

Dell™ OptiPlex™ 360

Setup and Quick Reference Guide

This guide provides a features overview, specifications, and quick setup, software, and troubleshooting information for your computer. For more information about your operating system, devices, and technologies, see the *Dell Technology Guide* at support.dell.com.

Models DCSM and DCNE

Notes, Notices, and Cautions



NOTE: A NOTE indicates important information that helps you make better use of your computer.



NOTICE: A NOTICE indicates either potential damage to hardware or loss of data and tells you how to avoid the problem.



CAUTION: A CAUTION indicates a potential for property damage, personal injury, or death.

If you purchased a Dell™ n Series computer, any references in this document to Microsoft® Windows® operating systems are not applicable.

Macrovision Product Notice

This product incorporates copyright protection technology that is protected by method claims of certain U.S. patents and other intellectual property rights owned by Macrovision Corporation and other rights owners. Use of this copyright protection technology must be authorized by Macrovision Corporation, and is intended for home and other limited viewing uses only unless otherwise authorized by Macrovision Corporation. Reverse engineering or disassembly is prohibited.

Information in this document is subject to change without notice.

© 2008 Dell Inc. All rights reserved.

Reproduction of this material in any manner whatsoever without the written permission of Dell Inc. is strictly forbidden.

Trademarks used in this text: *Dell*, the *DELL* logo, *OptiPlex*, and *DellConnect* are trademarks of Dell Inc.; *Bluetooth* is a registered trademark owned by Bluetooth SIG, Inc., and is used by Dell under license; *Intel*, *Pentium*, *Core*, and *Celeron* are registered trademarks of Intel Corporation in the U.S. and other countries; *Microsoft*, *Windows*, *Windows Vista*, and the *Windows Vista* start button logo are either trademarks or registered trademarks of Microsoft Corporation in the United States and/or other countries.

Other trademarks and trade names may be used in this document to refer to either the entities claiming the marks and names or their products. Dell Inc. disclaims any proprietary interest in trademarks and trade names other than its own.

Models DCSM and DCNE

August 2008

P/N U719F

Rev. A00

Contents

1	About Your Computer	7
	Mini Tower — Front View	7
	Mini Tower — Back View	8
	Mini Tower — Back Panel Connectors	9
	Desktop — Front View	10
	Desktop — Back View	11
	Desktop — Back Panel Connectors	12
2	Setting Up Your Computer	13
	Quick Setup	13
	Installing Your Computer in an Enclosure	18
	Connecting to the Internet	20
	Setting Up Your Internet Connection	20
	Transferring Information to a New Computer	21
	Microsoft® Windows Vista® Operating System	21
	Microsoft Windows® XP	21

3	Specifications — Mini Tower Computer	25
4	Specifications — Desktop Computer	31
5	Troubleshooting Tips	37
	Using the Hardware Troubleshooter.	37
	Tips	37
	Power Problems	37
	Memory Problems	39
	Lockups and Software Problems	39
	Dell Technical Update Service	41
	Dell Support Utility	41
	Dell Diagnostics.	41
6	Reinstalling Software	43
	Drivers	43
	Identifying Drivers	43
	Reinstalling Drivers and Utilities	43
	Restoring Your Operating System	45
	Using Microsoft® Windows® System Restore	46
	Using Dell Factory Image Restore	46
	Using the Operating System Media.	47

7	Finding Information	49
8	Getting Help	51
	Obtaining Assistance	51
	Technical Support and Customer Service	52
	DellConnect™	52
	Online Services	52
	AutoTech Service	53
	Automated Order-Status Service	53
	Problems With Your Order	53
	Product Information	54
	Returning Items for Warranty Repair or Credit	54
	Before You Call	55
	Contacting Dell	57
	Index	59

About Your Computer

Mini Tower — Front View

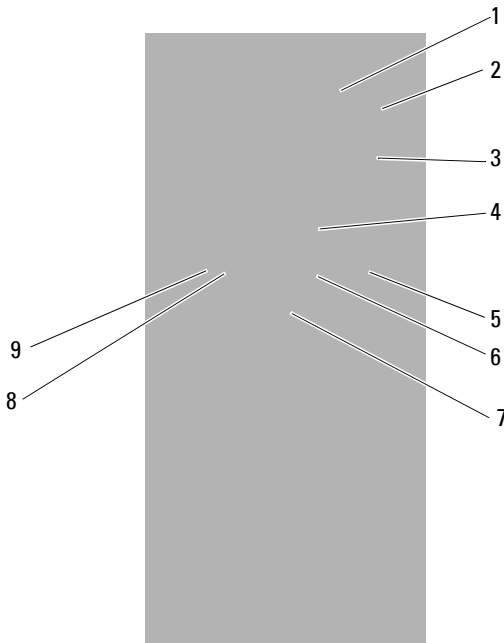

- | | | | |
|---|--------------------------------|---|----------------------------|
| 1 | optical drive | 2 | optical-drive eject button |
| 3 | optical-drive bay filler panel | 4 | floppy drive |
| 5 | USB 2.0 connectors (2) | 6 | drive-activity light |
| 7 | power button, power light | 8 | headphone connector |
| 9 | microphone connector | | |

Mini Tower — Back View

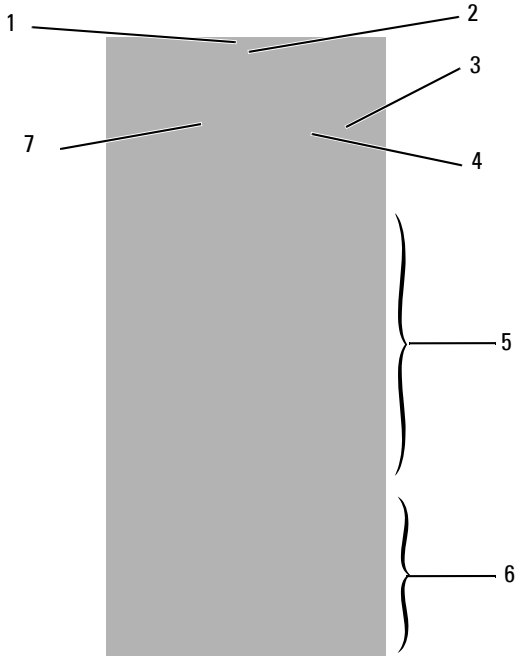

- | | | | |
|---|--|---|--------------------------|
| 1 | cover-release latch, and cable security slot | 2 | padlock ring |
| 3 | power cable connector | 4 | voltage selector switch |
| 5 | back-panel connectors | 6 | expansion-card slots (4) |
| 7 | power supply vent | | |

Mini Tower — Back Panel Connectors

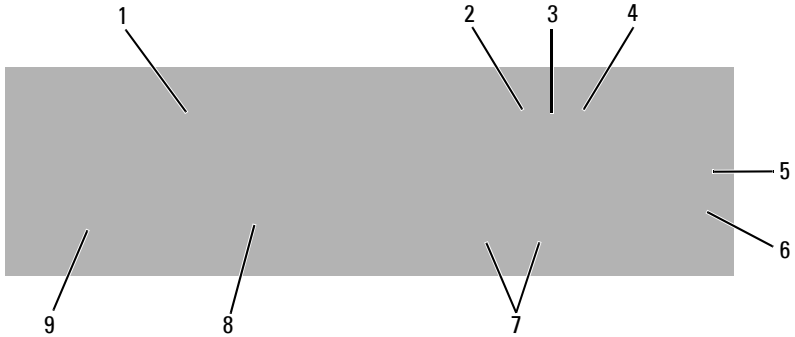

- | | | | |
|---|------------------------------|---|--------------------------------|
| 1 | parallel (printer) connector | 2 | link-integrity light |
| 3 | network adapter connector | 4 | network-activity light |
| 5 | line-out connector | 6 | line-in (microphone) connector |
| 7 | USB 2.0 connectors (6) | 8 | VGA video connector |
| 9 | serial connector | | |

Desktop — Front View

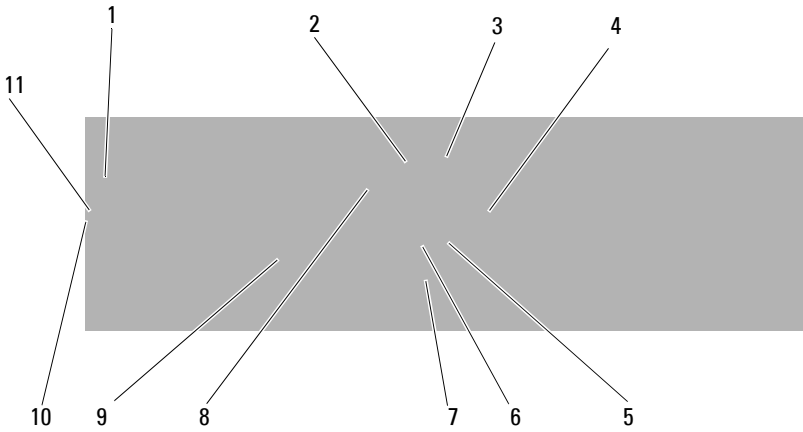

- | | | | |
|----|---------------------------|----|---|
| 1 | diagnostic lights | 2 | USB 2.0 connectors (2) |
| 3 | drive-activity lights | 4 | power button, power light |
| 5 | drive activity lights | 6 | headphone connector |
| 7 | microphone connector | 8 | optical-drive tray eject button |
| 9 | floppy-drive eject button | 10 | cover-release latch grip, and cable security slot |
| 11 | padlock ring | | |

Desktop — Back View

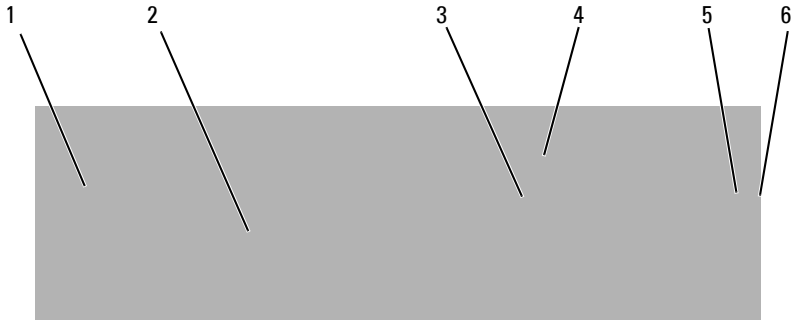

1 expansion-card slots (3)

2 back-panel connectors

3 power connector

4 voltage selector switch

5 padlock ring

6 cover-release latch grip, and security cable slot

Desktop — Back Panel Connectors

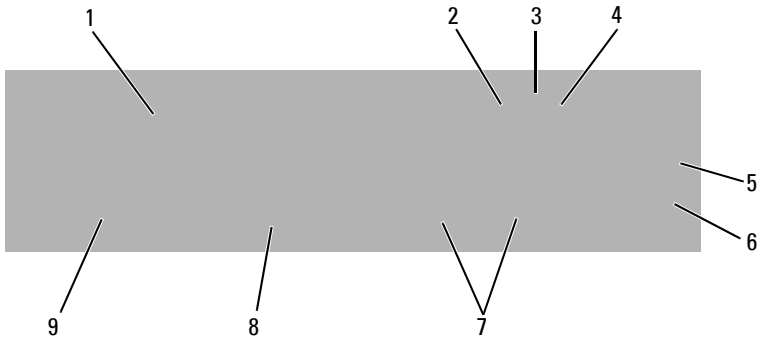

- | | | | |
|---|------------------------------|---|--------------------------------|
| 1 | parallel (printer) connector | 2 | network-activity light |
| 3 | network adapter connector | 4 | link-integrity light |
| 5 | line-out connector | 6 | line-in (microphone) connector |
| 7 | USB 2.0 connectors (6) | 8 | VGA video connector |
| 9 | serial connector | | |

Setting Up Your Computer

Quick Setup



CAUTION: Before you begin any of the procedures in this section, follow the safety instructions that shipped with your computer.



NOTE: Some devices may not be included if you did not order them.

- 1 Connect the monitor using only one of the following cables:
 - Dual monitor Y-adapter cable
 - White DVI cable
 - Blue VGA cable

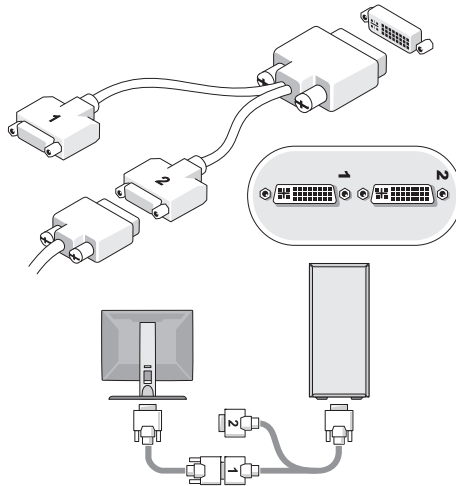

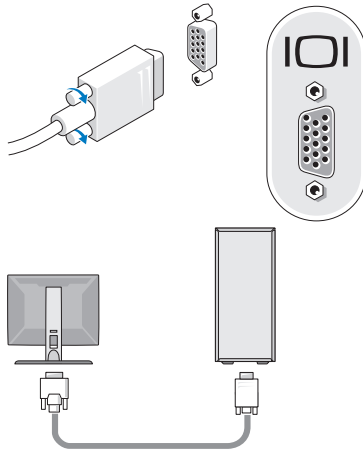
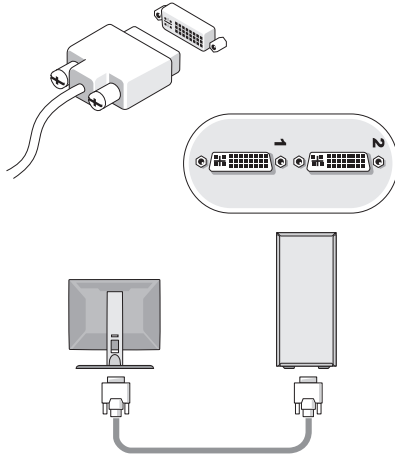

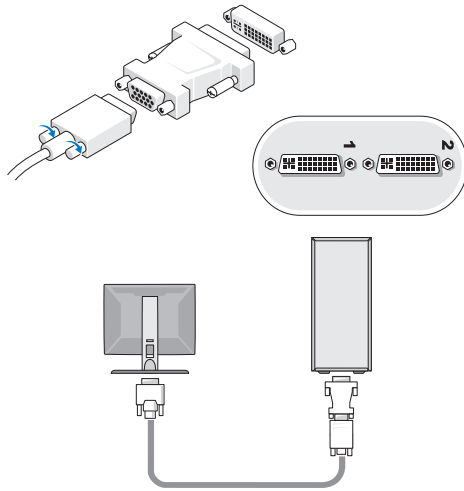

2 Connect a USB device, such as a keyboard or mouse.

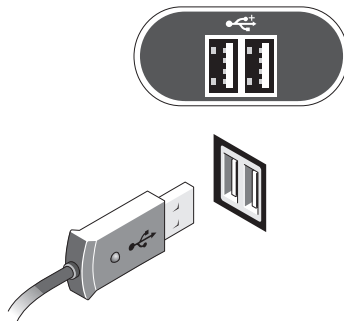

3 Connect the network cable.

➔ **NOTICE:** Ensure that you connect the network cable to the connector identified with the icon shown in the following illustration.

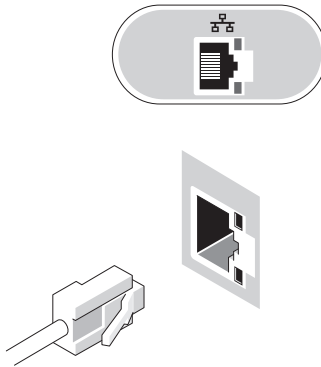

4 Connect the modem.

➔ **NOTICE:** Ensure that you connect the modem to the connector identified with the icon shown in the following illustration.

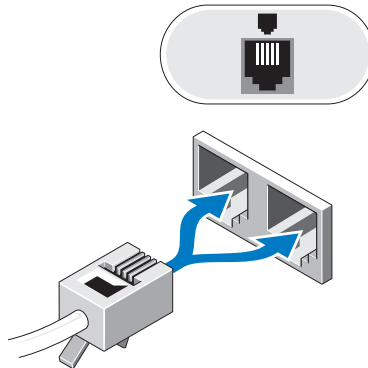

5 Connect the power cable(s).

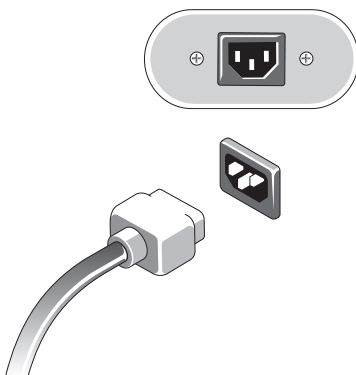

6 Press the power buttons on the monitor and the computer.

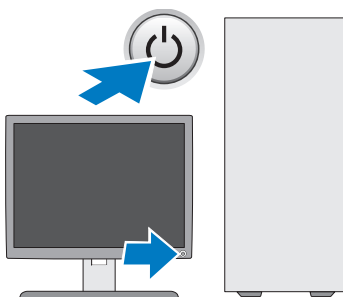

7 Connect to your network.

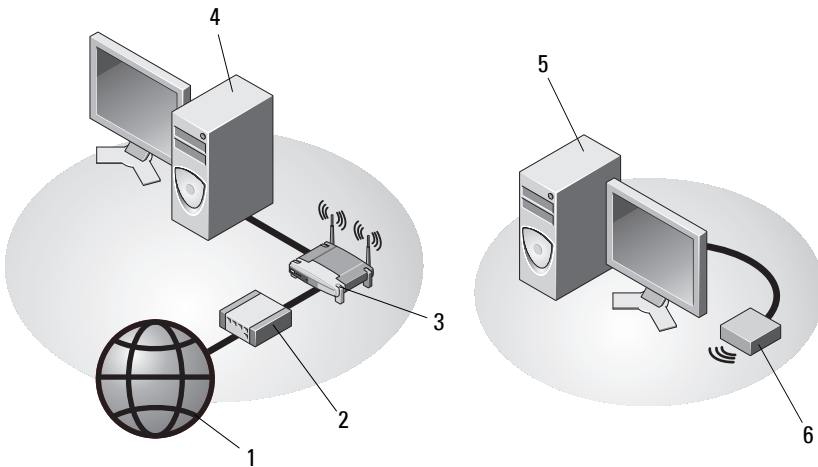

- | | | | |
|---|--|---|---------------------------------------|
| 1 | Internet service | 2 | cable or DSL modem |
| 3 | wireless router | 4 | desktop computer with network adapter |
| 5 | desktop computer with USB wireless adapter | 6 | USB wireless adapter |

Installing Your Computer in an Enclosure

Installing your computer in an enclosure can restrict the airflow and affect your computer's performance, possibly causing it to overheat. Follow the guidelines below when installing your computer in an enclosure.

⚠ CAUTION: Before installing your computer in an enclosure, read the safety instructions that shipped with your computer.

➡ NOTICE: The operating temperature specifications indicated in this document reflects the maximum ambient operating temperature. The room ambient temperature needs to be a consideration when you install your computer in an enclosure. For example, if the ambient room temperature is at 25°C (77°F), depending on your computer's specifications, you only have 5° to 10°C (9° to 18°F) temperature margin before you reach your computer's maximum operating

temperature. For details about your computer's specifications, see "Specifications — Mini Tower Computer" on page 25 or "Specifications — Desktop Computer" on page 31.

- Leave a 10.2-cm (4-in) minimum clearance on all sides of the computer that have air vents to permit the airflow required for proper ventilation.
- If your enclosure has doors, the doors need to be of a type that allows at least a 30-percent airflow through the enclosure at the front and at the back.

➔ NOTICE: Do not install your computer in an enclosure that does not allow airflow. Restricting the airflow impacts your computer's performance, possibly causing it to overheat.

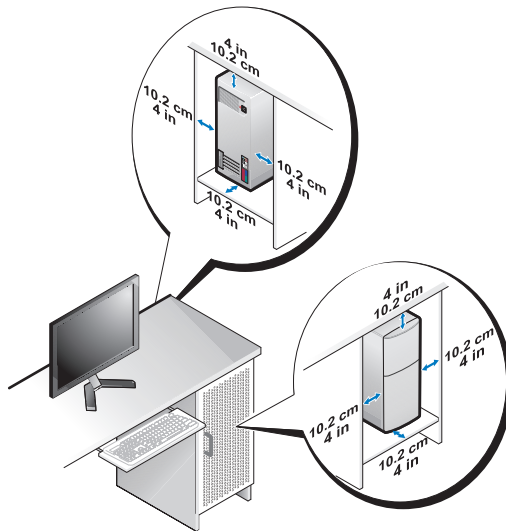

- If your computer is installed in a corner on a desk or under a desk, leave at least 5.1-cm (2-in) clearance from the back of the computer to the wall to permit the airflow required for proper ventilation.

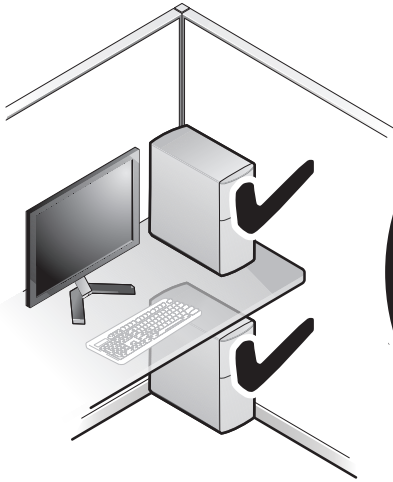

Connecting to the Internet

 **NOTE:** ISPs and ISP offerings vary by country.

To connect to the Internet, you need a modem or network connection and an Internet service provider (ISP). *If you are using a dial-up connection*, connect a telephone line to the modem connector on your computer and to the telephone wall connector before you set up your Internet connection. *If you are using a DSL or cable/satellite modem connection*, contact your ISP or cellular phone service for setup instructions.

Setting Up Your Internet Connection

To set up an Internet connection with a desktop shortcut provided by your ISP:

- 1 Save and close any open files, and exit any open programs.
- 2 Double-click the ISP icon on the Microsoft® Windows® desktop.
- 3 Follow the instructions on the screen to complete the setup.

If you do not have an ISP icon on your desktop or if you want to set up an Internet connection with a different ISP, perform the steps in the appropriate section below.

 **NOTE:** If you cannot connect to the Internet, see the *Dell Technology Guide*. If you have successfully connected in the past, the ISP might have a service outage. Contact your ISP to check the service status, or try connecting again later.

 **NOTE:** Have your ISP information ready. If you do not have an ISP, consult the **Connect to the Internet** wizard.

- 1 Save and close any open files, and exit any open programs.
- 2 Click the Windows Vista Start button  → **Control Panel**
- 3 Under **Network and Internet**, click **Connect to the Internet**.
- 4 In the **Connect to the Internet** window, click either **Broadband (PPPoE)** or **Dial-up**, depending on how you want to connect:
 - Choose **Broadband** if you will use a DSL, satellite modem, cable TV modem, or Bluetooth wireless technology connection.
 - Chose **Dial-up** if you will use a dial-up modem or ISDN.

 **NOTE:** If you do not know which type of connection to select, click **Help me choose** or contact your ISP.

- 5 Follow the instructions on the screen and use the setup information provided by your ISP to complete the setup.

Transferring Information to a New Computer

Microsoft® Windows Vista® Operating System

- 1 Click the Windows Vista Start button , and then click **Transfer files and settings** → **Start Windows Easy Transfer**.
- 2 In the **User Account Control** dialog box, click **Continue**.
- 3 Click **Start a new transfer** or **Continue a transfer in progress**.
- 4 Follow the instructions provided on the screen by the Windows Easy Transfer wizard.

Microsoft Windows® XP

Windows XP provides the Files and Settings Transfer Wizard to move data from a source computer to a new computer.

You can transfer the data to the new computer over a network or serial connection, or you can store it on removable media, such as a writable CD, for transfer to the new computer.



NOTE: You can transfer information from an old computer to a new computer by directly connecting a serial cable to the input/output (I/O) ports of the two computers.

For instructions on setting up a direct cable connection between two computers, see Microsoft Knowledge Base Article #305621, titled *How to Set Up a Direct Cable Connection Between Two Computers in Windows XP*. This information may not be available in certain countries.

For transferring information to a new computer, you must run the Files and Settings Transfer Wizard.

Running the Files and Settings Transfer Wizard With the Operating System Media



NOTE: This procedure requires the *Operating System* media. This media is optional and may not be included with certain computers.

To prepare a new computer for the file transfer:

- 1 Open the Files and Settings Transfer Wizard: click **Start**→ **All Programs**→ **Accessories**→ **System Tools**→ **Files and Settings Transfer Wizard**.
- 2 When the **Files and Settings Transfer Wizard** welcome screen appears, click **Next**.
- 3 On the **Which computer is this?** screen, click **New Computer**→ **Next**.
- 4 On the **Do you have a Windows XP CD?** screen, click **I will use the wizard from the Windows XP CD**→ **Next**.
- 5 When the **Now go to your old computer** screen appears, go to your old or source computer. Do *not* click **Next** at this time.

To copy data from the old computer:

- 1 On the old computer, insert the *Windows XP Operating System* media.
- 2 On the **Welcome to Microsoft Windows XP** screen, click **Perform additional tasks**.
- 3 Under **What do you want to do?**, click **Transfer files and settings**→ **Next**.
- 4 On the **Which computer is this?** screen, click **Old Computer**→ **Next**.
- 5 On the **Select a transfer method** screen, click the transfer method you prefer.

- 6 On the **What do you want to transfer?** screen, select the items you want to transfer and click **Next**.

After the information has been copied, the **Completing the Collection Phase** screen appears.

- 7 Click **Finish**.

To transfer data to the new computer:

- 1 On the **Now go to your old computer** screen on the new computer, click **Next**.
- 2 On the **Where are the files and settings?** screen, select the method you chose for transferring your settings and files and click **Next**.

The wizard applies the collected files and settings to your new computer.

- 3 On the **Finished** screen, click **Finished**, and restart the new computer.

Running the Files and Settings Transfer Wizard Without the Operating System Media

To run the Files and Settings Transfer Wizard without the *Operating System* media, you must create a wizard disk that will allow you to create a backup image file to removable media.

To create a wizard disk, use your new computer with Windows XP and perform the following steps:

- 1 Open the Files and Settings Transfer Wizard: click **Start**→ **All Programs**→ **Accessories**→ **System Tools**→ **Files and Settings Transfer Wizard**.
- 2 When the **Files and Settings Transfer Wizard** welcome screen appears, click **Next**.
- 3 On the **Which computer is this?** screen, click **New Computer**→ **Next**.
- 4 On the **Do you have a Windows XP CD?** screen, click **I want to create a Wizard Disk in the following drive**→ **Next**.
- 5 Insert the removable media, such as a writable CD, and click **OK**.
- 6 When the disk creation completes and the **Now go to your old computer** message appears, *do not* click **Next**.
- 7 Go to the old computer.

To copy data from the old computer:

- 1 On the old computer, insert the wizard disk, and click **Start**→**Run**.
- 2 In the **Open** field on the **Run** window, browse to the path for **fastwiz** (on the appropriate removable media) and click **OK**.
- 3 On the **Files and Settings Transfer Wizard** welcome screen, click **Next**.
- 4 On the **Which computer is this?** screen, click **Old Computer**→**Next**.
- 5 On the **Select a transfer method** screen, click the transfer method you prefer.
- 6 On the **What do you want to transfer?** screen, select the items you want to transfer and click **Next**.

After the information has been copied, the **Completing the Collection Phase** screen appears.

- 7 Click **Finish**.

To transfer data to the new computer:

- 1 On the **Now go to your old computer** screen on the new computer, click **Next**.
- 2 On the **Where are the files and settings?** screen, select the method you chose for transferring your settings and files and click **Next**. Follow the instructions on the screen.

The wizard reads the collected files and settings and applies them to your new computer.

When all of the settings and files have been applied, the **Finished** screen appears.

- 3 Click **Finished** and restart the new computer.



NOTE: For more information about this procedure, search support.dell.com for document #154781 (*What Are The Different Methods To Transfer Files From My Old Computer To My New Dell™ Computer Using the Microsoft® Windows® XP Operating System?*).



NOTE: Access to the Dell™ Knowledge Base document may not be available in certain countries.

Specifications — Mini Tower Computer



NOTE: Offerings may vary by region. For more information regarding the configuration of your computer, click **Start** → **Help and Support** and select the option to view information about your computer.

Processor

Processor type	Intel® Core™2 Duo processor Intel Pentium® Dual-Core processor Intel Celeron® Dual-Core processor Intel Celeron processor
Level 2 (L2) cache	at least 512-KB pipelined-burst, eight-way set associative, writeback SRAM

System Information

Chipset	Intel G31/ICH7
DMA channels	seven
Interrupt levels	24
BIOS chip (NVRAM)	8 Mb
NIC	integrated network interface capable of 10/100/1000 communication

Memory

Type	667-MHz or 800-MHz DDR2 SDRAM; non-ECC memory only
Memory connectors	two

Memory (continued)

Memory capacities	512 MB, 1 GB, or 2 GB
Minimum memory	512 MB
Maximum memory	4 GB

Video

Type:

Integrated VGA (on system board)	Intel G31
Discrete (graphics card)	PCI Express x16 slot can support a PCI Express graphics card (25 W)

Audio

Type	optional chassis speaker; microphone and headphone connectors on front panel; line-in and line-out audio connectors on back panel to support microphone
------	---

Expansion Bus

Bus type	PCI 2.3 PCI Express 1.0A SATA 1.0 and 2.0 USB 2.0
Bus speed	133 MB/s (PCI) x1-slot bidirectional speed — 500 MB/s (PCI Express) x16-slot bidirectional speed — 8 GB/s (PCI Express) 1.5 Gbps and 3.0 Gbps (SATA) 480-Mbps high speed, 12-Mbps full speed, 1.5-Mbps low speed (USB)
PCI	
connectors	two (full height)
connector size	124 pins
connector data width (maximum)	32 bits

Expansion Bus (continued)

PCI Express

connector	one x16 (with support for x1)
connector size	164 pins
connector data width (maximum)	16 PCI Express lanes (x16)

Drives

Externally accessible:	one 3.5-inch drive bay (FlexBay) two 5.25-inch drive bays
Internally accessible	two 3.5-inch SATA hard-drive bays

Connectors

External connectors:

Video	15-hole VGA connector
Network adapter	RJ-45 connector
USB	two front-panel, and six back-panel USB 2.0-compliant connectors
Audio	front panel: one microphone and one headphone connector; back panel: one line-out connector and one line-in (microphone) connector
Serial	two 9-pin connectors; 16550C-compatible
PS/2	two, through PS/2 serial expansion card (full height)
Parallel	one 25-pin connector (bidirectional)

System board connectors:

SATA	three 7-pin connectors
Floppy drive	one 34-pin connector
Processor fan	one 4-pin connector
Chassis fan	one 5-pin connector
PCI Express x16	one 164-pin connector

Connectors *(continued)*

Front panel USB	two 10-pin connectors
Front panel audio HDA header	one 10-pin connector
Processor	one 775-pin connector
Memory	two 240-pin connectors
Power 12 V	one 4-pin connector
Power	one 24-pin connector
LAN on motherboard (LOM)	through RJ-45 connector on back panel

Controls and Lights

Front of computer:

Power button	push button
Power light	<ul style="list-style-type: none">• green light — Blinking green in sleep state; solid green for power-on state• amber light — The blinking amber indicates a problem with the system board. A solid amber light when the computer does not start indicates that the system board cannot start initialization. This indication could be a system board or a power supply problem (see "Power Problems" on page 37).
Drive activity light	green light — A blinking green light indicates the computer is reading data from or writing data to the SATA hard drive or CD/DVD.

Controls and Lights (continued)

Back of computer:

- | | |
|--|--|
| Link integrity light (on integrated network adapter) | <ul style="list-style-type: none">• green light — A good connection with a speed of 10M exists between the network and the computer.• orange light — A better connection with a speed of 100M exists between the network and the computer.• yellow light — An excellent connection with a speed of 1000M exists between the network and the computer.• off (no light) — The computer is not detecting a physical connection to the network. |
| Network activity light (on integrated network adapter) | <ul style="list-style-type: none">• yellow blinking light — Indicates network activity.• off (no light) — Indicates <i>no</i> network activity. |

Power

DC power supply:

Wattage	255 W
Maximum heat dissipation (MHD)	for 255-W power supply: 138-W MHD NOTE: Heat dissipation is calculated by using the power supply wattage rating.
Voltage (see the safety information that shipped with your computer for important voltage setting information)	115/230 VAC, 50/60 Hz
Coin-cell battery	3-V CR2032 lithium coin cell

Physical

Height	40.8 cm (16.1 in)
Width	18.7cm (7.4 in)
Depth	43.3 cm (17.0 in)
Weight	12.7 kg (28.0 lb)

Environmental

Temperature:

Operating	10° to 35°C (50° to 95°F)
Storage	-40° to 65°C (-40° to 149°F)

Relative humidity
(noncondensing)

Operating	20% to 80% (maximum wet bulb temperature 29°C)
Storage	5% to 95% (maximum wet bulb temperature 38°C)

Maximum vibration:

Operating	5 to 350 Hz at 0.0002 G ² /Hz
Storage	5 to 500 Hz at 0.001 to 0.01 G ² /Hz

Maximum shock:

Operating	40 G +/- 5% with pulse duration of 2 msec +/- 10% (equivalent to 51 cm/sec [20 in/sec])
Storage	105 G +/- 5% with pulse duration of 2 msec +/- 10% (equivalent to 127 cm/sec [50 in/sec])

Altitude:

Operating	-15.2 to 3048 m (-50 to 10,000 ft)
Storage	-15.2 to 10,668 m (-50 to 35,000 ft)

Airborne contaminant level G2 or lower as defined by ISA-S71.04-1985

Specifications — Desktop Computer



NOTE: Offerings may vary by region. For more information regarding the configuration of your computer, click **Start** → **Help and Support** and select the option to view information about your computer.

Processor

Processor type	Intel® Core™2 Duo processor Intel Pentium® Dual-Core processor Intel Celeron® Dual-Core processor Intel Celeron processor
Level 2 (L2) cache	at least 512-KB pipelined-burst, eight-way set associative, writeback SRAM

System Information

Chipset	Intel G31/ICH7
DMA channels	seven
Interrupt levels	24
BIOS chip (NVRAM)	8 Mb
NIC	integrated network interface capable of 10/100/1000 communication

Memory

Type	667-MHz or 800-MHz DDR2 SDRAM; non-ECC memory only
Memory connectors	two
Memory capacities	512 MB, 1 GB, or 2 GB
Minimum memory	512 MB
Maximum memory	4 GB

Video

Type:	
Integrated (on system board)	Intel G31
Discrete (graphics card)	PCI Express x16 slot can support a PCI Express graphics card (25 W)

Audio

Type	optional chassis speaker; microphone and headphone connectors on front panel; line-in and line-out audio connectors on back panel to support microphone
------	---

Expansion Bus

Bus type	PCI 2.3 PCI Express 1.0A SATA 1.0 and 2.0 USB 2.0
Bus speed	133 MB/s (PCI) x1-slot bidirectional speed — 500 MB/s (PCI Express) x16-slot bidirectional speed — 8 GB/s (PCI Express) 1.5 Gbps and 3.0 Gbps (SATA) 480-Mbps high speed, 12-Mbps full speed, 1.5-Mbps low speed (USB)

Expansion Bus (continued)

PCI

connectors	two low-profile connectors, with support for two full-height 6.9-in PCI cards (or one 6.9-in PCI and one 6.9-in PCIe x16 card) if a PCI riser board is used
connector size	124 pins
connector data width (maximum)	32 bits

PCI Express

connector	one low-profile x16 (with support for x1); or one full-height PCIe x16 (and one 6.9-in full-height PCI) on a riser board
connector size	164 pins
connector data width (maximum)	16 PCI Express lanes

Drives

Externally accessible:	one 3.5-inch drive bay (FlexBay) one 5.25-inch drive bay
Internally accessible	one 3.5-inch SATA drive bay

Connectors

External connectors:

Video	15-hole VGA connector
Network adapter	RJ-45 connector
USB	two front-panel, and six back-panel USB 2.0-compliant connectors
Audio	front panel: one microphone and one headphone connector; back panel: one line-out connector and one line-in (microphone) connector
Serial	two 9-pin connectors; 16550C-compatible

Connectors *(continued)*

PS/2	one, through PS/2 serial expansion card (low profile)
Parallel	one 25-pin connector (bidirectional)
System board connectors:	
SATA	three 7-pin connectors
Floppy drive	one 34-pin connector
Processor fan	one 4-pin connector
Chassis fan	one 3-pin connector
PCI Express x16	one 164-pin connector
Front panel control	one 10-pin connector
Front panel USB	one 10-pin connectors
Front panel audio HDA header	one 10-pin connector
Processor	one 775-pin connector
Memory	four 240-pin connectors
Power 12 V	one 4-pin connector
Power	one 24-pin connector
LAN on motherboard (LOM)	through RJ-45 connector on back panel

Controls and Lights

Front of computer:

Power button	push button
Power light	green light — Blinking green in sleep state; solid green for power-on state amber light — The blinking amber indicates a problem with the system board. A solid amber light when the computer does not start indicates that the system board cannot start initialization. This indication could be a system board or a power supply problem (see "Power Problems" on page 37).

Controls and Lights *(continued)*

Drive activity light	green light — A blinking green light indicates the computer is reading data from or writing data to the SATA hard drive or CD/DVD.
----------------------	--

Back of computer:

Link integrity light (on integrated network adapter)	green light — A good connection exists between the network and the computer.
--	--

off (no light) — The computer is not detecting a physical connection to the network.

Network activity light (on integrated network adapter)	yellow blinking light
--	-----------------------

Power

DC power supply:

Wattage	235 W
---------	-------

Maximum heat dissipation (MHD)	For 235-W power supply: 126-W MHD
--------------------------------	-----------------------------------

NOTE: Heat dissipation is calculated by using the power supply wattage rating.

Voltage (see the safety information that shipped with your computer for important voltage setting information)	115/230 VAC, 50/60 Hz, 6.5/3.5 A
--	----------------------------------

Coin-cell battery	3-V CR2032 lithium coin cell
-------------------	------------------------------

Physical

Height	39.9 cm (15.7 in)
--------	-------------------

Width	11.4 cm (4.5 in)
-------	------------------

Depth	35.3 cm (13.9 in)
-------	-------------------

Weight	12.7 kg (28.0 lb)
--------	-------------------

Environmental

Temperature:

Operating	10° to 35°C (50° to 95°F)
Storage	-40° to 65°C (-40° to 149°F)

Relative humidity
(noncondensing)

Operating	20% to 80% (maximum wet bulb temperature 29°C)
Storage	5% to 95% (maximum wet bulb temperature 38°C)

Maximum vibration:

Operating	5 to 350 Hz at 0.0002 G ² /Hz
Storage	5 to 500 Hz at 0.001 to 0.01 G ² /Hz

Maximum shock:

Operating	40 G +/- 5% with pulse duration of 2 msec +/- 10% (equivalent to 51 cm/sec [20 in/sec])
Storage	105 G +/- 5% with pulse duration of 2 msec +/- 10% (equivalent to 127 cm/sec [50 in/sec])

Altitude:

Operating	-15.2 to 3048 m (-50 to 10,000 ft)
Storage	-15.2 to 10,668 m (-50 to 35,000 ft)

Airborne contaminant level G2 or lower as defined by ISA-S71.04-1985

Troubleshooting Tips



CAUTION: Always unplug your computer from the electrical outlet before opening the cover.



NOTE: For detailed troubleshooting information, including responding to system messages, see your *Service Manual* on support.dell.com.

Using the Hardware Troubleshooter

- 1 Click the Windows Vista Start button , and click **Help and Support**.
- 2 Type `hardware troubleshooter` in the search field and press <Enter> to start the search.
- 3 In the search results, select the option that best describes the problem and follow the remaining troubleshooting steps.

Tips

- If a device does not work, ensure that the device is properly connected.
- If you added or removed a part before the problem started, review the installation procedures and ensure that the part is correctly installed.
- If an error message appears on the screen, write down the exact message. This message may help support personnel to diagnose and fix the problem(s).
- If an error message occurs in a program, see the program documentation.

Power Problems



CAUTION: Before working inside your computer, read the safety information that shipped with your computer. For additional safety best practices information, see www.dell.com/regulatory_compliance.

IF THE POWER LIGHT IS OFF — The computer is either turned off or is not receiving power.

- Reseat the power cable in the power connector on the back of the computer and the electrical outlet.

- Bypass power strips, power extension cables, and other power protection devices to verify that the computer turns on properly.
- Ensure that any power strips being used are plugged into an electrical outlet and are turned on.
- Ensure that the electrical outlet is working by testing it with another device, such as a lamp.
- Ensure that the main power cable and front panel cable are securely connected to the system board.

IF THE POWER LIGHT IS GREEN AND THE COMPUTER IS NOT RESPONDING —

- Ensure that the display is connected and powered on.
- If the display is connected and powered on, see in your *Service Manual* on support.dell.com.

IF THE POWER LIGHT IS BLINKING GREEN — The computer is in standby mode. Press a key on the keyboard, move the mouse, or press the power button to resume normal operation.

IF THE POWER LIGHT IS BLINKING AMBER — The computer is receiving electrical power, a device might be malfunctioning or incorrectly installed.

- Remove and then reinstall all memory modules.
- Remove and then reinstall any expansion cards, including graphics cards.

IF THE POWER LIGHT IS STEADY AMBER — There is a power problem, a device may be malfunctioning or incorrectly installed.

- Ensure that the processor power cable is securely connected to the system board power connector (see your *Service Manual* at support.dell.com).
- Ensure that the main power cable and the front panel cable are securely connected to the system board connector.

ELIMINATE INTERFERENCE — Some possible causes of interference are:

- Power, keyboard, and mouse extension cables
- Too many devices connected to the same power strip
- Multiple power strips connected to the same electrical outlet

Memory Problems



CAUTION: Before working inside your computer, read the safety information that shipped with your computer. For additional safety best practices information, see www.dell.com/regulatory_compliance.

IF YOU RECEIVE AN INSUFFICIENT MEMORY MESSAGE —

- Save and close any open files and exit any open programs you are not using to see if that resolves the problem.
- See the software documentation for minimum memory requirements. If necessary, install additional memory.
- Reseat the memory modules to ensure that your computer is successfully communicating with the memory.
- Run the Dell Diagnostics (see "Dell Diagnostics" on page 41).

IF YOU EXPERIENCE OTHER MEMORY PROBLEMS —

- Reseat the memory modules to ensure that your computer is successfully communicating with the memory.
- Ensure that you are following the memory installation guidelines.
- Ensure that the memory you are using is supported by your computer. For more information about the type of memory supported by your computer, see "Specifications — Mini Tower Computer" on page 25 or "Specifications — Desktop Computer" on page 31.
- Run the Dell Diagnostics (see "Dell Diagnostics" on page 41).

Lockups and Software Problems



NOTE: The procedures in this document were written for the Windows default view, so they may not apply if you set your Dell computer to the Windows Classic view.

The computer does not start up

ENSURE THAT THE POWER CABLE IS FIRMLY CONNECTED TO THE COMPUTER AND TO THE ELECTRICAL OUTLET

A program stops responding

END THE PROGRAM —

- 1 Press <Ctrl><Shift><Esc> simultaneously to access the Task Manager, and click the **Applications** tab.
- 2 Click to select the program that is no longer responding, and click **End Task**.

A program crashes repeatedly



NOTE: Most software includes installation instructions in its documentation or on a floppy disk, CD, or DVD.

CHECK THE SOFTWARE DOCUMENTATION — If necessary, uninstall and then reinstall the program.

A program is designed for an earlier Microsoft® Windows® operating system

RUN THE PROGRAM COMPATIBILITY WIZARD —

- 1 Click **Start**  → **Control Panel** → **Programs** → **Use an older program with this version of Windows**.
- 2 In the welcome screen, click **Next**.
- 3 Follow the instructions on the screen.

A solid blue screen appears

TURN THE COMPUTER OFF — If you are unable to get a response by pressing a key on your keyboard or moving your mouse, press and hold the power button for at least 6 seconds (until the computer turns off), and then restart your computer.

Other software problems

CHECK THE SOFTWARE DOCUMENTATION OR CONTACT THE SOFTWARE MANUFACTURER FOR TROUBLESHOOTING INFORMATION —

- Ensure that the program is compatible with the operating system installed on your computer.
- Ensure that your computer meets the minimum hardware requirements needed to run the software. See the software documentation for information.
- Ensure that the program is installed and configured properly.

- Verify that the device drivers do not conflict with the program.
- If necessary, uninstall and then reinstall the program.

Dell Technical Update Service

The Dell Technical Update service provides proactive e-mail notification of software and hardware updates for your computer. To enroll for the Dell Technical Update service, go to support.dell.com/technicalupdate.

Dell Support Utility

The Dell Support Utility provides self-support information, software updates, and health scans of your computing environment. Access the Dell Support Utility from the  icon on the taskbar, or from the **Start** menu.

If the Dell Support icon does not appear in your taskbar:

- 1 Click **Start**→ **All Programs**→ **Dell Support**→ **Dell Support Settings**.
- 2 Ensure that the **Show icon on the taskbar** option is checked.



NOTE: If the Dell Support Utility is not available from the **Start** menu, go to support.dell.com and download the software.

For more information about the Dell Support Utility, click the question mark (?) at the top of the **Dell™ Support** screen.

Dell Diagnostics



CAUTION: Before you begin any of the procedures in this section, follow the safety instructions that shipped with your computer.

Starting the Dell Diagnostics From Your Hard Drive

- 1 Ensure that the computer is connected to a working electrical outlet.
- 2 Turn on (or restart) your computer.
- 3 When the **DELL™** logo appears, press <F12> immediately. Select **Diagnostics** from the start menu and press <Enter>.



NOTE: If you wait too long and the operating system logo appears, continue to wait until you see the Microsoft® Windows® desktop, and then shut down your computer and try again.



NOTE: If you see a message stating that no diagnostics utility partition has been found, run the Dell Diagnostics from the *Drivers and Utilities* media.

- 4 Press any key to start the Dell Diagnostics from the diagnostics utility partition on your hard drive, and follow the instructions on the screen.

Starting the Dell Diagnostics From the Dell *Drivers and Utilities* Media



NOTE: The Dell *Drivers and Utilities* media is optional and may not ship with your computer.

- 1 Insert the *Drivers and Utilities* media.
- 2 Shut down and restart the computer.

When the DELL logo appears, press <F12> immediately.



NOTE: If you wait too long and the operating system logo appears, continue to wait until you see the Microsoft® Windows® desktop; then, shut down your computer and try again.



NOTE: The next steps change the boot sequence for one time only. On the next start-up, the computer starts according to the devices specified in the system setup program.

- 3 When the boot device list appears, highlight **Onboard or USB CD-ROM Drive** and press <Enter>.
- 4 Select the **Boot from CD-ROM** option from the menu that appears and press <Enter>.
- 5 Type 1 to start the CD menu and press <Enter> to proceed.
- 6 Select **Run the 32 Bit Dell Diagnostics** from the numbered list. If multiple versions are listed, select the version that is appropriate for your computer.
- 7 When the Dell Diagnostics **Main Menu** appears, select the test that you want to run, and follow the instructions on the screen

Reinstalling Software

Drivers

Identifying Drivers

- 1 Locate the list of devices for your computer.
 - a Click the Windows Vista Start button , and right-click **Computer**.
 - b Click **Properties**→ **Device Manager**.



NOTE: The **User Account Control** window may appear. If you are an administrator on the computer, click **Continue**; otherwise, contact your administrator to continue.

- 2 Scroll down the list to see if any device has an exclamation point (a yellow circle with a [!]) on the device icon.

If an exclamation point is next to the device name, you may need to reinstall the driver or install a new driver (see "Reinstalling Drivers and Utilities" on page 43).

Reinstalling Drivers and Utilities



NOTICE: The Dell Support website at support.dell.com and your *Drivers and Utilities* media provide approved drivers for your computer. If you install drivers obtained from other sources, your computer might not work correctly.

Returning to a Previous Device Driver Version

- 1 Click the Windows Vista Start button , and right-click **Computer**.
- 2 Click **Properties**→ **Device Manager**.



NOTE: The **User Account Control** window may appear. If you are an administrator on the computer, click **Continue**; otherwise, contact your administrator to enter the Device Manager.

- 3 Right-click the device for which the new driver was installed and click **Properties**.
- 4 Click the **Drivers** tab→ **Roll Back Driver**.

If Device Driver Rollback does not resolve the problem, use System Restore (see "Restoring Your Operating System" on page 45) to return your computer to the operating state that existed before you installed the new driver.

Using the Drivers and Utilities Media

Before using the *Drivers and Utilities* media, try the following:

- Windows Device Driver Rollback (see "Returning to a Previous Device Driver Version" on page 43)
- Microsoft System Restore (see "Using Microsoft® Windows® System Restore" on page 46)

- 1 With the Windows desktop displayed, insert your *Drivers and Utilities* media.

If this is your first time using the *Drivers and Utilities* media, go to step 2. If not, go to step 5.

- 2 When the *Drivers and Utilities* media installation program starts, follow the prompts on the screen.

 **NOTE:** In most cases, the *Drivers and Utilities* program starts running automatically. If it does not, start Windows Explorer, click your media drive directory to display the media contents, and then double-click the **autorcd.exe** file.

- 3 When the **InstallShield Wizard Complete** window appears, remove the *Drivers and Utilities* media and click **Finish** to restart the computer.
- 4 When you see the Windows desktop, reinsert the *Drivers and Utilities* media.
- 5 At the **Welcome Dell System Owner** screen, click **Next**.

The drivers that are used by your computer are automatically displayed in the **My Drivers—The ResourceCD has identified these components in your system** window.

- 6 Click the driver that you want to reinstall and follow the instructions on the screen.

If a particular driver is not listed, that driver is not required by your operating system, or you must find the drivers that came with the specific device.

Manually Reinstalling Drivers

- 1 Click the Windows Vista Start button , and right-click **Computer**.
- 2 Click **Properties**→ **Device Manager**.



NOTE: The **User Account Control** window appears. If you are an administrator on the computer, click **Continue**; otherwise, contact your administrator to enter the **Device Manager**.

- 3 Double-click the type of device for which you are installing the driver (for example, **Audio** or **Video**).
- 4 Double-click the name of the device for which you are installing the driver.
- 5 Click the **Driver** tab→ **Update Driver**→ **Browse my computer for driver software**.
- 6 Click **Browse** and browse to the location to which you previously copied the driver files.
- 7 Click the name of the driver→ **OK**→ **Next**.
- 8 Click **Finish** and restart your computer.

Restoring Your Operating System



You can restore your operating system in the following ways:

- Microsoft Windows System Restore returns your computer to an earlier operating state without affecting data files. Use System Restore as the first solution for restoring your operating system and preserving data files.
- Dell Factory Image Restore returns your hard drive to the same operating state as when you purchased the computer. The program deletes all data on the hard drive and removes any programs installed after you received the computer.
- If you received the *Operating System* media with your computer, you can use it to restore your operating system. However, using the *Operating System* media deletes all data on the hard drive.

Using Microsoft® Windows® System Restore

 **NOTE:** The procedures in this document were written for the Windows default view, so they may not apply if you set your Dell™ computer to the Windows Classic view.

Starting System Restore

- 1 Click **Start** .
- 2 In the Start Search box, type `System Restore` and press <Enter>.
 **NOTE:** The **User Account Control** window may appear. If you are an administrator on the computer, click **Continue**; otherwise, contact your administrator to continue the desired action.
- 3 Click **Next** and follow the remaining prompts on the screen.

Undoing the Last System Restore

 **NOTICE:** Before you undo the last system restore, save and close all open files and exit any open programs. Do not alter, open, or delete any files or programs until the system restoration is complete.

- 1 Click **Start** .
- 2 In the Start Search box, type `System Restore` and press <Enter>.
- 3 Click **Undo my last restoration** and click **Next**.

Using Dell Factory Image Restore

 **NOTICE:** Use Dell Factory Image Restore only if System Restore did not resolve your operating system problem. Using Dell Factory Image Restore permanently deletes all data (for example, documents, spreadsheets, e-mail messages, digital photos, and music files) on the hard drive and removes any programs or drivers installed after you received your computer. If possible, back up the data before using Dell Factory Image Restore.

 **NOTE:** Dell Factory Image Restore may not be available in certain countries or on certain computers.

- 1 Turn on the computer.
- 2 When the Dell logo appears, press <F8> several times to access the **Vista Advanced Boot Options** window.

3 Select **Repair Your Computer**.

The **System Recovery Options** window appears.

4 Select a keyboard layout and click **Next**.

5 To access the recovery options, log on as a local user.

6 To access the command prompt, type `administrator` in the **User name** field, then click **OK**.

7 Click **Dell Factory Image Restore**.



NOTE: Depending upon your configuration, you may need to select **Dell Factory Tools**, then **Dell Factory Image Restore**.

8 On the **Dell Factory Image Restore** welcome screen, click **Next**.

The **Confirm Data Deletion** screen appears.



NOTICE: If you do not want to proceed with **Factory Image Restore**, click **Cancel**.

9 Click the checkbox to confirm that you want to continue reformatting the hard drive and restoring the system software to the factory condition, then click **Next**.

The restore process begins and may take 5 or more minutes to complete. A message appears when the operating system and factory-installed applications have been restored to factory condition.

10 Click **Finish** to restart the computer.

Using the Operating System Media

Before reinstalling the operating system, try the following:

- Windows Device Driver Rollback (see "Returning to a Previous Device Driver Version" on page 43)
- Microsoft System Restore (see "Using Microsoft® Windows® System Restore" on page 46)



NOTICE: Before performing the installation, back up all data files from your primary hard drive to another media. For conventional hard drive configurations, the primary hard drive is the first drive detected by the computer.

To reinstall Windows, you need the Dell™ *Operating System* media and the Dell *Drivers and Utilities* media. The Dell *Drivers and Utilities* media contains drivers that were installed at the time you ordered your computer.

 **NOTE:** Depending on the region from which you ordered your computer, or whether you requested the media, the Dell Drivers and Utilities media and Dell Operating System media may not ship with your computer.

Reinstalling Windows

 **NOTE:** The reinstallation process can take 1 to 2 hours to complete.

- 1 Save and close any open files and exit any open programs.
- 2 Insert the *Operating System* media.
- 3 If the `Install Windows` message appears, click **Exit**.
- 4 Restart the computer, and when the DELL logo appears, press <F12> immediately.

If you wait too long and the operating system logo appears, wait until you see the Microsoft® Windows® desktop; then, restart your computer and try again.

- 5 When the boot device list appears, highlight **Onboard or USB CD-ROM Drive** and press <Enter>.

This selection changes the boot sequence for one time only.

- 6 Press any key to **Boot from CD-ROM**, and follow the instructions on the screen to complete the installation.
- 7 Reinstall the device drivers, virus protection program, and other software.

Finding Information

 **NOTE:** Some features or media may be optional and may not ship with your computer. Some features or media may not be available in certain countries.

 **NOTE:** Additional information may ship with your computer.

Document/Media/Label	Contents
<p>Service Tag/Express Service Code</p> <p>The <i>Service Tag/Express Service Code</i> is located on your computer.</p>	<ul style="list-style-type: none"> • Use the Service Tag to identify your computer when you use support.dell.com or contact support. • Enter the Express Service Code to direct your call when contacting support <p>NOTE: Your Service Tag/Express Service Code is located on your computer.</p>
<p>Drivers and Utilities Media</p> <p>The <i>Drivers and Utilities</i> media is a CD or DVD that may have shipped with your computer.</p>	<ul style="list-style-type: none"> • A diagnostic program for your computer • Drivers for your computer <p>NOTE: Drivers and documentation updates can be found at support.dell.com.</p> <ul style="list-style-type: none"> • Desktop System Software (DSS) • Readme files <p>NOTE: Readme files may be included on your media to provide last-minute updates about technical changes to your computer or advanced technical-reference material for technicians or experienced users.</p>
<p>Operating System Media</p> <p>The <i>Operating System</i> media is a CD or DVD that may have shipped with your computer.</p>	<p>Reinstall your operating system</p>

Document/Media/Label	Contents
<p>Safety, Regulatory, Warranty, and Support Documentation</p> <p>This type of information may have shipped with your computer. For additional regulatory information, see the Regulatory Compliance Homepage at www.dell.com/regulatory_compliance.</p>	<ul style="list-style-type: none"> • Warranty information • Terms and Conditions (U.S. only) • Safety instructions • Regulatory information • Ergonomics information • End User License Agreement
<p>Service Manual</p> <p>The <i>Service Manual</i> for your computer can be found at support.dell.com.</p>	<ul style="list-style-type: none"> • How to remove and replace parts • How to configure system settings • How to troubleshoot and solve problems
<p>Dell Technology Guide</p> <p>The <i>Dell Technology Guide</i> is available at support.dell.com.</p>	<ul style="list-style-type: none"> • About your operating system • Using and maintaining devices • Understanding technologies such as RAID, Internet, Bluetooth® wireless technology, e-mail, networking, and more.
<p>Microsoft® Windows® License Label</p> <p>Your Microsoft Windows License is located on your computer.</p>	<ul style="list-style-type: none"> • Provides your operating system product key.

Getting Help

Obtaining Assistance

 **CAUTION:** If you need to remove the computer cover, first disconnect the computer power and modem cables from all electrical outlets. Follow the safety instructions that shipped with your computer.

If you experience a problem with your computer, you can complete the following steps to diagnose and troubleshoot the problem:

- 1 See "Tips" on page 37 for information and procedures that pertain to the problem your computer is experiencing.
- 2 See "Dell Diagnostics" on page 41 for procedures on how to run Dell Diagnostics.
- 3 Fill out the "Diagnostics Checklist" on page 56.
- 4 Use Dell's extensive suite of online services available at Dell Support (support.dell.com) for help with installation and troubleshooting procedures. See "Online Services" on page 52 for a more extensive list of Dell Support online.
- 5 If the preceding steps have not resolved the problem, see "Contacting Dell" on page 57.

 **NOTE:** Call Dell Support from a telephone at or near the affected computer so that the support staff can assist you with any necessary procedures.

 **NOTE:** Dell's Express Service Code system may not be available in all countries.

When prompted by Dell's automated telephone system, enter your Express Service Code to route the call directly to the proper support personnel. If you do not have an Express Service Code, open the **Dell Accessories** folder, double-click the **Express Service Code** icon, and follow the directions.

For instructions on using the Dell Support, see "Technical Support and Customer Service" on page 52.



NOTE: Some of the following services are not always available in all locations outside the continental U.S. Call your local Dell representative for information on availability.

Technical Support and Customer Service

Dell's support service is available to answer your questions about Dell™ hardware. Our support staff uses computer-based diagnostics to provide fast, accurate answers.

To contact Dell's support service, see "Before You Call" on page 55, and then see the contact information for your region or go to support.dell.com.

DellConnect™

DellConnect is a simple online access tool that allows a Dell service and support associate to access your computer through a broadband connection, diagnose your problem and repair it all under your supervision. For more information, go to support.dell.com and click **DellConnect**.

Online Services

You can learn about Dell products and services at the following websites:

www.dell.com

www.dell.com/ap (Asian/Pacific countries only)

www.dell.com/jp (Japan only)

www.euro.dell.com (Europe only)

www.dell.com/la (Latin American and Caribbean countries)

www.dell.ca (Canada only)

You can access Dell Support through the following websites and e-mail addresses:

- Dell Support websites:
 - support.dell.com
 - support.jp.dell.com (Japan only)
 - support.euro.dell.com (Europe only)

- Dell Support e-mail addresses:
mobile_support@us.dell.com
support@us.dell.com
la-techsupport@dell.com (Latin America and Caribbean countries only)
apsupport@dell.com (Asian/Pacific countries only)
- Dell Marketing and Sales e-mail addresses:
apmarketing@dell.com (Asian/Pacific countries only)
sales_canada@dell.com (Canada only)
- Anonymous file transfer protocol (FTP):
ftp.dell.com – log in as user `anonymous`, and use your e-mail address as your password

AutoTech Service

Dell's automated support service—AutoTech—provides recorded answers to the questions most frequently asked by Dell customers about their laptop and desktop computers.

When you call AutoTech, use your touch-tone telephone to select the subjects that correspond to your questions. For the telephone number to call for your region, see "Contacting Dell" on page 57.

Automated Order-Status Service

To check on the status of any Dell products that you have ordered, you can go to **support.dell.com**, or you can call the automated order-status service. A recording prompts you for the information needed to locate and report on your order. For the telephone number to call for your region, see "Contacting Dell" on page 57.

Problems With Your Order

If you have a problem with your order, such as missing parts, wrong parts, or incorrect billing, contact Dell for customer assistance. Have your invoice or packing slip available when you call. For the telephone number to call for your region, see "Contacting Dell" on page 57.

Product Information

If you need information about additional products available from Dell, or if you would like to place an order, visit the Dell website at www.dell.com. For the telephone number to call for your region or to speak to a sales specialist, see "Contacting Dell" on page 57.

Returning Items for Warranty Repair or Credit

Prepare all items being returned, whether for repair or credit, as follows:

- 1** Call Dell to obtain a Return Material Authorization Number, and write it clearly and prominently on the outside of the box.

For the telephone number to call for your region, see "Contacting Dell" on page 57. Include a copy of the invoice and a letter describing the reason for the return.

- 2** Include a copy of the Diagnostics Checklist (see "Diagnostics Checklist" on page 56), indicating the tests that you have run and any error messages reported by the Dell Diagnostics (see "Contacting Dell" on page 57).
- 3** Include any accessories that belong with the item(s) being returned (power cables, software floppy disks, guides, and so on) if the return is for credit.
- 4** Pack the equipment to be returned in the original (or equivalent) packing materials.

You are responsible for paying shipping expenses. You are also responsible for insuring any product returned, and you assume the risk of loss during shipment to Dell. Collect On Delivery (C.O.D.) packages are not accepted.

Returns that are missing any of the preceding requirements will be refused at Dell's receiving dock and returned to you.

Before You Call



NOTE: Have your Express Service Code ready when you call. The code helps Dell's automated-support telephone system direct your call more efficiently. You may also be asked for your Service Tag (located on the back or bottom of your computer).

Remember to fill out the Diagnostics Checklist (see "Diagnostics Checklist" on page 56). If possible, turn on your computer before you call Dell for assistance and call from a telephone at or near the computer. You may be asked to type some commands at the keyboard, relay detailed information during operations, or try other troubleshooting steps possible only at the computer itself. Ensure that the computer documentation is available.



CAUTION: Before working inside your computer, follow the safety instructions in the documentation that shipped with your computer.

Diagnostics Checklist

Name:

Date:

Address:

Phone number:

Service Tag (bar code on the back or bottom of the computer):

Express Service Code:

Return Material Authorization Number (if provided by Dell support technician):

Operating system and version:

Devices:

Expansion cards:

Are you connected to a network? Yes No

Network, version, and network adapter:

Programs and versions:

See your operating system documentation to determine the contents of the system's start-up files. If the computer is connected to a printer, print each file. Otherwise, record the contents of each file before calling Dell.

Error message, beep code, or diagnostic code:

Description of problem and troubleshooting procedures you performed:

Contacting Dell

For customers in the United States, call 800-WWW-DELL (800-999-3355).



NOTE: If you do not have an active Internet connection, you can find contact information on your purchase invoice, packing slip, bill, or Dell product catalog.

Dell provides several online and telephone-based support and service options. Availability varies by country and product, and some services may not be available in your area. To contact Dell for sales, technical support, or customer service issues:

- 1** Visit support.dell.com, and verify your country or region in the **Choose A Country/Region** drop-down menu at the bottom of the page.
- 2** Click **Contact Us** on the left side of the page, and select the appropriate service or support link based on your need.
- 3** Choose the method of contacting Dell that is convenient for you.

Index

C

- connecting
 - Internet, 20
 - modem, 16
 - monitor, 13
 - network, 18
 - network cable, 16
 - power cables, 17
- contacting Dell, 51, 57

D

- Dell
 - contacting, 51, 57
 - software updates, 41
 - Support Utility, 41
 - technical support and customer service, 52
 - Technical Update Service, 41
- Dell Diagnostics, 41
 - starting from the Drivers and Utilities media, 42
 - starting from your hard drive, 41
- Dell Technology Guide, 50
- DellConnect, 52
- Desktop System Software, 49

- diagnostics
 - Dell, 41
- documentation, 49
 - Dell Technology Guide, 50
 - Service Manual, 50
- drivers, 43
 - drivers and utilities media, 49
 - identifying, 43
 - reinstalling, 43
 - returning to a previous version, 43
- Drivers and Utilities media, 44
 - Dell Diagnostics, 41
- drivers and utilities media, 49

E

- End User License Agreement (EULA), 50
- ergonomics information, 50
- Express Service Code, 49

F

- Files and Settings Transfer Wizard, 21
- finding information, 49

I

- Internet
 - connecting, 20
 - setting up, 20

L

- license label, 50

M

- media
 - drivers and utilities, 49
 - operating system, 49
- memory
 - troubleshooting, 39

N

- networks, 18
 - connecting, 18

O

- operating system
 - Dell Factory Image Restore, 46
 - media, 47
 - reinstalling, 49
 - System Restore, 45
- operating system media, 49
- operating system product key, 50

P

- phone numbers, 57
- power
 - power light conditions, 37
 - troubleshooting, 37
- problems
 - restore to previous state, 46

R

- regulatory information, 50
- reinstalling
 - drivers and utilities, 43
 - software, 43

S

- safety information, 50
- Service Manual, 50
- Service Tag, 49
- setup
 - computer, 13
 - installing your computer in an enclosure, 18
 - Internet, 20
 - quick setup, 13
- software
 - problems, 40
 - reinstalling, 43
 - troubleshooting, 40
 - updates, 41

specifications
all, 25, 31
audio, 26, 32
connectors, 27, 33
controls and lights, 28, 34
drives, 27, 33
environmental, 30, 36
expansion bus, 26, 32
memory, 25, 32
physical, 30, 35
power, 29, 35
processor, 25, 31
system information, 25, 31
video, 26, 32

support, 51
contacting Dell, 57
DellConnect, 52
online services, 52
regional, 52
technical support and customer
service, 52

support information, 50
System Restore, 45-46

T

Terms and Conditions, 50
transferring information to a new
computer, 21
troubleshooting, 37, 50
blue screen, 40
computer not responding, 39
Dell Diagnostics, 41
memory, 39

troubleshooting (*continued*)
power, 37
power light conditions, 37
program crashes, 39
programs and Windows
compatibility, 40
restore to previous state, 45-46
software, 39-40
tips, 37

U

updates
software and hardware, 41

V

view
back, 8
back panel connectors, 7-9
front, 7

W

warranty information, 50
Windows License label, 50
Windows Vista
Dell Factory Image Restore, 46
Device Driver Rollback, 43
Program Compatibility wizard, 40
reinstalling, 49
returning to a previous device
driver version, 43
System Restore, 45-46

Windows XP

Files and Settings Transfer

Wizard, 21

reinstalling, 49

System Restore, 45-46

wizards

Files and Settings Transfer

Wizard, 21

Program Compatibility wizard, 40