



Dell USB-C Monitor

P2423DE/P2723DE

User's Guide

Monitor Model: P2423DE/P2723DE
Regulatory Model: P2423DEc/P2723DEc



-  **NOTE:** A NOTE indicates important information that helps you make better use of your computer.
-  **CAUTION:** A CAUTION indicates potential damage to hardware or loss of data if instructions are not followed.
-  **WARNING:** A WARNING indicates a potential for property damage, personal injury, or death.

Copyright © 2022 Dell Inc. or its subsidiaries. All rights reserved. Dell, EMC, and other trademarks are trademarks of Dell Inc. or its subsidiaries. USB Type-C® and USB-C® are registered trademarks of USB Implementers Forum. Other trademarks may be trademarks of their respective owners.

2022 – 02

Rev. A00



Contents

Safety instructions	6
About your monitor	7
Package contents	7
Product features	9
Identifying parts and controls	10
Front view	10
Back view	11
Bottom view	12
Monitor specifications	14
Resolution specifications	16
Supported video modes	16
Preset display modes	17
Physical characteristics	20
Environmental characteristics	22
Pin assignments	23
DisplayPort connector (in)	23
DisplayPort connector (out)	24
HDMI connector	25
Universal Serial Bus (USB) interface	26
RJ45 port (connector side)	29
Plug and play capability	32
LCD monitor quality and pixel policy	32
Ergonomics	32



Handling and moving your display	34
Maintenance guidelines	35
Cleaning your monitor.	35
Setting up the monitor	37
Attaching the stand	37
Connecting your monitor	40
Connecting the DisplayPort (DisplayPort to DisplayPort) cable	41
Connecting the USB-C (C-A) cable	41
Connecting the USB-C (C-C) cable	41
Connecting the HDMI cable (optional)	42
Connecting the monitor for DP Multi-Stream Transport (MST) function	42
Connecting the monitor for USB-C Multi-Stream Transport (MST) function	42
Connecting the RJ45 cable (optional)	43
Dell Power Button Sync (DPBS).	44
Connecting the monitor for DPBS for the first time.	47
Using DPBS function	48
Connecting the monitor for USB-C Multi-Stream Transport (MST) function	50
Connecting the monitor for USB-C.	51
Organizing cables	53
Securing your monitor using Kensington lock (optional)	53
Removing the monitor stand	54
VESA wall mounting (optional)	55
Operating the monitor	56
Power on the monitor	56



Using the joystick control	56
Using the On-Screen Display (OSD) menu	57
Accessing the Menu Launcher	57
Using the navigation keys	58
Accessing the menu system	59
Menu and Power button lock	71
OSD warning messages	73
Setting the maximum resolution	79
Using the tilt, swivel, and vertical extension	80
Tilt, swivel	80
Vertical Extension	80
Rotating the monitor	81
Rotate clockwise	81
Rotate counterclockwise	82
Adjusting the rotation display settings of your system	83
Troubleshooting	84
Self-Test	84
Built-in diagnostics	85
Common problems	87
Universal Serial Bus (USB) specific problems	92
Regulatory information	94
FCC notices (U.S. Only) and other regulatory information	94
EU product database for energy label and product information sheet	94
Contacting Dell.	94



Safety instructions

Use the following safety guidelines to protect your monitor from potential damage and to ensure your personal safety. Unless otherwise noted, each procedure included in this document assumes that you have read the safety information that shipped with your monitor.

 **NOTE: Before using the monitor, read the safety information that is shipped with your monitor and printed on the product. Keep the documentation at a secure location for future reference.**

 **WARNING: Use of controls, adjustments, or procedures other than those specified in this documentation may result in exposure to shock, electrical hazards, and/or mechanical hazards.**

 **WARNING: The possible long-term effect of listening to audio at high volume through the headphones (on monitor that support it) may cause damage to your hearing ability.**

- Place the monitor on a solid surface and handle it carefully. The screen is fragile and can be damaged if dropped or hit with a sharp object.
- Ensure that your monitor is electrically rated to operate with the AC power available in your location.
- Keep the monitor in room temperature. Excessive cold or hot conditions can have an adverse effect on the liquid crystal of the display.
- Connect the power cable from the monitor to a wall outlet that is near and accessible. See [Connecting your monitor](#).
- Do not place and use the monitor on a wet surface or near water.
- Do not subject the monitor to severe vibration or high impact conditions. For example, do not place the monitor inside a car trunk.
- Unplug the monitor when it is going to be left unused for an extended period.
- To avoid electric shock, do not attempt to remove any cover or touch the inside of the monitor.
- Read these instructions carefully. Keep this document for future reference. Follow all warnings and instructions marked on product.
- Certain monitors can be wall mounted using the VESA mount that is sold separately. Ensure to use the correct VESA specifications as mentioned in the wall mounting section of the *User's Guide*.

For information on safety instructions, see the *Safety, Environmental, and Regulatory Information (SERI)* document that is shipped with your monitor.







About your monitor





Package contents

The following table provides the list of components that are shipped with your monitor. If any component is missing, contact Dell. For more information, see [Contacting Dell](#).

 **NOTE: Some items may be optional and may not ship with your monitor. Some features may not be available in certain countries.**

Component image	Component description
	Display
	Stand riser
	Stand base
	Power cable (varies by country)



	<p>DisplayPort to DisplayPort cable (1.8 meters)</p>
	<p>Super speed USB 10 Gbps (USB 3.2 Gen2) Type-C to Type-C upstream cable (C-C cable) (1 meter)</p>
	<p>Super speed USB 5 Gbps (USB 3.2 Gen1) Type-C to Type-A upstream cable (C-A cable) (1.8 meters)</p>
	<p>Cable tie</p>
	<ul style="list-style-type: none"> • Quick Setup Guide • Safety, Environmental and Regulatory Information



Product features

The Dell P2423DE/P2723DE monitor has an active matrix, Thin-Film Transistor (TFT), Liquid Crystal Display (LCD) and LED backlight. The monitor features include:

- P2423DE: 60.45 cm (23.8 in.) viewable area display (measured diagonally).
- P2723DE: 68.47 cm (27 in.) viewable area display (measured diagonally).
- 2560 x 1440 resolution, with full-screen support for lower resolutions.
- Color gamut of 99% sRGB (typical).
- Digital connectivity with DisplayPort, USB-C and HDMI.
- Single USB-C to supply power (PD 90 W) to a compatible notebook while receiving video & data signal.
- Tilt, swivel, height, and rotate adjustment capabilities.
- Ultra-thin bezel minimizes the bezel gap in multi-monitor usage, enabling easier setup with an elegant viewing experience.
- Removable stand and Video Electronics Standards Association (VESA™) 100 mm mounting holes for flexible mounting solutions.
- Equipped with 1 USB-C upstream port and 4 SuperSpeed USB 5 Gbps (USB 3.2 Gen1) Type-A downstream ports.
- USB-C and RJ45 ports enable a single-cable, network-connected experience.
- Plug and play capability if supported by your system.
- On-Screen Display (OSD) adjustments for ease of set-up and screen optimization.
- Power and joystick buttons lock.
- Security lock slot.
- Stand lock.
- ≤ 0.3 W in Standby Mode.
- Optimize eye comfort with a flicker-free screen and low blue light feature.
- The monitor use Low Blue Light panel and is in compliance with TUV Rheinland (Hardware Solution) at factory reset/default setting model (Preset mode: Standard).

⚠ WARNING: The possible long-term effects of blue light emission from the monitor may cause damage to the eyes, which includes but is not limited to eye fatigue and digital eye strain. ComfortView Plus feature is designed to reduce the amount of blue light emitted from the monitor to optimize eye comfort.



Identifying parts and controls

Front view



Label	Description
1	Power LED indicator Solid white light indicates that the monitor is turned on and functioning normally. Blinking white light indicates that the monitor is in Standby Mode.



Back view



Back View with monitor stand



Label	Description	Use
1	VESA mounting holes (100 mm x 100 mm - behind attached VESA Cover)	Wall-mount the monitor using VESA-compatible wall mount kit (100 mm x 100 mm).
2	Regulatory label	Lists the regulatory approvals.
3	Stand release button	Releases the stand from the monitor.
4	Barcode, serial number, and Service Tag label	Contains monitor details and support information. Refer to this label if you need to contact Dell for technical support.
5	Power On/Off button	To turn the monitor on or off.
6	Joystick	Use to control the OSD menu. (For more Information, see Operating the monitor)
7	Cable-management slot	Use to organize cables by inserting them through the slot.



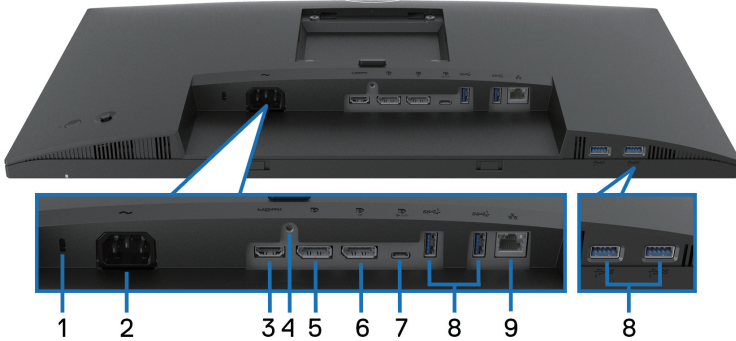

Bottom view



Bottom view without monitor stand

Label	Description	Use
1	Security lock slot (based on Kensington Security Slot)	Secure your monitor using a security lock (purchased separately) to prevent unauthorized movement of your monitor.
2	Power connector	Connect the power cable (shipped with your monitor).
3	HDMI port	Connect to your computer using a HDMI cable (purchased separately).
4	Stand lock	To lock the stand to the monitor using a M3 x 6 mm screw (screw not included).
5	DisplayPort (in)	Connect your computer with the DisplayPort cable (shipped with your monitor).
6	DisplayPort (out) 	DisplayPort output for MST (multi-stream transport) capable monitor. To enable MST, see Connecting the monitor for DP Multi-Stream Transport (MST) function .  NOTE: Remove the rubber plug when using DisplayPort out connector.



7	USB-C upstream port	<p>Connect the USB-C (C-C) or (C-A) cable that came with your monitor to the computer. This port supports USB Power Delivery, Data, and DisplayPort video signal. The SuperSpeed USB 5 Gbps (USB 3.2 Gen1) Type-C port supports Alternate Mode DP1.4 with a maximum resolution of 2560 x 1440 at 60 Hz, PD 20 V/4.5 A, 15 V/3 A, 9 V/3 A, 5 V/3 A.</p> <p> NOTE: USB-C is not supported on versions of Windows prior to Windows 10.</p>
8	SuperSpeed USB 5 Gbps (USB 3.2 Gen1) Type-A downstream port (4)	<p>Connect your USB device.*</p> <p> NOTE: To use these ports, you must connect the USB-C (C-C) or (C-A) cable (shipped with your monitor) to the USB-C upstream port on the monitor and to your computer.</p>
9	RJ45 port	<p>Connect the Internet. You can surf Internet via RJ45 only after you have connected the USB-C (C-C) or (C-A) cable (shipped with your monitor) from the computer to the monitor.</p>

*To avoid signal interference, when a wireless USB device has been connected to a USB downstream port, it is NOT recommended to connect any other USB devices to the adjacent port(s).



Monitor specifications

Model	P2423DE	P2723DE
Screen type	Active matrix - TFT LCD	
Panel type	In-Plane Switching Technology	
Aspect ratio	16:9	
Viewable image		
Diagonal	604.50 mm (23.80 in.)	684.70 mm (26.96 in.)
Horizontal, Active Area	526.85 mm (20.74 in.)	596.74 mm (23.49 in.)
Vertical, Active Area	296.35 mm (11.67 in.)	335.66 mm (13.21 in.)
Area	156132.00 mm ² (242.01 in. ²)	200301.75 mm ² (310.47 in. ²)
Native resolution and refresh rate	2560 x 1440 at 60 Hz	
Pixel pitch	0.2058 mm x 0.2058 mm	0.2331 mm x 0.2331 mm
Pixel per inch (PPI)	123	109
Viewing angle		
Horizontal	178° (typical)	
Vertical	178° (typical)	
Luminance output	300 cd/m ² (typical)	350 cd/m ² (typical)
Contrast ratio	1000 to 1 (typical)	
Display screen coating	Anti-glare treatment of the front polarizer (3H) hard coating	
Backlight	LED edgelight system	
Response time	5 ms (Fast mode) 8 ms (Normal mode)	
Color depth	16.7 million colors (8 bit)	
Color gamut	sRGB 99% (typical)	



Connectivity	<ul style="list-style-type: none"> • 1 x HDMI port version 1.4 (HDCP 1.4) • 1 x DisplayPort version 1.4 (HDCP 1.4) • 1 x DisplayPort (Out) with MST (HDCP 1.4) • 1 x USB-C upstream port (Alternate mode with DisplayPort 1.4, Power Delivery PD up to 90 W)* • 4 x SuperSpeed USB 5 Gbps (USB 3.2 Gen1) downstream port • 1 x RJ45 port 	
Bezel width (edge of monitor to active area)		
Top	5.42 mm	7.37 mm
Left/Right	5.48 mm	7.43 mm
Bottom	16.72 mm	17.77 mm
Adjustability		
Height adjustable stand	150 mm	
Tilt	-5° to 21°	
Swivel	-45° to 45°	
Pivot	-90° to 90°	
Cable management	Yes	
Dell Display Manager compatibility	Easy Arrange and other key features	
Security	Security lock slot (cable lock optional purchase)	

*DisplayPort and USB-C (Alternate mode with DisplayPort 1.4): HBR3 is supported.



Resolution specifications

Model	P2423DE/P2723DE
Horizontal scan range	29 kHz to 113 kHz
Vertical scan range	49 Hz to 75 Hz (automatic)
Maximum preset resolution	2560 x 1440 @ 60 Hz

Supported video modes

Model	P2423DE/P2723DE
Video display capabilities (HDMI & DisplayPort & USB-C DP alternate mode)	480p, 576p, 720p, 1080i(HDMI), 1080p, 1440p



Preset display modes

Display Mode	Horizontal Frequency (kHz)	Vertical Frequency (Hz)	Pixel Clock (MHz)	Sync Polarity (Horizontal / Vertical)
IBM, 720 x 400	31.50	70.10	28.30	-/+
VESA, 640 x 480	31.50	59.90	25.20	-/-
VESA, 640 x 480	37.50	75.00	31.50	-/-
VESA, 800 x 600	37.90	60.30	40.00	+/+
VESA, 800 x 600	46.90	75.00	49.50	+/+
VESA, 1024 x 768	48.40	60.00	65.00	-/-
VESA, 1024 x 768	60.00	75.00	78.80	+/+
VESA, 1152 x 864	67.50	75.00	108.00	+/+
VESA, 1280 x 768	47.80	59.90	79.50	-/+
VESA, 1280 x 1024	64.00	60.00	108.00	+/+
VESA, 1280 x 1024	79.90	75.00	135.00	+/+
VESA, 1600 x 1200	75.00	60.00	162.00	+/+
VESA, 1680 x 1050	65.30	60.00	146.30	-/+
CTA, 1920 x 1080	67.50	60.00	148.50	+/+
VESA, 1920 x 1200	74.60	59.90	193.30	-/+
VESA, 2048 x 1080	66.60	60.00	147.20	+/-
VESA, 2560 x 1440	88.80	60.00	241.50	+/-

DP Multi-Stream Transport (MST) modes

MST Source Monitor	Maximum number of external monitor that can be supported
	2560 x 1440 @ 60 Hz

 **NOTE: Maximum external monitor resolution supported is 2560 x 1440 60Hz only (HBR3).**



Electrical specifications

Model	P2423DE	P2723DE
Video input signals	<ul style="list-style-type: none"> · HDMI 1.4/DisplayPort 1.4*, 600 mV for each differential line, 100 ohm input impedance per differential pair · USB-C (with DP alternate mode) signal input support 	
AC input voltage/frequency/current	100 VAC to 240 VAC / 50 Hz or 60 Hz \pm 3 Hz / 2 A (typical)	100 VAC to 240 VAC / 50 Hz or 60 Hz \pm 3 Hz / 2 A (typical)
Inrush current	<ul style="list-style-type: none"> · 120 V: 30 A (Max.) at 0°C (cold start) · 240 V: 60 A (Max.) at 0°C (cold start) 	
Power consumption	<ul style="list-style-type: none"> · 0.3 W (Off mode)¹ · 0.3 W (Standby Mode)¹ · 20 W (On mode)¹ · 170 W (Max.)² · 17.5 W (Pon)³ · 56.5 kWh (TEC) 	<ul style="list-style-type: none"> · 0.3 W (Off mode)¹ · 0.3 W (Standby Mode)¹ · 26 W (On mode)¹ · 175 W (Max.)² · 19.94 W (Pon)³ · 63.98 kWh (TEC)

*HBR3/DisplayPort 1.4 is supported.

¹ As defined in EU 2019/2021 and EU 2019/2013.

² Max brightness and contrast setting with maximum power loading on all USB ports.

³ Pon: Power consumption of On Mode as defined in Energy Star 8.0 version.

TEC: Total energy consumption in kWh as defined in Energy Star 8.0 version.

This document is informational only and reflects laboratory performance. Your product may perform differently, depending on the software, components and peripherals you ordered and shall have no obligation to update such information.

Accordingly, the customer should not rely upon this information in making decisions about electrical tolerances or otherwise. No warranty as to accuracy or completeness is expressed or implied.





NOTE: This monitor is ENERGY STAR certified.



This product qualifies for ENERGY STAR in the factory default settings which can be restored by “Factory Reset” function in the OSD menu. Changing the factory default settings or enabling other features may increase power consumption that could exceed the ENERGY STAR specified limit.



Physical characteristics

Model	P2423DE	P2723DE
Signal cable type	<ul style="list-style-type: none"> • Digital: DisplayPort, 20 pins • Digital: HDMI, 19 pins (cable not included) • Universal Series Bus: Type-C, 24 pins 	
<p> NOTE: Dell monitors are designed to work optimally with the video cables that are shipped with your monitor. As Dell does not have control over the different cable suppliers in the market, the type of material, connector and process used to manufacture these cables, Dell does not guarantee video performance on cables that are not shipped with your Dell monitor.</p>		
Dimensions (with stand)		
Height (extended)	496.11 mm (19.53 in.)	535.20 mm (21.07 in.)
Height (compressed)	364.00 mm (14.33 in.)	385.20 mm (15.17 in.)
Width	537.80 mm (21.17 in.)	611.60 mm (24.08 in.)
Depth	179.57 mm (7.07 in.)	190.10 mm (7.48 in.)
Dimensions (without stand)		
Height	318.50 mm (12.54 in.)	360.80 mm (14.20 in.)
Width	537.80 mm (21.17 in.)	611.60 mm (24.08 in.)
Depth	52.15 mm (2.05 in.)	52.18 mm (2.05 in.)
Stand dimensions		
Height (extended)	410.80 mm (16.17 in.)	428.30 mm (16.86 in.)
Height (compressed)	364.00 mm (14.33 in.)	381.50 mm (15.02 in.)
Width	245.00 mm (9.65 in.)	268.00 mm (10.55 in.)
Depth	179.57 mm (7.07 in.)	190.10 mm (7.48 in.)
Base	245.00 x 173.00 mm (9.65 in. x 6.81 in.)	268.00 x 185.00 mm (10.55 in. x 7.28 in.)
Weight		
Weight with packaging	7.97 kg (17.57 lb)	9.78 kg (21.56 lb)
Weight with stand assembly and cables	5.98 kg (13.18 lb)	7.34 kg (16.18 lb)



Weight without stand assembly (For wall mount or VESA mount considerations - no cables)	3.92 kg (8.64 lb)	5.07 kg (11.18 lb)
Weight of stand assembly	1.63 kg (3.59 lb)	1.84 kg (4.06 lb)
Front-frame gloss	Black frame 2-4 gloss units	



Environmental characteristics

Model	P2423DE	P2723DE
Compliant Standards		
<ul style="list-style-type: none"> ENERGY STAR certified monitor. EPEAT registered where applicable. EPEAT registration varies by country. See www.epeat.net for registration status by country. RoHS-compliant. TCO Certified & TCO Certified Edge. BFR/PVC free monitor (excluding external cables). Meets NFPA 99 leakage current requirements. Arsenic-free glass and Mercury-free for the panel only. 		
Temperature		
Operating	0°C to 40°C (32°F to 104°F)	
Non-operating	<ul style="list-style-type: none"> Storage: -20°C to 60°C (-4°F to 140°F) Shipping: -20°C to 60°C (-4°F to 140°F) 	
Humidity		
Operating	10% to 80% (non-condensing)	
Non-operating	<ul style="list-style-type: none"> Storage 5% to 90% (non-condensing) Shipping 5% to 90% (non-condensing) 	
Altitude		
Operating (maximum)	5,000 m (16,400 ft)	
Non-operating (maximum)	12,192 m (40,000 ft)	
Thermal dissipation	<ul style="list-style-type: none"> 581.40 BTU/hour (Maximum) 68.40 BTU/hour (On Mode) 	<ul style="list-style-type: none"> 598.50 BTU/hour (Maximum) 88.92 BTU/hour (On Mode)



Pin assignments

DisplayPort connector (in)

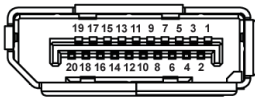

Pin number	20-pin side of the connected signal cable
1	ML3 (n)
2	GND
3	ML3 (p)
4	ML2 (n)
5	GND
6	ML2 (p)
7	ML1 (n)
8	GND
9	ML1 (p)
10	ML0 (n)
11	GND
12	ML0 (p)
13	GND
14	GND
15	AUX (p)
16	GND
17	AUX (n)
18	Hot Plug Detect
19	Re-PWR
20	+3.3 V DP_PWR



DisplayPort connector (out)

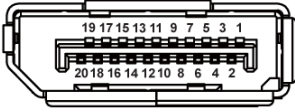

Pin number	20-pin side of the connected signal cable
1	ML0 (p)
2	GND
3	ML0 (n)
4	ML1 (p)
5	GND
6	ML1 (n)
7	ML2 (p)
8	GND
9	ML2 (n)
10	ML3 (p)
11	GND
12	ML3 (n)
13	CONFIG1
14	CONFIG2
15	AUX CH (p)
16	GND
17	AUX CH (n)
18	Hot Plug Detect
19	Return
20	DP_PWR



HDMI connector

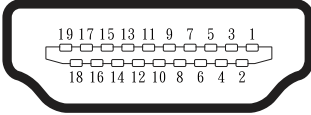

Pin number	19-pin side of the connected signal cable
1	TMDS DATA 2+
2	TMDS DATA 2 SHIELD
3	TMDS DATA 2-
4	TMDS DATA 1+
5	TMDS DATA 1 SHIELD
6	TMDS DATA 1-
7	TMDS DATA 0+
8	TMDS DATA 0 SHIELD
9	TMDS DATA 0-
10	TMDS CLOCK+
11	TMDS CLOCK SHIELD
12	TMDS CLOCK-
13	CEC
14	Reserved (N.C. on device)
15	DDC CLOCK (SCL)
16	DDC DATA (SDA)
17	DDC/CEC Ground
18	+5 V POWER
19	HOT PLUG DETECT



Universal Serial Bus (USB) interface

This section gives you information about the USB ports that are available on the monitor.

SuperSpeed USB 5 Gbps (USB 3.2 Gen1)

Transfer speed	Data rate	Maximum power supported (each port)
SuperSpeed	5 Gbps	4.5 W
High speed	480 Mbps	4.5 W
Full speed	12 Mbps	4.5 W

USB-C

USB-C	Description
Video	DisplayPort 1.4*
Data	SuperSpeed USB 5 Gbps (USB 3.2 Gen1)
Power Delivery (PD)	Up to 90 W

*HBR3 is supported.



USB downstream connector



Pin number	9-pin side of the connector
1	VCC
2	D-
3	D+
4	GND
5	SSRX-
6	SSRX+
7	GND
8	SSTX-
9	SSTX+



USB-C connector

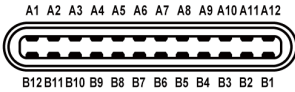

Pin number	Signal name	Pin number	Signal name
A1	GND	B1	GND
A2	TX1+	B2	TX2+
A3	TX1-	B3	TX2-
A4	VBUS	B4	VBUS
A5	CC1	B5	CC2
A6	D+	B6	D+
A7	D-	B7	D-
A8	SBU1	B8	SBU1
A9	VBUS	B9	VBUS
A10	RX2-	B10	RX1-
A11	RX2+	B11	RX1+
A12	GND	B12	GND

USB ports

- 1 USB-C upstream - bottom
- 4 SuperSpeed USB 5 Gbps (USB 3.2 Gen1) Type-A downstream - bottom

 **NOTE: SuperSpeed USB 5 Gbps (USB 3.2 Gen1) functionality requires a SuperSpeed USB 5 Gbps (USB 3.2 Gen1)-capable computer.**

 **NOTE: The USB ports on the monitor work only when the monitor is turned On or in power save mode. If you turn Off the monitor and then turn it On, the attached peripherals may take a few seconds to resume normal functionality.**



RJ45 port (connector side)

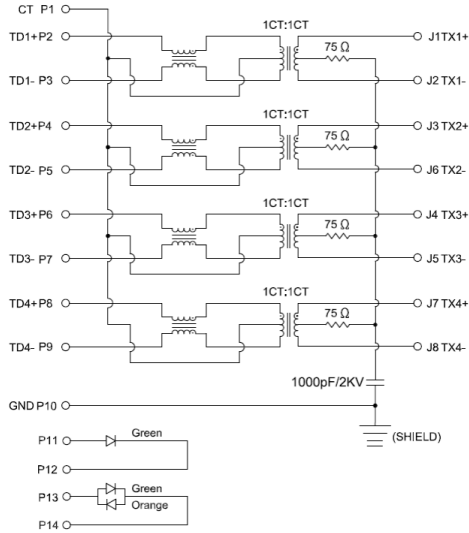

Pin number	Signal
1	CT
2	TD1+
3	TD1-
4	TD2+
5	TD2-
6	TD3+
7	TD3-
8	TD4+
9	TD4-
10	GND
11	GREEN
12	GREEN
13	GREEN_AMBER
14	GREEN_AMBER



Driver installation

Install the Realtek USB GBE Ethernet Controller Driver available for your system. This is available for download at www.dell.com/support under the “Driver and download” section.

Network (RJ45) data rate via USB-C max speed is 1000 Mbps.

NOTE: This LAN port is 1000Base-T IEEE 802.3az compliant, supporting Mac Address (Printed on model label) Pass-thru (MAPT), Wake-on-LAN (WOL) from standby mode (S3 only) and UEFI* PXE Boot function [UEFI PXE Boot is not supported on Dell Desktop PC's (except for OptiPlex 7090/3090 Ultra Desktop)], these 3 features depend on BIOS settings and version of the OS. Functionality may vary with Non Dell PC's.

*UEFI stands for Unified Extensible Firmware Interface.

RJ45 connector LED status



Label	LED	Color	Description
1	Left LED	Green	Link/Activity indicator: <ul style="list-style-type: none"> • Blinking - Activity on the port. • Green On - Link is being established. • Off - Link is not established.
2	Right LED	Amber or Green	Speed indicator: <ul style="list-style-type: none"> • Amber On - 1000 Mbps • Green On - 100 Mbps • Off - 10 Mbps

 **NOTE: The RJ45 cable is non in-box standard accessory.**



Plug and play capability

You can install the monitor in any Plug and Play-compatible system. The monitor automatically provides the computer system with its Extended Display Identification Data (EDID) using Display Data Channel (DDC) protocols so that the system can configure itself and optimize the monitor settings. Most monitor installations are automatic; you can select different settings if desired. For more information about changing the monitor settings, see [Operating the monitor](#).

LCD monitor quality and pixel policy

During the LCD Monitor manufacturing process, it is not uncommon for one or more pixels to become fixed in an unchanging state which are hard to see and do not affect the display quality or usability. For more information on Dell Monitor Quality and Pixel Policy, see Dell Support site at www.dell.com/pixelguidelines.

Ergonomics

 **CAUTION: Improper or prolonged usage of keyboard may result in injury.**

 **CAUTION: Viewing the monitor screen for extended periods of time may result in eye strain.**

For comfort and efficiency, observe the following guidelines when setting up and using your computer workstation:

- Position your computer so that the monitor and keyboard are directly in front of you as you work. Special shelves are commercially available to help you correctly position your keyboard.
- To reduce the risk of eye strain and neck, arm, back, or shoulder pain from using the monitor for long period, we recommend you to:
 1. Set the distance of the screen between 20 in. to 28 in. (50 cm - 70 cm) from your eyes.
 2. Blink frequently to moisten your eyes or wet your eyes with water after prolonged usage of the monitor.
 3. Take regular and frequent breaks for 20 minutes every two hours.
 4. Look away from your monitor and gaze at a distant object at 20 feet away for at least 20 seconds during the breaks.
 5. Perform stretches to relieve tension in the neck, arm, back, and shoulders during the breaks.



- Ensure that the monitor screen is at eye level or slightly lower when you are sitting in front of the monitor.
- Adjust the tilt of the monitor, its contrast, and brightness settings.
- Adjust the ambient lighting around you (such as overhead lights, desk lamps, and the curtains or blinds on nearby windows) to minimize reflections and glare on the monitor screen.
- Use a chair that provides good lower-back support.
- Keep your forearms horizontal with your wrists in a neutral, comfortable position while using the keyboard or mouse.
- Always leave space to rest your hands while using the keyboard or mouse.
- Let your upper arms rest naturally on both sides.
- Ensure that your feet are resting flat on the floor.
- When sitting, ensure that the weight of your legs is on your feet and not on the front portion of your seat. Adjust your chair's height or use a footrest if necessary to maintain a proper posture.
- Vary your work activities. Try to organize your work so that you do not have to sit and work for extended periods of time. Try to stand or get up and walk around at regular intervals.
- Keep the area under your desk clear of obstructions and cables or power cords that may interfere with comfortable seating or present a potential trip hazard.

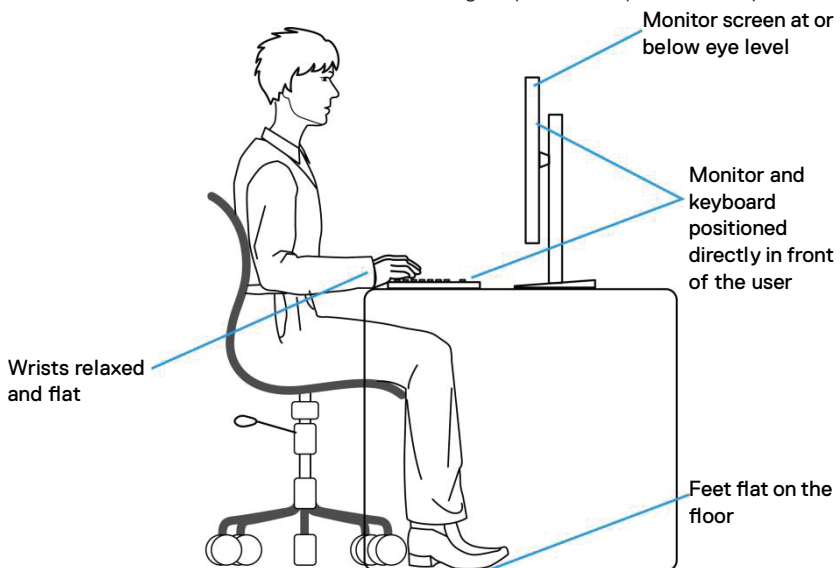

Handling and moving your display

To ensure that the monitor is handled safely when lifting or moving it, observe the following guidelines:

- Before moving or lifting the monitor, turn off your computer and the monitor.
- Disconnect all cables from the monitor.
- Place the monitor in the original box with the original packing materials.
- Hold the bottom edge and the side of the monitor firmly without applying excessive pressure when lifting or moving the monitor.

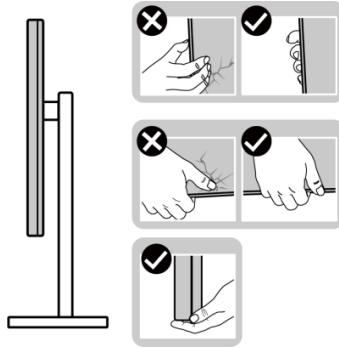

- When lifting or moving the monitor, ensure that the screen is facing away from you. Do not press on the display area to avoid any scratches or damage.

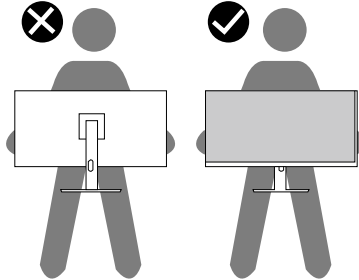

- When transporting the monitor, avoid any sudden shock or vibration to it.
- When lifting or moving the monitor, do not turn the monitor upside down while holding the stand base or stand riser. It may result in accidental damage to the monitor or cause personal injury.



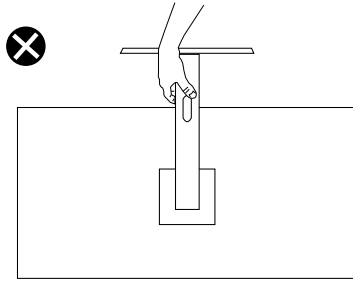

Maintenance guidelines

Cleaning your monitor

- ⚠ WARNING:** Before cleaning the monitor, unplug the monitor power cable from the electrical outlet.
- ⚠ CAUTION:** Read and follow the [Safety instructions](#) before cleaning the monitor.
- ⚠ WARNING:** Before cleaning the monitor, unplug the monitor power cable from the electrical outlet.

For best practices, follow the instructions in the list below when unpacking, cleaning, or handling your monitor:

- To clean the Dell monitor screen, lightly dampen a soft, clean cloth with water. If possible, use a special screen-cleaning tissue or solution suitable for the Dell monitor screen.
- ⚠ CAUTION:** Do not use detergents or other chemicals such as benzene, thinner, ammonia, abrasive cleaners, or compressed air.
- ⚠ CAUTION:** Using chemicals for cleaning may cause changes in the appearance of the monitor, such as color fading, milky film on the monitor, deformation, uneven dark shade, and peeling of screen area.
- ⚠ WARNING:** Do not spray the cleaning solution or even water directly on the surface of the monitor. Doing so will allow liquids to accumulate at the bottom of the display panel and corrode the electronics resulting in permanent damage. Instead, apply the cleaning solution or water to a soft cloth and then clean the monitor.





 **NOTE: Monitor damage due to improper cleaning methods and the use of benzene, thinner, ammonia, abrasive cleaners, alcohol, compressed air, detergent of any kind will lead to a Customer Induced Damage (CID). CID is not covered under the standard Dell warranty.**

- If you notice white powder when you unpack your monitor, wipe it off with a cloth.
- Handle your monitor with care as a dark-colored monitor may get scratched and show white scuff marks more than a light-colored monitor.
- To help maintain the best image quality on your monitor, use a dynamically changing screen saver and turn off your monitor when not in use.



Setting up the monitor

Attaching the stand

-  **NOTE:** The stand is not installed at the factory when shipped.
-  **NOTE:** The following instructions are applicable only for the stand that was shipped with your monitor. If you are attaching a stand that you purchased from any other source, follow the setup instructions that were included with the stand.

To attach the monitor stand:

1. Follow the instructions on the flaps of carton to remove the stand from the top cushion that secures it.
2. Remove the stand base and stand riser from the packaging cushion.

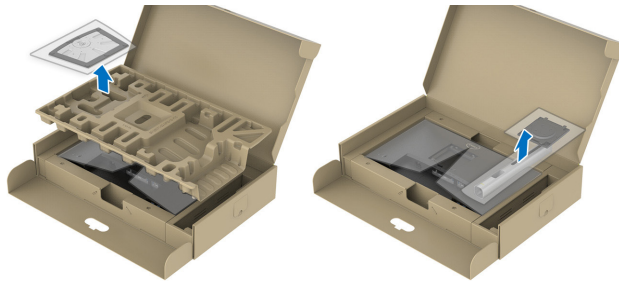

-  **NOTE:** The graphics are used for the purpose of illustration only. The appearance of the package cushion may vary.

3. Insert the stand base blocks fully into the stand slot.
4. Lift the screw handle and turn the screw clockwise.
5. After fully tightening the screw, fold the screw handle flat within the recess.

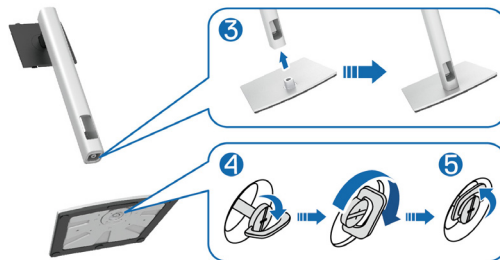

6. Lift the cover, as shown, to access the VESA area for stand assembly.



NOTE: Before attaching the stand assembly to the display, ensure that the front plate flap is opened to allow space for assembly.

7. Attach the stand assembly to the display.
- a. Fit the two tabs on the upper part of the stand to the groove on the back of the display.
 - b. Press the stand down till it snaps into place.



8. Hold the stand riser and lift the monitor carefully, then place it on a flat surface.

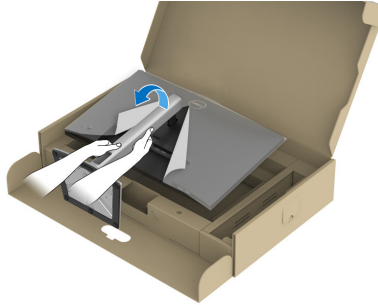

 **NOTE: Lift the monitor carefully to prevent it from slipping or falling.**

9. Remove the cover from the monitor.

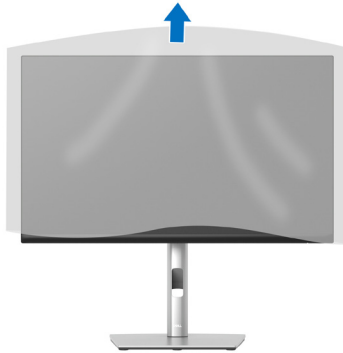

Connecting your monitor

⚠ WARNING: Before you begin any of the procedures in this section, follow the [Safety instructions](#).

🔧 NOTE: Dell monitors are designed to work optimally with Dell supplied inbox cables. Dell does not guarantee the video quality and performance if non-Dell cables are used.

🔧 NOTE: Route the cables through the cable-management slot before connecting them.

🔧 NOTE: Do not connect all cables to the computer at the same time.

🔧 NOTE: The images are for the purpose of illustration only. The appearance of the computer may vary.

To connect your monitor to the computer:

1. Turn off your computer and disconnect the power cable.
2. Route the power cable through the cable-management slot on the stand and then connect it to the monitor.



3. Connect the DisplayPort, HDMI, USB-C (C-C), or USB-C (C-A) cable from your monitor to the computer.



Connecting the DisplayPort (DisplayPort to DisplayPort) cable

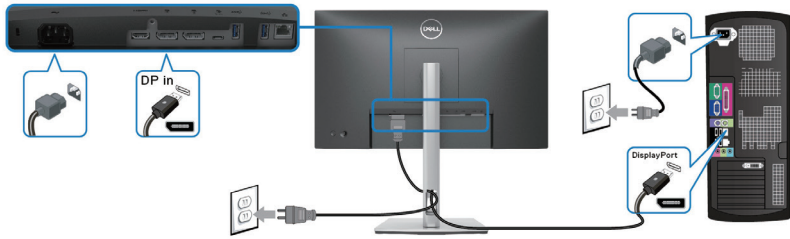

Connecting the USB-C (C-A) cable



Connecting the USB-C (C-C) cable

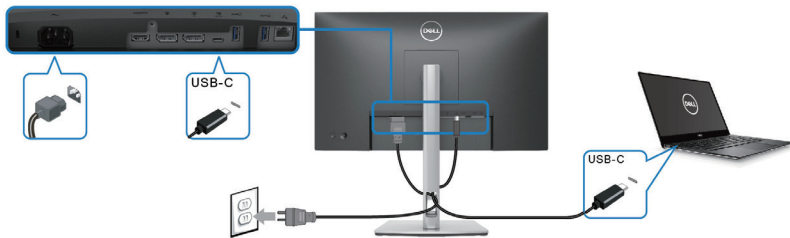

NOTE: Use the USB-C (C-C) cable shipped with monitor only.

- This port supports DisplayPort Alternate Mode (DP1.4 standard only).
- The USB-C power delivery compliant port (PD Version 3.0) delivers up to 90 W of power.
- If your notebook requires more than 90 W to operate and the battery is drained, it may not be powered up or charged with the USB PD port of this monitor.



Connecting the HDMI cable (optional)

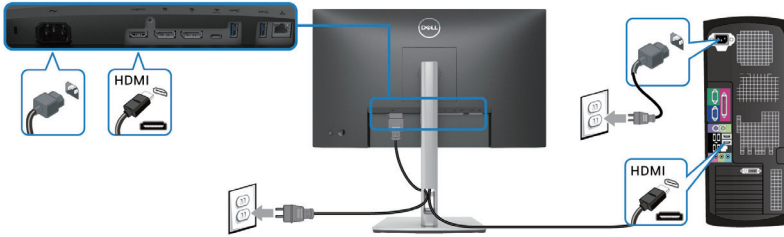

Connecting the monitor for DP Multi-Stream Transport (MST) function

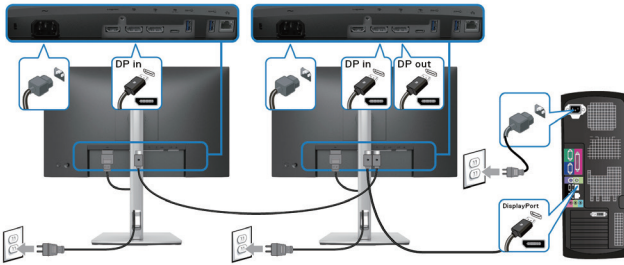

NOTE: This monitor supports the DP MST feature. To make use of this feature, your PC Graphics Card must be certified to DP1.4 with MST option.

NOTE: Remove the rubber plug when using DP out connector.

Connecting the monitor for USB-C Multi-Stream Transport (MST) function

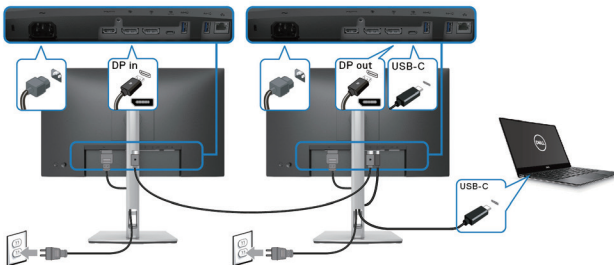

NOTE: The maximum number of supported monitors via MST is subjected to the bandwidth of the USB-C source.

NOTE: Remove the rubber plug when using the DP out connector.



Connecting the RJ45 cable (optional)

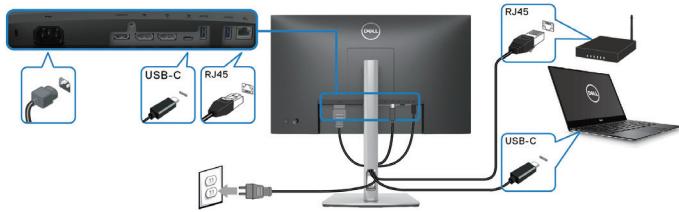

NOTE: The RJ45 cable is not an in-box standard accessory.



Dell Power Button Sync (DPBS)

Your monitor is designed with Dell Power Button Sync (DPBS) feature to allow you to control PC system power state from the monitor power button. This feature is only supported with Dell platform which has built-in DPBS function, and is only supported over USB-C interface.

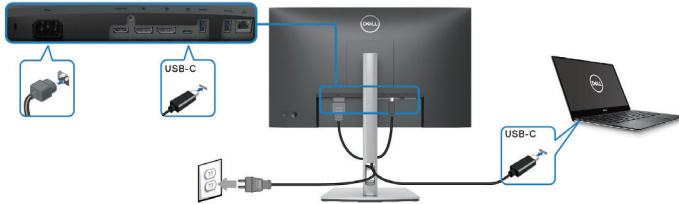

To make sure the DPBS function works for the first time, perform the following steps on the DPBS supported platform in the **Control Panel** first.

NOTE: DPBS only supports the USB-C upstream port.

1. Go to **Control Panel**.

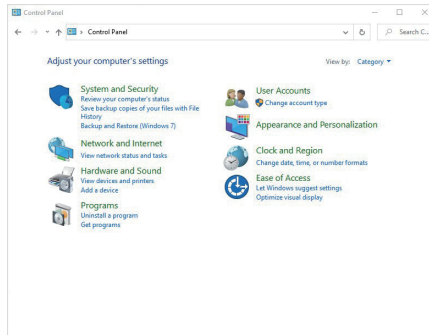

2. Select **Hardware and Sound**, followed by **Power Options**.

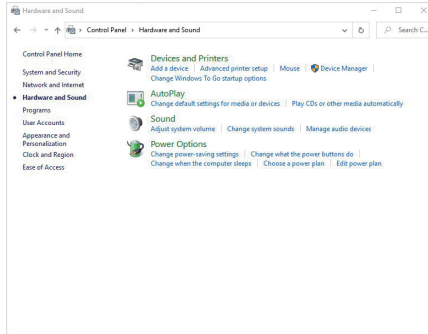

3. Go to **System Settings**.

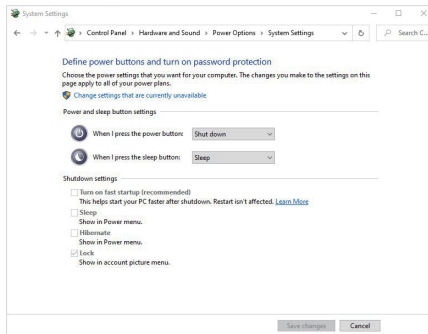

4. In the drop-down menu of **When I press the power button**, there are a few options for selection, namely **Do nothing/Sleep/Hibernate/Shut down**. You can select **Sleep/Hibernate/Shut down**.

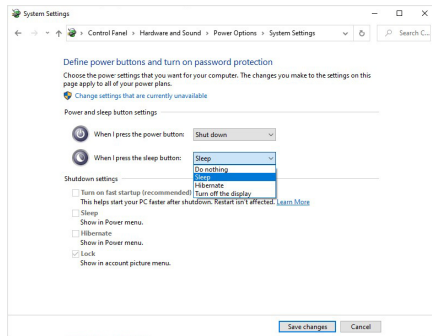
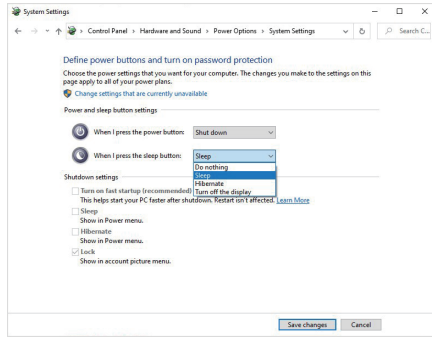

NOTE: Do not select “Do nothing”, otherwise the monitor power button will not be able to sync with PC system power state.



Connecting the monitor for DPBS for the first time

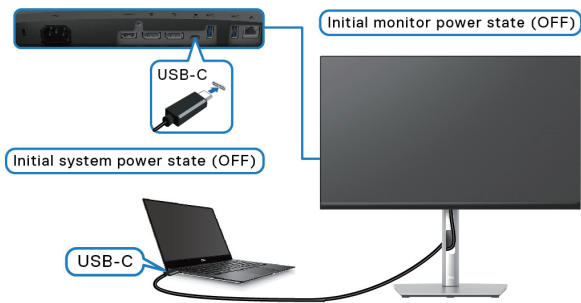

For the first time setting up the DPBS function:

1. Make sure both the PC and the monitor are OFF.
2. Press the monitor power button to turn ON the monitor.
3. Connect the USB-C cable from the PC to the monitor.
4. Both the monitor and PC will turn ON normally except Dell OptiPlex 7090/3090 Ultra platform.
5. When you connect the Dell OptiPlex 7090/3090 Ultra platform, you may see both the monitor and PC will turn ON momentarily. Wait for a while (approximately 6 seconds) and both the PC and monitor will turn OFF. When you press either the monitor power button or PC power button, both the PC and monitor will turn ON. The PC system power state is in sync with the monitor power button.

NOTE: When the monitor and PC are both at power OFF state for the first time, it is recommended that you turn ON the monitor first, then connect the USB-C cable from the PC to the monitor.

NOTE: You can power the Dell PC* Ultra platform using its DC adaptor jack. Alternatively, you can power the Dell PC* Ultra platform using the monitor's USB-C cable via Power Delivery (PD); please set USB-C Charging  90W to On in Off Mode.

*Ensure to check the Dell PC for DPBS supportability.



Using DPBS function

Waking on the USB-C cable

When you connect the USB-C cable, the Monitor/PC state is as follows:

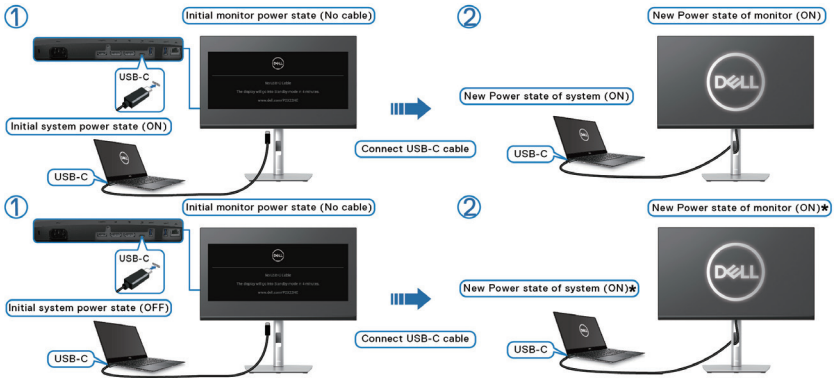

***Not all Dell PC systems support to wake up the platform via the monitor.**

***After connect the USB-C cable, tap on Keyboard or moving the mouse for the system to continue its boot up process when necessary.**

When you press the monitor power button or PC power button, the Monitor/PC state is as follows:

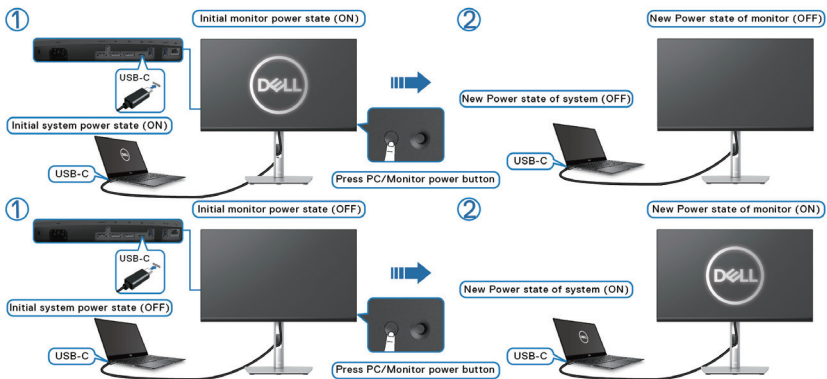

- When the monitor and the PC power state are both ON, **press and hold the monitor power button for 4 seconds**, the screen prompt will ask if you would like to shut down the PC.

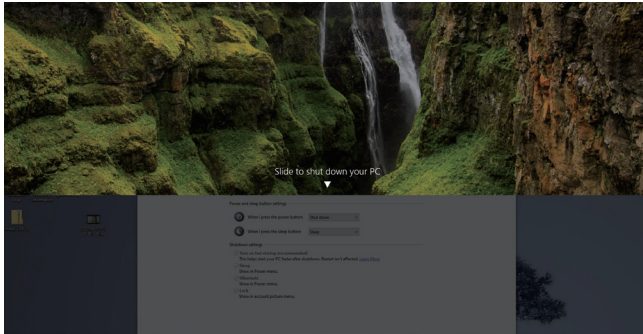
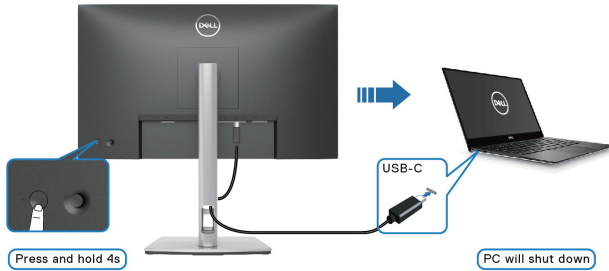

- When the monitor and the PC power state are both ON, **press and hold the monitor power button for 10 seconds**, the PC will shut down.

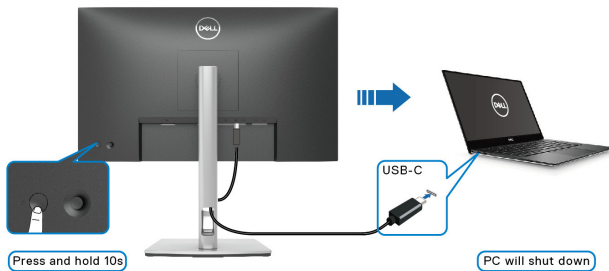

Connecting the monitor for USB-C Multi-Stream Transport (MST) function

A PC is connected to two monitors in an initial OFF power state, and the PC system power state is in sync with Monitor 1 power button. When you press Monitor 1 or PC power button, both Monitor 1 and PC turns ON. Meanwhile, Monitor 2 will remain OFF. You need to manually press the power button on Monitor 2 to turn it ON.

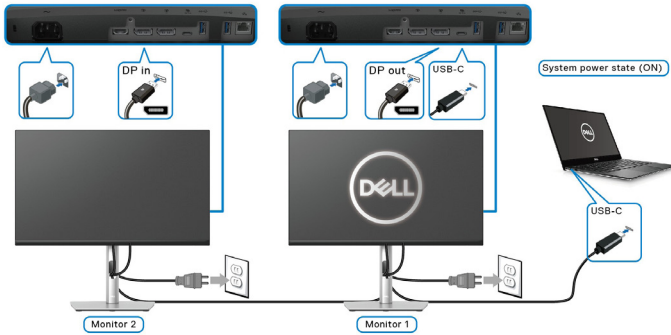

Similarly, a PC is connected to two monitors in an initial ON power state, and the PC system power state is in sync with Monitor 1 power button. When you press Monitor 1 or PC power button, both Monitor 1 and PC turn OFF. Meanwhile, Monitor 2 will be in Standby mode. You need to manually press the power button on Monitor 2 to turn it OFF.

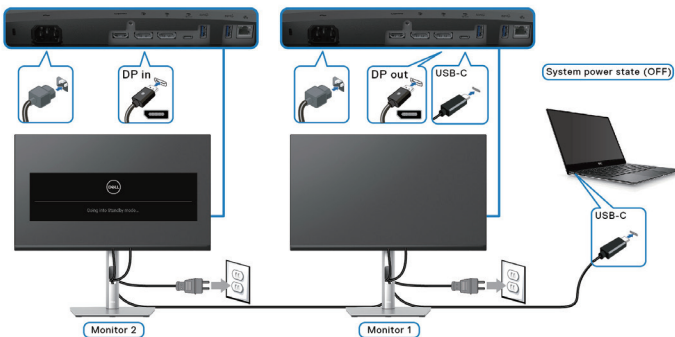

Connecting the monitor for USB-C

The Dell PC* Ultra platform has two USB-C ports, so both Monitor 1 and Monitor 2 power state can sync with the PC.

When the PC and two monitors are in an initial ON power state, pressing the power button on Monitor 1 or Monitor 2 will turn OFF the PC, Monitor 1, and Monitor 2.

*Ensure to check the Dell PC for DPBS supportability.

NOTE: DPBS only supports the USB-C upstream port.

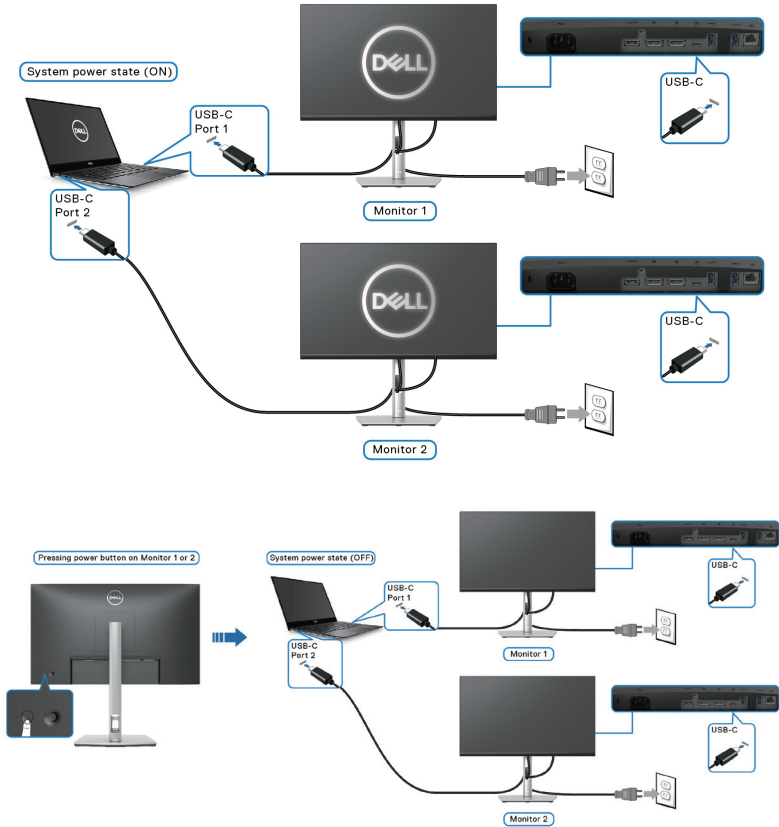

Ensure to set **USB-C Charging 90W to On in Off Mode**. When the PC and two monitors are in an initial OFF power state, pressing the power button on Monitor 1 or Monitor 2 will turn ON the PC, Monitor 1, and Monitor 2.

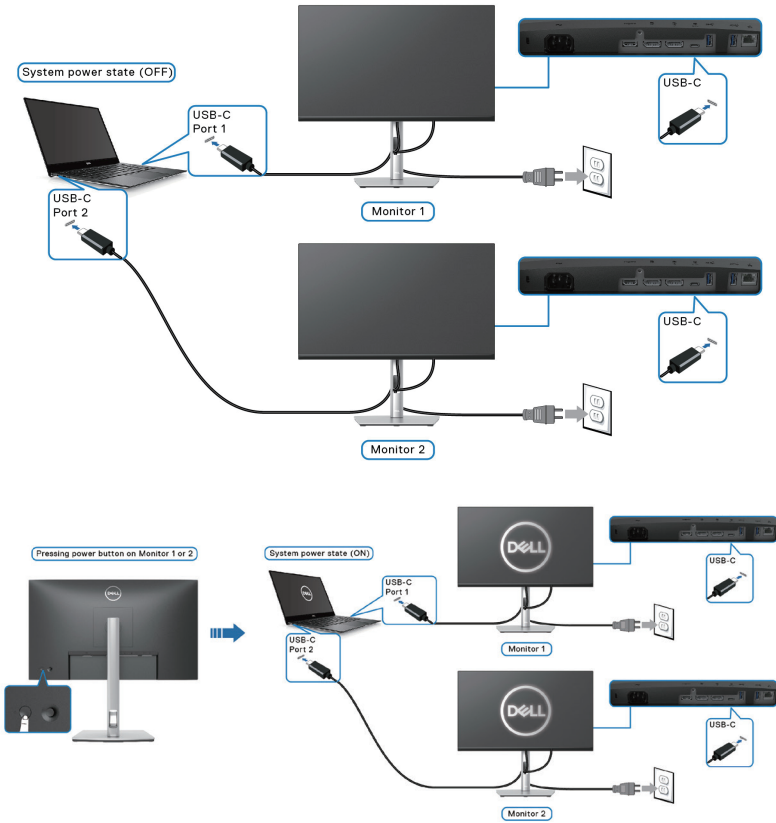

Organizing cables



After attaching all necessary cables to your monitor and computer, (See [Connecting your monitor](#) for cable attachment,) organize all cables as shown above.

Securing your monitor using Kensington lock (optional)

The security lock slot is located at the bottom of the monitor. (see [Security lock slot](#)). Secure your monitor to a table using the Kensington security lock.

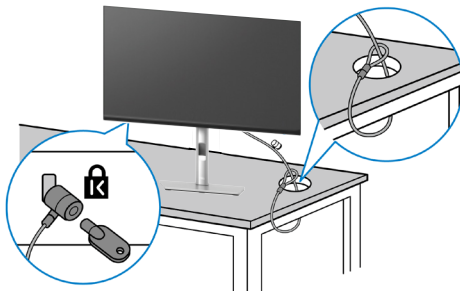

For more information on using the Kensington lock (sold separately), see the documentation that is shipped with the lock.



NOTE: The image is for the purpose of illustration only. The appearance of the lock may vary.



Removing the monitor stand

-  **NOTE:** To prevent scratches on the LCD screen when removing the stand, ensure that the monitor is placed on a soft surface and handle it carefully.
-  **NOTE:** The following steps are specifically for removing the stand that is shipped with your monitor. If you are removing a stand that you purchased from any other source, follow the setup instructions that are included with the stand.

To remove the stand:

1. Place the monitor on a soft cloth or cushion.
2. Press and hold the stand release button.
3. Lift the stand up and away from the monitor.



VESA wall mounting (optional)

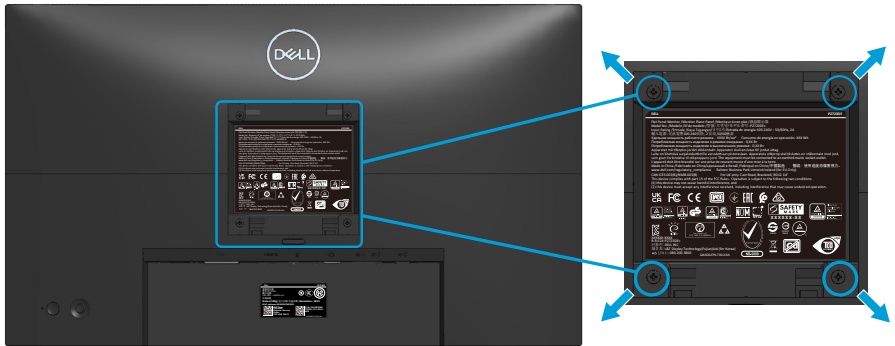

(Screw dimension: M4 x 10 mm).

See the documentation that shipped with the VESA-compatible wall mounting kit.

1. Place the display on a soft cloth or cushion at the edge of the desk.
2. Remove the stand. See [Removing the monitor stand](#).
3. Remove the four screws that secure the display back cover.
4. Install the mounting bracket from the wall mounting kit to the display.
5. To mount the monitor on the wall, see the documentation that shipped with the wall mounting kit.



NOTE: For use only with UL or CSA or GS-listed wall mount bracket with minimum weight/load bearing capacity of 15.68 kg (P2423DE) / 20.28 kg (P2723DE).



Operating the monitor

Power on the monitor

Press the Power button to turn On the monitor.

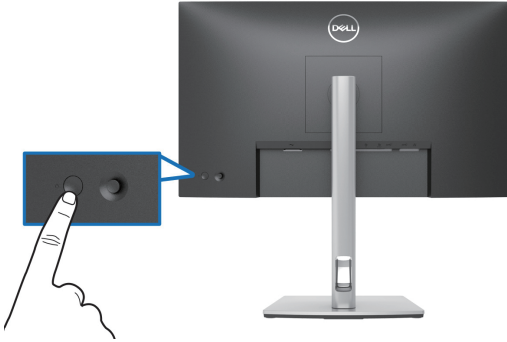

Using the joystick control

Use the joystick control on the rear of the monitor to make On-Screen Display (OSD) adjustments.

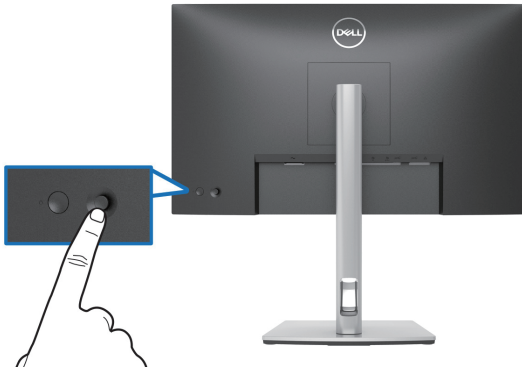

1. Press the joystick to launch the Menu Launcher.
2. Move the joystick up/down/left/right to toggle between options.
3. Press the joystick again to confirm the selection.



Using the On-Screen Display (OSD) menu



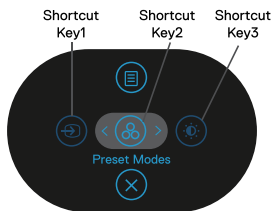

Accessing the Menu Launcher

When you toggle or press the joystick, the Menu Launcher appears to let you access the OSD main menu and shortcut functions.

To select a function, move the joystick.



The following table describes the Menu Launcher functions:

	Joystick	Description
1	 Shortcut key/ Input Source	To choose an input source from the list of video signals that may be connected to your monitor.
2	 Shortcut key/ Preset Modes	To choose a preferred color mode from the list of preset modes.
3	 Shortcut key/ Brightness/Contrast	To access the adjustment sliders of brightness and contrast.
4	 Menu	To launch the On-Screen Display (OSD) main menu. See Operating the monitor .
5	 OK	To exit the Menu Launcher.



Using the navigation keys

When the OSD main menu is active, move the joystick to configure the settings, following the navigation keys displayed below the OSD.

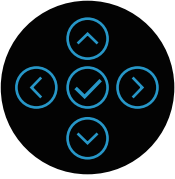

	Joystick	Description
1	 Up	Use the Up direction to adjust (increase ranges) items in the OSD menu.
2	 Down	Use the Down direction to adjust (decrease ranges) items in the OSD menu.
3	 Left	For all first level in the Menu list, Left arrow will exit/ close the OSD menu.
4	 Right	For all other levels except first level in the Menu list, Right arrow will go to the next level.
5	 OK	Press the joystick to confirm your selection.







Accessing the menu system

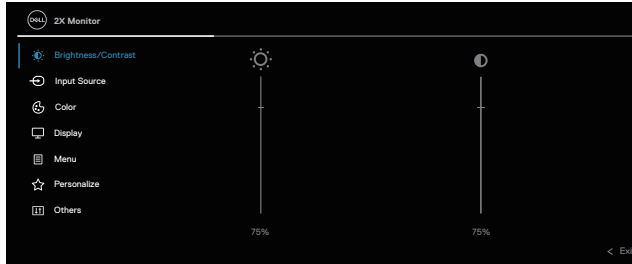





NOTE: If you change the settings and then either proceed to another menu or exit the OSD menu, the monitor automatically saves those changes. The changes are also saved if you change the settings and then wait for the OSD menu to disappear.

1. Select the  icon to launch the OSD and display the main menu.



2. Press the  and  directions to move between the setting options. As you move from one icon to another, the option is highlighted.
3. Press the  or  directions once to activate the highlighted option.

NOTE: NOTE: The directional buttons (and the OK button) displayed may differ according to the menu you've selected. Use available buttons to make your selection.

4. Press  and  directions to select the desired parameter.
5. Press  and then use the  and  directions, according to the indicators on the menu, to make your changes.
6. Select the  to return to the main menu.



Icon	Menu and Submenus	Description
------	-------------------	-------------



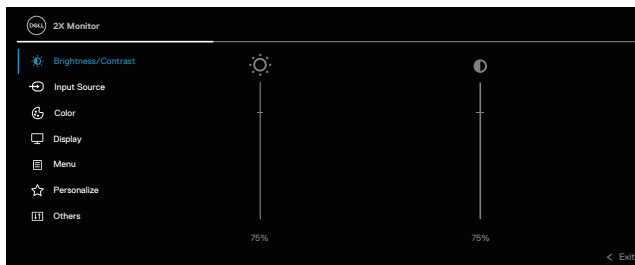

Brightness/Contrast

Use this menu to activate **Brightness/Contrast** adjustment.





Brightness

Brightness adjusts the luminance of the backlight.

Press the  direction to increase the brightness and press the  direction to decrease the brightness (min. 0 / max. 100).

Contrast

Adjust the **Brightness** first, and then adjust the **Contrast** only if further adjustment is necessary.

Press the  direction to increase the contrast and press the  direction to decrease the contrast (min. 0 / max. 100).

The **Contrast** function adjusts the degree of difference between darkness and lightness on the monitor screen.





Input Source

Selects between the different video signals that may be connected to your monitor.

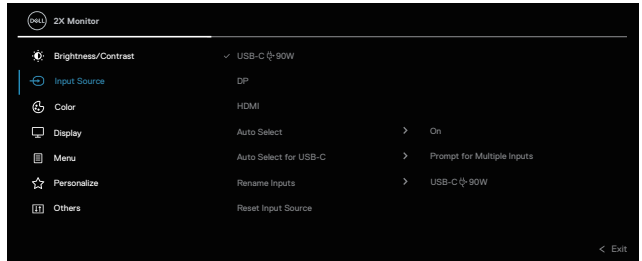

USB-C 90W

Select the **USB-C 90W** input when you are using the USB-C connector. Press the joystick to confirm the selection.

DP

Select the **DP** input when you are using the DisplayPort (DP) connector. Press the joystick to confirm the selection.

HDMI

Select the **HDMI** input when you are using the HDMI connector. Press the joystick to confirm the selection.

Auto Select

Allows you to scan for available input sources. The default is **On**.

Auto Select for USB-C

Allows you to set Auto Select for USB-C to:

- ◆ **Prompt for Multiple Inputs:** Always displays the “Switch to USB-C Video Input” message for you to choose whether to switch or not.
- ◆ **Yes:** Always switches to USB-C video input (without asking) when the USB-C (C-C) cable is connected.
- ◆ **No:** Never automatically switches to USB-C video input when the USB-C (C-C) cable is connected.

Press the joystick to confirm the selection.



NOTE: The option is available only when Auto Select is on.



Rename Inputs Allows you to specify a preset input name for the selected input source. The preset options are **PC**, **PC 1**, **PC 2**, **Laptop**, **Laptop 1**, and **Laptop 2**. The default setting is **Off**.

 **NOTE: When you perform a rename for the USB-C input, the wattage value remains after the specified option, e.g., PC 1 ⚡ 90W.**

 **NOTE: It is not applicable for the input names shown in the warning messages and Display Info.**

Reset Input Source Resets your monitor input settings to the factory settings.

Color Adjusts the color setting mode.

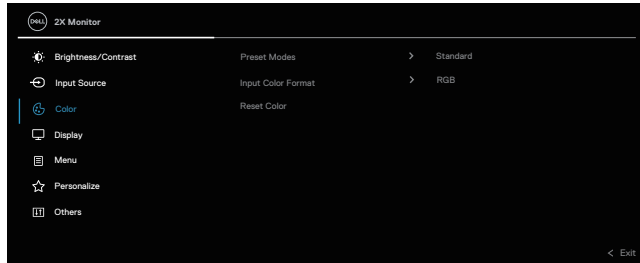

Preset Modes Allows you to choose from the list of preset color modes. Press the joystick to confirm the selection.



- **Standard:** Loads the monitor's default color settings. This is the default preset mode.
 - **Movie:** Loads color settings ideal for movies.
 - **Game:** Loads color settings ideal for most gaming applications.
 - **Warm:** Increases the color temperature. The screen appears warmer with a red/yellow tint.
 - **Cool:** Presents colors at higher color temperatures. The screen appears cooler with a blue tint.
 - **Custom Color:** Allows you to manually adjust the color settings. Move the joystick to adjust the R/G/B color values and create your own preset color mode.
-



Input Color Format

Allows you to set the video input mode to:

- **RGB:** Select this option if your monitor is connected to a computer or a media player that supports RGB output.
- **YCbCr:** Select this option if your media player supports only YCbCr output.

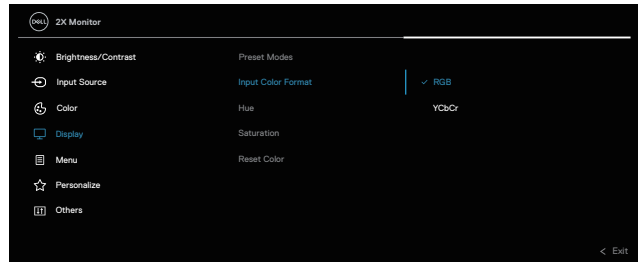

Hue

This feature can shift the color of the video image to green or purple. This is used to adjust the desired flesh tone color. Use ⤴ or ⤵ to adjust the hue from 0 to 100.



Press ⤴ to increase the green shade of the video image.

Press ⤵ to increase the purple shade of the video image.

 **NOTE: Hue adjustment is available only when you select Movie or Game preset mode.**



Saturation

This feature can adjust the color saturation of the video image. Use  or  to adjust the saturation from 0 to 100.

Press  to increase the monochrome appearance of the video image.

Press  to increase the colorful appearance of the video image.



NOTE: Saturation adjustment is available only when you select Movie or Game preset mode.

Reset Color

Resets your monitor's color settings to the factory settings.





Display

Use the display to adjust image.

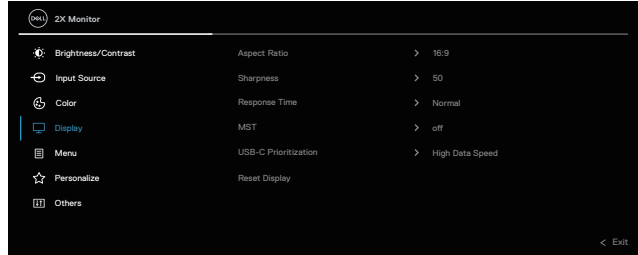

Aspect Ratio	Adjusts the image ratio to 16:9 , 4:3 or 5:4 .
Sharpness	This feature can make the image look sharper or softer. Move the joystick to adjust the sharpness level from '0' to '100'.
Response Time	Allows you to set the Response Time to Normal or Fast .
MST	DisplayPort Multi Stream Transport. The default setting is Off . To enable MST (DP out), select On .  NOTE: When the DisplayPort/USB-C cable and the DP downstream cable are connected, the OSD will set MST to On automatically. This action will only be done once after Factory Reset or Reset Display is selected.
USB-C Prioritization	Allows you to specify the priority to transfer the data with high resolution (High Resolution) or high speed (High Data Speed) when using the USB-C port/ DisplayPort.
Reset Display	Resets all display settings to the factory preset values.





Menu

Select this option to adjust the settings of the OSD, such as, the languages of the OSD, the amount of time the menu remains on screen and so on.

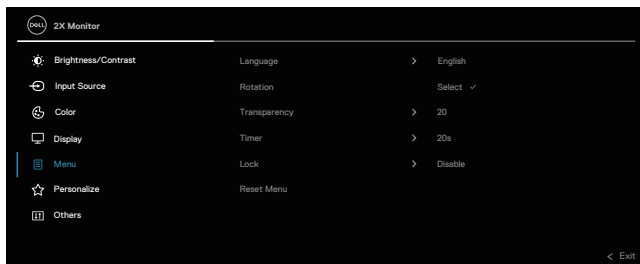

Language

Sets the OSD display to one of the eight languages (English, Spanish, French, German, Brazilian Portuguese, Russian, Simplified Chinese, or Japanese).

Rotation

Press the joystick to rotate the OSD and the screen by 0/90/180/270 degrees.

You can adjust the menu according to your display rotation.

Transparency

Select this option to change the menu transparency by moving the joystick (min. 0 / max. 100).

Timer

Sets the length of time the OSD will remain active after the last time you pressed a button.

Move the joystick to adjust the slider in 1 second increments, from 5 to 60 seconds.

Lock

Controls user access to adjustments. User can select one of the following: Menu Buttons, Power Button, Menu + Power Buttons, Disable.

Reset Menu

Resets all OSD settings to the factory preset values.





Personalize

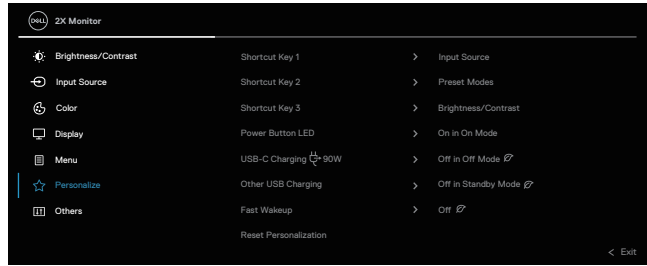

Shortcut Key 1 Allows you to choose a feature from **Preset Modes**, **Shortcut Key 2** **Brightness/Contrast**, **Input Source**, **Aspect Ratio**, **Shortcut Key 3** **Rotation**, or **Display Info** and set it as a shortcut key.

Power Button LED Allows you to set the power LED indicator On or Off to save energy.

USB-C Charging 90W The default setting is **Off in Off Mode**. Selecting **On in Off Mode** may automatically charge your notebook or mobile devices through the USB-C cable even when the monitor is in off mode.

Other USB Charging Allows you to enable or disable USB Type-A (Downstream Ports) charging function during monitor standby mode.

Fast Wakeup The default setting is **Off**. Selecting **On** may prevent the monitor from going into Standby mode. Pressing or move the joystick (except the power button) on the rear panel of the monitor may also wake up the monitor after it goes into Standby mode.

Reset Personalization Resets all settings under the **Personalize** menu to the factory preset values.





Others

Select this option to adjust the OSD settings, such as the DDC/CI, LCD conditioning, and so on.

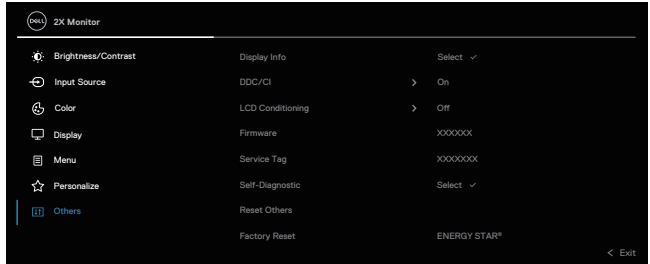

Display Info

Displays the monitor's current settings.

DDC/CI

DDC/CI (Display Data Channel/Command Interface) allows you to adjust the monitor settings using software on your computer. You can disable this feature by selecting **Off**.

Enable this feature for best user experience and optimum performance of your monitor.

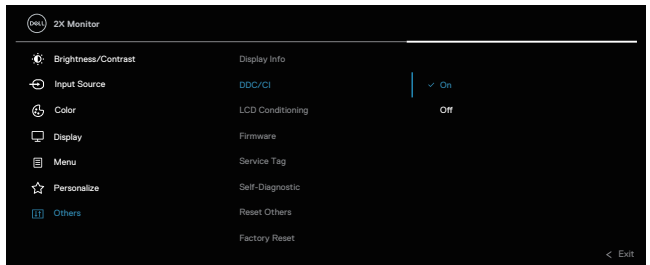

LCD Conditioning

Helps reduce minor cases of image retention. Depending on the degree of image retention, the program may take some time to run. You can enable this feature by selecting **On**.

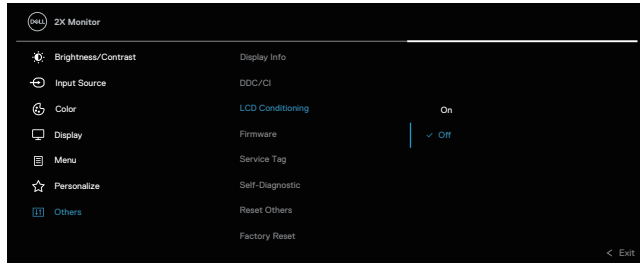

Firmware

Displays the firmware version of your monitor.

Service Tag

Displays the service tag of your monitor. This string is required when you look for phone support, check your warranty status, update drivers on Dell's website, etc.

Self-Diagnostic

Allows you to check if your monitor is functioning properly.

Reset Others

Resets all settings under the **Others** menu to the factory preset values.

Factory Reset

Restore all preset values to the factory default settings. These are also the settings for ENERGY STAR® tests.

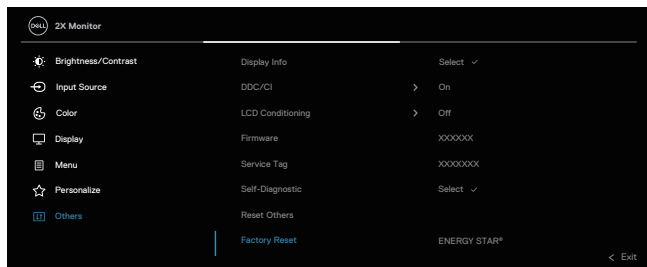

Menu and Power button lock

Prevents users to access or change OSD menu settings on the display.

By default, the Menu and Power button lock setting is disabled.

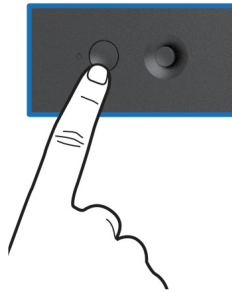

To access the lock menu, press and hold the Up or Down or Left or Right direction for four seconds. A lock menu appears at the bottom right corner of the display.

 **NOTE: The lock menu can be accessed using this method when the Menu and Power buttons are in unlocked state.**

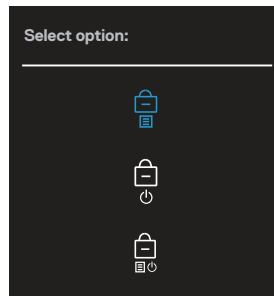



To access the unlock menu, press and hold the Up or Down or Left or Right direction for four seconds. An unlock menu appears at the bottom right corner of the display.

 **NOTE: The unlock menu can be accessed when the Menu and Power buttons are in locked state.**

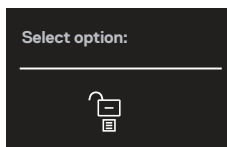



There are three lock options.

	Menu	Description
1	Menu Buttons 	When Menu Buttons is selected, the OSD menu settings cannot be changed. All buttons are locked except Power button.
2	Power Button 	When Power Button is selected, the display cannot be turned off using the Power button.
3	Menu + Power Buttons 	When Menu + Power Buttons is selected, the OSD menu settings cannot be changed and the Power button is locked.

 **NOTE: To access the Lock or Unlock menu – Press and hold the Up or Down or Left or Right direction for four seconds.**

In the following scenarios, the  icon appears at the center of the display:

- When Up or Down or Left or Right direction are pressed. This indicates the OSD menu buttons are in lock state.
- When the Power button is pressed. This indicates the Power button is in lock state.
- When Up or Down or Left or Right direction or Power button are pressed. This indicates OSD menu buttons and the Power button is in lock state.

Unlocking the OSD menu and Power buttons:

1. Press and hold the Up or Down or Left or Right direction for four seconds. The unlock menu appears.
2. Select the unlock icon  to unlock the buttons on the display.



OSD warning messages

When the monitor does not support a particular resolution mode, you will see the following message:

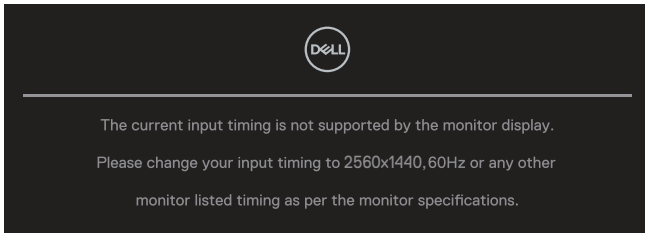

This means that the monitor cannot synchronize with the signal that it is receiving from the computer. See monitor specifications for the Horizontal and Vertical frequency ranges addressable by this monitor. Recommended mode is **2560 x 1440**.

You will see the following message before the **DDC/CI** function is disabled:

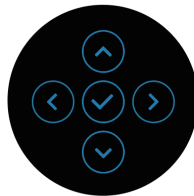

When you adjust the **Brightness** level above the default level for the first time, the following message appears:

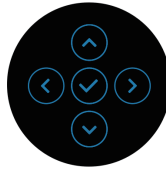
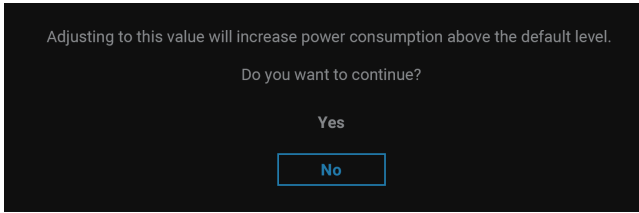

NOTE: If you select **Yes**, the message will not appear the next time you change the **Brightness** setting.

When you change the default setting of power saving features for the first time, such as **USB-C Charging 90W**, **Other USB Charging**, or **Fast Wakeup**, the following message appears:

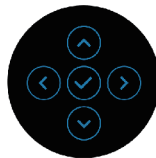
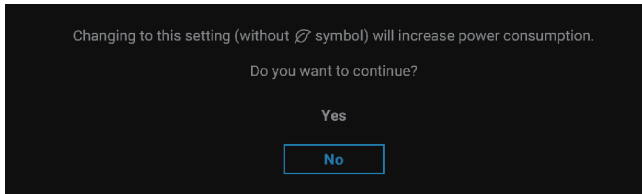

NOTE: If you select **Yes** for either of the features mentioned above, the message will not appear the next time you change the settings of these features. When you perform a factory reset, the message will appear again.



When the monitor goes into Standby mode, the following message appears:

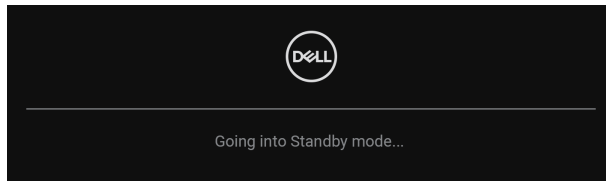

Activate the computer and wake up the monitor to gain access to the OSD. The OSD functions only in the normal operation mode. If you press the joystick during the Standby mode, the following message will appear depending on the selected input:

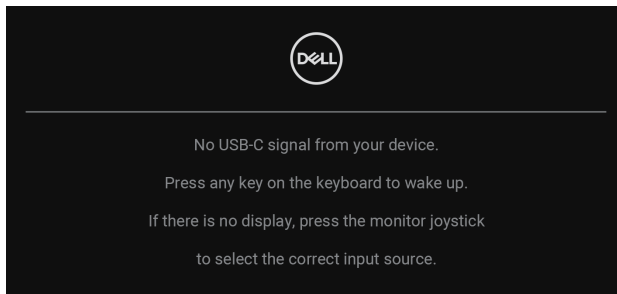

Activate the computer and the monitor to gain access to the OSD.

 **NOTE: The message may be slightly different according to the connected input signal.**

If either USB-C, DisplayPort, or HDMI input is selected and the corresponding cable is not connected, the following message will appear:

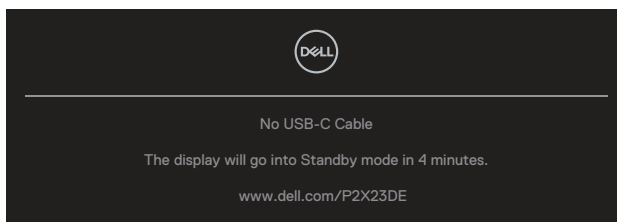

or



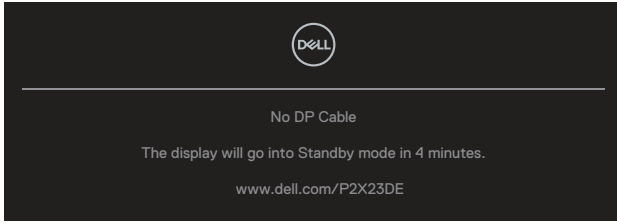

or

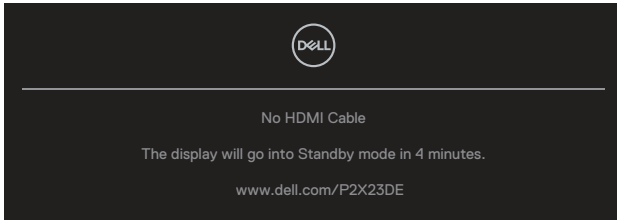

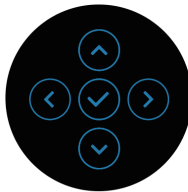
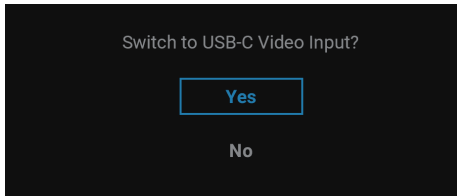

 **NOTE: The message may be slightly different according to the connected input signal.**

When the monitor is under DP/HDMI input and a USB-C (C-C) cable is connected to a notebook that supports DP Alternate Mode, if [Auto Select for USB-C](#) is enabled, the following message appears:

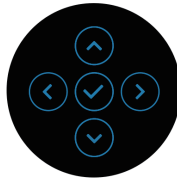
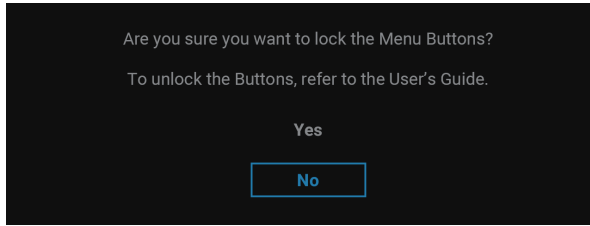

You will see the following message before the **Lock** function is activated:



 **NOTE:** The message may be slightly different according to the selected settings.

When **Factory Reset** is selected, the following message appears:

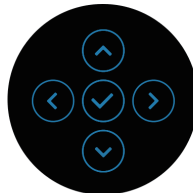
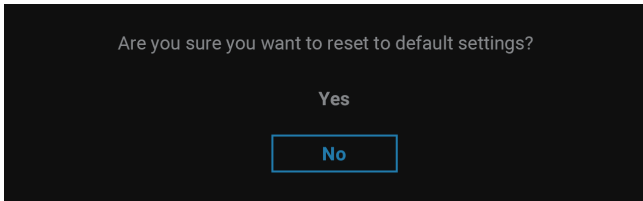

When **Yes** is selected, the following message appears.

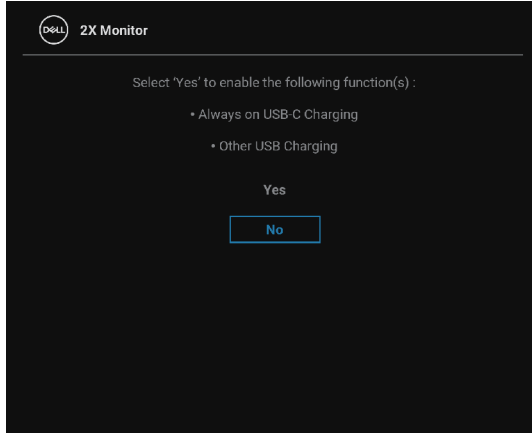

When **Yes** is selected, the following message appears.

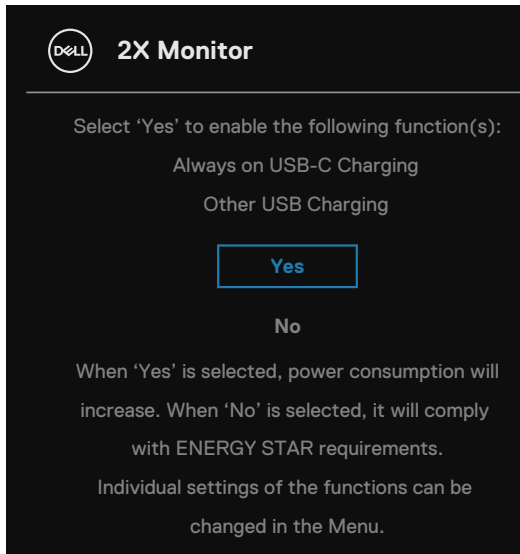

See [Troubleshooting](#) for more information.



Setting the maximum resolution

 **NOTE: The steps may vary slightly depending on the version of Windows you have.**

To set the maximum resolution for the monitor:

In Windows 8.1:

1. For Windows 8.1, select the Desktop tile to switch to classic desktop.
2. Right-click on the desktop and click **Screen Resolution**.
3. If you have more than one monitor connected, ensure that you select **P2423DE/ P2723DE**.
4. Click the **Screen Resolution** dropdown list and select **2560 x 1440**.
5. Click **OK**.

In Windows 10 and Windows 11:

1. Right-click on the desktop and click **Display settings**.
2. If you have more than one monitor connected, ensure to select **P2423DE/ P2723DE**.
3. Click the **Display Resolution** dropdown list and select **2560 x 1440**.
4. Click **Keep changes**.

If you do not see **2560 x 1440** as an option, you must update your graphics driver to the latest version. Depending on your computer, complete one of the following procedures:

If you have a Dell desktop or laptop:

- Go to <https://www.dell.com/support>, enter your service tag, and download the latest driver for your graphics card.

If you are using a non-Dell computer (laptop or desktop):

- Go to the support site for your computer and download the latest graphic drivers.
- Go to your graphics card website and download the latest graphic drivers.



Using the tilt, swivel, and vertical extension

 **NOTE:** The following instructions are applicable only for attaching the stand that was shipped with your monitor. If you are attaching a stand that you purchased from any other source, follow the set up instructions that were included with the stand.

Tilt, swivel

With the stand attached to the monitor, you can tilt and swivel the monitor for the most comfortable viewing angle.

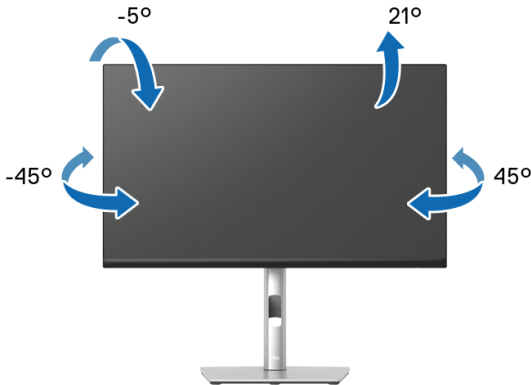

 **NOTE:** The stand is not installed at the factory when shipped.

Vertical Extension

 **NOTE:** The stand extends vertically up to 150 mm. The figure below illustrates how to extend the stand vertically.

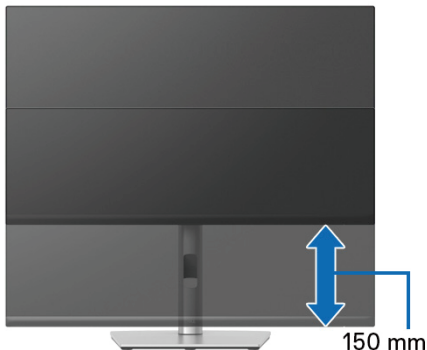

Rotating the monitor

Before you rotate the monitor, your monitor should be fully vertically extended ([Vertical Extension](#)) and fully tilted up to avoid hitting the bottom edge of the monitor.

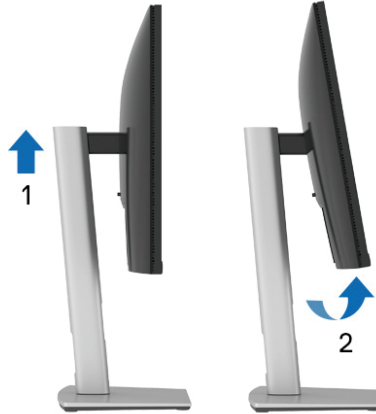



Rotate clockwise



Rotate counterclockwise



-  **NOTE:** To use the Display Rotation function (Landscape versus Portrait view) with your Dell computer, you require an updated graphics driver that is not included with this monitor. To download the graphics driver, go to www.dell.com/support and see the Download section for Video Drivers for latest driver updates.
-  **NOTE:** When in the Portrait View Mode, you may experience performance degradation in graphic-intensive applications (3D Gaming and etc.).



Adjusting the rotation display settings of your system

After you have rotated your monitor, you need to complete the procedure below to adjust the Rotation Display Settings of your system.

 **NOTE: If you are using the monitor with a non-Dell computer, you need to go to the graphics driver website or your computer manufacturer website for information on rotating the 'contents' on your display.**

To adjust the Rotation Display Settings:

1. Right-click on the desktop and click **Properties**.
2. Select the **Settings** tab and click **Advanced**.
3. If you have an ATI graphics card, select the **Rotation** tab and set the preferred rotation.
4. If you have an NVIDIA graphics card, click the **NVIDIA** tab, in the left-hand column select **NVRotate**, and then select the preferred rotation.
5. If you have an Intel® graphics card, select the **Intel** graphics tab, click **Graphic Properties**, select the **Rotation** tab, and then set the preferred rotation.

 **NOTE: If you do not see the rotation option or it is not working correctly, go to www.dell.com/support and download the latest driver for your graphics card.**



Troubleshooting

 **WARNING:** Before you begin any of the procedures in this section, follow the [Safety instructions](#).

Self-Test

Your monitor provides a self-test feature that allows you to check if your monitor is functioning properly. If your monitor and computer are properly connected but the monitor screen remains dark, run the monitor self-test by performing the following steps:

1. Turn off both your computer and the monitor.
2. Disconnect all video cables from the monitor. This way, the computer doesn't have to be involved.
3. Turn on the monitor.

If the monitor cannot sense a video signal and is working correctly, the following message will appear:

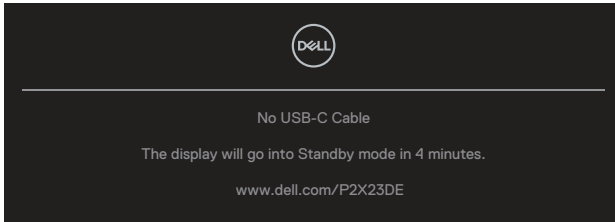

or

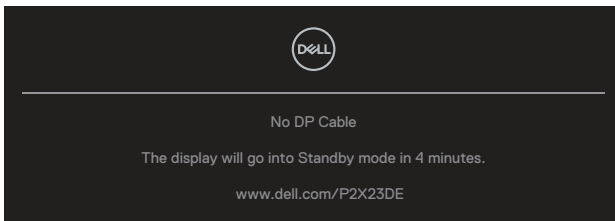

or



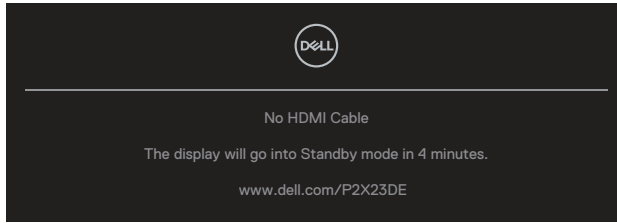

 **NOTE: The message may be slightly different according to the connected input signal.**

 **NOTE: While in self-test mode, the power LED remains white.**

4. This box also appears during normal system operation, if the video cable becomes disconnected or damaged.
5. Turn Off your monitor and reconnect the video cable; then turn On both your computer and the monitor.

If your monitor screen remains blank after you use the previous procedure, check your video controller and computer, because your monitor is functioning properly.

Built-in diagnostics

Your monitor has a built-in diagnostic tool that helps you determine if any screen abnormality you experience is an inherent problem with your monitor, or with your computer and video card.

To run the built-in diagnostics:

1. Ensure that the screen is clean (no dust particles on the surface of the screen).
2. Press the Joystick button to launch the OSD Menu Launcher and move the Joystick up to select “” to open Main Menu.



3. Move the Joystick to select **Others > Self-Diagnostic** to initiate the self-diagnostic process.

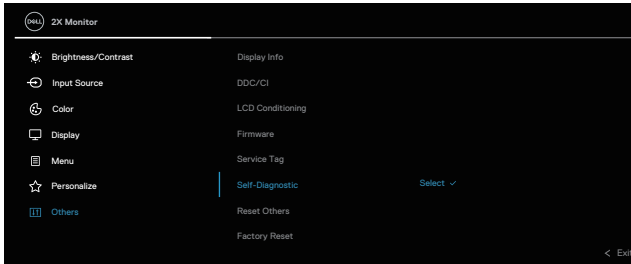

4. When initiated, a gray screen appears. Inspect the screen for abnormalities.
5. Toggle the Joystick. The color of the screen changes to red. Inspect the screen for abnormalities.
6. Repeat step 5 to inspect the display in green, blue, black, white and text screens.
7. The test is complete when the text screen appears. To exit, toggle the Joystick again.

If you do not detect any screen abnormalities upon using the BID tool, the monitor is functioning properly. Please check the video card and computer.



Common problems

The following table contains general information about common monitor problems you might encounter and the possible solutions:

Common Symptoms	What you experience	Possible Solutions
No Video/Power LED off	No picture	<p>Ensure that the video cable connecting the monitor and the computer is properly connected and secure.</p> <ul style="list-style-type: none">• Verify that the power outlet is functioning properly using any other electrical equipment.• Ensure that the power button is pressed.• Ensure that the correct input source is selected via the Input Source menu.
No Video/Power LED on	No picture or no brightness	<ul style="list-style-type: none">• Increase brightness and contrast controls using the OSD.• Perform monitor self-test feature check.• Check for bent or broken pins in the video cable connector.• Run the built-in diagnostics.• Ensure that the correct input source is selected via the Input Source menu.
Poor Focus	Picture is fuzzy, blurry, or ghosting	<ul style="list-style-type: none">• Eliminate video extension cables.• Reset the monitor to Factory Settings (Factory Reset).• Change the video resolution to the correct aspect ratio.
Shaky/Jittery Video	Wavy picture or fine movement	<ul style="list-style-type: none">• Reset the monitor to Factory Settings (Factory Reset).• Check environmental factors.• Relocate the monitor and test in another room.



Missing Pixels	LCD screen has spots	<ul style="list-style-type: none"> • Cycle power On-Off. • Pixel that is permanently Off is a natural defect that can occur in LCD technology. • For more information on Dell Monitor Quality and Pixel Policy, see Dell Support site at: www.dell.com/pixelguidelines.
Stuck-on Pixels	LCD screen has bright spots	<ul style="list-style-type: none"> • Cycle power On-Off. • Pixel that is permanently off is a natural defect that can occur in LCD technology. • For more information on Dell Monitor Quality and Pixel Policy, see Dell Support site at: www.dell.com/pixelguidelines.
Brightness Problems	Picture too dim or too bright	<ul style="list-style-type: none"> • Reset the monitor to Factory Settings (Factory Reset). • Adjust brightness & contrast controls via OSD.
Geometric Distortion	Screen not centered correctly	<ul style="list-style-type: none"> • Reset the monitor to Factory Settings (Factory Reset). • Adjust horizontal & vertical controls via OSD.
Horizontal/Vertical Lines	Screen has one or more lines	<ul style="list-style-type: none"> • Reset the monitor to Factory Settings (Factory Reset). • Perform monitor self-test feature check and determine if these lines are also in self-test mode. • Check for bent or broken pins in the video cable connector. • Run the built-in diagnostics.



Synchronization Problems	Screen is scrambled or appears torn	<ul style="list-style-type: none"> Reset the monitor to Factory Settings (Factory Reset). Perform monitor self-test feature check to determine if the scrambled screen appears in self-test mode. Check for bent or broken pins in the video cable connector. Restart the computer in the safe mode.
Safety Related Issues	Visible signs of smoke or sparks	<ul style="list-style-type: none"> Do not perform any troubleshooting steps. Contact Dell immediately.
Intermittent Problems	Monitor malfunctions on & off	<ul style="list-style-type: none"> Ensure that the video cable connecting the monitor to the computer is connected properly and is secure. Reset the monitor to Factory Settings (Factory Reset). Perform monitor self-test feature check to determine if the intermittent problem occurs in self-test mode.
Missing Color	Picture missing color	<ul style="list-style-type: none"> Perform monitor self-test feature check. Ensure that the video cable connecting the monitor to the computer is connected properly and is secure. Check for bent or broken pins in the video cable connector.
Wrong Color	Picture color not good	<ul style="list-style-type: none"> Try different Preset Modes in Color settings OSD. Adjust R/G/B value in Custom Color in Color settings OSD. Change the Input Color Format to RGB or YCbCr in the Color settings OSD. Run the built-in diagnostics.



Image retention from a static image left on the monitor for a long period of time	Faint shadow from the static image displayed appears on the screen	<ul style="list-style-type: none"> • Set the screen to turn off after a few minutes of screen idle time. These can be adjusted in Windows Power Options or Mac Energy Saver setting. • Alternatively, use a dynamically changing screensaver.
---	--	---

Product specific problems

Specific Symptoms	What you experience	Possible Solutions
Screen image is too small	Image is centered on screen, but does not fill entire viewing area	<ul style="list-style-type: none"> • Check the Aspect Ratio setting in the Display settings OSD. • Reset the monitor to Factory Settings (Factory Reset).
Cannot adjust the monitor with the joystick	OSD does not appear on the screen	<ul style="list-style-type: none"> • Turn Off the monitor, unplug the power cord, plug it back, and then turn On the monitor. • Check whether the OSD menu is locked. If yes, move and hold the joystick up/down/left/right for 4 seconds to unlock (for more information, see Menu and Power button lock).
No Input Signal when user controls are pressed	No picture, the LED light is white	<ul style="list-style-type: none"> • Check the signal source. Ensure the computer is not in Standby Mode by moving the mouse or pressing any key on the keyboard. • Check if the video cable is plugged in properly. Disconnect and reconnect the video cable if necessary. • Reset the computer or video player.



The picture does not fill the entire screen	The picture cannot fill the height or width of the screen	<ul style="list-style-type: none"> • Due to different video formats (aspect ratio) of DVDs, the monitor may display in full screen. • Run the built-in diagnostics.
No video at HDMI/ DisplayPort/USB-C port	When connected to some dongle/ docking device at the port, there is no video when unplugging/plugging the cable from the notebook	<ul style="list-style-type: none"> • Unplug the HDMI/DisplayPort/ USB-C cable from dongle/ docking device, then plug the docking HDMI/DisplayPort/ USB-C cable to the notebook.
No network connection	Network dropped or intermittent	<ul style="list-style-type: none"> • Do not turn Off the monitor during network connection.
The LAN port is not functioning	OS setting or cable connection issue	<ul style="list-style-type: none"> • Ensure that the latest BIOS and drivers for your computer are installed on your computer. • Ensure that the RealTek Gigabit Ethernet Controller is installed in the Windows Device Manager. • If your BIOS Setup has a LAN/ GBE Enabled/Disabled option, make sure it is set to Enabled. • Ensure that the Ethernet cable is connected securely on the monitor and the hub/router/ firewall. • Check the status LED of the Ethernet cable to confirm connectivity. Re-connect both ends of the Ethernet cable if the LED is not lit. • First power off the computer and unplug the USB-C cable and the power cord from the monitor. Then, power on the computer and plug the power cord and the USB-C cable into the monitor.



Universal Serial Bus (USB) specific problems

Common symptoms	What you experience	Possible Solutions
USB interface is not working	USB peripherals are not working	<ul style="list-style-type: none">• Check that your monitor is turned On.• Reconnect the upstream cable to your computer.• Reconnect the USB peripherals (downstream connector).• Turn off the monitor and turn it on again.• Reboot the computer.• Certain USB devices such as portable hard drive require higher power source; connect the drive to the computer directly.
USB-C port does not supply power	USB peripherals can not be charged	<ul style="list-style-type: none">• Check that the connected device is compliant with the USB-C specification. The USB-C port supports USB 3.2 Gen1 and an output of 90 W.• Check that you use the USB-C cable shipped with your monitor.
SuperSpeed USB 5 Gbps (USB 3.2 Gen1) interface is slow	SuperSpeed USB 5 Gbps (USB 3.2 Gen1) peripherals working slowly or not working at all	<ul style="list-style-type: none">• Check that your computer is SuperSpeed USB 5 Gbps (USB 3.2 Gen1)-compatible.• Some computers have USB 3.2, USB 2.0, and USB 1.1 ports. Ensure that the correct USB port is used.• Reconnect the upstream cable to your computer.• Reconnect the USB peripherals (downstream connector).• Reboot the computer.



Wireless USB peripherals stop working when a USB 3.2 device is plugged in

Wireless USB peripherals responding slowly or only working as the distance between itself and its receiver decreases

- Increase the distance between the USB 3.2 peripherals and the wireless USB receiver.
 - Position your wireless USB receiver as close as possible to the wireless USB peripherals.
 - Use a USB-extender cable to position the wireless USB receiver as far away as possible from the USB 3.2 port.
-



Regulatory information

FCC notices (U.S. Only) and other regulatory information

For FCC notices and other regulatory information, see the regulatory compliance website located at www.dell.com/regulatory_compliance.

EU product database for energy label and product information sheet

P2423DE: <https://eprel.ec.europa.eu/qr/1057583>

P2723DE: <https://eprel.ec.europa.eu/qr/1057602>

Contacting Dell

To contact Dell for sales, technical support, or customer service issues, see www.dell.com/contactdell.



NOTE: Availability varies by country and product, and some services may not be available in your country.



NOTE: If you do not have an active Internet connection, you can find contact information on your purchase invoice, packing slip, bill, or Dell product catalog.

