

ADAPT 460 | ADAPT 460T

In-ear neckband Bluetooth® headset with ANC

Contents

The ADAPT 460 ADAPT 460T headset.....	2
Package contents.....	3
Product overview.....	4
Overview of the headset.....	4
Overview of the headset LED indications.....	5
Overview of the headset buttons.....	5
Overview of the dongle.....	7
Overview of the dongle button.....	7
Overview of the icons.....	7
Getting started.....	8
Pairing the headset with Bluetooth® devices.....	8
Installing the EPOS Connect software.....	10
Changing Audio settings for the headset – Microsoft® Windows.....	10
Using the headset.....	11
Selecting / replacing the ear tips.....	11
Inserting / removing the earbuds.....	11
Turning the headset on and connecting it.....	12
Turning the headset off.....	12
Adjusting the volume.....	13
Adjusting the headset's microphone volume for softphones.....	13
Muting the microphone.....	13
Using Active Noise Cancellation (ANC).....	14
Turning TalkThrough on / off.....	14
Making calls using the headset.....	15
Making a call.....	15
Accepting / rejecting / ending a call.....	15
Redialing.....	16
Using the voice assistant / voice dial.....	16
Managing multiple calls.....	17
Using headset and dongle with Microsoft® Teams / Cortana – ADAPT 460T only.....	18
Invoking Microsoft® Teams and check notifications.....	18
Activating and using Microsoft® Cortana.....	18
Listening to audio using the headset.....	19
Additional functions.....	20
Charging the headset battery.....	20
Verifying remaining battery power.....	21
Storing and transporting the headset and the dongle.....	21
If you leave the Bluetooth range.....	22
Reconnecting / disconnecting Bluetooth.....	22
Enabling / disabling voice prompts.....	23
Maintaining the products and updating the firmware.....	24
Cleaning the products.....	24
Exchanging the ear tips.....	24
Replacing / removing the headset's rechargeable battery.....	24
Updating the firmware of the products.....	25
If a problem occurs.....	26
Clearing the pairing list of the headset (Reset).....	27
Clearing the pairing list of the dongle (Reset).....	27
Specifications.....	28

The ADAPT 460 | ADAPT 460T headset

Take great sound anywhere

Keep moving, stay focused and be productive with an in-ear, neckband headset that delivers rich, natural sound and ANC whether at work or commuting. Tune into clear business calls anywhere, any time, with a subtle vibrating neckband that means you'll never miss a call.

Key benefits & features

Boost your productivity with ANC

Your in-ear neckband headset to maintain concentration in noisy environments with an advanced four microphone ANC system

Clear business calls with UC optimized solution

Impressive sound with a Microsoft Teams certified/UC optimized solution and subtle vibrating neckband signaling incoming calls

Enjoy superior comfort and fit

Lightweight construction and comfortable earbuds with a choice of four pair of ear tips, plus versatile single or double-sided use

Stay connected to your favorite devices

Multi-point connectivity to two actively paired Bluetooth® devices and eight devices in the pairing list

Talk all day

With up to 14 hours of talk time

Additional benefits & features

Bluetooth®

ADAPT 460 in-ear wireless headset is compatible with all Bluetooth 1.1, 1.2, 2.0, 2.1, 3.0, 4.0, 4.1, 4.2, 5.0 and devices with the following profiles:

- Hands Free Profile (HFP),
- Advanced Audio Distribution Profile (A2DP), and
- Audio/Video Remote Control Profile (AVRCP).

aptX™

With aptX™ audio coding, you can be assured of crisp, pure and full stereo sound. It allows you to not only hear, but experience and feel the audio as it was intended. Utilizing aptX™, Bluetooth technology can now offer wireless audio quality that is indistinguishable from the highest quality wired connection.



For safety instructions, consult the Safety Guide.



A list of accessories can be found on the product page at www.eposaudio.com.

Trademarks



The Bluetooth® word mark and logos are registered trademarks owned by Bluetooth SIG, Inc. and any use of such marks by Sennheiser Communications A/S is under license.

USB Type-C® and USB-C® are trademarks of USB Implementers Forum.

Qualcomm aptX is a product of Qualcomm Technologies International, Ltd. Qualcomm is a trademark of Qualcomm Incorporated, registered in the United States and other countries, used with permission. aptX is a trademark of Qualcomm Technologies International, Ltd., registered in the United States and other countries, used with permission.

All other trademarks are the property of their respective owners.

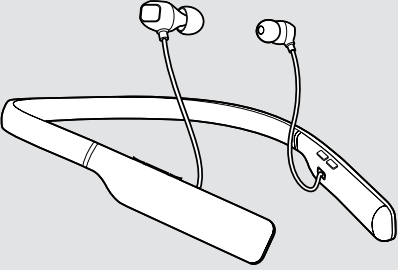
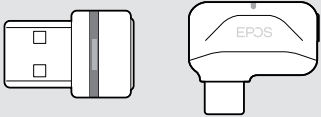
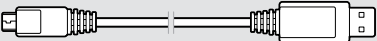
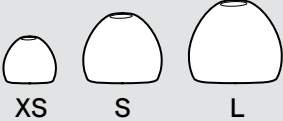
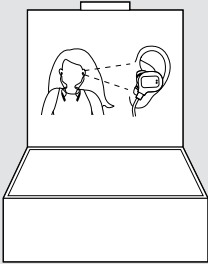
Package contents







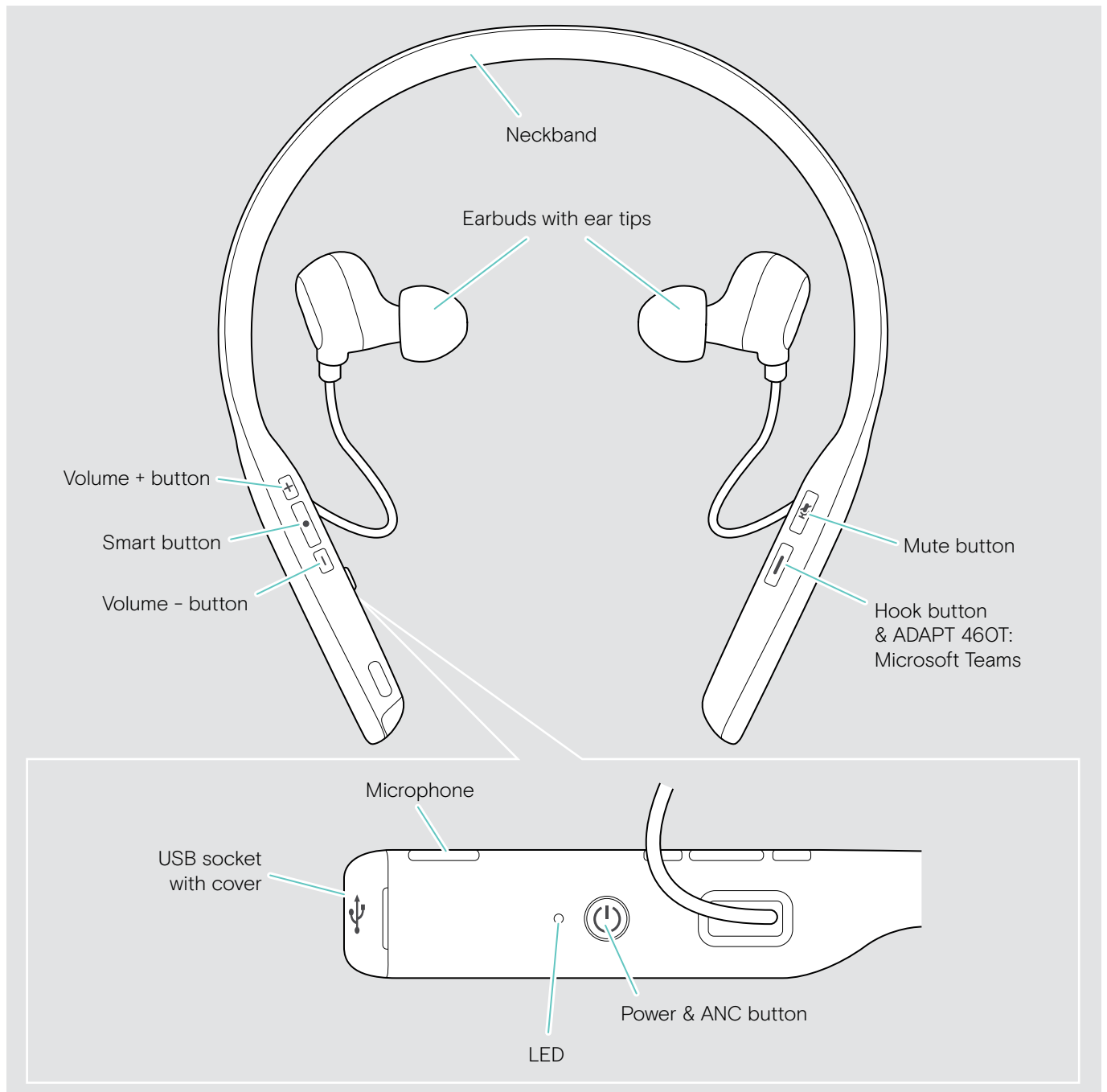



	<p>ADAPT 460 or ADAPT 460T Neckband headset</p>
	<p>Case</p>
	<p>BTB 800 USB or BTB 800 USB-C Bluetooth dongle</p>
	<p>USB cable with USB-A and micro-USB plug</p>
	<p>Ear tips</p>
	<p>Quick Guide on the box</p>
	<p>Safety Guide Compliance sheet</p>

Product overview

Overview of the headset











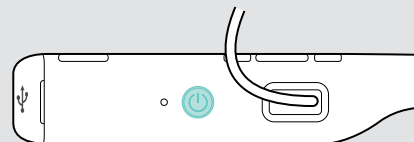



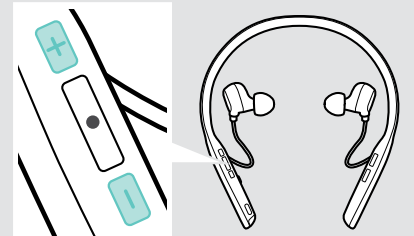

Overview of the headset LED indications

		<ul style="list-style-type: none"> Headset connected Headset turned off Headset fully charged
		<ul style="list-style-type: none"> Headset turns on Pairing list cleared
		<ul style="list-style-type: none"> Bluetooth device found Bluetooth reconnects
		Headset in pairing mode: searching for mobile device/dongle
		Headset turns off
		Headset disconnected from mobile device/dongle
		Incoming call
		Battery power between 60 and 99%
		Battery power between 20 and 59%
		<ul style="list-style-type: none"> No Bluetooth device found Rechargeable battery is weak



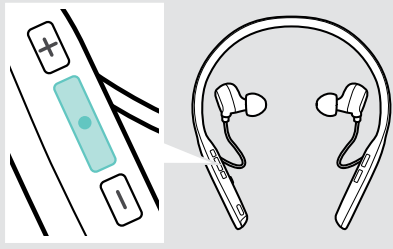

*Once the headset is successfully connected, the LED turns off.





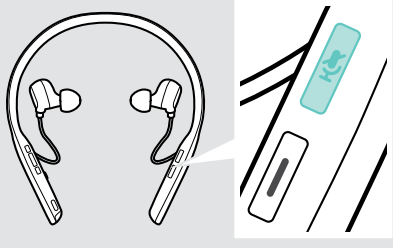



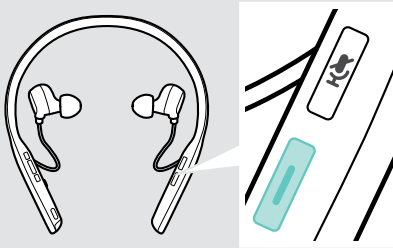

Overview of the headset buttons

Power & ANC button	Press	Function	Page
		Turns the headset on / off	12
		Turns ANC on / off	14
		Pairs the headset with a Bluetooth device Clears pairing list (Pairing mode): ▷ Press Power & Hook button	8 27
		Cancels pairing (Pairing mode)	8
Volume +/- button	Press	Function	Page
		 Increases the volume (press or press and hold)	13
		 Decreases the volume (press or press and hold)	
		 Turns neckband vibration off (incoming call)	15



Smart button	Press	Function	Page
		Starts / pauses audio playback	19
		Skips to the next track + hold: Fast-forwards the track*	
		Skips to the previous track + hold: Rewinds the track*	
		Activates voice assistant	16

* These functions are not supported by all connected Bluetooth devices.

Mute button	Press	Function	Page
		Mutes / unmutes the microphone	13
		Requests remaining battery power	21
		Enables/disables voice prompts	23

Hook button	Press	Function	Page
		Initiates a call	15
		Accepts / ends a call	15
		2 calls: Answers incoming & ends active call	17
		2 calls: Ends active & unholds paused call	17
		Puts an active call on hold (pause) / unholds call	15
		Redials the last number	16
		2 calls: Answers incoming & puts active on hold	16
		2 calls: Toggles between two calls	17
		Rejects a call	15
		Clears pairing list (Pairing mode): ▷ Press Power & Hook button	27

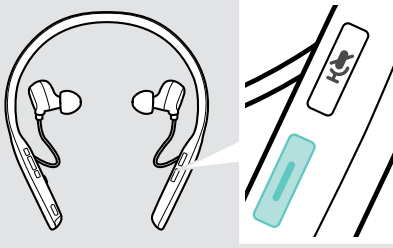
ADAPT 460T additional functions

Microsoft Teams button	Press	Function	Page
		Invokes Microsoft Teams	18
		Activates Cortana	18

Overview of the dongle

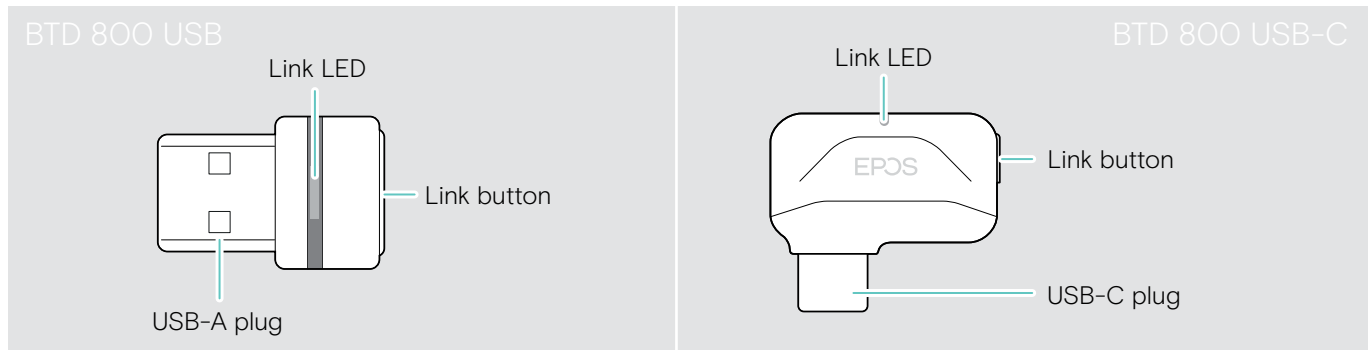

Overview of the dongle LED indications

		Dongle in pairing mode: searching for headset
	3x	Pairing successful
	3x	Pairing failed
		Dongle tries to connect to a Bluetooth device
		Dongle and Bluetooth device connected
		Incoming call
		<ul style="list-style-type: none"> Outgoing/active call Audio playback
		Connected to Teams
		<ul style="list-style-type: none"> Teams notification Connecting to Teams or Invoking Cortana
		Microphone of the connected Bluetooth device is muted

Overview of the dongle button

Link button	Press	Function	Page
		Pairs the dongle with the headset	8
		Reconnects the headset	22
		Disconnects the headset	22

Overview of the icons

	Tap the button		Notes: Good to know
	Press the button twice		LED indications
	Press and hold the button		Voice prompt is announced

Getting started

Pairing the headset with Bluetooth® devices

CAUTION
Danger of malfunction!

The transmitted radio waves of mobile devices can impair the operation of sensitive and unprotected devices.

- ▶ Only use Bluetooth where it is permitted.

The headset complies with the Bluetooth 5.0 standard. Bluetooth devices need to support the “Hands-Free Profile” (HFP), the “Headset Profile” (HSP), “Audio Video Remote Control Profile” (AVRCP) or the “Advanced Audio Distribution Profile” (A2DP).

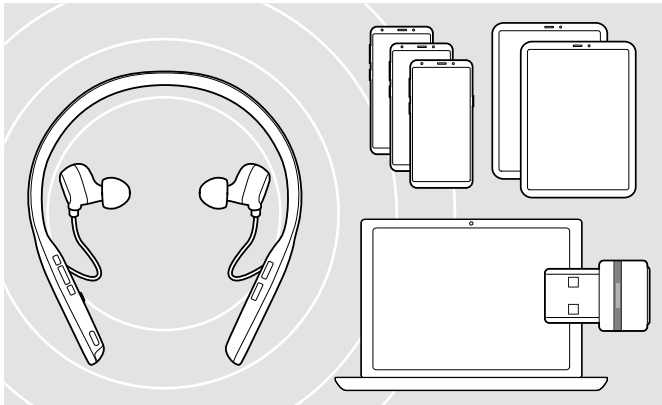

To transmit data via Bluetooth, you first have to pair your headset to a wireless device. The delivered dongle is already paired with the headset.

The headset can save up to eight paired devices. If you pair the headset with a ninth device, the device with the oldest activity will be overwritten. If you want to re-establish a connection with this device, you have to pair it again.

The headset can be connected to two of the paired devices at the same time. You can only connect another device by disconnecting one of the already connected devices.

Connecting the headset via the dongle

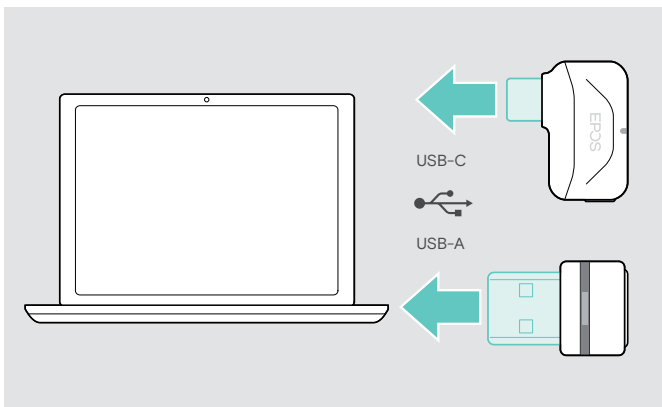

To connect the headset wirelessly with a computer, use the BTD 800 USB or BTD 800 USB-C dongle.

The dongle and the headset in the bundles are already paired.

- ▶ Turn the headset on (see page 12).
- ▶ Plug the dongle into the USB port of your computer.

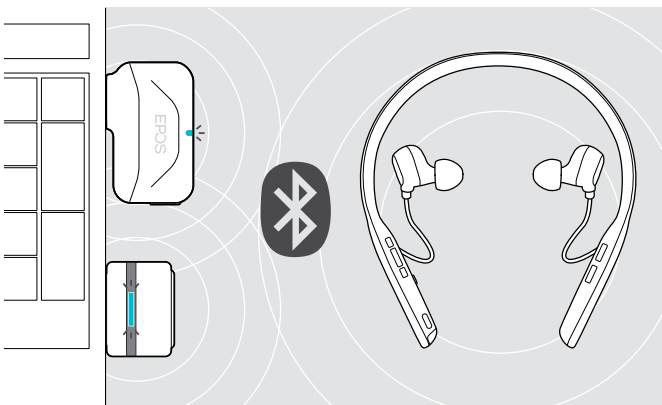

The dongle LED flashes blue while searching and switches to dimmed blue when connected successfully to the headset.



If Microsoft Teams is invoked: The dongle automatically attempts to connect to Teams and lights up purple instead of blue.



The dongle shows Teams notifications (see page 18).

i To manually pair the headset and the dongle, activate the pairing mode for both:

- ▶ Press and hold the headset’s Power button and the dongle’s button until the LEDs alternately flashes blue and red. Once the dongle and the headset are connected, the dongle lights up dimmed blue.

Pairing the headset via Bluetooth with a mobile device

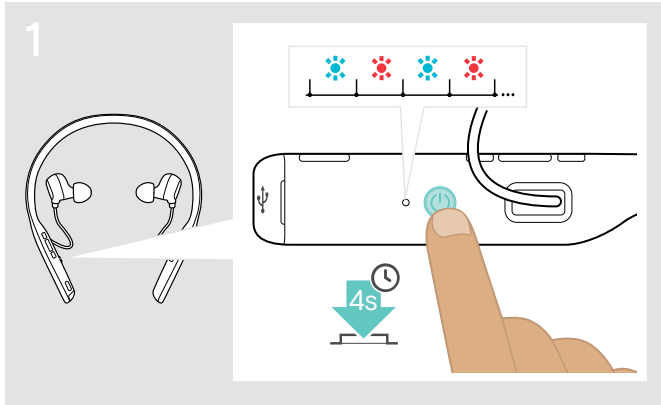

- ▶ Press and hold the Power button until the LED flashes blue and red. The headset is in pairing mode.



- ▶ Enable Bluetooth on your mobile device and start the search for Bluetooth devices – see instruction manual of your mobile device.



- ▶ Select “EPOS ADAPT 460” or “EPOS ADAPT 460T” to establish a Bluetooth connection to the headset.

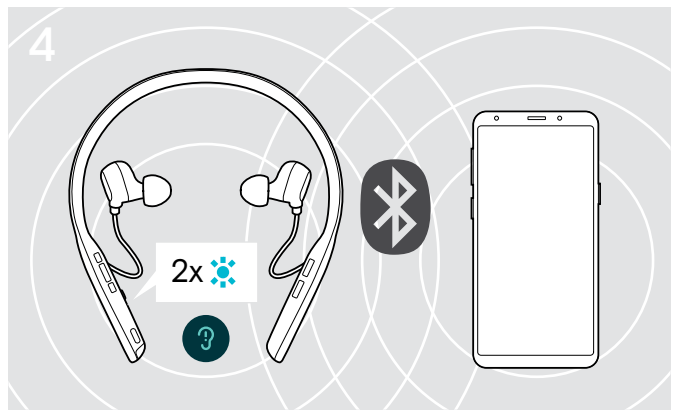

- ▶ The LED flashes 2 times blue as soon as the headset finds a device to connect to. The LED turns off.

- i** To cancel pairing:
 - ▶ Press the Power button.

Installing the EPOS Connect software



The free **EPOS Connect** software allows you to configure and update your headset and offers additional settings.

- ▶ Download the software from www.eposaudio.com/connect.
- ▶ Install the software.
You need administrator rights on your computer – if necessary, contact your IT department.

To make calls via the computer:

- ▶ Install a softphone (VoIP Software) or ask your admin for support.

Changing Audio settings for the headset – Microsoft® Windows

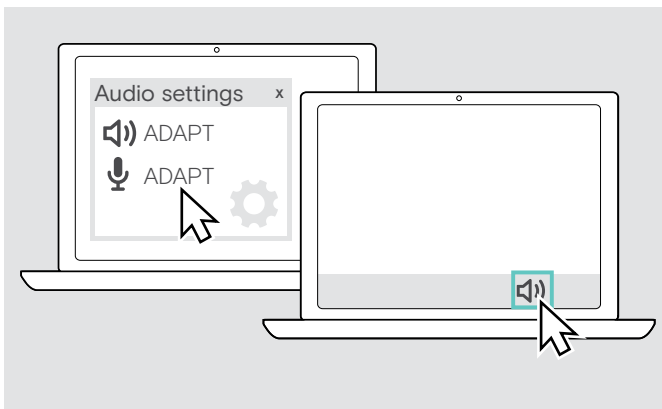

Windows usually changes the Audio settings automatically if you connect a new headset.

If the headset is connected but you hear no sound:

- ▶ Right-click the Audio icon.
- ▶ Select under output ADAPT 460 as speaker.
- ▶ Select under input ADAPT 460 as microphone.

Using the headset



CAUTION

Risk of hearing or ear canal damage!

Listening at high volume levels for long periods can lead to permanent hearing defects.

- ▷ Set the volume to a low level before putting on the headset. Do not continuously expose yourself to high volumes.
- ▷ Never insert the earbuds without ear tips.

Selecting / replacing the ear tips

The sound quality and wearing comfort depends on the correct fit of the earbuds.

- ▷ Select ear tips of the correct size (XS, S, M or L) so that the earbuds sit comfortably and securely in your ears. Check for your left and right ear separately as most peoples ears are different in size.

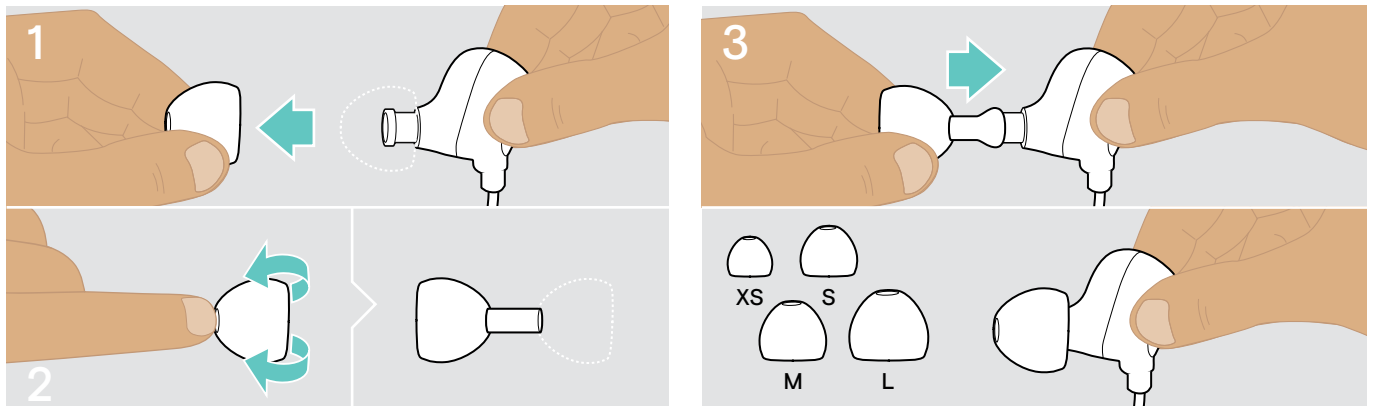

- ▷ Remove the ear tip carefully.
- ▷ Flip the ear tip.

- ▷ Push the suiting ear tip on the in-ear sound tunnel and flip it.

Inserting / removing the earbuds

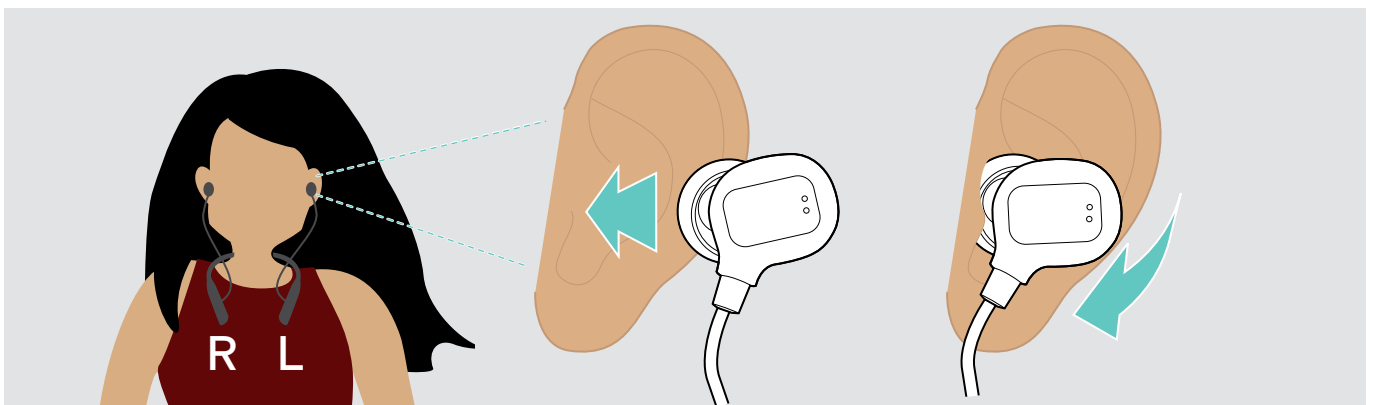

- ▷ Insert the earbuds into the ears.
- ▷ Rotate to fit comfortably.

After use:

- ▷ Always extract the earbuds very slowly and carefully from your ears.

Turning the headset on and connecting it

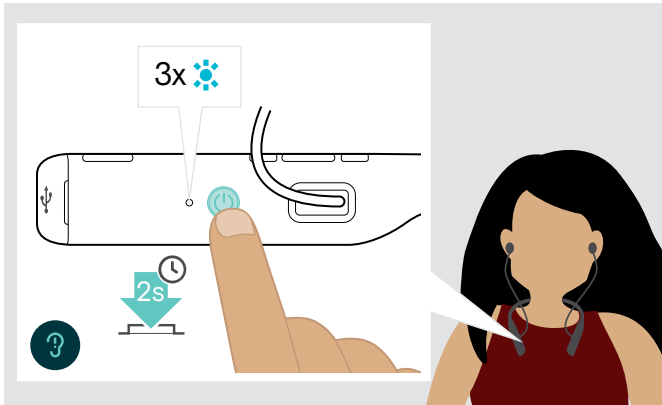

- ▶ Press the Power button for 2 seconds. The headset turns on. The LED flashes blue shortly. The headset automatically tries to connect to available paired Bluetooth devices.

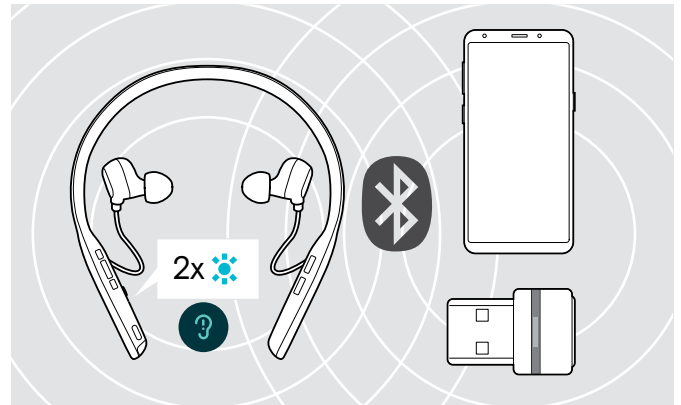

The LED flashes 2 times blue as soon as the headset finds a device to connect to. The LED turns off.

If the LED flashes red, no paired device has been found.

Turning the headset off

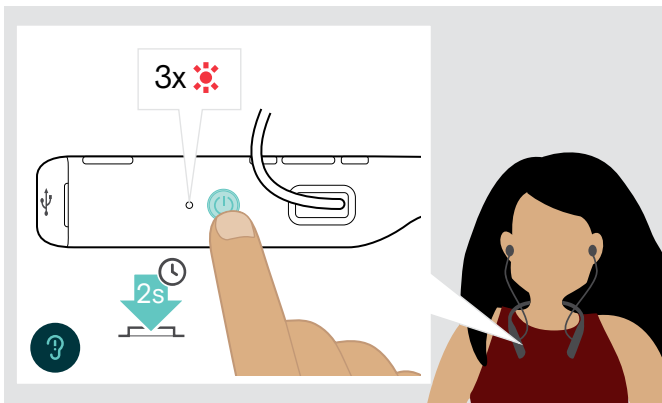

- ▶ Press the Power button for 2 seconds. The headset turns off and vibrates twice. The LED flashes red 3 times and turns off. All volume settings are saved automatically when the headset is turned off.
- ▶ Charge the headset (see page 20).
- OR
- ▶ Store the headset (see page 21).

Adjusting the volume

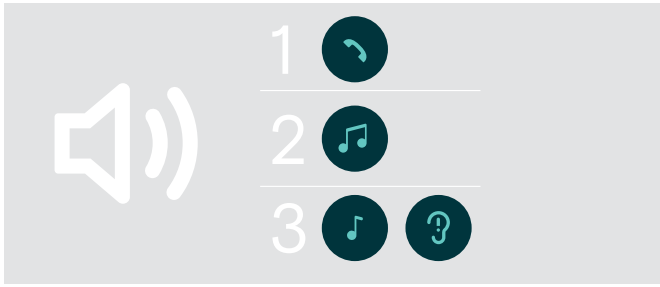

You can adjust three independent volume settings for the headset:

1. Call volume: during an active call
2. Audio volume: during audio streaming
3. Volume for ring tone, tones and voice prompts: in idle mode – no active call or audio streaming

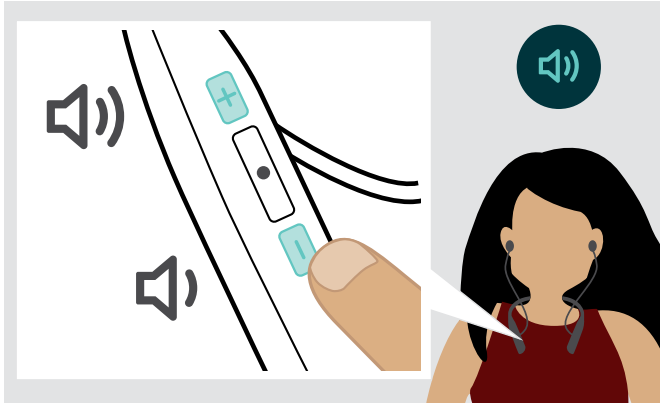

- ▶ Press the Volume button to increase or decrease the volume.
You hear a beep or double beep for maximum or minimum volume.

Alternatively you can adjust the volume on your connected device.

Adjusting the headset's microphone volume for softphones

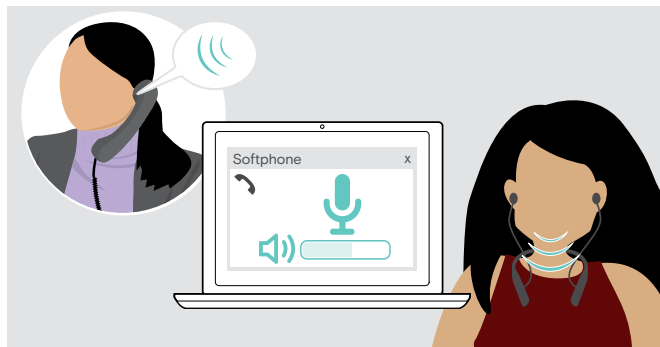

- ▶ Initiate a call on your connected device to someone who will help you find the correct volume setting for your microphone.
- ▶ Change the microphone volume in your softphone application and/or in your PC audio application.

Muting the microphone

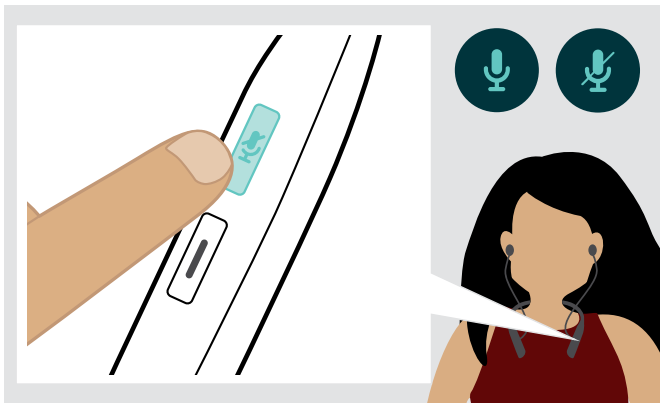

- ▶ Press the Mute button to

 mute or

 unmute the microphone.

Using Active Noise Cancellation (ANC)

This headset provides attenuation of ambient noise using Active Noise Cancellation (ANC) technology. Special microphones optimize speech and reduce background noise.

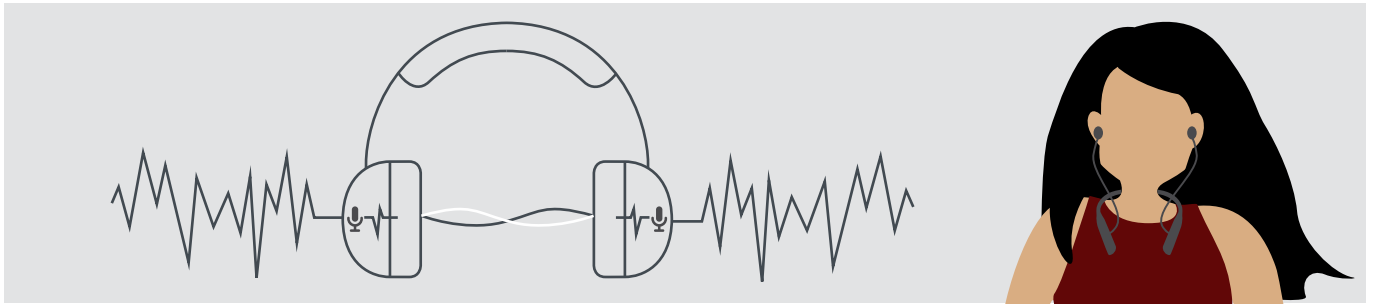

If you are in a noisy environment but would like to have your own quiet space, you can use the headset itself, disconnected from any device, and simply benefit from ANC. You can activate ANC if the battery is sufficiently charged and if the headset is turned on.

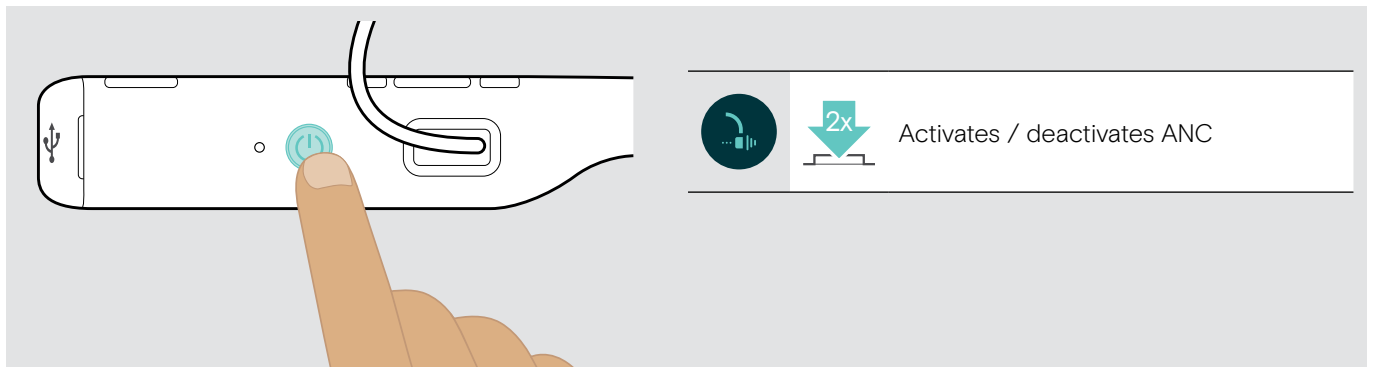

Turning TalkThrough on / off

TalkThrough allows you to communicate with your colleagues without having to remove the headset, even when ANC is turned on. Audio playback will be paused or muted.

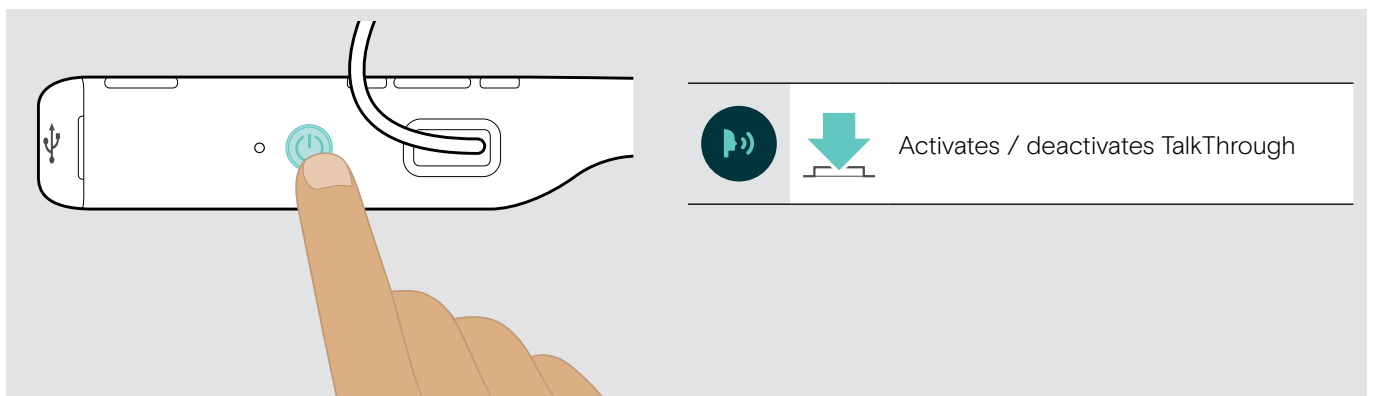

Making calls using the headset

The following functions depend on the connected device.

Making a call

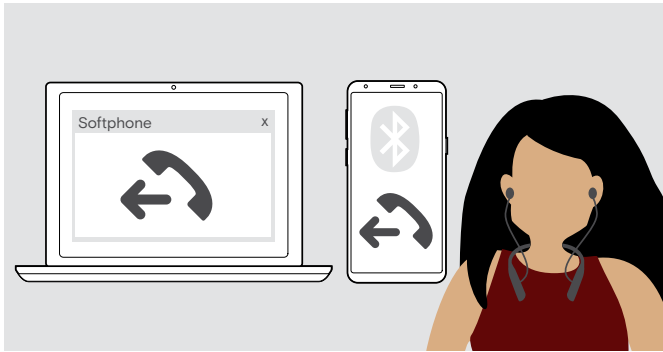

- ▷ Initiate the call on your connected device.
- OR
- ▷ Press the Hook button to initiate a call via your softphone.

If your call is not automatically transferred to the headset:

- ▷ Search this function in the instruction manual of your connected device.

Accepting / rejecting / ending a call

When you receive a call you hear a ring tone, the LED flashes blue and the neckband vibrates. You can stop the vibration by pressing the volume - button.

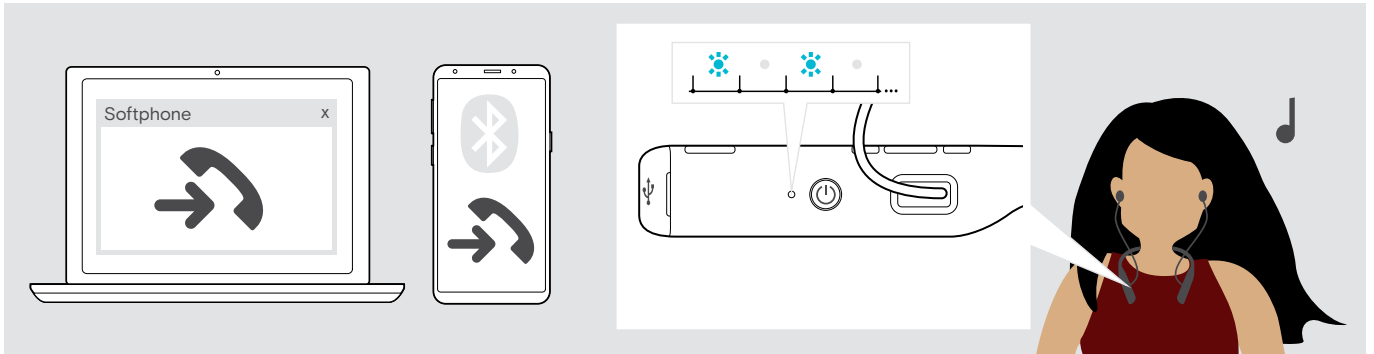

Accept / hold a call





		Accepts a call
		Puts an active call on hold (pause)

Reject / end a call

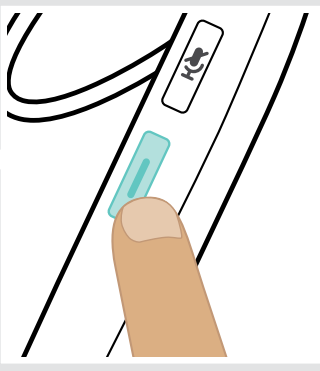
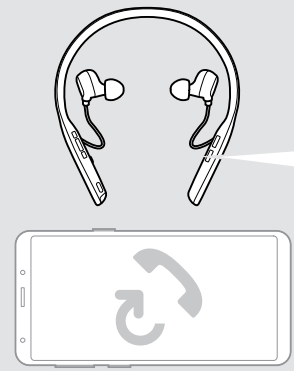
		Rejects a call
		Ends a call

Redialing





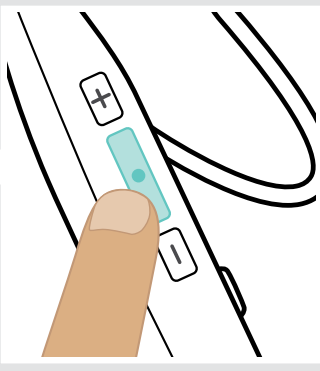
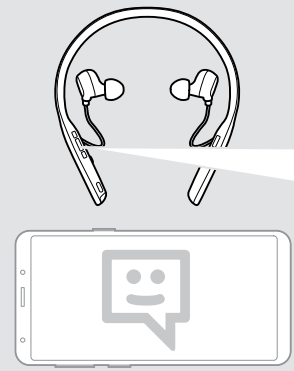

	 Redials the last number
	 Cancels redialing

Using the voice assistant / voice dial

The last connected Bluetooth device will be used for voice assistant or voice dial.
For Microsoft Cortana: see page 18.



	 Activates voice assistant / voice dial
	 Cancels voice assistant / voice dial

Managing multiple calls



You can use the Headset with up to two connected Bluetooth devices.

Two calls can be managed simultaneously.

If you receive a call during an active call, a knock on tone will be played and the neckband vibrates.

Accept / reject second call

Active call	2nd incoming call	
		Accepts the incoming call and puts the active call on hold
		Accepts the incoming call and ends the active call
		Rejects the incoming call and continues the active call

Toggle between calls / end active call

Active call	2nd held call	
		Toggles between the active and held call
		Ends the active call and makes the held call active

Using headset and dongle with Microsoft® Teams / Cortana – ADAPT 460T only

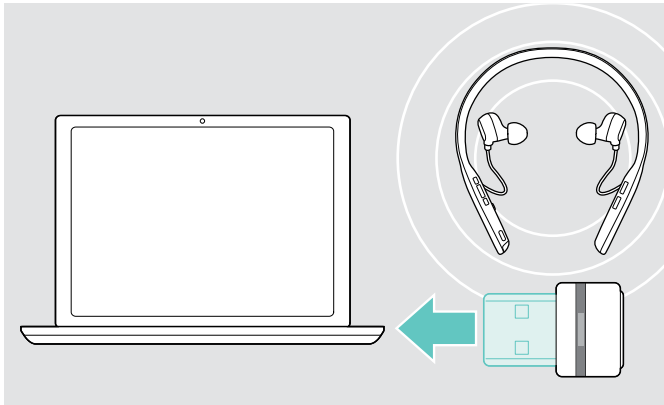

To use Microsoft Teams and Cortana with the headset:

- ▶ Plug the dongle into the USB port of your computer – see page 8.
If Microsoft Teams is already running, the blue LED changes to purple automatically.

Invoking Microsoft® Teams and check notifications

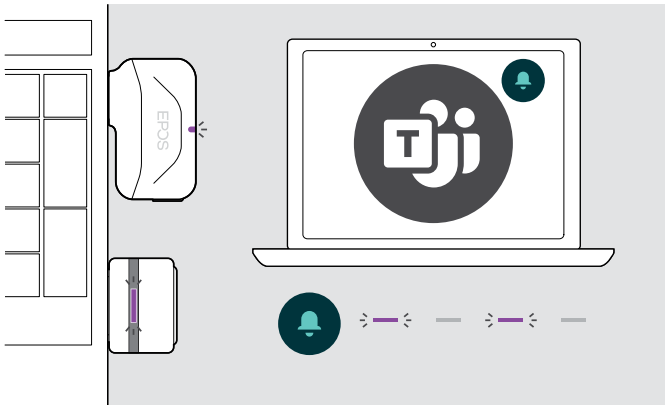

- ▶ Start Microsoft Teams on your computer.
The dongle connects to Microsoft Teams and the LED blue LED changes to purple.



The LED pulses purple to indicate:

- Meeting Join Notification
- Voice Mail Notification
- Missed Call Notification

To check these Notifications on your screen:

- ▶ Press the Microsoft Teams button.

Activating and using Microsoft® Cortana

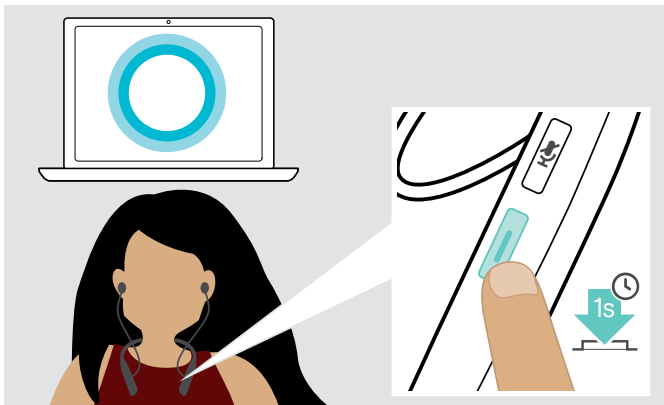

You can activate and use Cortana – Microsoft's Personal Digital Assistant using Voice command technology – with the headset.

- ▶ Press the Microsoft Teams button.
The Dongle LED flashes purple while activating Cortana.



The LED lights up purple.









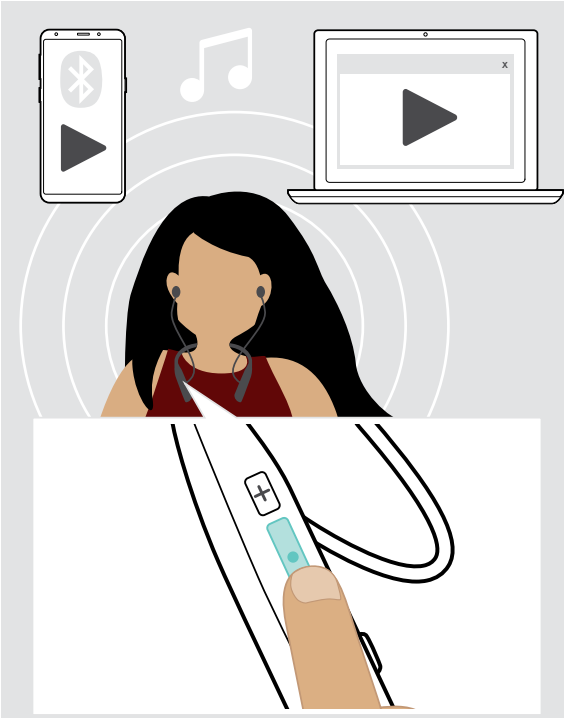





Listening to audio using the headset

You can listen to audio via a connected device. The following functions depend on the connected device.

- ▶ Play the media on your connected device.
The LED on the dongle lights up blue.



		Plays audio
		Pauses audio
		Plays the next track in the playlist
		+ hold: Fast-forwards the track
		Plays the previous track in the playlist
		+ hold: Rewinds the track



If you receive and accept a call, audio playback is paused and restarts after the call – if supported by the connected device.

Additional functions

Charging the headset battery

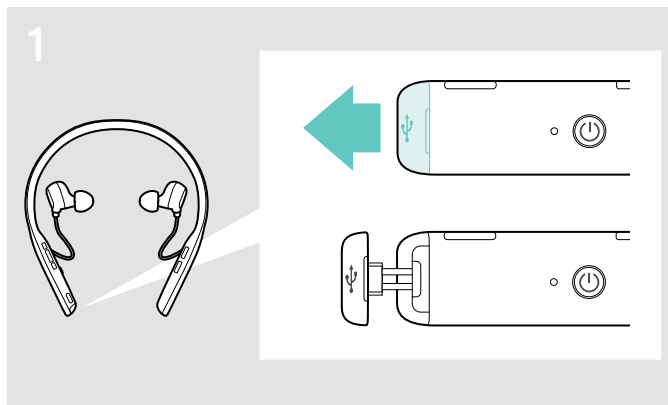

▷ Open the cover carefully.

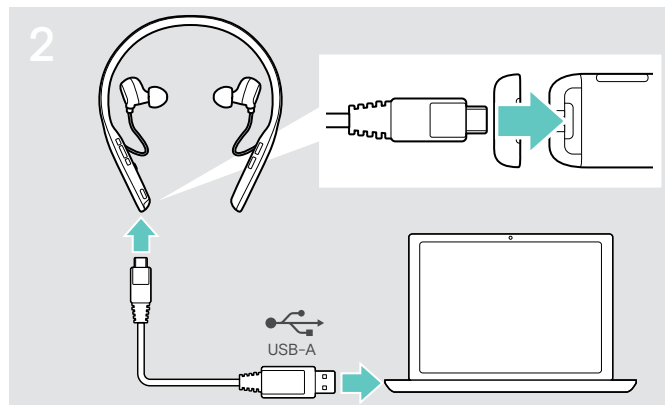

▷ Connect the supplied USB cable to the USB socket of the headset and a USB socket of your computer.

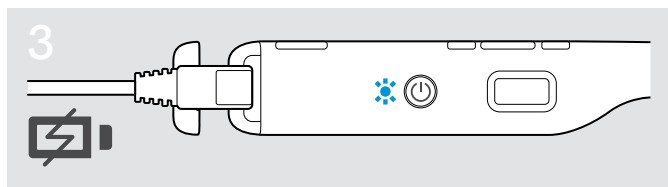

The battery is being charged. The LED lights up depending on the battery status of the headset and turns off when the battery is fully charged.

LED	Battery status
	100% – Battery fully charged
	more than 60%
	more than 20%
	less than 20%

i When the battery is flat, the headset turns off automatically.

Ending charging

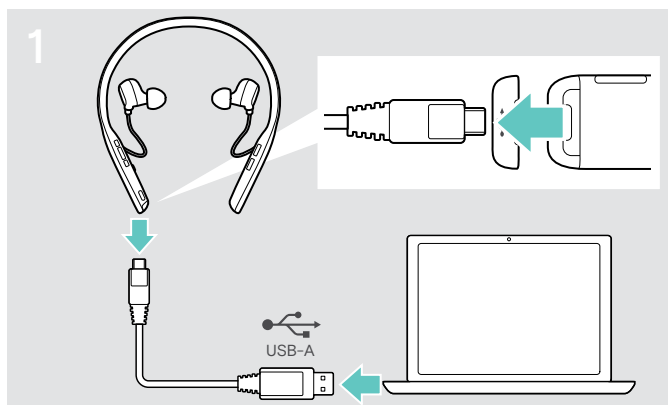

▷ Disconnect the USB cable from the headset.

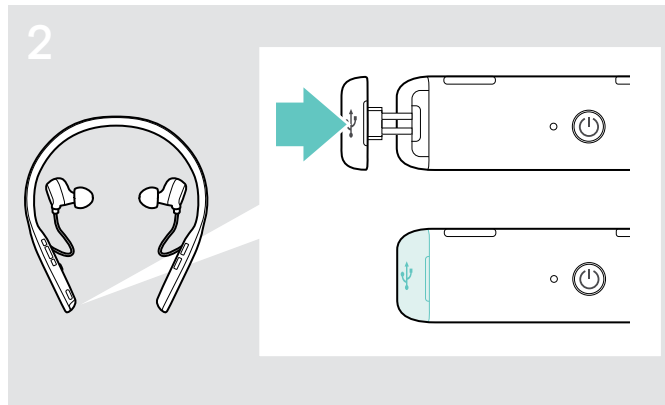

▷ Close the cover.

Verifying remaining battery power

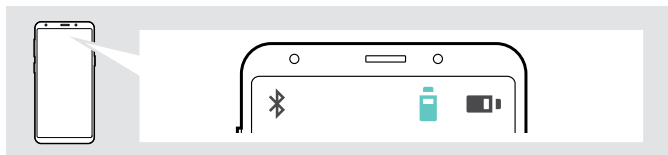

Some mobile devices indicate the battery status of the headset.

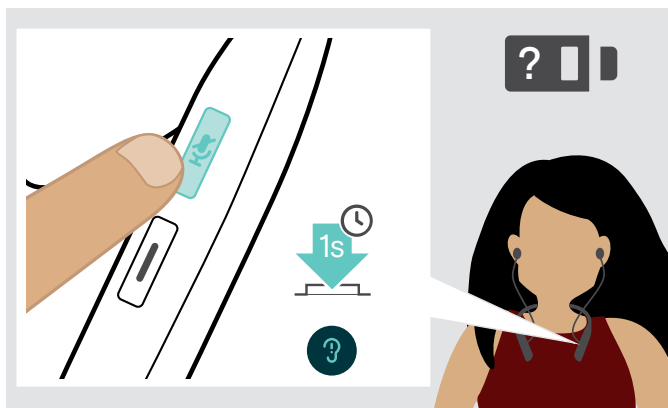

You can retrieve information on the remaining battery power at any time – except while you are in a call:

- ▶ Press the Mute button.
The LED flashes shortly and a voice prompt is announced.



When the battery power drops below 20%, the LED flashes red and “Recharge headset” is announced several times.

LED	Remaining battery power
	more than 60%
	more than 20%
	less than 20% – automatic voice prompt

Storing and transporting the headset and the dongle

To avoid nicks or scratches on the headset:

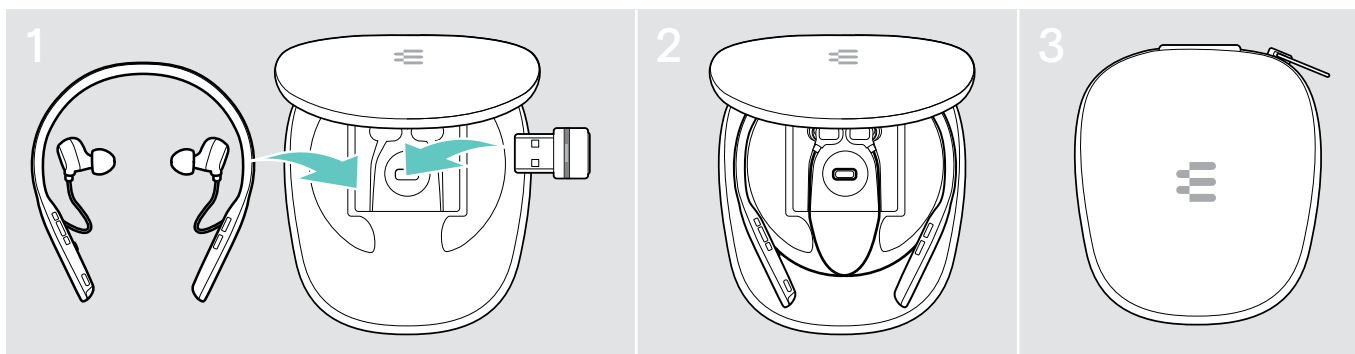

- ▶ Store the headset and the dongle in the case when not in use or when carrying them around.
- ▶ Keep it in a clean and dry environment.

If you do not use the headset for extended periods of time:

- ▶ Charge the built-in rechargeable battery every 3 months for about 1 hour.

If you leave the Bluetooth range

The range between headset and Bluetooth device is device dependent. The transmission range largely depends on environmental conditions such as wall thickness, wall composition etc. With a free line of sight, the transmission range of most Bluetooth devices is up to 25 meters.

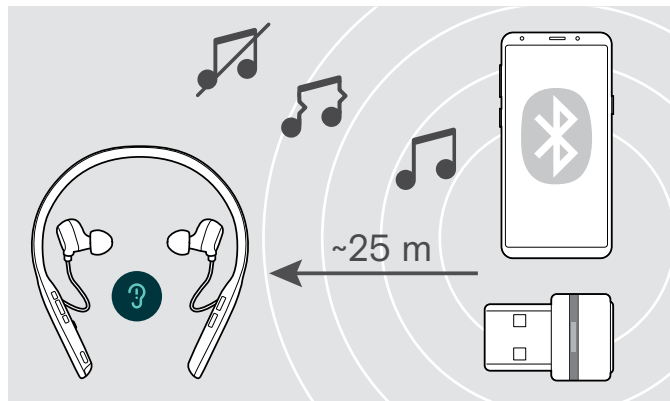

If the audio quality deteriorates e. g. during a call or the link breaks down completely:

- ▶ Re-enter the radio range of the Bluetooth device.

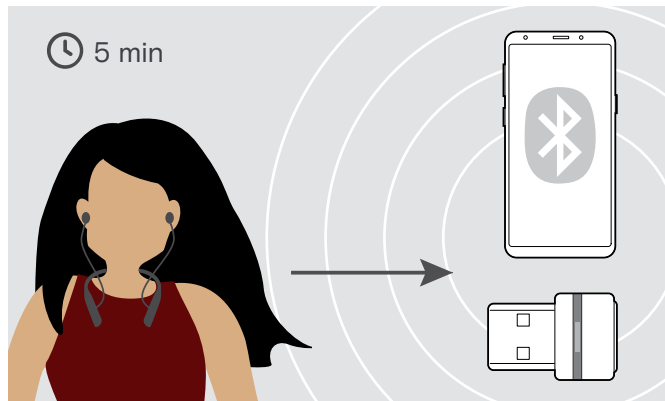

If you re-enter the Bluetooth transmission range **within 5 minutes**, the connection is re-established.

After **more than 5 minutes** the connection breaks down completely and you have to manually re-establish the connection:

- ▶ Tap the Hook button.

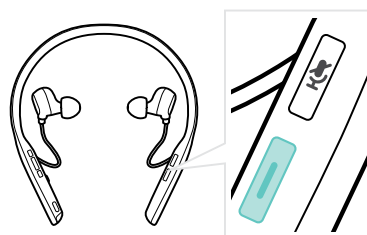

Reconnecting / disconnecting Bluetooth

Reconnecting Bluetooth

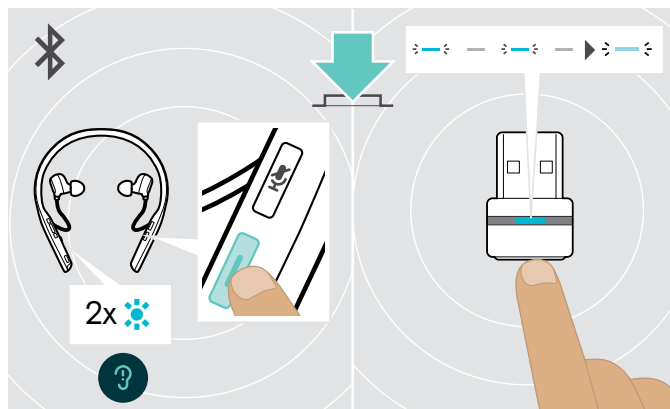

- ▶ Tap the headset's Hook button or the dongle's button. The headset flashes 2 times blue as soon as the headset finds a device to connect to. The dongle flashes blue and lights up dimmed blue.

Disconnecting Bluetooth

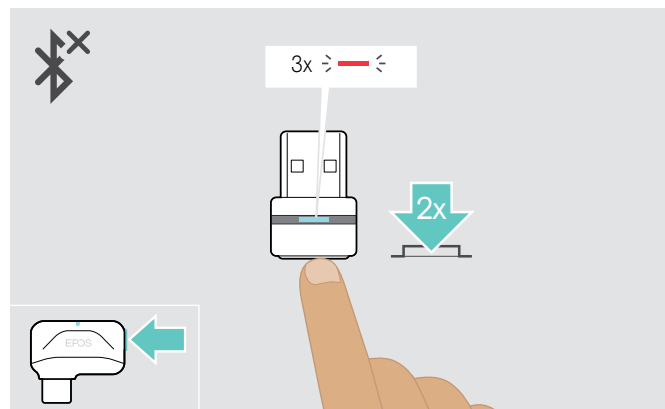

- ▶ Double tap the dongle's button. Bluetooth will be disconnected. The LED flashes 3 times red.

Enabling / disabling voice prompts

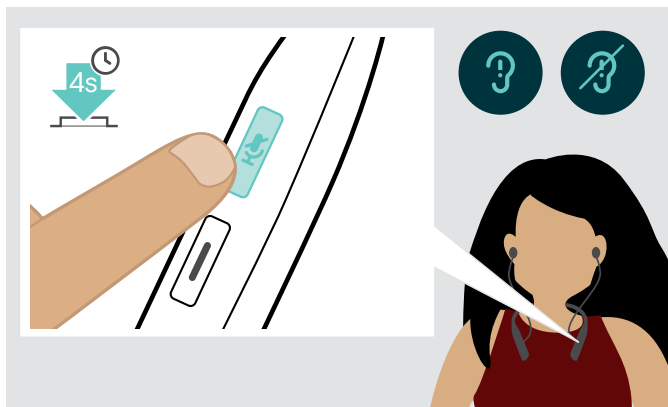

In idle mode (no active call or audio playback):

- ▶ Press and hold the Mute button until the headset announces a voice prompt for on or off.



If the voice prompts are deactivated you hear tones instead.

Maintaining the products and updating the firmware

Cleaning the products

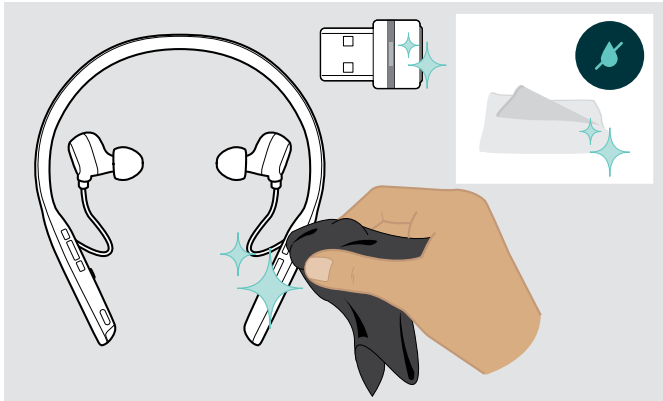

CAUTION

Liquids can damage the electronics of the product!

Liquids entering the housing of the device can cause a short circuit and damage the electronics.

- ▷ Keep all liquids far away from the product.
- ▷ Do not use any cleansing agents or solvents.

- ▷ Only use a dry cloth to clean the product.

Exchanging the ear tips

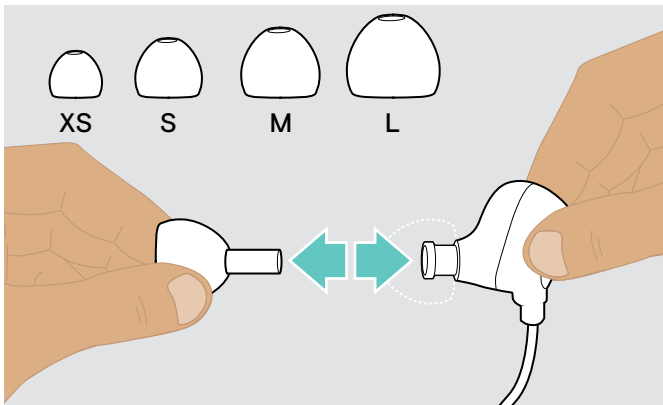

For hygienic reasons, you should replace the ear tips from time to time. Spare ear pads are available from your EPOS partner.

- ▷ Follow the steps on page 11.

Replacing / removing the headset's rechargeable battery

The rechargeable battery must only be replaced or removed by an authorized EPOS service center.

- ▷ Contact your EPOS service center if the rechargeable battery needs to be replaced. To find the EPOS service partner in your country, visit www.eposaudio.com.

Outside the warranty period, the rechargeable batteries may be replaced or re-moved by any qualified service center.

Updating the firmware of the products

To update the installed firmware:

- ▶ Install the free of charge [EPOS Connect](#) software (see page 10).

Updating the firmware of the headset

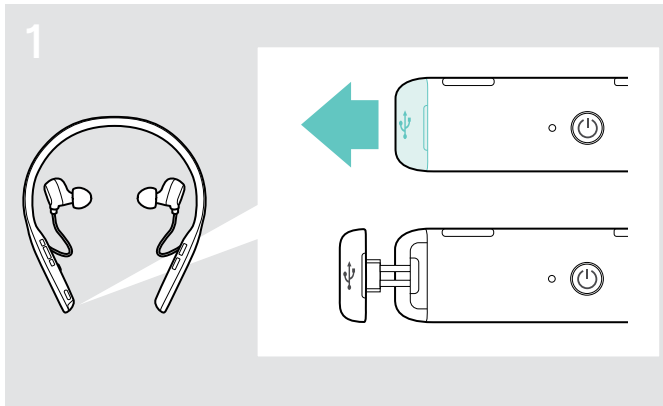

- ▶ Pull carefully on the cover of the USB socket.

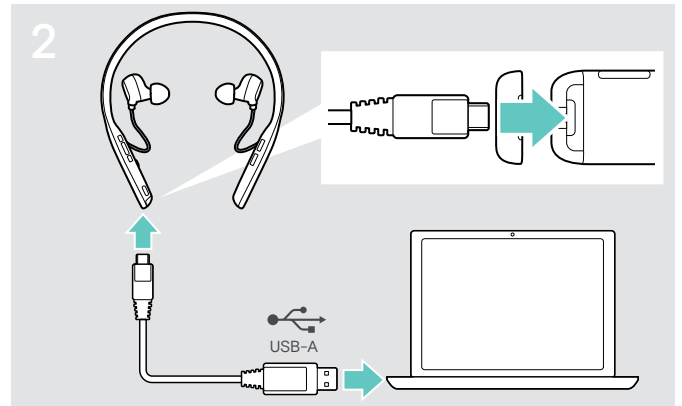

- ▶ Connect the USB cable to your headset and your computer. The LED lights up.
- ▶ Start [EPOS Connect](#). If there is a new firmware available the software will guide you through the update process.



Updating the firmware of the dongle

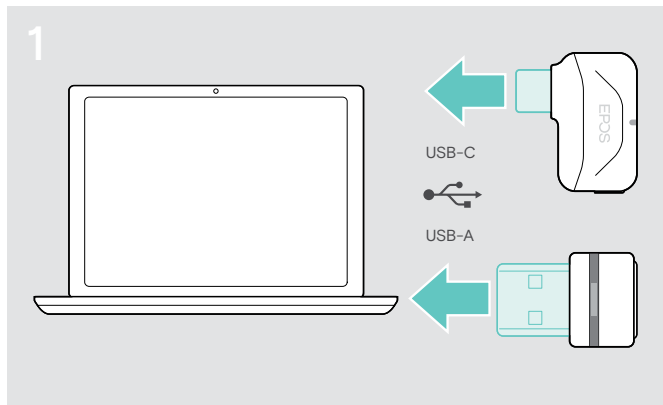

- ▶ Plug the dongle into the USB port of your computer. The LED lights up.

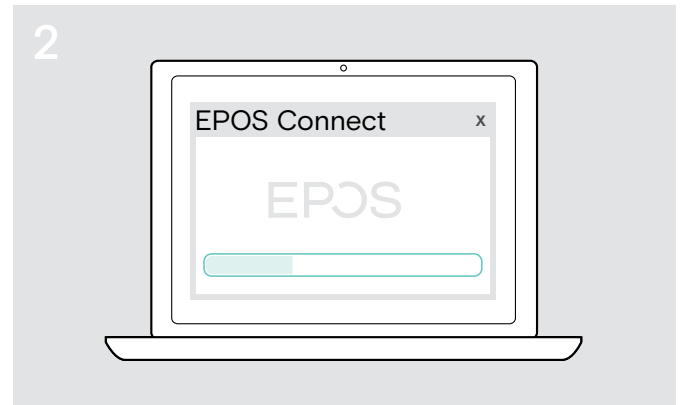

- ▶ Start [EPOS Connect](#). If there is a new firmware available the software will guide you through the update process.

If a problem occurs ...

Problem	Possible cause	Solution	Page
Headset cannot be turned on	Rechargeable battery empty	▷ Recharge the headset battery.	20
Active Noise Cancellation (ANC) cannot be turned on	Rechargeable battery empty	▷ Recharge the headset battery.	20
	Headset turned off	▷ Turn the headset on. ▷ Double tap the Power button.	12
No audio signal or drop outs	Headset not paired with a Bluetooth device	▷ Pair the headset.	8
	Volume adjusted too low	▷ Increase the headset's volume.	13
		▷ Increase the volume on the connected device.	-
	Headset turned off	▷ Turn the headset on.	12
Computer: Headset not selected as audio device	▷ Change the Audio settings of your computer.	10	
Headset cannot be connected via Bluetooth	Headset not paired	▷ Pair the headset with a Bluetooth device (max. 20 cm distance while pairing between devices).	8
		▷ Check if your Bluetooth device supports the HF or HS profile.	-
	Bluetooth at mobile device turned off	▷ Turn Bluetooth on.	-
	Dongle not plugged in	▷ Plug the dongle into the USB port of your Computer.	8
Microsoft Teams does not work: LED blue instead of purple	Dongle or Microsoft Teams disturbed	▷ Unplug and plug the dongle again.	-
		▷ Re-start Teams on your device.	-
Beeps instead of voice prompts	Voice prompts disabled	▷ Enable the voice prompts.	23
Headset or dongle does not react to any button press	Software or hardware problems	▷ Turn the headset off and on again.	12
		▷ Unplug and plug in the dongle again.	8
		▷ Clear the pairing list of the headset.	27
		▷ Clear the pairing list of the dongle.	27

If a problem occurs that is not listed in the above table or if the problem cannot be solved with the proposed solutions, please contact your local EPOS partner for assistance. To find the EPOS partner in your country, search at www.eposaudio.com.

Clearing the pairing list of the headset (Reset)

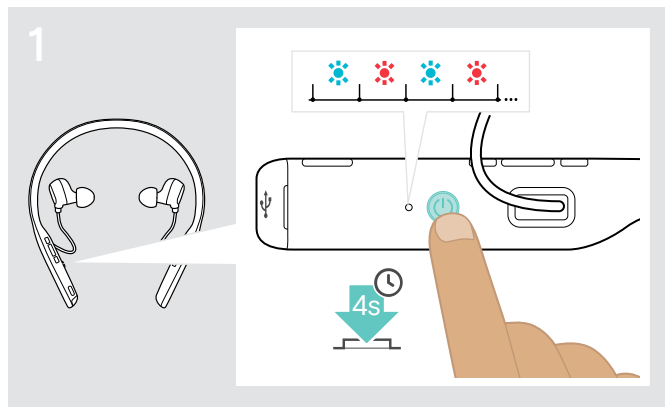

- ▶ Press and hold the Power button until the LED flashes blue and red.

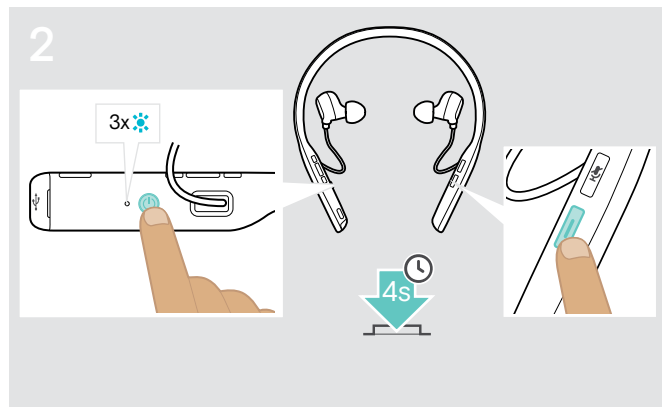

- ▶ Simultaneously press the Hook and the Power button. The LED flashes blue 3 times. The pairing list is cleared. The headset searches for Bluetooth devices to pair with (see page 8).

Clearing the pairing list of the dongle (Reset)

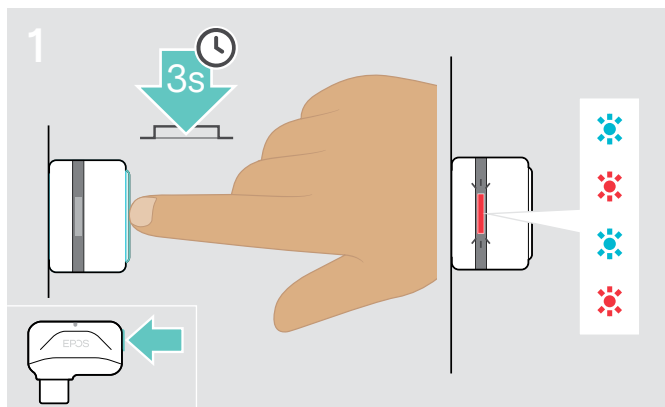

- ▶ Plug the dongle into the USB port of your computer.
- ▶ Press and hold the button until the LED flashes blue and red.

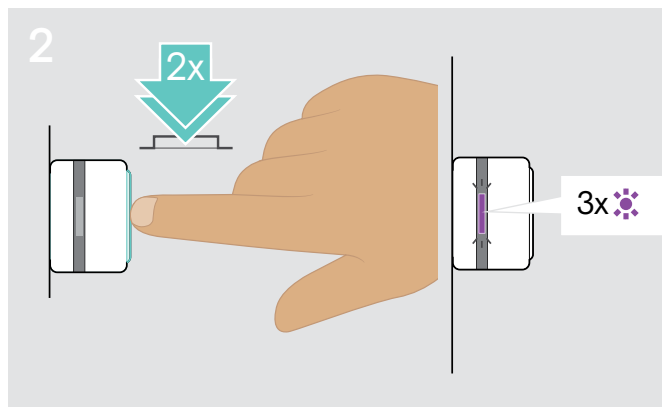

- ▶ Double press the dongle's button. The LED flashes purple 3 times. The pairing list is cleared. The dongle searches for Bluetooth devices to pair with (see page 8).

Specifications

Headset - General

Wearing style	In-ear neckband headset, single and double sided wearing style
Color	Black with silver
Dimensions (W x H x D)	171 x 159 x 17 mm / 6.73 x 6.25 x 0.67 in
Weight	50 g / 1.76 oz
Transducer principle	Dynamic, closed
Connectivity	Multi-point connectivity to 2 actively paired Bluetooth devices and 8 devices in the pairing list, Bluetooth 5.0
Connector	Micro USB
Supported Bluetooth profiles	Hands-Free Profile (HFP), Headset Profile (HSP), Audio Video Remote Control Profile (AVRCP), Advanced Audio Distribution Profile (A2DP)
Supported codecs	AptX™, SBC
Rechargeable battery (built-in)	Lithium Polymer / 3.7 V DC / 240 mAh
Charging time	2 hours
Standby time	216 hours
Battery time	Listening time: up to 15 hours (ANC off) / 14 hours (ANC on) Talking time: up to 14 hours (ANC off) / 14 hours (ANC on)
Range	Up to 20 m / 65.5 feet (device dependent)

Headset - Audio

Speaker frequency response	20 – 20,000 Hz
Sound pressure level (SPL)	Limited by EPOS ActiveGard®: max. 118 dB
Total harmonic distortion (THD)	< 0.5%
Noise cancellation	Hybrid ANC technology with 4 microphones
Microphone type	2 beamforming MEMS microphones
Microphone frequency response	100 – 8,000 Hz

Dongle BTD 800 USB

Dimensions (W x H x D)	22 x 16 x 6 mm / 0.87 x 0.63 x 0.24 in
Weight	2 g / 0.07 oz / 0.004 lbs
Connector	USB-A plug
Connectivity	Bluetooth 4.2
Output power	max. 8 dBm (EIRP)

Dongle BTD 800 USB-C

Dimensions (W x H x D)	27.5 x 23.5 x 7.5 mm / 1.05 x 0.93 x 0.30 in
Weight	2.8 g / 1.0 oz / 0.006 lbs
Connector	USB-C plug
Connectivity	Bluetooth 4.2
Output power	max. 11 dBm (EIRP)

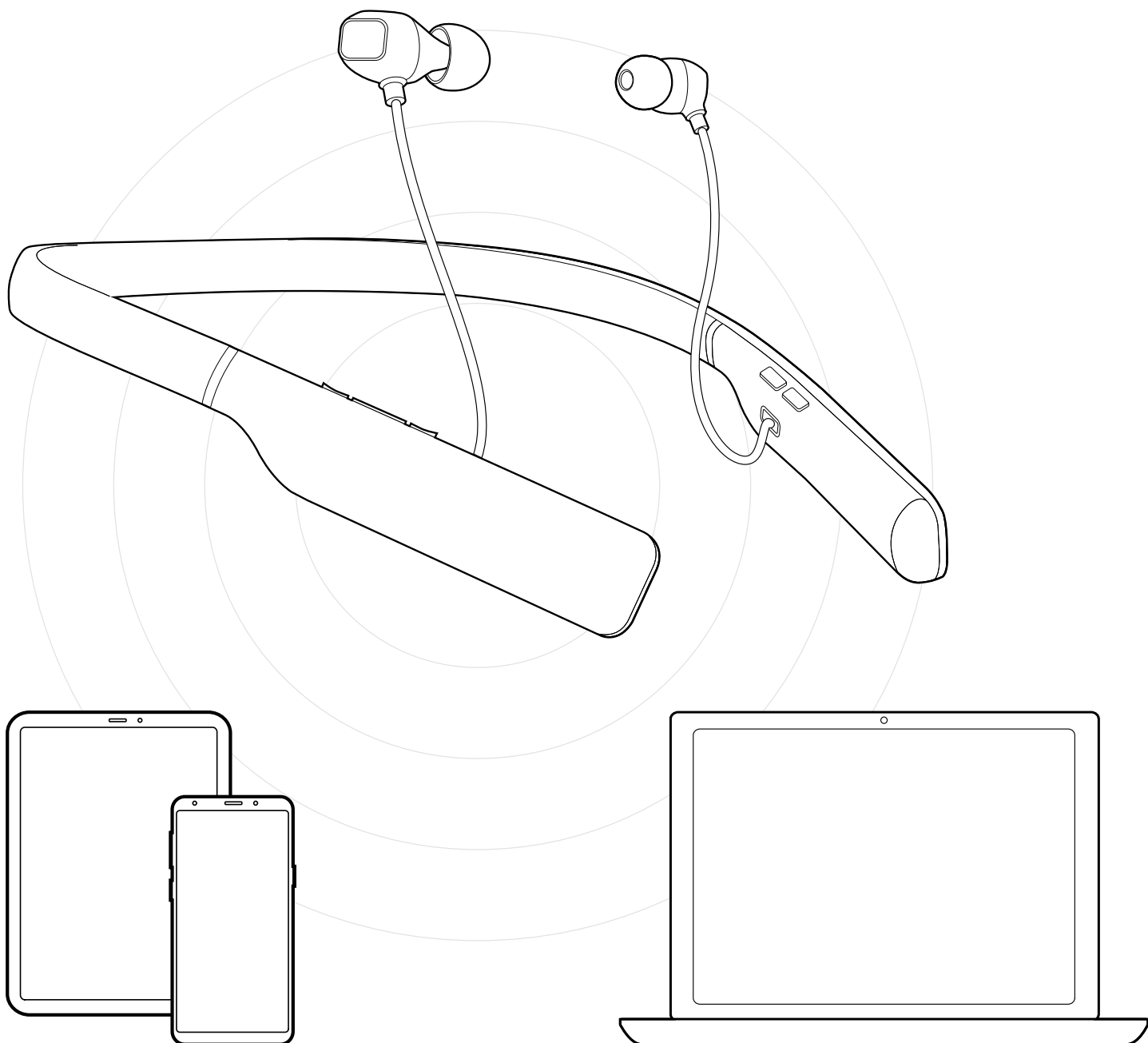

Sennheiser Communications A/S

Industriparken 27, DK-2750 Ballerup, Denmark
www.eposaudio.com