



CORSAIR

H60x | H100x

RGB ELITE

PERFORMANCE RGB LIQUID CPU COOLER

EN ENGLISH

FR FRANÇAIS (EURO)

DE DEUTSCH

NL NEDERLANDS

IT ITALIANO

ES ESPAÑOL (EURO)

PT PORTUGUÊS (EURO)

PL POLSKI

SC 简体中文

AR العربية



TABLE OF CONTENTS

INTEL (All Sockets)

AMD AM5/AM4

FINISHING UP YOUR INSTALLATION









FAQ

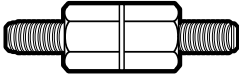

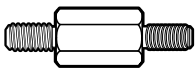
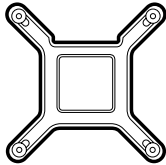
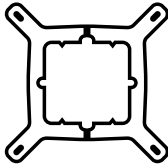
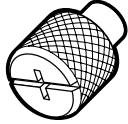
Note: Most newer PC cases include a CPU cut-out to allow access to the bottom of the motherboard. If your case does not include a cut-out, you will need to remove your motherboard from the case prior to installation. ELITE Series coolers come with the Intel mounting bracket pre-installed on the pump for quick installation.

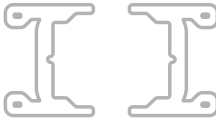
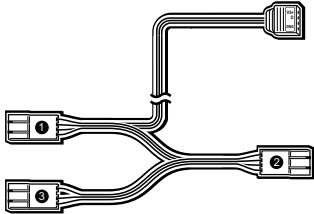
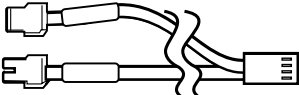
INCLUDED HARDWARE

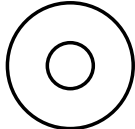
Highlighted parts for Intel installation only

<p>A</p>  <p>x4 INTEL 1200/1156/1155/1151/1150 STANDOFFS</p>	<p>B</p>  <p>x4 INTEL 2066/2011-3/2011 STANDOFFS</p>	<p>C</p>  <p>x4 INTEL 1700 STANDOFFS</p>
<p>D</p>  <p>x1 INTEL BACKPLATE (1200/115X/1700 ONLY)</p>	<p>E</p>  <p>x1 INTEL MOUNTING BRACKET (PRE-INSTALLED)</p>	<p>F</p>  <p>x4 THUMB NUTS</p>
<p>G</p>  <p>x4 AMD AM5/AM4 STANDOFFS</p>	<p>H</p>  <p>x1 AMD AM5/AM4 MOUNTING BRACKET</p>	<p>I</p>  <p>ARGB CABLE</p>
<p>J</p>  <p>Y-SPLITTER</p>	<p>K</p>  <p>x4 LONG FAN SCREWS (H60x) x8 LONG FAN SCREWS (H100x)</p>	<p>L</p>  <p>x4 RADIATOR SCREWS (H60x) x8 RADIATOR SCREWS (H100x)</p>
<p>M</p>  <p>x8 WASHERS (H60x/H100x)</p>	<p>N</p>  <p>x1 SP120 RGB ELITE (H60x) x2 SP120 RGB ELITE (H100x)</p>	

1. INSTALLING THE INTEL BACKPLATE

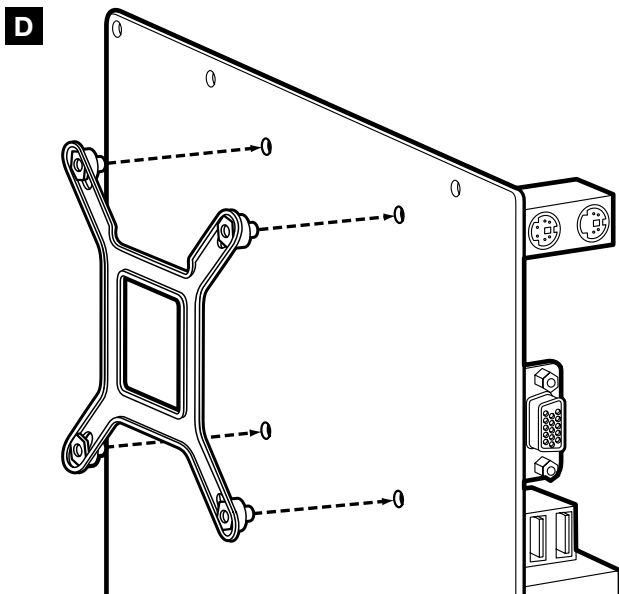

Adjust backplate for your required socket.

NOTE: Intel LGA 2066/2011-3/2011 do not require backplate installation. Proceed to step 2.

2. INSTALLING THE INTEL STANDOFF SCREWS

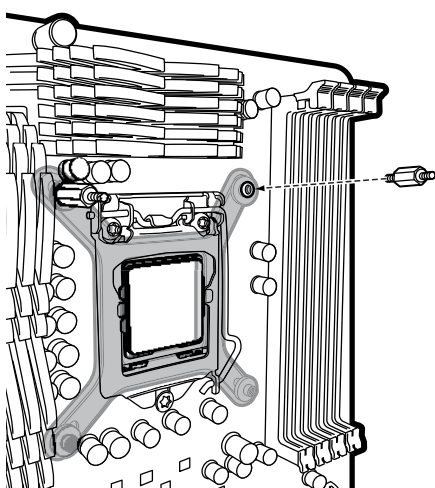

A LGA 1200/1150/
1151/1155/1156

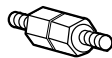

B LGA 2011/
2011-3/2066

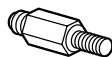

C LGA 1700



> Attach the provided Intel standoff for your socket.

> Use (A) for LGA 1200/115X, (B) for LGA 2011/2011-3/2066 or (C) for LGA 1700.

> Tighten all four standoffs until firmly secured.

3. INSTALL THE FANS AND RADIATOR

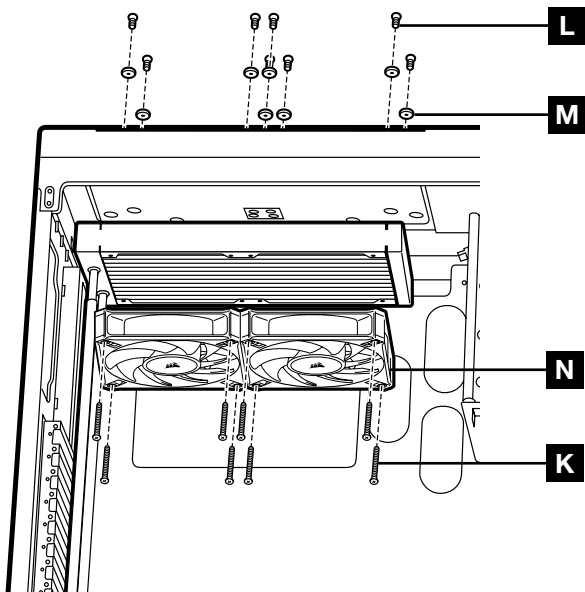

Attach the radiator and the fans as shown. For the best cooling performance, we recommend mounting the fans as an air-intake to your PC case.

4. INSTALLING THE PUMP UNIT

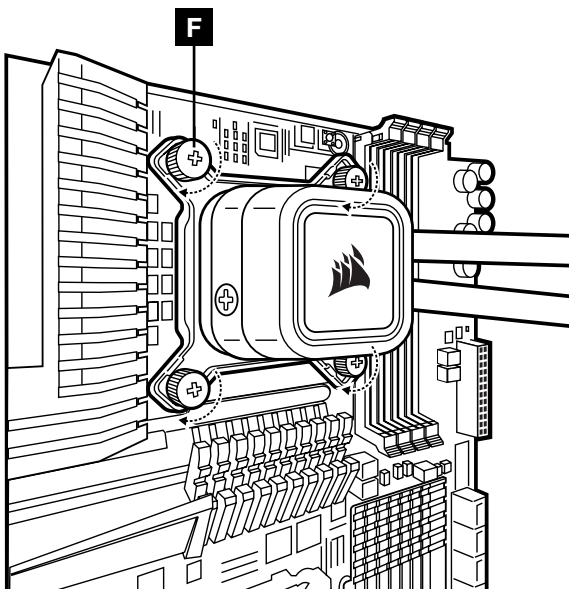







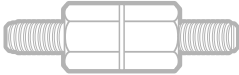

- > Align the bracket and pump over the standoff screws as shown.
- > Attach the thumb nuts (F) to the standoff screws as shown.
- > Tighten the thumb nuts until all four corners are firmly secured.

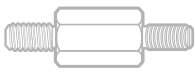
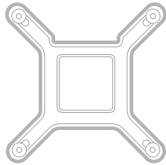
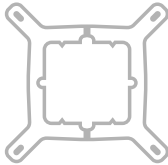
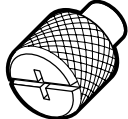
Please continue to Page 7 to continue your installation.

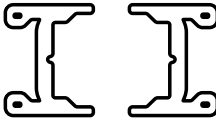
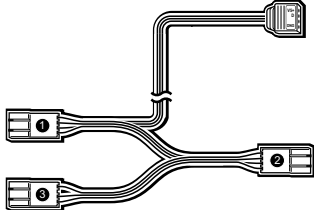
INCLUDED HARDWARE

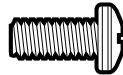
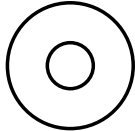
Highlighted parts for AMD AM5/AM4 installation only

<p>A</p>  <p>x4 INTEL 1200/1156/1155/1151/1150 STANDOFFS</p>	<p>B</p>  <p>x4 INTEL 2066/2011-3/2011 STANDOFFS</p>	<p>C</p>  <p>x4 INTEL 1700 STANDOFFS</p>
<p>D</p>  <p>x1 INTEL BACKPLATE (1200/115X/1700 ONLY)</p>	<p>E</p>  <p>x1 INTEL MOUNTING BRACKET (PRE-INSTALLED)</p>	<p>F</p>  <p>x4 THUMB NUTS</p>
<p>G</p>  <p>x4 AMD AM5/AM4 STANDOFFS</p>	<p>H</p>  <p>x1 AMD AM5/AM4 MOUNTING BRACKET</p>	<p>I</p>  <p>ARGB CABLE</p>
<p>J</p>  <p>Y-SPLITTER</p>	<p>K</p>  <p>x4 LONG FAN SCREWS (H60x) x8 LONG FAN SCREWS (H100x)</p>	<p>L</p>  <p>x4 RADIATOR SCREWS (H60x) x8 RADIATOR SCREWS (H100x)</p>
<p>M</p>  <p>x8 WASHERS (H60x/H100x)</p>	<p>N</p>  <p>x1 SP120 RGB ELITE (H60x) x2 SP120 RGB ELITE (H100x)</p>	

1. INSTALLING THE AMD AM5/AM4 MOUNTING BRACKET

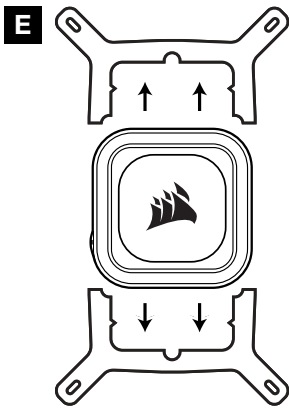

Figure 1

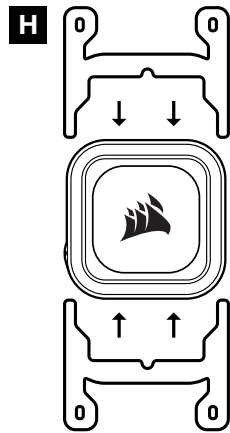
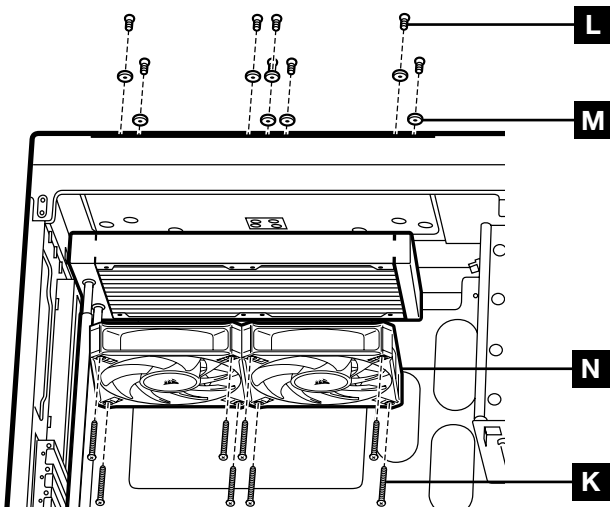

Figure 2

- > Remove the integrated Intel mounting bracket (Figure 1).
- > Install the AMD AM5/AM4 bracket by pushing both sides into the slot on the pump until secure (Figure 2).

Note: It is important that the AMD AM5/AM4 retention bracket be evenly secured on all sides before installation.

2. INSTALL THE FANS AND RADIATOR



Attach the radiator and the fans as shown. For the best cooling performance, we recommend mounting the fans as an air-intake to your PC case.

3. PREPARE THE MOTHERBOARD FOR INSTALLATION

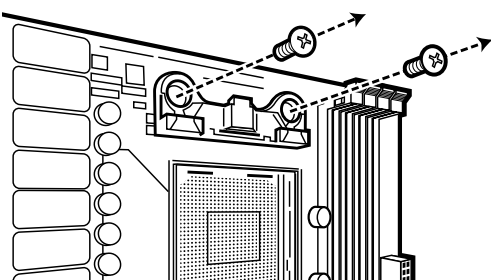

Remove the existing AMD AM5/AM4 mounting brackets shown.

4. INSTALLING THE AMD AM5/AM4 STANDOFF SCREWS

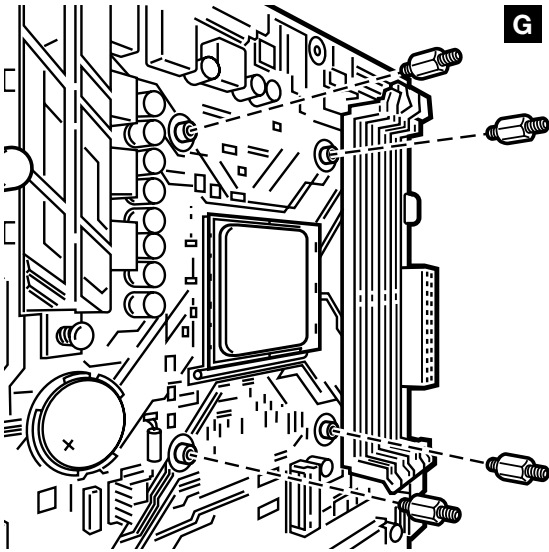

- > Attach the provided AMD AM5/AM4 standoffs to the CPU socket.
- > Tighten all four screws until firmly secure.

5. INSTALLING THE PUMP UNIT

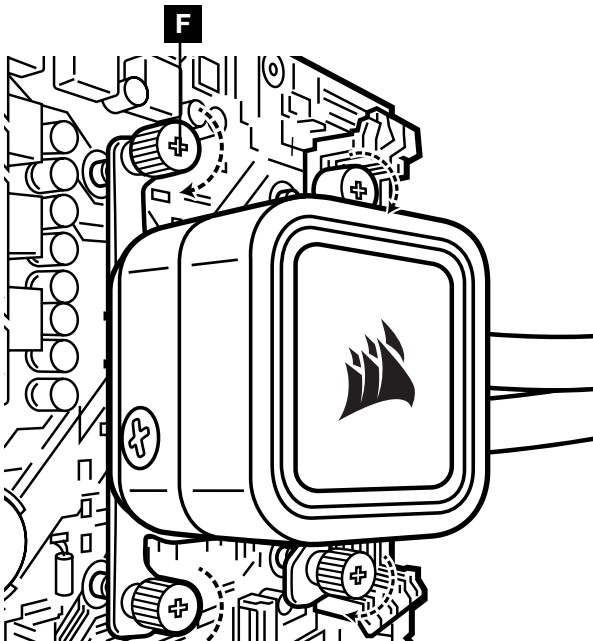

Align the bracket with the AMD AM5/AM4 standoffs as shown. Tighten the thumb nuts (F) until secure.

Please continue to Page 7 to continue your installation.

CONNECT PUMP AND FANS TO MOTHERBOARD

- > Connect pump tach cable to the CPU_FAN header on your motherboard (Figure 1).
- > Connect each fan to the Y-splitter cable (J) then plug the Y-splitter cable into a 4-pin header on your motherboard. (Figure 2)

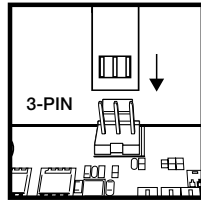

Figure 1



Figure 2

CONNECT PUMP AND FANS TO ARGB

- > Connect the pump and fans into the ARGB cable (I). For best lighting playback, connect the pump into connector #1 and the fan(s) on connector #2 and #3. Plug the ARGB cable into the ARGB header on a compatible motherboard.

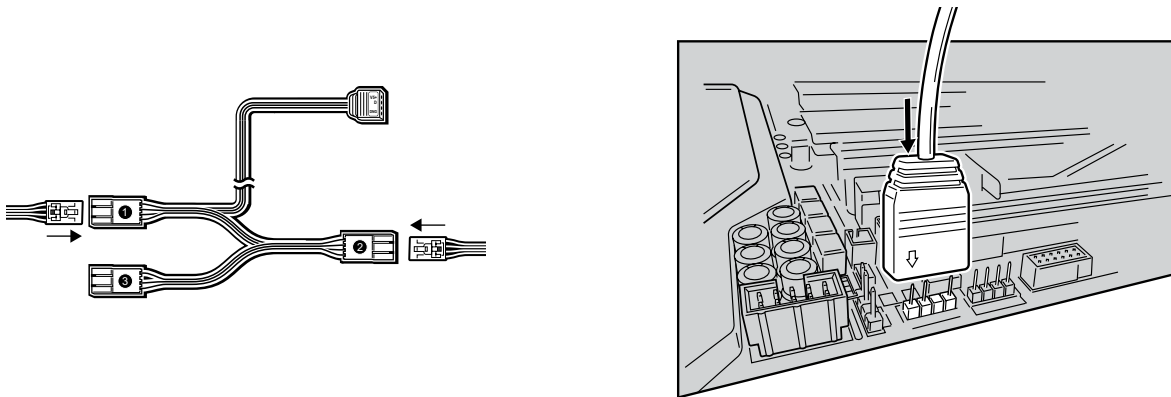

Note: The pump and fan LEDs get power from the motherboard or control device. If they are not connected, they will not illuminate.

- > Alternatively, for the full iCUE experience, connect the 4-pin fan and 4-pin RGB headers into the “Fans” (A) and “RGB HUB” (B) headers on an iCUE COMMANDER CORE XT (sold separately).

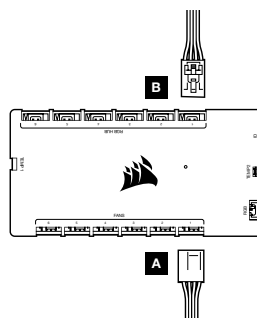

FAQ

1. How do I know the direction of the airflow of the fan?

An arrow located on the side of the fan indicates the direction of airflow.

2. Can I reuse the pre-applied thermal paste on the cooler for re-installation?

Re-installation of the cooler will require you to clean off the pre-applied thermal paste and apply an aftermarket paste.

3. What orientation should I install my radiator?

The best way to install a radiator is with the tubes on the bottom of the case, though you can install it with the tubes in any position, including an inverted radiator, as long as the highest point in the radiator is visibly higher than the CPU pump.

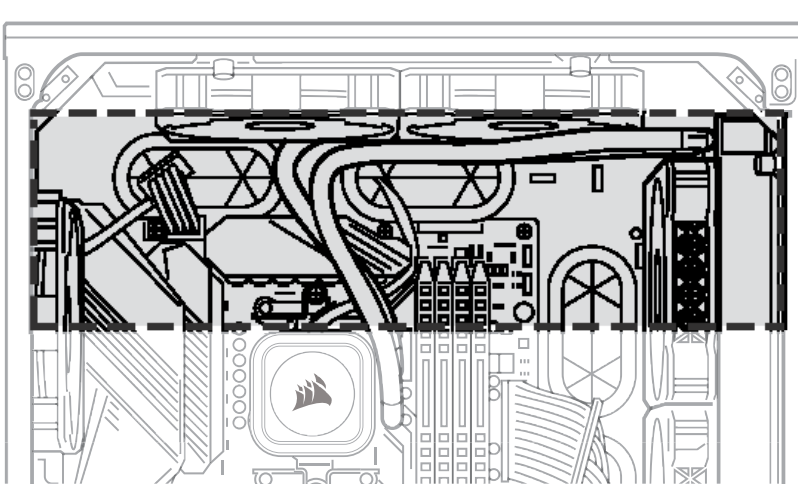

4. My cooler and fans are blinking red or not functioning. What do I do?

Please double check all connections between the cooler and fans. Ensure that the cooler is updated to the most recent firmware via iCUE. If this does not resolve your problems, please open a support ticket at support.corsair.com or contact our customer support team for further troubleshooting and assistance.

<https://help.corsair.com/hc/en-us/requests/new>

5. What should I do if my cooler backplate feels loose after installation?

It is common for your cooler backplate to feel loose after you install it into your motherboard for the first time. Once you have seated and tightened down the cooler pump, it will pull the backplate to the motherboard and apply pressure on the socket via the cooler.

IMPORTANT: Do NOT, under any circumstances, add additional washers and spacers to your backplate to decrease play in the backplate. Doing so will increase the mounting pressure to the retention kit and potentially damage your retention kit, motherboard, or socket.



Web:	corsair.com	Support:	support.corsair.com
Phone:	(888) 222-4346	Blog:	corsair.com/blog
Warranty:	corsair.com/support/warranty	Forum:	forum.corsair.com
		YouTube:	youtube.com/corsairhowto

© 2023 CORSAIR MEMORY, Inc. All rights reserved. CORSAIR and the sails logo are registered trademarks of CORSAIR in the United States and/or other countries. All other trademarks are the property of their respective owners. Product may vary slightly from those pictured.

49-002680 AA

