

## In-Band OAM Gigabit Ethernet to MM LC Fiber Media Converter - 550m, Metal Housing

ET91000LCOAM



\*actual product may vary from photos

DE: Bedienungsanleitung - [de.startech.com](http://de.startech.com)

FR: Guide de l'utilisateur - [fr.startech.com](http://fr.startech.com)

ES: Guía del usuario - [es.startech.com](http://es.startech.com)

IT: Guida per l'uso - [it.startech.com](http://it.startech.com)

NL: Gebruiksaanwijzing - [nl.startech.com](http://nl.startech.com)

PT: Guia do usuário - [pt.startech.com](http://pt.startech.com)

For the most up-to-date information, please visit: [www.startech.com](http://www.startech.com)

## FCC Compliance Statement

This equipment has been tested and found to comply with the limits for a Class B digital device, pursuant to part 15 of the FCC Rules. These limits are designed to provide reasonable protection against harmful interference in a residential installation. This equipment generates, uses and can radiate radio frequency energy and, if not installed and used in accordance with the instructions, may cause harmful interference to radio communications. However, there is no guarantee that interference will not occur in a particular installation. If this equipment does cause harmful interference to radio or television reception, which can be determined by turning the equipment off and on, the user is encouraged to try to correct the interference by one or more of the following measures:

- Reorient or relocate the receiving antenna.
- Increase the separation between the equipment and receiver.
- Connect the equipment into an outlet on a circuit different from that to which the receiver is connected.
- Consult the dealer or an experienced radio/TV technician for help.

## Use of Trademarks, Registered Trademarks, and other Protected Names and Symbols

This manual may make reference to trademarks, registered trademarks, and other protected names and/or symbols of third-party companies not related in any way to StarTech.com. Where they occur these references are for illustrative purposes only and do not represent an endorsement of a product or service by StarTech.com, or an endorsement of the product(s) to which this manual applies by the third-party company in question. Regardless of any direct acknowledgement elsewhere in the body of this document, StarTech.com hereby acknowledges that all trademarks, registered trademarks, service marks, and other protected names and/or symbols contained in this manual and related documents are the property of their respective holders.

# Table of Contents

<b>Product Overview .....</b>	<b>1</b>
Side 1 .....	1
Side 2 .....	1
<b>Introduction .....</b>	<b>2</b>
Packaging Contents .....	2
System Requirements.....	2
<b>Factory Reset Procedure .....</b>	<b>2</b>
<b>Installation .....</b>	<b>3</b>
Installation into ETCHS2U Chassis.....	4
<b>Operation .....</b>	<b>4</b>
System Information Section.....	5
Local Settings Section .....	6
Tools Section.....	15
Logging Out.....	17
<b>Specifications.....</b>	<b>18</b>
<b>Technical Support .....</b>	<b>19</b>
<b>Warranty Information.....</b>	<b>19</b>

# Product Overview

## Side 1



DC Jack

## Side 2

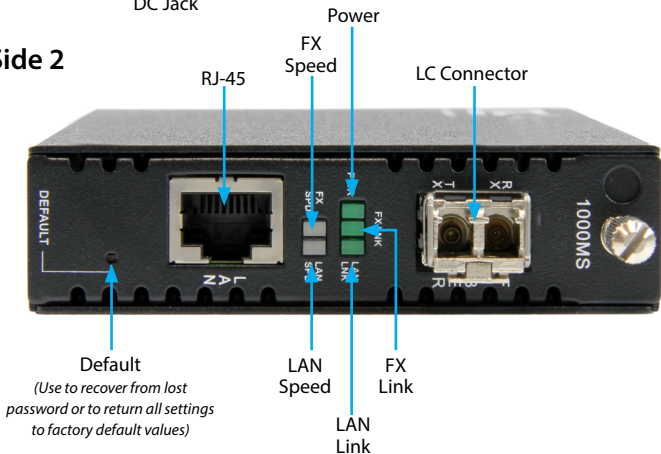

RJ-45

Power

LC Connector

Default

*(Use to recover from lost password or to return all settings to factory default values)*

LAN Speed

FX Link

LAN Link

The LAN Speed and FX Speed LEDs use 2 colors to indicate speed. Green indicates Fast Ethernet (100Mbps), while Yellow indicates Gigabit Ethernet. When the LEDs are off, it indicates a speed of 10Mbps.

# Introduction

## Packaging Contents

- 1x Fiber Media Converter
- 1x Universal Power Adapter (NA/UK/EU)
- 1x Instruction Manual

## System Requirements

- 1000BASE-T compatible Ethernet network equipment
- RJ45 terminated UTP Cat5e or better Ethernet cable
- Available AC electrical outlet

## Factory Reset Procedure

Apply power to the unit and allow approximately 30 seconds to fully boot. Using a pencil or a ball-point pen, press the "DEFAULT" push button located on the face plate and hold it for 6 seconds. The media converter will be restored to its factory default values, which are:

**IP:** 10.1.1.1

**Subnet Mask:** 255.255.255.0

**Gateway:** 10.1.1.254

**Username/Password:** "admin"

# Installation

1. Connect the fiber optic network cable from a computer/switch/media converter to the LC connector on the media converter.

**NOTE:** When connecting the fiber cable, make sure to connect the Tx (transmit) terminal on one end, with the Rx (receive) terminal on the other end.

2. Connect a UTP Ethernet cable, from a computer/switch to the RJ45 jack on the media converter.
3. Connect the power adapter to the media converter.

The following example illustrates the connection scheme when connecting from a 1000BASE-T Ethernet port of a hub/switch to a 1000BASE-SX/LX port of another hub/switch. Through the fiber media converter:

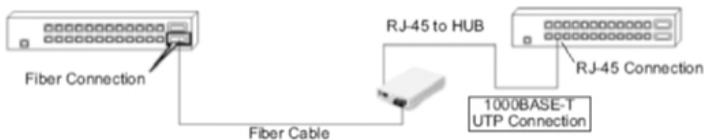

The following example illustrates the connection scheme when connecting from a 1000BASE-T Ethernet port on a hub/switch to a 1000BASE-T Ethernet Network Interface Card (NIC) in a computer through the fiber media converter:

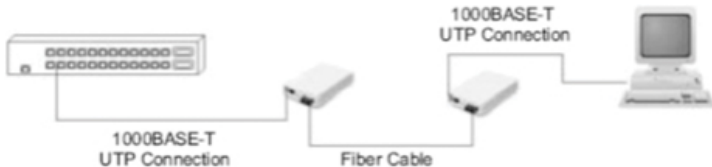

## Installation into ETCHS2U Chassis

The ETCHS2U chassis supports the full line of StarTech.com ET series 2 media converters, which can be installed in a mixed fashion to suit your environment. The cards are designed to be hot-swappable, meaning the chassis need not be powered off in order to remove or insert a card.

1. If the chassis slot was previously unused, loosen the screw at the top of the slot to remove the cover plate
2. Align the card with the desired slot of the chassis and gently slide the card into the groove to seat the power connection
3. Re-tighten the captive screw to hold the card in place

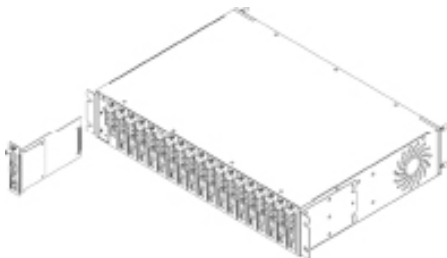

## Operation

The media converter can be configured via a web console, accessible through any web browser by using its IP address.

1. Open your desired web browser and enter the IP address for the device into the address bar (Default IP: **10.1.1.1**).

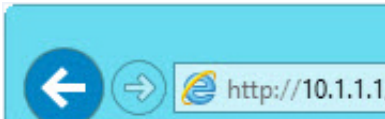

2. Enter the username / password (Default: **admin / admin**) and click **Login**.

# StarTech.com

## 1G Base-TX to 1G Base-FX OAM Media Converter

Username:

Password:

Login

The configuration webpage will appear with the following section down the left side. Each can be expanded to reveal several configuration options and tool, which will be explained in the following pages

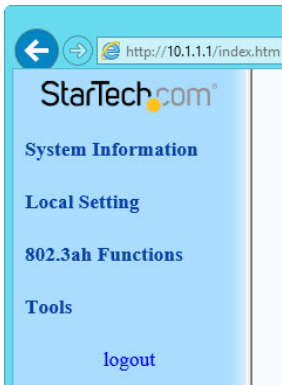

## System Information Section

### Network Information

The information displayed on this page gives specific device information, network information, and port status for the local ET91000LCOAM and for any remote unit that is accessible via IEEE802.3ah OAM in-band management.



### Local Device Information

MAC Address	00:01:02:03:04:99
Software Version	1.000
IP Address	192.168.0.250
Gateway	192.168.0.10
Subnet Mask	255.255.255.0
Description	ET91000LCOAM

### Remote Device Information

MAC Address	00:01:02:03:04:73
Software Version	1.000
IP Address	192.168.0.249
Gateway	192.168.0.10
Subnet Mask	255.255.255.0
Description	ET91000LCOAM

### Local Port Status

Ports	TP	FX
Link Status	Up	Up
Speed	100M	1000M
Duplex mode	Full	Full
Flow control	Enable	Enable
Auto negotiation	Auto	Force

### Remote Port Status

Ports	TP	FX
Link Status	Down	Up
Speed	10M	1000M
Duplex mode	Half	Full
Flow control	Enable	Enable
Auto negotiation	Auto	Auto

## DD Information

The DD or DDOM information is read from the MSA compliant SFP module and can be displayed via the web user interface.

Vendor Name If	CTC UNION
Vendor Part Number	SFM-7000-S85(I)
Fiber Type	Multi Mode
TX Wave Length	0850 nm
RX Wave Length	0850 nm
Link Length	0550 m

## Local Settings Section

### IP Configuration

Use this screen to configure TCP/IP settings for the local unit. Click the Apply button to save your settings.

**Note:** Changing the IP address will cause you to lose your remote management session until you re-connect at the new address.

DHCP Client	Disable ▾
IP Address	10.1.1.1
Subnet Mask	255.255.255.0
Gateway	10.1.1.254
Description	ET91000LCOAM

Apply

## Password Settings

Use this screen to change the web console login password. Key in the current password (Default: **admin**) and then enter your desired new password twice. Click the Apply button to save your settings.

<b>Login Name</b>	<input type="text" value="admin"/>
<b>Old Password</b>	<input type="password"/>
<b>New Password</b>	<input type="password"/>
<b>Confirm</b>	<input type="password"/>

## Converter Configuration

The Converter configuration menu includes special features of the ET91000LCOAM, defined below. Click the Apply button to save your settings.

<b>Management</b>	<input type="radio"/> Disable <input checked="" type="radio"/> Enable
<b>Jumbo Frame (9K)</b>	<input checked="" type="radio"/> Disable <input type="radio"/> Enable
<b>Link Loss Carry Forward</b>	<input checked="" type="radio"/> Disable <input type="radio"/> Enable
<b>Auto Laser Shutdown</b>	<input checked="" type="radio"/> Disable <input type="radio"/> Enable
<b>Forward CRC Error Frame</b>	<input checked="" type="radio"/> Drop <input type="radio"/> Forward
<b>Forward Pause Frame</b>	<input checked="" type="radio"/> Drop <input type="radio"/> Forward
<b>Management Packet High Priority (This function need reset to take effect!)</b>	<input type="radio"/> Disable <input checked="" type="radio"/> Enable
<b>Broadcast Storm Filter</b>	<input checked="" type="radio"/> Disable <input type="radio"/> Enable
<b>Multicast Storm Filter</b>	<input checked="" type="radio"/> Disable <input type="radio"/> Enable
<b>Unknown DA Unicast Storm Filter</b>	<input checked="" type="radio"/> Disable <input type="radio"/> Enable

**Management** - (Default: Enabled) If disabled, all management communication with a remote converter will be stopped. Only normal Ethernet transmission will occur without any possibility of remote management through 802.3ah OAM.

**Jumbo Frames (9k byte packets)** – (Default: Disabled) Enable to add Jumbo Frame support.

Note: Jumbo frames can only work on a pure Jumbo frame network where all devices support it.

**Auto Laser Shutdown (ALS)** - A safety mechanism that will disable laser output when no received optical signal is sensed. By default, ALS is disabled.

**Link Loss Carry Forward** – (Default: Disabled) A method of forwarding a link loss from copper to fiber or from fiber to copper.

**Forward CRC Frame** – (Default: Disabled) The normal behavior of a switch is to read the entire Ethernet frame (store), calculate the check sum and compare to the FCS in the packet. If the checksum matches, the packet is transmitted (&forward). If the checksum does not match, the switch considers the packet to have CRC error and drops it. If this option is enabled, the packet with CRC error will still be forwarded instead of being dropped.

**Forward Pause Frame** - (Default: Disabled) Enable to allow pause frame forwarding to occur. Pause frames are special broadcast frames defined in IEEE802.3x, normally used by the switch to throttle packets through a bottleneck rather than drop excess packets (E.g. A 1Gbps stream is exiting a 100Mbps port). Normally, pause frames are not forwarded between interfaces in the switch.

**Management Packet High Priority** – (Default: Enabled) Provides Quality of Service (QoS) functions to maintain a certain level of performance for specific applications (E.g. Voice and Video over IP). In Ethernet, QoS is dependent on VLAN tagged packets. This is because the QoS priority bits (3 bits) are included in the VLAN tag. Without VLAN tags, there are no priority bits, and no way to set QoS Priority. QoS Priority is enabled by default, but if there are no VLAN tagged packets, the enabled setting is meaningless.

**Broadcast Storm Filter** - (Default: Disabled) Enable to recognize and block the forwarding of excessive broadcast traffic. Broadcast Storm is a condition where either a loop exists on the network or an Ethernet transceiver is bad and exhibiting jabber.

**Multicast Storm Filter** - (Default: Disabled) Enable to block multicast traffic. Many applications like video streaming, IP punch clocks, etc. come with multicast or some broadcast-based protocol turned on by default. Multicast storms happen when application participants request re-transmits of information they have missed.

**Unknown DA Unicast Storm Filter** - (Default: Disabled) Enable to block unknown unicast traffic flooding at a specific port.

## Port Configuration

Use this screen to configure the Ethernet (TP) and the optical port (FX). Options include enabling / disabling the port, setting auto or forced Ethernet mode, enabling 802.3x (flow control), and setting ingress and egress rate limiting.

**Note:** Rate limiting has a granularity of 64K so the rate can be set from 64k to 1000M in 64K steps.

Click the Apply button to save your settings.

Port	Link	Port Active	Mode	Flow Control	Ingress Rate Limit (bps)		Egress Rate Limit (bps)	
TP	Down	Enable	Auto Speed	Enable	Not Limit	0	Not Limit	0
FX	1000R	Enable	Auto Speed	Enable	Not Limit	0	Not Limit	0

Apply Refresh

## MIB Counters

Reports packet statistics on all interfaces of the device.

Port	TP	FX	CPU
Total Bytes	0	83052	64339
Total Pkts	0	652	189
Total Error Pkts	0	0	0
Unicast Pkts	0	173	149
Multicast Pkts	0	332	0
Broadcast Pkts	0	147	40
64	0	148	134
65-127	0	392	9
128-255	0	57	3
256-511	0	40	4
512-1023	0	9	5
1024-1518	0	6	34
Undersize Pkts	0	0	0
Oversize Pkts	0	0	0
Fragments	0	0	0
CRC Errors	0	0	0
Jabbers	0	0	0
Drop Events	0	0	4
Pause Frames	0	0	0

Clear Refresh

## VLAN

### Group Configuration

ET91000LCOAM supports up to 16 VLAN groups. By using the check boxes for each port, the access to different VIDs can be controlled. Click the Apply button to save your settings.

VLAN Mode

VLAN Group	VID	Member		
		TP	FX	CPU
0	<input type="text" value="1"/>	<input checked="" type="checkbox"/>	<input checked="" type="checkbox"/>	<input checked="" type="checkbox"/>
1	<input type="text" value="1"/>	<input checked="" type="checkbox"/>	<input checked="" type="checkbox"/>	<input checked="" type="checkbox"/>
2	<input type="text" value="1"/>	<input checked="" type="checkbox"/>	<input checked="" type="checkbox"/>	<input checked="" type="checkbox"/>
3	<input type="text" value="1"/>	<input checked="" type="checkbox"/>	<input checked="" type="checkbox"/>	<input checked="" type="checkbox"/>
4	<input type="text" value="1"/>	<input checked="" type="checkbox"/>	<input checked="" type="checkbox"/>	<input checked="" type="checkbox"/>
5	<input type="text" value="1"/>	<input checked="" type="checkbox"/>	<input checked="" type="checkbox"/>	<input checked="" type="checkbox"/>
6	<input type="text" value="1"/>	<input checked="" type="checkbox"/>	<input checked="" type="checkbox"/>	<input checked="" type="checkbox"/>
7	<input type="text" value="1"/>	<input checked="" type="checkbox"/>	<input checked="" type="checkbox"/>	<input checked="" type="checkbox"/>
8	<input type="text" value="1"/>	<input checked="" type="checkbox"/>	<input checked="" type="checkbox"/>	<input checked="" type="checkbox"/>
9	<input type="text" value="1"/>	<input checked="" type="checkbox"/>	<input checked="" type="checkbox"/>	<input checked="" type="checkbox"/>
10	<input type="text" value="1"/>	<input checked="" type="checkbox"/>	<input checked="" type="checkbox"/>	<input checked="" type="checkbox"/>
11	<input type="text" value="1"/>	<input checked="" type="checkbox"/>	<input checked="" type="checkbox"/>	<input checked="" type="checkbox"/>
12	<input type="text" value="1"/>	<input checked="" type="checkbox"/>	<input checked="" type="checkbox"/>	<input checked="" type="checkbox"/>
13	<input type="text" value="1"/>	<input checked="" type="checkbox"/>	<input checked="" type="checkbox"/>	<input checked="" type="checkbox"/>
14	<input type="text" value="1"/>	<input checked="" type="checkbox"/>	<input checked="" type="checkbox"/>	<input checked="" type="checkbox"/>
15	<input type="text" value="1"/>	<input checked="" type="checkbox"/>	<input checked="" type="checkbox"/>	<input checked="" type="checkbox"/>

### Per Port Configuration

ET91000LCOAM actually has three different ports: the external copper, external fiber, plus the internal CPU port. The VLAN Per Port Setting page deals with how frames exit (egress) the copper, fiber and CPU (management).

Port	Egress Link Type	Port VLAN Entry
TP	Dont Touch Tag ▼	0 ▼
FX	Dont Touch Tag ▼	0 ▼
CPU	Dont Touch Tag ▼	0 ▼

Apply

The following operations may be performed to the outgoing frames:

1. **Replace Tag** - The device will remove VLAN tags from packets then add new tags to them. The inserted tag is defined in "VLAN Group Index".
2. **Remove Tag** - The switch will remove VLAN tags from packets, if they are tagged. The switch will not modify packets received without tags.
3. **Add Tag** - The switch will add VLAN tags to packets, if they are not tagged when these packets are output on this port. The switch will not add tags to packets already tagged. The inserted tag is defined in "VLAN Group Index".
4. **Don't Touch Tag** - Do not insert or remove VLAN tags to/from packet which is output on this port.

## Double VLAN (Q-in-Q)

Use this section to Enable Q-in-Q tagging and adjust associated settings.

<b>Q in Q Enable</b>	Disable ▼
<b>Out Layer VLAN Tag EtherType (HEX)</b>	0x8100
<b>Out Layer VLAN VID (DEC)</b>	1
<b>VLAN Tag Priority Decision</b>	Use Internal VLAN Tag Priority ▼
<b>Q in Q direction</b>	TP Add QinQ Tag, FX Remove Tag ▼

Apply

Q in Q or double VLAN tagging is defined in IEEE802.1ad. Double VLAN tagging is required when a service provider wishes to carry a customer's VLAN tagged traffic through its own VLAN network. In MEF (Metro Ethernet Forum) terms, the first tag or "inner tag" is referred to as the C-tag (customer) while the second tag or "outer tag" is referred to as the S-tag (service provider). Normal VLAN tag has an EtherType (TPID or Tag Protocol Identifier) of 0x8100. The IEEE802.1ad standard recommends 0x88a8 TPID for the outer or S-tag. Click the Apply button to save your settings.

## Management VLAN

Use this section to configure a management VLAN and designate which ports it can be accessed from.

Click the Apply button to save your settings.

Utp Port Access Control	<input checked="" type="radio"/> Disable	<input type="radio"/> Enable	<input type="radio"/> Drop
Fiber Port Access Control	<input checked="" type="radio"/> Disable	<input type="radio"/> Enable	<input type="radio"/> Drop
Management VID	<input type="text" value="1"/>	(1~4094)	
<input type="button" value="Apply"/>			

## 802.3ah Functions Section

This converter supports IEEE 802.3ah, an OAM protocol that operates at Ethernet Layer 2 (Data Link layer). OAM provides mechanisms to monitor link operation / health and to improve fault isolation.

OAM only works point-to-point over the fiber link. In addition to standard 802.3ah functions like loop back and dying gasp, ET91000LCOAM also implements OAM to provide complete provisioning of the remote fiber connected converter, without using Layer 3 IP protocol. By using OAM, we can remote manage another fiber connected converter, without IP addressing.

## 802.3ah Configuration

Use this section to configure OAM communication settings. Click the Apply button to save your settings.

<b>802.3ah Function</b>	<input type="radio"/> Disable	<input checked="" type="radio"/> Enable
<b>802.3ah Mode</b>	<input checked="" type="radio"/> Passive	<input type="radio"/> Active
<b>Link Events</b>	<input type="radio"/> Disable	<input checked="" type="radio"/> Enable
<b>Remote Loopback</b>	<input type="radio"/> Disable	<input checked="" type="radio"/> Enable
<b>Unidirection Support</b>	<input checked="" type="radio"/> Disable	<input type="radio"/> Enable
<b>Errfrm_Win(second)</b>	<input type="text" value="2"/>	(1~60)
<b>Errfrm_Thr</b>	<input type="text" value="1"/>	(1~2^32)
<b>Errfrmprd_Win</b>	<input type="text" value="148800"/>	(1~2^32)
<b>Errfrmprd_Thr</b>	<input type="text" value="5"/>	(1~2^32)
<b>Errfrmsec_Win(second)</b>	<input type="text" value="10"/>	(10~900)
<b>Errfrmsec_Thr</b>	<input type="text" value="5"/>	(1~65535)
<input type="button" value="Apply"/>		

Note: To use the OAM functions, the **802.3ah Functions** setting must be Enabled (Default: Disabled).

**802.3ah Mode** – (Default: Passive) Used to configure an OAM pair. In a pair, one unit must be 'active', while the other must be 'passive'. Typically the remote converter (CPE) would be in 'passive' mode and the local in 'active'.

**Link Events** – Enable / Disable reporting of Link Events via OAM.

**Remote Loopback** – (Default: Disabled) In order to do a Remote Loop Back test, the option must be enabled in both converters.

**Unidirection Support** – Enable / Disable reporting if Unidirectional Link Detection events via OAM.

**Errfrm\_Win (Error Frame Window)** – (Default: 2 seconds) Adjustable from 1 to 60 seconds. This is the "Window" of time used to gather error frames.

**Errfrm\_Thr (Error Frame Threshold)** - This threshold count can be set from 1 up to 2 x 1032. This count in conjunction with the error frame window, will determine if the Error Frame event is reported via OAM.

**Errfrmprd\_Win (Error Frame Period Window)** – (Default: 148800) This frame count window can be set from 1 up to 2 x 1032 to gather the number of frame errors within the last x frames.

**Errfrmprd\_Thr (Error Frame Period Threshold)** - This threshold count can be set from 1 up to 2 x 1032. This count in conjunction with the frame window will determine if the Error Frame Period event is reported via OAM.



**Errfrmsec\_Win (Error Frame Seconds Summary Window)** – (Default: 10) This window of time can be adjusted from 10 to 900 seconds. This is the "Window" used to gather error frame seconds (the number of 1-second intervals with at least one frame error).

**Errfrmsec\_Thr (Error Frame Seconds Summary Threshold)** - This threshold count can be set from 5 up to 2 x 1016. This count in conjunction with the frame seconds window, will determine if the Error Frame Seconds Summary event is reported via OAM.

## Loopback Test

The loop back test is a non-intrusive test which uses OAM packets and will not affect normal transmissions.

<b>Send Packet Number</b>	<input type="text" value="1"/> (1~255)
<b>Packet Length (Not include CRC)</b>	<input type="text" value="60"/> (60~1514)

**Send Packet Number** – (Default: 1) The number of OAM frames used (the number of times the loop back is done).

**Packet Length (Not including CRC)** – (Default: 60 bytes) Controls the packet size of the OAM frames used for loop back testing. The CRC of Ethernet packets uses 4 bytes. Valid Ethernet packets range in size from 64 - 1518 bytes. VLAN tag adds another 4 bytes and Q in Q adds yet another 4 bytes, bringing the packet size to a maximum of 1526 bytes. Any frame size larger than this is technically called a jumbo frame.

## 802.3ah Status

The **Global Config** fields display the state of OAM (if Enabled). We can also see the MAC addresses of the local and remote units in the OAM manageable pair.

The **Flags Field** list the results of individual events based on the results of OAM protocol data units (OAMPDUs).

Lastly, when two OAM devices start negotiation, there is **Discovery Information** passed between them. The results are shown here.

## Global Config

Function Enable	ENABLED
Fiber Port State	NORM FWD
Local DTE MAC	00-01-02-03-04-05
Remote DTE MAC	00-02-AB-FF-01-01

## Flags Field

	Local	Remote
Remote Stable	TRUE	TRUE
Remote Evaluating	FALSE	FALSE
Local Stable	TRUE	TRUE
Local Evaluating	FALSE	FALSE
Critical Event	FALSE	FALSE
Dying Gasp	FALSE	FALSE
Link Fault	FALSE	FALSE

## Discovery Information

Discovery State	SEND_ANY
Local PDU	ANY
Local Satisfied	TRUE
Remote State Valid	TRUE
Local Lost Link Timer Done	FALSE
Local Link Status	TRUE

## Tools Section

### System Reboot

When the converter is rebooted, all counters and registers are cleared and the converter starts fresh. If OAM is enabled, the discovery process will start. After selecting the System Reboot menu item, a confirmation dialogue box will pop up. Click "OK" to reboot the converter or click "Cancel" to leave without rebooting.

**Note:** The converter requires about 20~25 seconds to fully reboot.

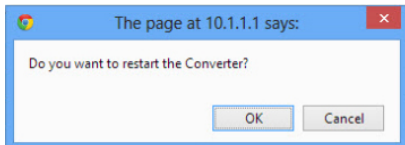

## Save and Restore

After configuring the converter, the entire configuration can be saved as a backup file using the **SaveToFlash** button. Once saved, the configuration file can be loaded at any time using the **LoadFromFlash** button.

To restore all settings to factory default, click the **ResetToFactory** button.

**Note:** The IP address will also be reset to default (10.1.1.1), so you may lose management contact with the converter.

Press the "**SaveToFlash**" button, all current configuration will save to converter as backup.

SaveToFlash

Press the "**LoadFromFlash**" button, the Web Interface may be disconnected for restore to previous backup configuration.

LoadFromFlash

Press the "**ResetToFactory**" button, the Web Interface will disconnected. After reset all configuration, the system will back to factory default mode. The default IP address is **10.1.1.1**.

ResetToFactory

## Firmware Upgrade

Use this section to upload a new firmware for added features, bug fixes or default setting changes.

**Note:** Please avoid loss of power or network connection during this process, to avoid damage to the device.

### Firmware Upgrade

This mode allows to proceed the firmware upgrade on device.

Please select the location of the firmware file on your PC by using the browse button as below, then press the **"Upgrade"** button.

Choose File No file chosen

Note:

1. Ensure that the **"File of type"** field in the browse window is set to 'All files(\*.\*)'.
2. To cancel the Firmware Upgrade process, power cycle the switch without selecting any files.

Upgrade

(Firmware Upgrading may take 60 seconds)

Firmware Upgrade process must NOT be interrupted !

## Logging Out

Click the Logout button at the bottom of the web interface to terminate your session. Once logged out, the username / password will be required to login again.

### Tools

System Reboot

Save and Restore

Firmware Upgrade

logout

# Specifications

<b>Supported Standards</b>	IEEE 802.3, 802.3u, 802.3ab, 802.3z, 802.3ah, 802.1Q
<b>Connectors</b>	1x RJ45 Female 1x LC Fiber Female 1x DC Power
<b>LED Indicator(s)</b>	Power, FX-Link, LAN Speed, LAN Link
<b>Compatible Fiber Mode</b>	Multimode
<b>Optical Wavelength</b>	850nm
<b>Maximum Distance</b>	550m
<b>Duplex Modes</b>	Full Duplex on Fiber
<b>Power Adapter</b>	12V DC, 1A
<b>Power Consumption</b>	<5W
<b>Enclosure Material</b>	Metal
<b>Operating Temperature</b>	0°C to 60°C (32°F to 140°F)
<b>Storage Temperature</b>	-10°C to 70°C (14°F to 158°F)
<b>Humidity</b>	10~90% non-condensing
<b>Dimensions</b>	155 x 87 x 24 mm
<b>Weight</b>	620 g

# Technical Support

StarTech.com's lifetime technical support is an integral part of our commitment to provide industry-leading solutions. If you ever need help with your product, visit [www.startech.com/support](http://www.startech.com/support) and access our comprehensive selection of online tools, documentation, and downloads.

For the latest drivers/software, please visit [www.startech.com/downloads](http://www.startech.com/downloads)

## Warranty Information

This product is backed by a two year warranty.

In addition, StarTech.com warrants its products against defects in materials and workmanship for the periods noted, following the initial date of purchase. During this period, the products may be returned for repair, or replacement with equivalent products at our discretion. The warranty covers parts and labor costs only. StarTech.com does not warrant its products from defects or damages arising from misuse, abuse, alteration, or normal wear and tear.

### Limitation of Liability

In no event shall the liability of StarTech.com Ltd. and StarTech.com USA LLP (or their officers, directors, employees or agents) for any damages (whether direct or indirect, special, punitive, incidental, consequential, or otherwise), loss of profits, loss of business, or any pecuniary loss, arising out of or related to the use of the product exceed the actual price paid for the product. Some states do not allow the exclusion or limitation of incidental or consequential damages. If such laws apply, the limitations or exclusions contained in this statement may not apply to you.



Hard-to-find made easy. At StarTech.com, that isn't a slogan. It's a promise.

StarTech.com is your one-stop source for every connectivity part you need. From the latest technology to legacy products — and all the parts that bridge the old and new — we can help you find the parts that connect your solutions.

We make it easy to locate the parts, and we quickly deliver them wherever they need to go. Just talk to one of our tech advisors or visit our website. You'll be connected to the products you need in no time.

Visit [www.startech.com](http://www.startech.com) for complete information on all StarTech.com products and to access exclusive resources and time-saving tools.

*StarTech.com is an ISO 9001 Registered manufacturer of connectivity and technology parts. StarTech.com was founded in 1985 and has operations in the United States, Canada, the United Kingdom and Taiwan servicing a worldwide market.*