

XP-2200 Series User's Guide



Printing

Scanning

Maintaining the Printer

Solving Problems

Contents

Guide to This Manual

Introduction to the Manuals.	6
Important Safety Instructions (paper manual).	6
Start Here (paper manual).	6
User's Guide (digital manual).	6
Information on the Latest Manuals.	6
Guide to Web Movie Manuals.	6
Searching for Information.	6
Printing Only the Pages You Need.	7
About This Manual.	8
Marks and Symbols.	8
Notes on Screenshots and Illustrations.	8
Operating System References.	8
Trademarks.	9
Copyright.	9

Important Instructions

Safety Instructions.	12
Safety Instructions for Ink.	12
Printer Advisories and Warnings.	12
Advisories and Warnings for Setting Up the Printer.	13
Advisories and Warnings for Using the Printer.	13
Advisories and Warnings for Connecting to the Internet.	14
Advisories and Warnings for Using the Printer with a Wireless Connection.	14
Advisories and Warnings for Transporting or Storing the Printer.	14
Protecting Your Personal Information.	14

Part Names and Functions

Front.	16
Inside.	16
Rear.	17

Guide to the Control Panel

Buttons and Functions.	19
Checking Lights and Printer Status.	20

Loading Paper

Paper Handling Precautions.	25
List of Paper Types.	25

Loading Papers.	26
Loading Paper in the Rear Paper Feeder.	26
Loading Various Paper.	28
Loading Envelopes.	28
Loading Pre-punched Paper.	29
Loading Long Papers.	29

Placing Originals

Placing Originals on the Scanner Glass.	31
---	----

Printing

Printing Documents.	34
Printing from a Computer.	34
Printing Documents from Smart Devices.	48
Printing on Envelopes.	49
Printing on Envelopes from a Computer (Windows).	49
Printing on Envelopes from a Computer (Mac OS).	50
Printing Photos.	50
Printing Photos from a Computer.	50
Printing Web Pages.	50
Printing Web Pages from a Computer.	50
Printing Web Pages from Smart Devices.	50
Printing Using a Cloud Service.	51

Copying

Copying Basics.	53
Making Multiple Copies.	53

Scanning

Basic Information on Scanning.	55
What is a "Scan"?.	55
Scanning Uses.	55
Available Scanning Methods.	55
Recommended File Formats to Suit Your Purpose.	56
Recommended Resolutions to Suit Your Purpose.	57
Scanning Originals to a Computer.	57
Scanning from the Control Panel.	57
Scanning from a Computer.	58
Scanning Originals to a Smart Device.	59

Advanced Scanning.	59
Scanning Multiple Photos at the Same Time.	59

Maintaining the Printer

Checking the Ink Levels.	62
Checking the Ink Levels - Windows.	62
Checking the Ink Levels (Mac OS).	62
Improving Print, Copy, and Scan Quality.	62
Checking and Cleaning the Print Head.	62
Running Power Cleaning.	64
Preventing nozzle clogging.	65
Aligning the Print Head.	66
Cleaning the Paper Path for Ink Smears.	66
Cleaning the Scanner Glass.	67
Cleaning the Translucent Film.	68
Cleaning the Printer.	70

In These Situations

When Replacing a Computer.	73
Saving Power.	73
Saving Power - Windows.	73
Saving Power - Mac OS.	73
Disabling your Wi-Fi Connection.	74
Installing the Applications Separately.	74
Checking if a genuine Epson printer driver is installed - Windows.	75
Checking if a genuine Epson printer driver is installed - Mac OS.	77
Re-Setting the Network Connection.	77
Making Settings for Connecting to the Computer.	77
Making Settings for Connecting to the Smart Device.	78
Making Wi-Fi Settings from the Control Panel.	78
Checking the Printer's Network Connection Status (Network Connection Report).	80
Messages and Solutions on the Network Connection Report.	81
Connecting a Smart Device and Printer Directly (Wi-Fi Direct).	86
About Wi-Fi Direct.	86
Connecting to Devices Using Wi-Fi Direct.	87
Changing the Wi-Fi Direct (Simple AP) Settings Such as the SSID.	88
Adding or Changing the Printer's Connection.	89
To Set Up a Printer on Multiple Computers.	89
Changing the Connection from Wi-Fi to USB.	89
Setting a Static IP Address for the Printer.	90

Transporting and Storing the Printer.	92
---	----

Solving Problems

Cannot Print or Scan.	96
Problem Solving.	96
The Application or Printer Driver do not Work Properly.	97
The Printer Cannot Connect to the Network.	100
Paper Does Not Feed Properly.	103
Printing, Copying, and Scanning Quality is Poor.	105
Print Quality is Poor.	105
Copy Quality is Poor.	114
Scanned Image Problems.	119
Cannot Select Paper Type or Paper Source in Printer Driver.	121
A genuine Epson printer driver has not been installed.	121
Checking Lights and Printer Status.	121
Paper Gets Jammed.	124
Removing Jammed Paper.	124
Preventing Paper Jams.	126
It is Time to Replace the Ink Cartridges.	127
Ink Cartridge Handling Precautions.	127
Replacing Ink Cartridges (When Ink Light is Off).	129
Replacing Ink Cartridges (When Ink Light is On or Flashing).	132
Continue Printing Temporarily without Replacing Ink Cartridges.	137
Cannot Operate the Printer as Expected.	140
The Printer Does Not Turn On or Off.	140
Operations are Slow.	141
Operation Sounds Are Loud.	143
The Root Certificate Needs to be Updated.	143
Cannot Perform Manual 2-sided Printing (Windows).	143
The Print Settings Menu is Not Displayed (Mac OS).	143
Cannot Solve Problem.	144
Cannot Solve Printing or Copying Problems.	144

Product Information

Paper Information.	147
Available Paper and Capacities.	147
Unavailable Paper Types.	149
Consumable Products Information.	150
Ink Cartridge Codes.	150
Software Information.	151

Application for Printing from a Computer (Windows Printer Driver)	151
Application for Printing from a Computer (Mac OS Printer Driver)	152
Application for Configuring Printer Operations (Web Config)	153
Application for Updating Software and Firmware (Epson Software Updater)	153
Product Specifications	154
Printer Specifications	154
Scanner Specifications	155
Interface Specifications	156
Network Specifications	156
Dimensions	158
Electrical Specifications	158
Environmental Specifications	159
System Requirements	159
Regulatory Information	160
Standards and Approvals	160
Restrictions on Copying	160

Where to Get Help

Technical Support Web Site	163
Contacting Epson Support	163
Before Contacting Epson	163
Help for Users in Europe	163
Help for Users in Taiwan	163
Help for Users in Australia	164
Help for Users in New Zealand	164
Help for Users in Singapore	165
Help for Users in Thailand	165
Help for Users in Vietnam	166
Help for Users in Indonesia	166
Help for Users in Hong Kong	169
Help for Users in Malaysia	170
Help for Users in India	170
Help for Users in the Philippines	170

Guide to This Manual

Introduction to the Manuals.	6
Guide to Web Movie Manuals.	6
Searching for Information.	6
Printing Only the Pages You Need.	7
About This Manual.	8
Trademarks.	9
Copyright.	9

Introduction to the Manuals

The following manuals are supplied with your Epson printer. As well as the manuals, see the help included in the various Epson software applications.

Important Safety Instructions (paper manual)

Provides you with instructions to ensure the safe use of this printer.

Start Here (paper manual)

Provides you with information on setting up the printer and installing the software.

User's Guide (digital manual)

This manual. Available as a PDF and Web manual. Provides detailed information and instructions on using the printer and solving problems.

Information on the Latest Manuals

Paper manual

Visit the Epson Europe support website at <http://www.epson.eu/support>, or the Epson worldwide support website at <http://support.epson.net/>.

Digital manual

Visit the following website, enter the product name, and then go to **Support**.

<https://epson.sn>

Guide to Web Movie Manuals

You can watch Web Movie Manuals to learn how to use the printer. Access the following website. The contents of the Web Movie Manuals are subject to change without prior notice.



https://support.epson.net/publist/video.php?model=xp-2200_series

Searching for Information

The PDF manual allows you to search for information you are looking for by keyword, or jump directly to specific sections using the bookmarks. This section explains how to use a PDF manual that has been opened in Adobe Acrobat Reader DC on your computer.

Searching by keyword

Click **Edit > Advanced Search**. Enter the keyword (text) for information you want to find in the search window, and then click **Search**. Hits are displayed as a list. Click one of the displayed hits to jump to that page.

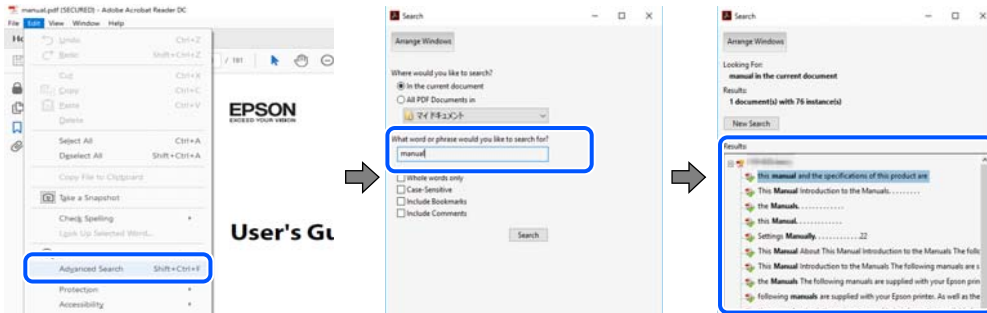

Jumping directly from bookmarks

Click a title to jump to that page. Click + or > to view the lower level titles in that section. To return to the previous page, perform the following operation on your keyboard.

- ❑ Windows: Hold down **Alt**. and then press **←**.
- ❑ Mac OS: Hold down the command key, and then press **←**.

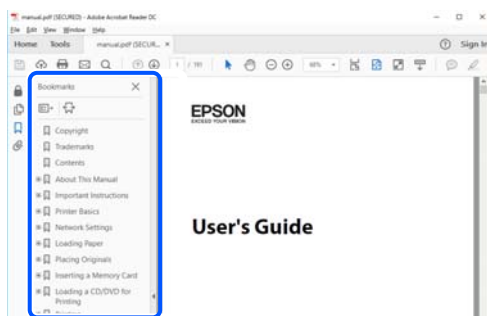

Printing Only the Pages You Need

You can extract and print only the pages you need. Click **Print** in the **File** menu, and then specify the pages you want to print in **Pages** in **Pages to Print**.

- ❑ To specify a series of pages, enter a hyphen between the start page and the end page.
Example: 20-25
- ❑ To specify pages that are not in series, divide the pages with commas.
Example: 5, 10, 15

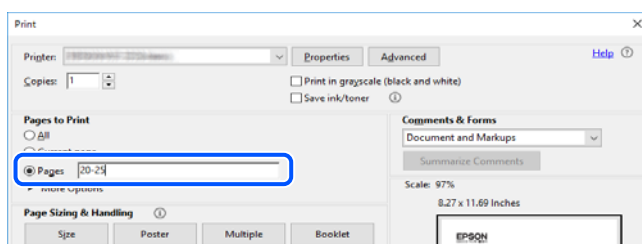

About This Manual

This section explains the meaning of marks and symbols, notes on descriptions, and operating system reference information used in this manual.

Marks and Symbols



Caution:

Instructions that must be followed carefully to avoid bodily injury.



Important:

Instructions that must be observed to avoid damage to your equipment.

Note:

Provides complementary and reference information.

Related Information

➔ Links to related sections.



Provides Web Movie Manuals of the operating instructions. See the related information link.

Notes on Screenshots and Illustrations

- Screenshots of the printer driver are from Windows 10 or macOS High Sierra (10.13). The content displayed on the screens varies depending on the model and situation.
- Illustrations used in this manual are examples only. Although there may be slight differences depending on the model, the method of operation is the same.

Operating System References

Windows

In this manual, terms such as "Windows 11", "Windows 10", "Windows 8.1", "Windows 8", "Windows 7", "Windows Vista", "Windows XP" refer to the following operating systems. Additionally, "Windows" is used to refer to all versions.

- Microsoft® Windows® 11 operating system
- Microsoft® Windows® 10 operating system
- Microsoft® Windows® 8.1 operating system
- Microsoft® Windows® 8 operating system
- Microsoft® Windows® 7 operating system
- Microsoft® Windows Vista® operating system

- Microsoft® Windows® XP operating system
- Microsoft® Windows® XP Professional x64 Edition operating system

Mac OS

In this manual, "Mac OS" is used to refer to Mac OS X 10.9.5 or later as well as macOS 11 or later.

Trademarks

- EPSON® is a registered trademark, and EPSON EXCEED YOUR VISION or EXCEED YOUR VISION is a trademark of Seiko Epson Corporation.
- QR Code is a registered trademark of DENSO WAVE INCORPORATED in Japan and other countries.
- Microsoft®, Windows®, and Windows Vista® are registered trademarks of Microsoft Corporation.
- Apple, Mac, macOS, OS X, Bonjour, ColorSync, and Safari are trademarks of Apple Inc., registered in the U.S. and other countries.
- Use of the Works with Apple badge means that an accessory has been designed to work specifically with the technology identified in the badge and has been certified by the developer to meet Apple performance standards.
- Chrome, Google Play, and Android are trademarks of Google LLC.
- Adobe, Acrobat, and Reader are either registered trademarks or trademarks of Adobe in the United States and/or other countries.
- Firefox is a trademark of the Mozilla Foundation in the U.S. and other countries.
- PictBridge is a trademark.
- General Notice: Other product names used herein are for identification purposes only and may be trademarks of their respective owners. Epson disclaims any and all rights in those marks.

Copyright

No part of this publication may be reproduced, stored in a retrieval system, or transmitted in any form or by any means, electronic, mechanical, photocopying, recording, or otherwise, without the prior written permission of Seiko Epson Corporation. No patent liability is assumed with respect to the use of the information contained herein. Neither is any liability assumed for damages resulting from the use of the information herein. The information contained herein is designed only for use with this Epson product. Epson is not responsible for any use of this information as applied to other products.

Neither Seiko Epson Corporation nor its affiliates shall be liable to the purchaser of this product or third parties for damages, losses, costs, or expenses incurred by the purchaser or third parties as a result of accident, misuse, or abuse of this product or unauthorized modifications, repairs, or alterations to this product, or (excluding the U.S.) failure to strictly comply with Seiko Epson Corporation's operating and maintenance instructions.

Seiko Epson Corporation and its affiliates shall not be liable for any damages or problems arising from the use of any options or any consumable products other than those designated as Original Epson Products or Epson Approved Products by Seiko Epson Corporation.

Seiko Epson Corporation shall not be held liable for any damage resulting from electromagnetic interference that occurs from the use of any interface cables other than those designated as Epson Approved Products by Seiko Epson Corporation.

© 2022 Seiko Epson Corporation

The contents of this manual and the specifications of this product are subject to change without notice.

Important Instructions

Safety Instructions.	12
Printer Advisories and Warnings.	12
Protecting Your Personal Information.	14

Safety Instructions

Read and follow these instructions to ensure safe use of this printer. Make sure you keep this manual for future reference. Also, be sure to follow all warnings and instructions marked on the printer.

- Some of the symbols used on your printer are to ensure safety and proper use of the printer. Visit the following Web site to learn the meaning of the symbols.
<http://support.epson.net/symbols/>
- Use only the power cord supplied with the printer and do not use the cord with any other equipment. Use of other cords with this printer or the use of the supplied power cord with other equipment may result in fire or electric shock.
- Be sure your AC power cord meets the relevant local safety standard.
- Never disassemble, modify, or attempt to repair the power cord, plug, printer unit, scanner unit, or options by yourself, except as specifically explained in the printer's manuals.
- Unplug the printer and refer servicing to qualified service personnel under the following conditions:
The power cord or plug is damaged; liquid has entered the printer; the printer has been dropped or the casing damaged; the printer does not operate normally or exhibits a distinct change in performance. Do not adjust controls that are not covered by the operating instructions.
- Place the printer near a wall outlet where the plug can be easily unplugged.
- Do not place or store the printer outdoors, near excessive dirt or dust, water, heat sources, or in locations subject to shocks, vibrations, high temperature or humidity.
- Take care not to spill liquid on the printer and not to handle the printer with wet hands.
- Keep the printer at least 22 cm away from cardiac pacemakers. Radio waves from this printer may adversely affect the operation of cardiac pacemakers.

Safety Instructions for Ink

- Be careful when you handle used ink cartridges, as there may be some ink around the ink supply port.
 - If ink gets on your skin, wash the area thoroughly with soap and water.
 - If ink gets into your eyes, flush them immediately with water. If discomfort or vision problems continue after a thorough flushing, see a doctor immediately.
 - If ink gets into your mouth, see a doctor right away.
- Do not disassemble the ink cartridge; otherwise ink may get into your eyes or on your skin.
- Do not shake ink cartridges too vigorously and do not drop them. Also, be careful not to squeeze them or tear their labels. Doing so may cause ink leakage.
- Keep ink cartridges out of the reach of children.



Printer Advisories and Warnings

Read and follow these instructions to avoid damaging the printer or your property. Make sure you keep this manual for future reference.

Advisories and Warnings for Setting Up the Printer

- Do not block or cover the vents and openings in the printer.
- Use only the type of power source indicated on the printer's label.
- Avoid using outlets on the same circuit as photocopiers or air control systems that regularly switch on and off.
- Avoid electrical outlets controlled by wall switches or automatic timers.
- Keep the entire computer system away from potential sources of electromagnetic interference, such as loudspeakers or the base units of cordless telephones.
- The power-supply cords should be placed to avoid abrasions, cuts, fraying, crimping, and kinking. Do not place objects on top of the power-supply cords and do not allow the power-supply cords to be stepped on or run over. Be particularly careful to keep all the power-supply cords straight at the ends and the points where they enter and leave the transformer.
- If you use an extension cord with the printer, make sure that the total ampere rating of the devices plugged into the extension cord does not exceed the cord's ampere rating. Also, make sure that the total ampere rating of all devices plugged into the wall outlet does not exceed the wall outlet's ampere rating.
- If you plan to use the printer in Germany, the building installation must be protected by a 10 or 16 amp circuit breaker to provide adequate short-circuit protection and over-current protection for the printer.
- When connecting the printer to a computer or other device with a cable, ensure the correct orientation of the connectors. Each connector has only one correct orientation. Inserting a connector in the wrong orientation may damage both devices connected by the cable.
- Place the printer on a flat, stable surface that extends beyond the base of the printer in all directions. The printer will not operate properly if it is tilted at an angle.
- Allow space above the printer so that you can fully raise the document cover.
- Leave enough space in front of the printer for the paper to be fully ejected.
- Avoid places subject to rapid changes in temperature and humidity. Also, keep the printer away from direct sunlight, strong light, or heat sources.

Advisories and Warnings for Using the Printer

- Do not insert objects through the slots in the printer.
- Do not put your hand inside the printer during printing.
- Do not touch the white flat cable inside the printer.
- Do not use aerosol products that contain flammable gases inside or around the printer. Doing so may cause fire.
- Do not move the print head by hand; otherwise, you may damage the printer.
- Be careful not to trap your fingers when closing the scanner unit.
- Do not press too hard on the scanner glass when placing the originals.
- Always turn the printer off using the  button. Do not unplug the printer or turn off the power at the outlet until the  light stops flashing.
- If you are not going to use the printer for a long period, be sure to unplug the power cord from the electrical outlet.

Advisories and Warnings for Connecting to the Internet

Do not connect this product to the Internet directly. Connect it in a network protected by a router or firewall.

Advisories and Warnings for Using the Printer with a Wireless Connection

- Radio waves from this printer may negatively affect the operation of medical electronic equipment, causing them to malfunction. When using this printer inside medical facilities or near medical equipment, follow directions from the authorized personnel representing the medical facilities, and follow all posted warnings and directions on the medical equipment.
- Radio waves from this printer may negatively affect the operation of automatically controlled devices such as automatic doors or fire alarms, and could lead to accidents due to malfunction. When using this printer near automatically controlled devices, follow all posted warnings and directions on these devices.

Advisories and Warnings for Transporting or Storing the Printer

- When storing or transporting the printer, avoid tilting it, placing it vertically, or turning it upside down; otherwise ink may leak.
- Before transporting the printer, make sure that the print head is in the home (far right) position.

Protecting Your Personal Information

If you give the printer to someone else or dispose of it, restore the default network settings by using the printer's buttons.

Related Information

- ➔ [“Buttons and Functions” on page 19](#)

Part Names and Functions

Front.	16
Inside.	16
Rear.	17

Front

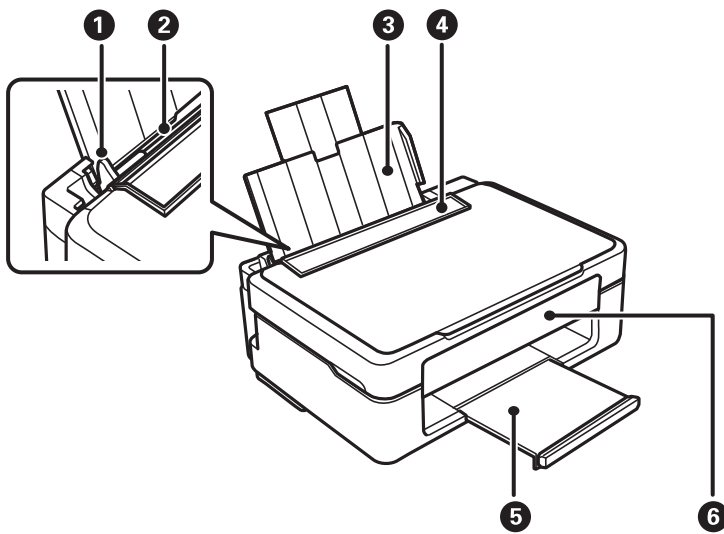

①	Edge guide	Feeds the paper straight into the printer. Slide to the edges of the paper.
②	Rear paper feeder	Loads paper.
③	Paper support	Supports loaded paper.
④	Feeder guard	Prevents foreign substance from entering the printer. Usually keep this guard closed.
⑤	Output tray	Holds the ejected paper.
⑥	Control panel	Operates the printer.

Inside

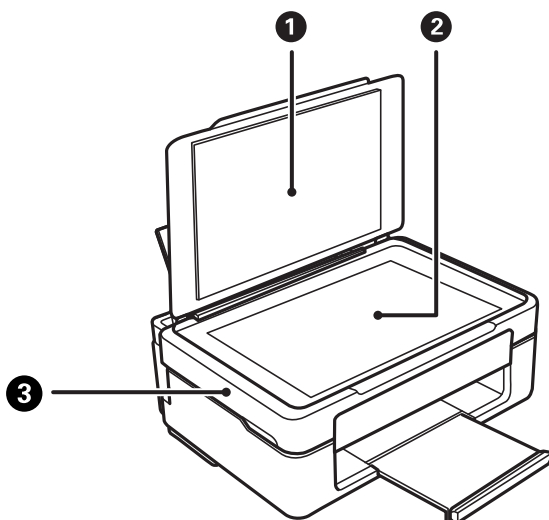

①	Document cover	Blocks external light while scanning.
②	Scanner glass	Place the originals.
③	Scanner unit	Scans placed originals. Open when replacing ink cartridges or removing jammed paper inside the printer.

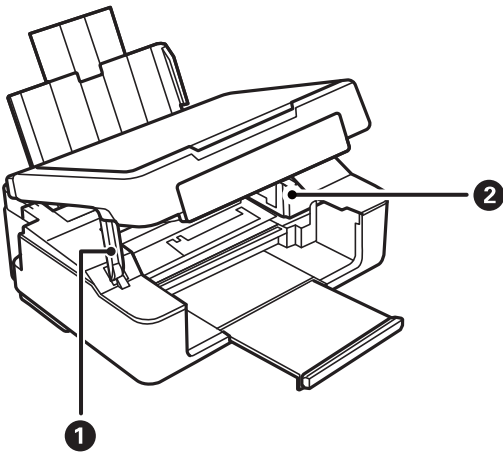

①	Scanner unit support	Supports the scanner unit.
②	Ink cartridge holder	Install the ink cartridges. Ink is ejected from the print head nozzles underneath.

Rear

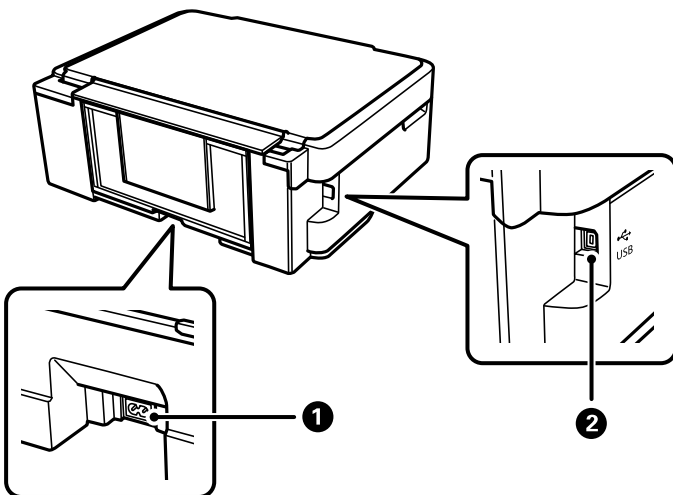

①	AC inlet	Connects the power cord.
②	USB port	Connects a USB cable to connect with a computer.





Guide to the Control Panel

Buttons and Functions.	19
Checking Lights and Printer Status.	20

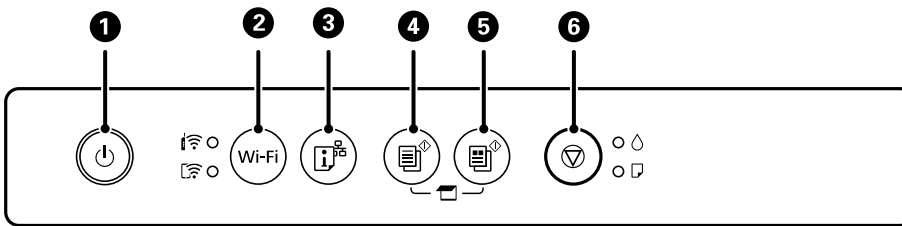









Buttons and Functions

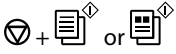





1	<p>Turns the printer on or off.</p> <p>Unplug the power cord after checking that the power light is off.</p>
2	<p>When a network error occurs, pressing this button cancels the error. Hold this button down for more than five seconds to perform Wi-Fi auto setup using the WPS push button.</p>
3	<p>Prints a network connection report allowing you to determine the causes of any problems you may have using the printer on a network. If you need more detailed network settings and connection status, hold this button down for at least five seconds to print a network status sheet.</p>
4	<p>Starts monochrome copying on A4 size plain paper. To increase the number of copies (by up to 20 copies), press this button within one second intervals.</p>
5	<p>Starts color copying on A4 size plain paper. To increase the number of copies (by up to 20 copies), press this button within one second intervals.</p>
6	<p>Stops the current operation.</p> <p>Hold this button down for five seconds until the  button flashes to run print head cleaning.</p> <p>When the  light turns on, press this button to replace the ink cartridges. When the  light flashes or turns off, hold this button down for 10 seconds until the ink cartridge holder starts moving to replace the cartridge.</p>

Functions of Button Combinations

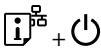
Additional functions are available with different combinations of buttons.

	<p>Scan to Computer</p> <p>Press the  and  buttons simultaneously to run software on a USB-connected computer and scan as a PDF file.</p>
	<p>Copy in Draft Mode</p> <p>Press the  and the  or  buttons simultaneously to copy in draft mode.</p> <p>For users in Western Europe, the draft mode is not available.</p>
Wi-Fi + 	<p>PIN Code Setup (WPS)</p> <p>Hold down the Wi-Fi and  buttons simultaneously to start PIN Code Setup (WPS).</p>
Wi-Fi + 	<p>Wi-Fi Direct (Simple AP) Setup</p> <p>Hold down the Wi-Fi and  buttons simultaneously to start Wi-Fi Direct (Simple AP) Setup.</p>

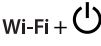
	<p>Restore Default Network Settings</p> <p>Turn the printer on while holding down the  button to restore the default network settings. When the network settings are restored, the printer turns on and the network status lights flash alternately.</p>
	<p>Print Nozzle Check Pattern</p> <p>Turn the printer on while holding down the  button to print the nozzle check pattern.</p>
	<p>Disable Network Service</p> <p>Turn the printer on while holding down the Wi-Fi button to disable Epson Connect settings.</p>

Related Information

- ➔ [“Making Wi-Fi Settings by PIN Code Setup \(WPS\)” on page 79](#)
- ➔ [“Connecting to Devices Using Wi-Fi Direct” on page 87](#)
- ➔ [“Checking and Cleaning the Print Head” on page 62](#)

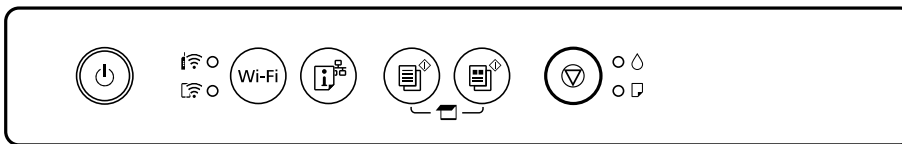

Checking Lights and Printer Status

Lights on the control panel indicates the status of the printer.



Normal Status

 : On



Light	Status
	The printer is connected to a wireless (Wi-Fi) network.
	The printer is connected to a network in Wi-Fi Direct (Simple AP) mode.

















Error Status







When an error occurs, the light turns on or flashes. Details of the error are displayed on the computer screen.

 /  : On

 /  : Flashing

Light	Status	Solutions
 	Wi-Fi connection error has occurred.	Press the Wi-Fi button to clear the error and try again.

Light	Status	Solutions
	An ink cartridge is expended or there is insufficient ink in the cartridge to charge the ink.	To ensure you receive premium print quality and to help protect your print head, a variable ink safety reserve remains in the cartridge when your printer indicates it is time to replace the cartridge. Replace with a new ink cartridge.
	An ink cartridge is not installed.	Install the ink cartridge.
	An ink cartridge has not been recognized.	Press the ink cartridge down firmly.
	An unsupported ink cartridge has been installed.	Install an ink cartridge that is supported by this printer. You cannot use the cartridges that came with your printer for replacement.
	An ink cartridge is nearly expended. You can print until the  light turns on.	Prepare a new ink cartridge. You can check the ink levels from the computer.
	No paper is loaded or more than one sheet has been fed at a time.	Load paper and press the  or  button.
	Flashing slowly (at 1.25 second intervals) A paper jam has occurred.	Remove the paper and press the  or  button.
	Flashing fast (at 0.5 second intervals) Paper remains inside the printer.	Load A4 size paper in the rear paper feeder, and then press the  or  button to remove the paper inside. Load paper in the portrait direction.
 	<ul style="list-style-type: none"> <input type="checkbox"/> The printer was not turned off correctly.* <input type="checkbox"/> Because the printer was turned off while operating, the nozzles may have dried and clogged. <p>* The power was turned off with a power strip or breaker, the plug was pulled out of the outlet, or an electrical failure occurred.</p>	<ul style="list-style-type: none"> <input type="checkbox"/> After clearing the error by pressing the  or  button, we recommend performing a nozzle check. Cancel any pending print jobs. <input type="checkbox"/> To turn off the printer, make sure you press the  button.

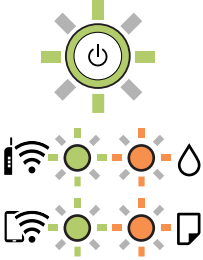
Light	Status	Solutions
	<p>Flashing simultaneously</p> <p>An ink pad is nearing or at the end of its service life.</p>	<p>The ink pads need to be replaced.</p> <p>Contact Epson or an authorised Epson service provider to replace the ink pad *1. It is not a user-serviceable part.</p> <p>When a message saying that you can continue printing is displayed on the computer, press the  or  button to continue printing. The lights stop flashing for the time being, however, they will continue to flash at regular intervals until the ink pad is replaced.</p>
	<p>Flashing alternately</p> <p>A borderless printing ink pad is nearing or at the end of its service life.</p>	<p>The borderless printing ink pad need to be replaced.</p> <p>Contact Epson or an authorised Epson service provider to replace the ink pad *2. It is not a user-serviceable part.</p> <p>When a message saying that you can continue printing is displayed on the computer, press the  or  button to continue printing. The lights stop flashing for the time being, however, they will continue to flash at regular intervals until the ink pad is replaced.</p> <p>Borderless printing is not available, but printing with a border is available.</p>
	<p>The printer has started in recovery mode because the firmware update failed.</p>	<p>Follow the steps below to try to update the firmware again.</p> <ol style="list-style-type: none"> 1. Connect the computer and the printer with a USB cable. (During recovery mode, you cannot update the firmware over a network connection.) 2. Visit your local Epson website for further instructions.
	<p>A printer error has occurred.</p>	<p>Open the scanner unit and remove any paper or protective material inside the printer. Turn the power off and on again.</p> <p>If the error continues to occur after turning the power off and on again, contact Epson support.</p>

*1 In some print cycles a very small amount of surplus ink may be collected in the ink pad. To prevent ink leakage from the pad, the printer is designed to stop printing when the pad has reached its limit. Whether and how often this is required will vary according to the number of pages you print, the type of material that you print and the number of cleaning cycles that the printer performs. The need for replacement of the pad does not mean that your printer has ceased to operate in accordance with its specifications. The printer will advise you when the pad requires replacing and this can only be performed by an authorised Epson Service provider. The Epson warranty does not cover the cost of this replacement.

*2 In some print cycles a very small amount of surplus ink may be collected in the ink pad. To prevent ink leakage from the pad, the product is designed to stop printing when the pad has reached its limit. Whether and how often

this is required will vary according to the number of pages you print using the borderless print option. The need for replacement of the pad does not mean that your printer has ceased to operate in accordance with its specifications. The printer will advise you when the pad requires replacing and this can only be performed by an authorised Epson Service provider. The Epson warranty does not cover the cost of this replacement.

Related Information

- ➔ [“Removing Jammed Paper” on page 124](#)
- ➔ [“Contacting Epson Support” on page 163](#)

Loading Paper

Paper Handling Precautions.	25
Loading Papers.	26
Loading Various Paper.	28

Paper Handling Precautions

- ❑ Read the instruction sheets supplied with the paper.
- ❑ To achieve high-quality printouts with genuine Epson paper, use the paper in the environment stated on the sheets supplied with the paper.
- ❑ Fan and align the edges of the paper before loading. Do not fan or curl photo paper. Doing so may damage the printable side.

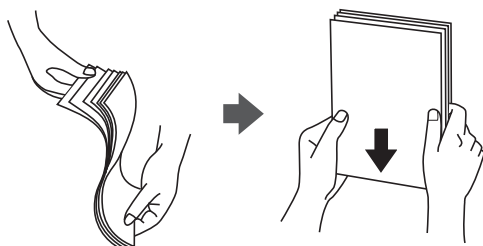

- ❑ If the paper is curled, flatten it or curl it slightly in the opposite direction before loading. Printing on curled paper may cause paper jams and smears on the printout.

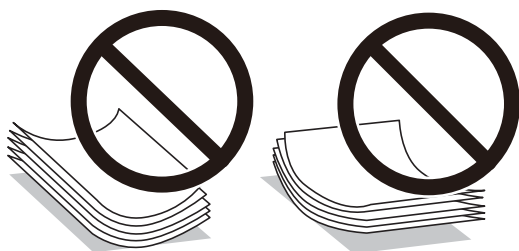

- ❑ Paper feed problems may occur frequently for manual 2-sided printing when printing on one side of pre-printed paper. Reduce the number of sheets to half or less, or load one sheet of paper at a time if paper jams continue.
- ❑ Fan and align the edges of the envelopes before loading. When the stacked envelopes are puffed up with air, press them down to flatten them before loading.



Related Information

- ➔ [“Available Paper and Capacities” on page 147](#)
- ➔ [“Unavailable Paper Types” on page 149](#)

List of Paper Types

To obtain optimum printing results, select the paper type that suits the paper.

Media Name	Media Type
	Printer Driver, Smart device*
Epson Bright White Ink Jet Paper Epson Business Paper	Plain paper
Epson Ultra Glossy Photo Paper	Epson Ultra Glossy
Epson Premium Glossy Photo Paper	Epson Premium Glossy
Epson Premium Semigloss Photo Paper	Epson Premium Semigloss
Epson Photo Paper Glossy	Photo Paper Glossy
Epson Matte Paper-Heavyweight	Epson Matte
Epson Photo Quality Ink Jet Paper Epson Photo Quality Self Adhesive Sheets	Epson Photo Quality Ink Jet

* For smart devices, these media types can be selected when printing using Epson Smart Panel.

Loading Papers

Loading Paper in the Rear Paper Feeder

1. Open the feeder guard, extend the paper support, and then tilt it backwards.

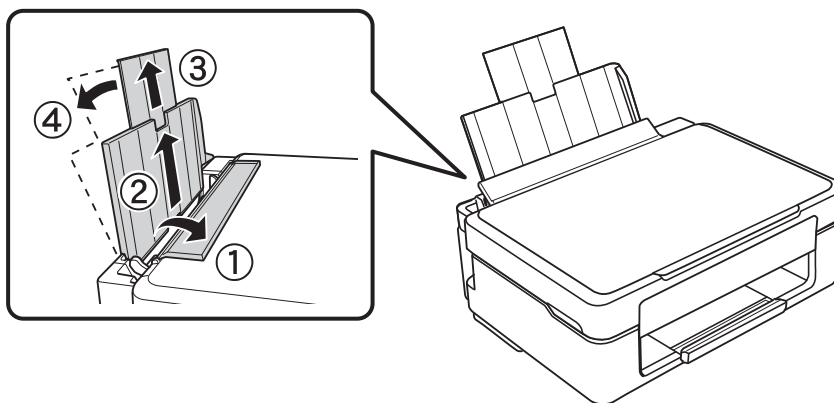

2. Slide the edge guide to the left.

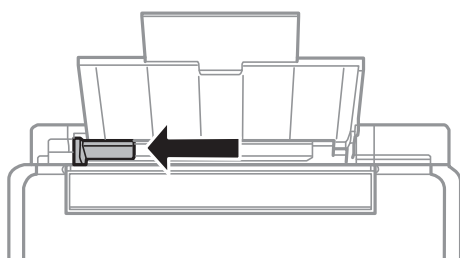

3. Load paper vertically along the right side of the rear paper feeder with the printable side facing up.

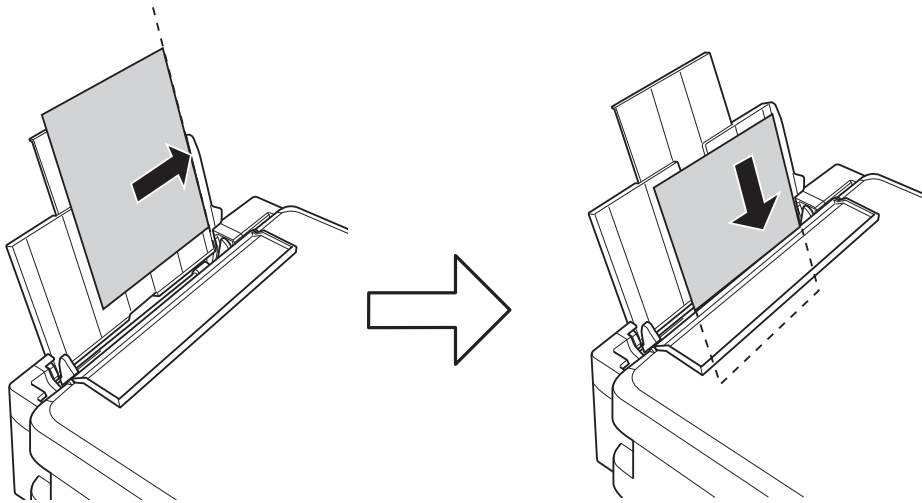

! **Important:**

Do not load more than the maximum number of sheets specified for the paper. For plain paper, do not load above the line indicated by the triangle symbol on the edge guide.

4. Slide the edge guide to the edge of the paper, and then close the feeder guard.

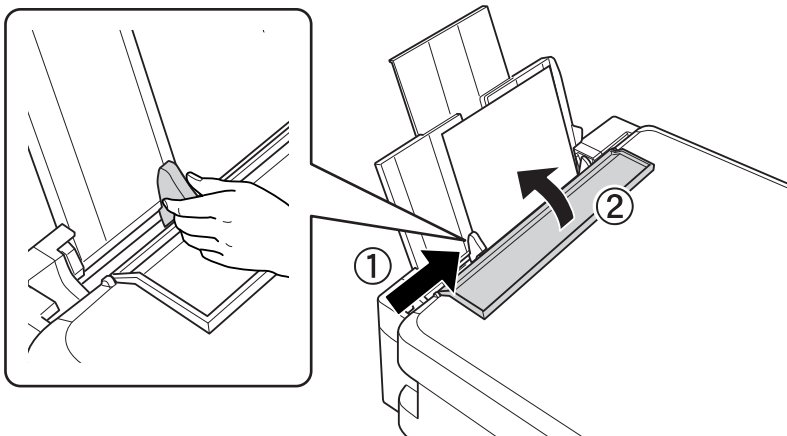

5. Slide out the output tray.

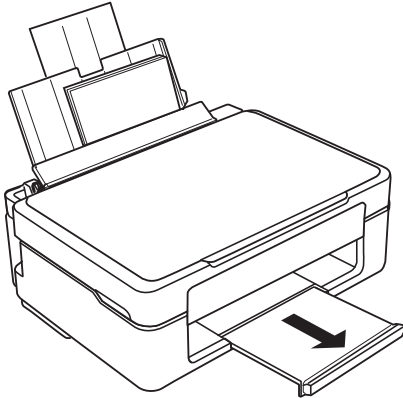

Note:

Return the remaining paper to its package. If you leave it in the printer, the paper may curl or the print quality may decline.

Loading Various Paper

Loading Envelopes

Load envelopes along the right side of the rear paper feeder, short edge first with the flap facing down, and slide the edge guide to the edge of the envelopes.

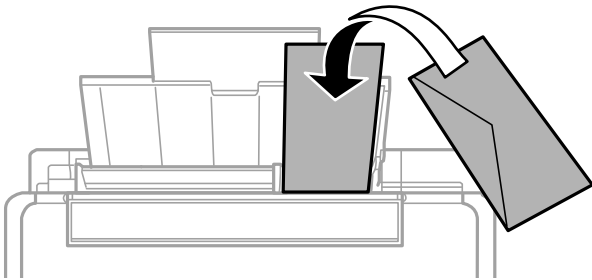

Related Information

- ➔ [“Available Paper and Capacities” on page 147](#)
- ➔ [“Unavailable Paper Types” on page 149](#)

Loading Pre-punched Paper

Load paper along the right side of the rear paper feeder with the printable side facing up.

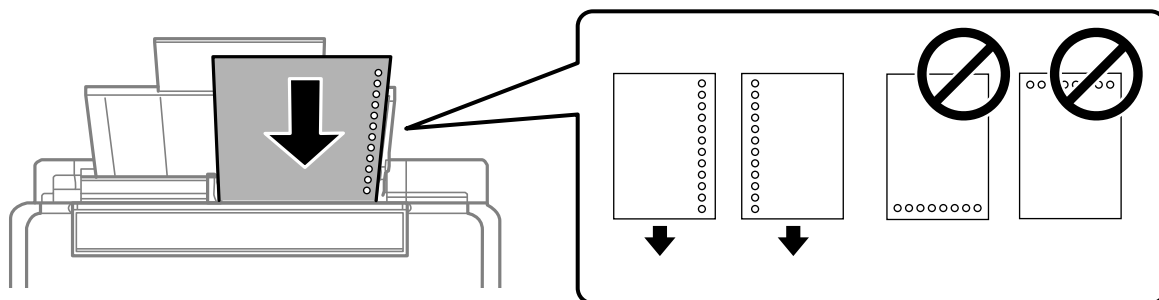

- Load a single sheet of defined size plain paper with binding holes at the left or right.
- Adjust the print position of your file to avoid printing over the holes.

Related Information

- ➔ [“Available Paper and Capacities” on page 147](#)
- ➔ [“Unavailable Paper Types” on page 149](#)

Loading Long Papers

When loading paper longer than legal size, store the paper support, and then flatten the leading edge of the paper.

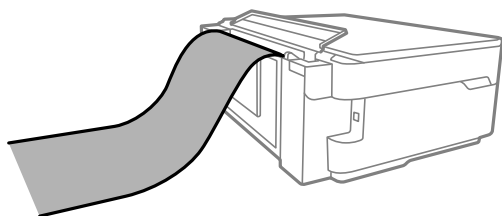

- Make sure the end of the paper is cut perpendicularly. A diagonal cut may cause paper feed problems.
- Long paper cannot be held in the output tray. Prepare a box and so on to make sure that paper does not fall on the floor.
- Do not touch paper that is being fed or ejected. It could injure your hand or cause print quality to decline.

Related Information

- ➔ [“Available Paper and Capacities” on page 147](#)
- ➔ [“Unavailable Paper Types” on page 149](#)



Placing Originals

Placing Originals on the Scanner Glass.31

Placing Originals on the Scanner Glass

1. Open the document cover.

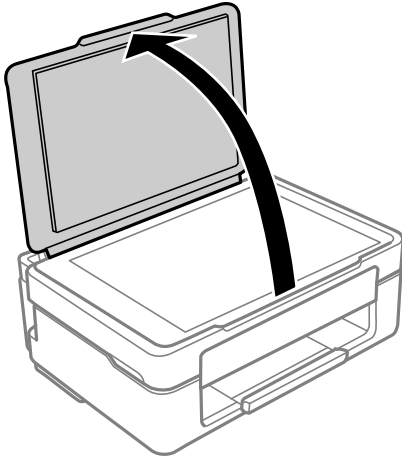

2. Remove any dust or stains on the surface of the scanner glass using a soft, dry, clean cloth.

Note:

If there is any trash or dirt on the scanner glass, the scanning range may expand to include it, so the image of the original may be displaced or reduced.

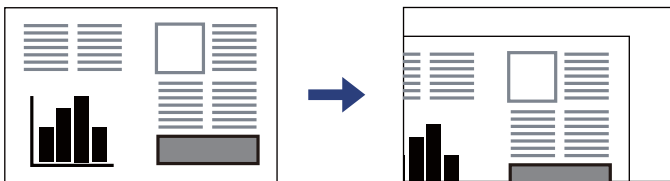

3. Place the original face-down and slide it to the corner mark.

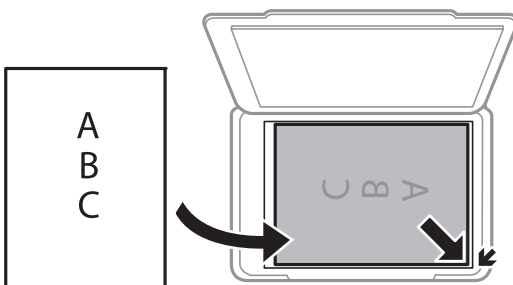

4. Close the cover gently.



Important:

- When placing bulky originals such as books, prevent exterior light from shining directly onto the scanner glass.
- Do not apply too much force to the scanner glass or the document cover. Otherwise, they may be damaged.

5. Remove the originals after scanning.

Note:

If you leave the originals on the scanner glass for a long time, they may stick to the surface of the glass.

Related Information

➔ [“Scanner Specifications” on page 155](#)

Printing

Printing Documents.	34
Printing on Envelopes.	49
Printing Photos.	50
Printing Web Pages.	50
Printing Using a Cloud Service.	51

Printing Documents

Printing from a Computer

This section explains how to print a document from your computer using Windows as an example. On Mac OS, the procedure may be different or some features may not be supported.

Printing Using Easy Settings

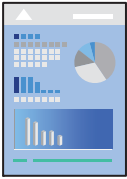

Note:

Operations may differ depending on the application. See the application's help for details.

1. Load paper in the printer.
[“Loading Paper in the Rear Paper Feeder” on page 26](#)
2. Open the file you want to print.
3. Select **Print** or **Print Setup** from the **File** menu.
4. Select your printer.

5. Select **Preferences** or **Properties** to access the printer driver window.

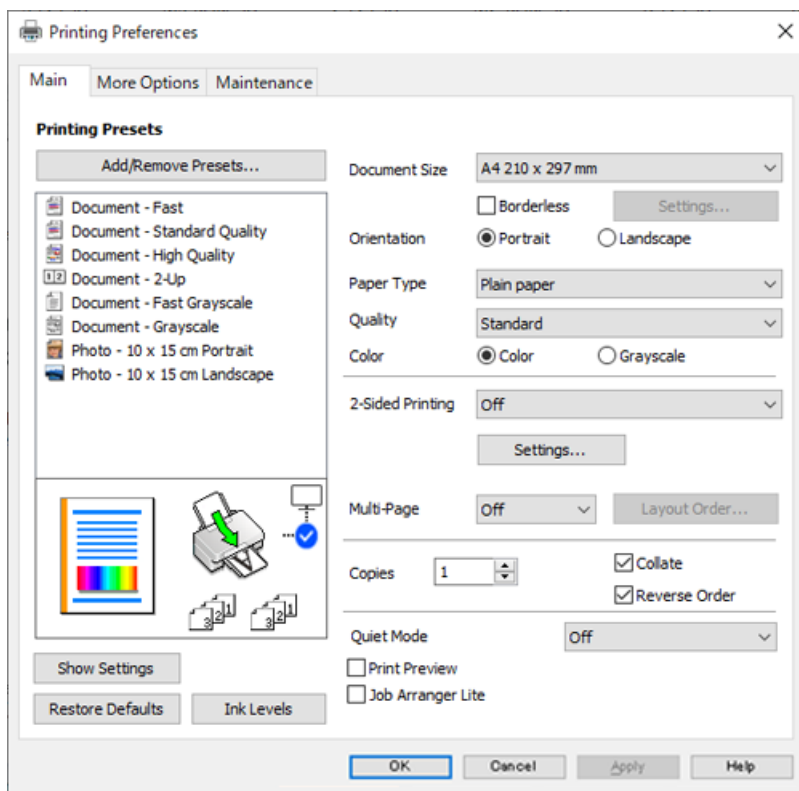

6. Change the settings as necessary.
You can see the online help for explanations of the setting items. Right-clicking an item displays **Help**.
7. Click **OK** to close the printer driver window.
8. Click **Print**.

Related Information

- ➔ [“List of Paper Types” on page 25](#)
- ➔ [“Available Paper and Capacities” on page 147](#)

Adding Printing Presets for Easy Printing

If you create your own preset of frequently used print settings on the printer driver, you can print easily by selecting the preset from the list.

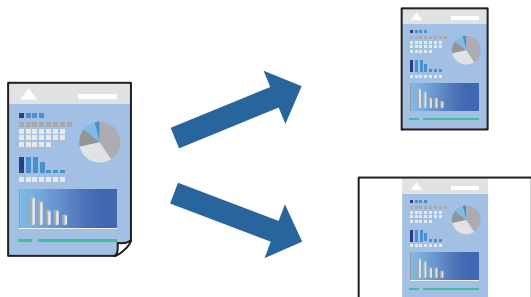

1. On the printer driver's **Main** or **More Options** tab, set each item (such as **Document Size** and **Paper Type**).
2. Click **Add/Remove Presets** in **Printing Presets**.
3. Enter a **Name** and, if necessary, enter a comment.
4. Click **Save**.

Note:

To delete an added preset, click **Add/Remove Presets**, select the preset name you want to delete from the list, and then delete it.

5. Click **Print**.

The next time you want to print using the same settings, select the registered setting name from **Printing Presets**, and click **OK**.

Printing on 2-Sides

You can use either of the following methods to print on both sides of the paper.

- Automatic 2-sided printing
- Manual 2-sided printing

When the printer has finished printing the first side, flip the paper over to print on the other side.

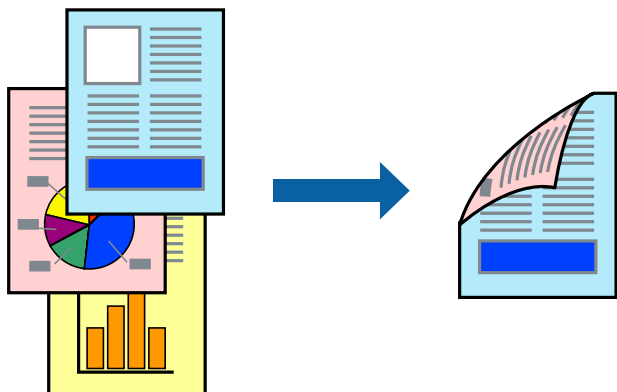

Note:

This feature is not available for borderless printing.

Access the printer driver, and then make the following settings.

Main tab > **2-Sided Printing**

Related Information

- ➔ [“Paper for 2-Sided Printing” on page 149](#)
- ➔ [“Cannot Perform Manual 2-sided Printing \(Windows\)” on page 143](#)

Printing a Booklet

You can also print a booklet that can be created by re-ordering the pages and folding the printout.

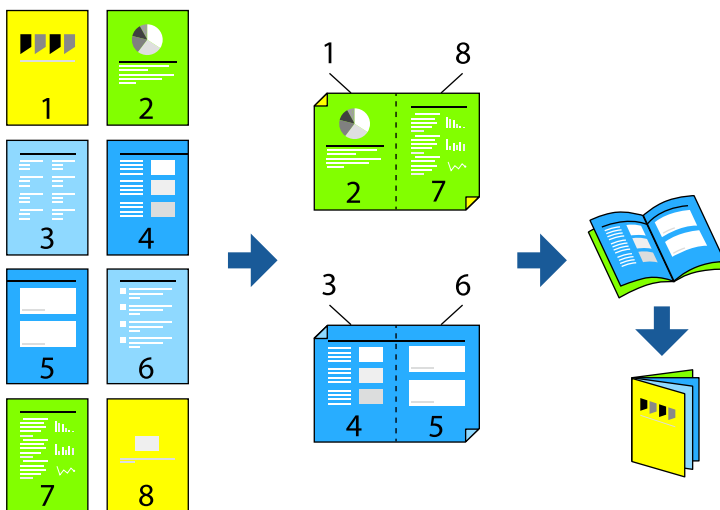

Note:

This feature is not available with borderless printing.

Access the printer driver, and then make the following settings.

On the **Main** tab, select the 2-side printing method from **2-Sided Printing**, and then select **Settings** > **Booklet**.

Related Information

- ➔ [“Paper for 2-Sided Printing” on page 149](#)
- ➔ [“Cannot Perform Manual 2-sided Printing \(Windows\)” on page 143](#)

Printing Several Pages on One Sheet

You can print several pages of data on a single sheet of paper.

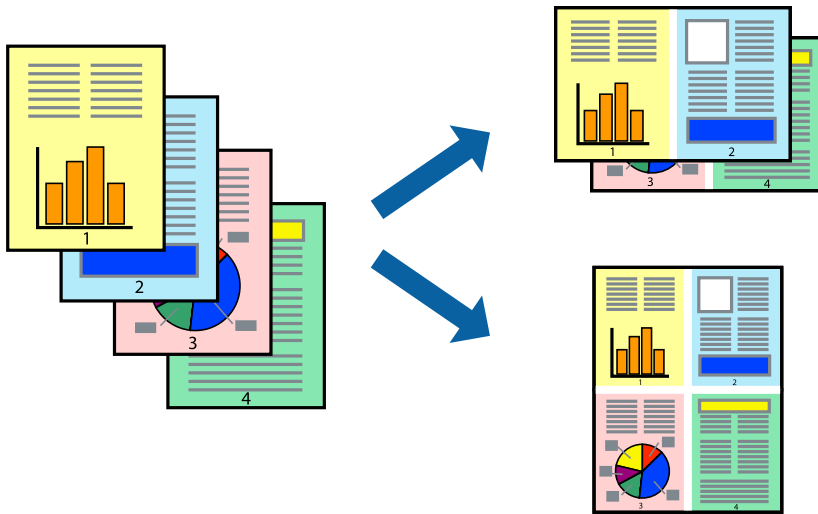

Note:

This feature is not available with borderless printing.

Access the printer driver, and then make the following settings.

Main tab > **Multi-Page** > **2-Up**, etc.

Printing to Fit the Paper Size

You can print to fit the paper size you loaded in the printer.



Note:

This feature is not available with borderless printing.

Access the printer driver, and then make the following settings.

On the **More Options** tab > **Output Paper**, select the size of the loaded paper.

Printing a Reduced or Enlarged Document at any Magnification

You can reduce or enlarge the size of a document by a specific percentage.



Note:

This feature is not available with borderless printing.

1. On the printer driver's **More Options** tab, select the document size from the **Document Size** setting.
2. Select the paper size you want to print on from the **Output Paper** setting.
3. Select **Reduce/Enlarge Document, Zoom to**, and then enter a percentage.

Printing One Image on Multiple Sheets for Enlargement (Creating a Poster)

This feature allows you to print one image on multiple sheets of paper. You can create a larger poster by taping them together.

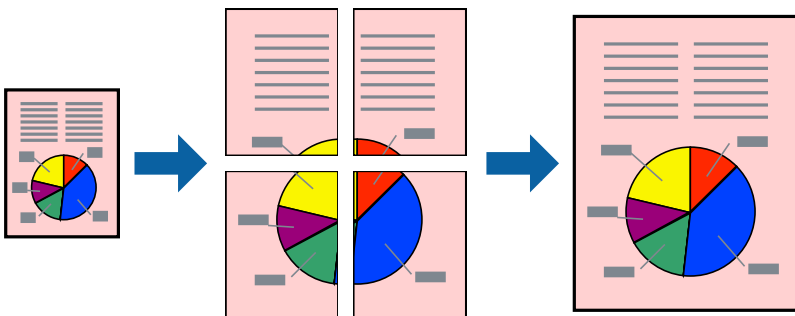

Note:

This feature is not available with 2-sided printing.

Access the printer driver, and then make the following settings.

Main tab > **Multi-Page** > **2x2 Poster**, etc.

Making Posters Using Overlapping Alignment Marks

Here is an example of how to make a poster when **2x2 Poster** is selected, and **Overlapping Alignment Marks** is selected in **Print Cutting Guides**.

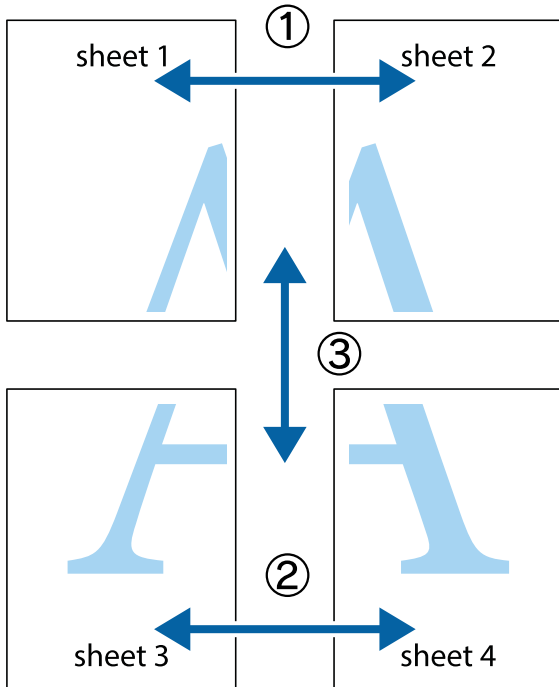

1. Prepare Sheet 1 and Sheet 2. Cut off the margins of Sheet 1 along the vertical blue line through the center of the top and bottom cross marks.

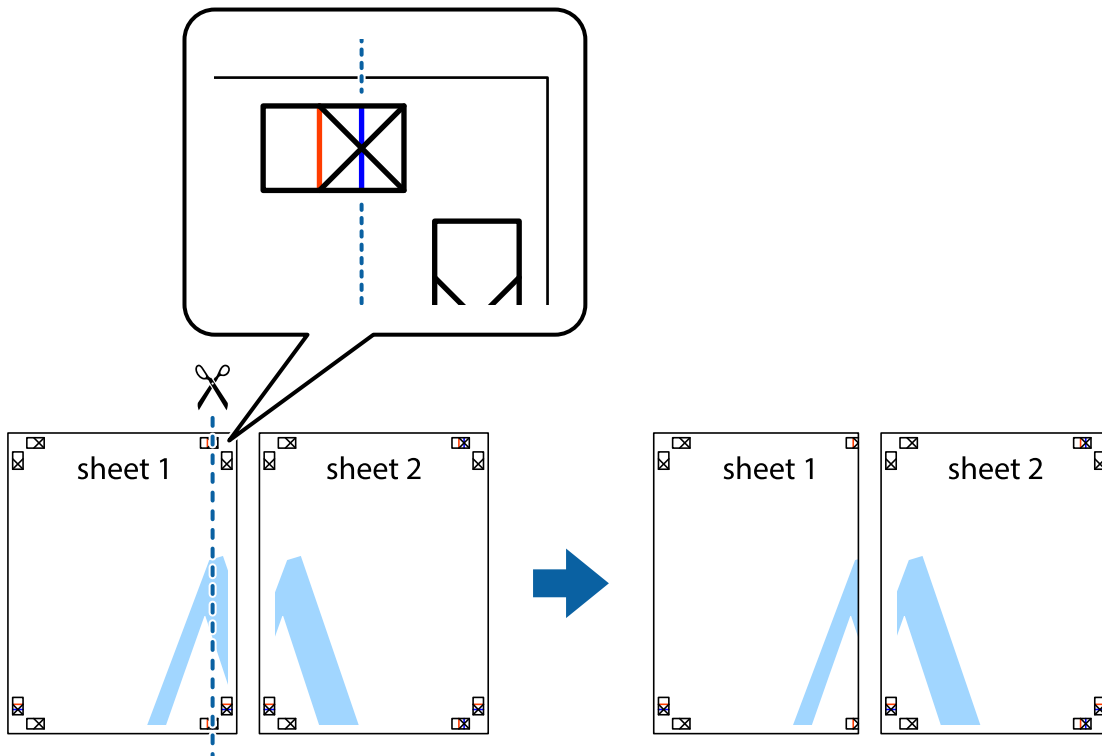

2. Place the edge of Sheet 1 on top of Sheet 2 and align the cross marks, then temporarily tape the two sheets together from the back.

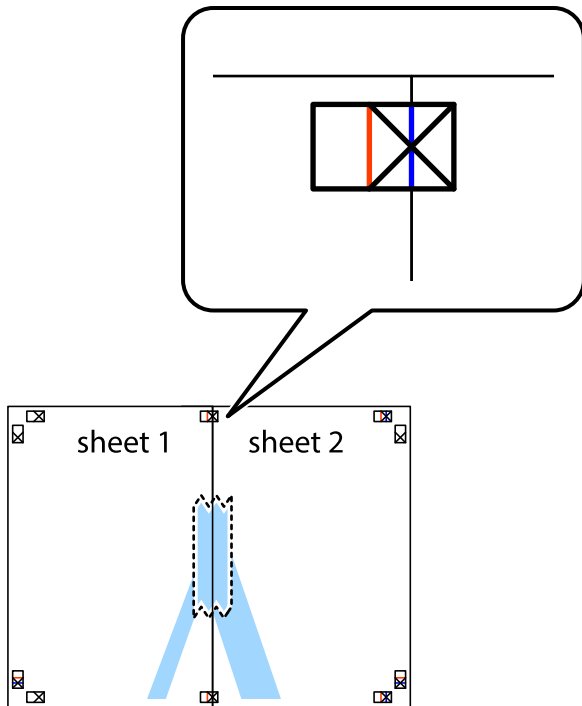

3. Cut the taped sheets in two along the vertical red line through the alignment markers (this time, the line to the left of the cross marks).

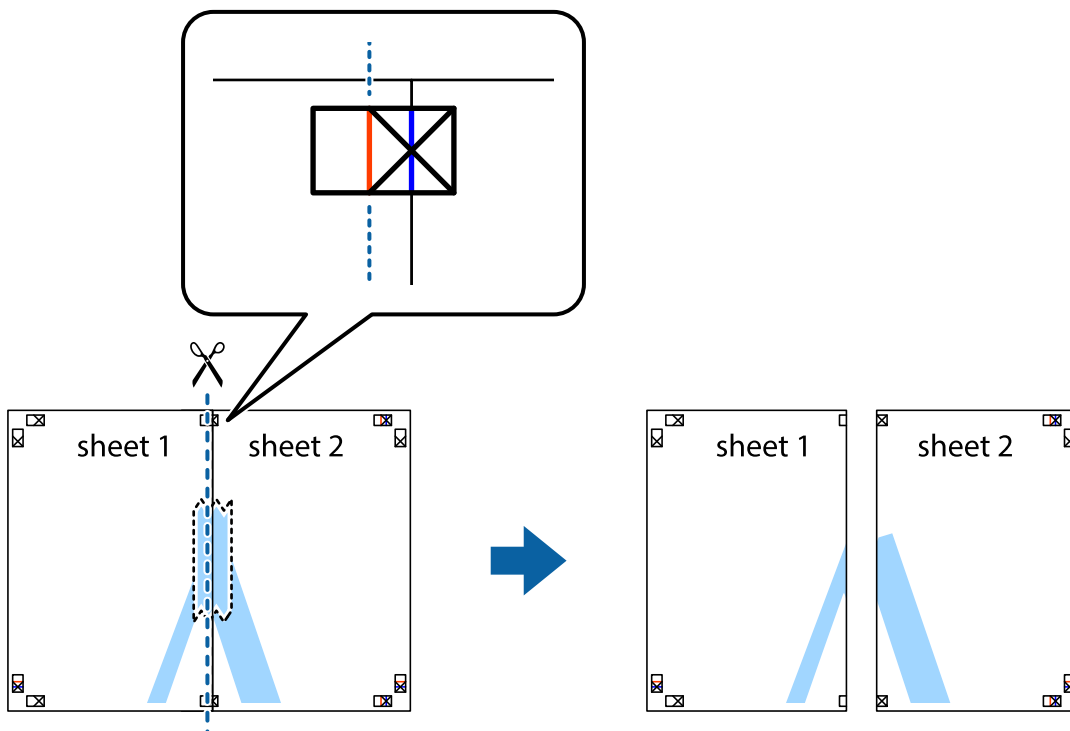

4. Tape the sheets together from the back.

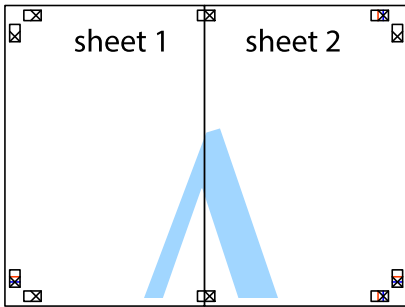

5. Repeat steps 1 to 4 to tape Sheet 3 and Sheet 4 together.
6. Cut off the margins of Sheet 1 and Sheet 2 along the horizontal blue line through the center of the left and right side cross marks.

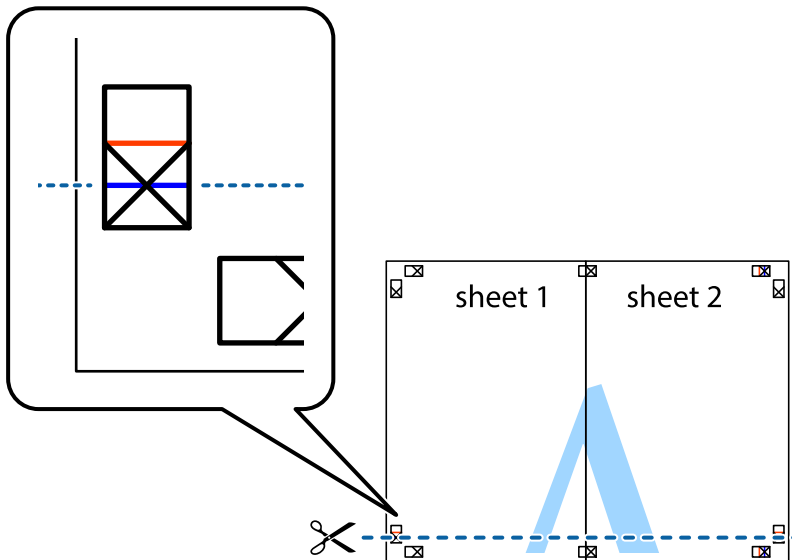

7. Place the edge of Sheet 1 and Sheet 2 on top of Sheet 3 and Sheet 4 and align the cross marks, and then temporarily tape them together from the back.

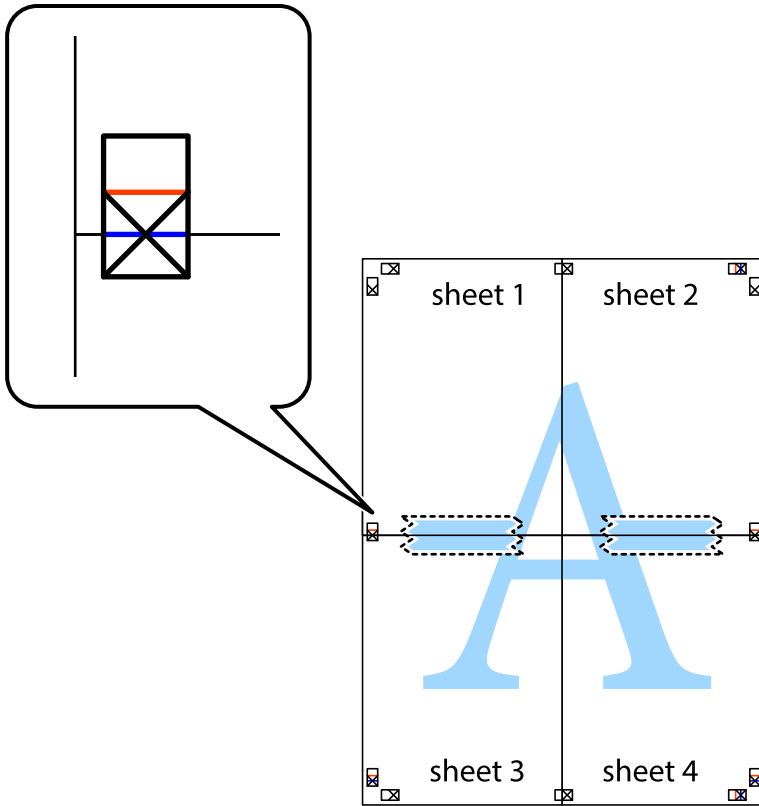

- Cut the taped sheets in two along the horizontal red line through the alignment markers (this time, the line above the cross marks).

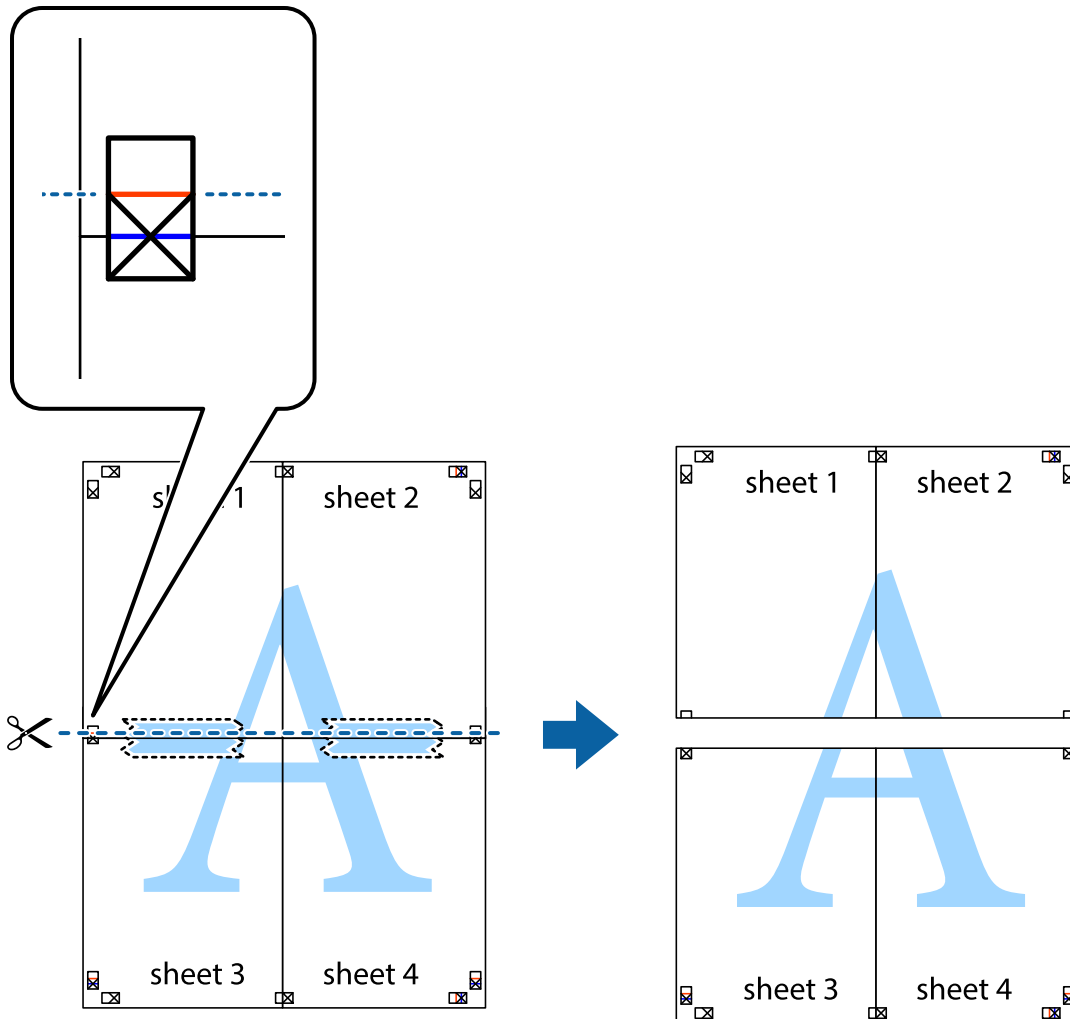

- Tape the sheets together from the back.

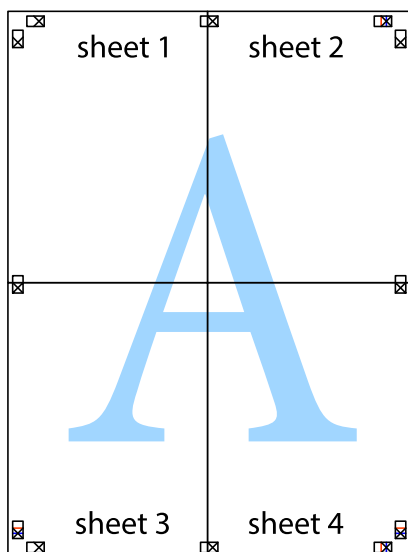

- Cut off the remaining margins along the outer guide.

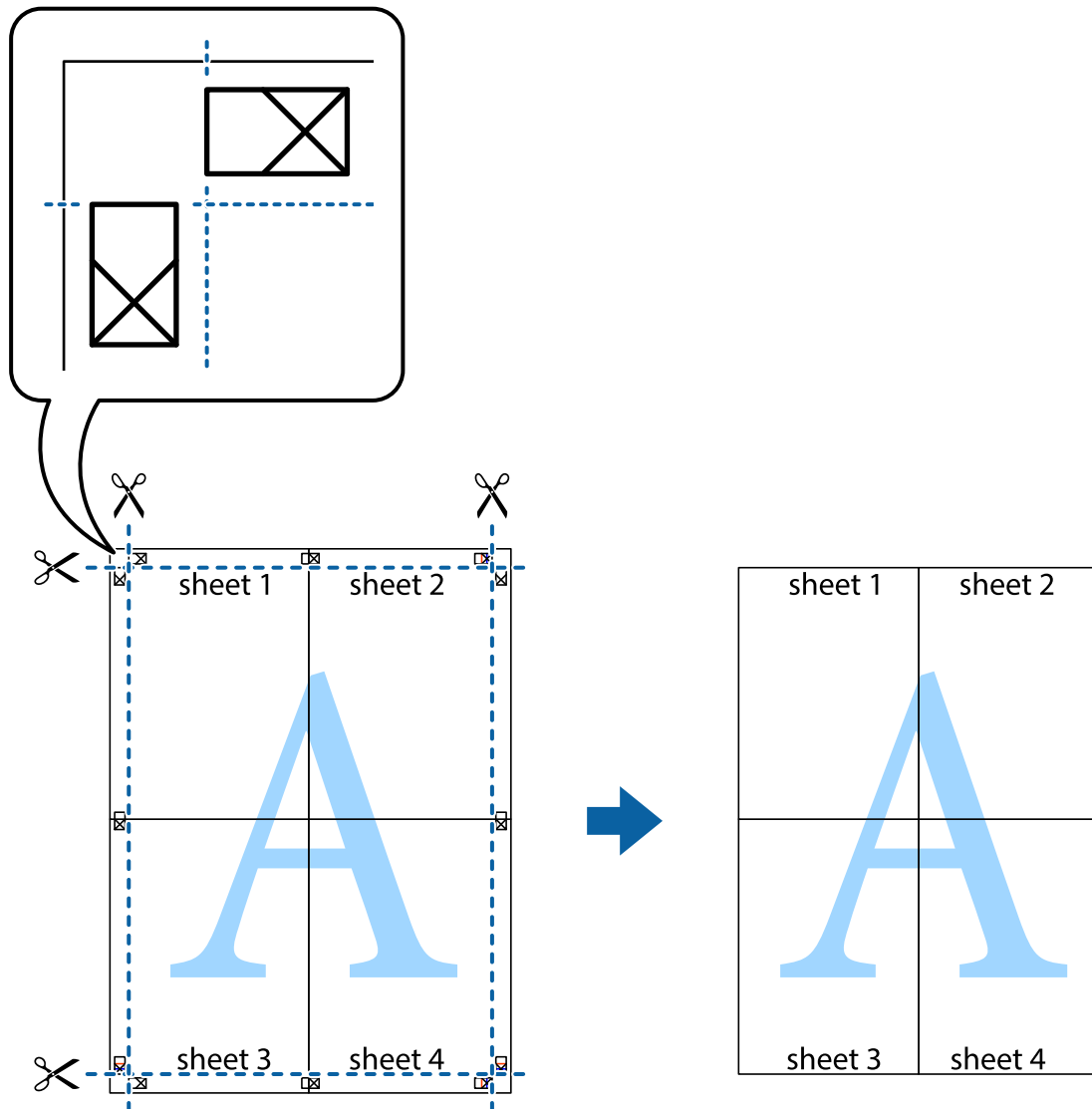

Printing with a Header and Footer

You can print information such as a user name and printing date in headers or footers.

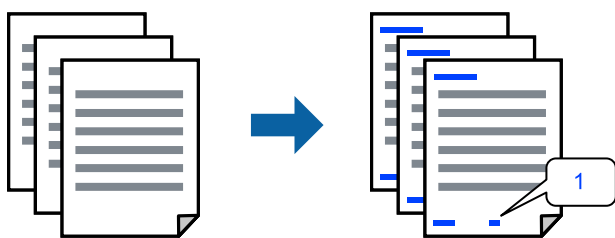

Access the printer driver, and then make the following settings.

More Options tab > **Watermark Features** > **Header/Footer**

Printing an Anti-Copy Pattern

You can print an anti-copy pattern on your printouts. When printing, the letters themselves are not printed and the entire print is screen-toned lightly. The hidden letters appear when photocopied to easily distinguish the original from the copies.



Anti-Copy Pattern is available under the following conditions:

- Paper Type: Plain paper
- Quality: Standard
- Borderless: Not selected
- Color Correction: Automatic

Access the printer driver, and then make the following settings.

More Options tab > **Watermark Features** > **Anti-Copy Pattern**

Printing Multiple Files Together

Job Arranger Lite allows you to combine several files created by different applications and print them as a single print job. You can specify the print settings for combined files, such as multi-page layout, and 2-sided printing.

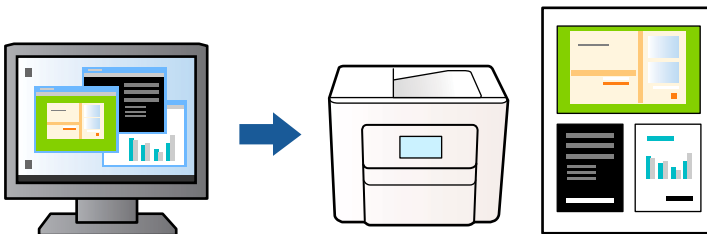

1. On the printer driver's **Main** tab, select **Job Arranger Lite**, and then click **OK**.
2. Click **Print**.
When you start printing, the Job Arranger Lite window is displayed.
3. With the Job Arranger Lite window opened, open the file that you want to combine with the current file, and then repeat the above steps.
4. When you select a print job added to Print Project in the Job Arranger Lite window, you can edit the page layout.

5. Click **Print** from the **File** menu to start printing.

Note:

If you close the Job Arranger Lite window before adding all the print data to the Print Project, the print job you are currently working on is canceled. Click **Save** from the **File** menu to save the current job. The extension of the saved files is ".ecl".

To open a Print Project, click **Job Arranger Lite** on the printer driver's **Maintenance** tab to open the Job Arranger Lite window. Next, select **Open** from the **File** menu to select the file.

Printing Using the Color Universal Print Feature

You can enhance the visibility of texts and images in printouts.

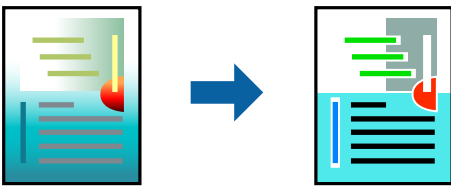

Color Universal Print is only available when the following settings are selected.

- Paper Type: Plain paper
- Quality: Standard or a higher quality
- Color: Color
- Applications: Microsoft® Office 2007 or later
- Text Size: 96 pts or smaller

Access the printer driver, and then make the following settings.

More Options tab > **Color Correction** > **Image Options** > **Color Universal Print**

Adjusting the Print Color

You can adjust the colors used in the print job. These adjustments are not applied to the original data.

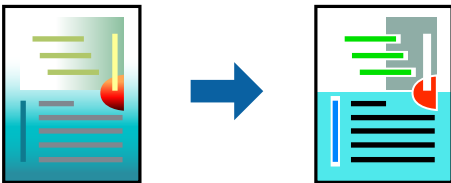

Access the printer driver, and then make the following settings.

More Options tab > **Color Correction** > **Custom** > **Advanced**, etc.

Printing to Emphasize Thin Lines

You can thicken thin lines that are too thin to print.

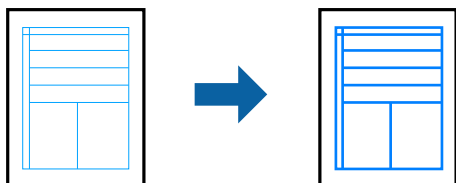

Access the printer driver, and then make the following settings.

More Options tab > **Color Correction** > **Image Options** > **Emphasize Thin Lines**

Printing Clear Bar Codes

If printed bar codes cannot be read correctly, you can print clearly using reduced ink bleeding. Only enable this feature if the bar code you printed cannot be scanned. Deblurring may not always be possible depending on the circumstances.

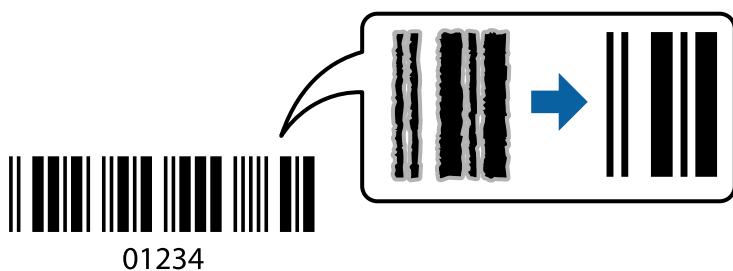

You can use this feature for the following paper types and print quality.

Plain paper, Envelope: Standard

Access the printer driver, and then make the following settings.

Maintenance tab > **Extended Settings** > **Barcode mode**

Printing Documents from Smart Devices

You can print documents from a smart device such as a smartphone or tablet.

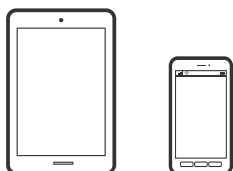

Printing Using Epson Smart Panel

Epson Smart Panel is an application that allows you to perform printer operations easily including printing, copying, or scanning from a smart device such as a smartphone or tablet. You can connect the printer and smart

device over a wireless network, check the ink levels and printer status, and check for solutions if an error occurs. You can also copy easily by registering a copy favorite.



Install Epson Smart Panel from the following URL or QR code.

<https://support.epson.net/smpdl/>



Start Epson Smart Panel, and then select the print menu on the home screen.

Printing Using Epson Print Enabler

You can wirelessly print your documents, emails, photos, and web pages right from your Android phone or tablet (Android v4.4 or later). With a few taps, your Android device will discover an Epson printer that is connected to the same wireless network.

Search for and install Epson Print Enabler from Google Play.

Go to **Settings** on your Android device, select **Printing**, and then enable Epson Print Enabler. From an Android application such as Chrome, tap the menu icon and print whatever is on the screen.

Note:

*If you do not see your printer, tap **All Printers** and select your printer.*

Printing on Envelopes

Printing on Envelopes from a Computer (Windows)

1. Load envelopes in the printer.
[“Loading Envelopes” on page 28](#)
2. Open the file you want to print.
3. Access the printer driver window.
4. Select the envelope size from **Document Size** on the **Main** tab, and then select **Envelope** from **Paper Type**.
5. Set the other items on the **Main** and **More Options** tabs as necessary, and then click **OK**.

6. Click **Print**.

Printing on Envelopes from a Computer (Mac OS)

1. Load envelopes in the printer.
[“Loading Envelopes” on page 28](#)
2. Open the file you want to print.
3. Select **Print** from the **File** menu or another command to access the print dialog.
4. Select the size as the **Paper Size** setting.
5. Select **Print Settings** from the pop-up menu.
6. Select **Envelope** as the **Media Type** setting.
7. Set the other items as necessary.
8. Click **Print**.

Printing Photos

Printing Photos from a Computer

Epson Photo+ allows you to print photos easily and finely in various layouts on photo paper or CD/DVD labels (CD/DVD label printing is only supported by some models.). See the application's help for details.

Printing Web Pages

Printing Web Pages from a Computer

Epson Photo+ allows you to display web pages, crop the specified area, and then edit and print them. See the application's help for details.

Printing Web Pages from Smart Devices

Install Epson Smart Panel from the following URL or QR code.

<https://support.epson.net/smpdl/>



Open the web page you want to print in your web browser app. Tap **Share** from the menu of the web browser application, select **Smart Panel**, and then start printing.

Printing Using a Cloud Service

By using Epson Connect service available on the Internet, you can print from your smartphone, tablet PC, or laptop, anytime and practically anywhere. To use this service, you need to register the user and the printer in Epson Connect.

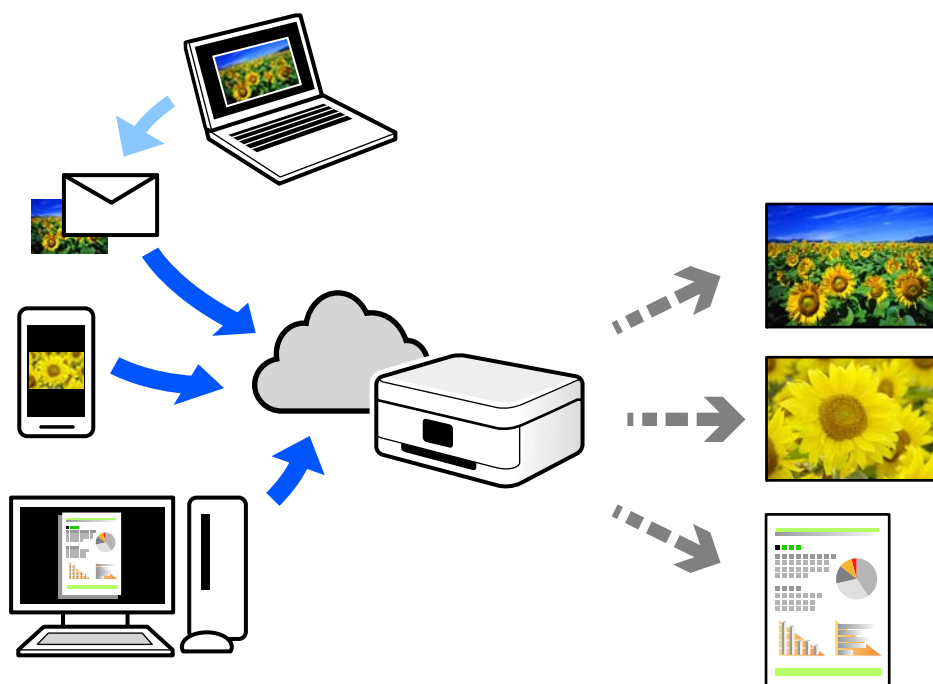

The features available on the Internet are as follows.

- Email Print
When you send an email with attachments such as documents or images to an email address assigned to the printer, you can print that email and the attachments from remote locations such as your home or office printer.
- Remote Print Driver
This is a shared driver supported by Remote Print Driver. When printing using a printer in a remote location, you can print by changing the printer on the usual applications window.

See the Epson Connect web portal for details on how to setup or print.

<https://www.epsonconnect.com/>

<http://www.epsonconnect.eu> (Europe only)





Copying

Copying Basics.	53
Making Multiple Copies.	53

Copying Basics

You can copy on A4-size paper at the same magnification. Margins with a width of 3 mm appear around the edges of the paper regardless of whether or not the original has margins around the edges of the paper. When copying originals smaller than A4-size, margins will be wider than 3 mm depending on the position where you place the original.



1. Load paper in the printer.
[“Loading Paper in the Rear Paper Feeder” on page 26](#)
2. Place the originals.
[“Placing Originals on the Scanner Glass” on page 31](#)
3. Press the  or  button.

Note:

□ *The color, size, and border of the copied image are slightly different from the original.*

Making Multiple Copies

You can make multiple copies at a time. You can specify up to 20 copies. Margins with a width of 3 mm appear around the edges of the paper.

1. Load the same number of sheets of A4-size paper as the number of copies you want to copy.
[“Loading Paper in the Rear Paper Feeder” on page 26](#)
2. Place the originals.
[“Placing Originals on the Scanner Glass” on page 31](#)
3. Press the  or  button the same number of times as the number of copies you want to make. For example, if you want to make 10 copies in color, press the  button 10 times.

Note:

Press the button within one second to change the number of copies. If the button is pressed after one second, the number of copies is set and copying starts.

Scanning

Basic Information on Scanning	55
Scanning Originals to a Computer.	57
Scanning Originals to a Smart Device.	59
Advanced Scanning.	59

Basic Information on Scanning

What is a "Scan"?

A "scan" is the process of converting the optical information of paper data (such as documents, magazine clippings, photos, handwritten illustrations, and so on) into digital image data.

You can save scanned data as a digital image such as a JPEG or PDF.

You can then print the image, send it by email, and so on.

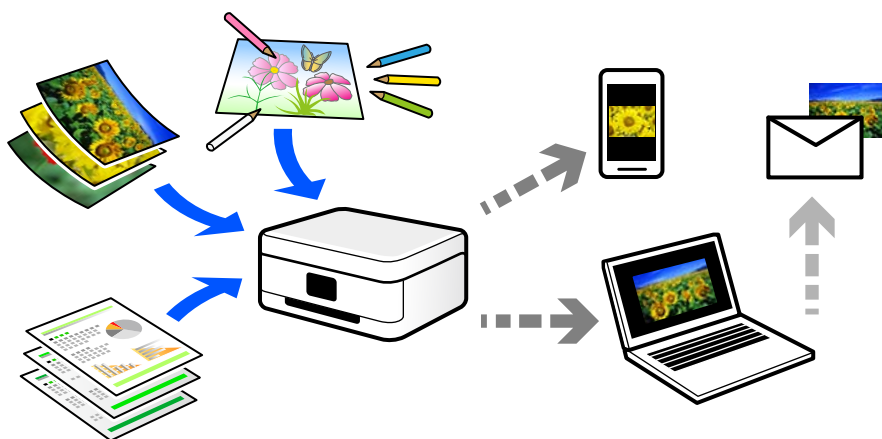

Scanning Uses

You can use scanning in a variety of ways to make your life more convenient.

- By scanning a paper document and turning it into digital data, you can read it on a computer or a smart device.
- By scanning tickets or flyers into digital data, you can dispose of the originals and reduce clutter.
- By scanning important documents, you can back them up to cloud services or another storage medium, just in case they get lost.
- You can send the scanned photos or documents to friends by email.
- By scanning hand-drawn illustrations and so on, you can share them on social media at a much higher quality than by just taking a photo on your smart device.
- By scanning your favorite pages from newspapers or magazines, you can save them and dispose of the originals.

Available Scanning Methods

You can use any of the following methods to scan using this printer.

Related Information

- ➔ ["Scanning to a Computer" on page 56](#)
- ➔ ["Scanning Directly from Smart Devices" on page 56](#)

Scanning to a Computer

There are two methods of scanning originals to a computer; scanning using the printer's control panel, and scanning from the computer.

You can scan easily from the control panel.

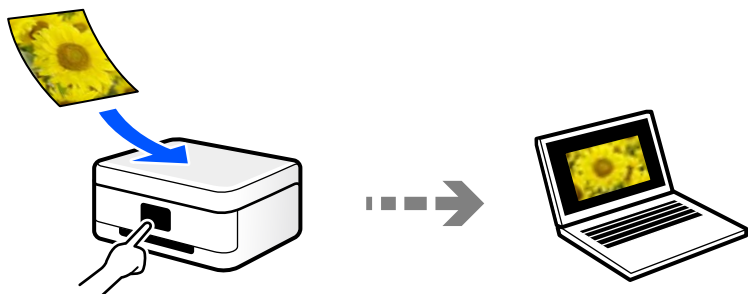

Use the scanning application Epson ScanSmart to scan from the computer. You can edit images after scanning.

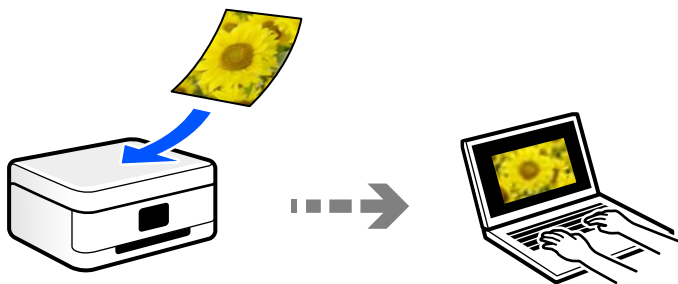

Scanning Directly from Smart Devices

You can save scanned images directly to a smart device such as a smart phone or tablet by using the Epson Smart Panel application on the smart device.

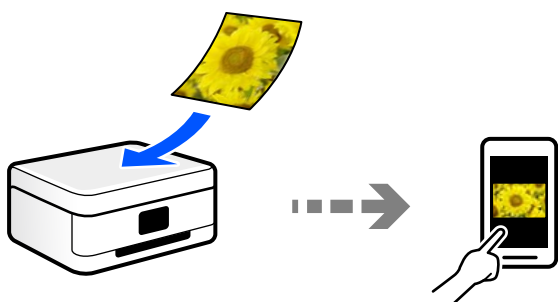

Recommended File Formats to Suit Your Purpose

Generally speaking, the JPEG format is suitable for photos while the PDF format is suitable for documents.

See the following descriptions to choose the best format for what you want to do.

File Format	Description
JPEG (.jpg)	<p>A file format that allows you to compress the data to be saved. If the compression ratio is high, the image quality declines, and you cannot convert the image back to the original quality.</p> <p>This is the standard image format for digital cameras. This format is suitable for images that have many colors.</p>
PDF (.pdf)	<p>A general file format that can be used across different operating systems and provides the same level of screen display and print result.</p> <p>You can view PDF files using dedicated PDF reading software or in Web browsers.</p>

Recommended Resolutions to Suit Your Purpose

Resolution indicates the number of pixels (smallest area of an image) for each inch (25.4 mm), and is measured in dpi (dots per inch). The advantage of increasing the resolution is that the details in the image become fine. However, it can also have the following disadvantages.

- The file size becomes large
(When you double the resolution, the file size becomes about four times larger.)
- Scanning, saving, and reading the image takes a long time
- The image becomes too large to fit the display or print on the paper

See the table and set the appropriate resolution for the purpose of your scanned image.

Purpose	Resolution (Reference)
Displaying on a computer Sending by email	Up to 200 dpi
Printing using a printer	200 to 300 dpi

Scanning Originals to a Computer

There are two methods of scanning originals to a computer; scanning using the printer's control panel, and scanning from the computer.

Related Information

- ➔ [“Scanning from the Control Panel” on page 57](#)
- ➔ [“Scanning from a Computer” on page 58](#)

Scanning from the Control Panel

You can save the scanned image to a computer which is connected to the printer with a USB cable.

Note:

To use this feature, make sure the following applications are installed on your computer.

- Epson ScanSmart (Windows 7 or later, or OS X El Capitan (10.11) or later)
- Epson Event Manager (Windows Vista/Windows XP, or OS X Yosemite (10.10)/OS X Mavericks (10.9.5))
- Epson Scan 2 (application required to use the scanner feature)

See the following to check for installed applications.

Windows 11: Click the start button, and then check the **All apps** > **Epson Software** folder > **Epson ScanSmart**, and the **EPSON** folder > **Epson Scan 2**.



Windows 10: Click the start button, and then check the **Epson Software** folder > **Epson ScanSmart**, and the **EPSON** folder > **Epson Scan 2**.

Windows 8.1/Windows 8: Enter the application name in the search charm, and then check the displayed icon.

Windows 7: Click the start button, and then select **All Programs**. Next, check the **Epson Software** folder > **Epson ScanSmart**, and the **EPSON** folder > **Epson Scan 2**.

Windows Vista/Windows XP: Click the start button, and then select **All Programs** or **Programs**. Next, check the **Epson Software** folder > **Epson Event Manager**, and the **EPSON** folder > **Epson Scan 2**.

Mac OS: Select **Go** > **Applications** > **Epson Software**.

1. Place the originals.
2. Press the  button and the  button simultaneously to start scanning.

When using Windows 7 or later, or OS X El Capitan (10.11) or later: Epson ScanSmart automatically starts on your computer, and scanning starts.

Note:

- See the *Epson ScanSmart help* for detailed operation information for the software. Click **Help** on the Epson ScanSmart screen to open the help.
- The color, size, and border of the scanned image will not be exactly the same as the original.

Scanning from a Computer

You can scan from a computer by using Epson ScanSmart.

This application allows you to scan documents and photos easily, and then save the scanned images in simple steps.

1. Place the originals.
[“Placing Originals on the Scanner Glass” on page 31](#)
2. Start Epson ScanSmart.
 - Windows 11
Click the start button, and then select **All apps** > **Epson Software** > **Epson ScanSmart**.
 - Windows 10
Click the start button, and then select **Epson Software** > **Epson ScanSmart**.
 - Windows 8.1/Windows 8
Enter the application name in the search charm, and then select the displayed icon.

Windows 7

Click the start button, and then select **All Programs > Epson Software > Epson ScanSmart**.

Mac OS

Select **Go > Applications > Epson Software > Epson ScanSmart**.

3. When the Epson ScanSmart screen is displayed, follow the on-screen instructions to scan.

Note:

Click **Help** to view detailed operation information.

Scanning Originals to a Smart Device

Note:

Before scanning, install *Epson Smart Panel* on your smart device.

1. Place the originals.
[“Placing Originals” on page 30](#)
2. Start Epson Smart Panel on your smart device.
3. Select scan menu on the home screen.
4. Follow the on-screen instructions to scan and save the images.

Advanced Scanning

Scanning Multiple Photos at the Same Time

Using Epson ScanSmart, you can scan multiple photos at the same time and save each image individually.

1. Place the photos on the scanner glass. Place them 4.5 mm (0.2 in.) away from the horizontal and vertical edges of the scanner glass, and place them at least 20 mm (0.8 in.) away from each other.

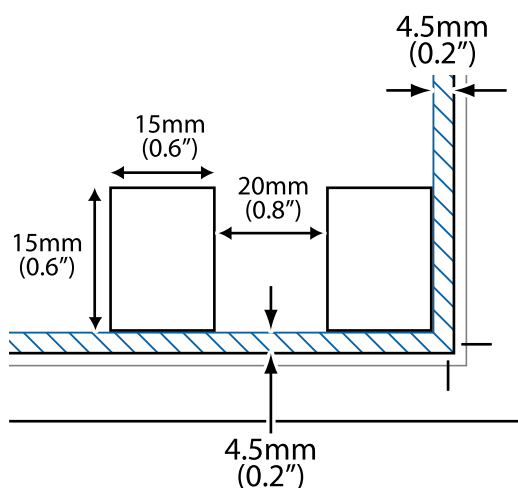

Note:

The photos should be larger than 15×15 mm (0.6×0.6 in.).

2. Start Epson ScanSmart.
 - Windows 11
Click the start button, and then select **All apps > Epson Software > Epson ScanSmart**.
 - Windows 10
Click the start button, and then select **Epson Software > Epson ScanSmart**.
 - Windows 8.1/Windows 8
Enter the application name in the search charm, and then select the displayed icon.
 - Windows 7
Click the start button, and then select **All Programs > Epson Software > Epson ScanSmart**.
 - Mac OS
Select **Go > Applications > Epson Software > Epson ScanSmart**.
3. When the Epson ScanSmart screen is displayed, follow the on-screen instructions to scan.

Scanned photos are saved as individual images.

Maintaining the Printer

Checking the Ink Levels.	62
Improving Print, Copy, and Scan Quality.	62
Cleaning the Printer.	70

Checking the Ink Levels

You can check the approximate ink levels from the computer.

Note:

You can continue printing while the ink low message is displayed. Replace the ink cartridges when required.

Related Information

- ➔ “Continue Printing Temporarily without Replacing Ink Cartridges” on page 137
- ➔ “Continue Printing to Conserve Black Ink (for Windows Only)” on page 139
- ➔ “It is Time to Replace the Ink Cartridges” on page 127

Checking the Ink Levels - Windows

1. Access the printer driver window.
2. Click **Ink Levels** on the **Main** tab.

Note:

*If EPSON Status Monitor 3 is disabled, the ink levels are not displayed. Click **Extended Settings** on the **Maintenance** tab, and then select **Enable EPSON Status Monitor 3**.*

Checking the Ink Levels (Mac OS)

1. Select **System Preferences** from the Apple menu > **Printers & Scanners** (or **Print & Scan**, **Print & Fax**), and then select the printer.
2. Click **Options & Supplies** > **Utility** > **Open Printer Utility**.
3. Click **EPSON Status Monitor**.

Improving Print, Copy, and Scan Quality

Checking and Cleaning the Print Head

 You can also watch the procedure in the Web Movie Manuals. Access the following website.



<https://support.epson.net/publist/vlink.php?code=NPD6930>

If the nozzles are clogged, the printouts become faint, there is visible banding, or unexpected colors appear. If the nozzles are severely clogged, a blank sheet will be printed. When print quality has declined, first use the nozzle check feature to check if the nozzles are clogged. If the nozzles are clogged, clean the print head.

! **Important:**

- ❑ Do not open the front cover or turn off the printer during head cleaning. If the head cleaning is incomplete, you may not be able to print.
- ❑ Head cleaning consumes ink and should not be performed more than necessary.
- ❑ When ink is low, you may not be able to clean the print head.
- ❑ If print quality has not improved after repeating nozzle check and head cleaning 3 times, wait for at least 12 hours without printing, and then run the nozzle check again and repeat the head cleaning if necessary. We recommend turning off the printer by using the  button. If print quality has still not improved, run Power Cleaning.
- ❑ To prevent the print head from drying out, do not unplug the printer while the power is on.

You can check and clean the print head by using the printer's control panel.

1. Load A4-size plain paper in the printer.
2. Press the  button to turn off the printer.
3. Turn the printer on while holding the  button down, and then release the buttons when the power light flashes.

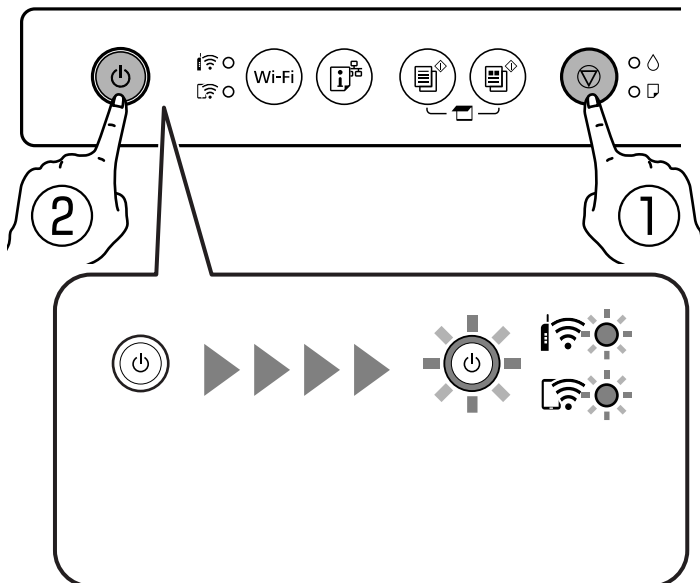

The nozzle check pattern is printed.

Note:

It may take some time to start printing the nozzle check pattern.

4. Check the printed pattern to see if the print head nozzles are clogged.

A) OK

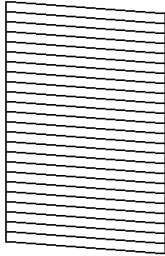

B) NG

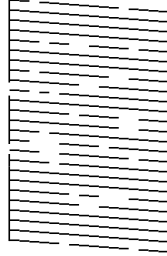

C) NG

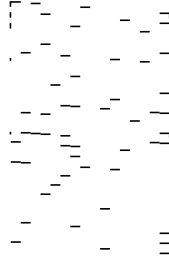

A:

All lines are printed. No further steps are needed.

B or close to B

Some nozzles are clogged. Hold the  button down for five seconds until the power light starts flashing. Print head cleaning starts.

Note:

It may take some time to start print head cleaning.

C or close to C

If most lines are missing or not printed, this indicates most nozzles are clogged. Run Power Cleaning. For details, see "Related information" below.

5. When the power light stops flashing, print a nozzle check pattern again. Repeat cleaning and printing the pattern until all lines are printed completely.

 **Important:**

If print quality has not improved after repeating nozzle check and head cleaning 3 times, wait for at least 12 hours without printing, and then run the nozzle check again and repeat the head cleaning if necessary. We recommend turning off the printer by using the  button. If print quality has still not improved, run Power Cleaning.

Related Information

➔ ["Running Power Cleaning" on page 64](#)

Running Power Cleaning

The Power Cleaning feature may improve print quality in the following cases.

- When most nozzles are clogged.
- When you have performed a nozzle check and head cleaning 3 times and waited for at least 12 hours without printing, but print quality still did not improve.

 **Important:**

The Power Cleaning uses more ink than the print head cleaning.

Related Information

➔ [“Checking and Cleaning the Print Head” on page 62](#)

Running Power Cleaning (Windows)

1. Access the printer driver window.
2. Click **Head Cleaning** on the **Maintenance** tab.
3. Select **Power Cleaning**.
4. Follow the on-screen instructions.



Important:

If print quality has not improved after running Power Cleaning, wait for at least 12 hours without printing, and then print the nozzle check pattern again. Run Cleaning or Power Cleaning again depending on the printed pattern. If quality still does not improve, contact Epson support.

Running Power Cleaning (Mac OS)

1. Select **System Preferences** from the Apple menu > **Printers & Scanners** (or **Print & Scan, Print & Fax**), and then select the printer.
2. Click **Option & Supplies** > **Utility** > **Open Printer Utility**.
3. Click **Print Head Cleaning**.
4. Select **Power Cleaning**.
5. Follow the on-screen instructions.



Important:

If print quality has not improved after running Power Cleaning, wait for at least 12 hours without printing, and then print the nozzle check pattern again. Run Cleaning or Power Cleaning again depending on the printed pattern. If quality still does not improve, contact Epson support.

Preventing nozzle clogging

Always use the power button when turning the printer on and off.

Check that the power light is off before you disconnect the power cord.

The ink itself can dry out if it is not covered. Just like placing a cap on a fountain pen or an oil pen to prevent it from drying, make sure the print head is capped properly to prevent the ink from drying.

When the power cord is unplugged or a power outage occurs while the printer is in operation, the print head may not be capped properly. If the print head is left as it is, it will dry out causing nozzles (ink outlets) to clog.

In these cases, turn the printer on and off again as soon as possible to cap the print head.

Aligning the Print Head

If you notice a misalignment of vertical lines or blurred images, align the print head.

Aligning the Print Head - Windows

1. Load A4-size plain paper in the printer.
2. Access the printer driver window.
3. Click **Print Head Alignment** on the **Maintenance** tab.
4. Follow the on-screen instructions.

Aligning the Print Head - Mac OS

1. Load A4-size plain paper in the printer.
2. Select **System Preferences** from the Apple menu > **Printers & Scanners** (or **Print & Scan, Print & Fax**), and then select the printer.
3. Click **Options & Supplies** > **Utility** > **Open Printer Utility**.
4. Click **Print Head Alignment**.
5. Follow the on-screen instructions.

Cleaning the Paper Path for Ink Smears

When the printouts are smeared or scuffed, clean the roller inside.



Important:

Do not use tissue paper to clean the inside of the printer. The print head nozzles may be clogged with lint.

1. Make sure there is no dust or stains on the scanner glass and the document cover.
2. Load A4-size plain paper in the printer.
3. Start copying without placing the original.
4. Repeat this procedure until the paper is not smeared with ink.

5. When the problem cannot be cleared after cleaning the paper path, the part inside the printer that is shown in the illustration is smeared. Turn off the printer, and then wipe off the ink using a cotton swab.

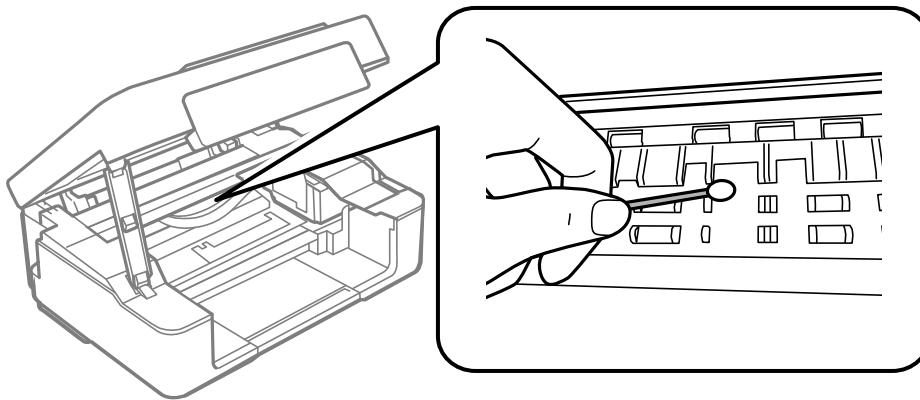

! *Important:*

- Do not use tissue paper to clean the inside of the printer. The print head nozzles may be clogged with lint.
- Do not touch the parts shown in the following illustration. Doing so may cause a malfunction.

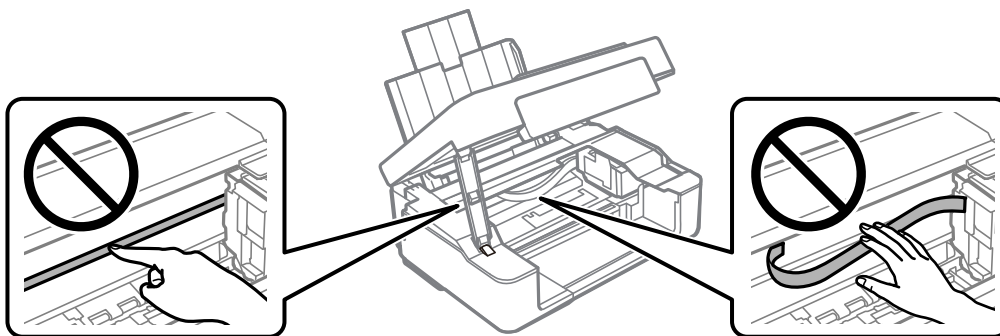

Cleaning the Scanner Glass

When the copies or scanned images are smeared, clean the scanner glass.

! *Important:*

Never use alcohol or thinner to clean the printer. These chemicals can damage the printer.

1. Open the document cover.

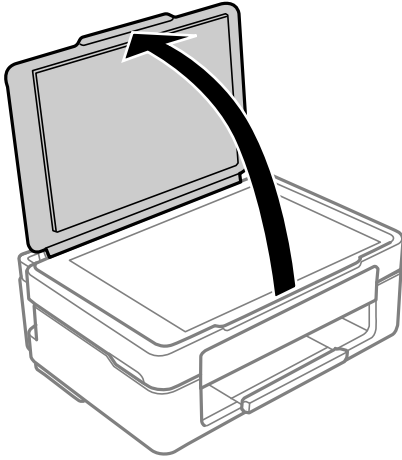

2. Use a soft, dry, clean cloth to clean the surface of the scanner glass.

! **Important:**

- If the glass surface is stained with grease or some other hard-to-remove material, use a small amount of glass cleaner and a soft cloth to remove it. Wipe off all remaining liquid.
- Do not press the glass surface too hard.
- Be careful not to scratch or damage the surface of the glass. A damaged glass surface can decrease the scan quality.

Cleaning the Translucent Film

When the printout is not improved after aligning the print head or cleaning the paper path, the translucent film inside the printer may be smeared.

Items required:

- Cotton swabs (several)
- Water with a few drops of detergent (2 to 3 drops of detergent in 1/4 cup of tap water)
- Light for checking smears

! **Important:**

Do not use cleaning liquid other than water with a few drops of detergent.

1. Turn off the printer by pressing the  button.

2. Open the scanner unit.

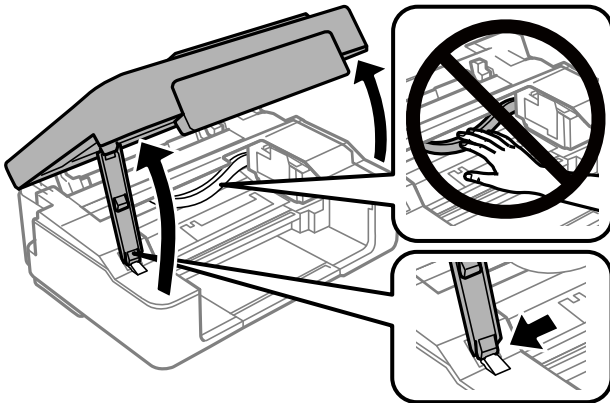

3. Check if the translucent film is smeared. Smears are easier to see if you use a light.
If there are smears (such as finger marks or grease) on the translucent film (A), go to the next step.

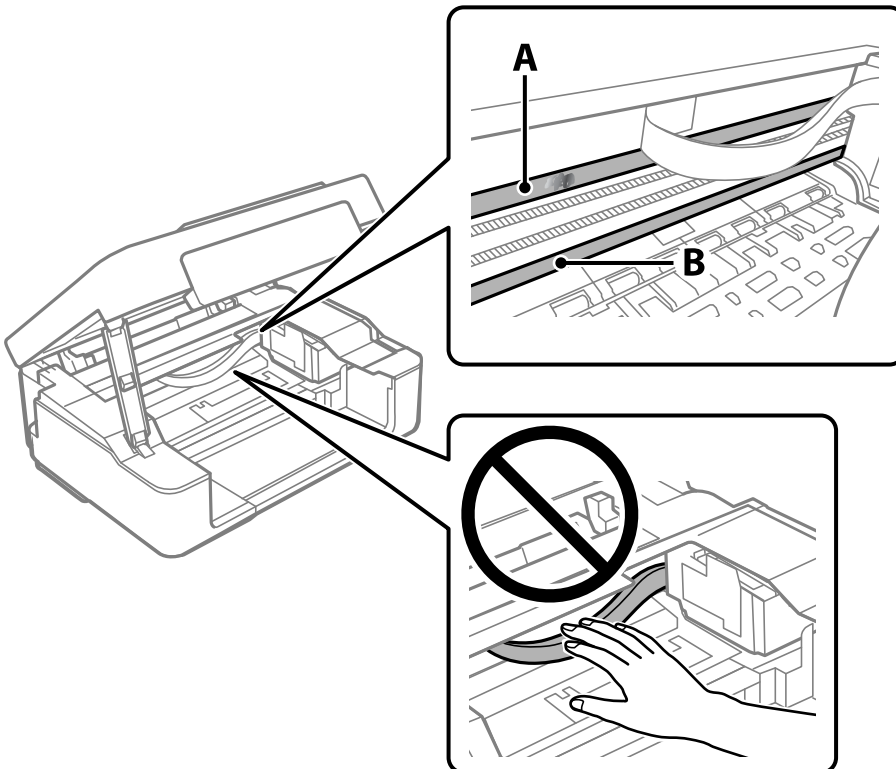

A: Translucent film

B: Rail



Important:

Be careful not to touch the rail (B). Otherwise, you may not be able to print. Do not wipe off the grease on the rail, because this is necessary for operations.

4. Moisten a cotton swab with the water with a few drops of detergent so that it is not dripping water, and then wipe the smeared part.

Be careful not to touch the ink that has adhered inside the printer.

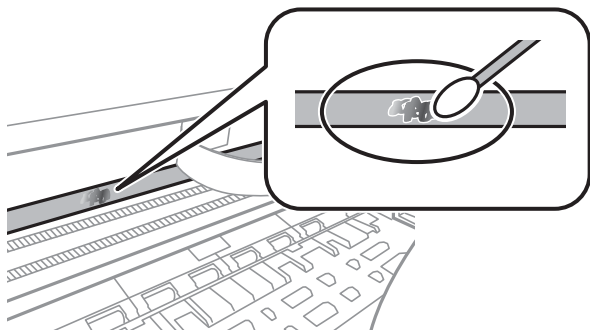

! **Important:**

Wipe off the smear gently. If you press the cotton swab too hard to the film, the springs of the film may be dislocated and the printer may be damaged.

5. Use a new dry cotton swab to wipe the film.

! **Important:**

Do not leave any fibers on the film.

Note:

To prevent the smear from spreading, frequently replace the cotton swab with a new one.

6. Repeat steps 4 and 5 until the film is not smeared.
7. Visually check that the film is not smeared.

Cleaning the Printer

If the components and the case are dirty or dusty, turn off the printer and clean them using a soft, clean cloth that has been dampened with water. If you cannot remove the dirt, try adding a small amount of mild detergent to the damp cloth.

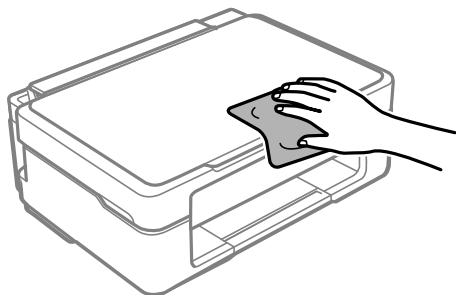

! *Important:*

- ❑ *Be careful not to get water onto the printer mechanism or any electrical components. Otherwise, the printer could be damaged.*
- ❑ *Never use alcohol or paint thinner to clean the components and the case. These chemicals can damage them.*
- ❑ *Do not touch the parts shown in the following illustration. Doing so may cause a malfunction.*

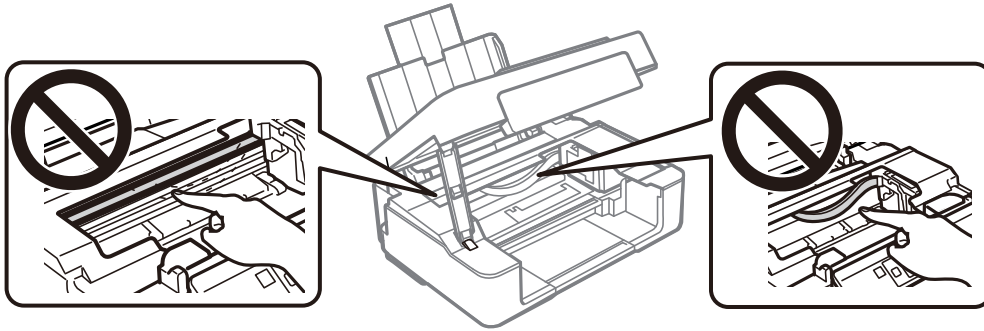

In These Situations

When Replacing a Computer.	73
Saving Power.	73
Installing the Applications Separately.	74
Re-Setting the Network Connection.	77
Connecting a Smart Device and Printer Directly (Wi-Fi Direct).	86
Adding or Changing the Printer's Connection.	89
Transporting and Storing the Printer.	92

When Replacing a Computer

You need to install the printer driver and other software on the new computer.

Access the following website, and then enter the product name. Go to **Setup**, and then start setting up. Follow the on-screen instructions.

<https://epson.sn>

Saving Power

The printer enters sleep mode or turns off automatically if no operations are performed for a set period. You can adjust the time before power management is applied. Any increase will affect the product's energy efficiency. Please consider the environment before making any change.

Depending on the location of purchase, the printer may have a feature that turns it off automatically if it is not connected to the network for 30 minutes.

Saving Power - Windows

1. Access the printer driver window.
2. Click **Printer and Option Information** on the **Maintenance** tab.
3. Do one of the following.

Note:

Your product may have the **Power Off Timer** feature or **Power Off If Disconnected** and **Power Off If Disconnected** features depending on the location of purchase.

- Select the time period before the printer enters sleep mode as the **Sleep Timer** setting, and click **Send**. To make the printer turn off automatically, select the time period as the **Power Off Timer** setting, and click **Send**.
 - Select the time period before the printer enters sleep mode as the **Sleep Timer** setting, and click **Send**. To make the printer turn off automatically, select the time period in the **Power Off If Inactive** or **Power Off If Disconnected** setting, and then click **Send**.
4. Click **OK**.

Related Information

➔ [“Application for Printing from a Computer \(Windows Printer Driver\)” on page 151](#)

Saving Power - Mac OS

1. Select **System Preferences** from the Apple menu > **Printers & Scanners** (or **Print & Scan**, **Print & Fax**), and then select the printer.
2. Click **Options & Supplies** > **Utility** > **Open Printer Utility**.

3. Click **Printer Settings**.

4. Do one of the following.

Note:

Your product may have the **Power Off Timer** feature or **Power Off If Inactive** and **Power Off If Disconnected** features depending on the location of purchase.

- Select the time period before the printer enters sleep mode as the **Sleep Timer** setting, and click **Apply**. To make the printer turn off automatically, select the time period as the **Power Off Timer** setting, and click **Apply**.
- Select the time period before the printer enters sleep mode as the **Sleep Timer** setting, and click **Apply**. To make the printer turn off automatically, select the time period in the **Power Off If Inactive** or **Power Off If Disconnected** setting, and then click **Apply**.

Disabling your Wi-Fi Connection

If you used to use Wi-Fi (wireless LAN) but no longer need to do so due to a change in connection mode and so on, you can disable your Wi-Fi connection.

By removing unnecessary Wi-Fi signals, you can also reduce the load on your standby power.

1. Turn off the printer if it is on.
2. Turn the printer on while holding down the  button.

The default network settings are restored and Wi-Fi connection is disabled.

Note:

You need to make network settings to use Wi-Fi again.

Related Information

➔ [“Buttons and Functions” on page 19](#)

Installing the Applications Separately

Connect your computer to the network and install the latest version of applications from the website. Log in to your computer as an administrator. Enter the administrator password if the computer prompts you.

Note:

When reinstalling an application, you need to uninstall it first.

1. Make sure the printer and the computer are available for communication, and the printer is connected to the Internet.

2. Start Epson Software Updater.

The screenshot is an example on Windows.

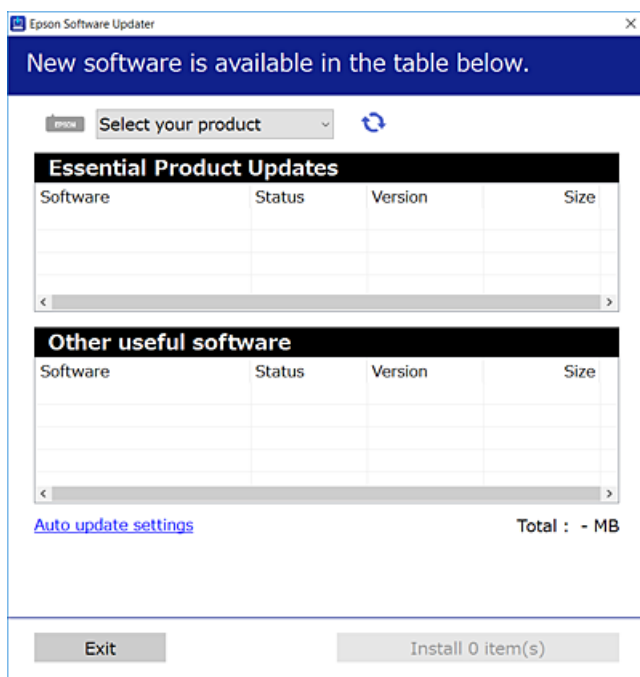

3. For Windows, select your printer, and then click  to check for the latest available applications.
4. Select the items you want to install or update, and then click the install button.



Important:

Do not turn off or unplug the printer until the update is complete. Doing so may result in malfunction of the printer.

Note:

You can download the latest applications from the Epson website.

<http://www.epson.com>

Related Information

➔ [“Application for Updating Software and Firmware \(Epson Software Updater\)”](#) on page 153

Checking if a genuine Epson printer driver is installed - Windows

You can check if a genuine Epson printer driver is installed on your computer by using one of the following methods.

Select **Control Panel > View devices and printers (Printers, Printers and Faxes)**, and then do the following to open the print server properties window.

- ❑ Windows 11/Windows 10/Windows 8.1/Windows 8/Windows 7

Click the printer icon, and then click **Print server properties** at the top of the window.

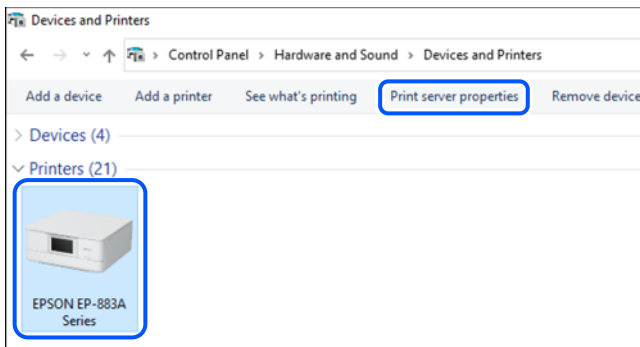

- ❑ Windows Vista

Right-click on the **Printers** folder, and then click **Run as administrator > Server Properties**.

- ❑ Windows XP

From the **File** menu, select **Server Properties**.

Click the **Drivers** tab. If your printer name is displayed in the list, a genuine Epson printer driver is installed on your computer.

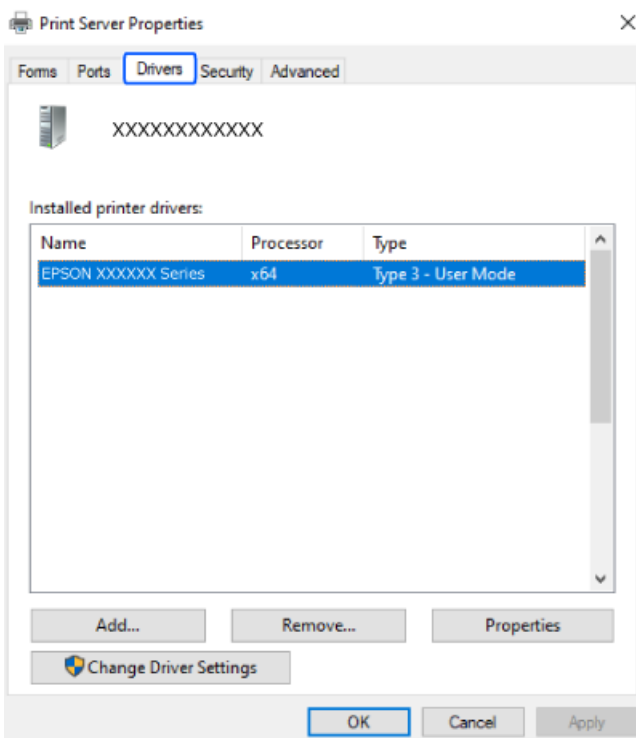

Related Information

- ➔ [“Installing the Applications Separately” on page 74](#)

Checking if a genuine Epson printer driver is installed - Mac OS

You can check if a genuine Epson printer driver is installed on your computer by using one of the following methods.

Select **System Preferences** from the Apple menu > **Printers & Scanners** (or **Print & Scan, Print & Fax**), and then select the printer. Click **Options & Supplies**, and if the **Options** tab and **Utility** tab are displayed on the window, a genuine Epson printer driver is installed on your computer.

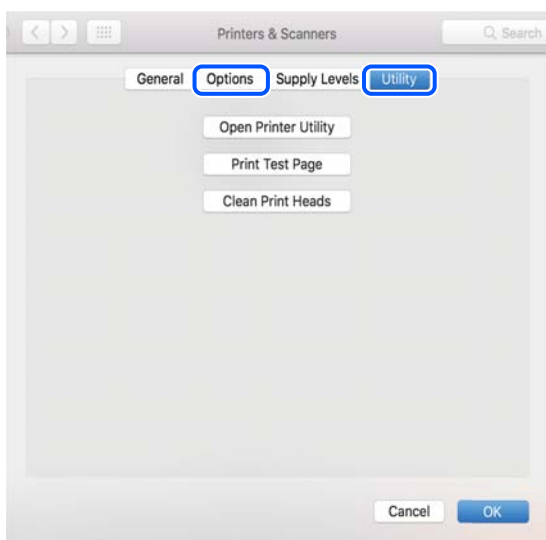

Related Information

➔ [“Installing the Applications Separately” on page 74](#)

Re-Setting the Network Connection

The printer network needs to be configured in the following cases.

- When using a printer with a network connection
- When your network environment has changed
- When replacing the wireless router
- Changing the connection method to the computer

Making Settings for Connecting to the Computer

You can run the installer using one of the following methods.

Setting up from the website

Access the following website, and then enter the product name. Go to **Setup**, and then start setting up.

<https://epson.sn>

 You can also watch the procedure in the Web Movie Manuals. Access the following website.

<https://support.epson.net/publist/vlink.php?code=NPD6870>

Setting up using the software disc

If your printer came with a software disc and you are using a Windows computer with a disc drive, insert the disc into the computer, and then follow the on-screen instructions.

Making Settings for Connecting to the Smart Device

You can use the printer via the wireless router from your smart device when you connect the printer to the same network as the wireless router.

To set up a new connection, access the following website from the smart device that you want to connect to the printer. Enter the product name, go to Setup, and then start the setup.

<https://epson.sn>

 You can watch the procedure in the Web Movie Manuals. Access the following website.

<https://support.epson.net/publist/vlink.php?code=VC00006>

Note:

If you have already set up the connection between your smart device and the printer but need to reconfigure it, you can do so from an app such as Epson Smart Panel.

Making Wi-Fi Settings from the Control Panel

If you are not using a computer or smart device to set up the printer connection, you can do so on the control panel.

You can make network settings from the printer's control panel in several ways. Choose the connection method that matches the environment and conditions that you are using.

Making Wi-Fi Settings by Push Button Setup

You can automatically set up a Wi-Fi network by pressing a button on the wireless router. If the following conditions are met, you can set up by using this method.

- The wireless router is compatible with WPS (Wi-Fi Protected Setup).
- The current Wi-Fi connection was established by pressing a button on the wireless router.



Note:

If you cannot find the button or you are setting up using the software, see the documentation provided with the wireless router.

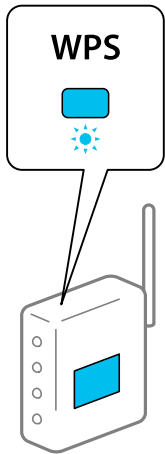
1. Hold down the [WPS] button on the wireless router until the security light flashes.





If you do not know where the [WPS] button is, or there are no buttons on the wireless router, see the documentation provided with your wireless router for details.

2. Hold down the Wi-Fi button on the printer for at least five seconds until the  light and the  light flash alternately.

The connection setting will start. When a connection is established, the  light turns on.



Note:

The printer is in a connection error status when the  light and the  light flash simultaneously. After clearing the printer error by pressing the Wi-Fi button on the printer, reboot the wireless router, place it close to the printer and try again. If it still does not work, print a network connection report and check the solution.



Making Wi-Fi Settings by PIN Code Setup (WPS)



You can connect to an wireless router by using a PIN code that is printed on the network status sheet. You can use this method to set up if an wireless router is capable of WPS (Wi-Fi Protected Setup). Use a computer to enter a PIN code into the wireless router.

1. Load papers.
2. Hold down the  button on the printer for at least 5 seconds.

The network status sheet is printed.

Note:

If you release the  button within 5 seconds, a network connection report is printed. Note that PIN code information is not printed on this report.



3. While holding down the Wi-Fi button, press the  button until the  light and the  light flash alternately.
4. Use your computer to enter the PIN code (an eight digit number) printed on [WPS-PIN Code] column of the network status sheet into the wireless router within two minutes.

When a connection is established, the  light turns on.



Note:

See the documentation provided with your wireless router for details on entering a PIN code.

The printer is in a connection error status when the  light and the  light flash simultaneously. After clearing the printer error by pressing the Wi-Fi button on the printer, reboot the wireless router, place it close to the printer and try again. If it still does not work, print a network connection report and check the solution.



Checking the Printer's Network Connection Status (Network Connection Report)

You can print a network connection report to check the status between the printer and the wireless router.

1. Load papers.
2. Press the  button.

The network connection report is printed.

If an error has occurred, check the network connection report, and then follow the printed solutions.

Messages and Solutions on the Network Connection Report

Check the messages and error codes on the network connection report, and then follow the solutions.

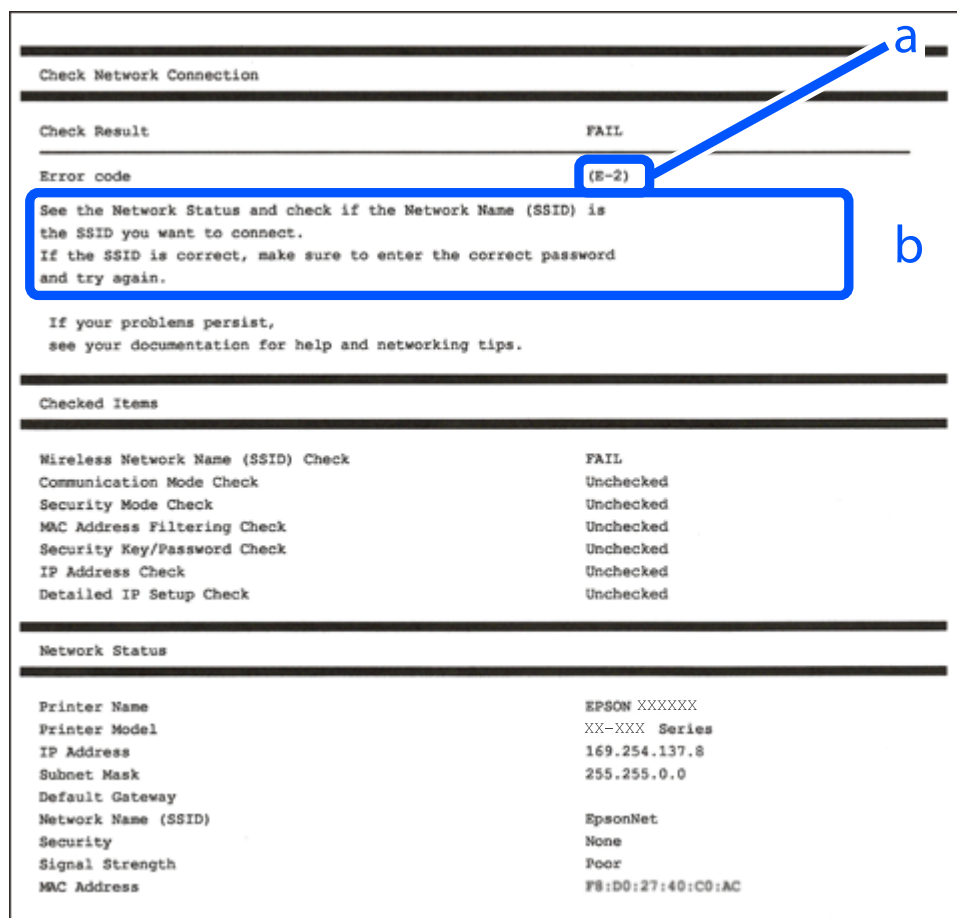

a. Error code

b. Messages on the Network Environment

Related Information

- ➔ “E-1” on page 82
- ➔ “E-2, E-3, E-7” on page 82
- ➔ “E-5” on page 83
- ➔ “E-6” on page 83
- ➔ “E-8” on page 83
- ➔ “E-9” on page 84
- ➔ “E-10” on page 84
- ➔ “E-11” on page 84
- ➔ “E-12” on page 85
- ➔ “E-13” on page 85
- ➔ “Message on the Network Environment” on page 86

E-1

Solutions:

- Make sure your hub or other network device is turned on.
- If you want to connect the printer by Wi-Fi, make Wi-Fi settings for the printer again because it is disabled.

Related Information

➔ [“Making Wi-Fi Settings from the Control Panel” on page 78](#)

E-2, E-3, E-7

Solutions:

- Make sure your wireless router is turned on.
- Confirm that your computer or device is connected correctly to the wireless router.
- Turn off the wireless router. Wait for about 10 seconds, and then turn it on.
- Place the printer closer to your wireless router and remove any obstacles between them.
- If you have entered the SSID manually, check if it is correct. Check the SSID from the **Network Status** part on the network connection report.
- If an wireless router has multiple SSIDs, select the SSID that is displayed. When the SSID is using a non-compliant frequency, the printer does not display them.
- If you are using push button setup to establish a network connection, make sure your wireless router supports WPS. You cannot use push button setup if your wireless router does not support WPS.
- Make sure your SSID uses only ASCII characters (alphanumeric characters and symbols). The printer cannot display an SSID that contains non-ASCII characters.
- Make sure you know your SSID and password before connecting to the wireless router. If you are using a wireless router with its default settings, the SSID and password are located on a label on the wireless router. If you do not know your SSID and password, contact the person who set up the wireless router, or see the documentation provided with the wireless router.
- If you are connecting to an SSID generated from a tethering smart device, check for the SSID and password in the documentation provided with the smart device.
- If your Wi-Fi connection suddenly disconnects, check for the conditions below. If any of these conditions are applicable, reset your network settings by downloading and running the software from the following website.
<https://epson.sn> > **Setup**
 - Another smart device was added to the network using push button setup.
 - The Wi-Fi network was set up using any method other than push button setup.

Related Information

➔ [“Re-Setting the Network Connection” on page 77](#)
➔ [“Making Wi-Fi Settings from the Control Panel” on page 78](#)

E-5

Solutions:

Make sure the wireless router's security type is set to one of the following. If it is not, change the security type on the wireless router, and then reset the printer's network settings.

- WEP-64 bit (40 bit)
- WEP-128 bit (104 bit)
- WPA PSK (TKIP/AES)*
- WPA2 PSK (TKIP/AES)*
- WPA (TKIP/AES)
- WPA2 (TKIP/AES)
- WPA3-SAE (AES)

* WPA PSK is also known as WPA Personal. WPA2 PSK is also known as WPA2 Personal.

E-6

Solutions:

- Check if MAC address filtering is disabled. If it is enabled, register the printer's MAC address so that it is not filtered. See the documentation provided with the wireless router for details. You can check the printer's MAC address from the **Network Status** part on the network connection report.
- If your wireless router is using shared authentication with WEP security, make sure the authentication key and index are correct.
- If the number of connectable devices on the wireless router is less than the number of network devices that you want to connect, make settings on the wireless router to increase the number of connectable devices. See the documentation provided with the wireless router to make settings.

Related Information

➔ [“Making Settings for Connecting to the Computer” on page 77](#)

E-8

Solutions:

- Enable DHCP on the wireless router if the printer's Obtain IP Address setting is set to Auto.
- If the printer's Obtain IP Address setting is set to Manual, the IP address you manually set is invalid due to out of range (for example: 0.0.0.0). Set a valid IP address from the printer's control panel.

Related Information

➔ [“Setting a Static IP Address for the Printer” on page 90](#)

E-9

Solutions:

Check the following.

- Devices are turned on.
- You can access the Internet and other computers or network devices on the same network from the devices you want to connect to the printer.

If still does not connect your printer and network devices after confirming the above, turn off the wireless router. Wait for about 10 seconds, and then turn it on. Then reset your network settings by downloading and running the installer from the following website.

<https://epson.sn> > Setup

Related Information

➔ “Making Settings for Connecting to the Computer” on page 77

E-10

Solutions:

Check the following.

- Other devices on the network are turned on.
- Network addresses (IP address, subnet mask, and default gateway) are correct if you have set the printer's Obtain IP Address to Manual.

Reset the network address if they are incorrect. You can check the IP address, subnet mask, and default gateway from the **Network Status** part on the network connection report.

If DHCP is enabled, change the printer's Obtain IP Address setting to Auto. If you want to set the IP address manually, check the printer's IP address from the **Network Status** part on the network connection report, and then select Manual on the network settings screen. Set the subnet mask to [255.255.255.0].

If still does not connect your printer and network devices, turn off the wireless router. Wait for about 10 seconds, and then turn it on.

Related Information

➔ “Setting a Static IP Address for the Printer” on page 90

E-11

Solutions:

Check the following.

- The default gateway address is correct if you set the printer's TCP/IP Setup setting to Manual.
- The device that is set as the default gateway is turned on.

Set the correct default gateway address. You can check the default gateway address from the **Network Status** part on the network connection report.

Related Information

➔ “Setting a Static IP Address for the Printer” on page 90

E-12

Solutions:

Check the following.

- Other devices on the network are turned on.
- The network addresses (IP address, subnet mask, and default gateway) are correct if you are entering them manually.
- The network addresses for other devices (subnet mask and default gateway) are the same.
- The IP address does not conflict with other devices.

If still does not connect your printer and network devices after confirming the above, try the following.

- Turn off the wireless router. Wait for about 10 seconds, and then turn it on.
- Make network settings again using the installer. You can run it from the following website.
<https://epson.sn> > **Setup**
- You can register several passwords on a wireless router that uses WEP security type. If several passwords are registered, check if the first registered password is set on the printer.

Related Information

➔ “Setting a Static IP Address for the Printer” on page 90

E-13

Solutions:

Check the following.

- Network devices such as a wireless router, hub, and router are turned on.
- The TCP/IP Setup for network devices has not been set up manually. (If the printer's TCP/IP Setup is set automatically while the TCP/IP Setup for other network devices is performed manually, the printer's network may differ from the network for other devices.)

If it still does not work after checking the above, try the following.

- Turn off the wireless router. Wait for about 10 seconds, and then turn it on.
- Make network settings on the computer that is on the same network as the printer using the installer. You can run it from the following website.
<https://epson.sn> > **Setup**
- You can register several passwords on a wireless router that uses the WEP security type. If several passwords are registered, check if the first registered password is set on the printer.

Related Information

➔ “Setting a Static IP Address for the Printer” on page 90

➔ [“Making Settings for Connecting to the Computer” on page 77](#)

Message on the Network Environment

Message	Solution
The Wi-Fi environment needs to be improved. Turn the wireless router off and then turn it on. If the connection does not improve, see the documentation for the wireless router.	After moving the printer closer to the wireless router and removing any obstacles between them, turn off the wireless router. Wait for about 10 seconds, and then turn it on. If it still does not connect, see the documentation supplied with the wireless router.
*No more devices can be connected. Disconnect one of the connected devices if you want to add another one.	<p>Computer and smart devices that can be connected simultaneously are connected in full in the Wi-Fi Direct (Simple AP) connection. To add another computer or smart device, disconnect one of the connected devices or connect it to the other network first.</p> <p>You can confirm the number of wireless devices which can be connected simultaneously and the number of connected devices by checking the network status sheet.</p>

Connecting a Smart Device and Printer Directly (Wi-Fi Direct)

Wi-Fi Direct (Simple AP) allows you to connect a smart device directly to the printer without a wireless router and print from the smart device.

About Wi-Fi Direct

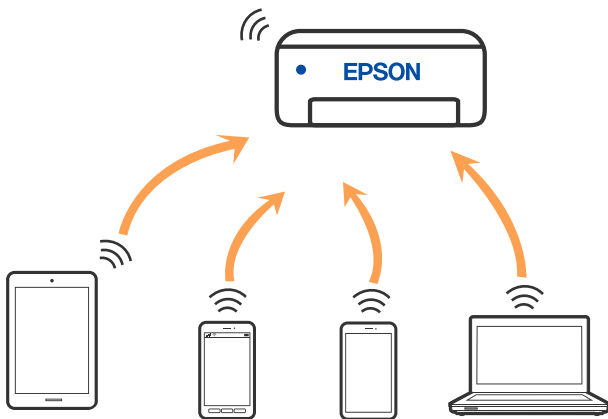

Use this connection method when you are not using Wi-Fi at home or at the office, or when you want to connect the printer and the computer or smart device directly. In this mode, the printer acts as an wireless router and you can connect the devices to the printer without having to use a standard wireless router. However, devices directly connected to the printer cannot communicate with each other through the printer.



The printer can be connected by Wi-Fi and Wi-Fi Direct (Simple AP) connection simultaneously. However, if you start a network connection in Wi-Fi Direct (Simple AP) connection when the printer is connected by Wi-Fi, the Wi-Fi is temporarily disconnected.

Connecting to Devices Using Wi-Fi Direct

This method allows you to connect the printer directly to devices without a wireless router. The printer acts as a wireless router.

1. While holding down the Wi-Fi button, press the  button until the  light and the  light flash alternately.

Wait until the process ends.

When a connection is established, the  light turns on.



Note:

If you enable Wi-Fi Direct once, it remains enabled unless you restore the default network settings.

2. Load papers.
3. Hold down the  button on the printer for at least 5 seconds.
The network status sheet is printed. You can check the SSID and Password for Wi-Fi Direct (Simple AP) on this sheet.
4. On the computer's network connection screen or the smart device's Wi-Fi screen, select the same SSID shown on the network status sheet to connect.



```

<Wi-Fi Direct>
Wi-Fi Direct Mode           On
Communication Mode         Simple AP
Operation Mode              IEEE802.11g/n
Communication Speed         Auto
SSID                        DIRECT-17304000
Password                    88888878
Channel                     11
Security Level              WPA2-PSK(AES)
Link Status                 Unknown
Connected Devices          2(Max 4)
Client MAC List             9C:5C:F9:38:C3:74
                             20:02:AF:C1:92:6B
    
```

5. Enter the password printed on the network status sheet into the computer or smart device.
You can confirm the status of Wi-Fi Direct on the network status sheet.

Note:

When you connect from a smart device using Wi-Fi Direct connection (for Android)

When you are using an Android device and connect to the printer using Wi-Fi Direct, the  light and  light flash simultaneously on the printer.

Press the **Wi-Fi** button to allow the connection request.

Press the  button if you want to reject the connection request.

Changing the Wi-Fi Direct (Simple AP) Settings Such as the SSID

When a Wi-Fi Direct (Simple AP) connection is enabled, you can change the Wi-Fi Direct settings such as the network name and the password.

1. Access Web Config.
2. Log on as an administrator from **Advanced Settings**.

Note:

The administrator password is set in advance for the advanced settings in Web Config. See the link below for details on the administrator password.

3. Select **Services > Wi-Fi Direct** tab .

4. Set the items you want to change.

Wi-Fi Direct:

Enables or disables Wi-Fi Direct.

When disabling it, all devices connected to the printer in Wi-Fi Direct (Simple AP) connection are disconnected.

SSID:

Change the Wi-Fi Direct (simple AP) network name (SSID) used for connecting to the printer to your arbitrary name.

When changing the network name (SSID), all connected devices are disconnected. Use the new network name (SSID) if you want to re-connect the device.

Password:

Change the Wi-Fi Direct (simple AP) password for connecting to the printer to your arbitrary value.

When changing the password, all connected devices are disconnected. Use the new password if you want to re-connect the device.

5. Click **Next** button.

If you want to restore all Wi-Fi Direct (simple AP) settings to their defaults, click **Restore Default Settings**. The Wi-Fi Direct (simple AP) connection information for the smart device saved to the printer is deleted.

Related Information

➔ [“Application for Configuring Printer Operations \(Web Config\)” on page 153](#)

Adding or Changing the Printer's Connection

To Set Up a Printer on Multiple Computers

Although several computers can be connected to the same wireless router, each computer may be assigned a different SSID.

If the SSIDs assigned by the wireless router are not handled as the same network, then each computer is effectively connected to a different network. When you start setting up the printer from computer A, the printer is added to the same network as computer A allowing computer A to print from it.

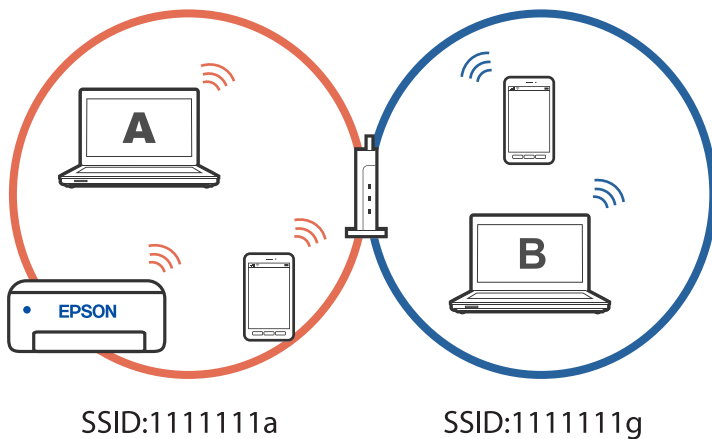

Furthermore, if you start setting up the printer from computer B in the configuration shown above, the printer is set up on computer B's network allowing computer B to print but not computer A.

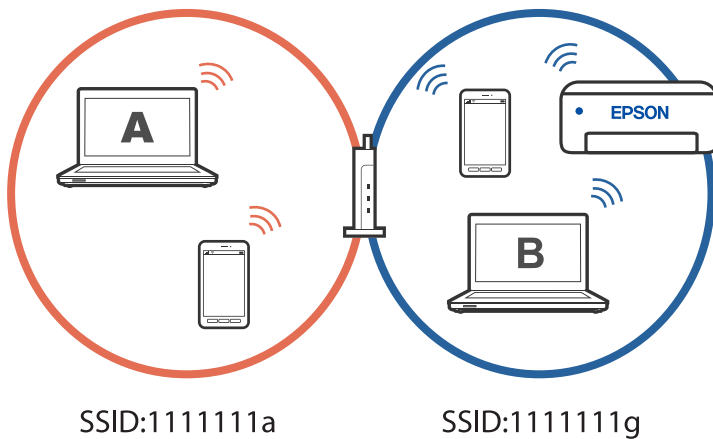

To prevent this from happening, when you want to set up a networked printer from a second computer, start the installer on the computer connected to the same network as the printer. If the printer is found on the same network, the printer will not be reconfigured for the network, and it will set up the printer ready for use.

Changing the Connection from Wi-Fi to USB

Follow the steps below if the Wi-Fi you are using is unstable, or if you want to change to a more stable USB connection.

1. Connect the printer to a computer using a USB cable.
2. Select a printer that is not labeled (XXXXXX) when printing using a USB connection.
Your printer name or "Network" is displayed in XXXX depending on the operating system version.

Example of Windows 11

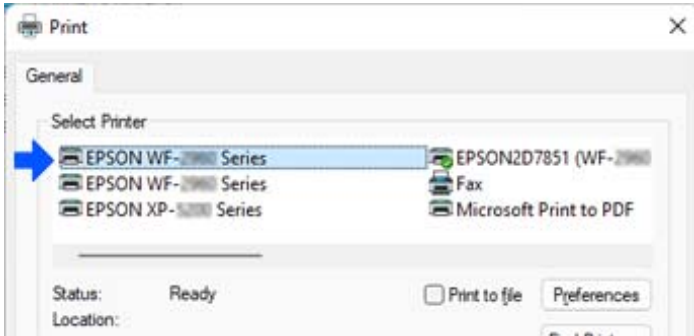

Example of Windows 10

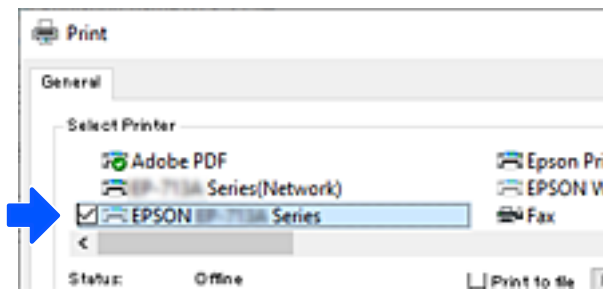

Setting a Static IP Address for the Printer

You can set up a static IP address for a printer using Web Config.

1. Access Web Config.

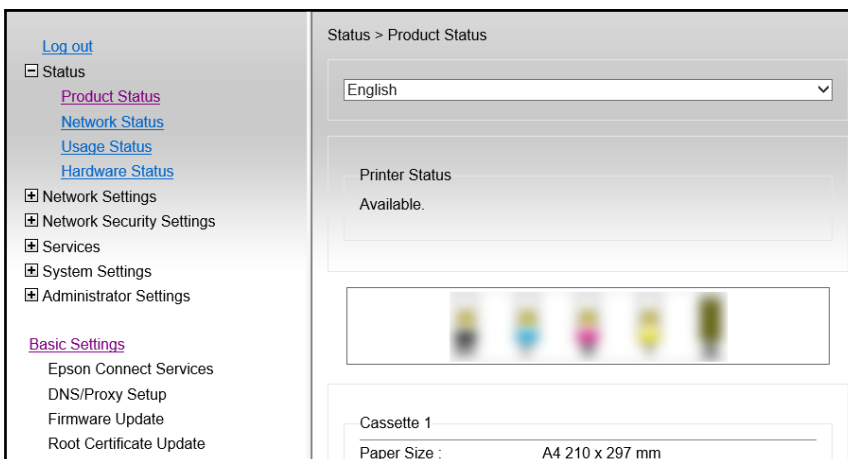

Note:

The display contents and items for Web Config differ depending on the model.

If you see the following, select **Advanced Settings** from the list at the top right of the window.

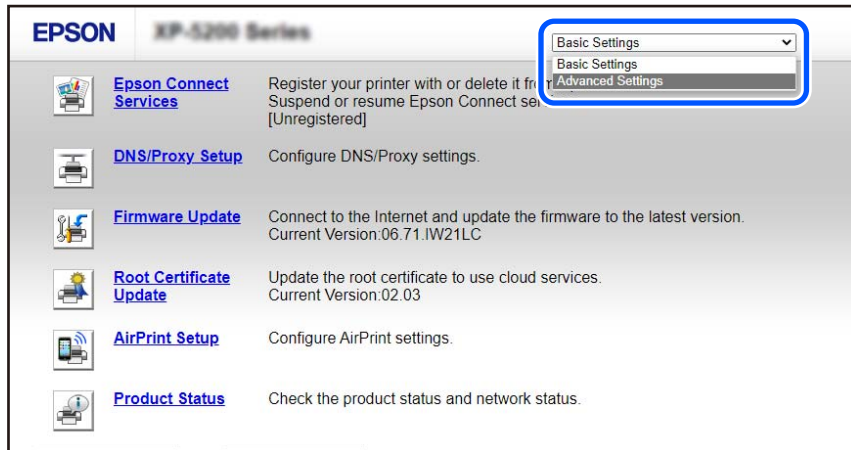

2. Login as an administrator.

Note:

The administrator password is set in advance for the **Advanced Settings** in Web Config. See the link below for details on the administrator password.

3. Select **Network Settings**.

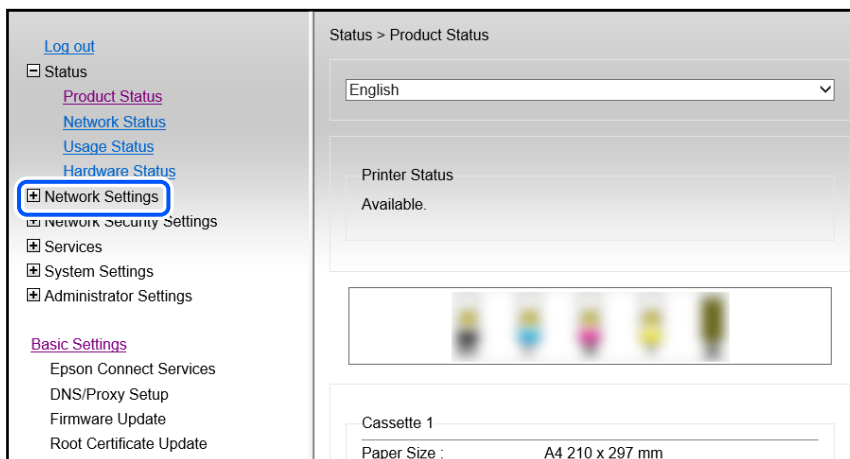

4. Select **Basic**.

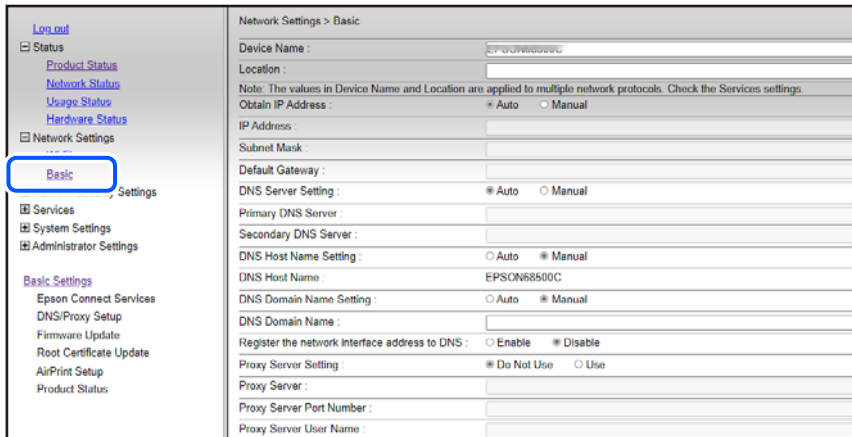

5. Select **Manual** for **Obtain IP Address**.
6. Enter the IP Address you are setting up in **IP Address**.
Set the subnet mask, default gateway, DNS server, and so on. according to your network environment.
7. Click **Next**.
8. Click **OK**.
The settings are applied.
To access Web Config again, specify the IP address you set.

Related Information

- ➔ [“Running Web Config on a Web Browser” on page 153](#)
- ➔ [“Application for Configuring Printer Operations \(Web Config\)” on page 153](#)

Transporting and Storing the Printer

When you need to store the printer or transport it when moving or for repairs, follow the steps below to pack the printer.

1. Turn off the printer by pressing the  button.
2. Make sure the power light turns off, and then unplug the power cord.



Important:

Unplug the power cord when the power light is off. Otherwise, the print head does not return to the home position causing the ink to dry, and printing may become impossible.

3. Disconnect all cables such as the power cord and USB cable.

4. Remove all of the paper from the printer.
5. Make sure there are no originals on the printer.
6. Open the scanner unit with the document cover closed. Secure the ink cartridge holder to the case with tape.

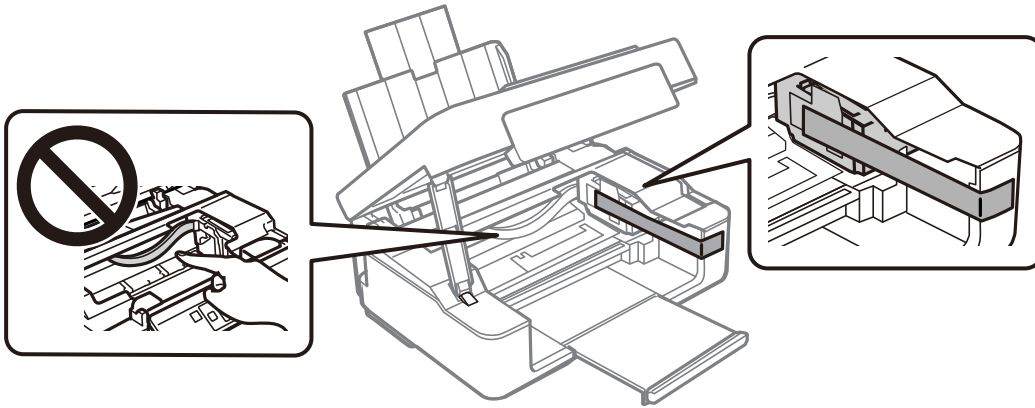

⚠ Caution:

Be careful not to trap your hand or fingers when opening or closing the scanner unit. Otherwise you may be injured.

7. Close the scanner unit.

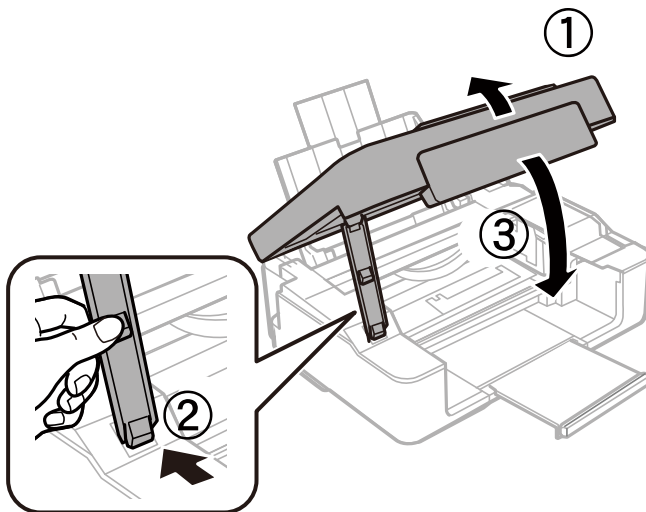

8. Prepare to pack the printer as shown below.

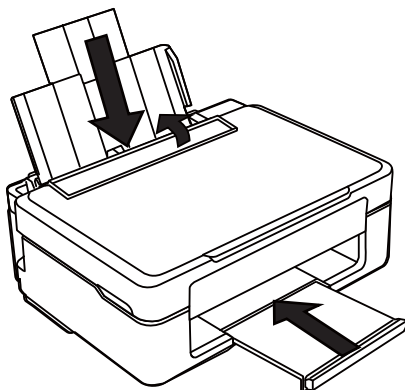

9. Pack the printer in its box, using the protective materials.

! **Important:**

- When storing or transporting the printer, avoid tilting it, placing it vertically, or turning it upside down; otherwise ink may leak.

The diagram shows a printer standing upright on the left. To its right is a circular prohibition sign (a circle with a diagonal slash) over a tilted printer. Two ink droplets are shown falling from the tilted printer, indicating that tilting causes ink to leak.

- Leave the ink cartridges installed. Removing the cartridges can dry out the print head and may prevent the printer from printing.

When you use the printer again, make sure you remove the tape securing the ink cartridge holder. If print quality has declined the next time you print, clean and align the print head.

Related Information

- ➔ [“Checking and Cleaning the Print Head” on page 62](#)
- ➔ [“Aligning the Print Head” on page 66](#)

Solving Problems

Cannot Print or Scan.96
Printing, Copying, and Scanning Quality is Poor.105
Cannot Select Paper Type or Paper Source in Printer Driver.	121
Checking Lights and Printer Status.121
Paper Gets Jammed.124
It is Time to Replace the Ink Cartridges.	127
Cannot Operate the Printer as Expected.	140
Cannot Solve Problem.144

Cannot Print or Scan

Problem Solving

Read this section if you cannot print or scan as expected or if there are problems when printing. See the following for solutions to some common problems.

■ Is the printer turned on?

Solutions

- Make sure that the printer is turned on.
- Make sure that the power cord is correctly connected.
- ➔ [“Power Does Not Turn On” on page 140](#)
- ➔ [“Cannot Solve Problem” on page 144](#)

■ Is any paper jammed in the printer?

Solutions

- If paper is jammed in the printer, it cannot start printing. Remove the jammed paper from the printer.
- ➔ [“Paper Gets Jammed” on page 124](#)

■ Is the printer itself working properly?

Solutions

- If lights on the control panel turn on or flash, check the error.
- Print a status sheet and use it to check if the printer itself can print properly.
- ➔ [“Checking Lights and Printer Status” on page 20](#)

■ Are you having connection problems?

Solutions

- Make sure that the cables are properly connected for all connections.
- Make sure that the network device and USB hub are operating normally.
- If you have a Wi-Fi connection, make sure that the Wi-Fi connection settings are correct.
- Check the network that your computer and printer are connected to, and make sure that the names of the networks match.
- ➔ [“The Printer Cannot Connect to the Network” on page 100](#)
- ➔ [“The Printer Cannot Connect by USB” on page 100](#)
- ➔ [“Checking the Printer's Network Connection Status \(Network Connection Report\)” on page 80](#)

■ Has print data been sent correctly?

Solutions

- Make sure there is no print data standing by from a previous job.

Check the printer driver to make sure the printer is not offline.

➔ [“There is still a job waiting to be printed.” on page 98](#)

➔ [“The printer is pending or offline.” on page 98](#)

The Application or Printer Driver do not Work Properly

Cannot Print Even Though a Connection has been Established (Windows)

The following causes can be considered.

■ There is a problem with the software or data.

Solutions

Make sure that a genuine Epson printer driver (EPSON XXXXX) is installed. If a genuine Epson printer driver is not installed, the available functions are limited. We recommend using a genuine Epson printer driver.

If you are printing a large data size image, the computer may run out of memory. Print the image at a lower resolution or a smaller size.

If you have tried all of the solutions and have not solved the problem, try uninstalling and then reinstalling the printer driver.

You may be able to clear the problem by updating the software to the latest version. To check the software status, use the software update tool.

➔ [“Checking if a genuine Epson printer driver is installed - Windows” on page 75](#)

➔ [“Checking if a genuine Epson printer driver is installed - Mac OS” on page 77](#)

➔ [“Installing the Applications Separately” on page 74](#)

■ There is a problem with the printer's status.

Solutions

Click **EPSON Status Monitor 3** on the printer driver's **Maintenance** tab, and then check the printer status. If **EPSON Status Monitor 3** is disabled, click **Extended Settings** on the **Maintenance** tab, and then select **Enable EPSON Status Monitor 3**.

There is still a job waiting to be printed.

Solutions

Click **Print Queue** on the printer driver's **Maintenance** tab. If unnecessary data remains, select **Cancel all documents** from the **Printer** menu.

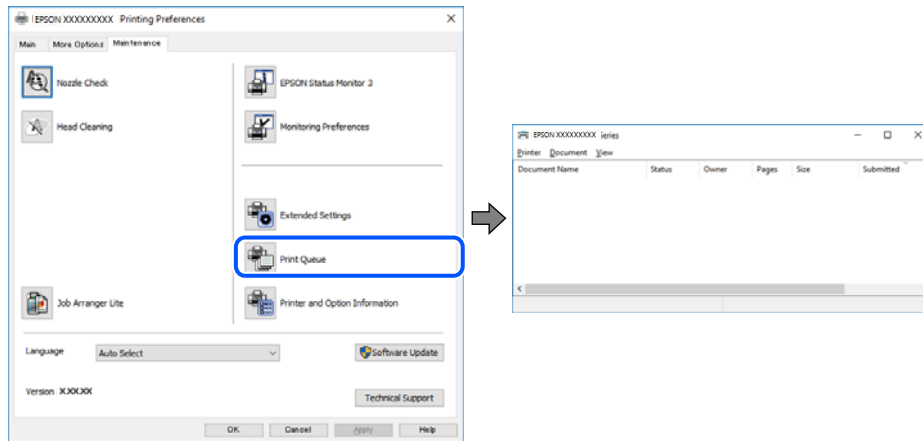

The printer is pending or offline.

Solutions

Click **Print Queue** on the printer driver's **Maintenance** tab.

If the printer is offline or pending, clear the offline or pending setting from the **Printer** menu.

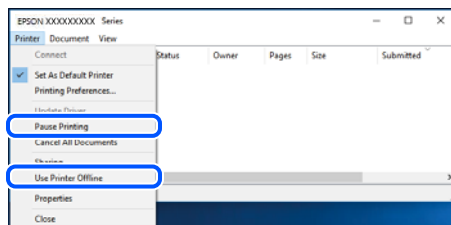

The printer is not selected as the default printer.

Solutions

Right-click the printer icon in **Control Panel > View devices and printers** (or **Printers, Printers and Faxes**) and click **Set as default printer**.

Note:

If there are multiple printer icons, see the following to select the correct printer.

Example)

USB connection: EPSON XXXX Series

Network connection: EPSON XXXX Series (network)

If you install the printer driver multiple times, copies of the printer driver may be created. If copies such as "EPSON XXXX Series (copy 1)" are created, right-click the copied driver icon, and then click **Remove Device**.

The printer port is not set correctly.

Solutions

Click **Print Queue** on the printer driver's **Maintenance** tab.

Make sure the printer port is set correctly as shown below in **Property > Port** from the **Printer** menu.

USB connection: **USBXXX**, Network connection: **EpsonNet Print Port**

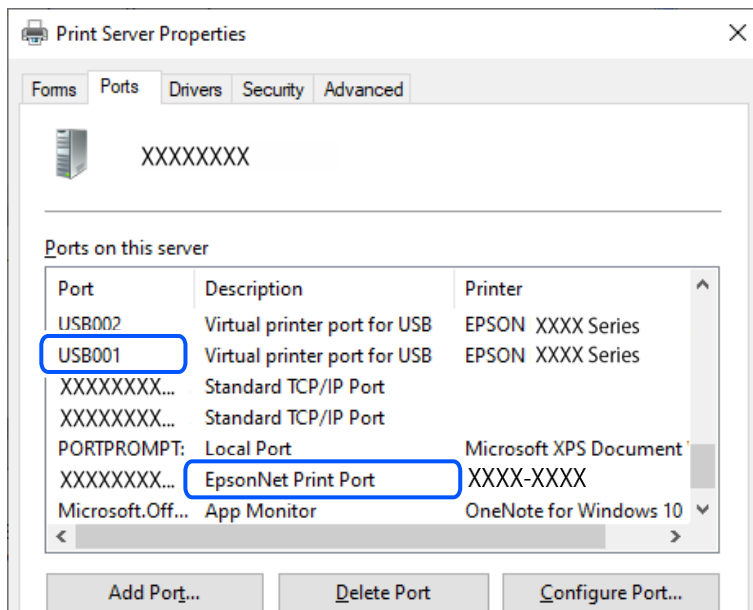

Cannot Print Even Though a Connection has been Established (Mac OS)

The following causes can be considered.

There is a problem with the software or data.

Solutions

- Make sure that a genuine Epson printer driver (EPSON XXXXX) is installed. If a genuine Epson printer driver is not installed, the available functions are limited. We recommend using a genuine Epson printer driver.
- If you are printing a large data size image, the computer may run out of memory. Print the image at a lower resolution or a smaller size.
- If you have tried all of the solutions and have not solved the problem, try uninstalling and then reinstalling the printer driver.
- You may be able to clear the problem by updating the software to the latest version. To check the software status, use the software update tool.

➔ “Checking if a genuine Epson printer driver is installed - Windows” on page 75

➔ “Checking if a genuine Epson printer driver is installed - Mac OS” on page 77

➔ “Installing the Applications Separately” on page 74

■ **There is a problem with the status of the printer.**

Solutions

Make sure the printer status is not **Pause**.

Select **System Preferences** from the **Apple** menu > **Printers & Scanners** (or **Print & Scan, Print & Fax**), and then double-click the printer. If the printer is paused, click **Resume**.

Cannot Scan Even Though a Connection has been Correctly Established

■ **Scanning at a high resolution over a network.**

Solutions

Try scanning at a lower resolution.

The Printer Cannot Connect by USB

The following causes can be considered.

■ **The USB cable is not plugged into the electrical outlet correctly.**

Solutions

Connect the USB cable securely to the printer and the computer.

■ **There is a problem with the USB hub.**

Solutions

If you are using a USB hub, try to connect the printer directly to the computer.

■ **There is a problem with the USB cable or the USB inlet.**

Solutions

If the USB cable cannot be recognized, change the port, or change the USB cable.

The Printer Cannot Connect to the Network

Main causes and solutions for network connection problems

If the Wi-Fi connection fails, check the following to see if there is a problem with the operation or settings for the connected device.

■ **Check the cause of the printer network connection failure.**

Solutions

Print out the network connection check report to see the issue and check the recommended solution.

See the following related information for details on reading the network connection check report.

Note:

If you want to check more information on the network settings, print a network status sheet.

➔ [“Checking the Printer's Network Connection Status \(Network Connection Report\)” on page 80](#)

Use the Epson Printer Connection Checker to improve the connection to the computer. (Windows)

Solutions

You may be able to solve the problem depending on the results of the check.

1. Double-click the **Epson Printer Connection Checker** icon on the desktop.

Epson Printer Connection Checker starts.

If there is no icon on the desktop, follow the methods below to start Epson Printer Connection Checker.

- Windows 11

Click the start button, and then select **All apps > Epson Software > Epson Printer Connection Checker**.

- Windows 10

Click the start button, and then select **Epson Software > Epson Printer Connection Checker**.

- Windows 8.1/Windows 8

Enter the application name in the search charm, and then select the displayed icon.

- Windows 7

Click the start button, and then select **All Programs > Epson Software > Epson Printer Connection Checker**.

2. Follow the on-screen instructions to check.

Note:

If the printer name is not displayed, install a genuine Epson printer driver.

[“Checking if a genuine Epson printer driver is installed - Windows” on page 75](#)

When you have identified the problem, follow the solution displayed on the screen.

When you cannot solve the problem, check the following according to your situation.

- The printer is not recognized over a network connection

[“Checking the Printer's Network Connection Status \(Network Connection Report\)” on page 80](#)

- The printer is not recognized using a USB connection

[“The Printer Cannot Connect by USB” on page 100](#)

- The printer is recognized, but printing cannot be performed.

[“Cannot Print Even Though a Connection has been Established \(Windows\)” on page 97](#)

Something is wrong with the network devices for Wi-Fi connection.

Solutions

Turn off the devices you want to connect to the network. Wait for about 10 seconds, and then turn on the devices in the following order; wireless router, computer or smart device, and then printer. Move the

printer and computer or smart device closer to the wireless router to help with radio wave communication, and then try to make network settings again.



Devices cannot receive signals from the wireless router because they are too far apart.

Solutions

After moving the computer or the smart device and the printer closer to the wireless router, turn off the wireless router, and then turn it back on.

When changing the wireless router, the settings do not match the new router.

Solutions

Make the connection settings again so that they match the new wireless router.

➔ [“Re-Setting the Network Connection” on page 77](#)

The SSIDs connected from the computer or smart device and computer are different.

Solutions

When you are using multiple wireless routers at the same time or the wireless router has multiple SSIDs, you cannot connect to the wireless router.

❑ Example of connecting to different SSIDs

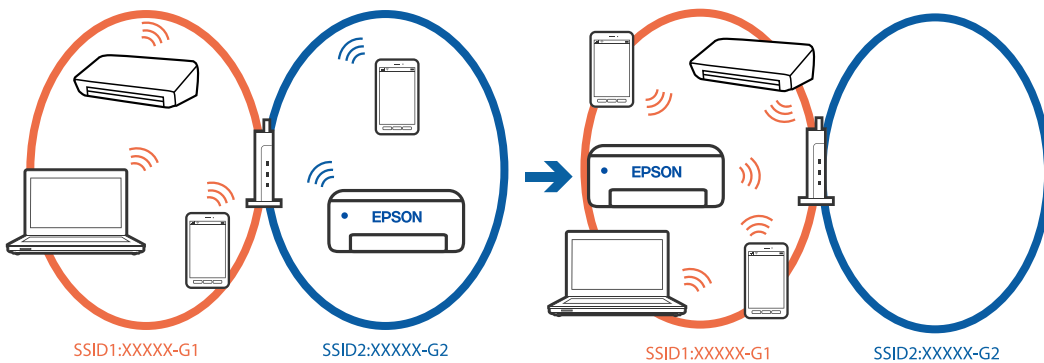

❑ Example of connecting to SSIDs with a different frequency range

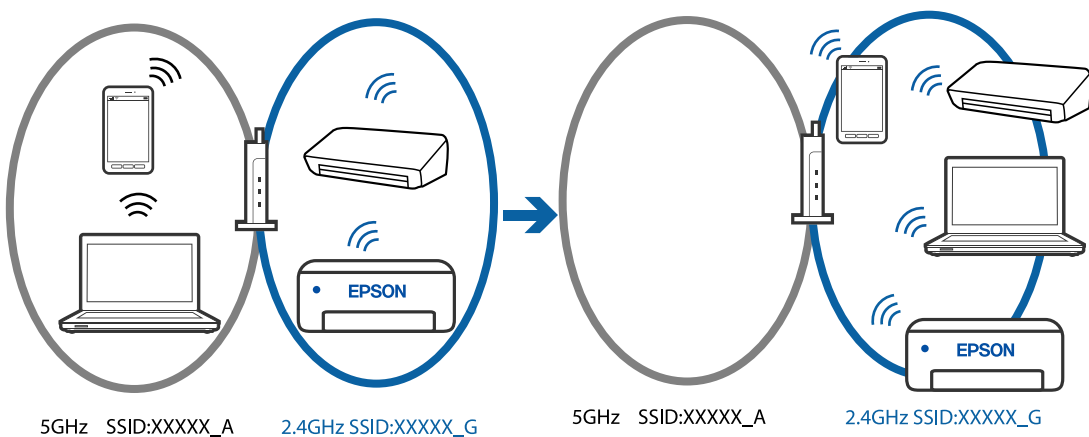

Connect the computer or smart device to the same SSID as the printer.

- Check the SSID that the printer is connected to by printing out the network connection check report.
- On all of the computers and smart devices you want to connect to the printer, check the name of the Wi-Fi or network you are connected to.
- If the printer and your computer or smart device are connected to different networks, reconnect the device to the SSID that the printer is connected to.

■ A privacy separator on the wireless router is available.

Solutions

Most wireless routers have a separator function that blocks communication between devices within the same SSID. If you cannot communicate between the printer and the computer or smart device even if they are connected to the same network, disable the separator function on the wireless router. See the manual provided with the wireless router for details.

■ The IP address is incorrectly assigned.

Solutions

If the IP address assigned to the printer is 169.254.XXX.XXX, and the subnet mask is 255.255.0.0, the IP address may not be assigned correctly.

Print the network connection report, and then check the IP address and the subnet mask assigned to the printer. To print the network connection report, press the  button on the printer's control panel.

Restart the wireless router or reset the network settings for the printer.

➔ [“Setting a Static IP Address for the Printer” on page 90](#)

■ The device connected to the USB 3.0 port causes radio frequency interference.

Solutions

When you connect a device to the USB 3.0 port on a Mac, radio frequency interference may occur. Try the following if you cannot connect to wireless LAN (Wi-Fi) or if operations become unstable.

- Place the device that is connected to the USB 3.0 port further away from the computer.

■ There is a problem with the network settings on the computer or smart device.

Solutions

Try accessing any website from your computer or smart device to make sure that your device's network settings are correct. If you cannot access any websites, there is a problem on the computer or smart device.

Check the network connection for the computer or smart device. See the documentation provided with the computer or smart device for details.

Paper Does Not Feed Properly

Points to Check

Check the following items, and then try the solutions according to the problems.

■ **The installation location is inappropriate.**

Solutions

Place the printer on a flat surface and operate in the recommended environmental conditions.

➔ [“Environmental Specifications” on page 159](#)

■ **Unsupported paper is being used.**

Solutions

Use paper supported by this printer.

➔ [“Available Paper and Capacities” on page 147](#)

➔ [“Unavailable Paper Types” on page 149](#)

■ **Paper handling is inappropriate.**

Solutions

Follow paper handling precautions.

➔ [“Paper Handling Precautions” on page 25](#)

■ **Too many sheets are loaded in the printer.**

Solutions

Do not load more than the maximum number of sheets specified for the paper. For plain paper, do not load above the line indicated by the triangle symbol on the edge guide.

➔ [“Available Paper and Capacities” on page 147](#)

Paper Feeds at a Slant

The following causes can be considered.

■ **The paper is loaded incorrectly.**

Solutions

Load paper in the correct direction, and slide the edge guide against the edge of the paper.

➔ [“Loading Paper in the Rear Paper Feeder” on page 26](#)

Several Sheets of Paper are Fed at a Time

The following causes can be considered.

■ **The paper is moist or damp.**

Solutions

Load new paper.

■ **Static electricity is causing sheets of paper to stick to each other.**

Solutions

Fan the paper before loading. If the paper still does not feed, load one sheet of paper at a time.

■ **Multiple sheets of paper feed at the same time during manual 2-sided printing.**

Solutions

Remove any paper that is loaded in the paper source before you reload the paper.

Paper Out Error Occurs

■ **Paper is not loaded in the center of the rear paper feeder.**

Solutions

When a paper out error occurs although paper is loaded in the rear paper feeder, reload paper in the center of the rear paper feeder.

Printing, Copying, and Scanning Quality is Poor

Print Quality is Poor

Color Missing, Banding, or Unexpected Colors Appear in Printout

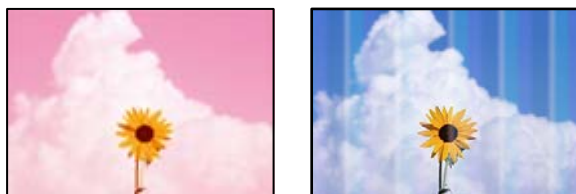

■ **The print head nozzles may be clogged.**

Solutions

Perform a nozzle check to see if the print head nozzles are clogged. Perform a nozzle check, and then clean the print head if any of the print head nozzles are clogged. If you have not used the printer for a long time, the print head nozzles may be clogged and ink drops may not be discharged.

➔ [“Checking and Cleaning the Print Head” on page 62](#)

Colored Banding Appears at Intervals of Approximately 2.5 cm



The following causes can be considered.

■ The paper type setting does not match the paper loaded.

Solutions

Select the appropriate paper type setting for the type of paper loaded in the printer.

➔ [“List of Paper Types” on page 25](#)

■ The print quality is set to low.

Solutions

When printing on plain paper, print using a higher quality setting.

Windows

Select **High** from **Quality** on the printer driver's **Main** tab.

Mac OS

Select **Fine** as **Print Quality** from the print dialog's **Print Settings** menu.

■ The print head position is out of alignment.

Solutions

Align the print head.

Windows

Click **Print Head Alignment** on the printer driver's **Maintenance** tab.

Mac OS

Select **System Preferences** from the Apple menu > **Printers & Scanners** (or **Print & Scan**, **Print & Fax**), and then select the printer. Click **Options & Supplies** > **Utility** > **Open Printer Utility**, and then click **Print Head Alignment**.

Blurry Prints, Vertical Banding, or Misalignment



enthalten alle
Aufdruck. W
↓ 5008 "Regel

The following causes can be considered. Check the causes and follow the solutions in order from the top.

■ The print head position is out of alignment.

Solutions

Align the print head.

Windows

Click **Print Head Alignment** on the printer driver's **Maintenance** tab.

Mac OS

Select **System Preferences** from the Apple menu > **Printers & Scanners** (or **Print & Scan**, **Print & Fax**), and then select the printer. Click **Options & Supplies** > **Utility** > **Open Printer Utility**, and then click **Print Head Alignment**.

■ The bidirectional printing setting is enabled.

Solutions

If print quality does not improve even after aligning the print head, disable the bidirectional setting.

During bidirectional (or high speed) printing, the print head prints while moving in both directions, and vertical lines may be misaligned. Disabling this setting may slow down printing speed but improve print quality.

Windows

Clear **Bidirectional Printing** on the printer driver's **More Options** tab.

Mac OS

Select **System Preferences** from the Apple menu > **Printers & Scanners** (or **Print & Scan**, **Print & Fax**), and then select the printer. Click **Options & Supplies** > **Options** (or **Driver**). Select **Off** as the **Bidirectional Printing** setting.

Printout Comes Out as a Blank Sheet

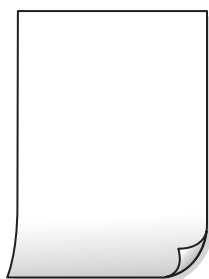

■ The print head nozzles may be clogged.

Solutions

Perform the nozzle check, and then try Power Cleaning if the print head nozzles are clogged.

➔ [“Checking and Cleaning the Print Head” on page 62](#)

➔ [“Running Power Cleaning” on page 64](#)

■ **The print settings and the paper size loaded in the printer are different.**

Solutions

Change the print settings according to the paper size loaded in the printer. Load paper in the printer that matches the print settings.

■ **Multiple sheets of paper are fed into the printer at the same time.**

Solutions

See the following to prevent multiple sheets of paper being fed into the printer at the same time.

➔ [“Several Sheets of Paper are Fed at a Time” on page 104](#)

Paper Is Smearred or Scuffed



The following causes can be considered.

■ **Paper is loaded incorrectly.**

Solutions

When horizontal banding (perpendicular to the printing direction) appears, or the top or bottom of the paper is smeared, load paper in the correct direction and slide the edge guides to the edges of the paper.

➔ [“Loading Paper in the Rear Paper Feeder” on page 26](#)

■ **The paper path is smeared.**

Solutions

When vertical banding (horizontal to the printing direction) appears, or the paper is smeared, clean the paper path.

➔ [“Cleaning the Paper Path for Ink Smears” on page 66](#)

■ **The paper is curled.**

Solutions

Place the paper on a flat surface to check if it is curled. If it is, flatten it.

■ **The back of the paper was printed before the side that had already been printed was dry.**

Solutions

When performing manual 2-sided printing, make sure that the ink is completely dry before reloading the paper.

Printed Photos are Sticky



■ The print was made on the wrong side of the photo paper.

Solutions

Make sure you are printing on the printable side. When printing on the wrong side of the photo paper, you need to clean the paper path.

➔ [“Cleaning the Paper Path for Ink Smears” on page 66](#)

Images or Photos are Printed in Unexpected Colors



The following causes can be considered.

■ The print head nozzles may be clogged.

Solutions

Perform a nozzle check to see if the print head nozzles are clogged. Perform a nozzle check, and then clean the print head if any of the print head nozzles are clogged. If you have not used the printer for a long time, the print head nozzles may be clogged and ink drops may not be discharged.

➔ [“Checking and Cleaning the Print Head” on page 62](#)

■ Color correction has been applied.

Solutions

When printing from the Windows printer driver, the Epson auto photo adjustment setting is applied by default depending on the paper type. Try change the setting.

On the **More Options** tab, select **Custom** in **Color Correction**, and then click **Advanced**. Change the **Scene Correction** setting from **Automatic** to any other option. If changing the setting does not work, use any color correction method other than **PhotoEnhance** in **Color Management**.

➔ [“Adjusting the Print Color” on page 47](#)

Colors in the Printout Differ from Those on the Display



■ The color properties for the display device you are using have not been adjusted correctly.

Solutions

Display devices such as computer screens have their own display properties. If the display is unbalanced, the images are not displayed with proper brightness and colors. Adjust the properties of the device. If you are using Mac OS, also perform the following operation.

Access the print dialog. Select **Color Matching** from the pop-up menu, and then select **ColorSync**.

■ The display device is reflecting external light.

Solutions

Avoid direct sunlight and confirm the image where an appropriate illuminance is assured.

■ The display device has a high resolution.

Solutions

Colors may differ from what you see on smart devices such as smart phones or tablets with high-resolution displays.

■ The display device and the printer have a different process of producing colors.

Solutions

Colors on a display are not quite identical to those on paper because the display device and the printer have a different process of producing colors. Adjust the color properties so that the colors are identical.

Cannot Print Without Margins



■ **Borderless is not set in the print settings.**

Solutions

Make borderless setting in the print settings. If you select a paper type that does not support borderless printing, you cannot select **Borderless**. Select a paper type that supports borderless printing.

Windows

Select **Borderless** on the printer driver's **Main** tab.

Mac OS

Select a borderless paper size from **Paper Size**.

➔ [“Paper for Borderless Printing” on page 148](#)

Edges of the Image are Cropped During Borderless Printing



■ **Because the image is slightly enlarged, the protruding area is cropped.**

Solutions

Select a smaller enlargement setting.

Windows

Click **Settings** next to the **Borderless** checkbox on the printer driver's **Main** tab, and then change the settings.

Mac OS

Change the **Expansion** setting from the print dialog's **Print Settings** menu.

■ **Aspect ratio of the image data and the paper size is different.**

Solutions

If the aspect ratio of the image data and the paper size is different, the long side of the image is cropped if it extends beyond the long side of the paper.

The Position, Size, or Margins of the Printout Are Incorrect

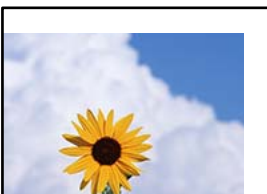

The following causes can be considered.

■ **You are using the printer driver for a different printer.**

Solutions

Make sure that the printer driver you are using is for this printer. Check the printer name on the top of the printer driver window.

The Printed Image Is Inverted

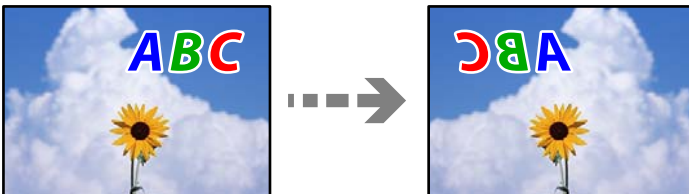

■ **The image is set to invert horizontally in the print settings.**

Solutions

Clear any mirror image settings in the printer driver or the application.

- Windows

Clear **Mirror Image** on the printer driver's **More Options** tab.

- Mac OS

Clear **Mirror Image** from the print dialog's **Print Settings** menu.

Mosaic-Like Patterns in the Prints



■ **Images or photos with a low resolution were printed.**

Solutions

When printing images or photos, print using high-resolution data. Images on web sites are often low resolution although they look good enough on the display, and so print quality may decline.

Copy Quality is Poor

Color Missing, Banding, or Unexpected Colors Appear in Copies



■ The print head nozzles may be clogged.



Solutions



Perform a nozzle check to see if the print head nozzles are clogged. Perform a nozzle check, and then clean the print head if any of the print head nozzles are clogged. If you have not used the printer for a long time, the print head nozzles may be clogged and ink drops may not be discharged.

➔ [“Checking and Cleaning the Print Head” on page 62](#)

■ You have made a copy in draft mode.

Solutions

If you press the  and the  or  buttons simultaneously, the printer copies in draft mode.

Simply press the the  or  button on their own.

Note:

For users in Western Europe, the draft mode is not available.

Colored Banding Appears at Intervals of Approximately 2.5 cm



The following causes can be considered.

■ The paper type setting does not match the paper loaded.

Solutions

Select the appropriate paper type setting for the type of paper loaded in the printer.

➔ [“List of Paper Types” on page 25](#)

■ The print head position is out of alignment.

Solutions

Align the print head.

Windows

Click **Print Head Alignment** on the printer driver's **Maintenance** tab.

Mac OS

Select **System Preferences** from the Apple menu > **Printers & Scanners** (or **Print & Scan**, **Print & Fax**), and then select the printer. Click **Options & Supplies** > **Utility** > **Open Printer Utility**, and then click **Print Head Alignment**.

Blurry Copies, Vertical Banding, or Misalignment



enthalten alle
Aufdruck. W
5008 "Regel

The following causes can be considered.

■ The print head position is out of alignment.

Solutions

Align the print head.

Windows

Click **Print Head Alignment** on the printer driver's **Maintenance** tab.

Mac OS

Select **System Preferences** from the Apple menu > **Printers & Scanners** (or **Print & Scan**, **Print & Fax**), and then select the printer. Click **Options & Supplies** > **Utility** > **Open Printer Utility**, and then click **Print Head Alignment**.

Printout Comes Out as a Blank Sheet

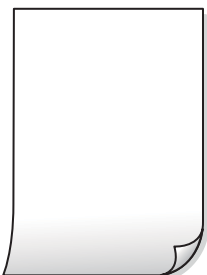

■ The print head nozzles may be clogged.

Solutions

Perform the nozzle check, and then try Power Cleaning if the print head nozzles are clogged.

➔ [“Checking and Cleaning the Print Head” on page 62](#)

➔ [“Running Power Cleaning” on page 64](#)

■ The print settings and the paper size loaded in the printer are different.

Solutions

Change the print settings according to the paper size loaded in the printer. Load paper in the printer that matches the print settings.

■ Multiple sheets of paper are fed into the printer at the same time.

Solutions

See the following to prevent multiple sheets of paper being fed into the printer at the same time.

➔ [“Several Sheets of Paper are Fed at a Time” on page 104](#)

Paper Is Smearred or Scuffed



The following causes can be considered.

■ Paper is loaded incorrectly.

Solutions

When horizontal banding (perpendicular to the printing direction) appears, or the top or bottom of the paper is smearred, load paper in the correct direction and slide the edge guides to the edges of the paper.

➔ [“Loading Paper in the Rear Paper Feeder” on page 26](#)

■ The paper path is smearred.

Solutions

When vertical banding (horizontal to the printing direction) appears, or the paper is smearred, clean the paper path.

➔ [“Cleaning the Paper Path for Ink Smears” on page 66](#)

■ The paper is curled.

Solutions

Place the paper on a flat surface to check if it is curled. If it is, flatten it.

The Position, Size, or Margins of the Copies are Incorrect



The following causes can be considered.

■ The paper is loaded incorrectly.

Solutions

Load paper in the correct direction, and slide the edge guide against the edge of the paper.

➔ [“Loading Paper in the Rear Paper Feeder” on page 26](#)

■ The originals are not placed correctly.

Solutions

- Make sure the original is placed correctly against the alignment marks.
- If the edge of the scanned image is missing, move the original slightly away from the edge of the scanner glass.

➔ [“Placing Originals” on page 30](#)

■ There is dust or dirt on the scanner glass.

Solutions

When placing the originals on the scanner glass, remove any dust or dirt that has stuck to the originals, and clean the scanner glass. If there is dust or stains on the glass, the copy area may extend to include the dust or stains, resulting in the wrong copying position or small images.

➔ [“Cleaning the Scanner Glass” on page 67](#)

■ The size of the paper is set incorrectly.

Solutions

Select the appropriate paper size setting.

Uneven Colors, Smears, Dots, or Straight Lines Appear in the Copied Image



The following causes can be considered.

■ **The paper path is dirty.**

Solutions

Load and eject paper without printing to clean the paper path.

➔ [“Cleaning the Paper Path for Ink Smears” on page 66](#)

■ **There is dust or dirt on the originals or the scanner glass.**

Solutions

Remove any dust or dirt that adheres to the originals, and clean the scanner glass.

➔ [“Cleaning the Scanner Glass” on page 67](#)

■ **The original was pressed with too much force.**

Solutions

If you press with too much force, blurring, smudges, and spots may occur.

Do not press with too much force on the original or the document cover.

Moiré (Cross-Hatch) Patterns Appear in the Copied Image

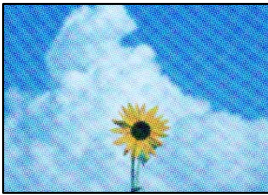

■ **If the original is a printed document such as a magazine or a catalog, a dotted moiré pattern appears.**

Solutions

Place the original at a slightly different angle.

An Image of the Reverse Side of the Original Appears in the Copied Image



The following causes can be considered.

■ **When scanning thin originals, images on the back may be scanned at the same time.**

Solutions

Place the original on the scanner glass and then place a piece of black paper over it.

➔ [“Placing Originals on the Scanner Glass” on page 31](#)

Scanned Image Problems

Uneven Colors, Dirt, Spots, and so on Appear in the Scanned Image



■ **There is dust or dirt on the originals or the scanner glass.**

Solutions

Remove any dust or dirt that adheres to the originals, and clean the scanner glass.

➔ [“Cleaning the Scanner Glass” on page 67](#)

■ **The original was pressed with too much force.**

Solutions

If you press with too much force, blurring, smudges, and spots may occur.

Do not press with too much force on the original or the document cover.

Offset Appears in the Background of Scanned Images



■ **When scanning thin originals, images on the back may be scanned at the same time.**

Solutions

When scanning from the scanner glass, place black paper or a desk pad over the original.

Cannot Scan the Correct Area

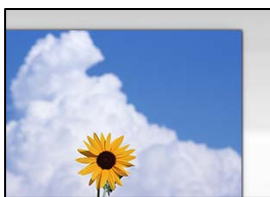

■ The originals are not placed correctly.

Solutions

- Make sure the original is placed correctly against the alignment marks.
- If the edge of the scanned image is missing, move the original slightly away from the edge of the scanner glass.

➔ [“Placing Originals” on page 30](#)

■ There is dust or dirt on the scanner glass.

Solutions

Remove any trash or dirt from the scanner glass and document cover. If there is any trash or dirt around the original, the scanning range expands to include it.

➔ [“Cleaning the Scanner Glass” on page 67](#)

■ When scanning multiple originals using Epson ScanSmart, there is not enough of a gap between the originals.

Solutions

When placing multiple originals on the scanner glass, make sure there is a gap of at least 20 mm (0.8 in.) between the originals.

➔ [“Scanning Multiple Photos at the Same Time” on page 59](#)

Cannot Solve Problems in the Scanned Image

Check the following if you have tried all of the solutions and have not solved the problem.

■ There are problems with the scanning software settings.

Solutions

Use Epson Scan 2 Utility to initialize the settings for the scanner software.

Note:

Epson Scan 2 Utility is an application supplied with the scanner software.

1. Start the Epson Scan 2 Utility.
 - Windows 11
Click the start button, and then select **All apps > EPSON > Epson Scan 2 Utility**.
 - Windows 10
Click the start button, and then select **EPSON > Epson Scan 2 Utility**.

- ❑ Windows 8.1/Windows 8
Enter the application name in the search charm, and then select the displayed icon.
- ❑ Windows 7/Windows Vista/Windows XP
Click the start button, and then select **All Programs** or **Programs > EPSON > Epson Scan 2 > Epson Scan 2 Utility**.
- ❑ Mac OS
Select **Go > Applications > Epson Software > Epson Scan 2 Utility**.

2. Select the **Other** tab.

3. Click **Reset**.

If initialization does not solve the problem, uninstall and re-install the scanner software.

➔ [“Installing the Applications Separately” on page 74](#)

Cannot Select Paper Type or Paper Source in Printer Driver

A genuine Epson printer driver has not been installed.

If a genuine Epson printer driver (EPSON XXXXX) has not been installed, the available functions are limited. We recommend using a genuine Epson printer driver.

Checking Lights and Printer Status

Lights on the control panel indicates the status of the printer.

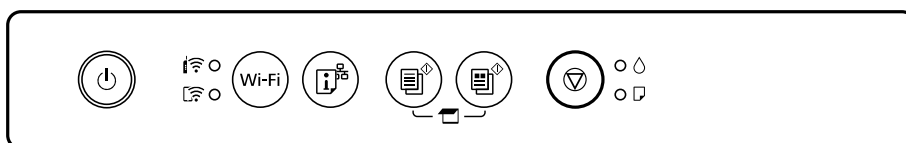

Normal Status

● : On



















Light	Status
	The printer is connected to a wireless (Wi-Fi) network.
	The printer is connected to a network in Wi-Fi Direct (Simple AP) mode.







Error Status

When an error occurs, the light turns on or flashes. Details of the error are displayed on the computer screen.

 / : On

 / : Flashing

Light	Status	Solutions
 	Wi-Fi connection error has occurred.	Press the Wi-Fi button to clear the error and try again.
	An ink cartridge is expended or there is insufficient ink in the cartridge to charge the ink.	To ensure you receive premium print quality and to help protect your print head, a variable ink safety reserve remains in the cartridge when your printer indicates it is time to replace the cartridge. Replace with a new ink cartridge.
	An ink cartridge is not installed.	Install the ink cartridge.
	An ink cartridge has not been recognized.	Press the ink cartridge down firmly.
	An unsupported ink cartridge has been installed.	Install an ink cartridge that is supported by this printer. You cannot use the cartridges that came with your printer for replacement.
	An ink cartridge is nearly expended. You can print until the  light turns on.	Prepare a new ink cartridge. You can check the ink levels from the computer.
	No paper is loaded or more than one sheet has been fed at a time.	Load paper and press the  or  button.
	Flashing slowly (at 1.25 second intervals) A paper jam has occurred.	Remove the paper and press the  or  button.
	Flashing fast (at 0.5 second intervals) Paper remains inside the printer.	Load A4 size paper in the rear paper feeder, and then press the  or  button to remove the paper inside. Load paper in the portrait direction.
 	<ul style="list-style-type: none"> <input type="checkbox"/> The printer was not turned off correctly.* <input type="checkbox"/> Because the printer was turned off while operating, the nozzles may have dried and clogged. <p>* The power was turned off with a power strip or breaker, the plug was pulled out of the outlet, or an electrical failure occurred.</p>	<ul style="list-style-type: none"> <input type="checkbox"/> After clearing the error by pressing the  or  button, we recommend performing a nozzle check. Cancel any pending print jobs. <input type="checkbox"/> To turn off the printer, make sure you press the  button.

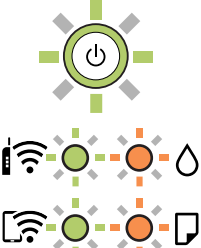
Light	Status	Solutions
	<p>Flashing simultaneously</p> <p>An ink pad is nearing or at the end of its service life.</p>	<p>The ink pads need to be replaced.</p> <p>Contact Epson or an authorised Epson service provider to replace the ink pad *1. It is not a user-serviceable part.</p> <p>When a message saying that you can continue printing is displayed on the computer, press the  or  button to continue printing. The lights stop flashing for the time being, however, they will continue to flash at regular intervals until the ink pad is replaced.</p>
	<p>Flashing alternately</p> <p>A borderless printing ink pad is nearing or at the end of its service life.</p>	<p>The borderless printing ink pad need to be replaced.</p> <p>Contact Epson or an authorised Epson service provider to replace the ink pad *2. It is not a user-serviceable part.</p> <p>When a message saying that you can continue printing is displayed on the computer, press the  or  button to continue printing. The lights stop flashing for the time being, however, they will continue to flash at regular intervals until the ink pad is replaced.</p> <p>Borderless printing is not available, but printing with a border is available.</p>
	<p>The printer has started in recovery mode because the firmware update failed.</p>	<p>Follow the steps below to try to update the firmware again.</p> <ol style="list-style-type: none"> 1. Connect the computer and the printer with a USB cable. (During recovery mode, you cannot update the firmware over a network connection.) 2. Visit your local Epson website for further instructions.
	<p>A printer error has occurred.</p>	<p>Open the scanner unit and remove any paper or protective material inside the printer. Turn the power off and on again.</p> <p>If the error continues to occur after turning the power off and on again, contact Epson support.</p>

*1 In some print cycles a very small amount of surplus ink may be collected in the ink pad. To prevent ink leakage from the pad, the printer is designed to stop printing when the pad has reached its limit. Whether and how often this is required will vary according to the number of pages you print, the type of material that you print and the number of cleaning cycles that the printer performs. The need for replacement of the pad does not mean that your printer has ceased to operate in accordance with its specifications. The printer will advise you when the pad requires replacing and this can only be performed by an authorised Epson Service provider. The Epson warranty does not cover the cost of this replacement.

*2 In some print cycles a very small amount of surplus ink may be collected in the ink pad. To prevent ink leakage from the pad, the product is designed to stop printing when the pad has reached its limit. Whether and how often

this is required will vary according to the number of pages you print using the borderless print option. The need for replacement of the pad does not mean that your printer has ceased to operate in accordance with its specifications. The printer will advise you when the pad requires replacing and this can only be performed by an authorised Epson Service provider. The Epson warranty does not cover the cost of this replacement.

Related Information

- ➔ [“Removing Jammed Paper” on page 124](#)
- ➔ [“Contacting Epson Support” on page 163](#)

Paper Gets Jammed

Check the error displayed on the control panel and follow the instructions to remove the jammed paper including any torn pieces. Next, clear the error.



Caution:

Never touch the buttons on the control panel while your hand is inside the printer. If the printer starts operating, it could cause an injury. Be careful not to touch the protruding parts to avoid injury.



Important:

Remove the jammed paper carefully. Removing the paper vigorously may cause damage to the printer.

Removing Jammed Paper



You can also watch the procedure in the Web Movie Manuals. Access the following website.

<https://support.epson.net/publist/vlink.php?code=NPD6872>



Caution:

- Be careful not to trap your hand or fingers when opening or closing the scanner unit. Otherwise you may be injured.*
- Never touch the buttons on the control panel while your hand is inside the printer. If the printer starts operating, it could cause an injury. Be careful not to touch the protruding parts to avoid injury.*

1. Remove the jammed paper from the rear paper feeder.

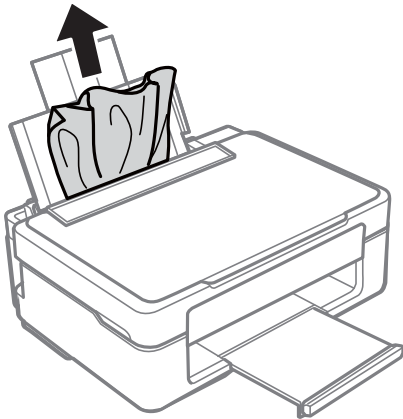

2. Remove the jammed paper from the output tray.

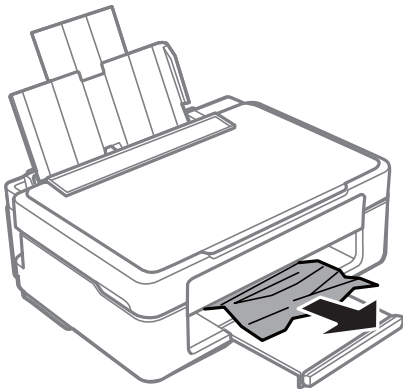

3. Open the scanner unit with the document cover closed.

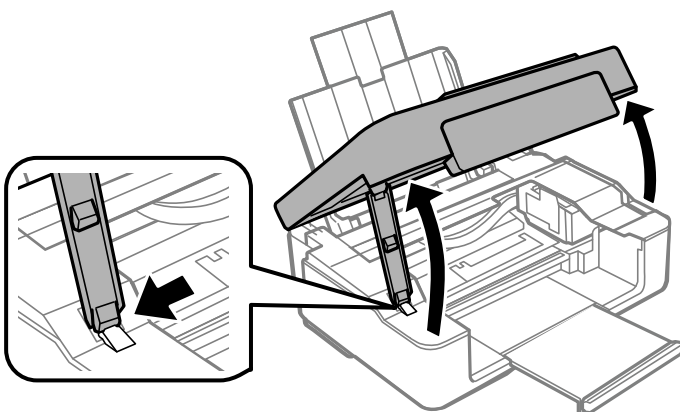

4. Remove the jammed paper.

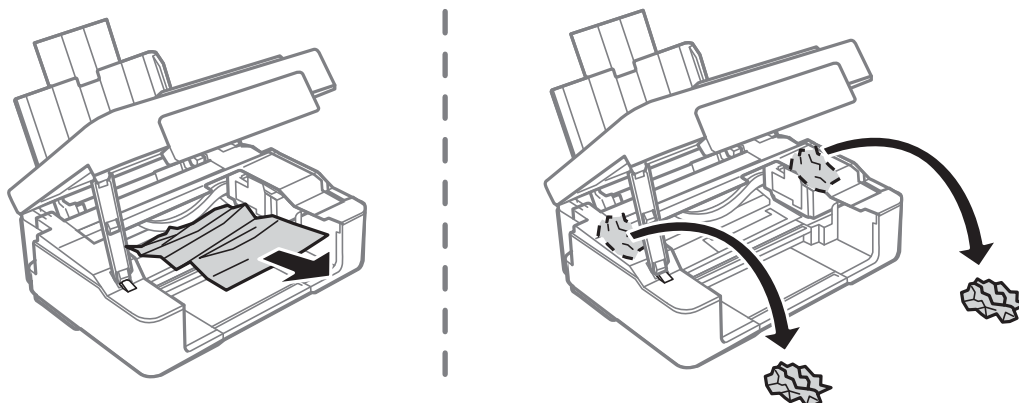

! *Important:*

Do not touch the white flat cable or translucent film inside the printer. Doing so may cause a malfunction.

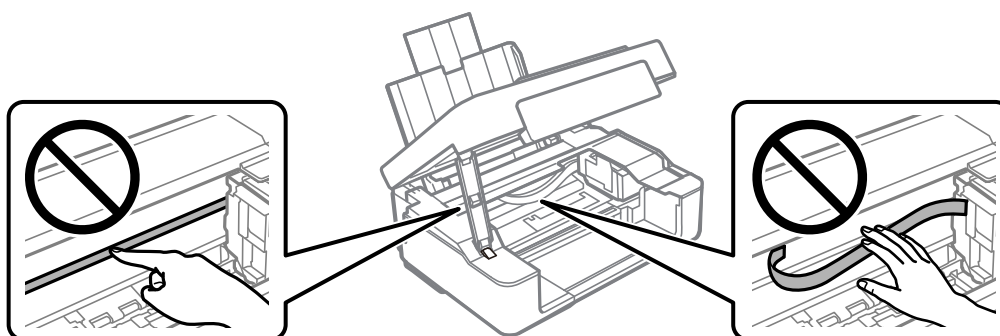

5. Close the scanner unit.

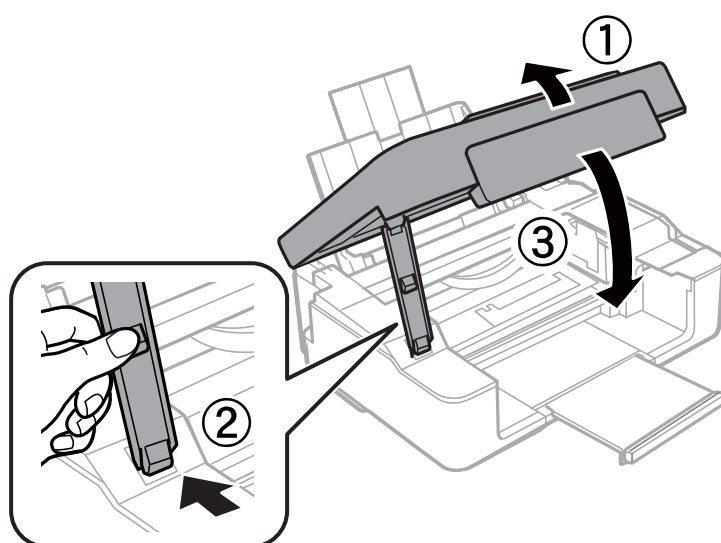

Preventing Paper Jams

Check the following if paper jams occur frequently.

- Place the printer on a flat surface and operate in the recommended environmental conditions.
“Environmental Specifications” on page 159
- Use the paper supported by this printer.
“Available Paper and Capacities” on page 147
- Follow paper handling precautions.
“Paper Handling Precautions” on page 25
- Load paper in the correct direction, and slide the edge guide against the edge of the paper.
“Loading Paper in the Rear Paper Feeder” on page 26
- Do not load more than the maximum number of sheets specified for paper.
- Load one sheet of paper at a time if you have loaded several sheets of paper.

It is Time to Replace the Ink Cartridges

Ink Cartridge Handling Precautions

Read the following instructions before replacing ink cartridges.

Storing precautions for ink

- Keep the ink cartridges out of direct sunlight.
- Do not store the ink cartridges in high or freezing temperatures.
- Epson recommends using the ink cartridge before the date printed on the package.
- For best results, Epson recommends using up ink cartridges before the best before date printed on the package, or within six months of opening the package, whichever is earlier.
- For best results, store ink cartridge packages with their bottom down.
- After bringing an ink cartridge inside from a cold storage site, allow it to warm up at room temperature for at least three hours before using it.
- Do not open the ink cartridge package until you are ready to install it in the printer. The cartridge is vacuum packed to maintain its reliability. If you leave a cartridge unpacked for a long time before using it, normal printing may not be possible.

Handling precautions for replacing ink cartridges

- Be careful not to break the hooks on the side of the ink cartridge when you remove it from the package.

- ❑ You must remove the yellow tape from the cartridge before installing it; otherwise, print quality may decline or you may not be able to print. Do not remove or tear the label on the cartridge; this can cause leakage.

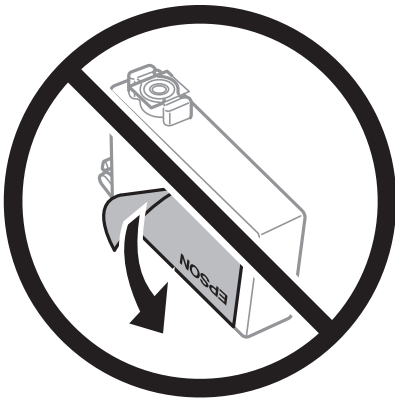

- ❑ Do not remove the transparent seal from the bottom of the cartridge; otherwise, the cartridge may become unusable.

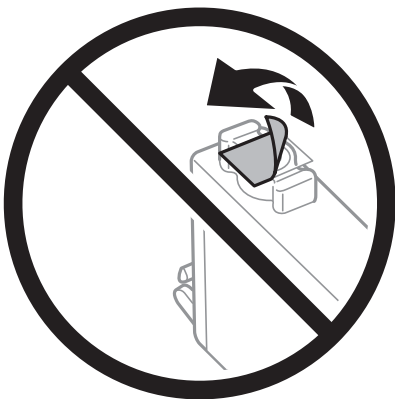

- ❑ Do not touch the sections shown in the illustration. Doing so may prevent normal operation and printing.

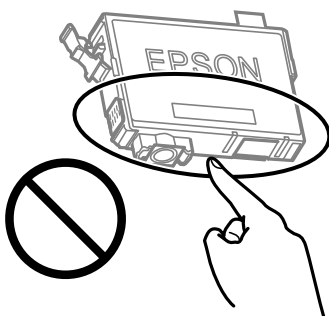

- ❑ Install all ink cartridges; otherwise you cannot print.
- ❑ Do not replace ink cartridges with the power off. Do not move the print head by hand; otherwise, you may damage the printer.
- ❑ After installing the ink cartridge, the power and ink light will continue to flash while the printer is charging ink. Do not turn off the printer during ink charging. If the ink charging is incomplete, you may not be able to print.
- ❑ Do not leave the printer with the ink cartridges removed or do not turn off the printer during cartridge replacement. Otherwise, ink remaining in the print head nozzles will dry out and you may not be able to print.

- ❑ If you need to remove an ink cartridge temporarily, make sure you protect the ink supply area from dirt and dust. Store the ink cartridge in the same environment as the printer, with the ink supply port facing down or sideways. Do not store ink cartridges with the ink supply port facing up. Because the ink supply port is equipped with a valve designed to contain the release of excess ink, there is no need to supply your own covers or plugs.
- ❑ Removed ink cartridges may have ink around the ink supply port, so be careful not to get any ink on the surrounding area when removing the cartridges.
- ❑ This printer uses ink cartridges equipped with a green chip that monitors information such as the amount of remaining ink for each cartridge. This means that even if the cartridge is removed from the printer before it is expended, you can still use the cartridge after reinserting it back into the printer. However, when reinserting a cartridge, some ink may be consumed to guarantee printer performance.
- ❑ For maximum ink efficiency, only remove an ink cartridge when you are ready to replace it. Ink cartridges with low ink status may not be used when reinserted.
- ❑ To ensure you receive premium print quality and to help protect your print head, a variable ink safety reserve remains in the cartridge when your printer indicates to replace the cartridge. The yields quoted for you do not include this reserve.
- ❑ Do not disassemble or remodel the ink cartridge, otherwise you may not be able to print normally.
- ❑ You cannot use the cartridges that came with the printer for the replacement.

Ink consumption

- ❑ To maintain optimum print head performance, some ink is consumed from all cartridges during maintenance operations. Ink may also be consumed when you replace ink cartridge or turn the printer on.
- ❑ When printing in monochrome or grayscale, color inks instead of black ink may be used depending on the paper type or print quality settings. This is because a mixture of color inks is used to create black.
- ❑ The ink in the ink cartridges supplied with your printer is partly used during initial setup. In order to produce high quality printouts, the print head in your printer will be fully charged with ink. This one-off process consumes a quantity of ink and therefore these cartridges may print fewer pages compared to subsequent ink cartridges.
- ❑ Quoted yields may vary depending on the images that you are printing, the paper type that you are using, the frequency of your prints and environmental conditions such as temperature.

Replacing Ink Cartridges (When Ink Light is Off)

 You can also watch the procedure in the Web Movie Manuals. Access the following website.

<https://support.epson.net/publist/vlink.php?code=NPD6469>



Caution:

Be careful not to trap your hand or fingers when opening or closing the scanner unit. Otherwise you may be injured.

Note:

If you replace the ink cartridges while copying, the originals may move out of place. Press the  button to cancel and replace the originals.

1. Open the scanner unit with the document cover closed.

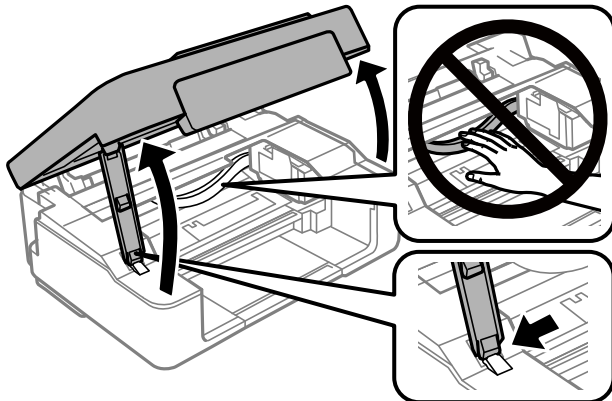

2. Hold down the  button for 10 seconds.

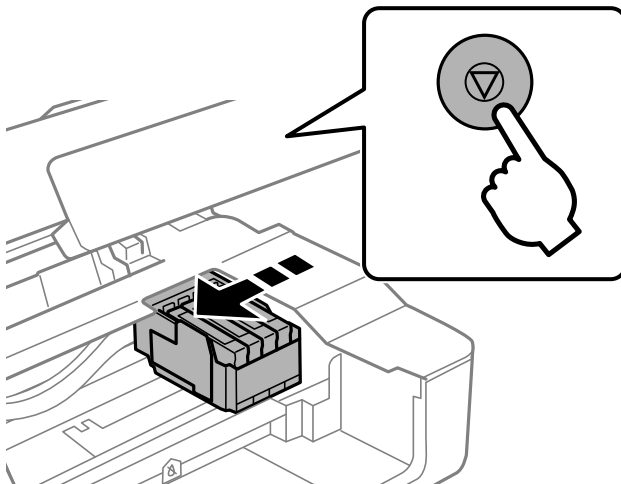

The ink cartridge holder moves to the replacement position.

Note:

To cancel ink cartridge replacement, keep the ink cartridges installed and turn off the printer.

3. When replacing the black ink cartridge, gently shake the new black ink cartridge four or five times and then remove it from its package. When replacing other color cartridges, remove the new color cartridges from their package without shaking.

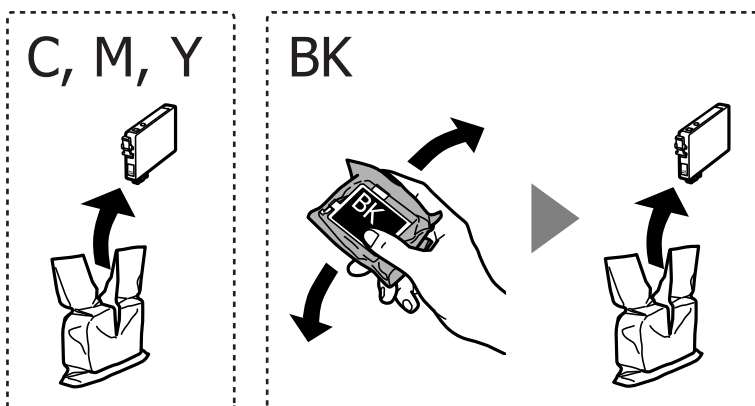

! **Important:**

Do not shake cartridges after opening the package, as they may leak.

4. Remove only the yellow tape.

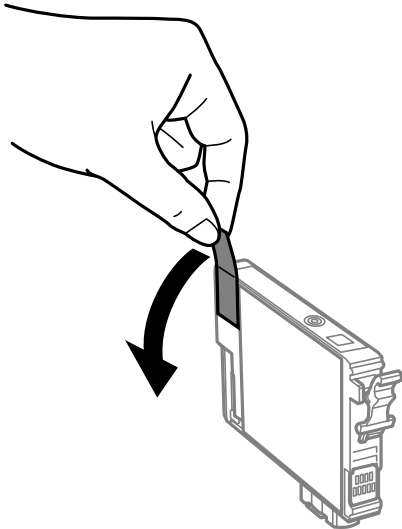

! **Important:**

Do not touch the sections shown in the illustration. Doing so may prevent normal operation and printing.

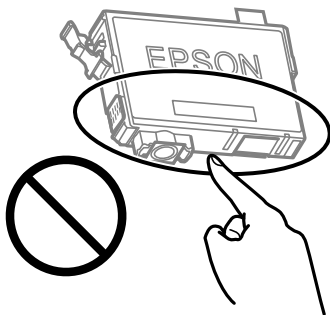

5. Squeeze the tab on the ink cartridge and pull it straight up. If you cannot remove the ink cartridge, pull it firmly

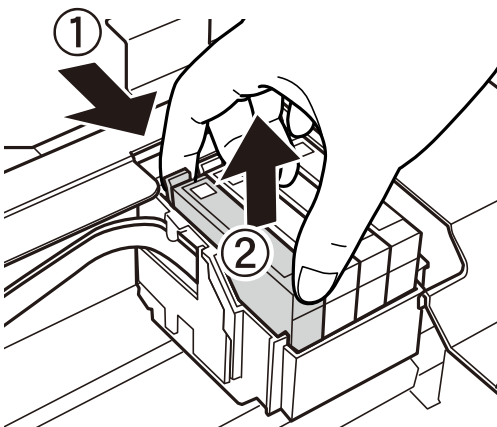

6. Insert the new ink cartridge, and then press it down firmly.

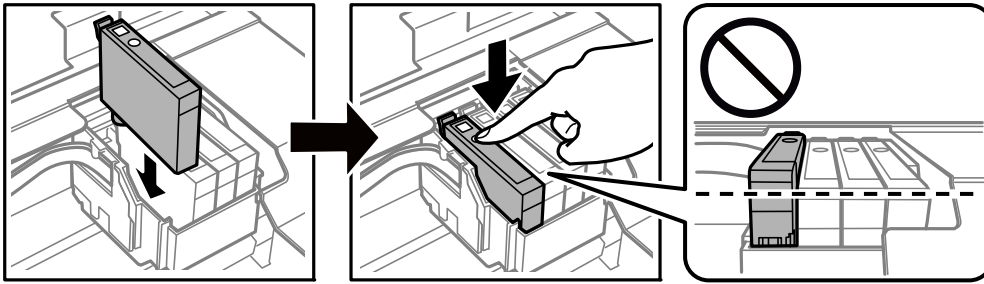

7. Close the scanner unit.

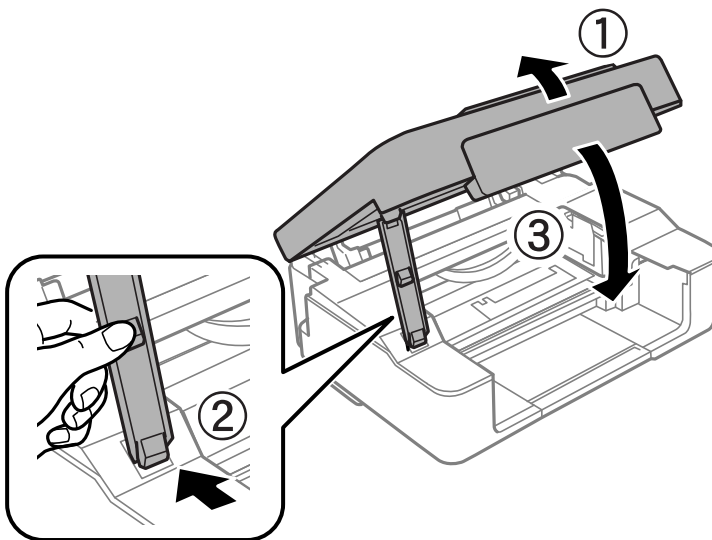

8. Press the  button.

Ink charging starts.

 **Important:**

After installing the ink cartridge, the power and ink light will continue to flash while the printer is charging ink. Do not turn off the printer during ink charging. Charging takes approximately two minutes. If the ink charging is incomplete, you may not be able to print.

Note:

If the  light does not turn off, try removing and reinserting the ink cartridge.

Related Information

- ➔ [“Ink Cartridge Handling Precautions” on page 127](#)
- ➔ [“Ink Cartridge Codes” on page 150](#)

Replacing Ink Cartridges (When Ink Light is On or Flashing)

 You can also watch the procedure in the Web Movie Manuals. Access the following website.

<https://support.epson.net/publist/vlink.php?code=NPD6468>

Caution:

Be careful not to trap your hand or fingers when opening or closing the scanner unit. Otherwise you may be injured.

Note:

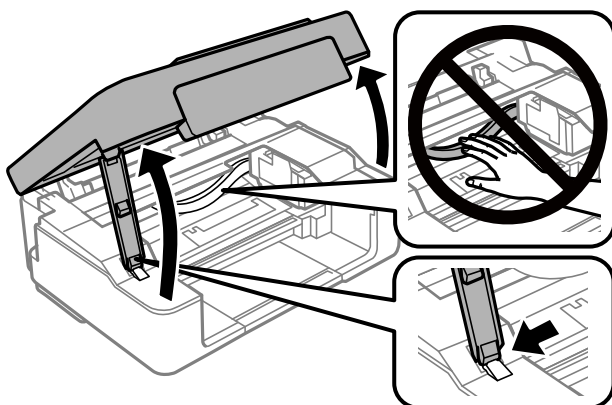

If you replace the ink cartridges while copying, the originals may move out of place. Press the  button to cancel and replace the originals.

1. Open the scanner unit with the document cover closed.





2. Operate the printer's buttons to move the ink cartridge holder.

Note:

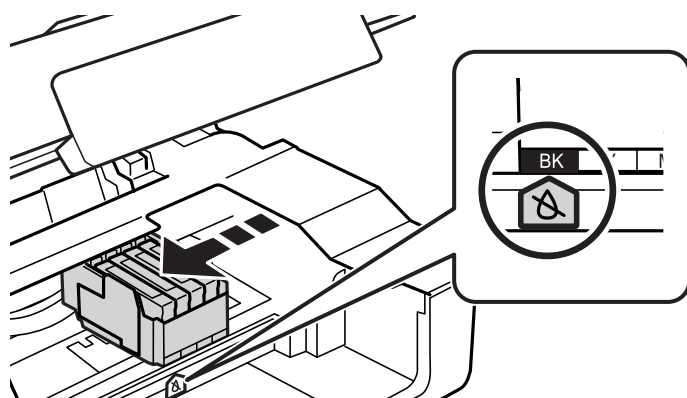
Replace the cartridge that stops at the  icon. If there are more expended ink cartridges, the cartridge moves to the  icon every time you press the .



- If the  light is on (one or more ink cartridges are expended)

Press the  button. The ink cartridge holder moves to the  icon. You cannot replace cartridges in this position. Go to the next step.

- If the  light flashes (one or more ink cartridges are running low)

Hold down the  button for 10 seconds. The ink cartridge holder moves to the  icon. You cannot replace cartridges in this position. Go to the next step.

Note:

To cancel ink cartridge replacement, keep the ink cartridges installed and turn off the printer.

3. Press the  button again.

The ink cartridge holder moves to the replacement position.

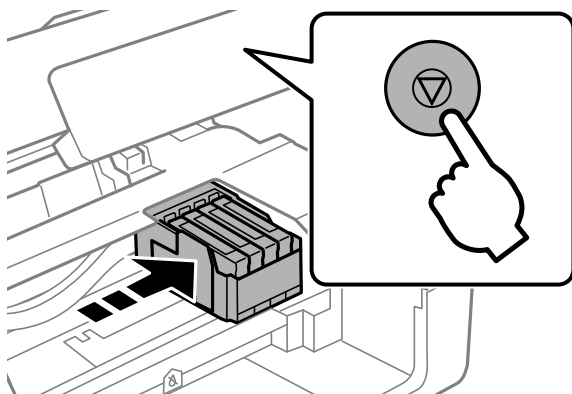

4. When replacing the black ink cartridge, gently shake the new black ink cartridge four or five times and then remove it from its package. When replacing other color cartridges, remove the new color cartridges from their package without shaking.

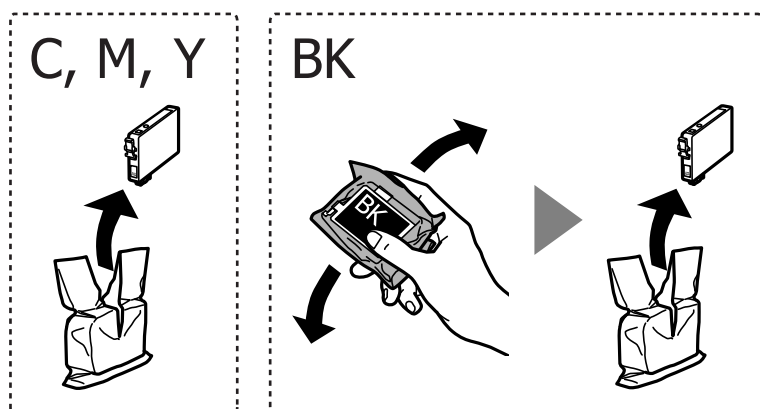

Important:

Do not shake cartridges after opening the package, as they may leak.

5. Remove only the yellow tape.

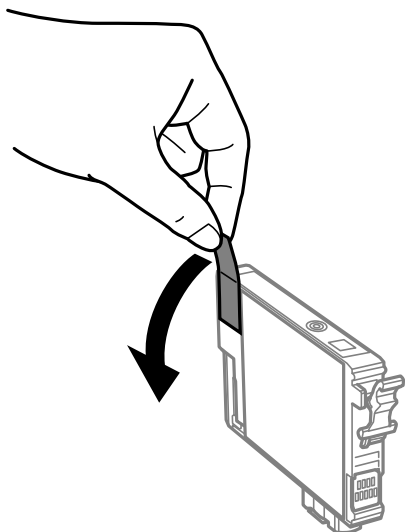

! **Important:**

Do not touch the sections shown in the illustration. Doing so may prevent normal operation and printing.

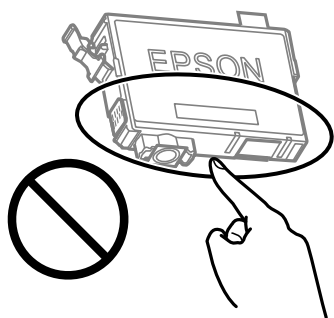

6. Squeeze the tab on the ink cartridge and pull it straight up. If you cannot remove the ink cartridge, pull it firmly.

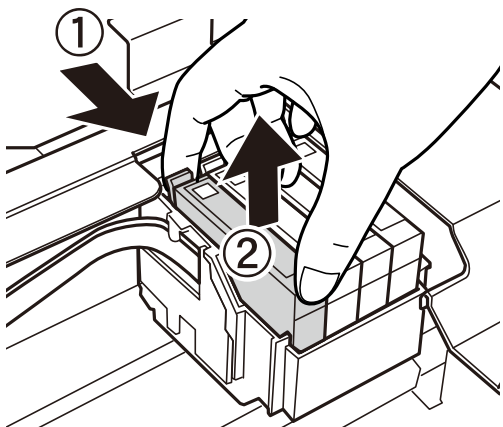

7. Insert the new ink cartridge, and then press it down firmly.

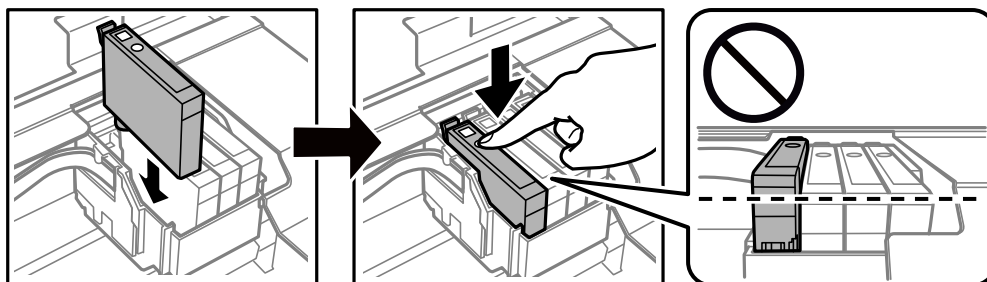

8. Close the scanner unit.

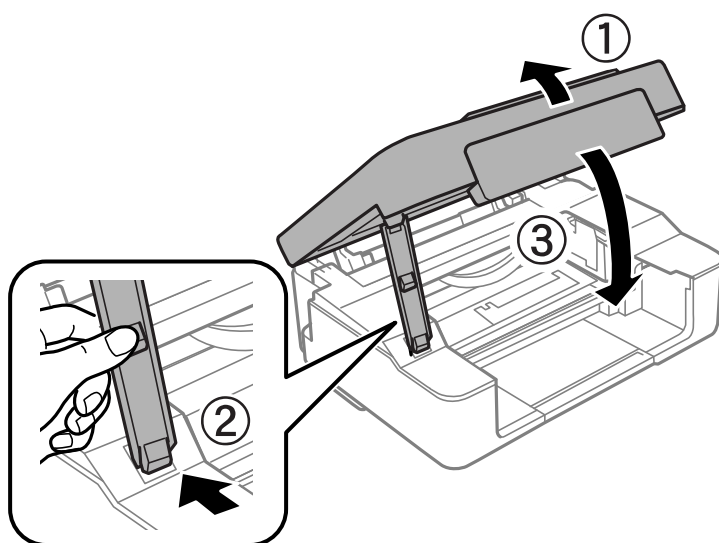

9. Press the  button.

Ink charging starts.

 **Important:**

After installing the ink cartridge, the power and ink light will continue to flash while the printer is charging ink. Do not turn off the printer during ink charging. Charging takes approximately two minutes. If the ink charging is incomplete, you may not be able to print.

Note:

If the  light does not turn off, try removing and reinserting the ink cartridge.

Related Information

- ➔ [“Ink Cartridge Handling Precautions” on page 127](#)
- ➔ [“Ink Cartridge Codes” on page 150](#)

Continue Printing Temporarily without Replacing Ink Cartridges

Temporarily Printing with Black Ink

When color ink is expended and black ink still remains, you can use the following settings to continue printing for a short time using only black ink.

- Type of paper: plain papers, Envelope
- Color: **Grayscale**
- Borderless: Not selected
- EPSON Status Monitor 3: Enabled (for Windows only)

Because this feature is only available for approximately five days, replace the expended ink cartridge as soon as possible.

Note:

- If **EPSON Status Monitor 3** is disabled, access the printer driver, click **Extended Settings** on the **Maintenance** tab, and then select **Enable EPSON Status Monitor 3**.
- The available period varies depending on the usage conditions.

Continue Printing Temporarily with Only Black Ink (Windows)

Do one of the following.

- When the following window is displayed, select **Print in Black**.

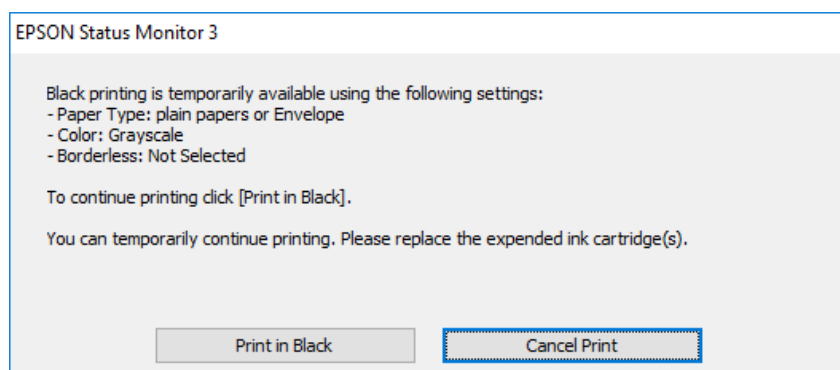

❑ When the following window is displayed, cancel printing. And then, printing again.

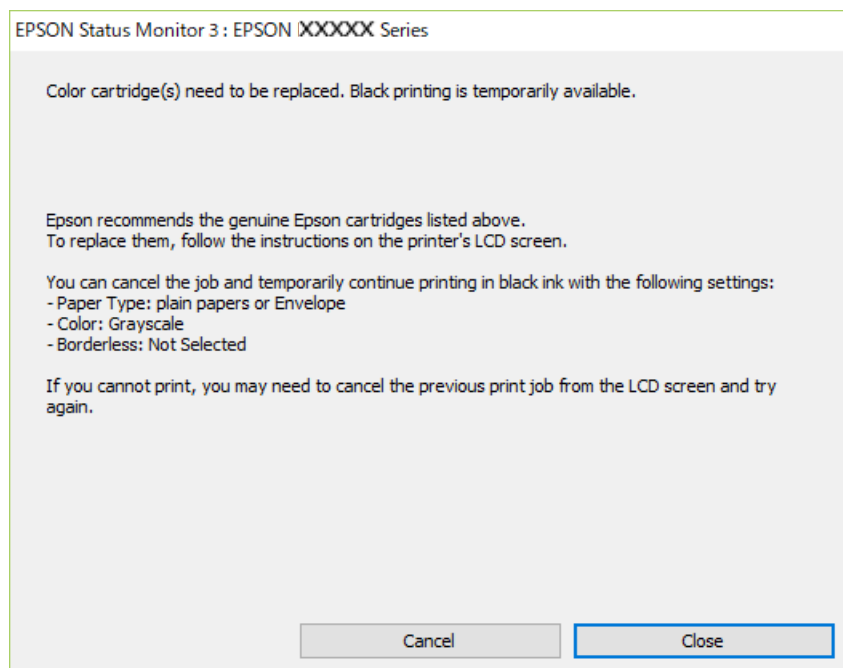

Note:

If you cannot cancel printing from the computer, cancel using the printer's control panel.

Follow the steps below when printing again.

1. Access the printer driver window.
2. Clear **Borderless** on the **Main** tab.
3. Select a **Paper Type** that supports Print in Black.
4. Select **Grayscale**.
5. Set the other items on the **Main** and **More Options** tabs as necessary, and then click **OK**.
6. Click **Print**.
7. Click **Print in Black** in the window displayed.

Related Information

➔ [“Temporarily Printing with Black Ink” on page 137](#)

Continue Printing Temporarily with Only Black Ink (Mac OS)

Note:

*To use this feature through a network, connect with **Bonjour**.*

1. Click the printer icon in the **Dock**.

2. Cancel the job.

Note:

If you cannot cancel printing from the computer, cancel using the printer's control panel.

3. Select **System Preferences** from the Apple menu > **Printers & Scanners** (or **Print & Scan, Print & Fax**), and then select the printer. Click **Options & Supplies** > **Options** (or **Driver**).
4. Select **On** as the **Permit temporary black printing** setting.
5. Access the print dialog.
6. Select **Print Settings** from the pop-up menu.
7. Select any paper size except for a borderless size as the **Paper Size** setting.
8. Select a paper type that supports **Permit temporary black printing** as the **Media Type** setting.
9. Select **Grayscale**.
10. Set the other items as necessary.
11. Click **Print**.

Related Information

➔ [“Temporarily Printing with Black Ink” on page 137](#)

Continue Printing to Conserve Black Ink (for Windows Only)

When black ink is running low and there is enough color ink remaining, you can use a mixture of color inks to create black. You can continue printing while preparing a replacement black ink cartridge.

This feature is only available when you select the following settings in the printer driver.

- Paper Type: Plain paper, Letterhead
- Quality: **Standard**
- EPSON Status Monitor 3: Enabled

Note:

- ❑ If EPSON Status Monitor 3 is disabled, access the printer driver, click **Extended Settings** on the **Maintenance** tab, and then select **Enable EPSON Status Monitor 3**.
- ❑ Composite black looks slightly different from pure black. In addition, the print speed is reduced.
- ❑ To maintain the quality of the print head, black ink is also consumed.

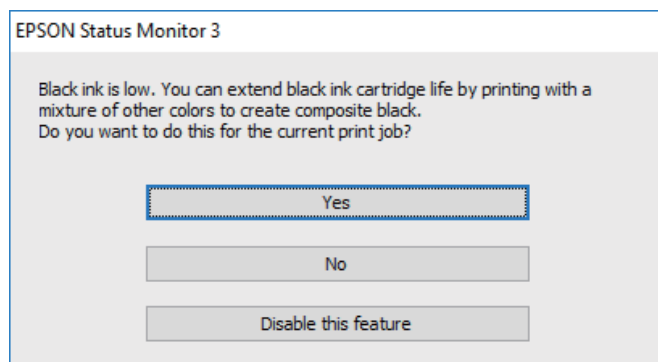

Options	Description
Yes	Select to use a mixture of color inks to create black. This window is displayed the next time you print a similar job.
No	Select to continue using the remaining black ink. This window is displayed the next time you print a similar job.
Disable this feature	Select to continue using the remaining black ink. This window is not displayed until you replace the black ink cartridge and it runs low again.

Cannot Operate the Printer as Expected

The Printer Does Not Turn On or Off

Power Does Not Turn On

The following causes can be considered.

- **The power cord is not plugged in properly to the electrical outlet.**

Solutions

Make sure the power cord is securely plugged in.

- **The  button was not pressed for long enough.**



Solutions

Hold down the  button for a little longer.

Power Does Not Turn Off

■ The  button was not pressed for long enough.

Solutions

Hold down the  button for a little longer. If you still cannot turn off the printer, unplug the power cord. To prevent the print head from drying out, turn the printer back on and turn it off by pressing the  button.

Power Turns Off Automatically

■ The **Power Off Timer** feature or **Power Off If Inactive** and **Power Off If Disconnected** feature is enabled.

Solutions

Windows

Click **Printer and Option Information** on the printer driver's **Maintenance** tab.

Disable the **Power Off If Inactive** and **Power Off If Disconnected** settings.

Disable the **Power Off Timer** setting.

Mac OS

Select **System Preferences** from the Apple menu > **Printers & Scanners** (or **Print & Scan**, **Print & Fax**), and then select the printer. Click **Options & Supplies** > **Utility** > **Open Printer Utility**, and then click **Printer Settings**.

Disable the **Power Off If Inactive** and **Power Off If Disconnected** settings.

Disable the **Power Off Timer** setting.

Note:

*Your product may have the **Power Off Timer** feature or **Power Off If Inactive** and **Power Off If Disconnected** features depending on the location of purchase.*

Operations are Slow

Printing Is Too Slow

The following causes can be considered.

■ **Unnecessary applications are running.**

Solutions

Close any unnecessary applications on your computer or smart device.

■ **The print quality is set to high.**

Solutions

Lower the quality setting.

■ Bidirectional printing is disabled.

Solutions

Enable the bidirectional (or high speed) setting. When this setting is enabled, the print head prints while moving in both directions, and the printing speed increases.

Windows

Select **Bidirectional Printing** on the printer driver's **More Options** tab.

Mac OS

Select **System Preferences** from the Apple menu > **Printers & Scanners** (or **Print & Scan, Print & Fax**), and then select the printer. Click **Options & Supplies > Options** (or **Driver**). Select **On** as the **Bidirectional Printing** setting.

■ Quiet Mode is enabled.

Solutions

Disable **Quiet Mode**. The printing speed slows down when the printer is running in **Quiet Mode**.

Windows

Select **Off** as the **Quiet Mode** setting on the printer driver's **Main** tab.

Mac OS

Select **System Preferences** from the Apple menu > **Printers & Scanners** (or **Print & Scan, Print & Fax**), and then select the printer. Click **Options & Supplies > Options** (or **Driver**). Select **Off** as the **Quiet Mode** setting.

■ There may be network connection problems with the wireless router.

Solutions

Reboot the wireless router while taking into consideration other users connected to the network. If this does not solve the problem, place the printer closer to your wireless router or see the documentation provided with the access point.

■ The printer is printing high density data such as photos on plain paper.

Solutions

If you are printing high-density data such as photos on plain paper, printing may take some time to maintain print quality. This is not a malfunction.

Printing Slows Down Dramatically During Continuous Printing

■ The function that prevents the printer mechanism from overheating and being damaged is operating.

Solutions

You can continue printing. To return to normal printing speed, leave the printer idle for at least 30 minutes. Printing speed does not return to normal if the power is off.

Scanning Speed Is Slow

■ Scanning at a high resolution.

Solutions

Try scanning at a lower resolution.

Operation Sounds Are Loud

■ Quiet Mode is disabled.

Solutions

If operations sounds are too loud, enable **Quiet Mode**. Enabling this feature may reduce printing speed.

- Windows printer driver

Enable **Quiet Mode** on the **Main** tab.

- Mac OS printer driver

Select **System Preferences** from the Apple menu > **Printers & Scanners** (or **Print & Scan, Print & Fax**), and then select the printer. Click **Options & Supplies** > **Options** (or **Driver**). Select **On** as the **Quiet Mode** setting.

The Root Certificate Needs to be Updated

■ The root certificate has expired.

Solutions

Run Web Config, and then update the root certificate.

➔ [“Application for Configuring Printer Operations \(Web Config\)” on page 153](#)

Cannot Perform Manual 2-sided Printing (Windows)

■ EPSON Status Monitor 3 is disabled.

Solutions

On the printer driver's **Maintenance** tab, click **Extended Settings**, and then select **Enable EPSON Status Monitor 3**.

However, it may not be available when the printer is accessed over a network or is used as a shared printer.

The Print Settings Menu is Not Displayed (Mac OS)

■ The Epson Printer Driver has Not been Installed Correctly.

Solutions

If the **Print Settings** menu is not displayed on macOS Catalina (10.15) or later, macOS High Sierra (10.13), macOS Sierra (10.12), OS X El Capitan (10.11), OS X Yosemite (10.10), OS X Mavericks (10.9), the Epson printer driver has not been installed correctly. Enable it from the following menu.

Select **System Preferences** from the Apple menu > **Printers & Scanners** (or **Print & Scan, Print & Fax**), remove the printer, and then add the printer again.

macOS Mojave (10.14) cannot access **Print Settings** in applications made by Apple such as TextEdit.

Cannot Solve Problem

If you cannot solve the problem after trying all of the solutions, contact Epson support.

If you cannot solve printing or copying problems, see the following related information.

Related Information

➔ [“Cannot Solve Printing or Copying Problems” on page 144](#)

Cannot Solve Printing or Copying Problems

Try the following problems in order starting at the top until you solve the problem.

Make sure you match the paper type loaded in the printer to the paper type settings in the printer driver.

Use a higher quality setting on the printer driver.

Reinstall the ink cartridges already installed in the printer.

Reinstalling the ink cartridges may clear clogging in the print head nozzles and allow the ink to flow smoothly.

However, because the ink is consumed when the ink cartridge is reinstalled, a message asking you to replace the ink cartridge may be displayed depending on the amount of ink remaining.

[“It is Time to Replace the Ink Cartridges” on page 127](#)

Align the print head.

[“Aligning the Print Head” on page 66](#)

Run a nozzle check to see if the print head nozzles are clogged.

If there are missing segments in the nozzle check pattern, the nozzles may be clogged. Repeat head cleaning and the nozzle check alternately 3 times and check if the clogging has cleared.

Note that print head cleaning uses some ink.

[“Checking and Cleaning the Print Head” on page 62](#)

Turn off the printer, wait for at least 12 hours, and then check if the clogging has cleared.

If the problem is clogging, leaving the printer for a while without printing may solve the problem.

You can check the following items while the printer is off.

Check that you are using genuine Epson ink cartridges.

Try to use genuine Epson ink cartridges. This product is designed to adjust colors based on the use of genuine Epson ink cartridges. The use of non-genuine ink cartridges may cause print quality to decline.

[“Ink Cartridge Codes” on page 150](#)

Check if the translucent film is smeared.

If there are smears on the translucent film, carefully wipe off the smear.

[“Cleaning the Translucent Film” on page 68](#)

Make sure that there are no paper fragments left inside the printer.

When you remove the paper, do not touch the translucent film with your hand or the paper.

Check the paper.

Check if the paper is curled or loaded with the printable side facing up.

[“Paper Handling Precautions” on page 25](#)

[“Available Paper and Capacities” on page 147](#)

[“Unavailable Paper Types” on page 149](#)

Make sure that you are not using an old ink cartridge.

For best results, Epson recommends using up ink cartridges before the best before date printed on the package, or within six months of opening the package, whichever is earlier.

If you turn off the printer, wait for at least 12 hours, and if print quality has still not improved, run Power Cleaning.

[“Running Power Cleaning” on page 64](#)

If you cannot solve the problem by checking the solutions above, you may need to request repairs. Contact Epson support.

Related Information

➔ [“Before Contacting Epson” on page 163](#)

➔ [“Contacting Epson Support” on page 163](#)

Product Information

Paper Information.	147
Consumable Products Information.	150
Software Information.	151
Product Specifications.	154
Regulatory Information.	160

Paper Information

Available Paper and Capacities

Genuine Epson Paper

Epson recommends using genuine Epson paper to ensure high-quality printouts.

Note:

- ❑ *The availability of paper varies by location. For the latest information on paper available in your area, contact Epson support.*
- ❑ *See the following for information on available paper types for borderless and 2-sided printing.*
[“Paper for Borderless Printing” on page 148](#)
[“Paper for 2-Sided Printing” on page 149](#)

Paper suitable for printing documents

Media Name	Size	Loading Capacity (Sheets)
Epson Bright White Ink Jet Paper	A4	Up to the line indicated by the triangle symbol on the edge guide.
Epson Business Paper	A4	Up to the line indicated by the triangle symbol on the edge guide.

Paper suitable for printing documents and photos

Media Name	Size	Loading Capacity (Sheets)
Epson Matte Paper-Heavyweight	A4	20
Epson Photo Quality Ink Jet Paper	A4	40

Paper suitable for printing photos

Media Name	Size	Loading Capacity (Sheets)
Epson Ultra Glossy Photo Paper	A4, 13×18 cm (5×7 in.), 10×15 cm (4×6 in.)	10*
Epson Premium Glossy Photo Paper	A4, 13×18 cm (5×7 in.), 16:9 wide size(102x181 mm), 10×15 cm (4×6 in.)	10*
Epson Premium Semigloss Photo Paper	A4, 13×18 cm (5×7 in.), 10×15 cm (4×6 in.)	10*
Epson Photo Paper Glossy	A4, 13×18 cm (5×7 in.), 10×15 cm (4×6 in.)	10*

* Load one sheet of paper at a time if the paper does not feed correctly or if the printout has uneven colors or smears.

Various other paper types 

Media Name	Size	Loading Capacity (Sheets)
Epson Photo Quality Self Adhesive Sheets	A4	1

Commercially Available Paper

Note:

See the following for information on available paper types for borderless and 2-sided printing.

[“Paper for Borderless Printing” on page 148](#)

[“Paper for 2-Sided Printing” on page 149](#)

Plain papers

Media Name	Size	Loading Capacity (Sheets)
Plain paper Copy paper	Letter, A4, B5, 16K (195×270 mm), A5, A6, B6	Up to the line indicated by the triangle symbol on the edge guide.*
	Legal, 8.5×13 in., Indian-Legal	1
	User Defined (mm) 89×127 to 215.9×1200	1

* Load one sheet of paper at a time if the paper does not feed correctly or if the printout has uneven colors or smears.

Envelopes

Media Name	Size	Loading Capacity (Envelopes)
Envelope	Envelope #10, Envelope DL, Envelope C6	5

Paper for Borderless Printing

Genuine Epson Paper

- Epson Bright White Ink Jet Paper
- Epson Business Paper
- Epson Photo Quality Ink Jet Paper
- Epson Matte Paper-Heavyweight
- Epson Ultra Glossy Photo Paper
- Epson Premium Glossy Photo Paper
- Epson Premium Semigloss Photo Paper
- Epson Photo Paper Glossy

- Epson Photo Quality Self Adhesive Sheets

Related Information

- ➔ [“Available Paper and Capacities” on page 147](#)

Commercially Available Paper

Plain paper, Copy paper (A4, Letter, User Defined)

Related Information

- ➔ [“Available Paper and Capacities” on page 147](#)

Paper for 2-Sided Printing

Genuine Epson Paper

- Epson Bright White Ink Jet Paper
- Epson Business Paper

Related Information

- ➔ [“Available Paper and Capacities” on page 147](#)

Commercially Available Paper

Plain paper, Copy paper

Related Information

- ➔ [“Available Paper and Capacities” on page 147](#)

Unavailable Paper Types

Do not use the following papers. Using these types of paper causes paper jams and smears on the printout.

- Papers that are wavy
- Papers that are torn or cut
- Papers that are folded
- Papers that are damp
- Papers that are too thick or too thin
- Papers that have stickers

Do not use the following envelopes. Using these types of envelope causes paper jams and smears on the printout.

- Envelopes that are curled or folded
- Envelopes with adhesive surfaces on the flaps or window envelopes

- Envelopes that are too thin
They may curl during printing.

Consumable Products Information

Ink Cartridge Codes

The following are the codes for genuine Epson ink cartridges.

Note:

- Ink cartridge codes may vary by location. For the correct codes in your area, contact Epson support.
- Not all cartridges are available in all regions.
- Although the ink cartridges may contain recycled materials, this does not affect printer function or performance.
- Specifications and appearance of the ink cartridge are subject to change without prior notice for improvement.

For Europe

Icon	BK: Black	C: Cyan	M: Magenta	Y: Yellow
Pineapple 	604 604XL*	604 604XL*	604 604XL*	604 604XL*

* "XL" indicates a large cartridge.

Note:

For users in Europe, visit the following website for information on Epson's ink cartridge yields.

<http://www.epson.eu/pageyield>

For Australia and New Zealand

Product	BK: Black	C: Cyan	M: Magenta	Y: Yellow
XP-2200	604 604XL*	604 604XL*	604 604XL*	604 604XL*
XP-2205	49 49XL*	49 49XL*	49 49XL*	49 49XL*

* "XL" indicates a large cartridge.

For Asia

BK: Black	C: Cyan	M: Magenta	Y: Yellow
10J	10J	10J	10J

Epson recommends the use of genuine Epson ink cartridges. Epson cannot guarantee the quality or reliability of non-genuine ink. The use of non-genuine ink may cause damage that is not covered by Epson's warranties, and under certain circumstances, may cause erratic printer behavior. Information about non-genuine ink levels may not be displayed.

Software Information

This section introduces some of the applications available for your printer. For a list of supported software, see the following Epson website or launch Epson Software Updater for confirmation. You can download the latest applications.

<http://www.epson.com>

Related Information

➔ “Application for Updating Software and Firmware (Epson Software Updater)” on page 153

Application for Printing from a Computer (Windows Printer Driver)

The printer driver controls the printer according to the commands from an application. Making settings on the printer driver provides the best printing results. You can also check the status of the printer or keep it in top operating condition using the printer driver utility.

Note:

You can change the language of the printer driver. Select the language you want to use from the **Language** setting on the **Maintenance** tab.

Accessing the printer driver from applications

To make settings that apply only to the application you are using, access from that application.

Select **Print** or **Print Setup** from the **File** menu. Select your printer, and then click **Preferences** or **Properties**.

Note:

Operations differ depending on the application. See the application's help for details.

Accessing the printer driver from the control panel

To make settings that apply to all of the applications, access from the control panel.

❑ Windows 11

Click on the start button, and then select **All apps > Windows Tools > Control Panel > View devices and printers** in **Hardware and Sound**. Right-click on your printer, or press and hold it and then select **Printing preferences**.

❑ Windows 10

Click on the start button, and then select **Windows System > Control Panel > View devices and printers** in **Hardware and Sound**. Right-click on your printer, or press and hold it and then select **Printing preferences**.

Windows 8.1/Windows 8

Select **Desktop > Settings > Control Panel > View devices and printers** in **Hardware and Sound**. Right-click on your printer, or press and hold it and then select **Printing preferences**.

Windows 7

Click the start button, and select **Control Panel > View devices and printers** in **Hardware and Sound**. Right-click on your printer and select **Printing preferences**.

Windows Vista

Click the start button, and select **Control Panel > Printers** in **Hardware and Sound**. Right-click on your printer and select **Printing preferences**.

Windows XP

Click the start button, and select **Control Panel > Printers and Other Hardware > Printers and Faxes**. Right-click on your printer and select **Printing preferences**.

Accessing the printer driver from the printer icon on the task bar

The printer icon on the desktop task bar is a shortcut icon allowing you to quickly access the printer driver.

If you click the printer icon and select **Printer Settings**, you can access the same printer settings window as the one displayed from the control panel. If you double-click this icon, you can check the status of the printer.

Note:

*If the printer icon is not displayed on the task bar, access the printer driver window, click **Monitoring Preferences** on the **Maintenance** tab, and then select **Register the shortcut icon to the taskbar**.*

Starting the utility

Access the printer driver window. Click the **Maintenance** tab.

Application for Printing from a Computer (Mac OS Printer Driver)

The printer driver controls the printer according to the commands from an application. Making settings on the printer driver provides the best printing results. You can also check the status of the printer or keep it in top operating condition using the printer driver utility.

Accessing the printer driver from applications

Click **Page Setup** or **Print** on the **File** menu of your application. If necessary, click **Show Details** (or ▼) to expand the print window.

Note:

*Depending on the application being used, **Page Setup** may not be displayed in the **File** menu, and the operations for displaying the print screen may differ. See the application's help for details.*

Starting the utility

Select **System Preferences** from the Apple menu > **Printers & Scanners** (or **Print & Scan, Print & Fax**), and then select the printer. Click **Options & Supplies > Utility > Open Printer Utility**.

Application for Configuring Printer Operations (Web Config)

Web Config is an application that runs in a web browser, such as Internet Explorer and Safari, on a computer or smart device. You can confirm the printer status or change the network service and printer settings. To use the Web Config, connect the printer and the computer or device to the same network.

The following browsers are supported.

Microsoft Edge, Internet Explorer 8 or later, Firefox*, Chrome*, Safari*

* Use the latest version.

Note:

The initial value of the Web Config administrator password is the serial number of the printer. Check the label attached to the printer.

The label attachment position depends on the product; it may be on the back, the open side of the cover, or the bottom.

Running Web Config on a Web Browser

1. Check the printer's IP address.

Hold down the  button for at least 5 seconds to print the network status sheet, and then check the printer's IP address.

2. Launch a Web browser from a computer or smart device, and then enter the printer's IP address.

Format:

IPv4: http://the printer's IP address/

IPv6: http://[the printer's IP address]/

Examples:

IPv4: http://192.168.100.201/

IPv6: http://[2001:db8::1000:1]/

Note:

Using the smart device, you can also run Web Config from the product information screen of the Epson Smart Panel.

Since the printer uses a self-signed certificate when accessing HTTPS, a warning is displayed on the browser when you start Web Config; this does not indicate a problem and can be safely ignored.

Application for Updating Software and Firmware (Epson Software Updater)

Epson Software Updater is an application that installs new software, and updates firmware over the Internet. If you want to check for update information regularly, you can set the interval for checking for updates in Epson Software Updater's Auto Update Settings.

Starting on Windows

- Windows 11

Click the start button, and then select **All apps > EPSON Software > Epson Software Updater**.

Windows 10

Click the start button, and then select **EPSON Software > Epson Software Updater**.

Windows 8.1/Windows 8

Enter the application name in the search charm, and then select the displayed icon.

Windows 7/Windows Vista/Windows XP

Click the start button, and then select **All Programs (or Programs) > EPSON Software > Epson Software Updater**.

Note:

You can also start Epson Software Updater by clicking the printer icon on the task bar on the desktop, and then selecting **Software Update**.

Starting on Mac OS

Select **Go > Applications > Epson Software > Epson Software Updater**.

Related Information

➔ [“Installing the Applications Separately” on page 74](#)

Product Specifications

Printer Specifications

Print Head Nozzle Placement		Black ink nozzles: 180 Color ink nozzles: 59 for each color
Weight of Paper*	Plain Paper	64 to 90 g/m ²
	Envelopes	75 to 100 g/m ²

* Even when the paper thickness is within this range, the paper may not feed in the printer or the print quality may decline depending on the paper properties or quality.

Printable Area

Printable Area for Single Sheets

Print quality may decline in the shaded areas due to the printer's mechanism.

Printing with borders

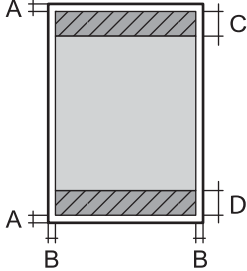
	A	3.0 mm (0.12 in.)
	B	3.0 mm (0.12 in.)
	C	40.0 mm (1.57 in.)
	D	32.0 mm (1.26 in.)

Borderless printing

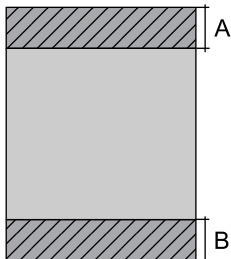
	A	43.0 mm (1.69 in.)
	B	35.0 mm (1.38 in.)

Printable Area for Envelopes

Print quality may decline in the shaded areas due to the printer's mechanism.

	A	3.0 mm (0.12 in.)
	B	3.0 mm (0.12 in.)
	C	18.0 mm (0.71 in.)
	D	40.0 mm (1.57 in.)

Scanner Specifications

Scanner Type	Flatbed
Photoelectric Device	CIS
Maximum Document Size	216×297 mm (8.5×11.7 in.) A4, Letter
Resolution	1200 dpi (main scan) 2400 dpi (sub scan)

Color Depth	<p>Color</p> <ul style="list-style-type: none"> <input type="checkbox"/> 48 bits per pixel internal (16 bits per pixel per color internal) <input type="checkbox"/> 24 bits per pixel external (8 bits per pixel per color external) <p>Grayscale</p> <ul style="list-style-type: none"> <input type="checkbox"/> 16 bits per pixel internal <input type="checkbox"/> 8 bits per pixel external <p>Black and white</p> <ul style="list-style-type: none"> <input type="checkbox"/> 16 bits per pixel internal <input type="checkbox"/> 1 bits per pixel external
Light Source	LED

Interface Specifications

For Computer	Hi-Speed USB*
--------------	---------------

* USB 3.0 cables are not supported.

Network Specifications

Wi-Fi Specifications

Standards	IEEE802.11b/g/n* ¹
Frequency Range	2.4 GHz
Coordination Modes	Infrastructure, Wi-Fi Direct (Simple AP)* ^{2*3}
Wireless Securities* ⁴	WEP (64/128bit), WPA2-PSK (AES)* ⁵ , WPA3-SAE (AES)

*1 IEEE802.11n is only available for the HT20.

*2 Not supported for IEEE 802.11b.

*3 Simple AP mode is compatible with a Wi-Fi connection (infrastructure).

*4 Wi-Fi Direct supports WPA2-PSK (AES) only.

*5 Complies with WPA2 standards with support for WPA/WPA2 Personal.

Network Functions and IPv4/IPv6

Functions			Supported	Remarks
Network Printing	EpsonNet Print (Windows)	IPv4	✓	-
	Standard TCP/IP (Windows)	IPv4, IPv6	✓	-
	WSD Printing (Windows)	IPv4, IPv6	✓	Windows Vista or later
	Bonjour Printing (Mac OS)	IPv4, IPv6	✓	-
	IPP Printing (Windows, Mac OS)	IPv4, IPv6	-	-
	PictBridge Printing (Wi-Fi)	IPv4	-	Digital camera
	Epson Connect (Email Print, Remote Print)	IPv4	✓	-
Network Scanning	Epson Scan 2	IPv4, IPv6	✓	-
	Epson ScanSmart	IPv4	✓	Windows 7 or later, or OS X El Capitan (10.11) or later
	Event Manager	IPv4	✓	Windows Vista/Windows XP, or OS X Yosemite (10.10)/OS X Mavericks (10.9.5)
	Epson Connect (Scan to Cloud)	IPv4	-	-
Fax	Send a fax	IPv4	-	-
	Receive a fax	IPv4	-	-

Security Protocol

SSL/TLS	HTTPS Server/Client
SNMPv3	

Dimensions

Dimensions	<p>Storage</p> <ul style="list-style-type: none"> ❑ Width: 390 mm (15.4 in.) ❑ Depth: 300 mm (11.8 in.) ❑ Height: 146 mm (5.7 in.) <p>Printing</p> <ul style="list-style-type: none"> ❑ Width: 390 mm (15.4 in.) ❑ Depth: 504 mm (19.8 in.) ❑ Height: 279 mm (11.0 in.)
Weight*	Approx. 4.0 kg (8.8 lb)

* Without the ink cartridges and the power cord.

Electrical Specifications

Power Supply Rating	AC 100-240 V	AC 220-240 V
Rated Frequency Range	50-60 Hz	50-60 Hz
Rated Current	0.4-0.2 A	0.2 A
Power Consumption (with USB Connection)	<p>Standalone copying: Approx. 12.0 W (ISO/IEC24712)</p> <p>Ready mode: Approx. 4.6 W</p> <p>Sleep mode: Approx. 0.8 W</p> <p>Power off: Approx. 0.3 W</p>	<p>Standalone copying: Approx. 12.0 W (ISO/IEC24712)</p> <p>Ready mode: Approx. 4.6 W</p> <p>Sleep mode: Approx. 0.8 W</p> <p>Power off: Approx. 0.3 W</p>

Note:

- ❑ Check the label on the printer for its voltage.
- ❑ For European users, see the following Website for details on power consumption.
<http://www.epson.eu/energy-consumption>

Environmental Specifications

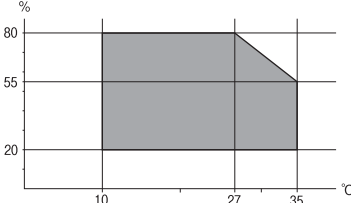
<p>Operation</p>	<p>Use the printer within the range shown in the following graph.</p>  <p>Temperature: 10 to 35°C (50 to 95°F) Humidity: 20 to 80% RH (without condensation)</p>
<p>Storage</p>	<p>Temperature: -20 to 40°C (-4 to 104°F)* Humidity: 5 to 85% RH (without condensation)</p>

* You can store for one month at 40°C (104°F).

Environmental Specifications for Ink Cartridges

<p>Storage Temperature</p>	<p>-30 to 40 °C (-22 to 104 °F)*</p>
<p>Freezing Temperature</p>	<p>-16 °C (3.2 °F) Ink thaws and is usable after approximately 3 hours at 25 °C (77 °F).</p>

* You can store for one month at 40 °C (104 °F).

System Requirements

Windows

Windows Vista, Windows 7, Windows 8/8.1, Windows 10, Windows 11 or later

Windows XP SP3 (32-bit)

Windows XP Professional x64 Edition SP2

Mac OS

Mac OS X 10.9.5 or later, macOS 11 or later

Note:

Mac OS may not support some applications and features.

The UNIX File System (UFS) for Mac OS is not supported.

Regulatory Information

Standards and Approvals

Standards and Approvals for European Model

For European users

Hereby, Seiko Epson Corporation declares that the following radio equipment model is in compliance with Directive 2014/53/EU. The full text of the EU declaration of conformity is available at the following website.

<http://www.epson.eu/conformity>

C671B

For use only in Ireland, UK, Austria, Germany, Liechtenstein, Switzerland, France, Belgium, Luxemburg, Netherlands, Italy, Portugal, Spain, Denmark, Finland, Norway, Sweden, Iceland, Croatia, Cyprus, Greece, Slovenia, Malta, Bulgaria, Czech, Estonia, Hungary, Latvia, Lithuania, Poland, Romania, and Slovakia.

Epson cannot accept responsibility for any failure to satisfy the protection requirements resulting from a non-recommended modification of the products.



Standards and Approvals for Australian Model

EMC	AS/NZS CISPR32 Class B
-----	------------------------

Epson hereby declares that the following equipment Models are in compliance with the essential requirements and other relevant provisions of AS/NZS4268:

C671B

Epson cannot accept responsibility for any failure to satisfy the protection requirements resulting from a non-recommended modification of the products.

Restrictions on Copying

Observe the following restrictions to ensure the responsible and legal use of the printer.

Copying of the following items is prohibited by law:

- Bank bills, coins, government-issued marketable securities, government bond securities, and municipal securities
- Unused postage stamps, pre-stamped postcards, and other official postal items bearing valid postage
- Government-issued revenue stamps, and securities issued according to legal procedure

Exercise caution when copying the following items:

- Private marketable securities (stock certificates, negotiable notes, checks, etc.), monthly passes, concession tickets, etc.

- Passports, driver's licenses, warrants of fitness, road passes, food stamps, tickets, etc.

Note:

Copying these items may also be prohibited by law.

Responsible use of copyrighted materials:

Printers can be misused by improperly copying copyrighted materials. Unless acting on the advice of a knowledgeable attorney, be responsible and respectful by obtaining the permission of the copyright holder before copying published material.

Where to Get Help

Technical Support Web Site.	163
Contacting Epson Support.	163

Technical Support Web Site

If you need further help, visit the Epson support website shown below. Select your country or region and go to the support section of your local Epson website. The latest drivers, FAQs, manuals, or other downloadables are also available from the site.

<http://support.epson.net/>

<http://www.epson.eu/support> (Europe)

If your Epson product is not operating properly and you cannot solve the problem, contact Epson support services for assistance.

Contacting Epson Support

Before Contacting Epson

If your Epson product is not operating properly and you cannot solve the problem using the troubleshooting information in your product manuals, contact Epson support services for assistance.

The following Epson support list is based on the country of sale. Some products may not be sold in your current location, so be sure to contact Epson support for the area in which you purchased your product.

If Epson support for your area is not listed below, contact the dealer where you purchased your product.

Epson support will be able to help you much more quickly if you give them the following information:

- Product serial number
(The serial number label is usually on the back of the product.)
- Product model
- Product software version
(Click **About**, **Version Info**, or a similar button in the product software.)
- Brand and model of your computer
- Your computer operating system name and version
- Names and versions of the software applications you normally use with your product

Note:

Depending on the product, network settings may be stored in the product's memory. Due to breakdown or repair of a product, settings may be lost. Epson shall not be responsible for the loss of any data, for backing up or recovering settings even during a warranty period. We recommend that you make your own backup data or take notes.

Help for Users in Europe

Check your Pan-European Warranty Document for information on how to contact Epson support.

Help for Users in Taiwan

Contacts for information, support, and services are:

World Wide Web

<http://www.epson.com.tw>

Information on product specifications, drivers for download, and products enquiry are available.

Epson HelpDesk

Phone: +886-2-2165-3138

Our HelpDesk team can help you with the following over the phone:

- Sales enquiries and product information
- Product usage questions or problems
- Enquiries on repair service and warranty

Repair service center:

<http://www.tekcare.com.tw/branchMap.page>

TekCare corporation is an authorized service center for Epson Taiwan Technology & Trading Ltd.

Help for Users in Australia

Epson Australia wishes to provide you with a high level of customer service. In addition to your product manuals, we provide the following sources for obtaining information:

Internet URL

<http://www.epson.com.au>

Access the Epson Australia World Wide Web pages. Worth taking your modem here for the occasional surf! The site provides a download area for drivers, Epson contact points, new product information and technical support (e-mail).

Epson Helpdesk

Phone: 1300-361-054

Epson Helpdesk is provided as a final backup to make sure our clients have access to advice. Operators on the Helpdesk can aid you in installing, configuring and operating your Epson product. Our Pre-sales Helpdesk staff can provide literature on new Epson products and advise where the nearest dealer or service agent is located. Many types of queries are answered here.

We encourage you to have all the relevant information on hand when you ring. The more information you prepare, the faster we can help solve the problem. This information includes your Epson product manuals, type of computer, operating system, application programs, and any information you feel is required.

Transportation of Product

Epson recommends retaining product packaging for future transportation.

Help for Users in New Zealand

Epson New Zealand wishes to provide you with a high level of customer service. In addition to your product documentation, we provide the following sources for obtaining information:

Internet URL

<http://www.epson.co.nz>

Access the Epson New Zealand World Wide Web pages. Worth taking your modem here for the occasional surf! The site provides a download area for drivers, Epson contact points, new product information and technical support (e-mail).

Epson Helpdesk

Phone: 0800 237 766

Epson Helpdesk is provided as a final backup to make sure our clients have access to advice. Operators on the Helpdesk can aid you in installing, configuring and operating your Epson product. Our Pre-sales Helpdesk staff can provide literature on new Epson products and advise where the nearest dealer or service agent is located. Many types of queries are answered here.

We encourage you to have all the relevant information on hand when you ring. The more information you prepare, the faster we can help solve the problem. This information includes your Epson product documentation, type of computer, operating system, application programs, and any information you feel is required.

Transportation of Product

Epson recommends retaining product packaging for future transportation.

Help for Users in Singapore

Sources of information, support, and services available from Epson Singapore are:

World Wide Web

<http://www.epson.com.sg>

Information on product specifications, drivers for download, Frequently Asked Questions (FAQ), Sales Enquiries, and Technical Support via e-mail are available.

Epson HelpDesk

Toll Free: 800-120-5564

Our HelpDesk team can help you with the following over the phone:

- Sales enquiries and product information
- Product usage questions or problem troubleshooting
- Enquiries on repair service and warranty

Help for Users in Thailand

Contacts for information, support, and services are:

World Wide Web

<http://www.epson.co.th>

Information on product specifications, drivers for download, Frequently Asked Questions (FAQ), and e-mail are available.

Epson Call Centre

Phone: 66-2460-9699

Email: support@eth.epson.co.th

Our Call Centre team can help you with the following over the phone:

- Sales enquiries and product information
- Product usage questions or problems
- Enquiries on repair service and warranty

Help for Users in Vietnam

Contacts for information, support, and services are:

Epson Service Center

65 Truong Dinh Street, District 1, Ho Chi Minh City, Vietnam.

Phone(Ho Chi Minh City): 84-8-3823-9239, 84-8-3825-6234

29 Tue Tinh, Quan Hai Ba Trung, Hanoi City, Vietnam

Phone(Hanoi City): 84-4-3978-4785, 84-4-3978-4775

Help for Users in Indonesia

Contacts for information, support, and services are:

World Wide Web

<http://www.epson.co.id>

- Information on product specifications, drivers for download
- Frequently Asked Questions (FAQ), Sales Enquiries, questions through e-mail

Epson Hotline

Phone: +62-1500-766

Fax: +62-21-808-66-799

Our Hotline team can help you with the following over the phone or fax:

- Sales enquiries and product information
- Technical support

Epson Service Center

Province	Company Name	Address	Phone E-mail
JAKARTA	Epson Sales and Service Jakarta (SUDIRMAN)	Wisma Keiai Lt. 1 Jl. Jenderal Sudirman Kav. 3 Jakarta Pusat - DKI JAKARTA 10220	021-5724335 ess@epson-indonesia.co.id ess.support@epson-indonesia.co.id
SERPONG	Epson Sales and Service Serpong	Ruko Melati Mas Square Blok A2 No.17 Serpong-Banten	082120090084 / 082120090085 esstag@epson-indonesia.co.id esstag.support@epson-indonesia.co.id
SEMARANG	Epson Sales and Service Semarang	Komplek Ruko Metro Plaza Block C20 Jl. MT Haryono No. 970 Semarang -JAWA TENGAH	024 8313807 / 024 8417935 esssmg@epson-indonesia.co.id esssmg.support@epson-indonesia.co.id
JAKARTA	Epson Sales and Service Jakarta (MANGGA DUA)	Ruko Mall Mangga Dua No. 48 Jl. Arteri Mangga Dua, Jakarta Utara - DKI JAKARTA	021 623 01104 jkt-technical1@epson-indonesia.co.id jkt-admin@epson-indonesia.co.id
BANDUNG	Epson Sales and Service Bandung	Jl. Cihampelas No. 48 A Bandung Jawa Barat 40116	022 420 7033 bdg-technical@epson-indonesia.co.id bdg-admin@epson-indonesia.co.id
MAKASSAR	Epson Sales and Service Makassar	Jl. Cendrawasih NO. 3A, kunjung mae, mariso, MAKASSAR - SULSEL 90125	0411- 8911071 mksr-technical@epson-indonesia.co.id mksr-admin@epson-indonesia.co.id
MEDAN	Epson Service Center Medan	Jl. Bambu 2 Komplek Graha Niaga Nomor A-4, Medan - SUMUT	061- 42066090 / 42066091 mdn-technical@epson-indonesia.co.id mdn-adm@epson-indonesia.co.id
PALEMBANG	Epson Service Center Palembang	Jl. H.M Rasyid Nawawi No. 249 Kelurahan 9 Ilir Palembang Sumatera Selatan	0711 311 330 escplg@epson-indonesia.co.id escplg.support@epson-indonesia.co.id
PEKANBARU	Epson Service Center Pekanbaru	Jl. Tuanku Tambusai No. 459 A Kel. Tangkerang barat Kec Marpoyan damai Pekanbaru - Riau 28282	0761- 8524695 pkb-technical@epson-indonesia.co.id pkb-admin@epson-indonesia.co.id
PONTIANAK	Epson Service Center Pontianak	Komp. A yani Sentra Bisnis G33, Jl. Ahmad Yani - Pontianak Kalimantan Barat	0561- 735507 / 767049 pontianak-technical@epson-indonesia.co.id pontianak-admin@epson-indonesia.co.id
SAMARINDA	Epson Service Center Samarinda	Jl. KH. Wahid Hasyim (M. Yamin) Kelurahan Sempaja Selatan Kecamatan Samarinda UTARA - SAMARINDA - KALTIM	0541 7272 904 escsmd@epson-indonesia.co.id escsmd.support@epson-indonesia.co.id

Province	Company Name	Address	Phone E-mail
SURABAYA	Epson Sales & Service Surabaya (barat)	Jl. Haji Abdul Wahab Saimin, Ruko Villa Bukit Mas RM-11, Kec. Dukuh Pakis, Surabaya - 60225	031- 5120994 sby-technical@epson-indonesia.co.id sby-admin@epson-indonesia.co.id
YOGYAKARTA	Epson Service Center Yogyakarta	YAP Square, Block A No. 6 Jl. C Simanjutak Yogyakarta - DIY	0274 581 065 ygy-technical@epson-indonesia.co.id ygy-admin@epson-indonesia.co.id
JEMBER	Epson Service Center Jember	JL. Panglima Besar Sudirman Ruko no.1D Jember-Jawa Timur (Depan Balai Penelitian & Pengolahan Kakao)	0331- 488373 / 486468 jmr-admin@epson-indonesia.co.id jmr-technical@epson-indonesia.co.id
MANADO	EPSON SALES AND SERVICE Manado	Jl. Piere Tendean Blok D No 4 Kawasan Mega Mas Boulevard - Manado 95111	0431- 8805896 MND-ADMIN@EPSON-INDONESIA.CO.ID MND-TECHNICAL@EPSON-INDONESIA.CO.ID
CIREBON	EPSON SERVICE CENTER Cirebon	Jl. Tuparev No. 04 (Depan Hotel Apita) Cirebon, JAWA BARAT	0231– 8800846 cbn-technical@epson-indonesia.co.id
CIKARANG	EPSON SALES AND SERVICE CIKARANG	Ruko Metro Boulevard B1 Jababeka cikarang - Jawa Barat,	021- 89844301 / 29082424 ckg-admin@epson-indonesia.co.id ckg-technical@epson-indonesia.co.id
MADIUN	EPSON SERVICE CENTER MADIUN	Jl. Diponegoro No.56, MADIUN - JAWA TIMUR	0351- 4770248 mun-admin@epson-indonesia.co.id mun-technical@epson-indonesia.co.id
PURWOKERTO	EPSON SALES AND SERVICE Purwokerto	Jl. Jendral Sudirman No. 4 Kranji Purwokerto - JAWA TENGAH	0281- 6512213 pwt-admin@epson-indonesia.co.id pwt-technical@epson-indonesia.co.id
BOGOR	EPSON SALES AND SERVICE Bogor	Jl.Pajajaran No 15B Kel Bantarjati Kec Bogor Utara - JAWA BARAT 16153	0251- 8310026 bgr-admin@epson-indonesia.co.id bgr-technical@epson-indonesia.co.id
SERANG	EPSON SERVICE CENTER Serang	Jl. Ahmad Yani No.45C, SERANG - BANTEN	0254- 7912503 srg-admin@epson-indonesia.co.id srg-technical@epson-indonesia.co.id
PALU	EPSON SALES AND SERVICE Palu	Jl. Juanda No. 58, Palu - Sulteng	0451- 4012 881 plw-admin@epson-indonesia.co.id plw-technical@epson-indonesia.co.id

Province	Company Name	Address	Phone E-mail
BANJARMASIN	EPSON SERVICE CENTER BANJARMASIN	Jl. Gatot Soebroto NO. 153 BANJARMASIN - KALSEL 70235	0511- 6744135 (TEKNISI) / 3266321(ADMIN) bdj-admin@epson-indonesia.co.id bdj-technical@epson-indonesia.co.id
DENPASAR	EPSON SALES AND SERVICE Denpasar	JL. MAHENDRADATA NO. 18, DENPASAR - BALI	0361- 3446699 / 9348428 dps-admin@epson-indonesia.co.id dps-technical@epson-indonesia.co.id
JAKARTA	EPSON SALES AND SERVICE CILANDAK	CIBIS Business Park Tower 9 LT. MEZZANINE, Jalan TB Simatupang No.2, Jakarta Selatan - DKI JAKARTA 12560	021- 80866777 esscibis.support1@epson-indonesia.co.id esscibis.support2@epson-indonesia.co.id esscibis.admin@epson-indonesia.co.id esscibis.sales@epson-indonesia.co.id
SURABAYA	EPSON SALES AND SERVICE SURABAYA (GUBENG)	JL. RAYA GUBENG NO. 62, SURABAYA - JAWA TIMUR	031- 99444940 / 99446299 / 99446377 esssby@epson-indonesia.co.id esssby.support@epson-indonesia.co.id
AMBON	EPSON SERVICE CENTER AMBON	Jl. Diponegoro No.37 (Samping Bank Mandiri Syariah) Kel.Ahusen, Kec.Sirimau - Ambon 97127	-

For other cities not listed here, call the Hot Line: 08071137766.

Help for Users in Hong Kong

To obtain technical support as well as other after-sales services, users are welcome to contact Epson Hong Kong Limited.

Internet Home Page

<http://www.epson.com.hk>

Epson Hong Kong has established a local home page in both Chinese and English on the Internet to provide users with the following information:

- Product information
- Answers to Frequently Asked Questions (FAQs)
- Latest versions of Epson product drivers

Technical Support Hotline

You can also contact our technical staff at the following telephone and fax numbers:

Phone: 852-2827-8911

Fax: 852-2827-4383

Help for Users in Malaysia

Contacts for information, support, and services are:

World Wide Web

<http://www.epson.com.my>

- Information on product specifications, drivers for download
- Frequently Asked Questions (FAQ), Sales Enquiries, questions through e-mail

Epson Call Centre

Phone: 1800-81-7349 (Toll Free)

Email: websupport@emsb.epson.com.my

- Sales enquiries and product information
- Product usage questions or problems
- Enquiries on repair services and warranty

Head Office

Phone: 603-56288288

Fax: 603-5628 8388/603-5621 2088

Help for Users in India

Contacts for information, support, and services are:

World Wide Web

<http://www.epson.co.in>

Information on product specifications, drivers for download, and products enquiry are available.

Helpline

- Service, product information, and ordering consumables (BSNL Lines)
 - Toll-free number: 18004250011
 - Accessible 9am to 6pm, Monday through Saturday (Except public holidays)
- Service (CDMA & Mobile Users)
 - Toll-free number: 186030001600
 - Accessible 9am to 6pm, Monday through Saturday (Except public holidays)

Help for Users in the Philippines

To obtain technical support as well as other after sales services, users are welcome to contact the Epson Philippines Corporation at the telephone, fax numbers and e-mail address below:

World Wide Web

<http://www.epson.com.ph>

Information on product specifications, drivers for download, Frequently Asked Questions (FAQ), and E-mail Enquiries are available.

Epson Philippines Customer Care

Toll Free: (PLDT) 1-800-1069-37766

Toll Free: (Digital) 1-800-3-0037766

Metro Manila: (632) 8441 9030

Web Site: <https://www.epson.com.ph/contact>

E-mail: customercare@epc.epson.com.ph

Accessible 9am to 6pm, Monday through Saturday (Except public holidays)

Our Customer Care team can help you with the following over the phone:

- Sales enquiries and product information
- Product usage questions or problems
- Enquiries on repair service and warranty

Epson Philippines Corporation

Trunk Line: +632-706-2609

Fax: +632-706-2663