

Canon

Exif Print

Photo Printer

PIXMA iP1700 Series Quick Start Guide



Getting Help from Canon

Help Us Help You Better

Before you contact Canon, please record the following information.

Serial Number (located on the inside of the product): _____

Model Number (located on the top of the product): _____

Setup CD-ROM number (located on the CD-ROM): _____

Purchase Date: _____

Customer Technical Support Sequence*

1. **Internet** — www.canontechsupport.com

For quick and comprehensive self-help in an intuitively guided interactive troubleshooting environment, the place to start is our helpful tech support web site. In addition, the latest driver downloads, answers to frequently asked questions, product information, and “where to buy” instructions are found here.

2. **Email Tech Support** — www.canontechsupport.com

For individual attention to a special issue, try emailing our friendly technical support representatives, specially trained to communicate quick, easy, and logical solutions to your inquiries within 24 hours.

3. **Toll-Free Live Tech Support** — **(1-800-828-4040)**

This option provides live telephone technical support, free of service charges, Monday-Saturday (excluding holidays), during your product’s 1 year limited warranty period. Telephone Device for the Deaf (TDD) support is available at (1-866-251-3752).

4. **Extended Service and Support** — www.canonesp.com

Canon CarePAK Extended Service Plan is a cost-attractive and easy-to-use extended service program that provides up to three full years of service and support coverage at a very attractive price. CarePAK offers toll-free Canon technical support and includes Canon’s superb InstantExchange product replacement program. For further information about extending your Canon service and support, call (1-800-385-2155), or visit our Web site at www.canonesp.com. CarePAK must be purchased during your product’s warranty period.

For more information and updated program specifics, please visit our web site at www.canontechsupport.com.

*Support program specifics are subject to change without notice.

Canon

PIXMA iP1700

Photo Printer

Quick Start Guide

Canon PIXMA iP1700 Photo Printer Quick Start Guide

Copyright

This manual is copyrighted by Canon U.S.A., Inc. with all rights reserved. Under the copyright laws, this manual may not be reproduced in any form, in whole or in part, without the prior written consent of Canon U.S.A., Inc.

© 2006 Canon U.S.A., Inc.

Disclaimer

Canon U.S.A., Inc. has reviewed this manual thoroughly in order that it will be an easy-to-use guide to your Canon PIXMA iP1700 Photo Printer. All statements, technical information and recommendations in this manual and in any guides or related documents are believed reliable, but the accuracy and completeness thereof are not guaranteed or warranted, and they are not intended to be, nor should they be understood to be, representation or warranties concerning the products described.

Specifications are subject to change without notice.



As an ENERGY STAR partner, Canon U.S.A., Inc., has determined that this product meets the ENERGY STAR guidelines for energy efficiency.

All information regarding non-Canon products was compiled from publicly available information. No representation is made regarding the accuracy thereof.

About Consumables

Consumables (ink tanks / FINE Cartridges) are available for 5 years after production has stopped.

Trademarks

- "Windows" and "Internet Explorer" are trademarks of Microsoft Corporation, registered in the United States and other countries.
- "Macintosh" and "Mac" are trademarks of Apple Computer, Inc., registered in the U.S. and other countries.

Canon U.S.A., Inc.
One Canon Plaza
Lake Success, NY 11042

Contents

Basic Printing

Turning on the Printer	2
Turning off the Printer	3
Loading Paper	4
Using Specialty Media	9
Printing with Windows	11
Printing with Macintosh	13
Cancel Printing	15

Advanced Printing

Accessing the Printer Driver	16
Using the Bundled Software.	18

Printing Maintenance

When Printing Becomes Faint or Colors are Incorrect	19
Printing the Nozzle Check Pattern	20
Print Head Cleaning.	25
Print Head Deep Cleaning.	29
Aligning the Print Head.	34
Replacing a FINE Cartridge	39

Troubleshooting

Cannot Install the Printer Driver.	48
The USB Connection Does Not Work Properly.	49
Print Quality is Poor or Contains Errors	50
Printer Does Not Start or Stops During Print Jobs	53
Paper Does Not Feed Properly	54
Paper Jams	55
The ALARM Lamp Flashes	56
An Error Message Appears on the Screen	58

Appendix

Specifications	60
Safety Precautions	62
Regulatory Information	64
CANON U.S.A., INC. LIMITED WARRANTY --- (USA Only)	65

Index	67
-----------------	----

Basic Printing



 **Note** This *Quick Start Guide* describes some of the features of your printer and how to use them. For more information, refer to the On-screen Manual installed on your computer.

Windows

While in the printer's **Properties** dialog box, place your cursor on the feature you want to know more about and press the **F1** key, or click  in the upper right corner and click the feature you want to know more about.

Also, click the **Instructions** button to display the *Printer Driver Guide*. Detailed information is provided. The **Instructions** button is not displayed unless the On-screen Manual is installed.

Macintosh

While in the **Page Setup** dialog box or **Print** dialog box, click  in the lower left corner to display the *Printer Driver Guide*. Detailed information is provided. The *Printer Driver Guide* is not displayed unless the On-screen Manual is installed, even if the  button is clicked.

Turning on the Printer

- 1** To turn on the printer, press the **POWER** button.

The **POWER** lamp flashes while the printer warms up and changes to steady (non-flashing) green when the printer is ready.

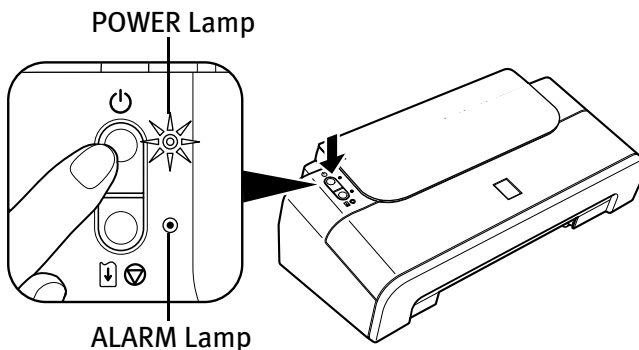

Important If the **ALARM** lamp changes to a flashing, refer to the section "[The ALARM Lamp Flashes](#)" on page 56.

- 2 Turn on your computer.

Turning off the Printer

- 1 To turn off the printer, press the **POWER** button.

When the **POWER** lamp stops flashing, the printer is turned off.

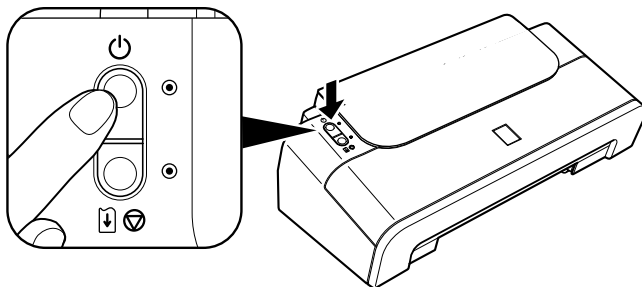

Important About the Power Plug

When removing the power plug after you have turned off the printer, be sure to check that the **POWER** lamp is not lit. If the power plug is removed from the wall outlet when the **POWER** lamp remains lit or is flashing, the Print Head will not be protected and it may be unable to print.

Loading Paper

■ Print Media to Avoid

Do not use the following types of paper. Using such papers as these will not only produce unsatisfactory results, but they may also cause the printer to jam or malfunction.

- Folded, curled or wrinkled paper
- Damp paper
- Paper that is too thin (less than 64 gsm/17 lb)
- Paper that is too thick (more than 105 gsm/28 lb)*
- Paper with holes (For example: loose leaf)
- Picture postcards
- Postcards with an affixed photo or sticker
- Envelopes with double flaps
- Envelopes with pressure seals
- Envelopes with an embossed or treated surface

*Non-Canon genuine specialty paper

Also, do not use a cut paper or memo pad, when printing on a paper smaller than A5 size.

■ Preparing the Printer

- For detailed information on the specialty media Canon provides for use with its various printers, refer to the section "[Using Specialty Media](#)" on page 9.
- Consult "[Printing Media](#)" in the *User's Guide* for detailed instructions on how to load specialty media into the printer.

1 Flatten the four corners of the paper before loading it.

-  **Note**
- When paper is curled, gently bend it in the opposite direction until the paper becomes completely flat.
 - To prevent paper from being curled, we recommend handling it in the following ways:
 - Put unused paper back into the package, and store them horizontally.
 - Remove only as many sheets from the package as you need right before printing.

2 Prepare to load paper.

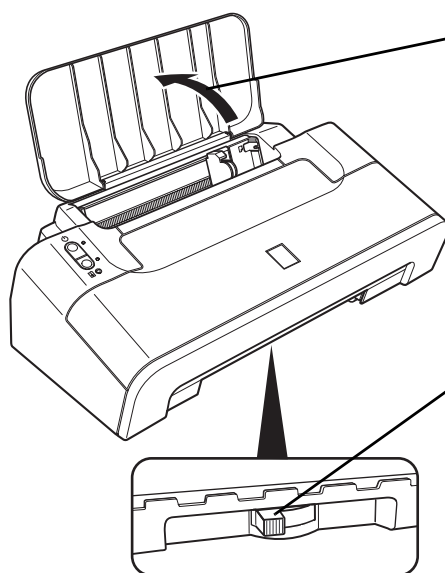

(1) Open the Paper Support.

(2) Move the Paper Thickness Lever to the correct position for the media in use. Move the lever to its left position for plain paper, and move it to the right position for envelopes and T-Shirt Transfers. See "[Canon Specialty Media](#)" on page 10.

**Note**

- Place the printer on a flat surface.
- Do not place any obstacles in front of the printer to keep this area open for paper which is ejected.
- Remove each sheet as soon as paper is ejected. If the Paper Output Slot is stacked with printed sheets it may interfere with the printer's ejecting process.
- When performing duplex printing, pay great attention to the dust and stain on the area (desk, etc.) where the printed paper is ejected. Printing with dust and stain remaining on this area can have a bad effect on the printing result and printer.

3 Load the paper.

■ Loading Plain Paper

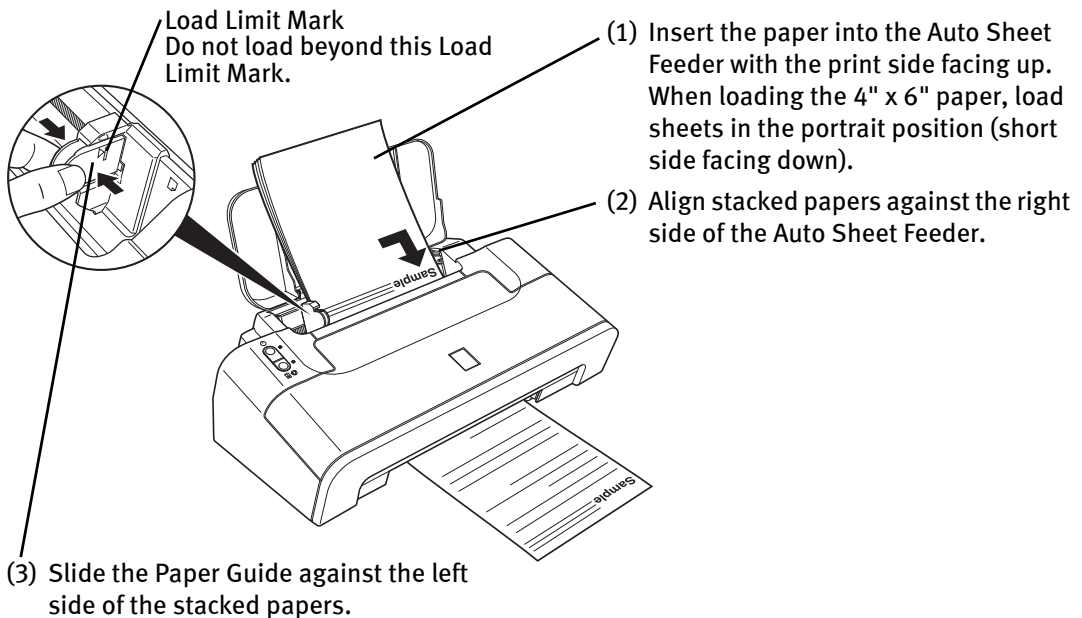
**Note**

- Remove the printed papers as necessary from the Paper Output Slot.
- Do not touch the printed surfaces until the ink dries. For specific drying times, refer to the instructions packaged with your media.

■ Loading Envelopes

Use either European DL or US Comm. Env. #10 size envelopes.

The address is automatically rotated and printed out.

- Important**
- Do not use envelopes with embossed or treated surface, with a double flap or pressure seals, with sticker flaps.
 - Select either **DL Env.** (Windows) / **DL Envelope** (Macintosh) or **Comm. Env. #10** (Windows) / **#10 Envelope** (Macintosh) in the printer driver according to the envelope size you are using.
 - If you do not select **Media Type** correctly, the print out results in the wrong way round.

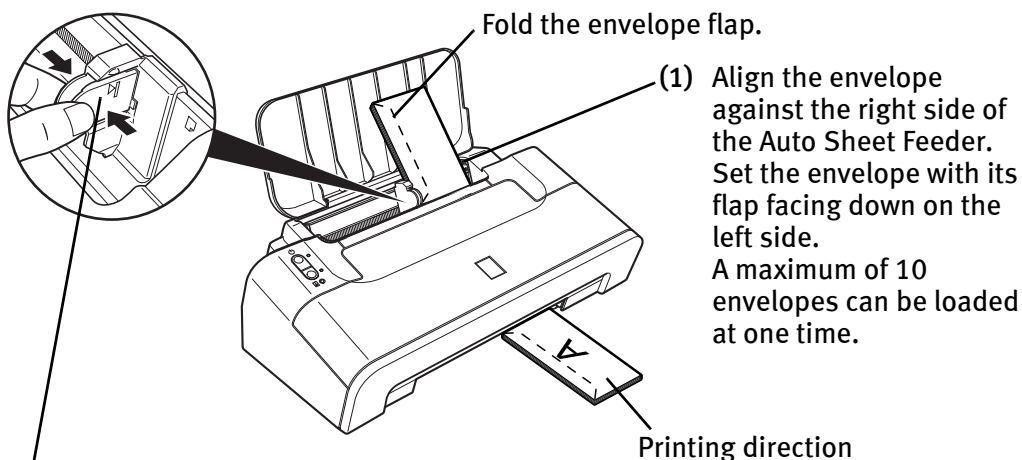

- (2) Slide the Paper Guide against the left side of the envelope (next to the flap).

- Note**
- When printing the envelope, set the Paper Thickness Lever to the right.
 - When using a special paper to inverse the print result on Windows, open the **Printer Properties** dialog box and select the **Rotate 180 degrees** check box on the **Page Setup** tab.

- (3) Select **Envelope** in **Media Type**, and then select **DL Env.** (Windows) / **DL Envelope** (Macintosh) or **Comm. Env. #10** (Windows) / **#10 Envelope** (Macintosh) in **Page Size**.

- (4) Select **Portrait** in **Orientation**.

For the printer driver setting, refer to "[Printing with Windows](#)" on page 11, or "[Printing with Macintosh](#)" on page 13.

■ Loading 4" x 6" size papers

You can print on 4" x 6" size papers.

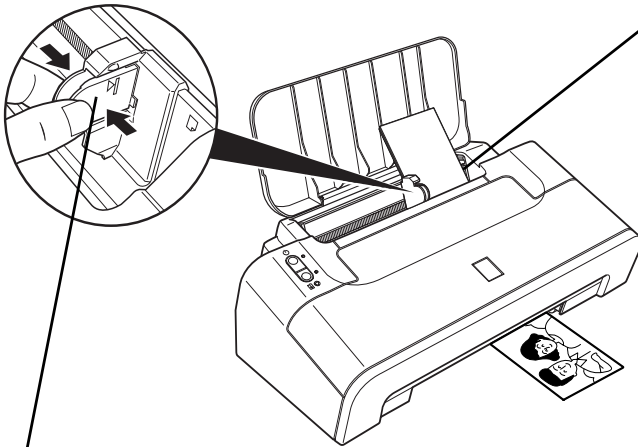

(1) Align the paper against the right side of the Auto Sheet Feeder. Regardless to the actual orientation of your photograph, load the paper vertically (short side first) in the printer. A maximum of 20 sheets of size in 4" x 6" paper can be loaded at one time.

(2) Slide the Paper Guide against the left side of the papers.

(3) Select **4 x 6 in 101.6 x 152.4 mm** in **Page Size**.

For the printer driver setting, refer to "[Printing with Windows](#)" on page 11, or "[Printing with Macintosh](#)" on page 13.

Using Specialty Media

Canon recommends that you use genuine Canon media to ensure optimal print quality.

■ Photo Quality Media

- Glossy Photo Paper
- Matte Photo Paper
- Photo Paper Plus Double Sided
- Photo Paper Plus Glossy
- Photo Paper Plus Semi-Gloss
- Photo Paper Pro



■ Media for Business Documents

- High Resolution Paper



■ Canon Specialty Media

Media Name	Paper Support Load Limit	Paper Thickness Lever Position	Printer Driver Settings for Media Type
Super White Paper	Letter: up to 10mm or 0.39 inches	Left	Plain Paper
High Resolution Paper	Letter: up to 80 sheets	Left	High Resolution Paper
Glossy Photo Paper	Letter: up to 10 sheets* ¹ 4"×6": up to 20 sheets Credit Card: up to 20 sheets	Left	Glossy Photo Paper
Matte Photo Paper	Letter: up to 10 sheets 4"×6": up to 20 sheets	Left	Matte Photo Paper
Photo Paper Plus Double Sided	Letter: 1 sheet 5"×7": 1 sheet	Left	Photo Paper Plus Double Sided
Photo Paper Plus Glossy	Letter: up to 10 sheets* ¹ 5"×7": up to 10 sheets 4"×6": up to 20 sheets	Left	Photo Paper Plus Glossy
Photo Paper Plus Semi-Gloss	Letter: up to 10 sheets 4"×6": up to 20 sheets 8"×10": up to 10 sheets	Left	Photo Paper Plus Glossy
Photo Paper Pro	Letter: up to 10 sheets 4"×6": up to 20 sheets 8"×10": up to 10 sheets	Left	Photo Paper Pro
Photo Stickers* ²	1 sheet	Left	Photo Paper Plus Glossy
T-Shirt Transfers	1 sheet	Right	T-Shirt Transfers

*1 When paper cannot be fed normally, load the necessary number of sheets in the Auto Sheet Feeder after having first separated them from each other to avoid them from sticking together.

*2 You can specify the print setting easily by using the Easy-PhotoPrint provided with the *Setup CD-ROM*. For instructions on how to print from the software applications, refer to the *Photo Application Guide*.



Note

- When using plain paper (64 gsm/17 lb), up to 100 sheets can be loaded at one time. Set the Paper Thickness Lever to the left and select **Plain Paper** under printer driver **Media Type**.
- For a detailed description of print media types, refer to "Printing Media" in the *User's Guide*.



Printing with Windows

-  **Note**
- The menu screens and dialog boxes that appear may vary depending on the application you are using.
 - The steps described in this section are for printing using a computer with Windows® XP Service Pack 2 installed (hereafter called Windows XP SP2).

1 Turn your printer on, then set papers.

2 Create a document or open a file to print.

3 Open the **Printer Properties** dialog box.

(1) Select **Print** from the application's **File** menu.

The **Print** dialog box opens.

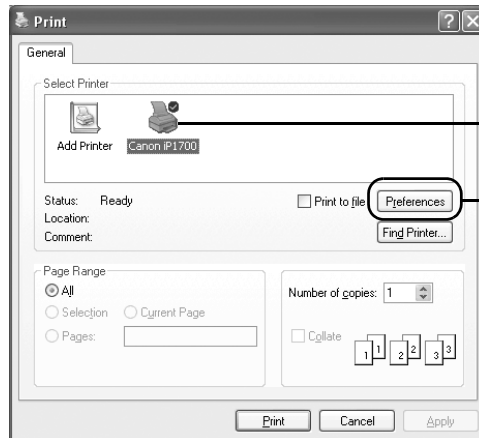

(2) Ensure that **Canon iP1700** is selected.

(3) Click on **Preferences** or **Properties**.

-  **Note** In Windows 2000, click on the **Main** tab in the **Print** dialog box.

4 Specify the required settings.

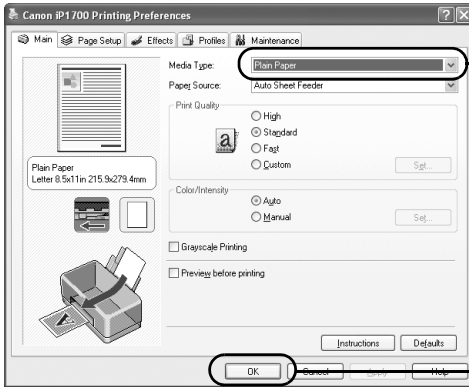

(1) Click **Media Type** to select the media loaded in the printer.

(2) Click **OK**.



Note

- From the **Page Setup** tab select the correct document size to be printed.
- To adjust **Print Quality** settings, select **Custom** and click **Set** on the **Main** tab. You can control the quality in the **Custom** dialog box.
- For details about other printer driver functions, click the **Help** button or **Instructions** button and refer to Help or *Printer Driver Guide*. The **Instructions** button is not displayed unless the On-screen Manual is installed.
- Click the check box to select **Preview before printing**. This will allow you to preview a screen that shows how the selected printing effects on your document will look when printed. Some applications do not contain the preview function.

5 Print the document.

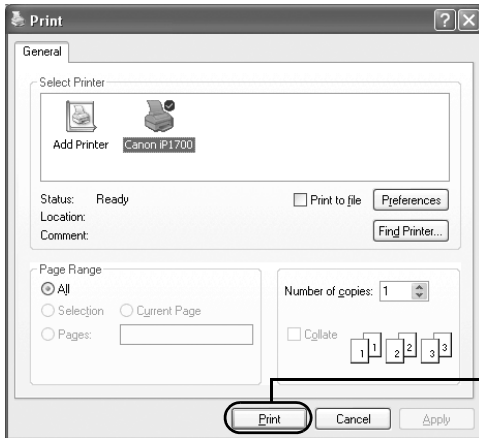

(1) Click **Print** (or **OK**).

 **Note** You can cancel a print job in progress by simply pressing the **RESUME/CANCEL** button on the printer.

See "[Cancel Printing](#)" on page 15.

Macintosh

Printing with Macintosh

-  **Note**
- The menu screens and dialog boxes that appear may vary depending on the software application you are using.
 - The steps described in this section are for printing using a computer with Mac[®] OS X v.10.4.x installed (hereafter called Macintosh[®]).
 - You can use Easy-PhotoPrint to easily do print operations when printing photographs. Easy-PhotoPrint is provided on the Setup CD-ROM. For details on how to use Easy-PhotoPrint, refer to the *Photo Application Guide*.

1 Turn your printer on, then set papers.

2 Create a document or open a file to print.

3 Select Paper Size.

(1) Select **Page Setup** from the application's **File** menu.

The **Page Setup** dialog box opens.

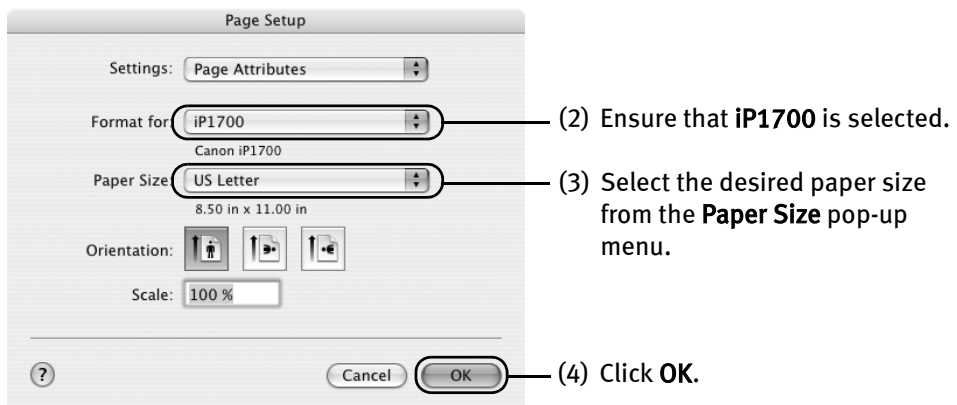

4 Specify the required settings.

- (1) Select **Print** from the application's **File** menu.

The **Print** dialog box opens.

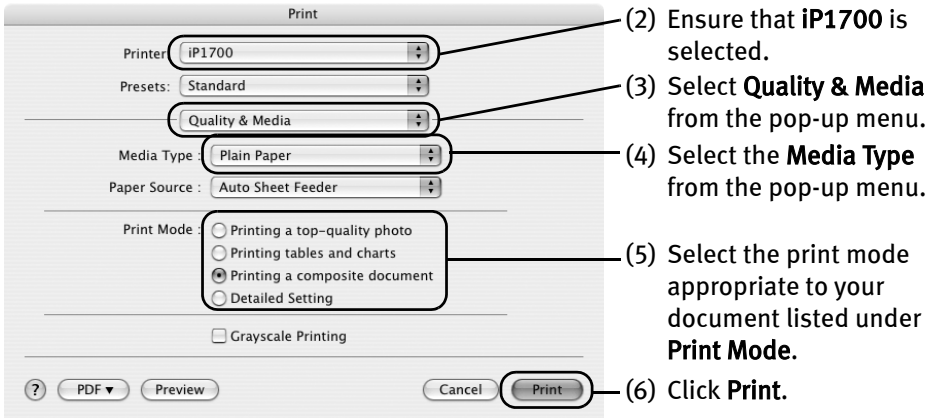

-  **Note**
- When you select the print mode appropriate to your document under **Print Mode**, the document will be printed in the color and print quality suited to the characteristics of the **Media Type** you have selected.

Printing a top-quality photo: Select when printing documents which mainly consist of photographs and graphics featuring fine color gradation.

Printing tables and charts: Select when printing documents which mainly consist of graphs and graphics (illustrations) with strong color definition.

Printing a composite document: Select when printing documents which are mainly just text.

Detailed Setting: You can fine-tune **Print Quality** and **Halftoning** settings here.

- For details about other printer driver functions, click the  button to see *Printer Driver Guide*. The *Printer Driver Guide* is not displayed unless the On-screen Manual is installed.
- You can cancel a print job while printing.

See "[Cancel Printing](#)" on page 15.

Cancel Printing

Windows

You can cancel a print job while printing by pushing the **RESUME/CANCEL** button on the printer.

- 1 Press the **RESUME/CANCEL** button while the printer is printing.

Printing is canceled and the paper is ejected.

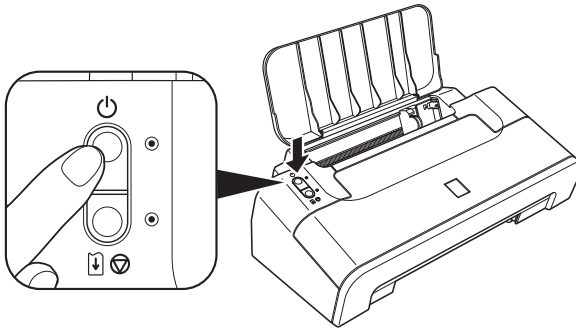

 **Note** Click **Cancel Printing** on the Canon IJ Status Monitor to stop printing. To display the Canon IJ Status Monitor, click **Canon iP1700** on the taskbar. The Canon IJ Status Monitor opens automatically whenever a printer error occurs.

Macintosh

- 1 Click the printer's icon in the Dock and display the list of print jobs in progress.

If you are using Mac OS X v.10.2.8, click on the printer icon in the Dock to start up the **Print Center** and double-click on the name of your printer in the **Printer List** to open a list of print jobs in progress.

- 2 Select an undesired document and click the **Delete** icon.

The print job is deleted.

 **Note** To temporarily stop a job in progress, click **Hold**. To cancel all the jobs in the list, click **Stop Jobs**.

Advanced Printing

Accessing the Printer Driver

The **Printer Properties** dialog box can be opened from either within an application or directly from the Windows **Start** menu.

 **Note** This manual refers to operations in Windows XP SP2.

These operations may vary depending on the operating system you use.

■ Opening the Printer Properties Dialog Box from your Application Program

The operations may vary slightly depending on your application program. This section describes only a general procedure for opening the **Printer Properties** dialog box.

- 1** In your application, select the command to print a document.
The **Print** dialog box can usually be opened by selecting **Print** from the **File** menu.
- 2** Ensure that **Canon iP1700** is selected. Then click **Preferences (or Properties)**.
The **Printer Properties** dialog box opens.

 **Note** Depending on your application program, the command and menu names may differ and there may be more steps involved in opening the **Printer Properties** dialog box. For more details, see the user's manual regarding your application.

■ Opening the Printer Properties Dialog Box Directly from the Start Menu

This method is used to specify printer settings common to all application programs.

- 1** Click **Start** and select **Control Panel, Printers and Other Hardware**, and then **Printers and Faxes**.
For non-Windows XP users, click **Start**, select **Settings**, and then **Printers**.
- 2** Select the **Canon iP1700** icon.
- 3** Open the **File** menu and select **Printing Preferences (or Properties)**.
The **Printer Properties** dialog box opens.

When opening the **Printer Properties** dialog box from **Properties**, the tabs related to the Windows function (e.g., the **Ports** tab, or the **Details** tab) appear. These tabs do not appear, when opening the **Printer Properties** dialog box from **Printing Preferences** or applications. For details about the tabs related to the Windows function, refer to the manual of Windows.

 **Note** For details on how to set each function, refer to the *Printer Driver Guide* or Help.

Using the Bundled Software

The *Setup CD-ROM* includes photo applications designed to edit the photographs taken by a digital camera and print them as photo-lab quality prints. Use the application(s) suitable for your print purposes.

-  **Note**
- To install applications, refer to *Easy Setup Instructions*.
 - For details about photo applications, refer to the *Photo Application Guide*.

■ Easy-PhotoPrint (Windows/Macintosh)

You can make a Borderless Print easily and quickly, just by selecting a photograph taken with a digital camera and the paper type on which to print it. In addition, it has tools to correct red eye caused by the camera's flash or smooth and beautify facial skin.

It is compatible with Exif Print*.

■ PhotoRecord (Windows)

You can create fun and unique photo albums with decorative themes which include different frames, background, and clip-art. You can also copy or move decorated photos.

It is compatible with Exif Print*.

■ Easy-WebPrint (Windows)

You can easily print out homepages displayed on Internet Explorer® in full size without its right-hand side being cropped. This application is automatically added to the Internet Explorer toolbar. Internet Explorer 6.0 is recommended.

* Exif Print is the worldwide standard. Under Exif Print, the digital camera can record data tags for specific camera settings and functions such as whether the flash was on or off, if the camera was in portrait or night scene mode, etc.

Canon PIXMA Printers support Exif Print and use a suitable photo application to read the camera data precisely, producing optimal prints. This enables you to create prints that reproduce color more accurately.

Printing Maintenance

When Printing Becomes Faint or Colors are Incorrect

When printing becomes faint or colors are incorrect, the Print Head Nozzles are probably clogged. Follow the procedures below to clean these nozzles.

Step 1

"Printing the Nozzle Check Pattern" on page 20

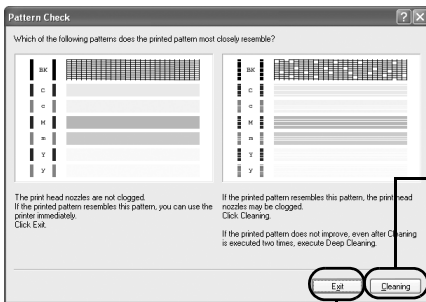

After Print Head Cleaning, print the nozzle check pattern.

If the print quality is poor, perform Print Head Cleaning.

If the pattern is printed normally, click **Exit**.

Step 2

"Print Head Cleaning" on page 25

If the problem remains after performing Print Head Cleaning twice

Step 3

"Print Head Deep Cleaning" on page 29

If the problem still remains after performing Print Head Deep Cleaning twice

Step 4

"Replacing a FINE Cartridge" on page 39

 **Note** If ruled lines appear misaligned when printed, adjust the Print Head position. See "[Aligning the Print Head](#)" on page 34.

Printing the Nozzle Check Pattern

Print the nozzle check pattern to determine whether the ink ejects properly from the Print Head Nozzles. Use this function when printed results are blurred or a color is incorrect.

■ Printing the Nozzle Check Pattern

Windows

- 1 With the printer on, load a sheet of Letter size plain paper in the Auto Sheet Feeder.
- 2 Open the **Printer Properties** dialog box.
See "[Opening the Printer Properties Dialog Box Directly from the Start Menu](#)" on page 16.
- 3 Print the Nozzle Check Pattern.

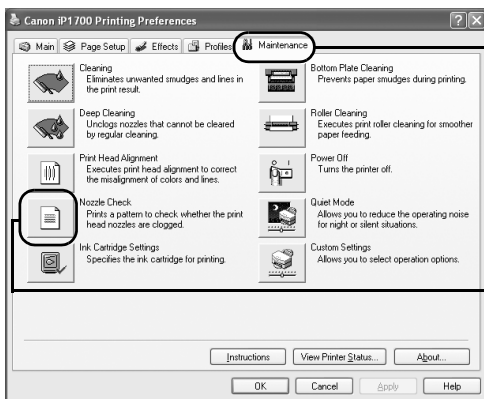

(1) Click the **Maintenance** tab.

(2) Click **Nozzle Check**.

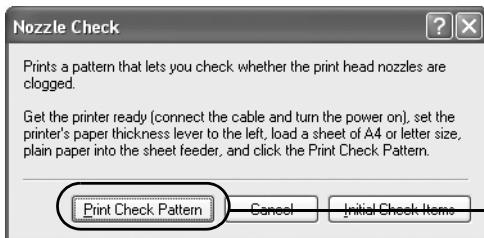

(3) Click **Print Check Pattern**.



Note

Click the **Initial Check Items** button and a confirmation message for printing the nozzle check pattern will appear.

(4) Confirm the nozzle check pattern.

See "[Examining the Nozzle Check Pattern](#)" on page 23.

Macintosh

1 With the printer on, load a sheet of Letter size plain paper in the Auto Sheet Feeder.

2 Open the **Canon IJ Printer Utility** dialog box.

(1) Select **Applications** from the **Go** menu.

(2) Double-click the **Utilities** folder, and then double-click the **Printer Setup Utility** icon.

If you are using Mac OS X v.10.2.8, double-click the **Utilities** folder, and then double-click the **Print Center** icon.

(3) Select **iP1700** from the **Name** list and then click **Utility**.

If you are using Mac OS X v.10.2.8, select **iP1700** from **Name** in **Printer List** and then click **Configure**.

(4) Select **iP1700** from the **Product** list and then click **Maintenance**.

3 Print the Nozzle Check Pattern.

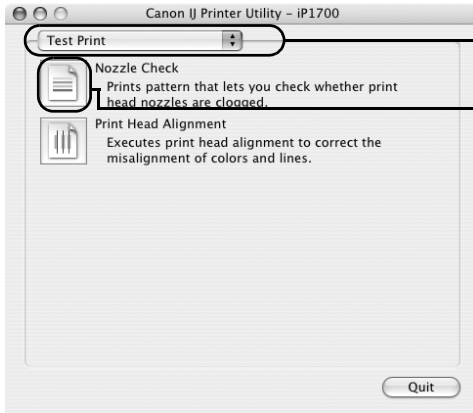

(1) Select **Test Print** from the pop-up menu.

(2) Click **Nozzle Check**.



(3) Click **Print Check Pattern**.



Note Click the **Initial Check Items** button and a confirmation message for printing the nozzle check pattern will appear.

(4) Confirm the nozzle check pattern.

See "[Examining the Nozzle Check Pattern](#)" on page 23.

■ Examining the Nozzle Check Pattern

The nozzle check pattern should appear as follows when ink is discharged properly. Examine the nozzle check pattern printed by the printer.

 **Note** If the ink level is low, the nozzle check pattern cannot be printed properly. Stop printing the nozzle check pattern, and replace a FINE Cartridge.

See "[Replacing a FINE Cartridge](#)" on page 39.

1 Confirm the printed nozzle check pattern.

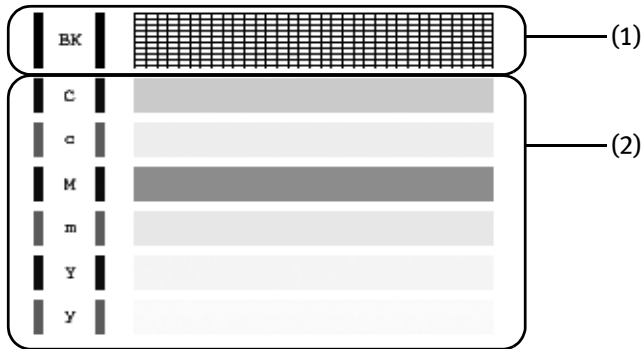

(1) Lines missing in this pattern indicate that the Print Head for Black ink requires cleaning.

When with lines missing (Black ink)

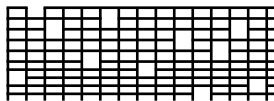

(2) White stripes in this pattern indicate that the Print Head for Color ink requires cleaning.

When white stripes appear (Color ink)



2 When cleaning is necessary, click the **Cleaning** button on the **Pattern Check** dialog box.

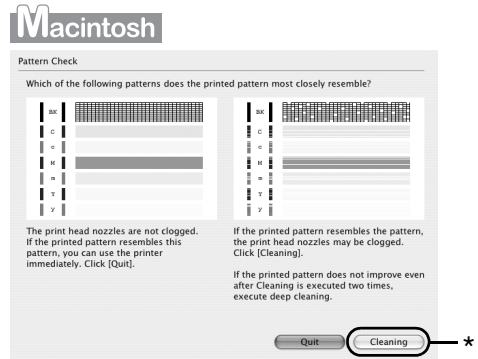
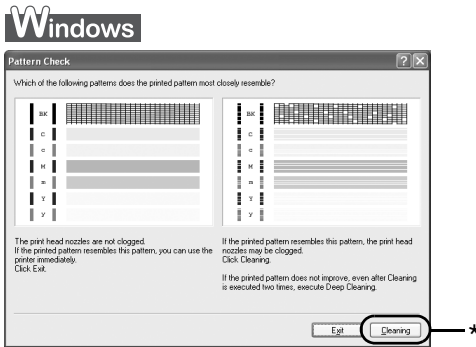

*Click the **Cleaning** button and then go to Print Head Cleaning.

See "[Print Head Cleaning](#)" on page 25.

If there are neither missing lines nor white stripes in the nozzle check pattern, click **Exit** (Windows) or **Quit** (Macintosh) to finish the nozzle check.

Print Head Cleaning

If missing lines or white stripes are found in the printed nozzle check pattern, proceed with a Print Head Cleaning to unclog the Print Head Nozzles. Cleaning the Print Head Nozzles will consume ink, so proceed with a Print Head Cleaning only when necessary.

 **Note** If you pressed the **Cleaning** button on the **Pattern Check** screen displayed after a nozzle check pattern has been printed, start the Print Head Cleaning procedure from 3-(2).

Windows

1 Ensure that the printer is turned on.

2 Open the **Printer Properties** dialog box.

See "[Opening the Printer Properties Dialog Box Directly from the Start Menu](#)" on page 16.

3 Start Print Head Cleaning.

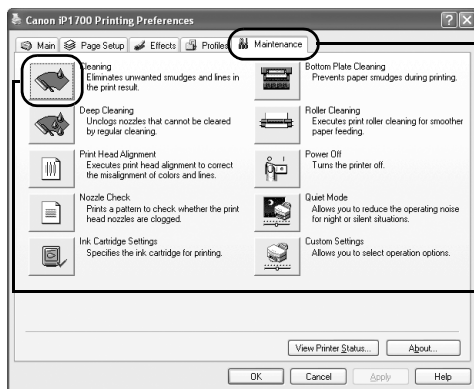

(1) Click the **Maintenance** tab.

(2) Click **Cleaning**.

(3) When the confirmation message is displayed, click **OK**.

Print Head Cleaning starts when the **POWER** lamp starts flashing.

Important Do not perform any other operations until the Print Head Cleaning finishes. This takes about 60 seconds.

4 Check on the Print Head condition.

- (1) Click **Print Check Pattern** in the **Nozzle Check** dialog box which automatically appears after the cleaning is done.

When the confirmation message is displayed, click **OK**.

A nozzle check pattern will be printed.

Do not perform any other operation until the printing of the nozzle check pattern is finished.

 **Note** Click the **Initial Check Items** button and a confirmation message for Print Head Cleaning will appear.

- (2) Look carefully at the printout of the nozzle check pattern to evaluate the condition of the Print Head.

See "[Examining the Nozzle Check Pattern](#)" on page 23.

- (3) If the problem persists even after you have performed the normal Print Head Cleaning procedure twice, execute Print Head Deep Cleaning.

See "[Print Head Deep Cleaning](#)" on page 29.

Macintosh

1 Ensure that the printer is turned on.

2 Open the **Canon IJ Printer Utility** dialog box.

- (1) Select **Applications** from the **Go** menu.
- (2) Double-click the **Utilities** folder, and then double-click the **Printer Setup Utility** icon.

If you are using Mac OS X v.10.2.8, double-click the **Utilities** folder, and then double-click the **Print Center** icon.

- (3) Select **iP1700** from the **Name** list and then click **Utility**.

If you are using Mac OS X v.10.2.8, select **iP1700** from **Name** in **Printer List** and then click **Configure**.

- (4) Select **iP1700** from the **Product** list and then click **Maintenance**.

3 Start Print Head Cleaning.

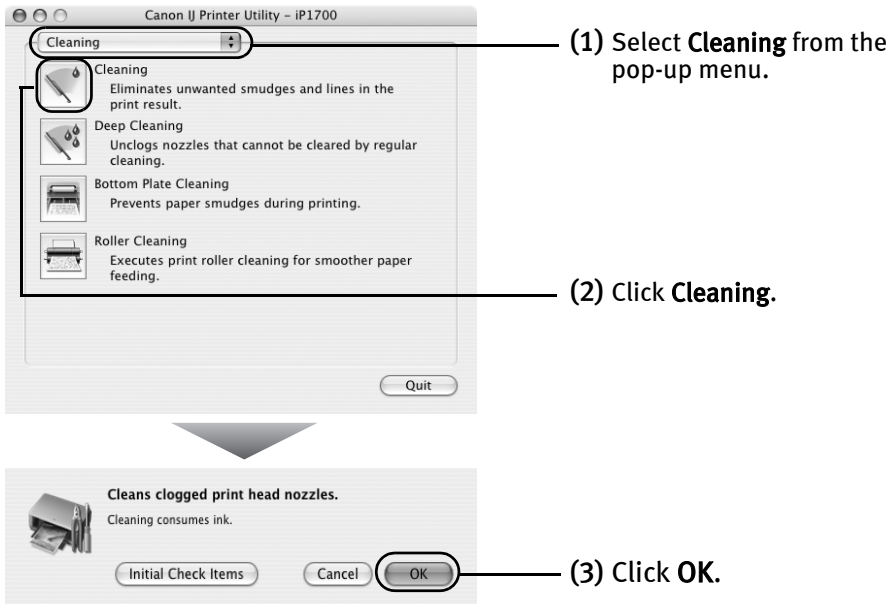

Note Click the **Initial Check Items** button and a confirmation message for Print Head Cleaning will appear.

Print Head Cleaning starts when the **POWER** lamp starts flashing.

Important Do not perform any other operations until **Print Head Cleaning** finishes. This takes about 60 seconds.

4 Check on the Print Head condition.

- (1) Click **Print Check Pattern** in the **Nozzle Check** dialog box which automatically appears after the cleaning is done.

A nozzle check pattern will be printed.

Do not perform any other operation until the printing of the nozzle check pattern is finished.

- (2) Look carefully at the printout of the nozzle check pattern to evaluate the condition of the Print Head.

See "[Examining the Nozzle Check Pattern](#)" on page 23.

- (3) If the problem persists even after you have performed the normal Print Head Cleaning procedure twice, execute Print Head Deep Cleaning.

See "[Print Head Deep Cleaning](#)" on page 29.

Print Head Deep Cleaning

If print quality does not improve after a standard Print Head Cleaning, try Print Head Deep Cleaning, which is a more powerful cleaning process. Print Head Deep Cleaning consumes more ink than standard Print Head Cleaning, so perform this procedure only when necessary.

Windows

- 1** Ensure that the printer is turned on.
- 2** Open the **Printer Properties** dialog box.

See "[Opening the Printer Properties Dialog Box Directly from the Start Menu](#)" on page 16.

3 Start Print Head Deep Cleaning.

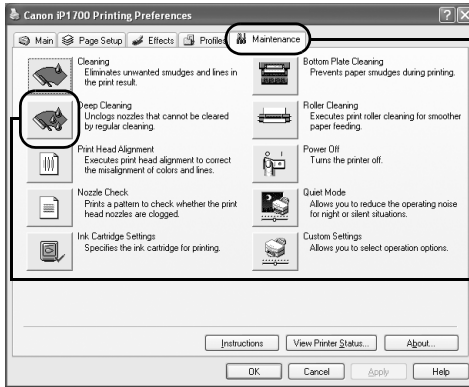

(1) Click the **Maintenance** tab.

(2) Click **Deep Cleaning**.

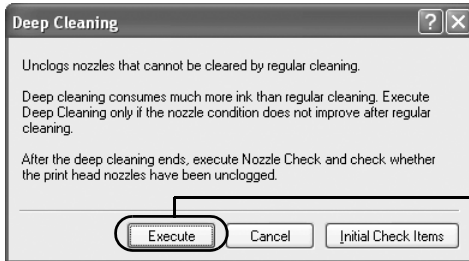

(3) Click **Execute**.

 **Note** Click the **Initial Check Items** button and a confirmation message for Print Head Deep Cleaning will appear.

(4) When the confirmation message is displayed, click **OK**.
Print Head Deep Cleaning starts when the **POWER** lamp starts flashing.

Important Do not perform any other operations until Print Head Deep Cleaning finishes. This takes about one to two minutes.

4 Check the Print Head condition.

- (1) Print a nozzle check pattern to evaluate a Print Head condition.

See "[Printing the Nozzle Check Pattern](#)" on page 20.

- (2) If the problem persists, perform step 3 again.

- (3) If the problem persists, the printer may have run out of ink.

See "[Replacing a FINE Cartridge](#)" on page 39.

Macintosh

- 1 Ensure that the printer is turned on.

- 2 Open the **Canon IJ Printer Utility** dialog box.

- (1) Select **Applications** from the **Go** menu.

- (2) Double-click the **Utilities** folder, and then double-click the **Printer Setup Utility** icon.

If you are using Mac OS X v.10.2.8, double-click the **Utilities** folder, and then double-click the **Print Center** icon.

- (3) Select **iP1700** from the **Name** list and then click **Utility**.

If you are using Mac OS X v.10.2.8, select **iP1700** from **Name** in **Printer List** and then click **Configure**.

- (4) Select **iP1700** from the **Product** list and then click **Maintenance**.

3 Start Print Head Deep Cleaning.

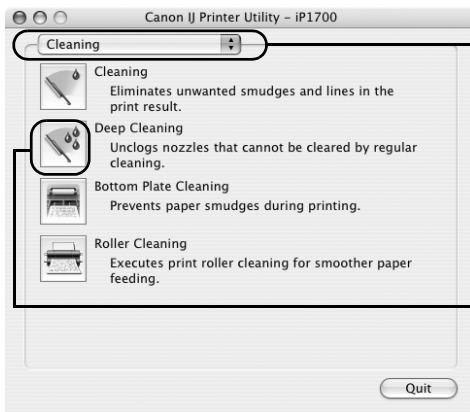

(1) Select **Cleaning** from the pop-up menu.

(2) Click **Deep Cleaning**.

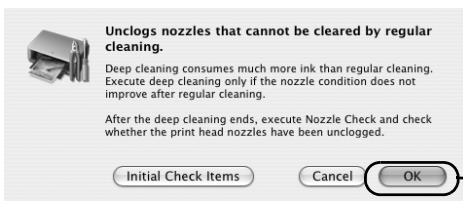

(3) Click **OK**.



Note Click the **Initial Check Items** button and a confirmation message for Print Head Deep Cleaning will appear.

Print Head Deep Cleaning starts when the **POWER** lamp starts flashing.

Important Do not perform any other operations until Print Head Deep Cleaning finishes. This takes about one to two minutes.

4 Check the Print Head condition.

(1) Print a nozzle check pattern to evaluate a Print Head condition.

See "[Printing the Nozzle Check Pattern](#)" on page 20.

(2) If the problem persists, perform step 3 again.

(3) If the problem still persists, the printer may have run out of ink.

See "[Replacing a FINE Cartridge](#)" on page 39.

Aligning the Print Head

If ruled lines are misaligned or a printout is unsatisfactory, Print Head Alignment is required.

Windows

- 1 With the printer on, load a sheet of Letter size plain paper in the Auto Sheet Feeder.

Move the Paper Thickness Lever to the left position.

- 2 Open the **Printer Properties** dialog box.

See "[Opening the Printer Properties Dialog Box Directly from the Start Menu](#)" on page 16.

- 3 Print the pattern.

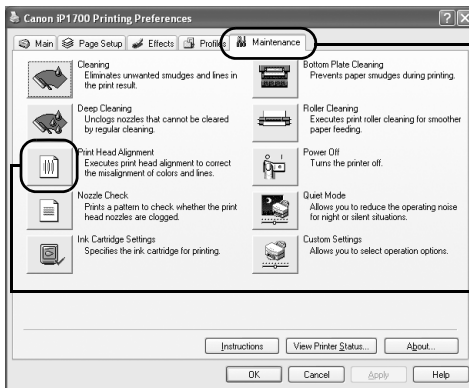

(1) Click the **Maintenance** tab.

(2) Click **Print Head Alignment**.



(3) Click **OK**.
The pattern will be printed.

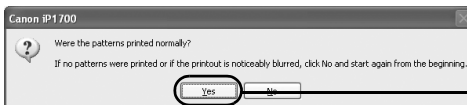

(4) After the pattern is printed, click **Yes**.

4 Align the Print Head.

- (1) Look at the printout. From the patterns, select the most even and least irregular patterns.

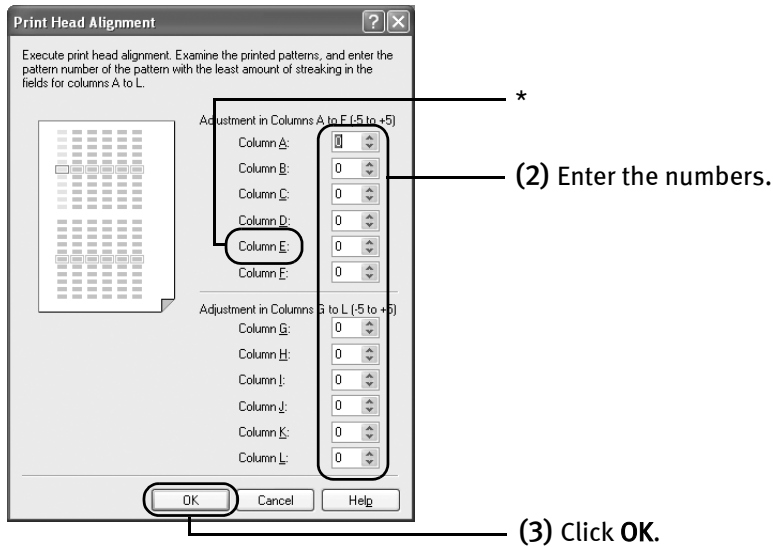

- * If it is difficult to determine the best pattern on Column E, then pick a setting that has the least noticeable white stripes.

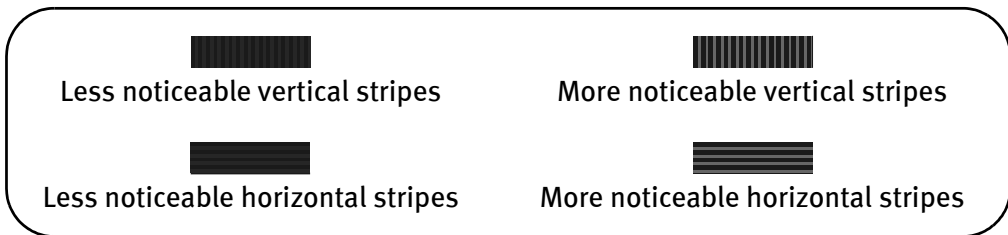

- (4) When the confirmation message is displayed, click **OK**.

Macintosh

- 1** With the printer on, load a sheet of Letter size plain paper in the Auto Sheet Feeder.

Move the Paper Thickness Lever to the left position.

- 2** Open the **Canon IJ Printer Utility** dialog box.

- (1) Select **Applications** from the **Go** menu.
- (2) Double-click the **Utilities** folder, and then double-click the **Printer Setup Utility** icon.

If you are using Mac OS X v.10.2.8, double-click the **Utilities** folder, and then double-click the **Print Center** icon.

- (3) Select **iP1700** from the **Name** list and then click **Utility**.

If you are using Mac OS X v.10.2.8, select **iP1700** from **Name** in **Printer List** and then click **Configure**.

- (4) Select **iP1700** from the **Product** list and then click **Maintenance**.

3 Print the pattern.

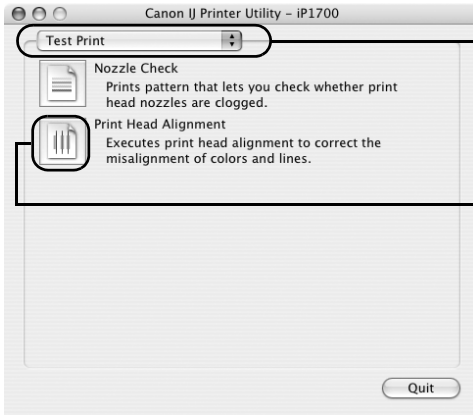

(1) Select **Test Print** from the pop-up menu.

(2) Click **Print Head Alignment**.

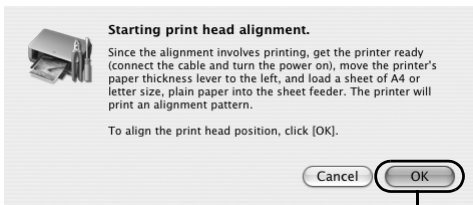

(3) Click **OK**.
The Pattern will be printed.

4 Align the Print Head.

- (1) Look at the print out. From the patterns, select the most even and least irregular patterns.

Print Head Alignment

Execute head alignment. Examine the printed patterns, and enter the pattern number of the pattern with the least amount of streaking in the fields for columns A to L.

Adjustment in Columns A to F (-5~+5)

Column A : 0
Column B : 0
Column C : 0
Column D : 0
Column E : 0
Column F : 0

Adjustment in Columns G to L (-5~+5)

Column G : 0
Column H : 0
Column I : 0
Column J : 0
Column K : 0
Column L : 0

Cancel Send

(2) Enter the numbers.

(3) Click Send.

* If it is difficult to determine the best pattern on Column E, then pick a setting that has the least noticeable white stripes.

Less noticeable vertical stripes

More noticeable vertical stripes

Less noticeable horizontal stripes

More noticeable horizontal stripes

Replacing a FINE Cartridge

If there is no improvement with the quality of printing following such maintenance as Print Head Cleaning, a FINE Cartridge is probably empty. Replace an empty FINE Cartridge with a new one. When replacing a FINE Cartridge, check the model number very carefully. The printer will not print properly if a wrong FINE Cartridge is used, or installed improperly.

Black: PG-40



Color: CL-41



■ Replacing a FINE Cartridge

When a FINE Cartridge runs out of ink, replace it using the following steps.

- 1** Ensure that the printer is turned on, and then open the Front Cover.
The FINE Cartridge Holder moves to the left.

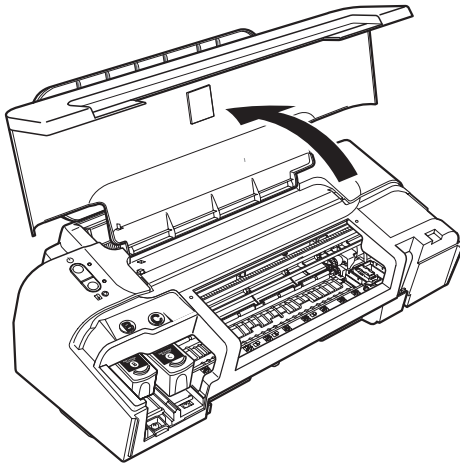

2 Remove the empty FINE Cartridge.

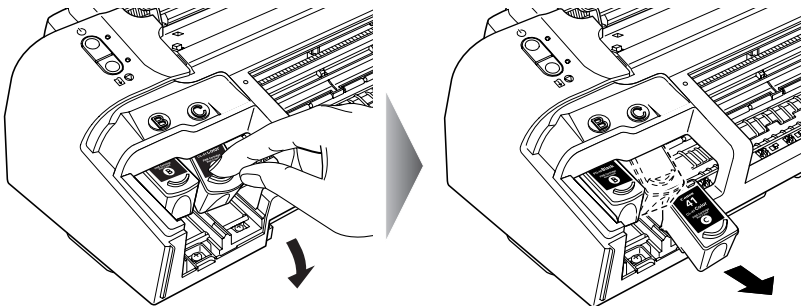

(1) Push down the FINE Cartridge.

(2) Remove the FINE Cartridge.

- Important**
- Handle FINE Cartridges carefully to avoid staining your clothes or surrounding area.
 - Discard empty FINE Cartridges according to local laws and disposal regulations.

3 Prepare a replacement FINE Cartridge.

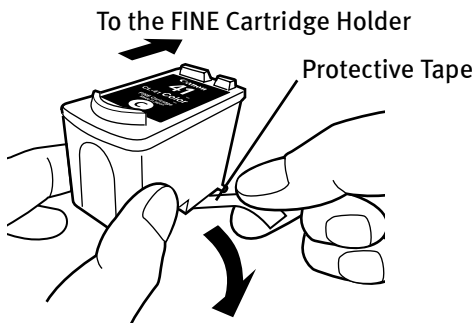

(1) Unpack a new FINE Cartridge and remove the Protective Tape gently.

- Important**
- Do not reattach the Protective Tape once you have removed it.
 - Handle the removed Protective Tape carefully to avoid getting your hands dirty or staining surrounding work area.
 - Once the Protective Tape is removed, do not touch the electrical contacts or Print Head Nozzles on a FINE Cartridge. The printer may not print out properly if you touch it.

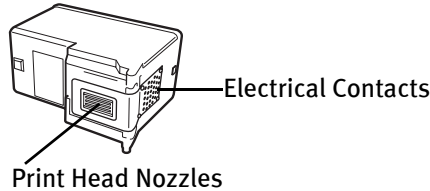

4 Insert the new FINE Cartridge.

The Black FINE Cartridge should be installed into the left slot (B) and the Color FINE Cartridge should be into the right slot (C).

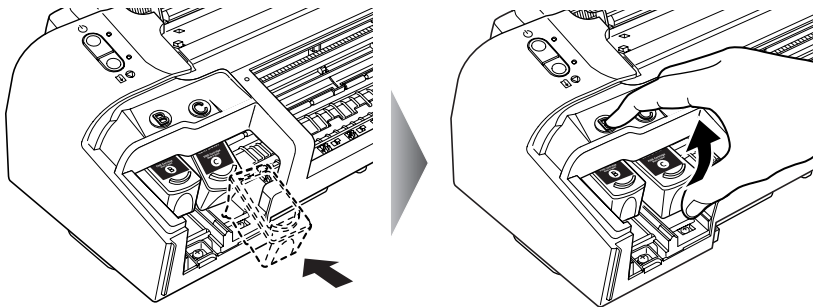

- (1) Insert a new FINE Cartridge slightly slanted.
- (2) Push up the FINE Cartridge until it clicks into place.

5 Close the Front Cover.

The FINE Cartridge Holder moves to the right.

 **Note** If the straight line is misaligned or the Print Head position is misaligned, align the Print Head position.

See "[Aligning the Print Head](#)" on page 34.

- Important**
- To maintain optimal print quality, we recommend that you use Canon brand FINE Cartridge. Replenishing ink only is also not recommended.
 - Replace FINE Cartridge promptly. Do not leave FINE Cartridge removed.
 - When a FINE Cartridge runs out of ink, replace the FINE Cartridge with a new one immediately. If you replace it with the FINE Cartridge that has been removed once, the printer may not print properly due to clogged Print Head nozzles. And, the **Low Ink Warning** dialog box which relays the exchange time of a FINE Cartridge will be off.
 - To maintain optimal print quality, FINE Cartridge should be installed until the "recommended date of replacement". And, use up all ink in the FINE Cartridge within six months from its first use (We recommend that you take note of the date when the FINE Cartridge is installed to the printer).
 - Color ink consumption may occur even when black-and-white or grayscale printing is specified. Color ink is consumed in the head cleaning which are necessary to maintain the printer's capabilities.
 - When a FINE Cartridge runs out of ink, you can continue printing with either Black or Color ink only by **Ink Cartridge Settings**.
In this case, print with leaving the empty FINE Cartridge installed. If either of the Color FINE Cartridge or Black FINE Cartridge is removed, the printer does not work.

See "[Setting of FINE Cartridges](#)" on page 44.

■ What is Low Ink Warning?

Low Ink Warning is that the ink counter counts a remaining level of ink and tells you that Fine Cartridges are running out of ink during printing.

The ink counter considers as ink is full when a new FINE Cartridge is installed, and then starts counting a remaining level of ink. For this, if old FINE Cartridge is installed, remaining ink level may be displayed incorrectly.

Note How to Check the Ink Level

Windows

Open the **Printer Properties** dialog box. Click the **Maintenance** tab and then **View Printer Status**.

Canon IJ Status Monitor appears. It appears during printing automatically.

See "[Opening the Printer Properties Dialog Box Directly from the Start Menu](#)" on page 16.

Macintosh

Open the **Canon IJ Printer Utility** dialog box, and then select **Ink Level Information** from the pop-up menu.

1. Select **Applications** from the **Go** menu.
2. Double-click the **Utilities** folder, and then double-click the **Printer Setup Utility** icon.
If you are using Mac OS X v.10.2.8, double-click the **Utilities** folder, and then double-click the **Print Center** icon.
3. Select **iP1700** from the **Name** list and then click **Utility**.
If you are using Mac OS X v.10.2.8, select **iP1700** from **Name** in **Printer List** and then click **Configure**.
4. Select **iP1700** from the **Product** list and then click **Maintenance**.

When "!" mark appears on Low Ink Warning

Windows

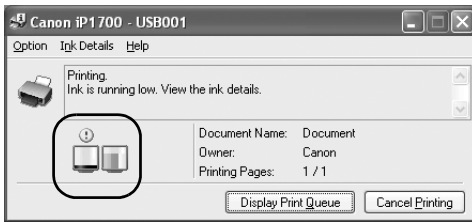

Macintosh

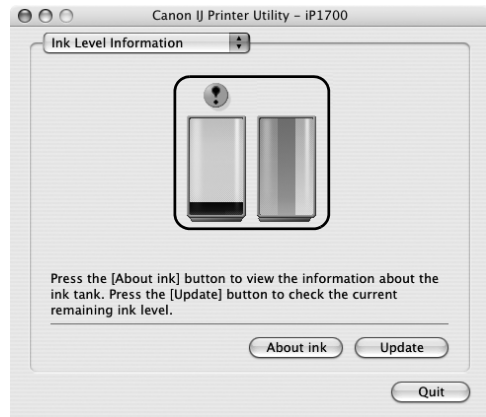

The ink level of the FINE Cartridge with "!" mark is low. You should purchase new FINE Cartridge.

Note **Setting of FINE Cartridges**

If a FINE Cartridge runs out of ink, you can print with either Color or Black FINE Cartridge only for a while. However the same printing quality cannot be expected comparing to printing with both cartridges.

In this case, you should perform the following settings without removing the empty cartridge. If the FINE Cartridge is removed, an error occurs. You cannot print regardless of the **Ink Cartridge Settings**.

Windows

1. Open the **Printer Properties** dialog box.
See "[Opening the Printer Properties Dialog Box Directly from the Start Menu](#)" on page 16.
2. Click the **Maintenance** tab and then **Ink Cartridge Settings**.
3. Select **Color only** when the cartridge runs out of Black ink, or select **Black only** when the cartridge runs out of Color ink, and then click the **OK** button.

Macintosh

1. Select **Applications** from the **Go** menu.
2. Double-click the **Utilities** folder, and then double-click the **Printer Setup Utility** icon.
If you are using Mac OS X v.10.2.8, double-click the **Utilities** folder, and then double-click the **Print Center** icon.
3. Select **iP1700** from **Name** in **Printer List** and then click **Utility**.
If you are using Mac OS X v.10.2.8, select **iP1700** from **Name** in **Printer List** and then click **Configure**.
4. Select **iP1700** from the **Product** list and then click **Maintenance**.
5. Choose **Ink Cartridge Settings** from the pull down menu.
6. Select **Color only** when the cartridge runs out of Black ink, or select **Black only** when the cartridge runs out of Color ink, and then click the **Apply** button.

The **Black only** setting can be used when you select **Plain Paper** in the **Media Type**. In this case the **Borderless Printing** setting cannot be enabled.

If you select **Color only** or **Black only** when the cartridge runs out of ink, remember to return the **Ink Cartridge Settings** to **Both Black and Color** after replacing with a new one.

When "?" mark appears on Low Ink Warning

Windows

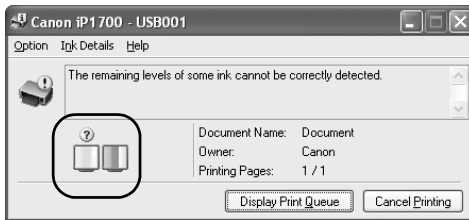

Macintosh

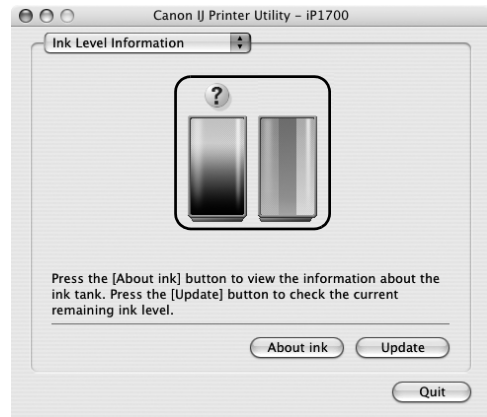

If you install the FINE Cartridge that was once empty and start printing, "?" on the FINE Cartridge appears. Then the following message appears and printing stops. In this case, a remaining level of ink cannot be counted correctly.

Windows



Macintosh



Pressing the **RESUME/CANCEL** button cancels the error indication and enables continuation of printing. However, error detection function is disabled after the error indication is canceled, therefore, **Low Ink Warning** message does not appear later on. When you install new FINE Cartridge, Low Ink Warning is enabled automatically.

Troubleshooting

Troubleshooting usually falls into one of the following categories. In this chapter you will find the most common printing problems. Refer to the *User's Guide* for additional information on topics not covered in this section.

- "Cannot Install the Printer Driver" on page 48
- "The USB Connection Does Not Work Properly" on page 49
- "Print Quality is Poor or Contains Errors" on page 50
- "Printer Does Not Start or Stops During Print Jobs" on page 53
- "Paper Does Not Feed Properly" on page 54
- "Paper Jams" on page 55
- "The ALARM Lamp Flashes" on page 56
- "An Error Message Appears on the Screen" on page 58

Windows

When an Error Occurs

When an error occurs in printing pertaining to such problems as low ink or paper jams, a troubleshooting message is displayed automatically.

The message may vary depending on your operating system.

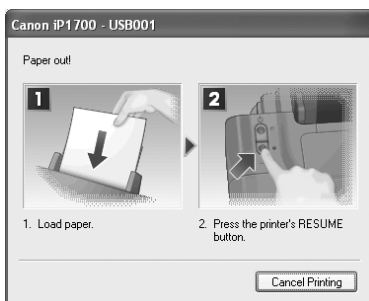

Cannot Install the Printer Driver

Problem	Possible Cause	Try This
Cannot Install the Printer Driver	Installation procedure not followed correctly	<p>Follow the <i>Easy Setup Instructions</i> for proper printer driver installation. If the printer driver was not installed correctly, delete the printer driver and restart your computer following the procedure described in the <i>Printer Driver Guide</i>. Try to reinstall the printer driver.</p> <p>Windows If the installer was forcibly terminated due to an error, restart your computer to reinstall the printer driver.</p>
	Other applications running in the background	Other applications, such as anti-virus software, running in the background can interfere with the printer driver installation. Close all open applications before reinstalling the printer driver.
	Installation does not start automatically when the CD-ROM is inserted into the drive	<p>Windows If printer driver installation did not start automatically when you inserted the CD-ROM into the CD-ROM drive:</p> <ol style="list-style-type: none"> 1. Click Start and select My Computer. 2. Double-click the CD-ROM icon. <p>For non-Windows XP users, open the My Computer window and then double-click the CD-ROM icon.</p> <p>Macintosh Double-click the CD-ROM icon on your desktop to start installation.</p>
	Installation CD-ROM not working properly	<p>Ensure that there are no problems with the <i>Setup CD-ROM</i>.</p> <p>Windows Use Windows Explorer to ensure that the CD-ROM can be read.</p> <p>Macintosh Ensure that the CD-ROM icon is displayed on the desktop. If there is any problem with the CD-ROM, contact the Customer Care Center.</p>
	Unable to proceed beyond the Printer Connection Screen	<p>Windows</p> <div data-bbox="474 960 803 1208" data-label="Image"> </div> <p>If you cannot proceed beyond the Printer Connection screen;</p> <ol style="list-style-type: none"> 1. Click Cancel. 2. When the Installation Failure screen appears, click Start Over. 3. Click Back on the Easy Install screen when it is displayed. 4. Click Exit and remove the CD-ROM. 5. Turn off the printer. 6. Restart the computer. 7. Carefully follow the procedures described in the <i>Easy Setup Instructions</i> and reinstall the printer driver.

The USB Connection Does Not Work Properly

Problem	Possible Cause	Try This
The Printer is not Recognized Properly	You connect to the computer through a USB hub	Connect the printer directly to the computer's USB port without going through the hub.
	Windows A USB expansion card may not be installed correctly	Read the manual supplied with the USB expansion card and reinstall the card.
	Windows The USB driver may not be installed correctly	The computer does not recognize the printer properly. Reinstall the USB driver using the latest version of the driver.

Print Quality is Poor or Contains Errors

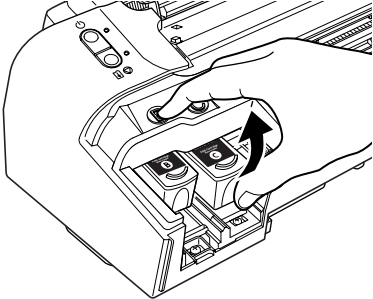
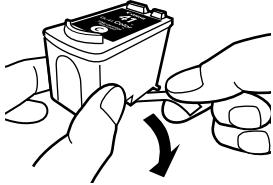

Problem	Possible Cause	Try This
<p>Cannot Print to End of Job</p>	<p>The Page Size setting does not match the size of the paper loaded in the printer</p>	<p>First, check the Page Size setting in the application. Then, check the Page Size setting in the Page Setup tab of the printer driver for Windows or the Page Setup dialog box of the printer driver for Macintosh.</p>
	<p>The size of the print data is too large</p>	<p>Windows If the size of the data is too large, part of it may be lost. When the spool format is EMF, follow the procedure below.</p> <ol style="list-style-type: none"> 1. Open the Printer Properties dialog box. See "Opening the Printer Properties Dialog Box Directly from the Start Menu" on page 16. 2. On the Page Setup tab, click Print Options. 3. Select the Reduce spool data size check box and click OK. When Reduce spool data size is selected, the print quality may be degraded.
<p>Ink Does Not Eject Properly/Not Printed/Printing is Blurred/ Colors are Wrong/White Streaks Appear/ Printed Ruled Lines are Misaligned</p>	<p>FINE Cartridge is not installed properly/ there is no ink left</p>	<p>Remove the FINE Cartridge, then reinstall it. Small dusts may be stuck between the contact points. In this case, the print out result may be improved by reinstalling the FINE Cartridge.</p>  <p>Also, check that the Protective Tape is removed.</p> 
<p>Print Head Nozzles are clogged</p>		<p>Print the nozzle check pattern to ensure that ink is ejected properly. See "Printing the Nozzle Check Pattern" on page 20. If the ink is not ejected properly: See "Print Head Cleaning" on page 25. See "Print Head Deep Cleaning" on page 29.</p>
<p>Incorrect paper type</p>		<p>Windows On the Main tab, ensure that the Media Type selected matches the media being used. Macintosh In the Print dialog box, select Quality & Media from the pop-up menu, and then ensure that the Media Type selected matches the media loaded.</p>

Problem	Possible Cause	Try This
	Glossy photo paper other than Canon specialty media is used	Select Other Photo Paper from Media Type , which may resolve the problem. Load one sheet at a time and remove each sheet as soon as it is printed.
	Print Quality is not set properly	Be sure to set the Print Quality setting to High for Windows or Fine for Macintosh. Windows 1. Open the Printer Properties dialog box. See " Opening the Printer Properties Dialog Box from your Application Program " on page 16. 2. On the Main tab, click High for the Print Quality setting. If you cannot select High or the problem is not solved, select Custom , click Set , and select the higher quality. Macintosh 1. Open the Print dialog box. You can generally select Print in the File menu from you application program. 2. In the Print dialog box, select Quality & Media from the pop-up menu, and then click Detailed Setting . 3. Drag the Print Quality slide bar towards the Fine side.
	Media is not loaded with print-side up	Check that your paper is loaded with the correct print side facing up. Consult " Printing Media " in the <i>User's Guide</i> for detailed instructions on how to load and use your media.
Printed Ruled Lines are Misaligned	Print Head is misaligned	Align the Print Head. See " Aligning the Print Head " on page 34.
	Paper Thickness Lever position is not proper	Set the Paper Thickness Lever in suitable position for your media. See " Canon Specialty Media " on page 10.
	Print Quality is not set properly	Be sure to set the Print Quality setting to High for Windows or Fine for Macintosh. Windows On the Main tab, click High for the Print Quality setting. Macintosh 1. In the Print dialog box, select Quality & Media from the pop-up menu, and then click Detailed Setting . 2. Drag the Print Quality slide bar to the Fine end.
Printed Paper Curls or has Ink Blots	Paper being used is too thin	We recommend that you use a photo paper such as Photo Paper Pro, when you print a photograph or dense colored picture that consumes large amount of ink. See " Using Specialty Media " on page 9.
	Incorrect paper type	Windows On the Main tab, ensure that the Media Type selected matches the media being used. Macintosh In the Print dialog box, select Quality & Media from the pop-up menu, and then ensure that the Media Type selected matches the media being used.
Back of Paper is Smudged	Inside of the printer is dirty	If the inside of the printer is dirty, printed paper may become smudged. Periodically clean the inside of the printer. See " Cleaning the Inside of the Printer " in the <i>User's Guide</i> .
	Paper Feed Roller is dirty	Clean the Paper Feed Roller. See " Paper Does Not Feed Properly " on page 54.

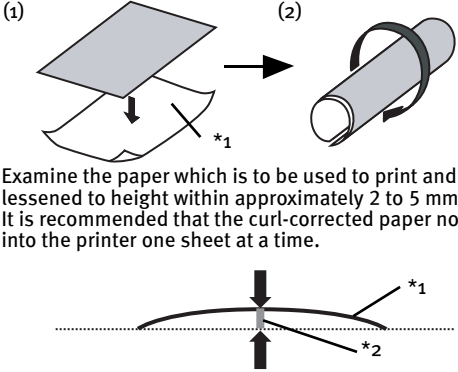
Troubleshooting

Problem	Possible Cause	Try This
Printed Surface is Scratched	Inappropriate type of paper is being used	<p>Check to see if the paper you are printing on is too thick or curled. See "Print Media to Avoid" on page 4.</p> <p>Note that smudging may occur at the top and bottom edges of paper when using Borderless Printing. Ensure that the paper you are using is compatible with Borderless Printing.</p>
	Paper is curled	<p>When all four corners are curled or the printing surface of the paper is curled, the paper may become dirty or the paper may not feed properly. Try using the paper after correcting the curl by taking the following actions.</p> <p>(1) On the side to be printed^{*1}, place a sheet of regular paper exactly over it to avoid damaging the surface.</p> <p>(2) Roll up the papers together in the direction opposite of the curl as shown in the figure below.</p>  <p>(3) Examine the paper which is to be used to print and see if the curl has been lessened to height within approximately 2 to 5 mm / 0.08 to 0.2 inches^{*2}. It is recommended that the curl-corrected paper not be stacked and be fed into the printer one sheet at a time.</p>
Paper Thickness Lever position is not proper		<p>Set the Paper Thickness Lever in suitable position for your media. See "Canon Specialty Media" on page 10.</p> <p>If the paper is scratched even when printing on plain paper (left), set the Paper Thickness Lever to the right.</p> <p>Return the Paper Thickness Lever to the left after printing.</p>

Printer Does Not Start or Stops During Print Jobs

Problem	Possible Cause	Try This
Printer Does Not Start or Printer Stops During Print Jobs	<p>Printer cable is too long</p> <p>Undesired print jobs are spooled/Troubles in your computer</p>	<p>Avoid using USB cables longer than 16.4 feet.</p> <p>Restart your computer. It may solve the problem. Delete any undesired print jobs. Use Canon IJ Status Monitor in Windows or click the printer's icon in the Dock in Macintosh for the deletion.</p> <p>Windows</p> <ol style="list-style-type: none"> 1. Open the Printer Properties dialog box. See "Opening the Printer Properties Dialog Box Directly from the Start Menu" on page 16. 2. Click the Maintenance tab and then View Printer Status. 3. Click Display Print Queue. 4. Then select Cancel All Documents in the Printer menu. When the confirmation message is displayed, click Yes. The print job is deleted. <p> Note In Windows Me or Windows 98 Click to select an undesired document and select Purge Print Documents in the Printer menu.</p> <p>Macintosh</p> <ol style="list-style-type: none"> 1. Click the printer's icon in the Dock and display the list of print jobs in progress. If you are using Mac OS X v.10.2.8, click on the printer icon in the Dock to start up the Print Center and double-click on the name of your printer in the Printer List to open a list of print jobs in progress. 2. Select an undesired document and click . The print job is deleted.

Paper Does Not Feed Properly

Problem	Possible Cause	Try This
Paper Does Not Feed Properly	Inappropriate type of paper is being used	<ul style="list-style-type: none"> • Check to see if the paper you are printing on is too thick or curled. See "Print Media to Avoid" on page 4. • Check if the paper exceeds the load limit mark. If it exceeds, load less paper. See "Loading Plain Paper" on page 6.
	Paper Feed Roller is dirty	<p>Follow the steps described below to clean the Paper Feed Rollers. Since the Paper Feed Roller cleaning exhausts the Paper Feed Roller, perform only when it is needed. Three sheets of Letter size plain paper are required for the cleaning. Have them on hand.</p> <p>Windows</p> <ol style="list-style-type: none"> 1. Ensure that the printer is turned on, and remove papers loaded in the printer. 2. Open the Printer Properties dialog box. See "Opening the Printer Properties Dialog Box Directly from the Start Menu" on page 16. 3. Click the Maintenance tab, then click Roller Cleaning. The confirmation message is displayed. Follow the on-screen instructions. <p>Macintosh</p> <ol style="list-style-type: none"> 1. Ensure that the printer is turned on, and remove papers loaded in the printer. 2. Open the Canon IJ Printer Utility to ensure that Cleaning is displayed in the pull-down menu. 3. Click Roller Cleaning. The confirmation message is displayed. Follow the on-screen instructions.

Paper Jams

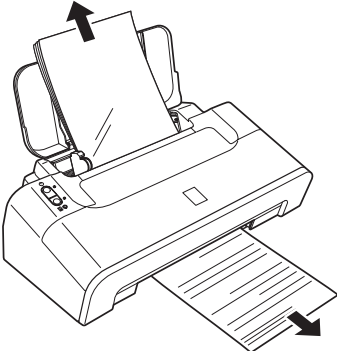
Problem	Possible Cause	Try This
Paper Jams	Paper jams in Paper Output Slot/Auto Sheet Feeder	<p>Remove the paper according to the following procedure.</p> <ol style="list-style-type: none"> 1. Slowly pull the paper out, either from the Auto Sheet Feeder or from the Paper Output Slot, whichever is easier.  <ul style="list-style-type: none"> • If the paper tears and a piece remains inside the printer, open the Front Cover and remove it. Caution Be careful not to touch any components inside the printer. After removing all paper, close the Front Cover. • If you cannot pull the paper out, turn the printer off and turn it back on. The paper will be ejected automatically. <p>2. Reload the paper into the printer and press the RESUME/CANCEL button.</p> <p>If you cannot remove the paper or if the paper tears inside the printer or the paper jam error (See "The ALARM Lamp Flashes" on page 56) continues after removing the paper, contact the Customer Care Center.</p>
	Paper is loaded incorrectly	<p>Check to see if the paper is loaded correctly, and set the Paper Guide for the loaded paper correctly. See "Loading Paper" on page 4.</p>

The ALARM Lamp Flashes

When a printer error occurs, the **ALARM** lamp flashes after the **POWER** lamp was turned off and then on. The number of flashes indicates the type of error that has occurred. Count the flashes and then take appropriate action to correct the error.

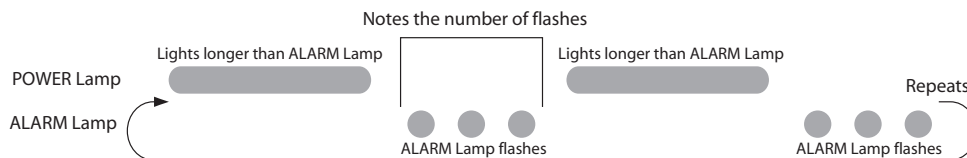

Number of Flashes	Possible Cause	Try This
Two Flashes	Out of paper or paper feed error	Reload paper and press the RESUME/CANCEL button.
Three Flashes	Paper jam	If a paper jam occurs, clear the jammed paper, reload paper in the printer, then press the RESUME/CANCEL button. See " Paper Jams " on page 55.
Four Flashes	The ink may have run out	Ink has run out. Replace the FINE Cartridge, and close the Front Cover. If lines are misaligned or the resulting output is not satisfactory, carry out the Print Head Alignment. If printing is in progress and you want to continue printing, press the RESUME/CANCEL button. Then printing can continue under the ink out condition with the FINE Cartridge installed. Replace the empty FINE Cartridge immediately after the printing. The resulting print quality is not satisfactory, if printing is continued under the ink out condition.
Five Flashes	The FINE Cartridge cannot be recognized	Possible causes are as follows: <ul style="list-style-type: none"> The FINE Cartridge may not be installed properly. The FINE Cartridge may not be the compatible with this printer. Install the appropriate FINE Cartridge. If lines are misaligned or the resulting output is not satisfactory, carry out the Print Head Alignment. See " Replacing a FINE Cartridge " on page 39. See " Aligning the Print Head " on page 34.
Seven Flashes	The FINE Cartridge is not installed in the appropriate position	Some FINE Cartridges are not installed in place. Install the FINE Cartridges in the appropriate positions. See " Replacing a FINE Cartridge " on page 39.
Eight Flashes	Ink absorber is almost full	Ink used for cleaning is absorbed in a ink absorber inside the machine. Press the RESUME/CANCEL button to dismiss the error message and continue printing. You can continue printing for a while, but once the ink absorber becomes completely full, you will not be able to print until the ink absorber is replaced. Contact a Canon service representative as soon as possible to have this part replaced.
Fourteen Flashes	The FINE Cartridge cannot be recognized	The FINE Cartridge may not be the compatible with this printer. Install the appropriate FINE Cartridge. If lines are misaligned or the resulting output is not satisfactory, carry out the Print Head Alignment. See " Aligning the Print Head " on page 34.
Fifteen Flashes	The FINE Cartridge cannot be recognized	Possible causes are as follows: <ul style="list-style-type: none"> The FINE Cartridge may not be installed properly. The FINE Cartridge may not be the compatible with this printer. Install the appropriate FINE Cartridge. If lines are misaligned or the resulting output is not satisfactory, carry out the Print Head Alignment. See " Replacing a FINE Cartridge " on page 39. See " Aligning the Print Head " on page 34.

Number of Flashes	Possible Cause	Try This
Sixteen Flashes	The ink level cannot be correctly detected	<p>Possible causes are as follows:</p> <ul style="list-style-type: none"> · This FINE Cartridge has previously been used. · Ink may have run out. <p>The function for detecting the remaining ink level will be disabled since the remaining ink level cannot be correctly detected. If you want to continue printing without this function, press the RESUME/CANCEL button.</p> <p>Canon recommends to use new genuine Canon cartridges in order to obtain optimum quality.</p>

 **Note** **The POWER Lamp (green) and ALARM Lamp (orange) Flashes Alternately:** Disconnect the printer cable from the printer, and then turn the printer off and then unplug the printer from the power supply for a while. Plug the printer back in and turn the printer back on.
If the problem remains, contact the Customer Care Center.

An Error Message Appears on the Screen

Problem	Possible Cause	Try This
Windows Error Writing/Output to USBn\nn or MPUSBPRN\nn	Printer not ready	Ensure that the printer is turned on. If the POWER lamp is turned off, turn the printer on. When the POWER lamp is flashing, the printer is initializing. Wait until the POWER lamp stops flashing.
	Paper is not loaded	Load paper and press the RESUME/CANCEL button. An error message may appear if the "No paper" error has not been reset for a certain period.
	The printer port setting does not match the printer interface connection	Ensure the printer port setting. 1. Click Start, Control Panel, Printers and Other Hardware , then Printers and Faxes . If your OS is other than Windows XP, click Start, Settings , then Printers . 2. Click the Canon iP1700 icon. 3. On the File menu, select Properties . 4. On the Ports tab (or Details tab), check if the printer port setting corresponds to the printer interface connection. If USBn\nn (Canon iP1700) or MPUSBPRN\nn (Canon iP1700) ("n" represents a number) is displayed in the Print to the following port(s) field, the USB port is selected. If the port setting is not correct, modify the port setting according to the interface you use on the Ports tab (or Details tab), or reinstall the printer driver.
	Printer not properly connected	Ensure that the printer is securely connected to the computer. Note If you are using a switch box or other devices, remove and reconnect the printer directly to the computer and try printing again. If you are now able to print successfully, there may be a problem with your switch box or other device. Also there could be a problem with the cable(s). Replace the cable(s) and try printing again.
	Printer driver is not installed properly	Uninstall then reinstall the printer driver. 1. Click Start , and select All Programs (or Programs), Canon iP1700 , and Uninstall . 2. Follow the on-screen instructions to uninstall the driver. 3. Follow the procedures described in the <i>Easy Setup Instructions</i> and reinstall the printer driver.
Macintosh "Error No.: 300"	Printer not ready	Ensure that the printer is turned on. If the POWER lamp is turned off, turn the printer on. When the POWER lamp is flashing, the printer is initializing. Wait until the POWER lamp stops flashing.
	Printer not properly connected	Ensure that the printer is securely connected to the computer. Note If you are using a switch box or other devices, remove and reconnect the printer directly to the computer and try printing again. If you are now able to print successfully, there may be a problem with your switch box or other device. Also there could be a problem with the cable(s). Replace the cable(s) and try printing again.
	Your printer name is not displayed in Printer	1. Select Print and Fax Preferences from the Printer pop-up menu. When using Mac OS X v.10.3.x or Mac OS X v.10.2.8, select Edit Printer List from the Printer pop-up menu. 2. Ensure that Canon iP1700 is displayed and the check box is selected in the screen that is displayed. When using Mac OS X v.10.2.8, ensure that Canon iP1700 is displayed in the Printer List. If Canon iP1700 is not displayed in Printer , follow the procedures described in the <i>Easy Setup Instructions</i> and reinstall the printer driver.

Problem	Possible Cause	Try This
<p>Macintosh "Error No.:1700"</p>	<p>The ink absorber is almost full</p>	<p>Ink used for cleaning is absorbed in a ink absorber inside the machine. Press the RESUME/CANCEL button to dismiss the error message and continue printing. You can continue printing for a while, but once the ink absorber becomes completely full, you will not be able to print until the ink absorber is replaced.</p> <p>Contact a Canon service representative as soon as possible to have this part replaced.</p>

Appendix

Specifications

Printer

Maximum resolution (dpi):	4800 (horizontal)* x 1200 (vertical) (*Ink droplets can be placed in a pitch of 1/4800 inch at minimum.)
Print speed *	Black printing Max Speed (Custom Setting 5): 22 ppm Standard: 13.3 ppm Color printing Max Speed (Custom Setting 5): 17 ppm Standard: 7.8 ppm
*Print speed will vary depending on system configuration, software, document complexity, print mode and page coverage.	
Print width:	203.2 mm max. (8.0 in) (for Borderless Printing: 216 mm/8.5 in)
Interface:	USB
Acoustic noise level:	Approx. 44 dB (A) (when printing in the highest print quality mode on Photo Paper Pro)
Operating environment:	Temperature: 5 to 35°C (41 to 95°F) Humidity: 10 to 90%RH (no condensation)
Storage environment:	Temperature: 0 to 40°C (32 to 104°F) Humidity: 5 to 95% RH (no condensation)
Power supply:	AC 100-240 V, 50/60 Hz
Power consumption:	Standby: 1 W or lower Printing: Approx. 10 W OFF: Approx. 0.5 W
Dimensions (with Paper Support retracted):	435 (W) x 253 (D) x 165 (H) mm 17.13 (W) x 9.96 (D) x 6.5 (H) in
Weight:	Approx. 3.0 kg (6.5 lb)
Canon FINE Cartridges:	Nozzles: Black: 320 nozzles Cyan/Magenta/Yellow: 384 x 3 nozzles

Minimum System Requirements*¹

Windows*²

Operating System	Processor	RAM	Hard Disk Space
Windows XP SP1, SP2	PentiumII 300 MHz* ³	128 MB	400 MB
Windows 2000 Professional SP2, SP3, SP4 Windows Millennium Edition			
Windows 98, 98 Second Edition			

Macintosh

Operating System	Processor	RAM	Hard Disk Space
Mac OS X v.10.4.x	Intel processor, PowerPC G3/G4/G5	256 MB	250 MB
Mac OS X v.10.2.8 - v.10.3.x		128 MB	

*1 For updated compatibility, visit our website.

*2 Operation can only be guaranteed on a PC with built-in USB or USB 2.0 Hi-Speed port and pre-installed Windows XP, 2000, Me, 98 or Mac OS X v.10.2.8-v.10.4.

*3 Including compatible processors.

- CD-ROM drive

Windows

- Display: 800 x 600
Color (16bit)

- Macintosh File System : Mac OS X Extended(Journaled), Mac OS X Extended

Macintosh

- Display: 800 x 600
Thousands Colors

Additional System Requirements for On-screen Manuals

Windows

Browser: Windows HTML Help Viewer

Note: Microsoft Internet Explorer 5.0 or later must be installed.

The On-screen Manual may not be displayed properly depending on your operating system or Internet Explorer version. We recommend that you keep your system up to date with Windows Update.

Macintosh



Browser: Help Viewer

Note: The On-screen Manual may not be displayed properly depending on your operating system. We recommend that you keep your system up to date.

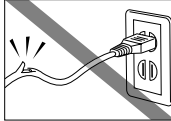
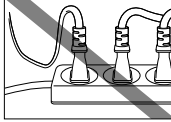

⚠ Safety Precautions

Please read the safety warnings and cautions provided in this manual to ensure that you use your printer safely. Do not attempt to use printer in any way not described in this manual.

Warning You may cause an electric shock/fire or damage the printer if you ignore any of these safety precautions.

Choosing a location	Do not place the printer close to flammable solvents such as alcohol or thinners.	
Power supply	Never attempt to plug in or unplug the printer from the power supply when your hands are wet.	
	Always push the plug all the way into the power outlet.	
	Never damage, modify, stretch or excessively bend or twist the power cord. Do not place heavy objects on the power cord.	
	Never plug the printer into a power socket that is shared with other equipment (extension lead/cord, 2- or 3- way adapter, etc.).	
	Never use the printer if the power cord is bundled or knotted.	
	If you detect smoke, unusual smells or strange noises around the printer, immediately unplug the printer at the power supply and call for service.	
Cleaning the printer	Use a damp cloth to clean the printer. Never use flammable solvents such as alcohol, benzene or thinners. If flammable solvents come in contact with the electrical components inside the printer, it could cause a fire or electric shock.	
	Always unplug the printer from the power outlet before cleaning the printer. If you accidentally switch the printer on while cleaning it, you could injure yourself or damage the printer.	
Maintaining the printer	Do not attempt to disassemble or modify the printer. There are no user serviceable parts inside the printer. The printer contains high-voltage components. Never attempt any maintenance procedure which is not described in this guide.	
Working around the printer	Do not use flammable sprays near the printer. This could cause a fire or electric shock if spray were to come in contact with the electrical components inside the printer.	

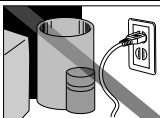
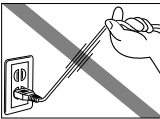
Caution You may cause injury or damage the printer if you ignore any of these safety precautions.

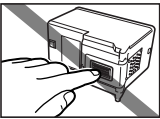
Choosing a location	Do not install the printer in a location that is unstable or subject to excessive vibration.	
	Do not install the printer in locations that are very humid or dusty, in direct sunlight, outdoors, or close to a heating source. To avoid the risk of fire or electric shocks, install the printer in a location that has a constant temperature range of 5°C to 35°C (41°F to 95°F) and humidity of 10% to 90% (condensation free).	
	Do not place the printer on a thick rug or carpet.	
Power supply	Ensure that the area around the power outlet is kept clear at all times so you can easily unplug the power cord when if necessary.	
	Never remove the plug by pulling on the cord.	
	Do not use an extension lead/cord.	
	Never use a power supply source other than the one rated for the printer in the country of where you purchased the printer. AC 100-240 V, 50/60 Hz	
Working around the printer	Never put your hands or fingers in the printer while it is printing.	
	When moving the printer, carry the printer at both ends.	
	Do not place any object on the printer.	
	Do not place any metal objects (paper clips, staples, etc.) or containers of flammable solvents (alcohol, thinners, etc.) on top of the printer.	
	Should any foreign object (metal or liquid) fall into the printer, unplug the power cord and call for service.	
	When installing or transporting this printer, do not incline it, lay it down on its side, or turn it upside down. Ink can leak.	
FINE Cartridges (Ink Cartridges)	For safety reasons, store FINE Cartridges (Ink Cartridges) out of the reach of small children. If a child should ingest any ink, consult a doctor immediately.	
	Do not shake FINE Cartridges (Ink Cartridges). Ink may leak out and stain clothing or the surrounding area.	
	Never touch the electrical contacts or Print Head Nozzles on a FINE Cartridge (Ink Cartridge) after printing. The metal parts may be very hot and could cause burns.	

Regulatory Information

For 120V, 60Hz model

Color Printer Model: K10279

This device complies with Part 15 of the FCC Rules. Operation is subject to the following two conditions: (1) This device may not cause harmful interference, and (2) this device must accept any interference received, including interference that may cause undesired operation.

Note: This equipment has been tested and found to comply with the limits for a Class B digital device, pursuant to Part 15 of the FCC Rules. These limits are designed to provide reasonable protection against harmful interference in a residential installation. This equipment generates, uses and can radiate radio frequency energy and, if not installed and used in accordance with the instructions, may cause harmful interference to radio communications. However, there is no guarantee that interference will not occur in a particular installation. If this equipment does cause harmful interference to radio or television reception, which can be determined by turning the equipment off and on, the user is encouraged to try to correct the interference by one or more of the following measures:

- Reorient or relocate the receiving antenna.
- Increase the separation between the equipment and receiver.
- Connect the equipment into an outlet on a circuit different from that to which the receiver is connected.
- Consult the dealer or an experienced radio/TV technician for help.

Use of a shielded cable is required to comply with Class B limits in Subpart B of Part 15 of the FCC Rules.

Do not make any changes or modifications to the equipment unless otherwise specified in the manual. If such changes or modifications should be made, you could be required to stop operation of the equipment.

Canon U.S.A., Inc.
One Canon Plaza
Lake Success, NY 11042
1-516-328-5600

(For U.S.A. Only)

Canadian Radio Interference Regulations

This digital apparatus does not exceed the Class B limits for radio noise emissions from a digital apparatus as set out in the interference-causing equipment standard entitled "Digital Apparatus", ICES-003 of the Industry Canada.

Cet appareil numérique respecte les limites de bruits radioélectriques applicables aux appareils numériques de Classe B prescrites dans la norme sur le matériel brouilleur NMB-003 d'Industrie Canada intitulée « Appareils numériques ».

CANON U.S.A., INC. LIMITED WARRANTY --- (USA Only)

The limited warranty set forth below is given by Canon U.S.A., Inc. ("Canon USA") with respect to the new or refurbished Canon-brand product ("Product") packaged with this limited warranty, when purchased and used in the United States only. The Product is warranted against defects in materials and workmanship under normal use and service (a) for a period of one (1) year from the date of original purchase when delivered to you in new condition in its original container or (b) for 90 days from the date of original purchase for refurbished Products. Defective parts or a defective Product returned to a Canon USA repair facility or a Canon USA Authorized Service Facility ("ASF"), and proven to be defective upon inspection, will be repaired, exchanged for new or comparable rebuilt parts, or exchanged for a refurbished Product, as determined by the Canon USA repair facility or the ASF. Warranty repair or replacement shall not extend the original warranty period of the Product. A dated proof of purchase is required at the time of warranty service. A copy of your dated bill of sale will satisfy this requirement. This warranty does not cover any accessories, or any consumables, such as paper or ink cartridges, as to which there shall be no warranty or replacement.

This limited warranty shall only apply if the Product is used in conjunction with compatible computers, peripheral equipment and software. Canon USA shall have no responsibility for such items except for compatible Canon brand peripheral equipment covered by a separate warranty ("Separate Warranty"). Repairs of such Canon brand peripheral equipment shall be governed by the terms of the Separate Warranty. Non-Canon brand equipment and software that may be distributed with the Product are sold "as is" and without warranty of any kind by Canon USA, including any implied warranty regarding merchantability or fitness for a particular purpose, and all such warranties are disclaimed. The sole warranty, if any, with respect to such non-Canon brand items is given by the manufacturer or producer thereof.

This limited warranty covers all defects encountered in normal use of the Product and does not apply in the following cases:

- (a) Loss of or damage to the Product due to abuse, neglect, mishandling, improper packaging by you, alteration, accident, electrical current fluctuations, improper use, failure to follow operating or maintenance instructions in, or environmental conditions prescribed in, Canon USA's user's manual or other documentation, or services performed by someone other than a Canon USA repair facility or ASF. Without limiting the foregoing, dropping the Product, scratches, and abrasions will be presumed to have resulted from misuse, abuse or failure to operate the Product as set forth in the user's manual or other documentation for the Product.
- (b) Use of parts or supplies (other than those sold by Canon USA) that cause damage to the Product or cause abnormally frequent service calls or service problems.
- (c) If the Product has had its serial number or dating defaced, altered or removed.

ANY SYSTEM SOFTWARE (WHETHER FACTORY LOADED ON THE PRODUCT OR CONTAINED ON THE SOFTWARE DISKETTES OR CDROMS ENCLOSED WITH, OR ACCOMPANYING, THE PRODUCT), AND ANY UTILITY SOFTWARE, DISTRIBUTED WITH OR FOR THE PRODUCT, IS SOLD "AS IS" AND WITHOUT WARRANTY BY CANON USA. THE SOLE WARRANTY WITH RESPECT TO SUCH SOFTWARE IS CONTAINED IN THE SOFTWARE MANUFACTURER'S LICENSE AGREEMENT DISTRIBUTED THEREWITH, INCLUDING ANY LIMITATIONS AND DISCLAIMERS THEREON. PLEASE CONTACT CANON USA IMMEDIATELY IF YOU HAVE NOT RECEIVED A COPY OF THE SOFTWARE MANUFACTURER'S LICENSE AGREEMENT.

NO IMPLIED WARRANTY, INCLUDING ANY IMPLIED WARRANTY OF MERCHANTABILITY OR FITNESS FOR A PARTICULAR PURPOSE, APPLIES TO THE PRODUCT AFTER THE APPLICABLE PERIOD OF THE EXPRESS LIMITED WARRANTY STATED ABOVE, AND NO OTHER EXPRESS WARRANTY OR GUARANTY, EXCEPT AS MENTIONED ABOVE, GIVEN BY ANY PERSON OR ENTITY WITH RESPECT TO THE PRODUCT SHALL BIND CANON USA, OR ITS ASF. (SOME STATES DO NOT ALLOW LIMITATIONS ON HOW LONG AN IMPLIED WARRANTY LASTS, SO THE ABOVE LIMITATION MAY NOT APPLY TO YOU.) CANON USA SHALL NOT BE LIABLE FOR LOSS OF REVENUES OR PROFITS, INCONVENIENCE, EXPENSE FOR SUBSTITUTE EQUIPMENT OR SERVICE, STORAGE CHARGES, LOSS OR CORRUPTION OF DATA, OR ANY OTHER SPECIAL, INCIDENTAL OR CONSEQUENTIAL DAMAGES CAUSED BY THE USE, MISUSE, OR INABILITY TO USE THE PRODUCT REGARDLESS OF THE LEGAL THEORY ON WHICH THE CLAIM IS BASED, AND EVEN IF CANON USA OR ITS ASF HAS BEEN ADVISED OF THE POSSIBILITY OF SUCH DAMAGES. NOR SHALL RECOVERY OF ANY KIND AGAINST CANON USA OR ITS ASF BE GREATER IN AMOUNT THAN THE PURCHASE PRICE OF THE PRODUCT CAUSING THE ALLEGED DAMAGE. WITHOUT LIMITING THE FOREGOING, YOU ASSUME ALL RISK AND LIABILITY FOR LOSS, DAMAGE OR INJURY TO YOU AND YOUR PROPERTY AND TO OTHERS AND THEIR PROPERTY ARISING OUT OF THE POSSESSION, USE, MISUSE, OR INABILITY TO USE THE PRODUCT SOLD BY CANON USA NOT CAUSED SOLELY AND DIRECTLY BY THE NEGLIGENCE OF CANON USA, OR ITS ASF. (SOME STATES DO NOT ALLOW THE EXCLUSION OR LIMITATION OF INCIDENTAL OR CONSEQUENTIAL DAMAGES, SO THE ABOVE EXCLUSION OR LIMITATION MAY NOT APPLY TO YOU.) THIS LIMITED WARRANTY SHALL NOT EXTEND TO ANYONE OTHER THAN THE ORIGINAL PURCHASER OF THE PRODUCT OR THE PERSON FOR WHOM IT WAS PURCHASED AS A GIFT, AND STATES YOUR EXCLUSIVE REMEDY.

Appendix

Canon USA offers a range of customer technical support* options:

- Interactive troubleshooting, e-mail technical support, the latest driver downloads and answers to frequently asked questions (www.canontechsupport.com)
- Toll-free live technical support Monday-Saturday (excluding holidays) at 1-800-828-4040
- Telephone Device for the Deaf (TDD-1-866-251-3752)
- Repair or Exchange Service Options:
In the event service is required for the Product during the limited warranty period, Canon USA offers two hardware support options:

Authorized Service Facility Carry-In / Mail-In Service

Canon USA's Carry-In/Mail-In Service provides repair or exchange, at Canon USA's option, through Canon USA's Authorized Service Facility (ASF) network. The name and telephone number of the ASF(s) near you may be obtained from Canon USA's Web site at: www.canontechsupport.com or by calling the Canon USA Customer Care Center at 1-800-828-4040, or any time while speaking to a technical support person. A Product covered by this limited warranty will be repaired or exchanged, as determined by Canon USA, and returned without charge by the ASF.

InstantExchange Service **

A Canon Customer Care Center or ASF technician will attempt to diagnose the nature of the problem and, if possible, correct it over the telephone. If the problem cannot be corrected over the telephone, and you elect the InstantExchange option, a reference number will be issued to you. You will be asked for the Product serial number and other information pertaining to your defective Product and for a ship-to location for the replacement Product (must include street address). The Canon USA repair facility will ship out the replacement Product, via 2nd day Air freight service, prepaid by Canon USA. After receipt of the replacement Product (with instructions and a prepaid waybill), follow the enclosed instructions on how to ship the defective Product to the Canon USA repair facility. The defective Product must be returned in the shipping carton in which the replacement Product was packed and include the reference number, A COPY OF YOUR DATED PROOF OF PURCHASE (BILL OF SALE), and a complete explanation of the problem. DO NOT INCLUDE ANY OTHER ITEMS WITH THE DEFECTIVE PRODUCT IN THE RETURN SHIPPING CARTON, AND BE SURE TO RETAIN YOUR PRINthead AND INK CARTRIDGE(S) AND TANK(S).

InstantExchange Service expedites, usually by the second business day, the exchange of a defective Product with a replacement Product, which will normally be shipped the same day if your request for this service is by 3 p.m. E.T. Monday through Friday, except holidays (three (3) business day InstantExchange Service for Alaska and Hawaii). Canon USA does not guarantee expedited shipping service in the event of the occurrence of factors beyond its reasonable control. The replacement Product you receive may be a refurbished or reconditioned unit and will be covered for the balance of the period remaining on your original limited warranty. NOTE THAT BY USING THIS SERVICE YOU WILL KEEP THE REPLACEMENT PRODUCT THAT IS SENT TO YOU. CANON USA WILL RETAIN THE DEFECTIVE PRODUCT THAT YOU ORIGINALLY PURCHASED, WHICH SHALL BECOME THE PROPERTY OF CANON USA. InstantExchange warranty program service is available only during the express limited-warranty period for your Product and only in the continental United States, Alaska and Hawaii during such period.

This limited warranty gives you specific legal rights, and you may also have other rights, which vary from state to state.

* Support program specifics are subject to change without notice.

** InstantExchange warranty service is subject to the availability of refurbished or new replacement units.

Canon U.S.A., Inc.
One Canon Plaza
Lake Success, NY 11042
USA

Canon is a registered trademark of Canon Inc.

©2006 Canon U.S.A., Inc. Canon is a registered trademark of Canon Inc. in the United States and may also be a registered trademark in other countries.

Index

A

Advanced Printing	16
ALARM Lamp	2
ALARM Lamp Flashes	56
Aligning the Print Head	34
An Error Message Appears on the Screen	58

B

Borderless Print	18
Borderless Printing	52

C

Cancel Printing	15
Cannot Install the Printer Driver	48
Canon IJ Printer Utility dialog box	21
CANON U.S.A., INC. LIMITED WARRANTY --- (USA Only) ..	65
CL-41	39
Cleaning	25, 29

D

Deep Cleaning	29, 31
Driver	
settings	12, 14
uninstalling	58

E

Easy-PhotoPrint	18
Easy-WebPrint	18
Examining the Nozzle Check Pattern	23
Exif Print	18

F

FINE Cartridge	39
----------------------	----

G

Glossy Photo Paper	10
--------------------------	----

H

High Resolution Paper	10
-----------------------------	----

L

Load Limit Mark	6
Loading 4" x 6" size papers	8
Loading Envelopes	7
Loading Plain Paper	6

M

Matte Photo Paper	10
Media Name	10
Media Type	10, 12, 14
Minimum System Requirements	61

N

Nozzle Check	20, 21
Nozzle Check Pattern	
examining	23
printing	20

O

Opening the Printer Properties Dialog Box Directly from the Start Menu	16
Opening the Printer Properties Dialog Box from your Application Program	16

P

Page Setup	13
Page Setup dialog box	13
Paper Feed Rollers	54
Paper Size	13
Paper Support Load Limit	10
Paper Thickness Lever	5
Paper Thickness Lever Position	10
Pattern Check dialog	24
PG-40	39
Photo Paper Plus Double Sided	10
Photo Paper Plus Glossy	10
Photo Paper Plus Semi-Gloss	10
Photo Paper Pro	10
Photo Stickers	10
PhotoRecord	18
POWER button	2
POWER lamp	2
Preparing the Printer	5
Preview before printing	12
Print Center	21
Print Check Pattern	20, 22
Print dialog box	11, 14
Print Head Alignment	34, 37
Print Head Cleaning	25
Print Head Deep Cleaning	29
Print Media to Avoid	4
Print Mode	14
Print Quality	12, 50
Printer Driver Settings for Media Type	10
Printer Properties dialog box	11, 16, 20, 51

Index

Printer Setup Utility	21
Printing the Nozzle Check Pattern	20

R

Replacing a FINE Cartridge	39
RESUME/CANCEL button	13

S

Safety Precautions	62
Specialty Media	10
Specifications	60
Status Monitor	53
Super White Paper	10

T

Troubleshooting	47
T-Shirt Transfers	10
Turning off the Printer	3
Turning on the Printer	2

U

Uninstalling the printer driver	58
Using Specialty Media	9

W

What is Low Ink Warning?	43
When "!" mark appears on Low Ink Warning	44
When "?" mark appears on Low Ink Warning	46
When Printing Becomes Faint or Colors are Incorrect ...	19

Ordering Information

For additional supplies, use the following descriptions and order numbers.

Description	Order #
FINE Cartridges	
PG-40	0615B002
CL-41	0617B002
Canon Specialty Papers	
Photo Paper Plus Glossy (4" x 6"/20 sheets)	7980A007
Photo Paper Plus Glossy (4" x 6"/50 sheets)	7980A012
Photo Paper Plus Glossy (4" x 6"/120 sheets)	7980A022
Photo Paper Plus Glossy (5" x 7"/20 sheets)	7980A019
Photo Paper Plus Glossy (8.5" x 11"/20 sheets)	7980A006
Photo Paper Plus Double Sided (5" x 7"/10 sheets)	9981A006
Photo Paper Plus Double Sided (8.5" x 11"/10 sheets)	9981A005
Photo Paper Plus Double Sided Album Kit (5" x 7")	0041B005
Photo Paper Plus Double Sided Album Kit (8.5" x 11")	0041B006
Photo Paper Plus Semi-Gloss (4" x 6"/50 sheets)	8386A010
Photo Paper Plus Semi-Gloss (8.5" x 11"/20 sheets)	8386A007
Photo Paper Pro for Borderless Printing (4" x 6"/20 sheets)	1029A014
Photo Paper Pro for Borderless Printing (4" x 6"/75 sheets)	1029A027
Photo Paper Pro (8.5" x 11"/15 sheets)	1029A004
Photo Paper Pro (8" x 10"/20 sheets)	1029A059
Photo Paper Pro (8.5" x 11"/30 sheets)	1029A028
Matte Photo Paper (4" x 6"/120 sheets)	7981A014
Matte Photo Paper (8.5" x 11"/50 sheets)	7981A004
Photo Paper Glossy (4" x 6"/50 sheets)	0755B021
Photo Paper Glossy (4" x 6"/100 sheets)	0775B022
Photo Paper Glossy (8.5" x 11"/50 sheets)	0775B023
Photo Paper Glossy (8.5" x 11"/100 sheets)	0775B024
Glossy Photo Paper Credit Card Size	9157A023
Photo Stickers	0001C001
High Resolution Paper (8.5" x 11"/100 sheets)	1043A011

Call **1-800-OK-CANON** to locate a dealer near you, or visit the Canon eStore at www.estore.usa.canon.com.



Canon U.S.A., Inc.

One Canon Plaza, Lake Success, NY 11042, U.S.A.

Canon Inc.

30-2, Shimomaruko 3-chome, Ohta-ku, Tokyo 146-8501, Japan

Canon Canada, Inc.

6390 Dixie Road, Mississauga, Ontario, L5T 1P7, Canada

Canon Latin America, Inc.

703 Waterford Way, Suite 400, Miami, FL 33126, U.S.A.

Canon Mexicana

Boulevard Manuel Avila Camacho No. 138 PB
y Pisos 15, 16 y 17, Colonia Lomas de Chapultepec
Delegación Miguel Hidalgo, CP 11000, Mexico D.F.

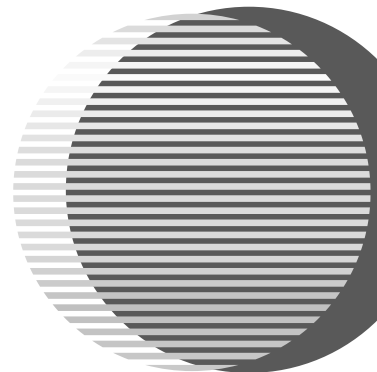

The following FINE Cartridges are compatible with iP1700.



Black

PG-40



Color

CL-41