

# Canon

GX7000 series

GX6000 series

## Getting Started

## Guía de inicio

Read **Safety and Important Information**  
(addendum) first.

Lea primero **Información de seguridad  
e información importante** (apéndice).



QT63586V01



Installing the Printer.....page 1

Instalación de la impresora .....página 1



Connecting to a Computer, Smartphone or Tablet ..... page 6

Conexión con un ordenador, teléfono inteligente o tableta ..... página 6

The illustrations and screenshots used in this book are from the GX7000 series. Model-specific information is indicated by icons.

Las ilustraciones y las capturas de pantalla que se utilizan en esta publicación son de la serie GX7000. La información específica de un modelo se indica mediante iconos.

---

### Holding the Printer

Cómo sujetar la impresora

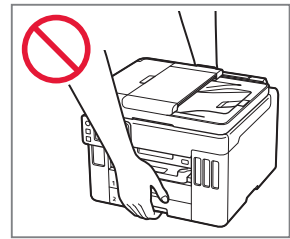
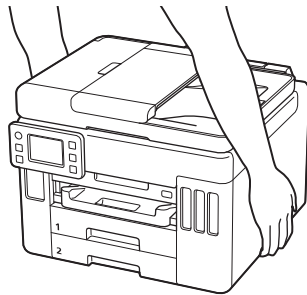

# Setting Up the Printer



**For Setup, visit the URL**

**<https://ij.start.canon>**

or scan the code with your mobile device



● Follow the instructions below if you do not have an internet connection.

## 1. Box Contents

- Ink Bottles
- Power Cord
- **GX7000** Phone Cable
- Safety and Important Information
- Getting Started (this manual)

## 2. Removing Packing Materials



### 1 Remove and dispose of any packing materials and orange tape.

- Using the printer with orange tape or packing material still attached, may cause the printer to malfunction.

### 2 Open the scanning unit / cover, remove and dispose of the orange tape and protective material inside.

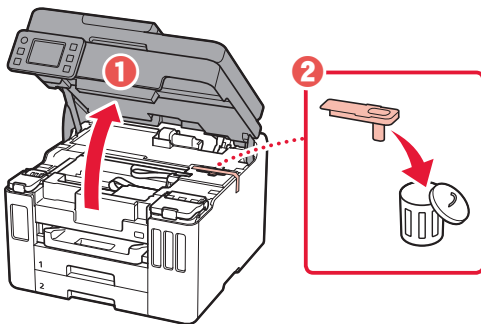

### 3 Close the scanning unit / cover.

- Open the scanning unit / cover fully and then close it.

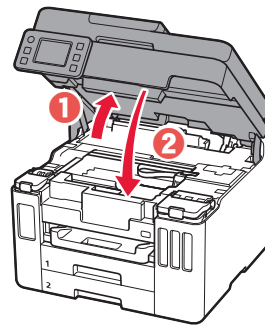

**⚠ Caution**  
Watch your fingers.

## 3. Turning on the Printer



### 1 Connect the power cord.

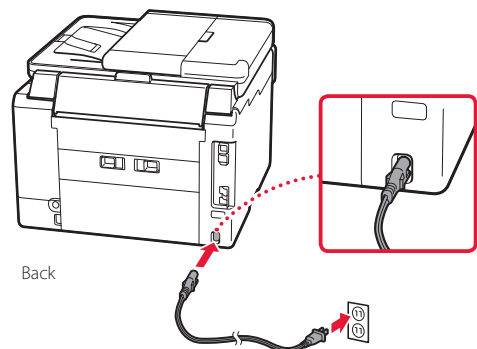

Back

## Setting Up the Printer

- 2 Open the operation panel and press the **ON** button.

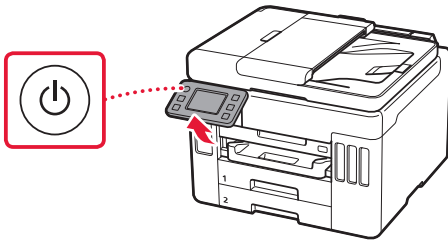

- 3 Scroll and tap to select your language, and then tap **Yes**.

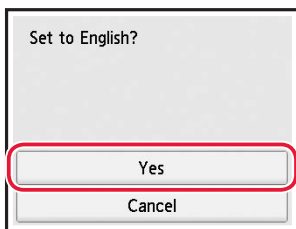
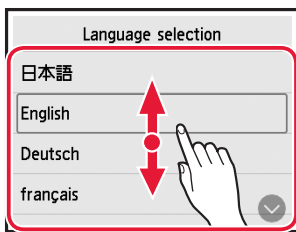

- 4 **GX7000** If the following screen appears, tap your country or region to select.

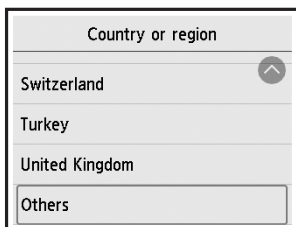

- 5 Set the date, and then tap **OK**.

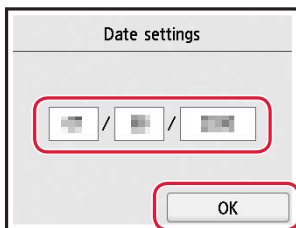

- 6 Set the time, and then tap **OK**.

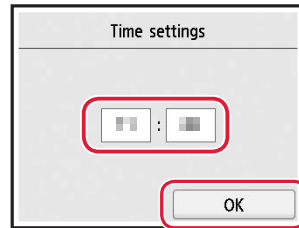

- 7 Tap **OK**.

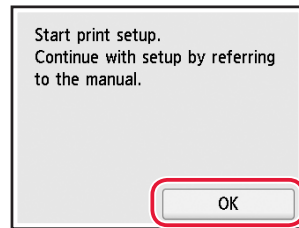

## 4. Pouring Ink



### Important

This product requires careful handling of ink. Ink may splatter when the ink tanks are filled with ink. If ink gets on your clothes or belongings, it may not come off.

- 1 Open the scanning unit / cover.

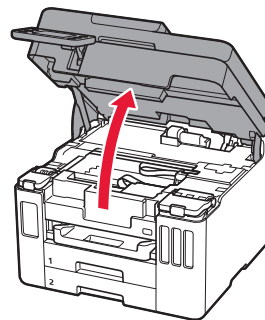

- 2 Open the ink tank cover and tank cap on the left of the printer.

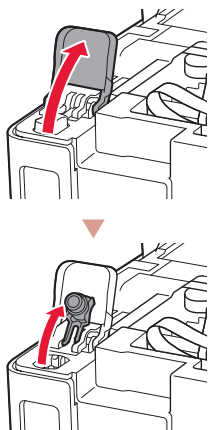

- 3 Hold the ink bottle upright and gently twist the bottle cap to remove.

**Check!**

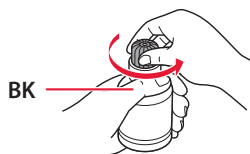

- 4 Align the nozzle of the ink bottle with the inlet.

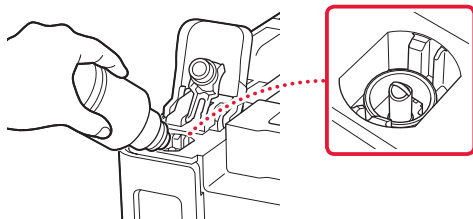

- 5 Slowly stand the ink bottle upside down and push down to pour the ink.
- If the ink does not pour, gently remove the ink bottle and try again.

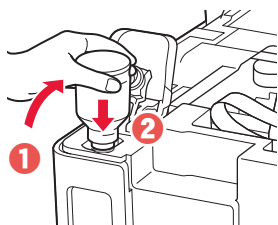

- 6 Gently remove the ink bottle from the inlet.
- Be careful not to spill the ink.

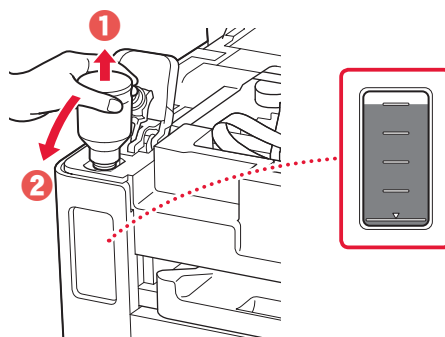

- 7 Replace the tank cap **securely**.

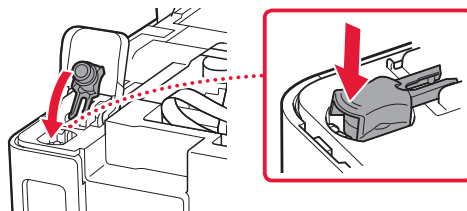

- 8 Close the ink tank cover securely.

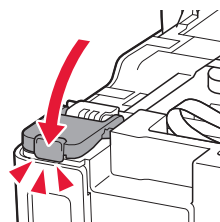

- 9 Repeat steps 2 through 8 to pour all ink into the corresponding ink tanks on the right.

**Check!**

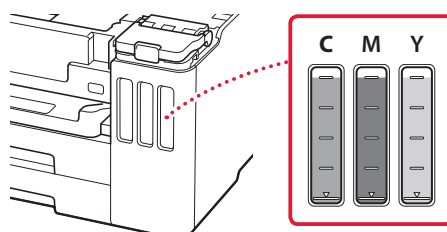

# Setting Up the Printer

- 10 Close the scanning unit / cover.
- Open the scanning unit / cover fully and then close it.

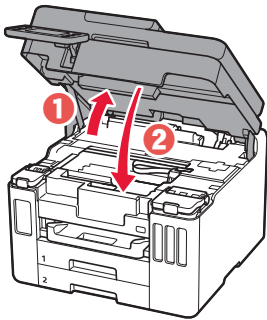

⚠ Caution  
Watch your fingers.

- 3 Slide apart the paper guides.
- Slide the right paper guide to the right edge. Align the front paper guide with the Letter or A4 mark.

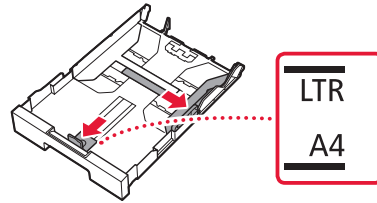

- 4 Load Letter or A4 sized plain paper.
- Place the paper against the front paper guide, and align the right paper guide to the width of the paper.

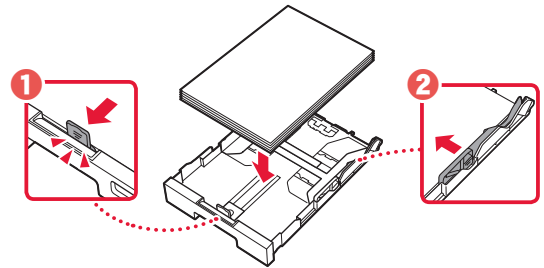

- 5 Replace the cassette.

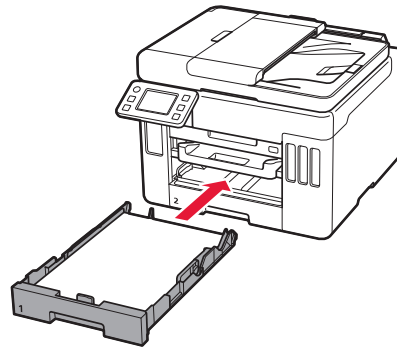

- 6 Pull out the paper output tray.

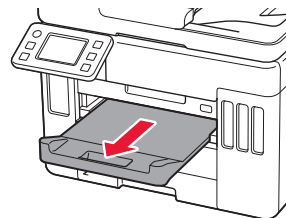

## 5. Loading Paper



- 1 Tap **OK**.

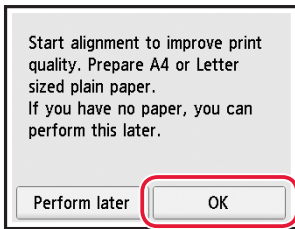

- 2 Remove the cassette from the printer.
- **GX7000** Pull out Cassette 1 (upper) from the printer.

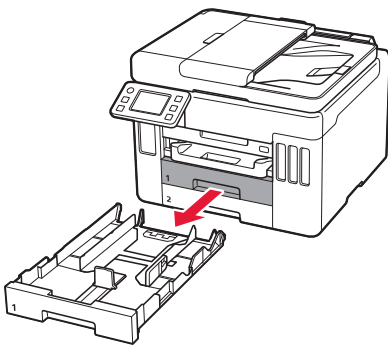

## 7 Tap OK.

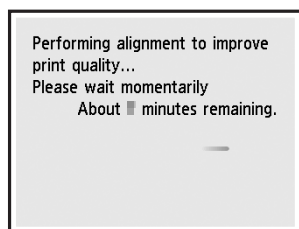
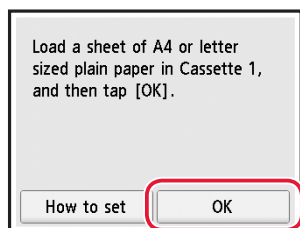

- The alignment process prints out one double sided sheet. Wait without touching the paper until the screen in step 8 appears.

## 8 Tap Next.

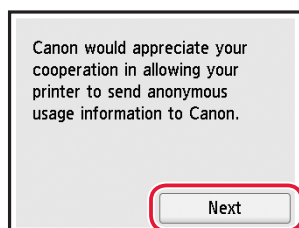

- Follow the on-screen instructions to continue setup. This includes making selections related to sending information. Refer to "Sending Information To Canon" in **Safety and Important Information**.

## 9 Check that the following screen appears.

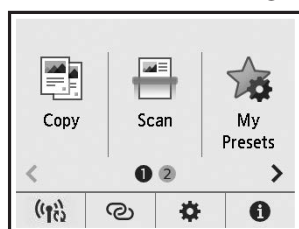

Select the connection method that best matches how you will use the printer.

- To use the printer without connecting to any other devices
  - ➔ Setup is now complete.
    - GX7000** To set up a fax, see **"Using Fax Function" on page 8**.
- To use the printer connecting to a computer or smartphone
  - ➔ Proceed to the next page.

---

If you will use the printer without connecting any other devices, setup is now complete.

---

## Setting Up the Printer

### What device are you connecting?



Computer



Computer and  
smartphone





Smartphone

### 6-a

## Connecting to a Computer

If you are using multiple computers, perform these steps on each computer.



- 1 Access the Canon website from your computer.  
 <https://ij.start.canon>
- 2 Select  **Set Up**.
- 3 Enter your printer's model name and click **Go**.
- 4 Click **Start**.
- 5 Click **(B) Connecting to a Computer/Smartphone**.
  - The following steps are for Windows users.
- 6 Click **Download**.
- 7 Run the downloaded file.
  - Follow the on-screen instructions. This may take some time.
  - To connect to a smartphone as well, see "6-b. Connecting to a Smartphone" on page 7.
  - **GX7000** To set up a fax, see "**Using Fax Function**" on page 8.



## 6-b

## Connecting to a Smartphone

If you are using multiple smartphones, perform these steps on each smartphone.



### 1 Install the "Canon PRINT Inkjet/SELPHY" app on your smartphone.



- Search for "Canon PRINT" in App Store, or Google Play.
- Access the Canon website to download the app.



### 2 Open your smartphone's Wi-Fi settings. Check that the network name (SSID) that starts with "Canon\_ij\_" appears.

(Example of iOS screen)

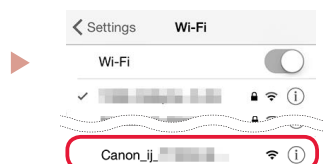

The network name (SSID) that starts with "Canon\_ij\_"

- If "Canon\_ij\_" appears → Proceed to step 3.
- If "Canon\_ij\_" does not appear → Proceed to step 4.

### 3 Tap the network name (SSID) that starts with "Canon\_ij\_".

### 4 Open the installed app, and follow the on-screen instructions in the app to add your printer.

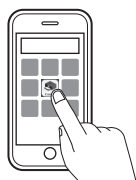

- 
- Once you have added your printer, you can print from your smartphone. To print photos, see "Loading Paper" on page 8.
  - **GX7000** To set up a fax, see "Using Fax Function" on page 8.
-

## Loading Paper

- 1 Open the rear tray cover and extend the paper support.

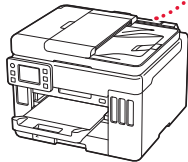
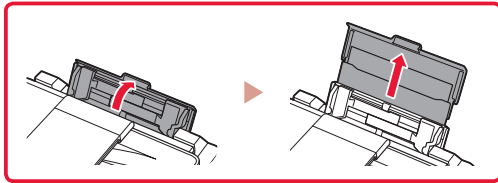

- 2 Slide the right-hand side paper guide to the far right.
- 3 Load several sheets of paper with the print side facing up and slide the side paper guide against the edge of the paper stack.

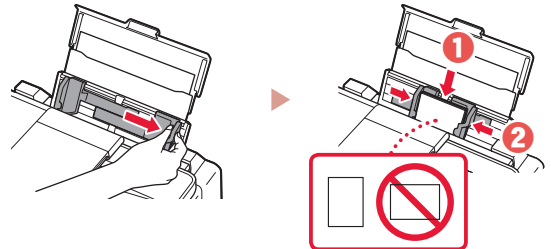

## GX7000 Using Fax Function

The fax function of your printer requires setup. Refer to **FAX Setup Guide**.



- Access the FAX Setup Guide

- 1 Access the Canon website.

 <https://ij.start.canon>

- 2 Click  **See Recommended Functions.**

- 3 Click **Functions/Services.**

- 4 Click  **Setting Up the FAX.**

## Transporting Your Printer

When relocating the printer, check the following. Refer to the **Online Manual** for details.

Check that the position of the ink valve lever is closed.

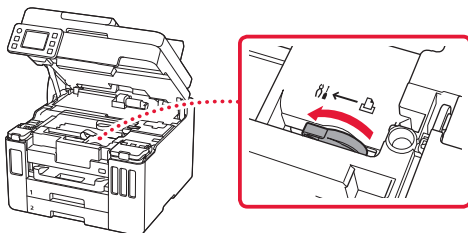

Pack the printer in a plastic bag in case ink leaks.

- Pack the printer in a sturdy box so that it is placed with its bottom facing down, using sufficient protective material to ensure safe transport.
- Do not tilt the printer. Ink may leak.

- Please handle with care and ensure the box remains flat and NOT turned upside down or on its side, as the printer may be damaged and ink in the printer may leak.
- When a shipping agent is handling transport of the printer, have its box marked "THIS SIDE UP" to keep the printer with its bottom facing down. Mark also with "FRAGILE" or "HANDLE WITH CARE".

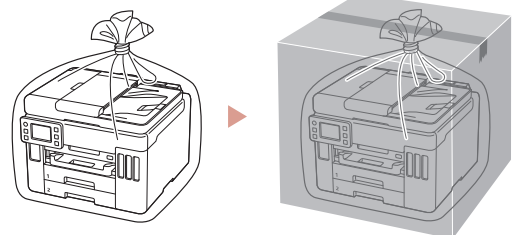

# Instalación de la impresora



Para la configuración, visite la URL

<https://ij.start.canon>

o bien escanee el código con su dispositivo móvil



- Siga las instrucciones que se proporcionan a continuación si no tiene conexión a Internet.

## 1. Contenido de la caja

- Frascos de tinta
- Cable de alimentación
- **GX7000** Cable de teléfono
- Información de seguridad e información importante
- Guía de inicio (este manual)

## 2. Retirar los materiales de protección



- 1 Retire y tire los materiales de protección y la cinta naranja.
  - El uso de la impresora con la cinta naranja o material de protección todavía adherido podría provocar un mal funcionamiento de la impresora.

- 2 Abra la cubierta/unidad de escaneo, retire y tire la cinta naranja y el material de protección que hay dentro.

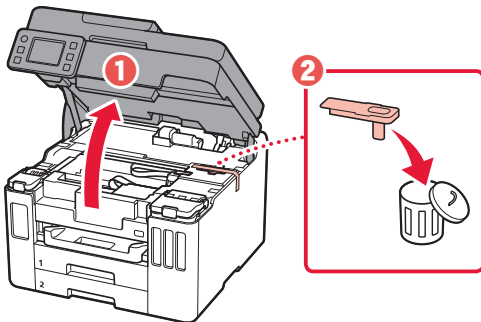

- 3 Cierre la cubierta/unidad de escaneo.

- Abra la cubierta/unidad de escaneo completamente y luego ciérrela.

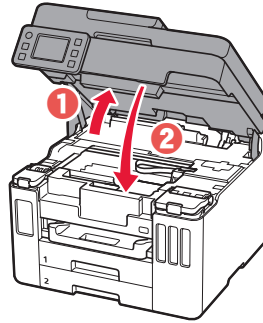

**⚠ Precaución**  
Tenga cuidado con los dedos.

## 3. Encender la impresora



- 1 Conecte el cable de alimentación.

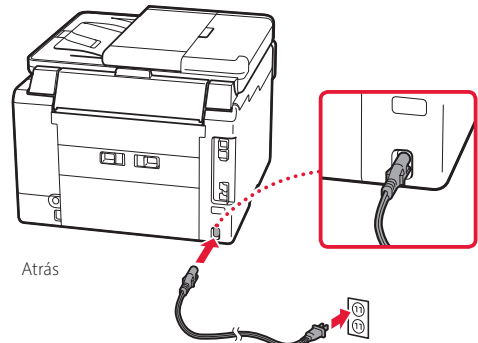

## Instalación de la impresora

- 2 Abra el panel de control y pulse el botón **ACTIVADO (ON)**.

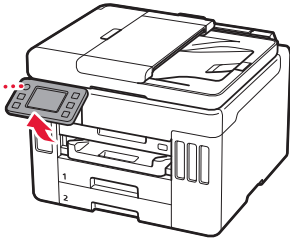

- 3 Desplácese y toque para seleccionar su idioma y luego toque **Sí (Yes)**.

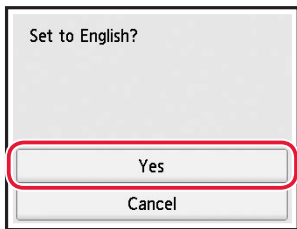
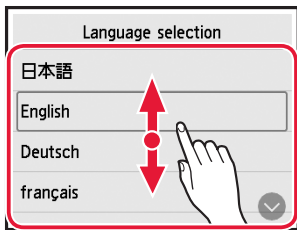

- 4 **GX7000** Si aparece la siguiente pantalla, toque su país o región para seleccionarlo.

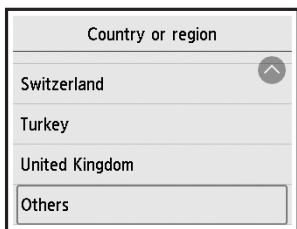

- 5 Establezca la fecha y, a continuación, toque **OK**.

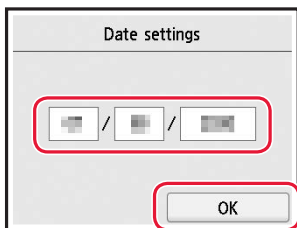

- 6 Establezca la hora y, a continuación, toque **OK**.

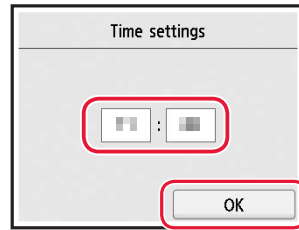

- 7 Toque **OK**.

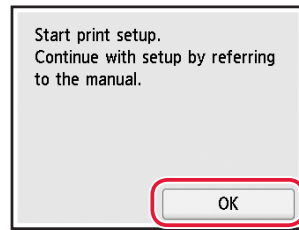

## 4. Verter la tinta



### »»» Importante

Este producto requiere un tratamiento cuidadoso de la tinta, ya que puede salpicar cuando se rellenan de tinta los depósitos de tinta. Es posible que las manchas de tinta no salgan de la ropa u otras pertenencias.

- 1 Abra la cubierta/unidad de escaneo.

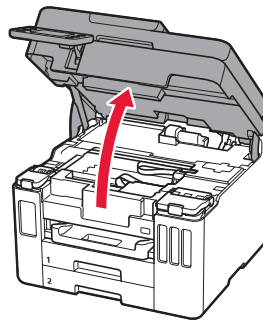

- 2 Abra la cubierta del depósito de tinta y la tapa del depósito a la izquierda de la impresora.

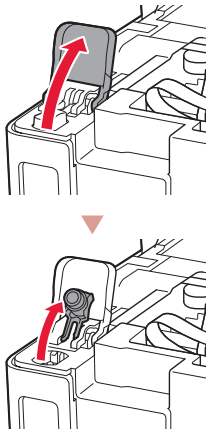

- 3 Sujete el frasco de tinta hacia arriba y gire suavemente la tapa del frasco para retirarla.

¡Comprobar!

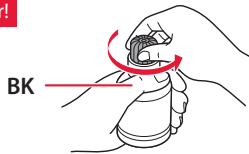

- 4 Alinee la boquilla del frasco de tinta con la entrada.

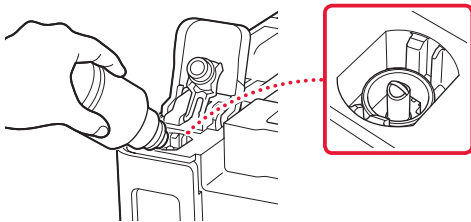

- 5 Coloque lentamente el frasco de tinta boca abajo y empuje hacia abajo para verter la tinta.

- Si la tinta no se vierte, retire suavemente el frasco de tinta e inténtelo de nuevo.

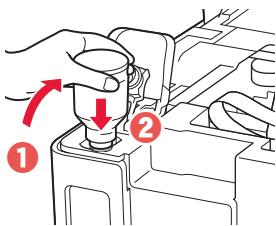

- 6 Retire suavemente el frasco de tinta de la entrada.

- Tenga cuidado de no derramar la tinta.

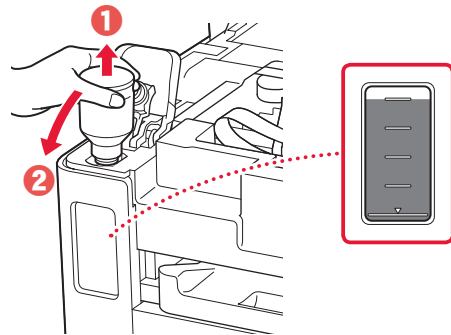

- 7 Vuelva a colocar la tapa del depósito firmemente.

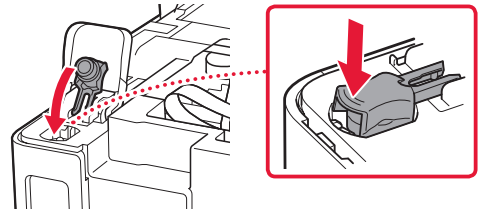

- 8 Cierre la cubierta del depósito de tinta firmemente.

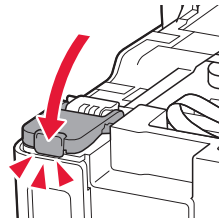

- 9 Repita los pasos del 2 al 8 para verter toda la tinta en los depósitos de tinta correspondientes de la derecha.

¡Comprobar!

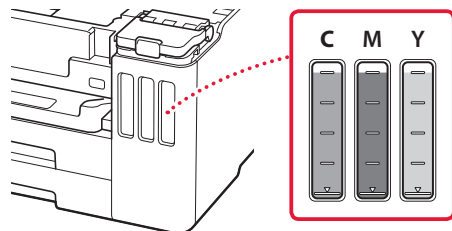

## Instalación de la impresora

### 10 Cierre la cubierta/unidad de escaneado.

- Abra la cubierta/unidad de escaneado completamente y luego ciérrela.

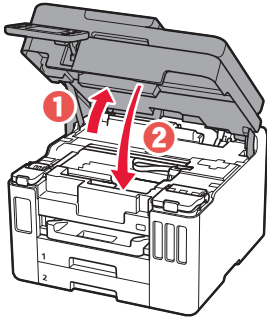

**⚠ Precaución**  
Tenga cuidado con los dedos.

## 5. Carga de papel



### 1 Toque OK.

Start alignment to improve print quality. Prepare A4 or Letter sized plain paper. If you have no paper, you can perform this later.

Perform later

OK

### 2 Retire el cassette de la impresora.

- **GX7000** Retire el Cassette 1 (superior) de la impresora.

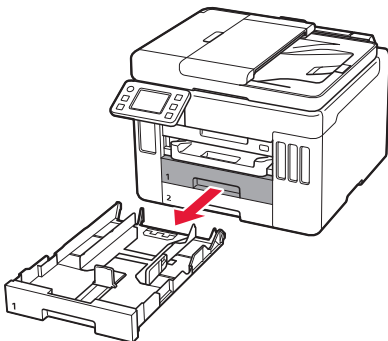

### 3 Separe las guías del papel deslizándolas.

- Deslice la guía del papel derecha hacia el borde derecho. Alinee la guía del papel frontal con la marca Carta o A4.

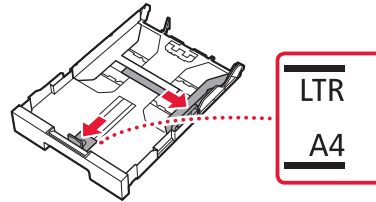

### 4 Cargue papel Carta o papel normal de tamaño A4.

- Coloque el papel delante de la guía del papel frontal y alinee la guía del papel derecha con el ancho del papel.

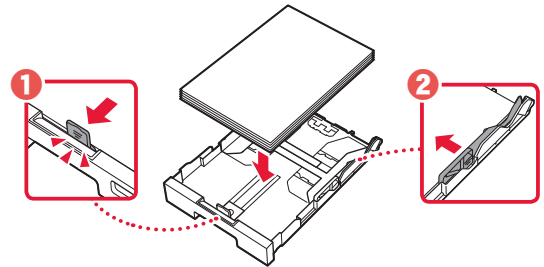

### 5 Reemplace el cassette.

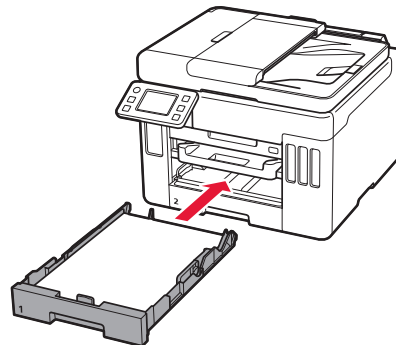

### 6 Extraiga la bandeja de salida del papel.

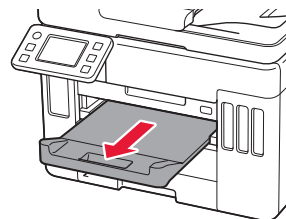

## 7 Toque **OK**.

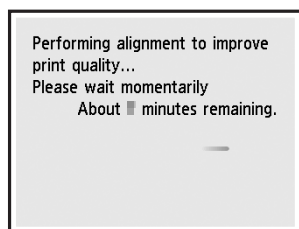
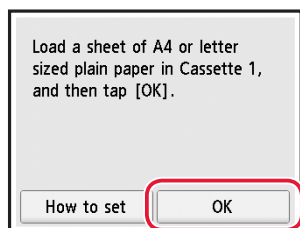

- El proceso de alineación imprime una hoja de doble cara. Espere sin tocar el papel hasta que aparezca la pantalla del paso 8.

## 8 Toque **Siguiente (Next)**.

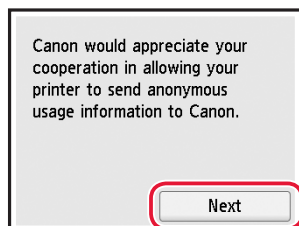

- Siga las instrucciones que aparecen en pantalla para continuar con la instalación. Esto incluye la realización de selecciones relacionadas con el envío de información.

Consulte "Enviando información a Canon" en **Información de seguridad e información importante**.

## 9 Compruebe que aparezca la siguiente pantalla.

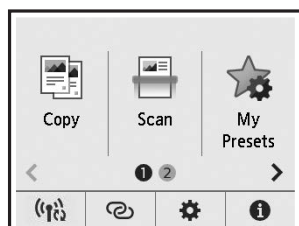

Seleccione el método de conexión que mejor se adapte al uso de la impresora.

- Para usar la impresora sin conectar con ningún otro dispositivo
  - ➔ Ha finalizado la configuración.
    - **GX7000** Para configurar un fax, consulte "**Usar la función de fax**" en la página 8.
- Para usar la impresora conectándola a un ordenador o un teléfono inteligente
  - ➔ Continúe a la página siguiente.

Si va a utilizar la impresora sin conectar con ningún otro dispositivo, la configuración ya se ha completado.

### ¿Qué dispositivo va a conectar?



Ordenador



Ordenador y  
teléfono inteligente





Teléfono inteligente

## 6-a

### Conectar al ordenador

Si utiliza varios ordenadores, realice estos pasos en cada ordenador.



- 1 Acceda al sitio web de Canon desde el ordenador.  
 <https://ij.start.canon>
- 2 Seleccione  **Configurar**.
- 3 Escriba el nombre del modelo de su impresora y haga clic en **Ir**.
- 4 Haga clic en **Iniciar**.
- 5 Haga clic en **(B) Conexión con un ordenador/teléfono inteligente**.
  - Los siguientes pasos son para usuarios de Windows.
- 6 Haga clic en **Descargar**.
- 7 Ejecute el archivo descargado.
  - Siga las instrucciones que aparezcan en pantalla. Esto puede llevar algún tiempo.
  - Para conectar con un teléfono inteligente también, consulte "6-b. Conexión con un teléfono inteligente" en la página 7.
  - **GX7000** Para configurar un fax, consulte "**Usar la función de fax**" en la página 8.



## 6-b

### Conexión con un teléfono inteligente

Si utiliza varios teléfonos inteligentes, realice estos pasos en cada teléfono inteligente.



#### 1 Instale la aplicación "Canon PRINT Inkjet/SELPHY" en su teléfono inteligente.



- Busque "Canon PRINT" en App Store o Google Play.
- Acceda al sitio web Canon para descargar la aplicación.



#### 2 Abra la configuración de Wi-Fi de su teléfono inteligente. Compruebe que aparezca el nombre de red (SSID) que empieza con "Canon\_ij\_".

(Ejemplo de la pantalla de iOS)

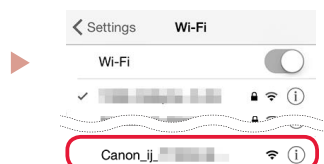

El nombre de red (SSID) que empieza con "Canon\_ij\_"

- Si se muestra "Canon\_ij\_" → continúe en el paso **3**.
- Si no se muestra "Canon\_ij\_" → continúe en el paso **4**.

#### 3 Toque el nombre de red (SSID) que empieza con "Canon\_ij\_".

#### 4 Abra la aplicación instalada y luego siga las instrucciones en la aplicación para agregar su impresora.

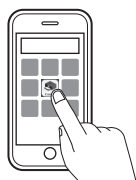

- Cuando haya agregado la impresora, podrá imprimir desde su teléfono inteligente. Para imprimir fotos, consulte "Carga de papel" en la página 8.
- **GX7000** Para configurar un fax, consulte "**Usar la función de fax**" en la página 8.

## Carga de papel

- 1 Abra la cubierta de la bandeja posterior y extienda el soporte del papel.

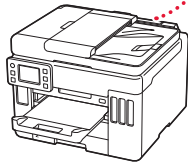
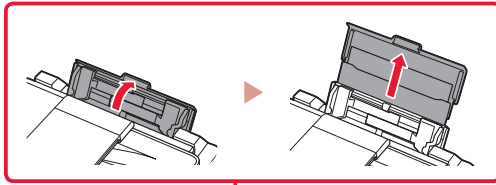

- 2 Deslice la guía del papel del lado derecho totalmente hacia la derecha.
- 3 Cargue varias hojas de papel con la cara de impresión hacia arriba y deslice la guía del papel lateral contra el borde de las hojas de papel.

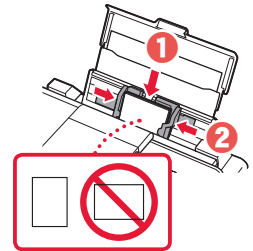
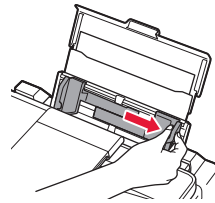

## GX7000 Usar la función de fax

La función de fax de su impresora necesita configurarse. Consulte **Guía de configuración del FAX**.



- Acceda a la Guía de configuración del FAX

- 1 Acceda al sitio web de Canon.

 <https://ij.start.canon>

- 2 Haga clic en  **Consulte las funciones recomendadas.**

- 3 Haga clic en **Funciones/Servicios.**

- 4 Haga clic en  **Configuración del FAX.**

## Transporte de la impresora

Cuando vaya a transportar la impresora, compruebe lo siguiente. Consulte el **Manual en línea** para obtener más información.

Compruebe que la palanca de válvula de tinta esté en la posición cerrada.

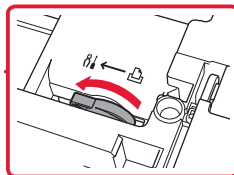
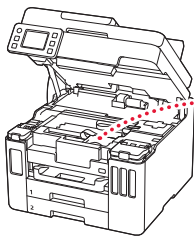

Embale la impresora en una bolsa de plástico por si hay derrames de tinta.

- Embale la impresora en una caja resistente y de modo que no quede boca abajo. Utilice suficiente material de protección para garantizar un transporte seguro.
- No incline la impresora. De lo contrario, es posible que la tinta se derrame.

- Manipule con cuidado y asegúrese de que la caja permanece en una superficie plana y que NO se coloca boca abajo o de lado, ya que la impresora podría dañarse y la tinta de la impresora, derramarse.
- Cuando se ocupe del transporte de la impresora una empresa de mensajería, marque la caja con "ESTE LADO ARRIBA" para mantener la impresora con la parte inferior abajo. Márquela también con "FRÁGIL" o "MANEJAR CON CUIDADO".

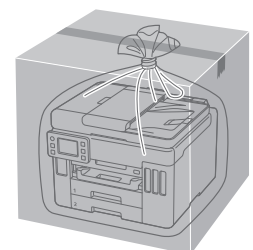
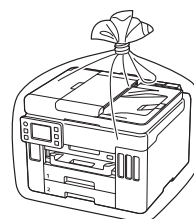

## How-To Video Library Videoteca sobre procedimientos

[www.usa.canon.com/howto/printer](http://www.usa.canon.com/howto/printer)

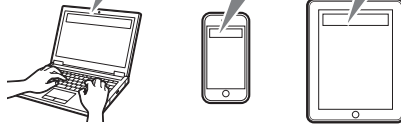

### Trademarks

- Windows is a trademark or registered trademark of Microsoft Corporation in the U.S. and/or other countries.
- App Store is a trademark of Apple Inc., registered in the U.S. and other countries.
- Google Play is a registered trademark of Google LLC..

### Marcas comerciales

- Windows es una marca comercial o marca comercial registrada de Microsoft Corporation, registrada en EE.UU. y/o en otros países.
- App Store es una marca comercial de Apple Inc., registradas en EE.UU. y en otros países.
- Google Play es una marca comercial registrada de Google LLC.



Access Online Manual

Acceso al Manual en línea

From your browser

Desde su navegador



<https://ij.start.canon>

