

Canon

TS3500 series

Getting Started

Démarrage

Inbetriebnahme

Aan de Slag-gids

Guida Rapida

Para Começar

Guía de inicio

ΞΕΚΙΝΩΝΤΑΣ

Uppstartsguide

Komme i gang

Før du begynder

Aloitusopas

Read **Safety and Important Information** (addendum) first.

Commencez par lire **Sécurité et informations importantes** (addendum).

Lesen Sie **Sicherheitsinformationen und wichtige Hinweise** (Anhang) zuerst.

Lees eerst **Veiligheidsinformatie en belangrijke informatie** (addendum).

Leggere innanzitutto **Informazioni importanti e sulla sicurezza** (addendum).

Leia **Informações Importantes e Sobre Segurança** (adendo) primeiro.

Lea primero **Información de seguridad e información importante** (apéndice).

Διαβάστε πρώτα τις **Πληροφορίες για την ασφάλεια και σημαντικές πληροφορίες** (συμπλήρωμα).

Läs **Information om säkerhet och annan viktig information** (bilaga) först.

Les **Sikkerhetsinformasjon og viktig informasjon** (tillegg) først.

Læs **Sikkerhedsoplysninger og vigtige oplysninger** (tillæg) først.

Lue **Turvallisuus ja tärkeitä tietoja** (lisähuomautus) ensin.



Q T 6 4 0 6 9 V 0 1



Installing the Printer.....	page 1
Installation de l'imprimante.....	page 1
Installation des Druckers.....	Seite 1
De printer installeren.....	pagina 1
Installazione della stampante.....	pagina 1
Instalando a impressora.....	página 1
Instalación de la impresora.....	página 1
Εγκατάσταση του εκτυπωτή.....	σελίδα 1
Installera skrivaren.....	sida 1
Installere skriveren.....	side 1
Installation af printeren.....	side 1
Tulostimen asennus.....	sivu 1



Connecting to a Computer, Smartphone or Tablet.....	page 4
Connexion à un ordinateur, un smartphone ou une tablette.....	page 4
Herstellen einer Verbindung mit einem Computer, Smartphone oder Tablet.....	Seite 4
Verbinden met een computer, smartphone of tablet.....	pagina 4
Connessione a un computer, uno smartphone o un tablet.....	pagina 4
Conectando a um computador, smartphone ou tablet.....	página 4
Conexión con un ordenador, teléfono inteligente o tableta.....	página 4
Σύνδεση σε υπολογιστή, smartphone ή tablet.....	σελίδα 4
Ansluta till en dator, smarttelefon eller surfplatta.....	sida 4
Koble til en datamaskin, en smarttelefon eller et nettbrett.....	side 4
Tilslutning til en computer, smartphone eller tablet.....	side 4
Yhdistäminen tietokoneeseen, älypuhelimeen tai tablet-tietokoneeseen.....	sivu 4

Holding the Printer
Manipulation de l'imprimante
Halten des Druckers
De printer vasthouden
Come tenere la stampante
Segurando a impressora
Cómo sujetar la impresora
Πώς να κρατήσετε τον εκτυπωτή
Bära skrivaren
Holde skriveren
Holde printeren
Tulostimen pitäminen

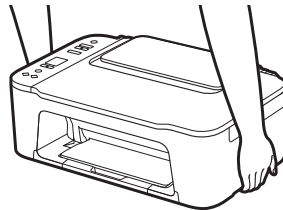

Setting Up the Printer



For Setup, visit the URL

<https://ij.start.canon>

or scan the code with your mobile device



● Follow the instructions below if you do not have an internet connection.

1. Box Contents

● FINE cartridges

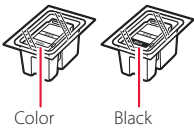

Color

Black

● Power Cord

● Safety and Important Information

● Getting Started (this manual)

2. Removing Packing Materials



1 Remove the orange tape on the right and open the cover.

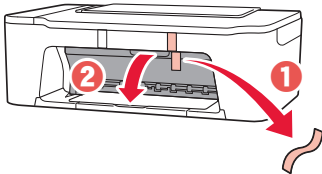

2 Remove the orange tape on the left.

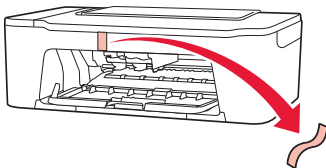

3 Close the cover.

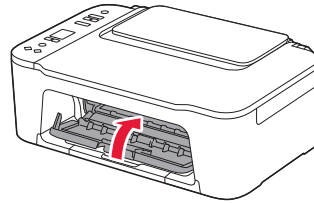

3. Turning on the Printer



1 Connect the power cord.

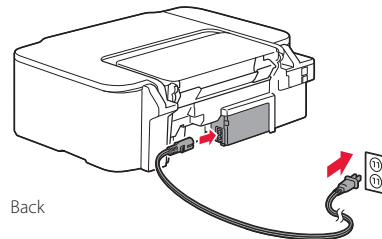

2 Press the **ON** button.

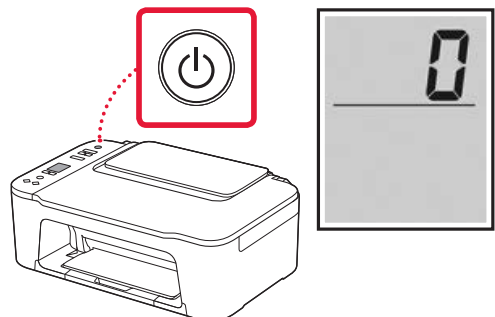

Important

If another screen appears, see "If any of the following screens appear" on page 3 and follow the instructions.

Setting Up the Printer

4. Installing the FINE Cartridges



1 Open the cover.

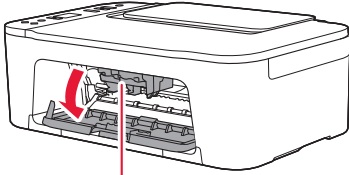

▲ Caution

Do not touch the FINE cartridge holder until it stops moving.

2 Lower the ink cartridge lock lever on the left-hand side.

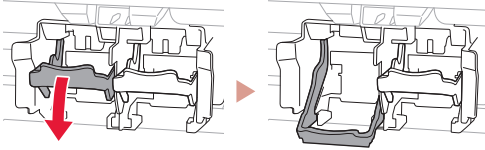

3 Remove the Color FINE cartridge from the package and remove the protective tape.

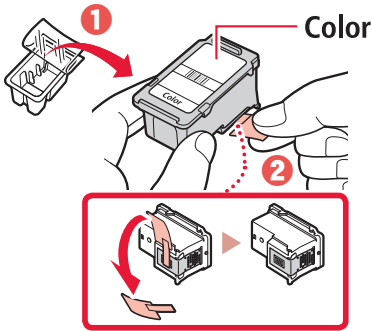

▶▶▶ Important

- Do not touch the ink on the protective tape. It could stain your hands or surrounding objects.
- Do not touch the areas shown in the figure. Otherwise, the printer may not print correctly.

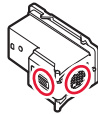

4 Insert the Color FINE cartridge in the FINE cartridge holder.

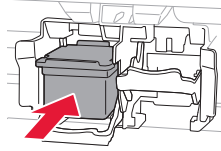

▶▶▶ Important

Do not bump the FINE cartridge. Doing so may cause a malfunction.



5 Raise the ink cartridge lock lever.

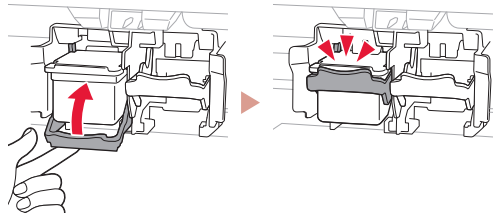

6 Repeat steps 2 to 5 and install the Black FINE cartridge on the right-hand side.

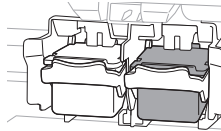

7 Close the cover.

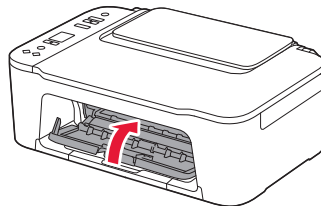

8 Check that the following screen appears.



»»» Important

If E > 0 > 4 appears on the screen, see "If any of the following screens appear" on page 3 and follow the instructions.

Select the connection method that best matches how you will use the printer.

- To use the printer without connecting to any other devices
 - ➔ Setup is now complete.
- To use the printer connecting to a computer or smartphone
 - ➔ Proceed to the next page.



If any of the following screens appear

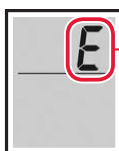

Numbers or letters

Check the screen, and then follow the corresponding instructions below.



Install the FINE cartridges.

➔ "4. Installing the FINE Cartridges" on page 2



Protective material remaining.

➔ "2. Removing Packing Materials" on page 1



FINE cartridges are not installed correctly.

➔ "4. Installing the FINE Cartridges" on page 2

For all other cases, refer to the **Online Manual**.

Setting Up the Printer

What device are you connecting?



Computer



Computer and
smartphone





Smartphone

5-a

Connecting to a Computer

If you are using multiple computers, perform these steps on each computer.



- 1 Access the Canon website from your computer.
 <https://ij.start.canon>
- 2 Select  **Set Up**.
- 3 Enter your printer's model name and click **Go**.
- 4 Click **Start**.
- 5 Click **(B) Connecting to a Computer/Smartphone**.
 - The following steps are for Windows users.
- 6 Click **Download**.
- 7 Run the downloaded file.
 - Follow the on-screen instructions.
 - These operations may take some time.
 - To connect to a smartphone as well, see "5-b. Connecting to a Smartphone" on page 5.

5-b

Connecting to a Smartphone

If you are using multiple smartphones, perform these steps on each smartphone.



1 Install the "Canon PRINT Inkjet/SELPHY" app on your smartphone.



- Search for "Canon PRINT" in App Store, or Google Play.
- Access the Canon website to download the app.



2 Open the installed app, and follow the on-screen instructions in the app to add your printer.



Once you have added your printer, you can print from your smartphone.
To print photos, see "Loading Paper" on page 6.

Loading Paper

- 1 Open the paper support.

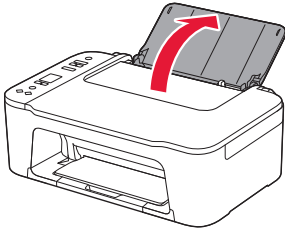

- 2 Slide the paper guide to the left.

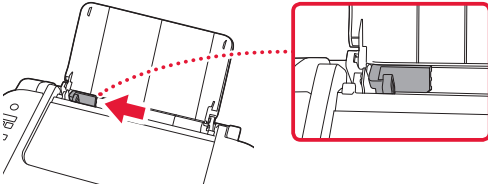

- 3 Load several sheets of paper against the right edge with the print side facing up and align the paper guide to the width of the paper.

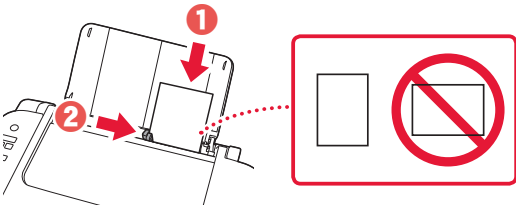

- 4 Press the **Paper Select** button, select a paper size, and then press the **OK** button.

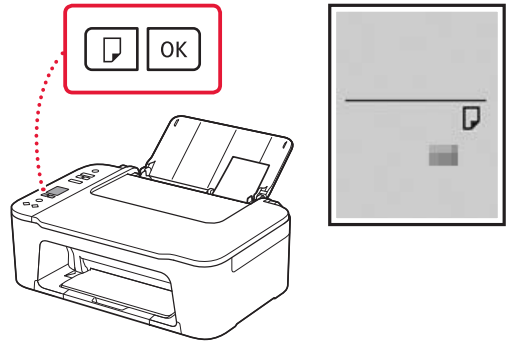

- 5 Extend the paper output tray, and open the output tray extension.



- Look at it from the side to confirm it looks like the diagram.

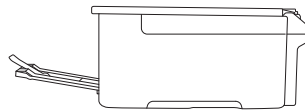

If Print Results Are Unsatisfactory

Perform Print Head Alignment if straight lines are crooked or colors are inconsistent, or print results are otherwise not what you expected.

For details, click **Maintenance** on the **Online Manual** and refer to **If Printing Is Faint or Uneven > Aligning the Print Head**. Refer to the back cover for how to access the **Online Manual**.

■ Lines Are Misaligned



■ Uneven or Streaked Colors



Configuration de l'imprimante



**Pour la configuration,
rendez-vous sur l'URL
<https://ij.start.canon>**



ou numérisez le code avec votre appareil mobile

● Suivez les instructions ci-dessous si vous ne disposez d'aucune connexion à Internet.

1. Contenu de la boîte

- Cartouches FINE

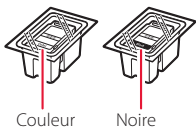

- Cordon d'alimentation
- Sécurité et informations importantes
- Démarrage (ce manuel)

2. Retrait du matériel d'emballage



- 1 Retirez la bande orange de droite et ouvrez le capot.

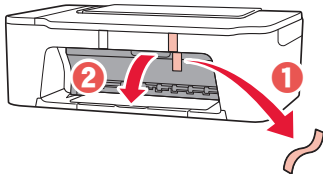

- 2 Retirez la bande orange de gauche.

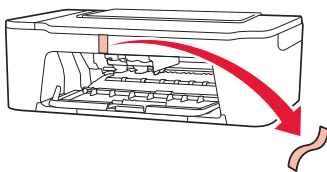

- 3 Fermez le capot.

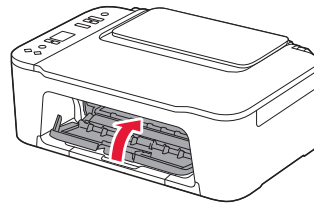

3. Mise sous tension de l'imprimante



- 1 Branchez le cordon d'alimentation.

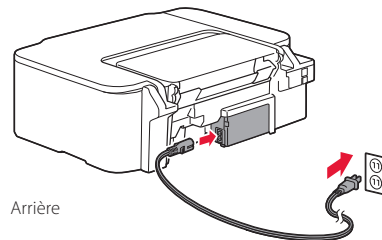

- 2 Appuyez sur le bouton **MARCHE (ON)**.

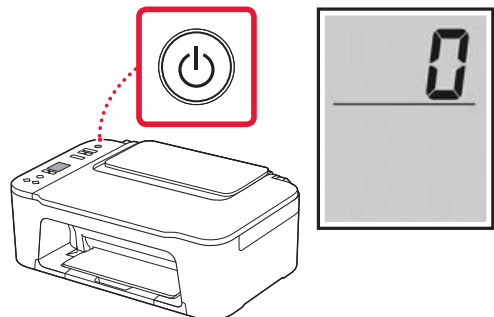

» Important

Si un autre écran s'affiche, reportez-vous à la section « Si un des écrans suivants s'affiche » à la page 3 et suivez les instructions.

Configuration de l'imprimante

4. Installation des cartouches FINE



1 Ouvrez le capot.

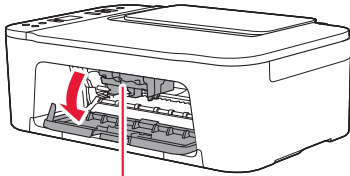

⚠ Attention

Ne touchez pas le porte-cartouche FINE avant son arrêt.

2 Abaissez le levier de verrouillage de cartouche d'encre sur la gauche.

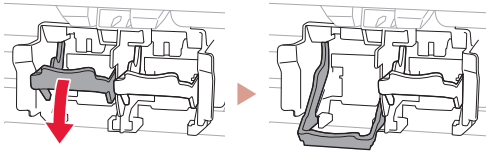

3 Retirez la cartouche FINE couleur du paquet et retirez le ruban protecteur.

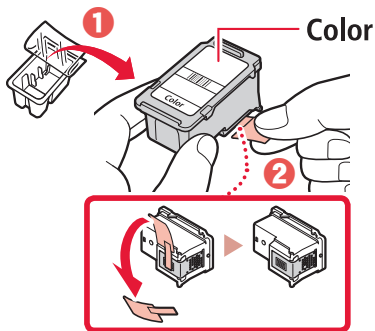

»»» Important

- Ne touchez pas l'encre se trouvant sur le ruban protecteur. Cela pourrait salir vos mains ou les objets environnants.
- Ne touchez pas les zones présentées dans la figure. Sinon, l'imprimante pourrait ne pas imprimer correctement.

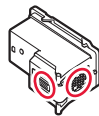

4 Insérez la cartouche FINE couleur dans le porte-cartouche FINE.

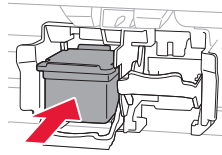

»»» Important

Ne cognez pas la cartouche FINE. Cela risquerait d'entraîner un dysfonctionnement.



5 Relevez le levier de verrouillage de cartouche d'encre.

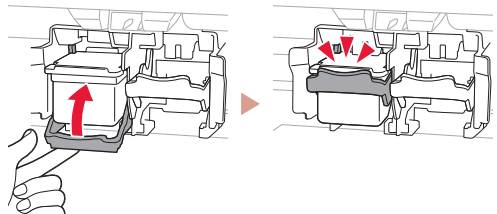

6 Répétez les étapes 2 à 5 et installez la cartouche FINE noire sur la droite.

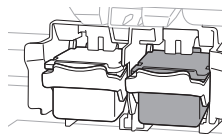

7 Fermez le capot.

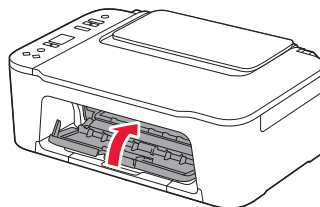

8 Assurez-vous que l'écran suivant s'affiche.



»»» Important

Si E > 0 > 4 apparaît à l'écran, reportez-vous à la section « Si un des écrans suivants s'affiche » à la page 3 et suivez les instructions.

Sélectionnez la méthode de connexion correspondant le mieux à la manière dont vous utiliserez l'imprimante.

- Pour utiliser l'imprimante sans connexion à aucun autre périphérique
➔ La configuration est terminée.
- Pour utiliser l'imprimante en la connectant à un ordinateur ou à un smartphone
➔ Passez à la page suivante.



Si un des écrans suivants s'affiche



Chiffres ou lettres

Vérifiez l'écran et suivez les instructions correspondantes ci-dessous.



Installez les cartouches FINE.

➔ « 4. Installation des cartouches FINE » à la page 2



Matériau protecteur restant.

➔ « 2. Retrait du matériel d'emballage » à la page 1



Les cartouches FINE ne sont pas installées correctement.

➔ « 4. Installation des cartouches FINE » à la page 2

Pour tous les autres cas, reportez-vous au **Manuel en ligne**.

Configuration de l'imprimante

Quel périphérique connectez-vous ?



Ordinateur



Ordinateur et
smartphone



Smartphone

5-a

Connexion à un ordinateur

Si vous utilisez plusieurs ordinateurs, effectuez ces étapes sur chaque ordinateur.



- 1 Accès au site Web Canon à partir de votre ordinateur.
 <https://ij.start.canon>
- 2 Sélectionnez  **Configuration**.
- 3 Entrez le nom de modèle de votre imprimante et cliquez sur **Accéder**.
- 4 Cliquez sur **Démarrer**.
- 5 Cliquez sur **(B) Connexion à un ordinateur/smartphone**.
 - Les étapes suivantes concernent les utilisateurs Windows.
- 6 Cliquez sur **Télécharger**.
- 7 Exécutez le fichier téléchargé.
 - Suivez les instructions à l'écran.
 - Ces opérations peuvent prendre du temps.
 - Pour vous connecter aussi à un smartphone, voir « 5-b. Connexion à un smartphone » à la page 5.

5-b

Connexion à un smartphone

Si vous utilisez plusieurs smartphones, effectuez ces étapes sur chaque smartphone.

**1** Installez l'application « Canon PRINT Inkjet/SELPHY » sur votre smartphone.

- Recherchez « Canon PRINT » dans App Store ou Google Play.
- Accédez au site Web Canon pour télécharger l'application.

**2** Ouvrez l'application installée, puis suivez les instructions affichées à l'écran par l'application pour ajouter votre imprimante.

Une fois que vous avez ajouté votre imprimante, vous pouvez imprimer depuis votre smartphone. Pour imprimer des photos, voir « Chargement du papier » à la page 6.

Chargement du papier

- 1 Ouvrez le support papier.

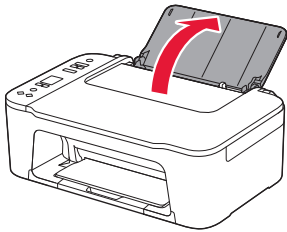

- 2 Faites glisser le guide papier vers la gauche.

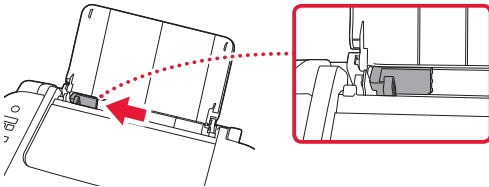

- 3 Chargez plusieurs feuilles de papier contre le bord droit et face à imprimer vers le haut, puis alignez le guide papier en fonction de la largeur du papier.

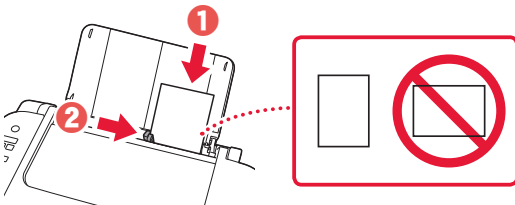

- 4 Appuyez sur le bouton **Sélectionner le papier (Paper Select)**, sélectionnez un format de papier, puis appuyez sur le bouton **OK**.

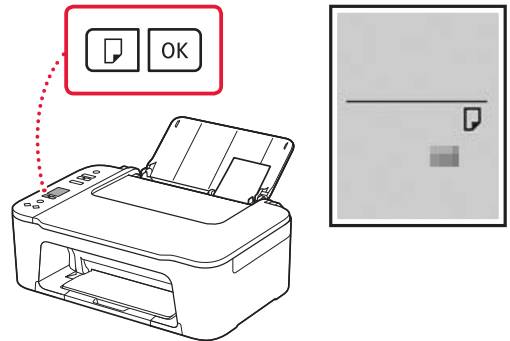

- 5 Déployez le bac de sortie papier et ouvrez l'extension du bac de sortie papier.



- Observez-la depuis le côté pour confirmer qu'elle se présente comme dans le diagramme.

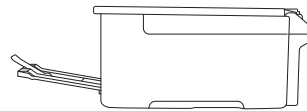

Si les résultats de l'impression ne sont pas satisfaisants

Si les lignes droites sont de travers ou les couleurs incohérentes, ou si les résultats de l'impression ne sont pas conformes à vos attentes, procédez à un **Alignement tête d'impression**.

Pour plus de détails, cliquez sur **Entretien** dans le **Manuel en ligne** et reportez-vous à **Si l'impression est pâle ou irrégulière > Alignement de la tête d'impression**.

Reportez-vous à la couverture arrière pour savoir comment accéder au **Manuel en ligne**.

- Des lignes sont mal alignées



- Des couleurs sont inégales ou striées



Einrichten des Druckers



Um Informationen zur Einrichtung zu erhalten, rufen Sie die URL

<https://ij.start.canon>

auf oder scannen Sie den Code mit Ihrem Mobilgerät

- Befolgen Sie die folgenden Anweisungen, wenn Sie keine Internetverbindung haben.



1. Inhalt der Box

- FINE-Patronen

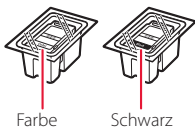

- Netzkabel
- Sicherheitsinformationen und wichtige Hinweise
- Inbetriebnahme (dieses Handbuch)

2. Entfernen des Verpackungsmaterials



- 1 Entfernen Sie das orangefarbene Klebeband auf der rechten Seite und öffnen Sie die Abdeckung.

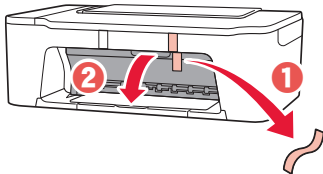

- 2 Entfernen Sie das orangefarbene Klebeband auf der linken Seite.

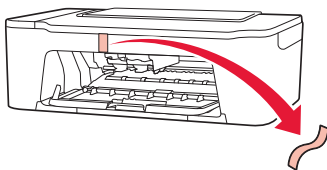

- 3 Schließen Sie die Abdeckung.

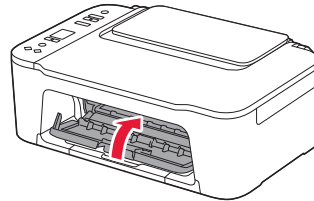

3. Einschalten des Druckers



- 1 Schließen Sie das Netzkabel an.

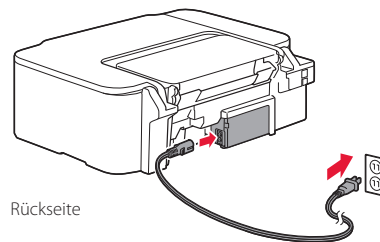

- 2 Drücken Sie die Taste **EIN (ON)**.

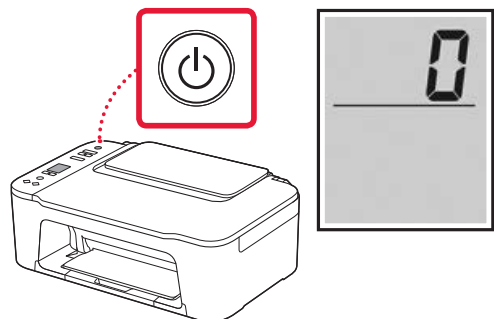

Wichtig

Wird ein anderer Bildschirm angezeigt, befolgen Sie die Anweisungen in „Wenn einer der folgenden Bildschirme angezeigt wird“ auf Seite 3.

Einrichten des Druckers

4. Einsetzen der FINE-Patronen



1 Öffnen Sie die Abdeckung.

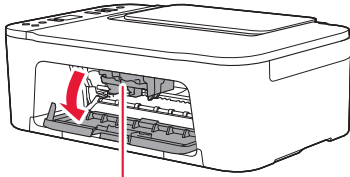

⚠ Vorsicht

Berühren Sie die FINE-Patronen-Halterung nicht, solange sie sich bewegt.

2 Drücken Sie den Tintenpatronen-Sperrhebel auf der linken Seite nach unten.

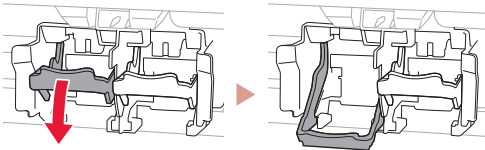

3 Nehmen Sie die farbige FINE-Patrone aus der Verpackung und entfernen Sie das Schutzband.

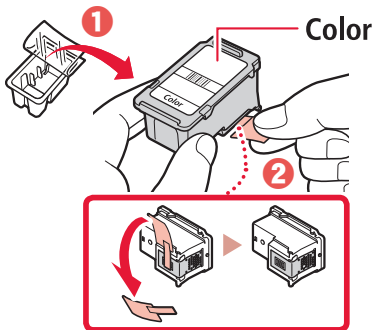

Wichtig

- Berühren Sie nicht die Tinte auf dem Schutzband. Ihre Hände oder Objekte in der Nähe könnten dadurch verschmutzt werden.
- Berühren Sie nicht die in der Abbildung gezeigten Bereiche. Andernfalls druckt der Drucker möglicherweise nicht richtig.

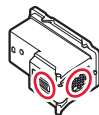

4 Setzen Sie die farbige FINE-Patrone in die FINE-Patronen-Halterung ein.

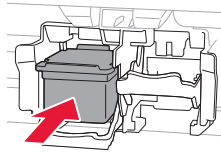

Wichtig

Stoßen Sie mit der FINE-Patrone nirgends an. Dies könnte zu einer Fehlfunktion führen.



5 Drücken Sie den Tintenpatronen-Sperrhebel nach oben.

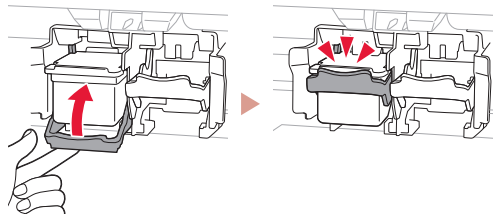

6 Wiederholen Sie die Schritte 2 bis 5 und setzen Sie die schwarze FINE-Patrone auf der rechten Seite ein.

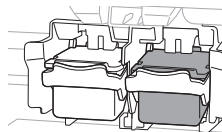

7 Schließen Sie die Abdeckung.

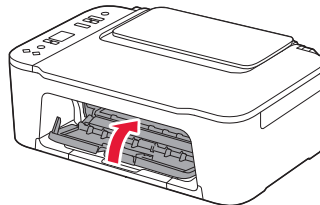

8 Überprüfen Sie, ob der folgende Bildschirm angezeigt wird.



»»» Wichtig

Wird E > 0 > 4 auf dem Bildschirm angezeigt, befolgen Sie die Anweisungen in „Wenn einer der folgenden Bildschirme angezeigt wird“ auf Seite 3.

Wählen Sie die Verbindungsmethode aus, die der späteren Verwendung des Druckers am besten entspricht.

- Verwenden des Druckers ohne Anschluss weiterer Geräte
➔ Die Einrichtung ist jetzt abgeschlossen.
- Verwenden des Druckers, indem eine Verbindung mit einem Computer oder Smartphone hergestellt wird
➔ Fahren Sie auf der nächsten Seite fort.

? Wenn einer der folgenden Bildschirme angezeigt wird

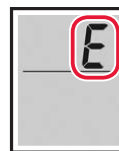

Ziffern oder Buchstaben

Überprüfen Sie den Bildschirm und führen Sie die entsprechenden unten beschriebenen Schritte aus.



Setzen Sie die FINE-Patronen ein.

➔ „4. Einsetzen der FINE-Patronen“ auf Seite 2



Es ist noch Schutzmaterial vorhanden.

➔ „2. Entfernen des Verpackungsmaterials“ auf Seite 1



FINE-Patronen sind nicht richtig installiert.

➔ „4. Einsetzen der FINE-Patronen“ auf Seite 2

Informieren Sie sich in allen anderen Fällen im **Online-Handbuch**.

Mit welchem Gerät stellen Sie eine Verbindung her?



Computer



Computer und
Smartphone





Smartphone

5-a

Herstellen einer Verbindung mit einem Computer

Wenn Sie mehrere Computer verwenden, führen Sie diese Schritte auf jedem Computer aus.



- 1 Greifen Sie von Ihrem Computer aus auf die Canon-Website zu.
 <https://ij.start.canon>
- 2 Wählen Sie  **Einrichten** aus.
- 3 Geben Sie den Modellnamen Ihres Druckers ein und klicken Sie auf **Los**.
- 4 Klicken Sie auf **Start**.
- 5 Klicken Sie auf **(B) Herstellen einer Verbindung mit einem Computer/Smartphone**.
 - Die folgenden Schritte gelten für Benutzer von Windows.
- 6 Klicken Sie auf **Herunterladen**.
- 7 Führen Sie die heruntergeladene Datei aus.
 - Befolgen Sie die Anweisungen auf dem Bildschirm.
 - Diese Verfahren können einige Zeit dauern.
 - Um auch eine Verbindung mit einem Smartphone herzustellen, lesen Sie „5-b. Herstellen einer Verbindung mit einem Smartphone“ auf Seite 5.

5-b

Herstellen einer Verbindung mit einem Smartphone

Wenn Sie mehrere Smartphones verwenden, führen Sie diese Schritte auf jedem Smartphone aus.



1 Installieren Sie die App „Canon PRINT Inkjet/SELPHY“ auf Ihrem Smartphone.



- Suchen Sie „Canon PRINT“ im App Store oder in Google Play.
- Rufen Sie die Canon-Website auf, um die App herunterzuladen.



2 Öffnen Sie die installierte App und befolgen Sie die Anweisungen in der App, um Ihren Drucker hinzuzufügen.



Sobald Sie Ihren Drucker hinzugefügt haben, können Sie über Ihr Smartphone drucken.
Informationen zum Drucken von Fotos finden Sie unter „Einlegen von Papier“ auf Seite 6.

Einlegen von Papier

- 1 Öffnen Sie die Papierstütze.

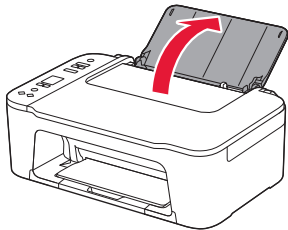

- 2 Schieben Sie die Papierführung nach links.

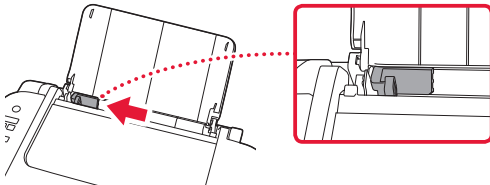

- 3 Legen Sie mehrere Blätter Papier an der rechten Kante mit der bedruckbaren Seite nach oben ein und richten Sie die Papierführung an der Breite des Papiers aus.

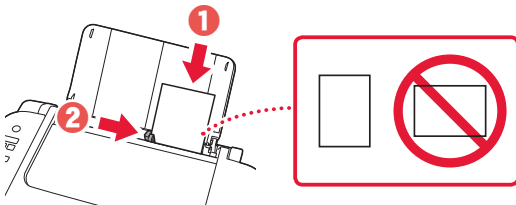

- 4 Drücken Sie die Taste **Papierauswahl (Paper Select)**, wählen Sie ein Papierformat und drücken Sie anschließend die Taste **OK**.

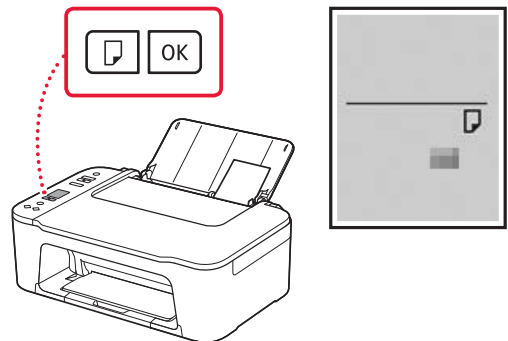

- 5 Ziehen Sie das Papierausgabefach heraus und öffnen Sie die Verlängerung des Ausgabefachs.



- Sehen Sie es sich von der Seite an und stellen Sie sicher, dass es der Abbildung entspricht.

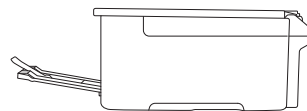

Wenn die Druckergebnisse nicht zufriedenstellend sind

Führen Sie eine Druckkopfausrichtung (Print Head Alignment) aus, wenn gerade Linien schief oder Farben ungleichmäßig gedruckt wurden oder die Druckergebnisse aus einem anderen Grund nicht Ihren Erwartungen entsprechen.

Klicken Sie auf **Wartung** im **Online-Handbuch** und lesen Sie den Abschnitt **Bei blassem oder ungleichmäßigem Druck > Ausrichten des Druckkopfs**, um weitere Informationen zu erhalten.

Informationen zum Zugriff auf das **Online-Handbuch** finden Sie auf der Rückseite.

- Linien sind schief

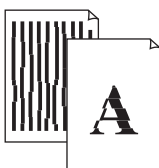

- Farben sind ungleichmäßig oder weisen Streifen auf



De printer instellen



Voor de installatie gaat u naar de URL

<https://ij.start.canon>

of scant u de code met uw mobiele apparaat



- Volg de onderstaande instructies als u geen internetverbinding hebt.

1. Inhoud van de doos

- FINE-cartridges

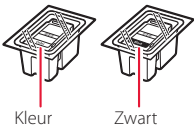

- Netsnoer
- Veiligheidsinformatie en belangrijke informatie
- Aan de Slag-gids (deze handleiding)

2. Verpakkingsmateriaal verwijderen



- 1 Verwijder de oranje tape aan de rechterkant en open de klep.

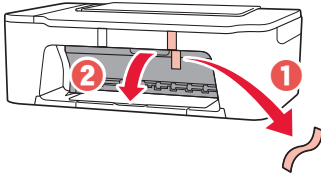

- 2 Verwijder de oranje tape aan de linkerkant.

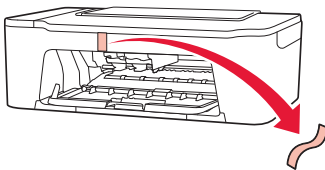

- 3 Sluit de klep.

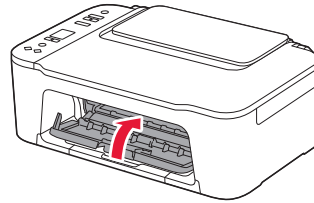

3. De printer inschakelen



- 1 Sluit het netsnoer aan.

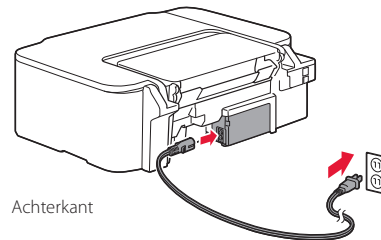

- 2 Druk op de knop **AAN (ON)**.

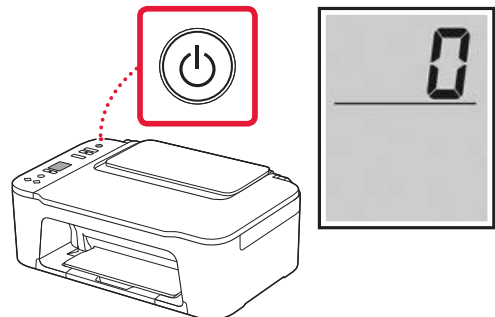

»»» Belangrijk

Als er een ander scherm wordt weergegeven, raadpleegt u "Als een van de volgende schermen verschijnt" op pagina 3 en volgt u de instructies.

De printer instellen

4. De FINE-cartridges installeren



1 Open de klep.

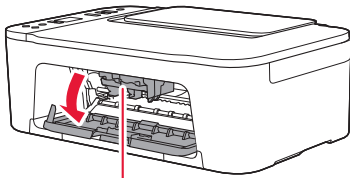

▲ Let op

Raak de FINE-cartridgehouder niet aan totdat deze stopt met bewegen.

2 Duw de inktcartridgevergrendeling aan de linkerkant omlaag.

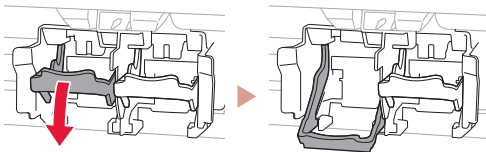

3 Haal de kleuren FINE-cartridge uit de verpakking en verwijder de beschermende tape.

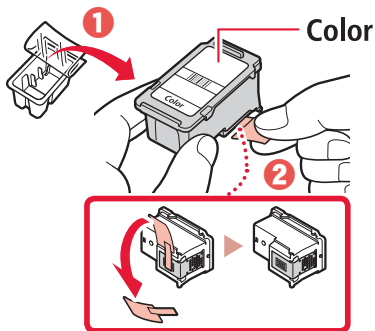

►►► Belangrijk

- Raak de inkt op de beschermende tape niet aan. Deze kan vlekken veroorzaken op uw handen of op voorwerpen in de buurt.
- Raak de aangegeven gebieden in de afbeelding niet aan. De printer kan anders mogelijk niet correct afdrukken.

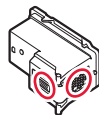

4 Plaats de kleuren FINE-cartridge in de FINE-cartridgehouder.

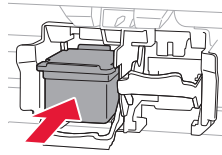

►►► Belangrijk

Stoot niet tegen de FINE-cartridge. Als u dat wel doet, kan dit leiden tot defecten.



5 Duw de inktcartridgevergrendeling omhoog.

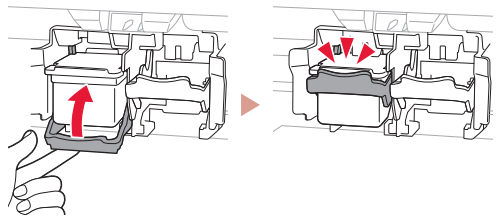

6 Herhaal stap 2 tot en met 5 en installeer de zwarte FINE-cartridge aan de rechterkant.

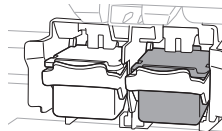

7 Sluit de klep.

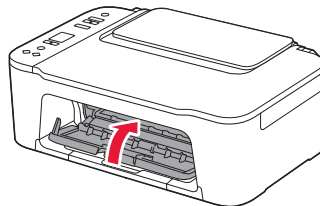

8 Controleer of het volgende scherm verschijnt.



»»» **Belangrijk**

Als E > 0 > 4 op het scherm wordt weergegeven, raadpleegt u "Als een van de volgende schermen verschijnt" op pagina 3 en volgt u de instructies.

Selecteer de verbindingsmethode die het beste past bij de manier waarop u de printer gebruikt.

- Als u de printer wilt gebruiken zonder deze met andere apparaten te verbinden
 - ➔ De installatie is nu voltooid.
- De printer gebruiken door deze met een computer of smartphone te verbinden
 - ➔ Ga verder naar de volgende pagina.

? Als een van de volgende schermen verschijnt

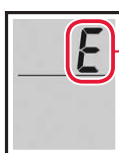

Cijfers of letters

Controleer het scherm en volg de bijbehorende instructies hieronder.



Installeer de FINE-cartridges.

➔ "4. De FINE-cartridges installeren" op pagina 2



Er is beschermend materiaal achtergebleven.

➔ "2. Verpakkingsmateriaal verwijderen" op pagina 1



De FINE-cartridges zijn niet correct geïnstalleerd.

➔ "4. De FINE-cartridges installeren" op pagina 2

In alle andere gevallen raadpleegt u de **Online handleiding**.

Met welk apparaat maakt u verbinding?



Computer



Computer en
smartphone



Smartphone

5-a

Verbinden met een computer

Als u meerdere computers gebruikt, voert u deze stappen uit op elke computer.



- 1 Ga naar de Canon-website op uw computer.
 <https://ij.start.canon>
- 2 Selecteer  **Installatie**.
- 3 Voer de modelnaam van de printer in en klik op **Ga**.
- 4 Klik op **Start**.
- 5 Klik op **(B) Verbinding maken met een computer/smartphone**.
 - De volgende stappen zijn bedoeld voor Windows-gebruikers.
- 6 Klik op **Downloaden**.
- 7 Voer het gedownloade bestand uit.
 - Volg de instructies op het scherm.
 - Deze handelingen kunnen enige tijd duren.
 - Als u ook verbinding wilt maken met een smartphone, raadpleegt u "5-b. Verbinden met een smartphone" op pagina 5.

5-b

Verbinden met een smartphone

Als u meerdere smartphones gebruikt, voert u deze stappen uit op elke smartphone.



1 Installeer de app "Canon PRINT Inkjet/SELPHY" op uw smartphone.



- Zoek "Canon PRINT" in App Store of Google Play.
- Ga naar de Canon-website om de app te downloaden.



2 Open de geïnstalleerde app en volg de instructies in de app om uw printer toe te voegen.

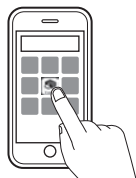

Nadat u de printer hebt toegevoegd, kunt u afdrukken vanaf uw smartphone.
Als u foto's wilt afdrukken, raadpleegt u "Papier plaatsen" op pagina 6.

Papier plaatsen

- 1 Open de papiersteun.

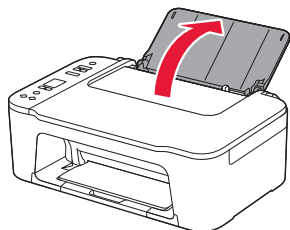

- 2 Schuif de papiergeleider naar links.

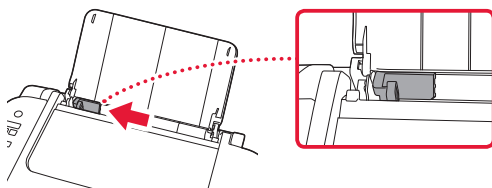

- 3 Plaats meerdere vellen papier tegen de rechterrاند met de afdrukszijde omhoog en lijn de papiergeleider uit met de breedte van het papier.

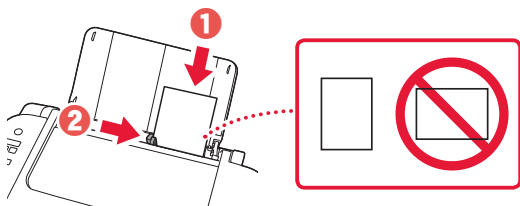

- 4 Druk op de knop **Papier selecteren (Paper Select)**, selecteer een papierformaat en druk op de knop **OK**.

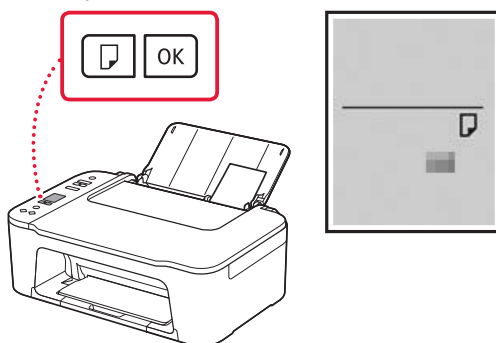

- 5 Trek de papieruitvoerlade uit en open het verlengstuk van de uitvoerlade.



- Kijk vanaf de zijkant om te controleren of het eruitziet zoals in de afbeelding.

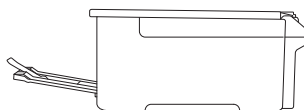

Als de afdrukresultaten onvoldoende zijn

Voer Uitlijning printkop (Print Head Alignment) uit als rechte lijnen niet recht zijn, als kleuren inconsistent zijn of als de afdrukresultaten anderszins niet zijn zoals u verwachtte.

Klik voor meer informatie op **Onderhoud** in de **Online handleiding** en lees **Als afdrukken vaag of ongelijkmatig zijn > De Printkop uitlijnen**.

Op de achterklep kunt u lezen hoe u toegang krijgt tot de **Online handleiding**.

- Lijnen zijn niet uitgelijnd

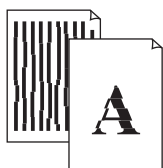

- Kleuren zijn ongelijkmatig of gevlekt



Impostazione della stampante



**Per eseguire l'impostazione,
visitare l'URL**

<https://ij.start.canon>

o eseguire la scansione del codice con il proprio dispositivo cellulare



● Se non si dispone di una connessione a Internet, attenersi alle istruzioni riportate di seguito.

1. Contenuto della scatola

- Cartucce FINE

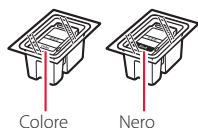

- Cavo di alimentazione
- Informazioni importanti e sulla sicurezza
- Guida Rapida (questo manuale)

2. Rimozione del materiale da imballaggio



- 1 Rimuovere il nastro arancione sulla destra e aprire il coperchio.

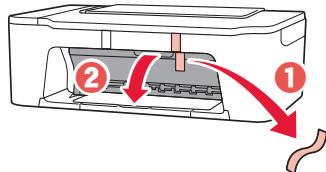

- 2 Rimuovere il nastro arancione sulla sinistra.

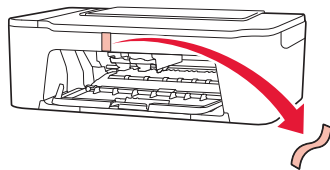

- 3 Chiudere il coperchio.

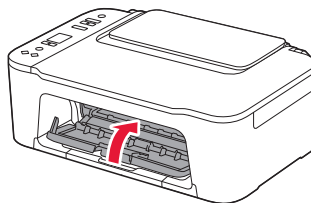

3. Accensione della stampante



- 1 Collegare il cavo di alimentazione.

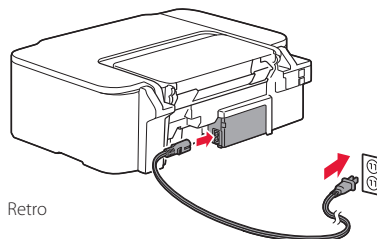

- 2 Premere il pulsante **ON**.

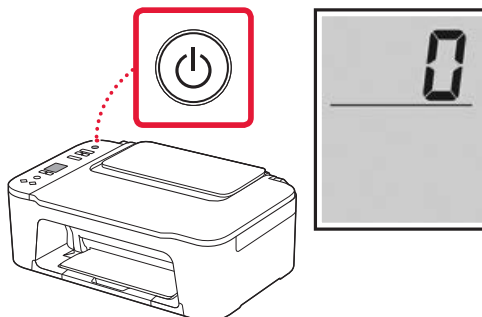

►►► Importante

Se appare un'altra schermata, vedere "Se viene visualizzata una delle seguenti schermate" a pagina 3 e seguire le istruzioni.

Impostazione della stampante

4. Installazione delle cartucce FINE



1 Aprire il coperchio.

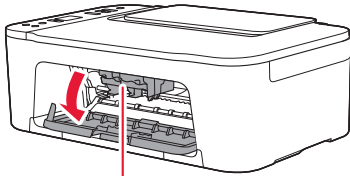

⚠ Attenzione

Non toccare il supporto cartuccia FINE fino a che non si ferma.

2 Abbassare la leva di bloccaggio della cartuccia di inchiostro sul lato sinistro.

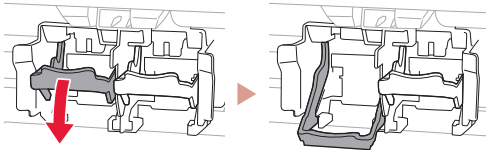

3 Rimuovere la cartuccia FINE del colore dalla confezione e rimuovere il nastro protettivo.

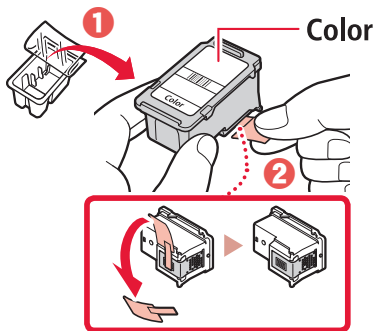

»»» Importante

- Non toccare l'inchiostro presente sul nastro protettivo. Potrebbe macchiare le mani o altri oggetti vicini.
- Non toccare le aree mostrate nella figura. Altrimenti, la stampante potrebbe non stampare correttamente.

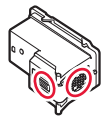

4 Inserire la cartuccia FINE del colore nel supporto cartuccia FINE.

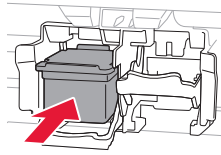

»»» Importante

Non scuotere la cartuccia FINE. Ciò potrebbe causare un malfunzionamento.



5 Sollevare la leva di bloccaggio della cartuccia di inchiostro.

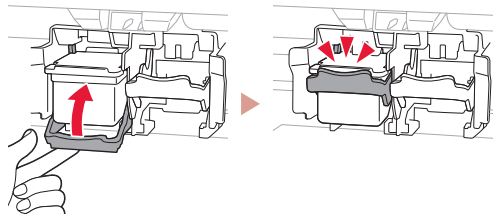

6 Ripetere i passi da 2 a 5 e installare la cartuccia FINE del nero sul lato destro.

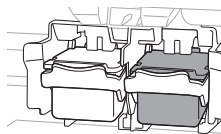

7 Chiudere il coperchio.

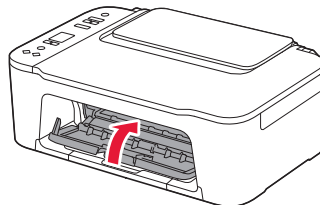

8 Verificare che venga visualizzata la schermata seguente.



»»» **Importante**

Se appare E > 0 > 4 sulla schermata, vedere "Se viene visualizzata una delle seguenti schermate" a pagina 3 e seguire le istruzioni.

Selezionare il metodo di connessione che più si adatta al modo in cui si utilizzerà la stampante.

- Per utilizzare la stampante senza connettersi ad altre periferiche
➔ L'impostazione è ora completata.
- Per utilizzare la stampante stabilendo una connessione a un computer o uno smartphone
➔ Procedere alla pagina successiva.



Se viene visualizzata una delle seguenti schermate

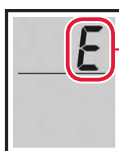

Numeri o lettere

Controllare la schermata e seguire le istruzioni corrispondenti di seguito.



Installare le cartucce FINE.

➔ "4. Installazione delle cartucce FINE" a pagina 2



È rimasto del materiale di protezione.

➔ "2. Rimozione del materiale da imballaggio" a pagina 1



Le cartucce FINE non sono installate correttamente.

➔ "4. Installazione delle cartucce FINE" a pagina 2

Per tutti gli altri casi, consultare il **Manuale online**.

Quale periferica si sta connettendo?



Computer



Computer e
smartphone



Smartphone

5-a

Connessione a un computer

Se si utilizzano più computer, eseguire questi passaggi su ciascun computer.



- 1 Accedere al sito Web di Canon dal computer.
 <https://ij.start.canon>
- 2 Selezionare  **Impostazione**.
- 3 Immettere il nome del modello della stampante e fare clic su **Vai**.
- 4 Fare clic su **Avvio**.
- 5 Fare clic su **(B) Connessione a un computer/uno smartphone**.
 - Le seguenti procedure sono destinate agli utenti Windows.
- 6 Fare clic su **Scarica**.
- 7 Eseguire il file scaricato.
 - Seguire le istruzioni visualizzate sullo schermo.
 - Queste operazioni possono richiedere del tempo.
 - Per connettersi anche a uno smartphone, vedere "5-b. Connessione a uno smartphone" a pagina 5.

5-b

Connessione a uno smartphone

Se si utilizzano più smartphone, eseguire questi passaggi su ciascuno smartphone.



1 Installare l'app "Canon PRINT Inkjet/SELPHY" sullo smartphone.



- Cercare "Canon PRINT" in App Store o Google Play.
- Accedere al sito Web Canon per scaricare l'app.



2 Aprire l'app installata e seguire le istruzioni visualizzate nell'app per aggiungere la stampante.



Una volta aggiunta la stampante, è possibile stampare dallo smartphone.
Per stampare foto, vedere "Caricamento della carta" a pagina 6.

Caricamento della carta

- 1 Aprire il supporto per la carta.

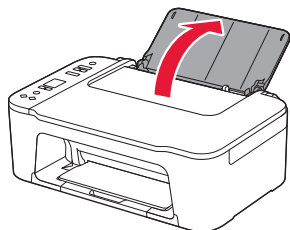

- 2 Far scorrere la guida della carta verso sinistra.

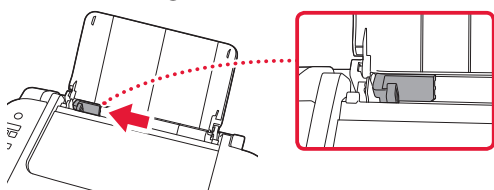

- 3 Caricare diversi fogli di carta contro il bordo destro con il lato di stampa rivolto verso l'alto e allineare la guida della carta alla larghezza della carta.

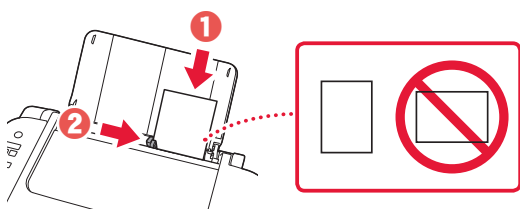

- 4 Premere il pulsante **Selezione carta (Paper Select)**, selezionare un formato carta, quindi premere il pulsante **OK**.

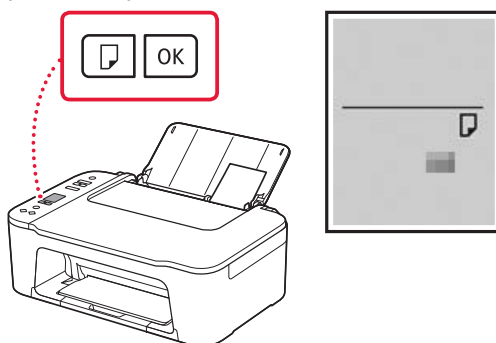

- 5 Estendere il vassoio di uscita della carta, quindi aprire l'estensione del vassoio di uscita.



- Guardarlo lateralmente per assicurarsi che assomiglia al disegno.

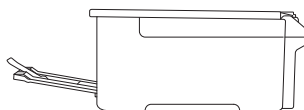

Se i risultati di stampa non sono soddisfacenti

Eseguire l'Allineamento testina di stampa (Print Head Alignment) se le linee rette risultano deformate, i colori risultano inconsistenti o i risultati di stampa sono diversi da quanto previsto.

Per ulteriori informazioni, fare clic su **Manutenzione** nel **Manuale online** e vedere **Se la stampa è sbiadita o irregolare > Allineamento della posizione della Testina di stampa**.

Fare riferimento al coperchio posteriore per informazioni su come accedere al **Manuale online**.

■ Linee non allineate

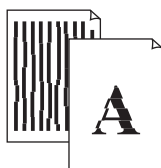

■ Colori non uniformi o con striature



Configurando a impressora



Para configurar, visite a URL

<https://ij.start.canon>

ou digitalize o código com seu dispositivo celular



●Siga as instruções abaixo se você não tiver uma conexão com a internet.

1. Conteúdo da caixa

● Cartuchos FINE

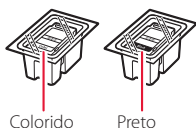

Colorido

Preto

● Cabo de alimentação

● Informações Importantes e Sobre Segurança

● Para Começar (este manual)

2. Removendo os materiais da embalagem



1 Remova a fita laranja à direita e abra a tampa.

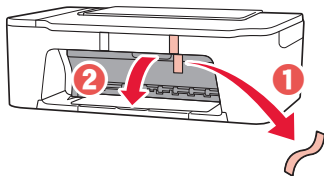

2 Remova a fita laranja à esquerda.

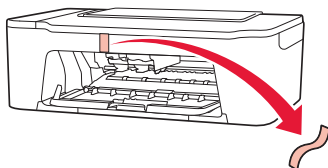

3 Feche a tampa.

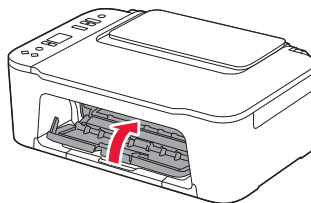

3. Ligando a impressora



1 Conecte o cabo de alimentação.

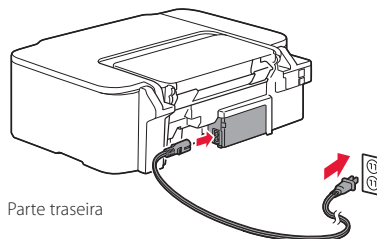

Parte traseira

2 Pressione o botão **ATIVADO (ON)**.

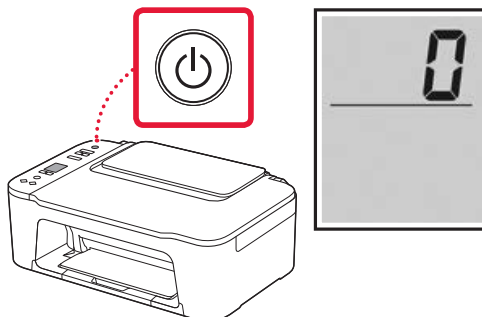

▶▶▶ Importante

Se outra tela aparecer, consulte "Se alguma das seguintes telas aparecer" na página 3 e siga as instruções.

Configurando a impressora

4. Instalando os Cartuchos FINE



1 Abra a tampa.

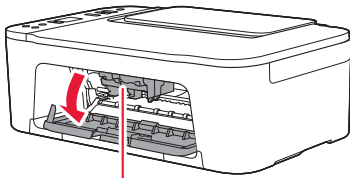

⚠ Cuidado

Não toque no suporte do cartucho FINE antes de ele parar de se mover.

2 Abaixar a alavanca de bloqueio do cartucho de tinta no lado esquerdo.

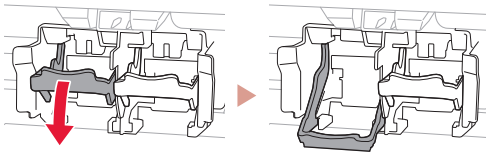

3 Remova o Cartucho FINE colorido do pacote e remova a fita de proteção.

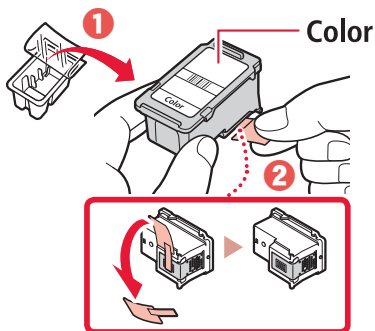

»»» Importante

- Não toque na tinta na fita de proteção. Ela pode manchar suas mãos ou os objetos em volta.
- Não toque nas áreas mostradas na figura. Caso contrário, a impressora pode não imprimir corretamente.

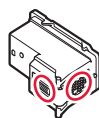

4 Insira o Cartucho FINE colorido no suporte do cartucho FINE.

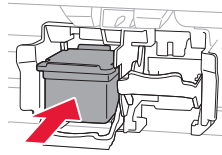

»»» Importante

Não bata o cartucho FINE. Fazer isso pode causar problemas de funcionamento.



5 Eleve a alavanca de bloqueio do cartucho de tinta.

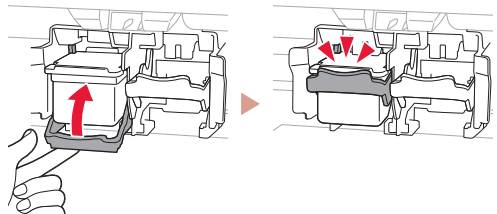

6 Repita as etapas 2 a 5 e instale o cartucho FINE preto no lado direito.

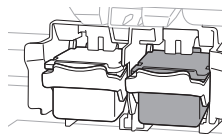

7 Feche a tampa.

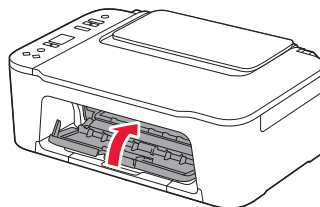

8 Verifique se a tela a seguir aparece.



►►► Importante

Se aparecer E > 0 > 4 na tela, consulte "Se alguma das seguintes telas aparecer" na página 3 e siga as instruções.

Selecione o método de conexão que melhor se adequa ao seu uso da impressora.

- Para usar a impressora sem conectá-la a nenhum outro dispositivo
 - ➔ A configuração foi concluída.
- Para utilizar a impressora com conexão a um computador ou smartphone
 - ➔ Prossiga para a página seguinte.



Se alguma das seguintes telas aparecer

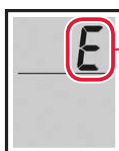

Números ou letras

Verifique a tela e siga as instruções correspondentes abaixo.



Instale os Cartuchos FINE.

➔ "4. Instalando os Cartuchos FINE" na página 2



Material de proteção restante.

➔ "2. Removendo os materiais da embalagem" na página 1



Os Cartuchos FINE não estão instalados corretamente.

➔ "4. Instalando os Cartuchos FINE" na página 2

Para todos os outros casos, consulte o **Manual On-line**.

Qual dispositivo você está conectando?



Computador



Computador e
smartphone



Smartphone

5-a

Conectando a um Computador

Se você estiver usando vários computadores, execute estas etapas em cada computador.



- 1 Acesse o site Canon do seu computador.
 <https://ij.start.canon>
- 2 Selecione  **Configurar**.
- 3 Insira o nome do modelo da sua impressora e clique em **Ir**.
- 4 Clique em **Iniciar**.
- 5 Clique em **(B) Conectar a um Computador/Smartphone**.
 - As etapas a seguir são para usuários do Windows.
- 6 Clique em **Download**.
- 7 Execute o arquivo baixado.
 - Siga as instruções na tela.
 - Estas operações podem levar algum tempo.
 - Para conectar a um smartphone também, consulte "5-b. Conectando a um smartphone" na página 5.

5-b

Conectando a um smartphone

Se você estiver usando vários smartphones, execute estas etapas em cada smartphone.



1 Instale o aplicativo "Canon PRINT Inkjet/SELPHY" no seu smartphone.



- Procure por "Canon PRINT" na App Store, ou Google Play.
- Acesse o site Canon para fazer o download do aplicativo.



2 Abra o aplicativo instalado e siga as instruções para adicionar sua impressora.

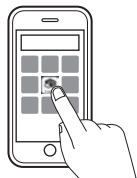

Depois que você adicionar a impressora, poderá imprimir a partir do smartphone.
Para imprimir fotos, consulte "Colocando papel" na página 6.

Colocando papel

- 1 Abra o suporte de papel.

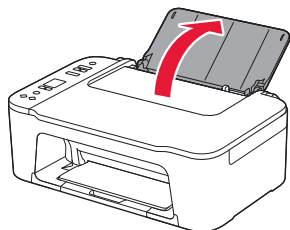

- 2 Deslize a guia do papel para a esquerda.

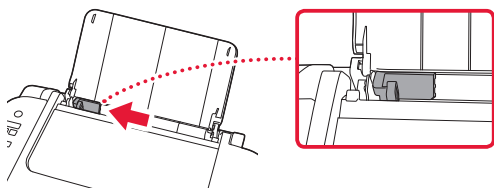

- 3 Coloque várias folhas de papel na borda direita com o lado a ser impresso virado para cima e alinhe a guia do papel à largura do papel.

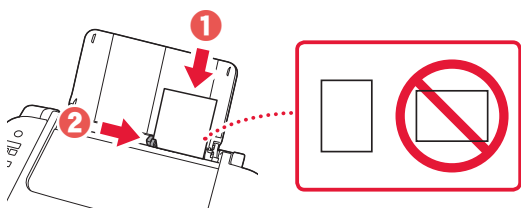

- 4 Pressione o botão **Selecionar papel (Paper Select)** selecione um tamanho de papel e, em seguida, pressione o botão **OK**.

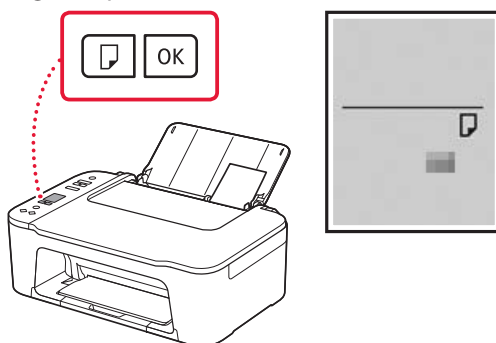

- 5 Estenda a bandeja de saída do papel e abra a extensão da bandeja de saída.



- Olhe pela lateral para confirmar se parece com o diagrama.

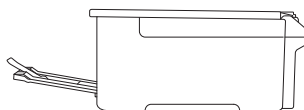

Se os Resultados da Impressão Forem Insatisfatórios

Execute Alinhamento da cabeça de impressão (Print Head Alignment) se as linhas retas estiverem tortas ou se as cores estiverem inconsistentes, ou se os resultados da impressão não forem como esperados.

Para obter detalhes, clique em **Manutenção** no **Manual On-line** e consulte **Se a Impressão Estiver Menos Nítida ou Irregular > Alinhando a Cabeça de Impressão**.

Consulte a contracapa para saber como acessar o **Manual On-line**.

■ Linhas Desalinhadas

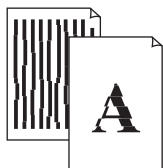

■ Cores Irregulares ou com listras



Instalación de la impresora



Para la configuración, visite
la URL

<https://ij.start.canon>

o bien escanee el código con su dispositivo móvil

●Siga las instrucciones que se proporcionan a continuación si no tiene conexión a Internet.



1. Contenido de la caja

● Cartuchos FINE

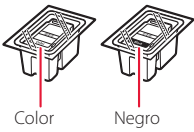

● Cable de alimentación

● Información de seguridad e información importante

● Guía de inicio (este manual)

2. Retirar los materiales de protección



1 Retire la cinta naranja de la derecha y abra la cubierta.

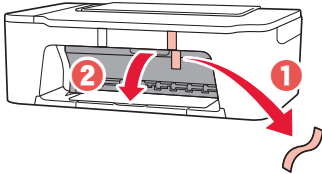

2 Retire totalmente la cinta naranja de la izquierda.

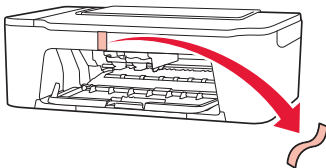

3 Cierre la cubierta.

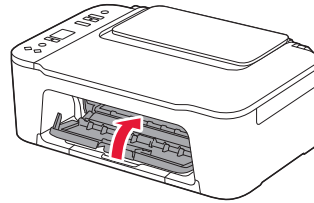

3. Encender la impresora



1 Conecte el cable de alimentación.

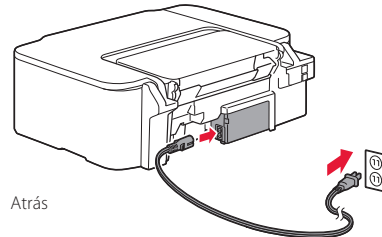

2 Pulse el botón **ACTIVADO (ON)**.

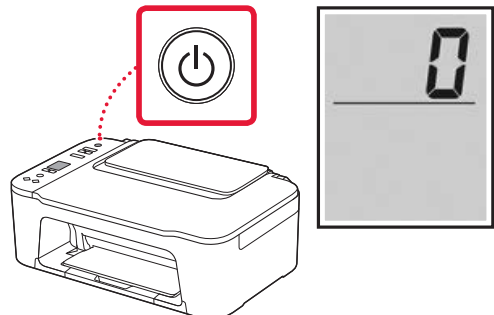

►►► Importante

Si aparece otra pantalla, consulte "Si aparece alguna de las siguientes pantallas" en la página 3 y siga las instrucciones.

Instalación de la impresora

4. Instalar los cartuchos FINE



1 Abra la cubierta.

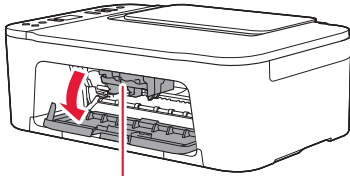

▲ Precaución

No toque el soporte de cartucho FINE hasta que se detenga.

2 Baje la palanca de bloqueo del cartucho de tinta del lado izquierdo.

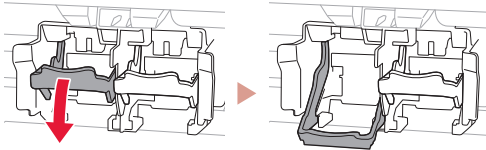

3 Retire el cartucho FINE de color del paquete y retire la cinta protectora.

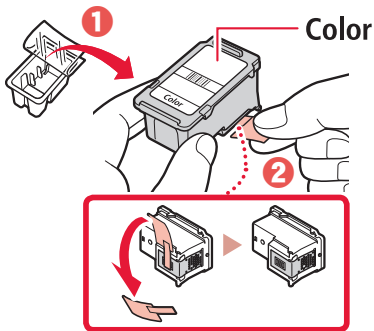

►►► Importante

- No toque la tinta de la cinta protectora. Podría manchar sus manos o los objetos que se encuentran a su alrededor.
- No toque las áreas que se muestran en la imagen. Si lo hace, puede que la impresora no imprima correctamente.

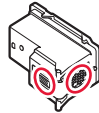

4 Inserte el cartucho FINE de color en el soporte de cartucho FINE.

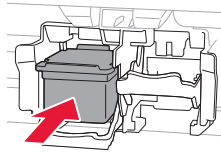

►►► Importante

No golpee el cartucho FINE. Si se golpea, puede funcionar mal.



5 Suba la palanca de bloqueo del cartucho de tinta.

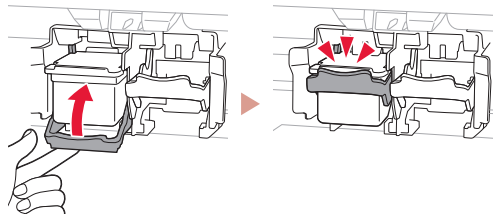

6 Repita los pasos del 2 al 5 e instale el cartucho FINE negro en el lado derecho.

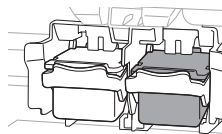

7 Cierre la cubierta.

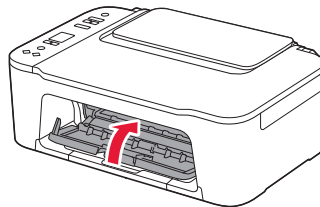

8 Compruebe que aparezca la siguiente pantalla.



»»» Importante

Si aparece E > 0 > 4 en la pantalla, consulte "Si aparece alguna de las siguientes pantallas" en la página 3 y siga las instrucciones.

Seleccione el método de conexión que mejor se adapte al uso de la impresora.

- Para usar la impresora sin conectar con ningún otro dispositivo
 - ➔ Ha finalizado la configuración.
- Para usar la impresora conectándola a un ordenador o un teléfono inteligente
 - ➔ Continúe a la página siguiente.



Si aparece alguna de las siguientes pantallas

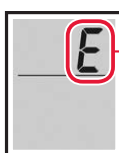

Números o letras

Consulte la pantalla y, a continuación, siga las instrucciones correspondientes que se muestran a continuación.



Instale los cartuchos FINE.

➔ "4. Instalar los cartuchos FINE" en la página 2



Material de protección restante.

➔ "2. Retirar los materiales de protección" en la página 1



Los cartuchos FINE no están instalados correctamente.

➔ "4. Instalar los cartuchos FINE" en la página 2

Para los demás casos, consulte el **Manual en línea**.

¿Qué dispositivo va a conectar?



Ordenador



Ordenador y
teléfono inteligente





Teléfono inteligente

5-a

Conectar al ordenador

Si utiliza varios ordenadores, realice estos pasos en cada ordenador.



- 1 Acceda al sitio web de Canon desde el ordenador.
 <https://ij.start.canon>
- 2 Seleccione  **Configurar**.
- 3 Escriba el nombre del modelo de su impresora y haga clic en **Ir**.
- 4 Haga clic en **Iniciar**.
- 5 Haga clic en **(B) Conexión con un ordenador/teléfono inteligente**.
 - Los siguientes pasos son para usuarios de Windows.
- 6 Haga clic en **Descargar**.
- 7 Ejecute el archivo descargado.
 - Siga las instrucciones que aparezcan en pantalla.
 - Estas operaciones pueden llevar algún tiempo.
 - Para conectar con un teléfono inteligente también, consulte "5-b. Conexión con un teléfono inteligente" en la página 5.

5-b

Conexión con un teléfono inteligente

Si utiliza varios teléfonos inteligentes, realice estos pasos en cada teléfono inteligente.



1 Instale la aplicación "Canon PRINT Inkjet/SELPHY" en su teléfono inteligente.



- Busque "Canon PRINT" en App Store o Google Play.
- Acceda al sitio web Canon para descargar la aplicación.



2 Abra la aplicación instalada y luego siga las instrucciones en la aplicación para agregar su impresora.

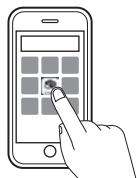

Cuando haya agregado la impresora, podrá imprimir desde su teléfono inteligente.
Para imprimir fotos, consulte "Carga de papel" en la página 6.

Carga de papel

- 1 Abra el soporte del papel.

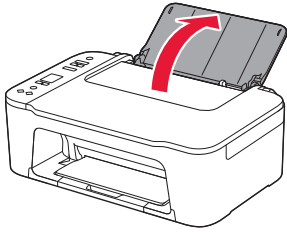

- 2 Deslice la guía del papel hacia la izquierda.

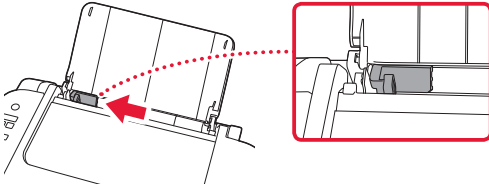

- 3 Cargue varias hojas de papel contra el borde derecho con la cara de impresión hacia arriba y alinee la guía del papel con el ancho del papel.

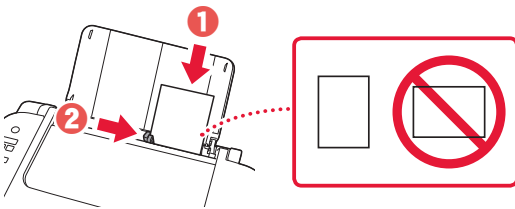

- 4 Pulse el botón **Selección de papel (Paper Select)**, seleccione un tamaño de papel y, a continuación, pulse el botón **OK**.

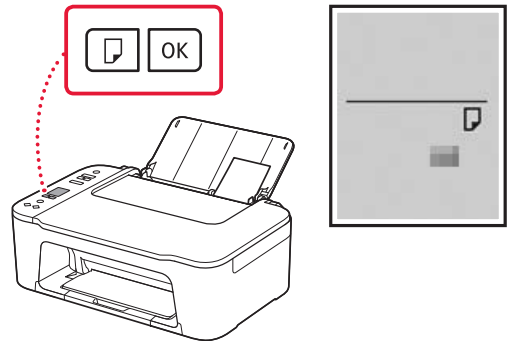

- 5 Extienda la bandeja de salida del papel y abra la extensión de la bandeja de salida.

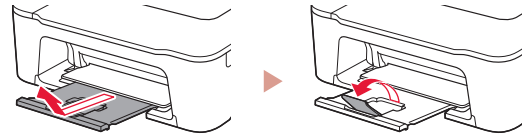

- Mírelo desde el lado para confirmar que está como en el diagrama.

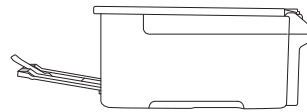

Si los resultados de impresión no son satisfactorios

Realice Alineación de los cabezales de impresión (Print Head Alignment) si las líneas rectas aparecen torcidas o los colores no son uniformes, o si los resultados de impresión no son como se esperaba.

Para más información, haga clic en **Mantenimiento** en el **Manual en línea** y consulte **Si la impresión pierde intensidad o es irregular > Alineación del Cabezal de impresión**.

Consulte en la cubierta trasera cómo acceder al **Manual en línea**.

■ Líneas desalineadas

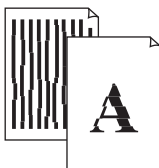

■ Colores desiguales o con manchas



Ρύθμιση του εκτυπωτή



Για την εγκατάσταση, επισκεφθείτε το URL

<https://ij.start.canon>

ή σαρώστε τον κωδικό με την κινητή συσκευή σας

• Ακολουθήστε τις παρακάτω οδηγίες αν δεν έχετε σύνδεση internet.



1. Περιεχόμενα συσκευασίας

• Φυσίγγια FINE

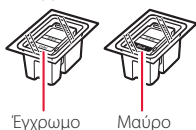

Εγχρωμο

Μαύρο

• Καλώδιο τροφοδοσίας

• Πληροφορίες για την ασφάλεια και σημαντικές πληροφορίες

• Ξεκινώντας (αυτό το εγχειρίδιο)

2. Αφαίρεση υλικών συσκευασίας



1 Αφαιρέστε την πορτοκαλί ταινία στα δεξιά και ανοίξτε το κάλυμμα.

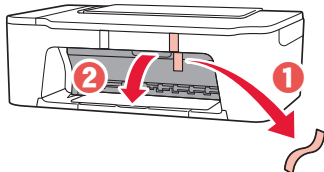

2 Αφαιρέστε την πορτοκαλί ταινία στα αριστερά.

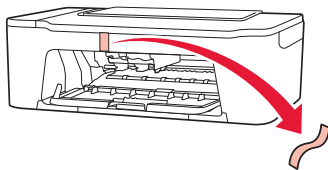

3 Κλείστε το κάλυμμα.

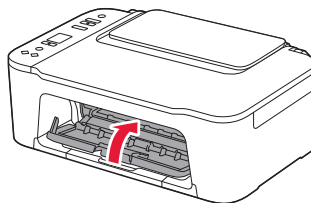

3. Ενεργοποίηση του εκτυπωτή



1 Συνδέστε το καλώδιο τροφοδοσίας.

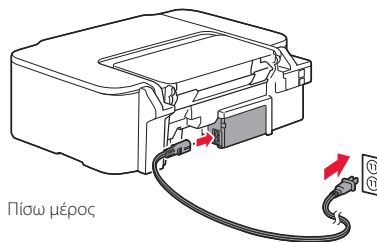

Πίσω μέρος

2 Πατήστε το κουμπί ON.

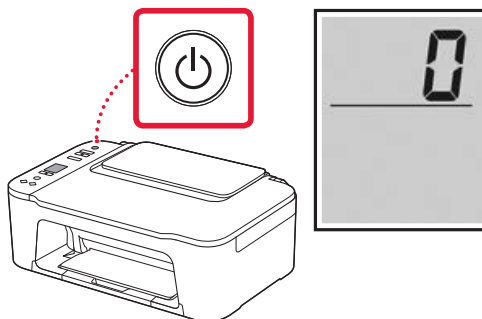

»»» Σημαντικό

Αν εμφανιστεί μια άλλη οθόνη, ανατρέξτε στην ενότητα «Αν εμφανιστεί οποιαδήποτε από τις ακόλουθες οθόνες» στη σελίδα 3 και ακολουθήστε τις οδηγίες.

Ρύθμιση του εκτυπωτή

4. Τοποθέτηση των φυσιγγίων FINE



1 Ανοίξτε το κάλυμμα.

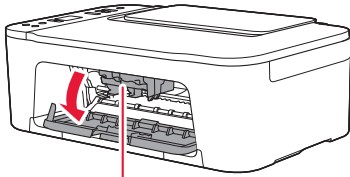

⚠ Προσοχή

Μην αγγίζετε τη θήκη φυσιγγίου FINE μέχρι να σταματήσει να κινείται.

2 Κατεβάστε τον μοχλό ασφάλισης φυσιγγίου μελάνης στην αριστερή πλευρά.

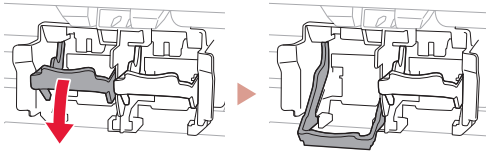

3 Αφαιρέστε το έγχρωμο φυσιγγίο FINE από τη συσκευασία και αφαιρέστε την προστατευτική ταινία.

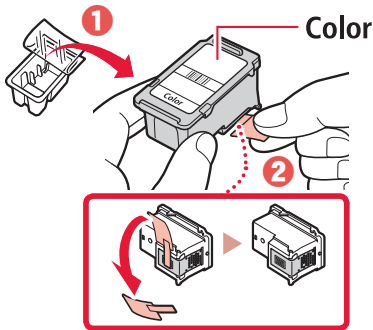

»»» Σημαντικό

- Μην αγγίζετε τη μελάνη που παραμένει στην προστατευτική ταινία. Μπορεί να λερώσετε τα χέρια σας ή τα γύρω αντικείμενα.
- Μην αγγίζετε τις περιοχές που υποδεικνύονται στην εικόνα. Διαφορετικά, ο εκτυπωτής ενδέχεται να μην εκτυπώνει σωστά.

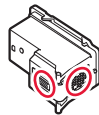

4 Τοποθετήστε το έγχρωμο φυσιγγίο FINE στη θήκη φυσιγγίου FINE.

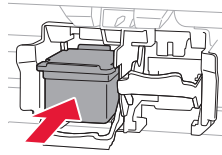

»»» Σημαντικό

Μη χτυπάτε το φυσιγγίο FINE. Κάτι τέτοιο μπορεί να προκαλέσει δυσλειτουργία.



5 Ανεβάστε τον μοχλό ασφάλισης φυσιγγίου μελάνης.

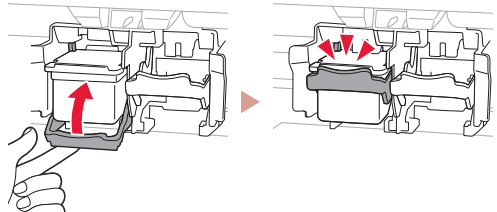

6 Επαναλάβετε τα βήματα 2 έως 5 και εγκαταστήστε το μαύρο φυσιγγίο FINE στη δεξιά πλευρά.

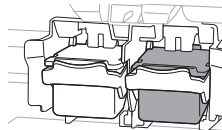

7 Κλείστε το κάλυμμα.

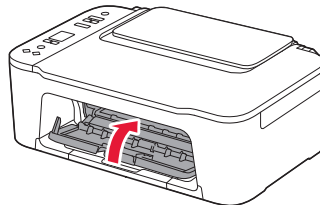

8 Βεβαιωθείτε ότι εμφανίζεται η ακόλουθη οθόνη.



»»» Σημαντικό

Αν στην οθόνη εμφανιστεί η ένδειξη $E > 0 > 4$, ανατρέξτε στην ενότητα «Αν εμφανιστεί οποιαδήποτε από τις ακόλουθες οθόνες» στη σελίδα 3 και ακολουθήστε τις οδηγίες.

Επιλέξτε τη μέθοδο που ταιριάζει καλύτερα στον τρόπο που θα χρησιμοποιείτε τον εκτυπωτή.

- Για χρήση του εκτυπωτή χωρίς σύνδεση σε άλλες συσκευές
 - ➔ Η ρύθμιση έχει ολοκληρωθεί.
- Για χρήση του εκτυπωτή με σύνδεση σε υπολογιστή ή smartphone
 - ➔ Προχωρήστε στην επόμενη σελίδα.



Αν εμφανιστεί οποιαδήποτε από τις ακόλουθες οθόνες

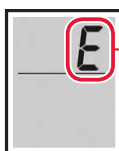

Αριθμοί ή γράμματα

Ελέγξτε την οθόνη και, στη συνέχεια, ακολουθήστε τις αντίστοιχες οδηγίες παρακάτω.



Τοποθετήστε τα φυσιγγία FINE.

➔ «4. Τοποθέτηση των φυσιγγίων FINE» στη σελίδα 2



Προστατευτικό υλικό που απομένει.

➔ «2. Αφαίρεση υλικών συσκευασίας» στη σελίδα 1



Τα φυσιγγία FINE δεν έχουν τοποθετηθεί σωστά.

➔ «4. Τοποθέτηση των φυσιγγίων FINE» στη σελίδα 2

Για όλες τις λοιπές περιπτώσεις, ανατρέξτε στο **Online εγχειρίδιο**.

Τι συσκευή σκοπεύετε να συνδέσετε;



Υπολογιστής



Υπολογιστής και
smartphone



Smartphone





5-a

Σύνδεση με υπολογιστή

Εάν χρησιμοποιείτε πολλούς υπολογιστές, εκτελέστε αυτά τα βήματα σε κάθε υπολογιστή.



- 1 Μεταβείτε στη διαδικτυακή τοποθεσία της Canon από τον υπολογιστή σας.
 <https://ij.start.canon>
- 2 Επιλέξτε  **Εγκατάσταση.**
- 3 Καταχωρίστε το όνομα μοντέλου του εκτυπωτή σας και κάντε κλικ στην επιλογή **Μετάβαση.**
- 4 Κάντε κλικ στο **Έναρξη.**
- 5 Κάντε κλικ στο **(B) Σύνδεση σε υπολογιστή/smartphone.**
 - Τα παρακάτω βήματα αφορούν τους χρήστες Windows.
- 6 Κάντε κλικ στο **Λήψη.**
- 7 Εκτελέστε το ληφθέν αρχείο.
 - Ακολουθήστε τις οδηγίες στην οθόνη.
 - Αυτές οι λειτουργίες ενδέχεται να χρειαστούν κάποιο χρόνο.
 - Για να συνδέσετε και σε smartphone, ανατρέξτε στην ενότητα «5-b. Σύνδεση με Smartphone» στη σελίδα 5.

5-b

Σύνδεση με Smartphone

Εάν χρησιμοποιείτε πολλά smartphone, εκτελέστε αυτά τα βήματα σε κάθε smartphone.

**1** Εγκαταστήστε την εφαρμογή «Canon PRINT Inkjet/SELPHY» στο smartphone σας.

- Κάντε αναζήτηση για το «Canon PRINT» στο App Store ή στο Google Play.
- Μεταβείτε στη διαδικτυακή τοποθεσία της Canon για λήψη της εφαρμογής.

**2** Ανοίξτε την εγκατεστημένη εφαρμογή και ακολουθήστε τις οδηγίες που εμφανίζονται στην οθόνη στην εφαρμογή για να προσθέσετε τον εκτυπωτή σας.

Αφού προσθέσετε τον εκτυπωτή σας, θα μπορείτε να εκτυπώνετε από το smartphone σας.
Για να εκτυπώσετε φωτογραφίες, ανατρέξτε στην ενότητα «Τοποθέτηση χαρτιού» στη σελίδα 6.

Τοποθέτηση χαρτιού

- 1 Ανοίξτε την υποστήριξη χαρτιού.

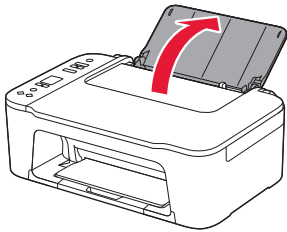

- 2 Σύρετε τον οδηγό χαρτιού προς τα αριστερά.

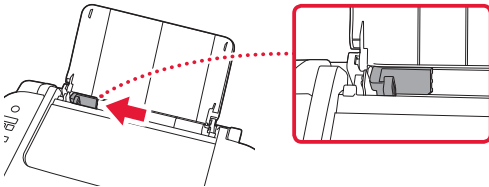

- 3 Τοποθετήστε αρκετά φύλλα χαρτιού έτσι ώστε να ακουμπούν στη δεξιά πλευρά και με την πλευρά εκτύπωσης στραμμένη προς τα επάνω και ευθυγραμμίστε τον οδηγό χαρτιού με το πλάτος του χαρτιού.

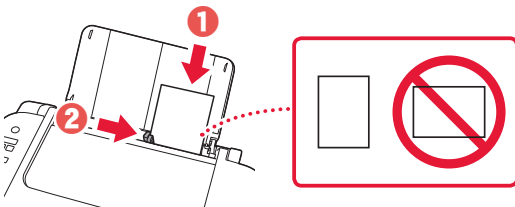

- 4 Πατήστε το κουμπί **Επιλογή χαρτιού (Paper Select)**, επιλέξτε μέγεθος χαρτιού και, στη συνέχεια, πατήστε το κουμπί **OK**.

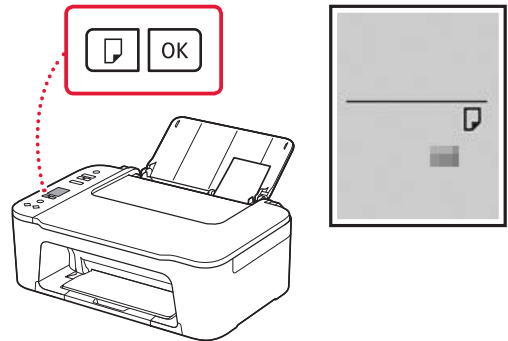

- 5 Εκτείνετε τη θήκη εξόδου χαρτιού και ανοίξτε την προέκταση θήκης εξόδου.

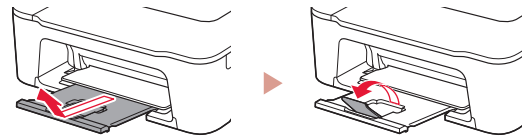

- Κοιτάξτε την από το πλάι για να επιβεβαιώσετε ότι είναι όπως στο διάγραμμα.

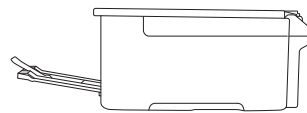

Εάν τα αποτελέσματα εκτύπωσης δεν είναι ικανοποιητικά

Εκτελέστε Ευθυγράμμιση κεφαλής εκτύπωσης (Print Head Alignment) εάν οι ευθείες γραμμές είναι στραβές ή τα χρώματα δεν είναι συνεπή ή εάν τα αποτελέσματα της εκτύπωσης δεν είναι αυτά που αναμένετε.

Για λεπτομέρειες, κάντε κλικ στην επιλογή **Συντήρηση** στο **Online εγχειρίδιο** και ανατρέξτε στην ενότητα **Εάν η εκτύπωση είναι αχνή ή ανομοιομορφή > Ευθυγράμμιση της Κεφαλής εκτύπωσης**.

Ανατρέξτε στο πίσω εξώφυλλο για να δείτε πώς θα αποκτήσετε πρόσβαση στο **Online εγχειρίδιο**.

- Κακή ευθυγράμμιση των γραμμών



- Ανομοιογενή χρώματα ή χρώματα με ραβδώσεις



Ställa in skrivaren



Besök webbadressen för Konfiguration

<https://ij.start.canon>

eller skanna koden med mobilenheten



● Följ anvisningarna nedan om du inte är uppkopplad till internet.

1. Boxens innehåll

● FINE-kassetter

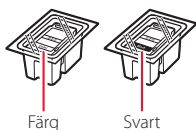

● Strömkabel

● Information om säkerhet och annan viktig information

● Uppstartsguide (denna handbok)

2. Ta bort förpackningsmaterial



1 Ta bort den orange tejen till höger och öppna luckan.

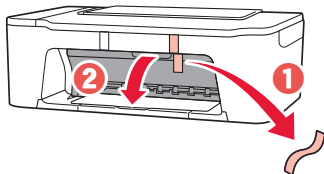

2 Ta bort den orange tejen till vänster.

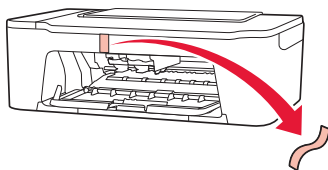

3 Stäng luckan.

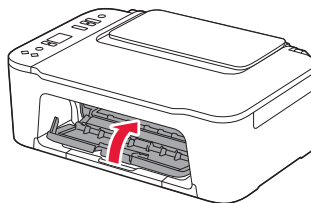

3. Slå på skrivaren



1 Anslut strömkabeln.

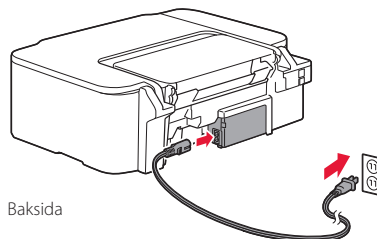

2 Tryck på **PÅ (ON)**.

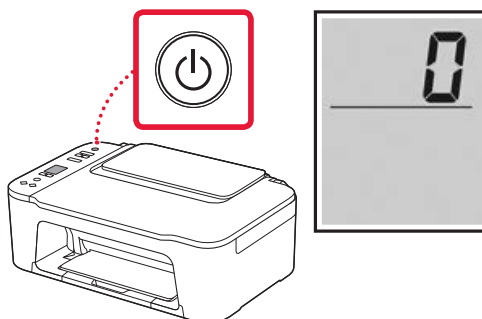

»»» Viktigt!

Läs "Om någon av följande skärmar visas" på sida 3 och följ anvisningarna om en annan skärm visas.

Ställa in skrivaren

4. Installera FINE-kassetterna



1 Öppna luckan.

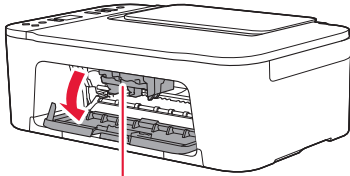

⚠ Försiktighet

Rör inte hållaren för FINE-kassetten förrän den har stannat.

2 Sänk låsspaken för bläckkassetten på vänster sida.

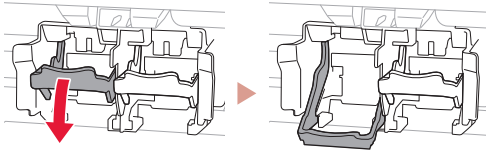

3 Ta bort FINE-kassetten för färg från förpackningen och ta bort skyddstejpen.

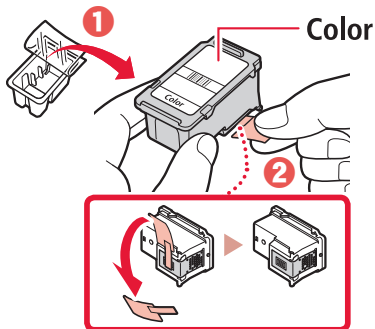

»»» Viktigt!

- Rör inte bläcket på skyddstejpen. Det kan ge fläckar på dina händer eller omgivande objekt.
- Rör inte områdena som visas på bilden. Annars kanske inte skrivaren fungerar korrekt.

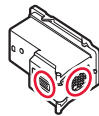

4 Sätt in FINE-kassetten för färg i hållaren för FINE-kassetter.

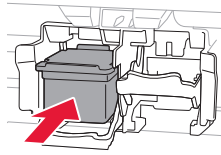

»»» Viktigt!

Låt inte FINE-kassetterna stöta i något. Det kan göra att den slutar fungera.



5 Höj låsspaken för bläckkassetten.

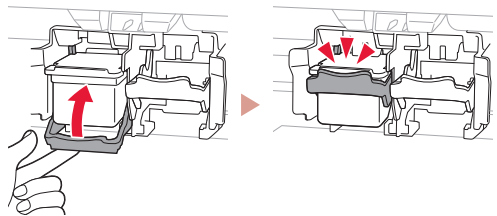

6 Upprepa steg 2 till 5 och installera FINE-kassetten för svart på höger sida.

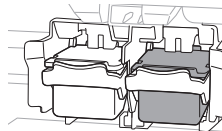

7 Stäng luckan.

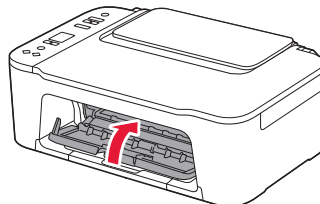

8 Kontrollera att följande skärm visas.



»»» Viktigt!

Om E > 0 > 4 visas på skärmen läser du "Om någon av följande skärmar visas" på sida 3 och följer instruktionerna.

Välj anslutningsmetoden som bäst passar hur du ska använda skrivaren.

- Om du vill använda skrivaren utan att ansluta några andra enheter
 - ➔ Konfigurationen är nu klar.
- För att använda skrivaren genom att ansluta till en dator eller smarttelefon
 - ➔ Fortsätt till nästa sida.



Om någon av följande skärmar visas

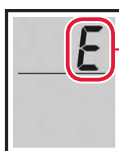

Siffror eller bokstäver

Kontrollera skärmen och följ motsvarande instruktioner nedan.



Installera FINE-kassetterna.

➔ "4. Installera FINE-kassetterna" på sida 2



En del skyddsmaterial har inte tagits bort.

➔ "2. Ta bort förpackningsmaterial" på sida 1



FINE-kassetterna är inte korrekt installerade.

➔ "4. Installera FINE-kassetterna" på sida 2

För alla övriga fall kan du läsa **Onlinehandbok**.

Vilken enhet ansluter du?



Dator



Dator och
smarttelefon



Smarttelefon

5-a

Ansluta till dator

Om du använder flera datorer utför du dessa steg på varje dator.



- 1 Gå till Canons webbplats på datorn.
 <https://ij.start.canon>
- 2 Välj  **Konfigurera**.
- 3 Mata in skrivarens modellnamn och klicka på **Kör**.
- 4 Klicka på **Starta**.
- 5 Klicka på **(B) Ansluta till en dator/smarttelefon**.
 - Följande steg gäller för Windows-användare.
- 6 Klicka på **Hämta**.
- 7 Starta den hämtade filen.
 - Följ instruktionerna på skärmen.
 - Dessa åtgärder kan ta en stund.
 - Om du även vill ansluta till en smarttelefon läser du "5-b. Ansluta till en smarttelefon" på sida 5.

5-b

Ansluta till en smarttelefon

Om du använder flera smarttelefoner utför du dessa steg på varje smarttelefon.

**1** Installera appen "Canon PRINT Inkjet/SELPHY" på smarttelefonen.

- Sök efter "Canon PRINT" i App Store eller Google Play.
- Öppna Canons webbplats för att hämta appen.

**2** Öppna den installerade appen och följ anvisningarna i appen för att lägga till skrivaren.

När du har lagt till skrivaren kan du skriva ut från din smarttelefon.
Om du vill skriva ut foton läser du "Lägga i papper" på sida 6.

Lägga i papper

- 1 Öppna pappersstödet.

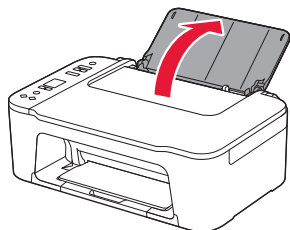

- 2 Skjut pappersledaren åt vänster.

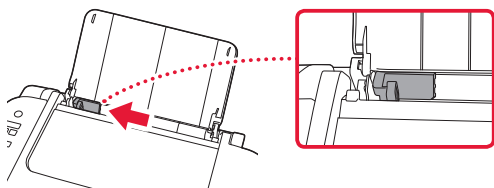

- 3 Lägg i flera ark papper mot den högra kanten med utskriftssidan uppåt och rikta in pappersledaren med papperets bredd.

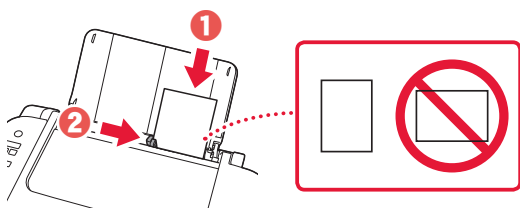

- 4 Tryck på knappen **Välj papper (Paper Select)**, välj en pappersstorlek och tryck sedan på **OK**.

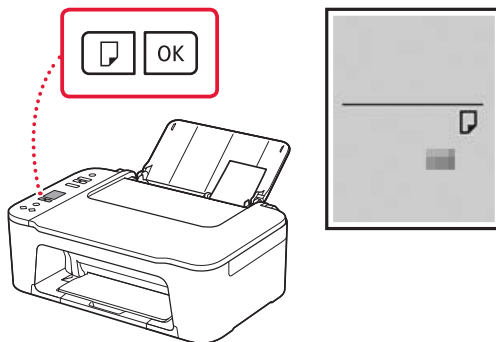

- 5 Dra ut utmatningsfacket och öppna utmatningsfackets förlängningsdel.



- Kontrollera från sidan att det ser ut som på bilden.

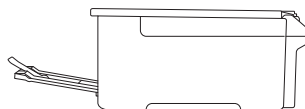

Om utskriftsresultatet inte är tillfredsställande

Utför Justering av skrivhuvud (Print Head Alignment) om raka linjer är ojämna eller om färger är flammiga, eller om utskriftsresultaten på något annat vis inte blir som förväntat.

Klicka på **Underhåll** på **Onlinehandbok** och **Om utskriften är svag eller ojämn** > **Justera Skrivhuvud** för mer information.

Se baksidan för information om att komma åt **Onlinehandbok**.

- Linjer är feljusterade

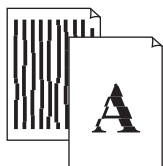

- Ojämma eller randiga färger



Konfigurere skriveren



For oppsett, besøk følgende URL

<https://ij.start.canon>

eller skann koden med mobilenheten



• Hvis du ikke har en internett-tilkobling, kan du følge instruksjonene nedenfor.

1. Innhold i esken

• FINE-kassetter

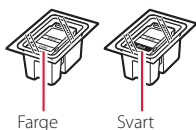

• Strømledning

• Sikkerhetsinformasjon og viktig informasjon

• Komme i gang (denne manualen)

2. Fjerning av beskyttelsesmateriale



1 Fjern den oransje tapen på høyre side, og åpne dekelet.

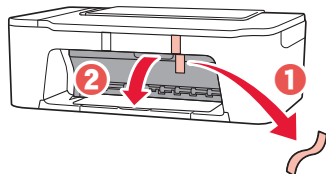

2 Fjern den oransje tapen på venstre side.

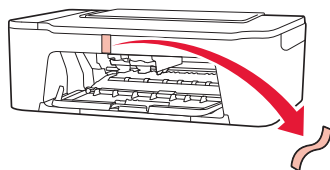

3 Lukk dekelet.

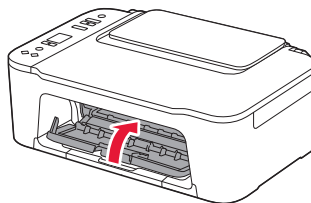

3. Slå på skriveren



1 Koble til strømledningen.

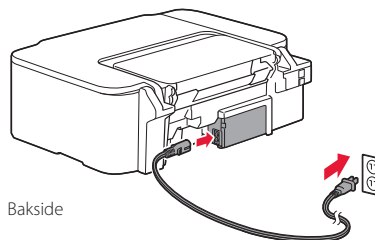

2 Trykk på **PÅ (ON)**-knappen.

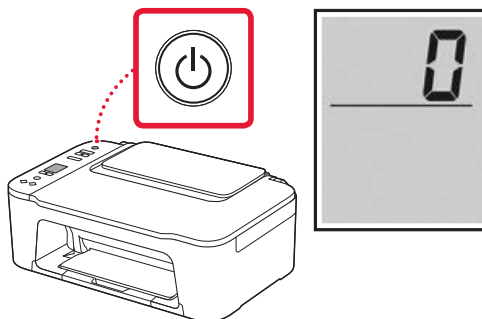

Viktig!

Hvis en annen skjerm vises, må du se "Hvis et av følgende skjermbilder kommer opp" på side 3 og følge instruksjonene.

Konfigurere skriveren

4. Installere FINE-kassetten



1 Åpne dekkelet.

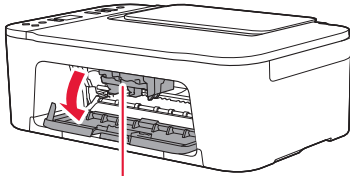

⚠ Forsiktig!

Ikke berør FINE-kassettholderen før den slutter å bevege seg.

2 Senk låsehendelen for blekkassetter på venstre side.

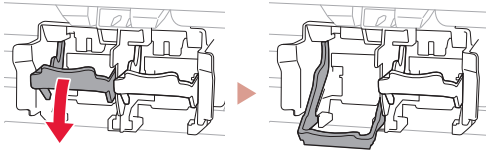

3 Ta FINE-kassetten for farge ut av pakken og fjern beskyttelsestapen.

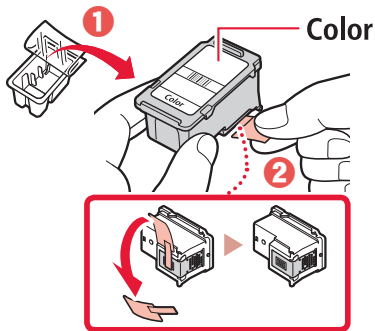

»»» Viktig!

- Ikke berør blekket på den beskyttende tapen. Det kan sette flekker på hendene dine eller andre gjenstander.
- Ikke berør områdene som er vist på figuren. Skriveren vil ellers ikke kunne skrive ut riktig.

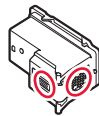

4 Sett inn FINE-kassetten med farger i FINE-kassettholderen.

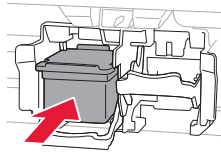

»»» Viktig!

Ikke dunk på FINE-kassetten. Dette kan føre til at det oppstår en feil.



5 Hev låsehendelen for blekkassetter.

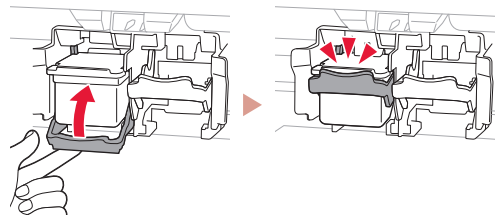

6 Gjenta trinn 2 til 5 og installer den svarte FINE-kassetten på høyre side.

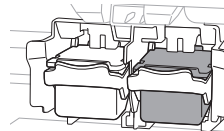

7 Lukk dekkelet.

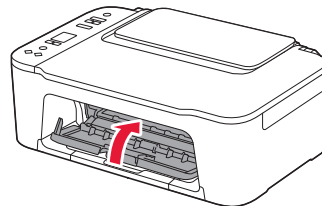

8 Sjekk at følgende skjermbilde vises.



»»» Viktig!

Hvis E > 0 > 4 vises på skjermen, må du se "Hvis et av følgende skjermbilder kommer opp" på side 3 og følge instruksjonene.

Velg tilkoblingsmetoden som passer best til hvordan du skal bruke skriveren.

- For å bruke skriveren uten å koble den til andre enheter
➔ Oppsettet er nå ferdig.
- Bruke skriveren ved å koble til en datamaskin eller smarttelefon
➔ Gå videre til neste side.



Hvis et av følgende skjermbilder kommer opp

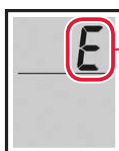

Tall eller bokstaver

Kontroller skjermen, og følg deretter de tilsvarende instruksjonene nedenfor.



Installer FINE-kassetten.

➔ "4. Installere FINE-kassetten" på side 2



Gjenstående beskyttelsesmateriale.

➔ "2. Fjerning av beskyttelsesmateriale" på side 1



FINE-kassetten er ikke korrekt installert.

➔ "4. Installere FINE-kassetten" på side 2

Se **Nettbasert manual** for alle andre tilfeller.

Hvilken enhet kobler du til?



Datamaskin



Datamaskin og
smarttelefon



Smarttelefon

5-a

Koble til en datamaskin

Hvis du bruker flere datamaskiner, utfører du disse trinnene på hver datamaskin.



- 1 Åpne Canon-nettstedet fra datamaskinen.
 <https://ij.start.canon>
- 2 Velg  **Oppsett**.
- 3 Angi skriverens modellnavn og klikk på **Gå**.
- 4 Klikk på **Start**.
- 5 Klikk på **(B) Koble til en datamaskin/smarttelefon**.
 - Følgende trinn gjelder Windows-brukere.
- 6 Klikk på **Last ned**.
- 7 Kjør den nedlastede filen.
 - Følg instruksjonene på skjermen.
 - Disse operasjonene kan ta litt tid.
 - Se "5-b. Koble til en smarttelefon" på side 5 hvis du i tillegg vil koble til en smarttelefon.

5-b

Koble til en smarttelefon

Hvis du bruker flere smarttelefoner, utfører du disse trinnene på hver smarttelefon.



1 Installer "Canon PRINT Inkjet/SELPHY"-appen på smarttelefonen.



- Søk etter "Canon PRINT" i App Store eller Google Play.
- Åpne Canon-nettsiden for å laste ned appen.



2 Åpne den installerte appen og følg deretter instruksjonene i appen for å legge til skriveren.



Når du har lagt til skriveren din, kan du skrive ut fra smarttelefon.

Se "Legge i papir" på side 6 for å skrive ut bilder.

Legge i papir

1 Åpne papirstøtten.

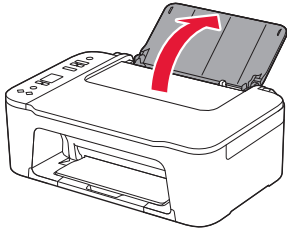

2 Dra papirføreren til venstre.

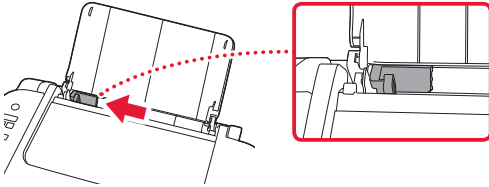

3 Legg inn flere ark med papir mot høyre kant og med utskriftssiden opp, og juster papirføreren etter bredden på papiret.

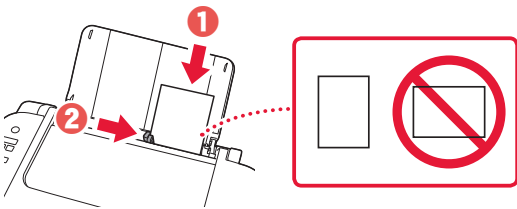

4 Trykk på **Velg papir (Paper Select)**-knappen, velg en papirstørrelse, og trykk deretter på **OK**-knappen.

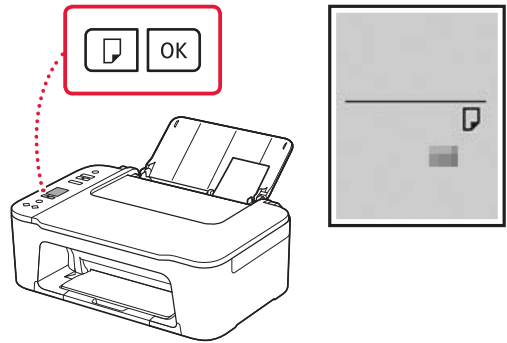

5 Forleng papirutmatingsbrettet, og åpne mottakerbrettforlengelsen.

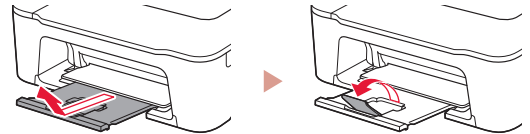

• Sjekk at alt ser ut som på skjemaet sett fra siden.

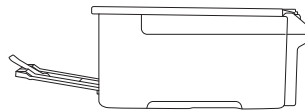

Hvis utskriftsresultatene ikke er tilfredsstillende

Utfør Justering av skrivehodet (Print Head Alignment) hvis rette linjer er bøyd, farger er ujevne eller utskriftsresultatene på annen måte ikke ble slik du forventet.

Hvis du vil ha mer detaljer, klikker du på **Vedlikehold** på **Nettbasert manual** og ser **Hvis utskriften er svak eller ujevn > Justere Skrivehodet**.

Se bakdekselet for informasjon om hvordan du får tilgang til **Nettbasert manual**.

■ Linjer er feiljusterte



■ Ujevne eller stripete farger



Konfigurere printeren



Ved opsætning: Gå til URL-adressen

<https://ij.start.canon>

eller scan koden med din mobilenhed



• Følg instruktionerne nedenfor, hvis du ikke har en internetforbindelse.

1. Æskens indhold

• FINE-patroner

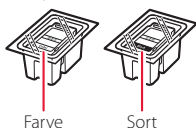

• Netledning

• Sikkerhedsoplysninger og vigtige oplysninger

• Før du begynder (denne vejledning)

2. Fjern emballage



1 Fjern den orange tape til højre, og åbn dækslet.

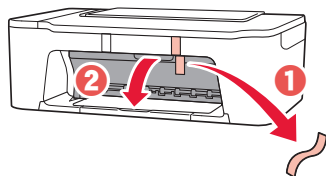

2 Fjern den orange tape til venstre.

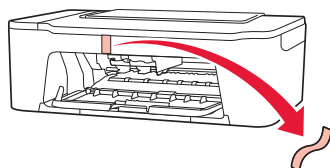

3 Luk dækslet.

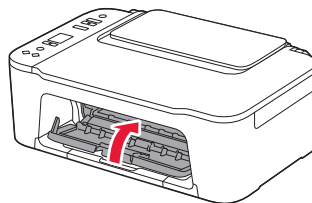

3. Tænd printeren



1 Tilslut netledningen.

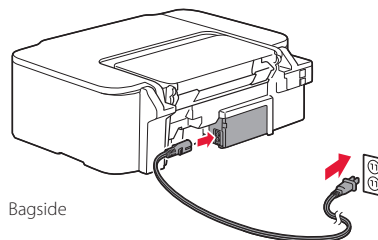

2 Tryk på knappen **TIL (ON)**.

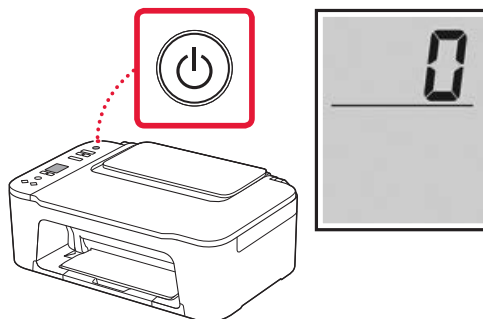

Vigtigt

Hvis der vises et andet skærbillede, skal du se "Hvis nogle af følgende skærbilleder vises" på side 3 og følge instruktionerne.

Konfigurere printeren

4. Installation af FINE-patroner



1 Åbn dækslet.

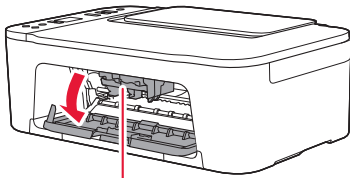

⚠ Forsigtig

Undgå at røre ved FINE-patronholderen, før den stopper.

2 Sænk låsehåndtaget til blækpatronen på venstre side.

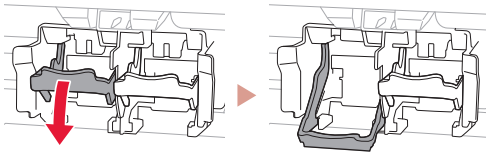

3 Tag farve-FINE-patronen ud af pakken, og fjern beskyttelsestapen.

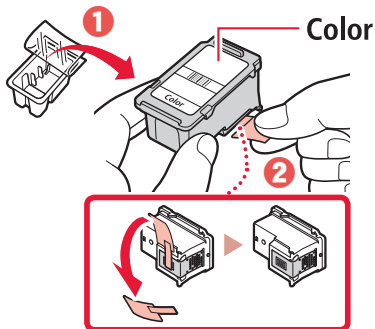

»»» Vigtigt

- Rør ikke ved blækket på den beskyttende tape. Det kan give pletter på dine hænder og genstande i nærheden.
- Rør ikke de områder, der vises på figuren. Hvis du gør det, kan printeren muligvis ikke udskrive korrekt.

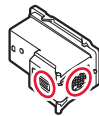

4 Indsæt farve-FINE-patronen i FINE-patronholderen.

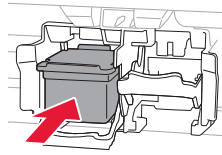

»»» Vigtigt

Pas på, at du ikke kommer til at støde FINE-patronen mod noget. Det kan medføre funktionsfejl.



5 Løft låsehåndtaget til blækpatronen.

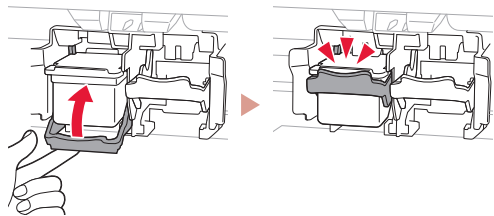

6 Gentag trin 2 til 5, og indsæt den sorte FINE-patron til højre.

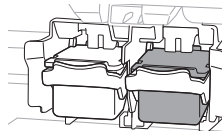

7 Luk dækslet.

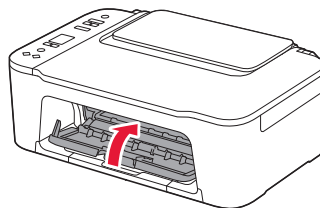

8 Tjek, at følgende skærbillede vises.



»»» **Vigtigt**

Hvis E > 0 > 4 vises på skærmen, skal du se "Hvis nogle af følgende skærbilleder vises" på side 3 og følge instruktionerne.

Vælg den forbindelsesmetode, der passer bedst til den måde, du vil bruge printerens på.

- For at bruge printerens uden tilslutning af andre enheder
 - ➔ Opsætningen er nu fuldført.
- For at bruge printerens ved at tilslutte til en computer eller smartphone
 - ➔ Fortsæt på næste side.

? Hvis nogle af følgende skærbilleder vises

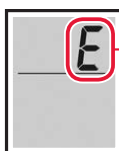

Tal eller bogstaver

Tjek skærbilledet, og følg de relevante instruktioner nedenfor.



Indsæt FINE-patronerne.

➔ "4. Installation af FINE-patroner" på side 2



Der er stadig noget beskyttende materiale.

➔ "2. Fjern emballage" på side 1



FINE-patronerne er ikke isat korrekt.

➔ "4. Installation af FINE-patroner" på side 2

I alle andre tilfælde skal du se i **Online vejledning**.

Hvilken enhed tilslutter du?



Computer



Computer og
smartphone





Smartphone

5-a

Tilslutning til en computer

Hvis du bruger flere computere, skal du udføre disse trin på hver computer.



- 1 Gå til Canon-webstedet fra din computer.
 <https://ij.start.canon>
- 2 Vælg  **Konfiguration**.
- 3 Skriv printerens modelnavn, og klik på **Ok**.
- 4 Klik på **Start**.
- 5 Klik på **(B) Tilslutning til en computer/smartphone**.
 - Følgende trin gælder for Windows-brugere.
- 6 Klik på **Hent**.
- 7 **Kør den downloadede fil**.
 - Følg instruktionerne på skærmen.
 - Disse handlinger kan tage lidt tid.
 - Hvis du også vil tilslutte en smartphone, skal du se "5-b. Tilslutning til en smartphone" på side 5.

5-b

Tilslutning til en smartphone

Hvis du bruger flere smartphones, skal du udføre disse trin på hver smartphone.



1 Installer appen "Canon PRINT Inkjet/SELPHY" på din smartphone.



- Søg efter "Canon PRINT" i App Store eller Google Play.
- Gå til Canon-webstedet for at downloade appen.



2 Åbn den installerede app, og følg instruktionerne på skærmen i appen for at tilføje din printer.



Når du har tilføjet din printer, kan du udskrive fra din smartphone.
Hvis du vil udskrive fotos, skal du se "Ilægning af papir" på side 6.

Ilægning af papir

- 1 Åbn papirstøtten.

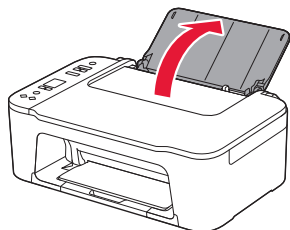

- 2 Skub papirstyret til venstre.

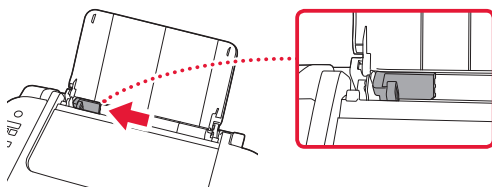

- 3 Ilæg flere ark papir mod højre kant med udskriftssiden opad, og juster papirstyret med bredden af papiret.

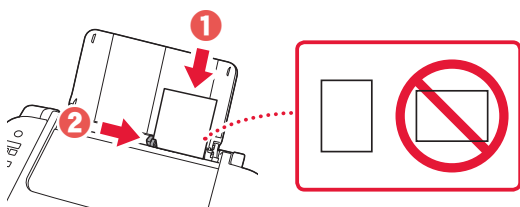

- 4 Tryk på knappen **Valg af papir (Paper Select)**, vælg en papirstørrelse, og tryk derefter på knappen **OK**.

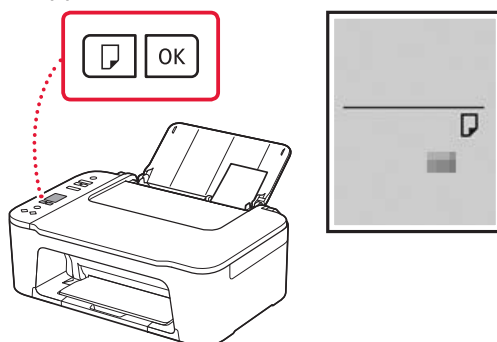

- 5 Træk udbakken til papir ud, og åbn forlængeren til udbakken.



- Kig på printeren fra siden, og bekræft, at det ser ud som på tegningen.

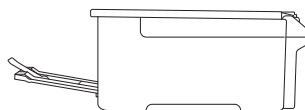

Hvis udskriftsresultaterne ikke er tilfredsstillende

Udfør Printheadjustering (Print Head Alignment), hvis lige linjer f.eks. er skæve, eller farverne afviger, eller hvis udskriftsresultaterne på anden måde ikke er som forventet.

Du kan få flere oplysninger ved at klikke på **Vedligeholdelse** i **Online vejledning** og se **Hvis udskrivningen er bleg eller ujævn > Justering af Printhead**.

Se på bagsiden, hvordan du får adgang til **Online vejledning**.

- Linjer er skæve

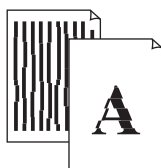

- Ujævne eller stribede farver



Tulostimen asennus



Lisätietoja asennuksesta saat URL-osoitteesta

<https://ij.start.canon>

tai skannaamalla koodin mobiililaitteellasi



•Toimi alla olevien ohjeiden mukaisesti, jos käytettävissä ei ole Internet-yhteyttä.

1. Paketin sisällys

• FINE-kasetit

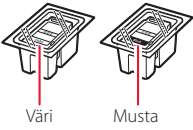

• Virtajohto

• Turvallisuus ja tärkeitä tietoja

• Aloitusopas (tämä käyttöopas)

2. Pakkausmateriaalien poistaminen



1 Poista oranssi teippi oikealta puolelta ja avaa kansi.

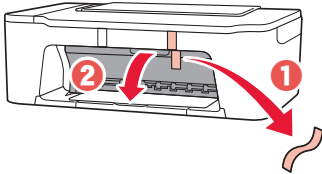

2 Irrota oranssi teippi vasemmalta puolelta.

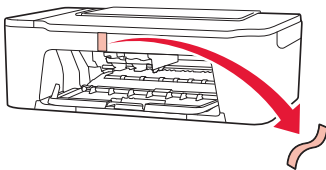

3 Sulje kansi.

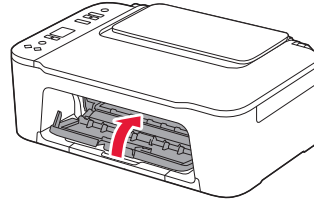

3. Virran kytkeminen tulostimeen



1 Kytke virtajohto.

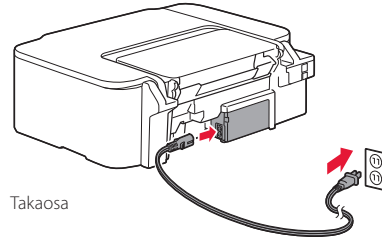

Takaosa

2 Paina **KÄYTÖSSÄ (ON)** -painiketta.

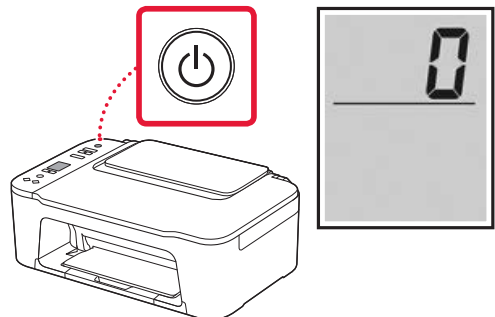

»»» Tärkeää

Jos jokin toinen näyttö avautuu, katso "Jos seuraava näyttö tulee näkyviin" sivulla 3 ja noudata ohjeita.

Tulostimen asennus

4. FINE-kasettien asentaminen



1 Avaa kansi.

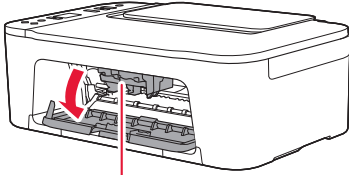

▲ Huomio

Älä koske FINE-kasetin pidikkeeseen, ennen kuin se pysähtyy.

2 Laske mustekasetin lukitusvipu alas vasemmalta puolelta.

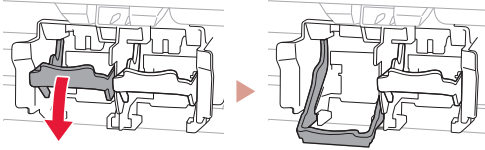

3 Poista värillinen FINE-kasetti pakkauksesta ja irrota suojaiteppi.

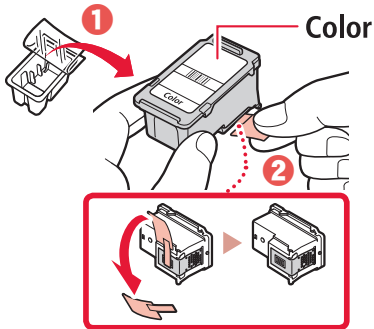

»»» Tärkeää

- Älä koske suojaitepissä olevaan musteeseen. Se saattaa liata kätesi tai ympärillä olevia esineitä.
- Älä koske kuvassa merkittyihin alueisiin. Tulostin välttämättä tulosta muussa tapauksessa oikein.

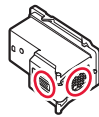

4 Aseta värillinen FINE-kasetti FINE-kasetin pidikkeeseen.

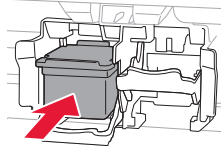

»»» Tärkeää

Älä pumpppaa FINE-kasettia. Se voi aiheuttaa toimintahäiriön.



5 Nosta mustekasetin lukitusvipu ylös vasemmalta puolelta.

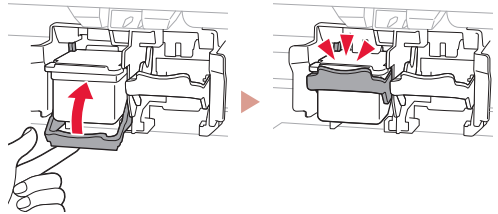

6 Toista vaiheet 2–5 ja asenna musta FINE-kasetti oikealle.

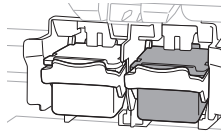

7 Sulje kansi.

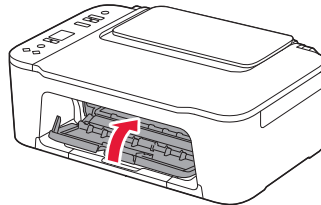

8 Tarkista, että seuraava näyttö tulee näkyviin.



»»» Tärkeää

Jos E > 0 > 4 näkyy näytössä, katso "Jos seuraava näyttö tulee näkyviin" sivulla 3 ja noudata ohjeita.

Valitse yhteysmenetelmä, joka parhaiten vastaa tulostimen käyttötapaa.

- Tulostimen käyttö ilman yhteyttä muihin laitteisiin
➔ Asennus on nyt valmis.
- Tulostimen käyttö tietokone tai älypuhelin yhdistettynä
➔ Jatka seuraavalta sivulta.



Jos seuraava näyttö tulee näkyviin

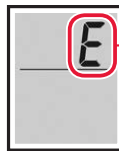

Numeroita tai kirjaimia

Tarkista näyttö, ja noudata alla olevia vastaavia ohjeita.



Asenna FINE-kasetit.

➔ "4. FINE-kasettien asentaminen" sivulla 2



Suojamateriaalia jäljellä.

➔ "2. Pakkausmateriaalien poistaminen" sivulla 1



FINE-kasetteja ei ole asennettu oikein.

➔ "4. FINE-kasettien asentaminen" sivulla 2

Katso kaikissa muissa tapauksissa lisätietoja **Online-käyttöopas**-ohjeesta.

Mitä laitetta olet yhdistämässä?



Tietokone



Tietokone ja
älypuhelin



Älypuhelin

5-a

Yhdistäminen tietokoneeseen

Jos käytät useita tietokoneita, suorita nämä vaiheet jokaiselle tietokoneelle.



- 1 Avaa tietokoneesta Canon-verkkosivusto.
 <https://ij.start.canon>
- 2 Valitse  **Määrittys**.
- 3 Anna tulostinmallin nimi ja valitse **Siirry**.
- 4 Valitse **Aloita**.
- 5 Valitse **(B) Yhdistäminen tietokoneeseen/älypuhelimeen**.
 - Seuraavat vaiheet ovat Windows-käyttäjille.
- 6 Valitse **Lataa**.
- 7 Suorita ladattu tiedosto.
 - Noudata näytön ohjeita.
 - Näissä toiminnoissa voi kestää hetken.
 - Jos haluat liittää myös älypuhelimien, katso kohta "5-b. Yhdistäminen älypuhelimeen" sivulla 5.

5-b

Yhdistäminen älypuhelimien

Jos käytät useita älypuhelimia, suorita nämä vaiheet jokaiselle älypuhelimelle.



1 Asenna "Canon PRINT Inkjet/SELPHY" -sovellus älypuhelimien.



- Etsi App Store- tai Google Play -kaupassa tekstiä "Canon PRINT".
- Lataa sovellus avaamalla ensin Canon-sivusto.



2 Avaa asennettu sovellus ja lisää sitten tulostin noudattamalla sovelluksen näytön ohjeita.



Kun olet lisännyt tulostimen, voit tulostaa älypuhelimien.

Jos tulostat valokuvia, katso kohtaa "Paperin asettaminen" sivulla 6.

Paperin asettaminen

1 Avaa paperituki.

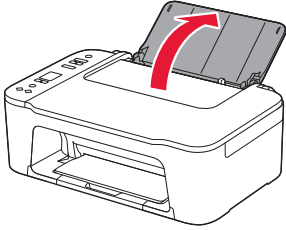

2 Liu'uta paperiohjain vasemmalle.

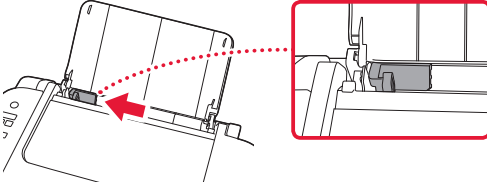

3 Aseta useita arkkeja paperia oikeaa reunaa vasten tulostuspuoli ylöspäin, ja kohdista sitten paperiohjain paperin leveyteen.

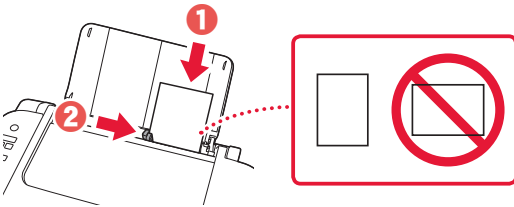

4 Paina **Valitse paperi (Paper Select)** -painiketta, valitse paperikoko ja paina sitten **OK** -painiketta.

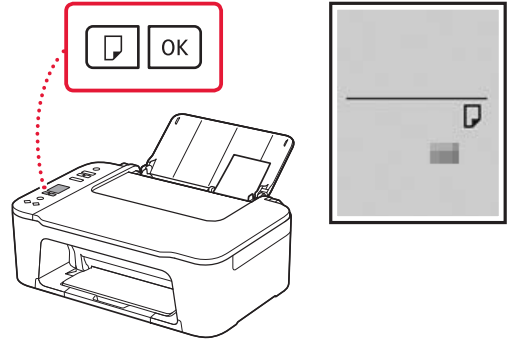

5 Laajenna paperin luovutustaso ja avaa sitten luovutustason jatke.

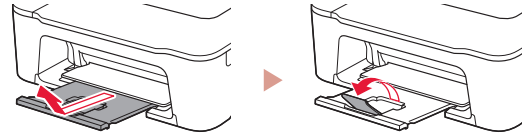

- Katso sitä sivulta ja varmista, että se on kaavion kaltainen.

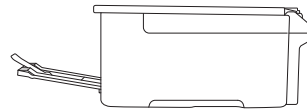

Jos tulostusjälki ei ole tyydyttävä

Suorita Tulostuspään kohdistus (Print Head Alignment), jos suorat viivat tai värit ovat epäyhtenäisiä tai tulostustulokset eivät muutoin täytä odotuksia.

Saat lisätietoja valitsemalla **Huolto**-käyttöoppaasta kohdan **Online-käyttöopas** ja valitsemalla **Jos tulostus on himmeä tai epätasainen > Tulostuspään kohdistaminen**.

Takakannessa on ohjeet **Online-käyttöopas**-käyttöoppaan avaamiseen.

■ Viivat tulostuvat vinoon

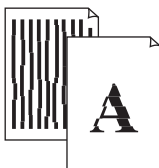

■ Värit ovat epätasaisia tai juovikkaita



Trademarks

- Windows is a trademark or registered trademark of Microsoft Corporation in the U.S. and/or other countries.
- App Store is a trademark of Apple Inc., registered in the U.S. and other countries.
- Google Play is a registered trademark of Google LLC.

Marques

- Windows est une marque ou une marque déposée de Microsoft Corporation aux États-Unis et/ou dans d'autres pays.
- App Store est une marque d'Apple Inc., déposées aux États-Unis et dans d'autres pays.
- Google Play est une marque déposée de Google LLC.

Marken

- Windows ist eine Marke oder eine eingetragene Marke der Microsoft Corporation in den USA und/oder anderen Ländern.
- App Store ist eine Marke von Apple Inc. in den USA und anderen Ländern.
- Google Play ist eine eingetragene Marke von Google LLC.

Handelsmerken

- Windows is een handelsmerk of gedeponeerd handelsmerk van Microsoft Corporation in de Verenigde Staten en/of andere landen.
- App Store is een handelsmerk van Apple Inc., gedeponeerd in de V.S. en andere landen.
- Google Play is een gedeponeerd handelsmerk van Google LLC.

Marchi

- Windows è un marchio commerciale o marchio registrato di Microsoft Corporation, registrato negli Stati Uniti e/o in altri Paesi.
- App Store è un marchio di Apple Inc., registrati negli Stati Uniti e in altri paesi.
- Google Play è un marchio registrato di Google LLC.

Marcas registradas

- Windows é uma marca comercial ou marca registrada da Microsoft Corporation nos EUA e/ou em outros países.
- App Store é uma marca registrada da Apple Inc., registradas nos EUA e em outros países.
- Google Play é uma marca registrada do Google LLC.

Marcas comerciales

- Windows es una marca comercial o marca comercial registrada de Microsoft Corporation, registrada en EE.UU. y/o en otros países.
- App Store es una marca comercial de Apple Inc., registradas en EE.UU. y en otros países.
- Google Play es una marca comercial registrada de Google LLC.

Εμπορικά σήματα

- Η επωνυμία Windows είναι εμπορικό σήμα ή σήμα κατατεθέν της Microsoft Corporation στις Η.Π.Α. ή/και σε άλλες χώρες.
- App Store είναι εμπορικό σήμα της Apple Inc., καταχωρημένα στις ΗΠΑ και σε άλλες χώρες.
- Το Google Play είναι σήμα κατατεθέν της Google LLC.

Varumärken

- Windows Vista är ett varumärke eller registrerat varumärke som tillhör Microsoft Corporation i USA och/eller andra länder.
- App Store är ett varumärke som tillhör Apple Inc. och som är registrerade i USA och andra länder.
- Google Play är ett registrerat varumärke som tillhör Google LLC.

Varemerker

- Windows er et varemerke eller et registrert varemerke for Microsoft Corporation i USA og/eller andre land.
- App Store er et varemerke for Apple Inc., registrert i USA og andre land.
- Google Play er et registrert varemerke for Google LLC.

Varemærker

- Windows er et varemærke eller et registreret varemærke tilhørende Microsoft Corporation i USA og/eller andre lande.
- App Store er et varemærke, der tilhører Apple Inc., som er registreret i USA og andre lande.
- Google Play er et registreret varemærke tilhørende Google LLC.

Tavaramerkit

- Windows on Microsoft Corporationin tavaramerkki tai rekisteröity tavaramerkki Yhdysvalloissa ja/tai muissa maissa.
- App Store ovat Apple Inc. -yhtiön tavaramerkejä, jotka on rekisteröity Yhdysvalloissa ja muissa maissa.
- Google Play on Google LLC:n rekisteröity tavaramerkki.



Access Online Manual
Zugriff auf das Online-Handbuch
Accedere al Manuale online
Acceso al Manual en línea
Läs Onlinehandbok
Åbn Online vejledning

Accès au Manuel en ligne
Online handleiding openen
Acesse o Manual On-line
Αποκτήστε πρόσβαση στο Εγχειρίδιο Online
Gå til Nettbasert manual
Online-käyttöopas-oppaan käyttö

From your browser

À partir de votre navigateur

Über Ihren Browser

Via de browser

Dal browser

Do seu navegador

Desde su navegador

Από το πρόγραμμα περιήγησής σας

Från webbläsaren

Fra nettleseren din

Fra din browser

Selaimesta

