



RAZER KIYO V2 X

MASTER GUIDE

CONTENTS

1. WHAT'S INSIDE.....	2
2. WHAT'S NEEDED.....	4
3. LET'S GET YOU COVERED.....	4
4. GETTING STARTED.....	5
5. CONFIGURING YOUR RAZER KIYO V2 X VIA RAZER SYNAPSE.....	7
6. SAFETY AND MAINTENANCE.....	20
7. LEGALESE.....	21

1. WHAT'S INSIDE

- Razer Kiyo V2 X

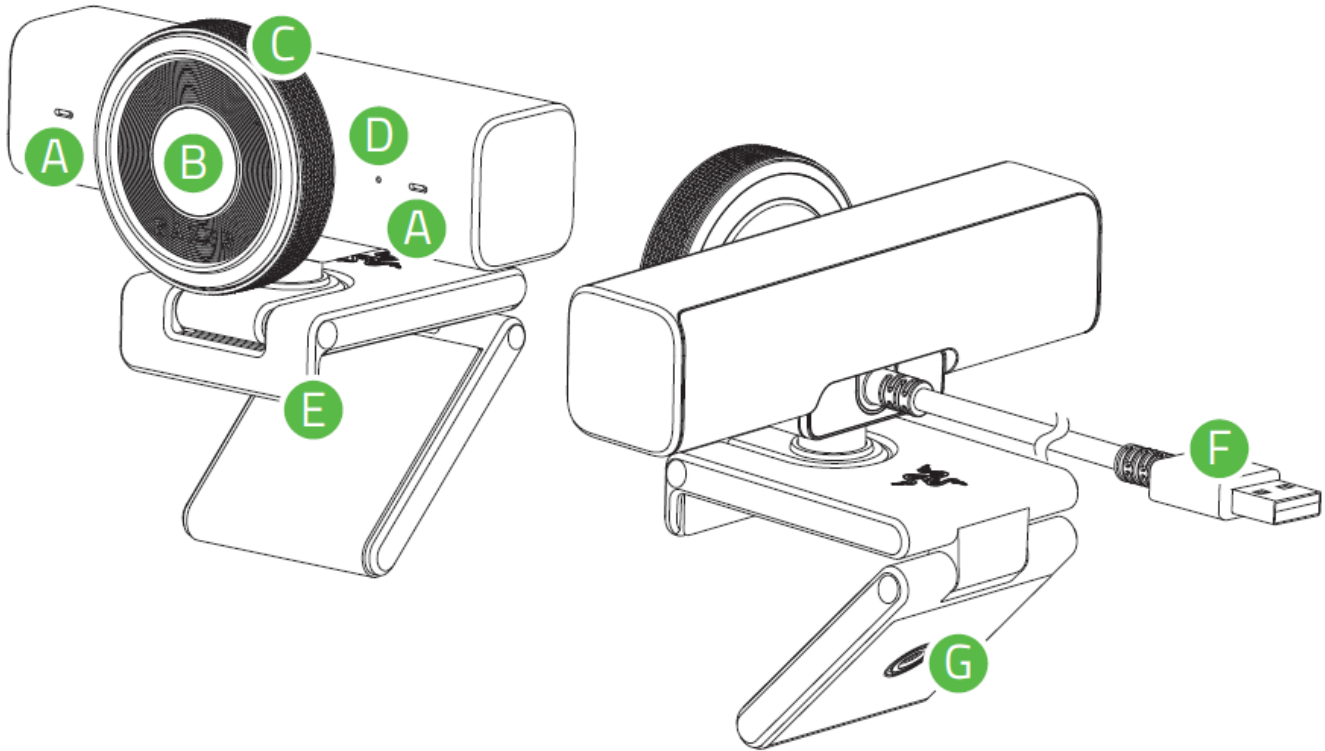

- A. Built-in dual microphone
- B. Wide Angle lens with software-adjustable Field of View (FoV)
- C. Privacy shutter dial
- D. Status indicator
- E. Adjustable clip/stand
- F. USB 2.0 Type A connector
- G. Camera thread mount

- Important Product Information Guide

2. WHAT'S NEEDED

PRODUCT REQUIREMENTS

- Direct USB Type A connection
- Windows® 10 64-bit (or higher)
- macOS 14 (or higher)

RAZER SYNAPSE REQUIREMENTS

- Internet connection for software installation

3. LET'S GET YOU COVERED

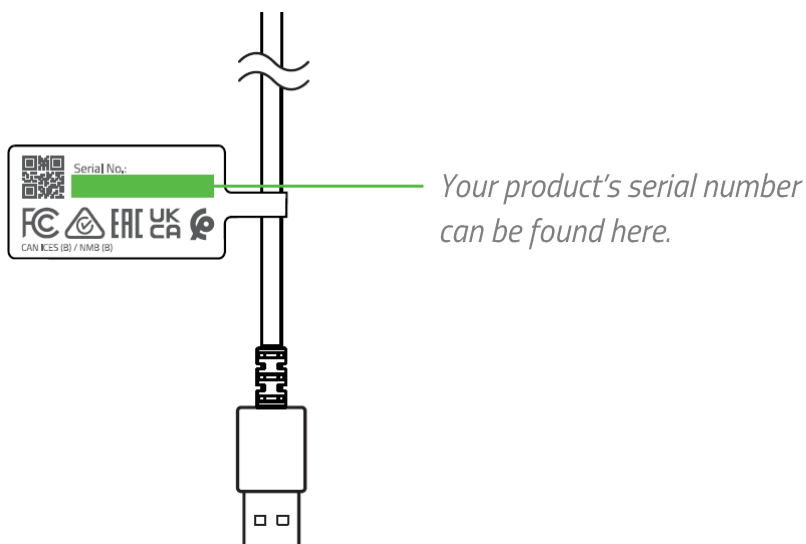

You've got a great device — now make it even better. Register your device at razerid.razer.com to get covered and unlock exclusive Razer benefits.

i A valid Proof of Purchase is required for any Limited Warranty Claim.

4. GETTING STARTED

POSITION YOUR CAMERA

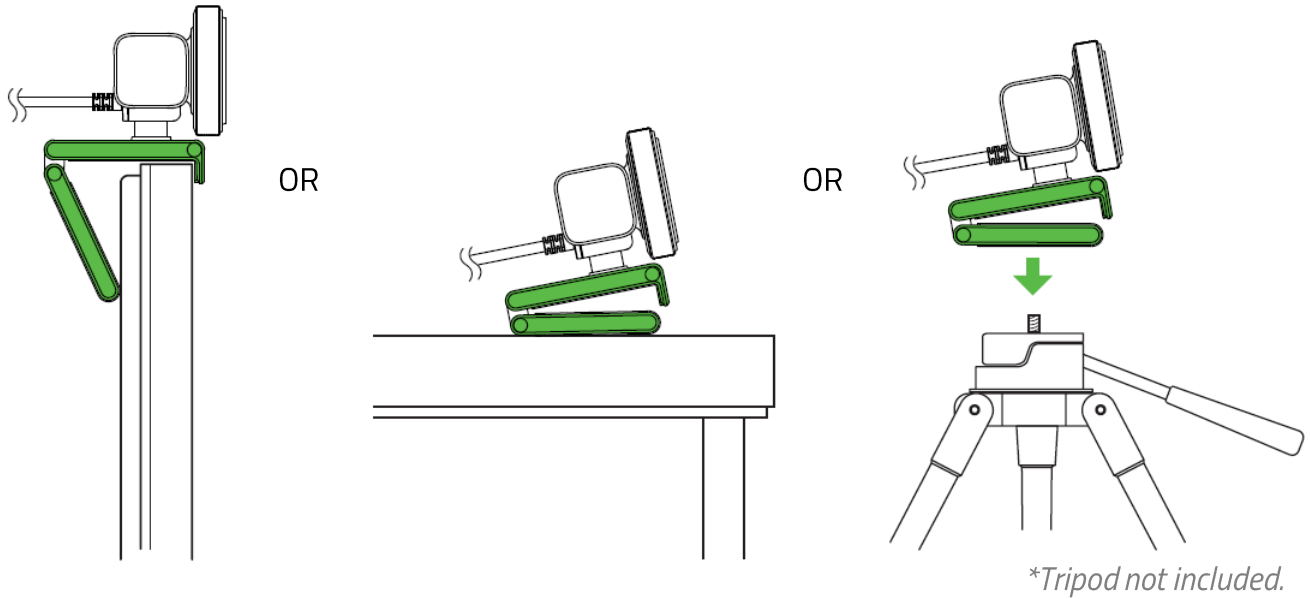

CONNECT TO YOUR PC

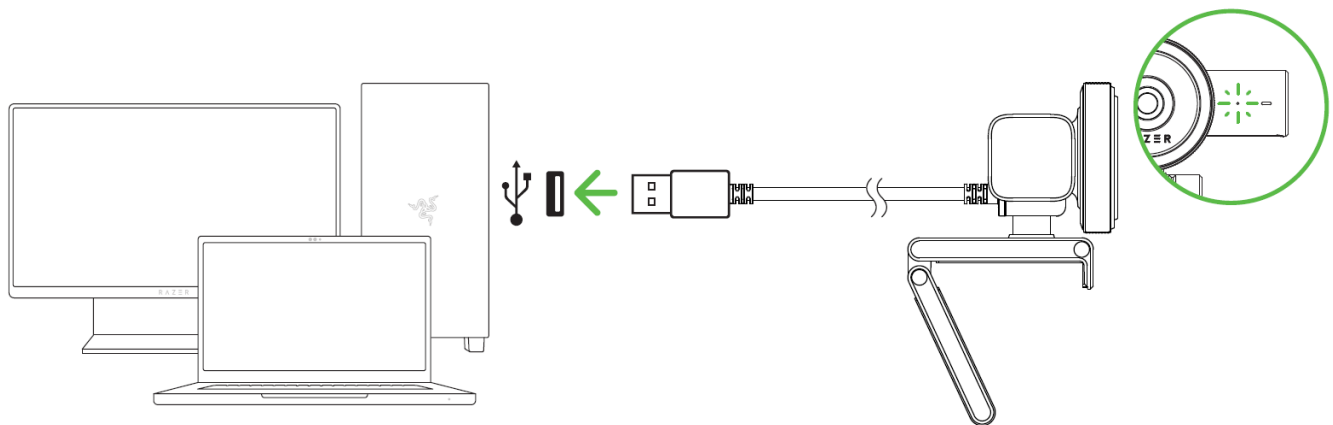

- i** Use only the USB Type C to Type C cable included in the packaging. This cable is not intended for use with other devices. For optimal streaming and recording performance, connect the camera directly to a USB 3.0 port of your PC. Using a USB 2.0 port, USB hub, switch, or extender may decrease its performance.

OPEN THE PRIVACY SHUTTER

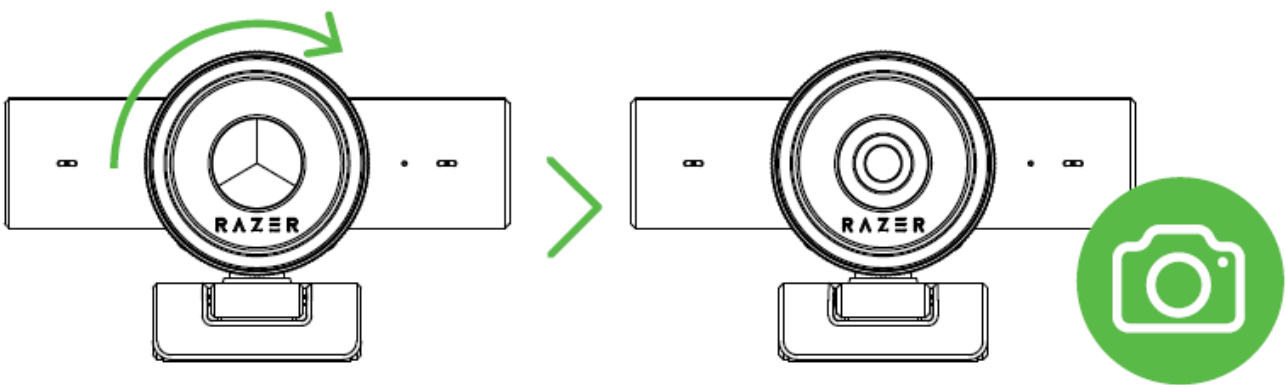
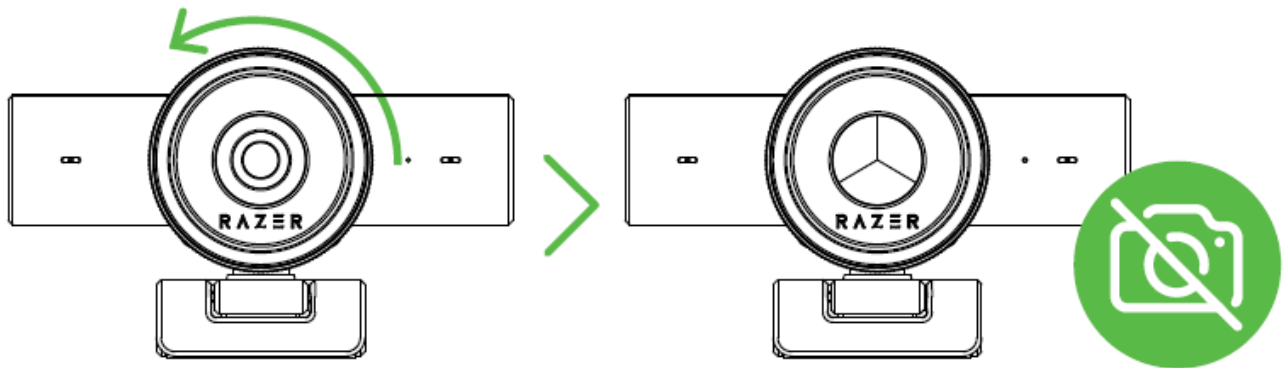

UNLEASH ITS FULL POTENTIAL

Use the Razer Synapse app to personalize camera settings, including FoV, video options, audio effects, and more. Install Razer Synapse when prompted or download its installer from razer.com/synapse

5. CONFIGURING YOUR RAZER KIYO V2 X VIA RAZER SYNAPSE

i *Disclaimer: This guide provides an overview of the New Razer Synapse app and may only partially cover some of the features of your device. The New Razer Synapse requires an Internet connection to install, update, access, and save cloud-based features. Registering for a Razer ID account is recommended but optional. All features listed here are subject to change based on the current version, connected device(s), and supported add-ons.*

SYNAPSE

The Synapse tab is your default tab when you first launch Razer Synapse. Use the following buttons below to navigate the user interface:

– Minimize

Clicking this button will minimize the app to the taskbar while it runs in the background.

□ Maximize

This button expands the browser window to fill the entire screen. To restore the window to its original size, click the maximize button again.

× Close

This button will close all relevant tabs and terminate the application completely.

< Previous Tab

Clicking this button will return you to the last tab you have visited.

> Next Tab

Clicking this button will move you to the next page if you've recently used the Previous Tab button.

↻ Refresh Tab

This button reloads the current page. Use this if a page isn't displaying correctly or you want to see the latest content.

↓ Download Update

If this button appears, that means there are changes to the app. Use this if a page isn't displaying correctly or you want to see the latest content.

More

Clicking this button will open a pop-up so you can easily access your Devices, Modules, and Other Installed Apps tabs.

Settings

Clicking this button will open the Settings tab, so you can quickly change the settings to this app.

Profile

This button will open a pop-up to access the Log In, Feedback, Rate This Software, Add WiFi Device, and Exit options.

Info

Hovering over this button will pop up an additional information about a feature or function.

Dashboard

The Dashboard subtab is an overview of your Razer Synapse, where you can access all your Razer devices, modules, and online services.

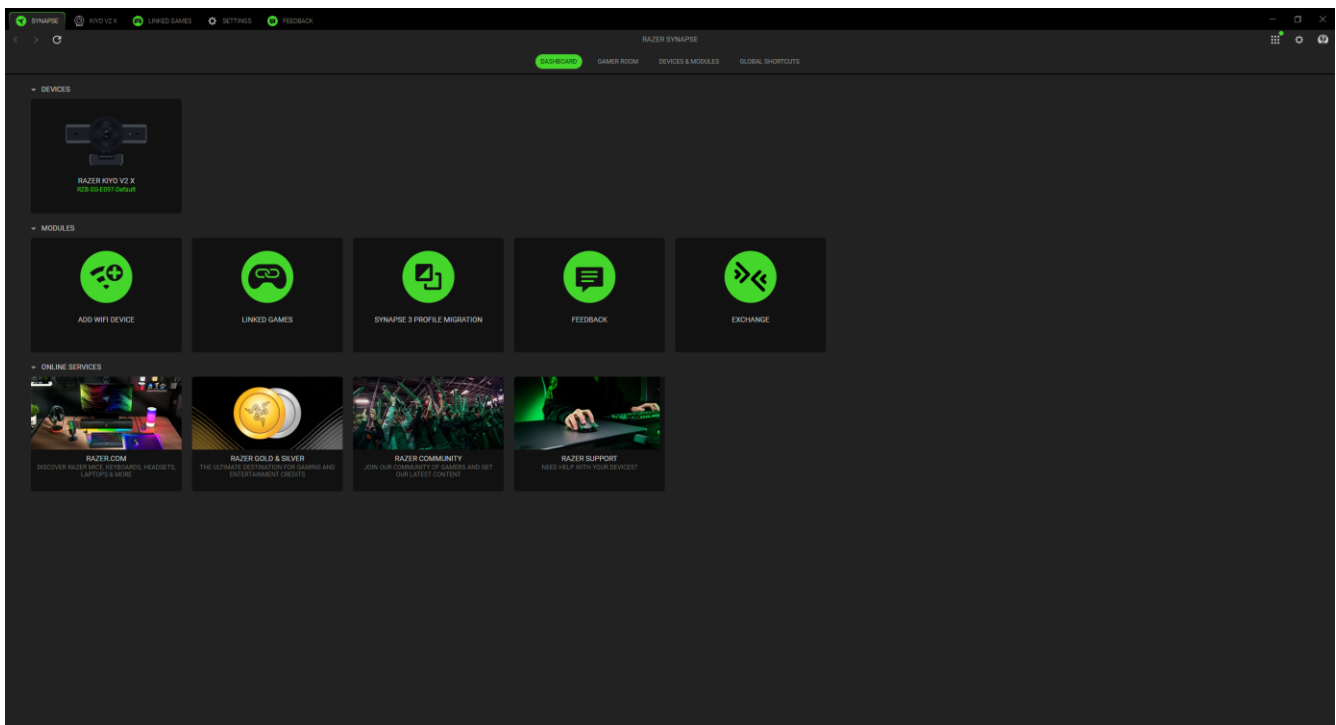

Gamer Room

The Gamer Room subtab shows all devices with the Razer Aether Light feature. From here, you can view and manage your Gamer Room-supported devices.

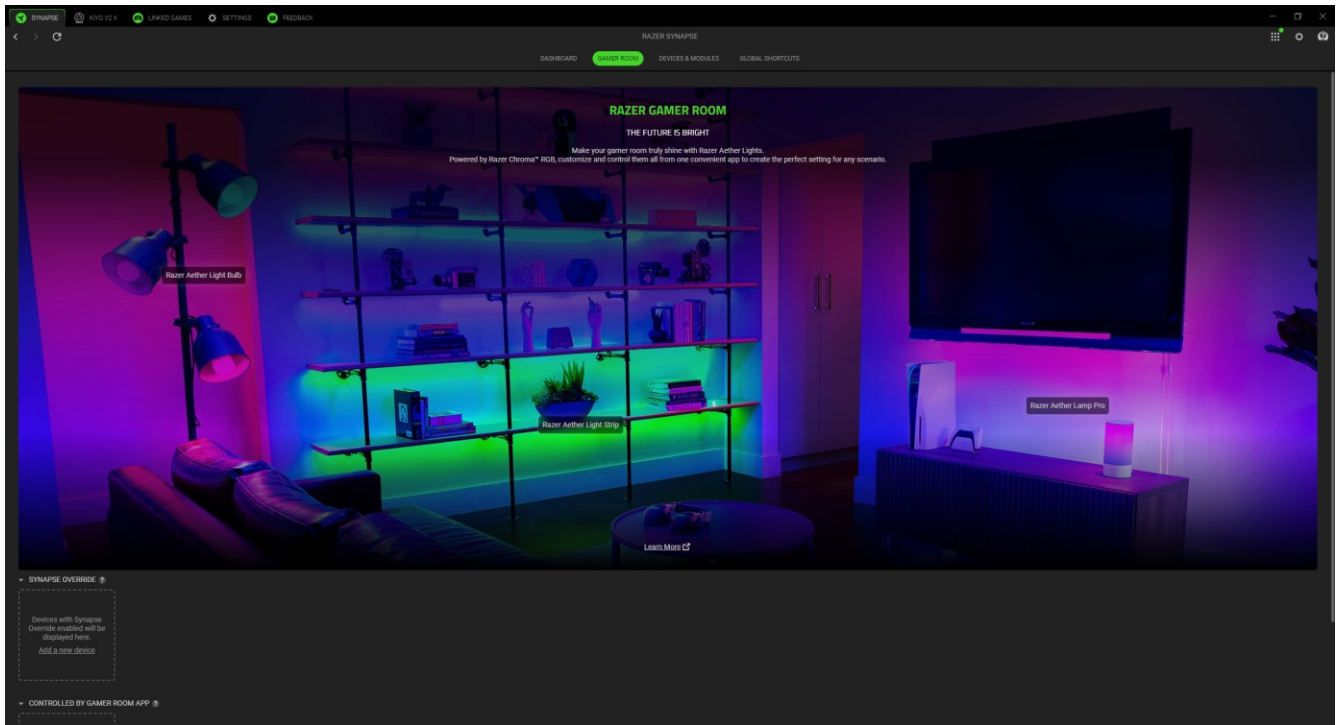

Synapse Override

This section allows you to select and customize your device's lighting and make it react to Chroma-enabled games and Chroma Connect apps using Razer Synapse.

Controlled By Gamer Room App

This section displays all supported devices controlled remotely by the Gamer Room app.

Devices & Modules

The Modules subtab displays all installed and available modules for installation.

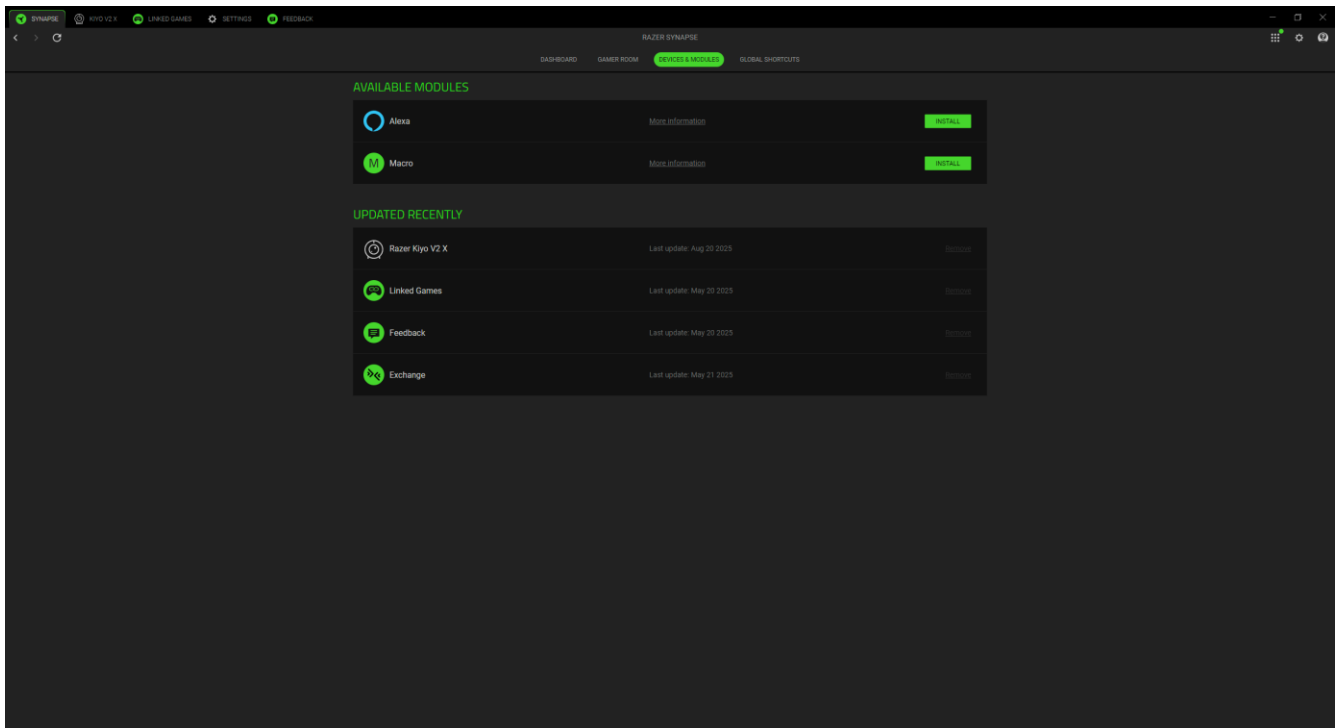

Global Shortcuts

Bind operations or Razer Synapse functions to custom key-combinations from any Razer Synapse-enabled device inputs, which apply across all device profiles.

 *Only Razer Synapse-enabled device inputs will be recognized.*

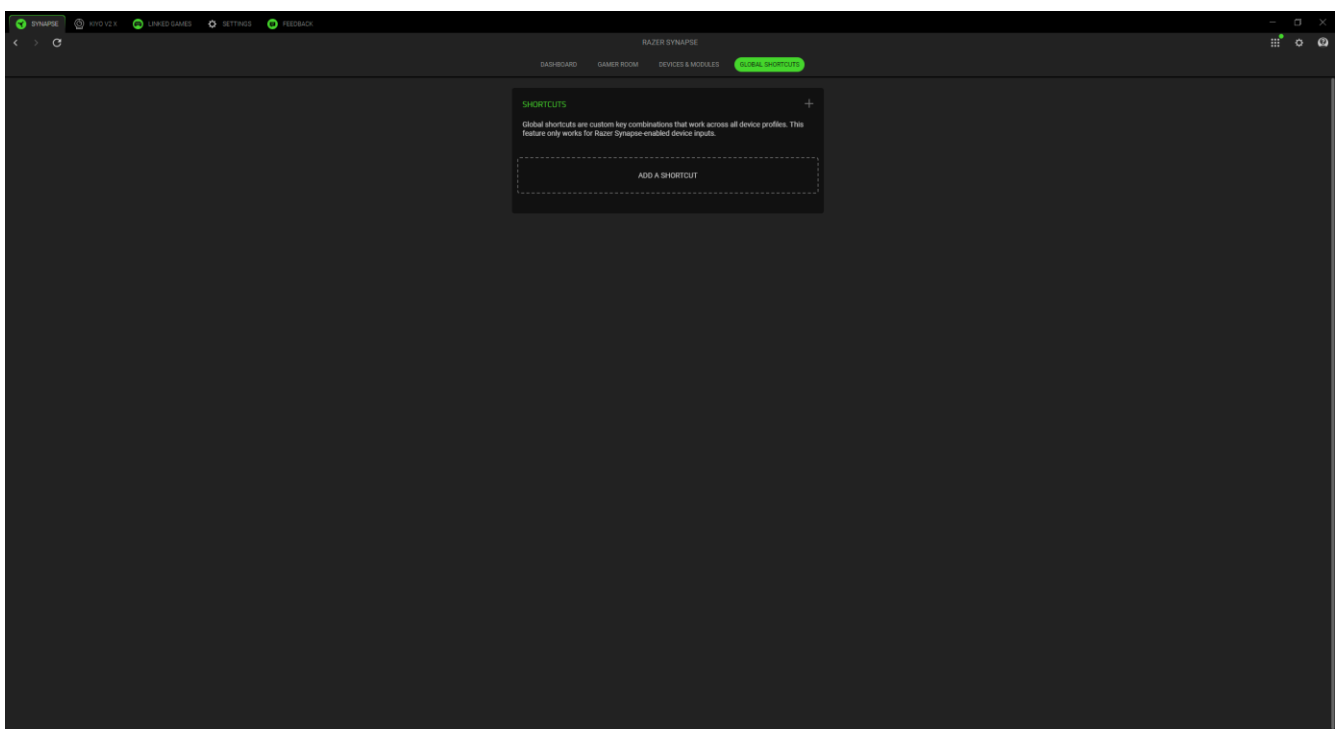

KIYO V2 X

The Kiyo V2 X tab is the main tab for your Razer webcam. You can adjust your device settings from here, including video quality, image processing, and color correction. Any changes under this tab will be saved automatically to your local system and cloud storage. Use the following buttons below to access your profile options:

▾ Profiles Dropdown Bar

Clicking this dropdown bar will display all the profiles for this device so you can quickly change profiles.

⋮ Miscellaneous

Clicking this button will open a pop-up with options related to your current profile.

Camera

Set and control how close a subject is to the camera, how it will track a subject and determines how light or dark its captures are.

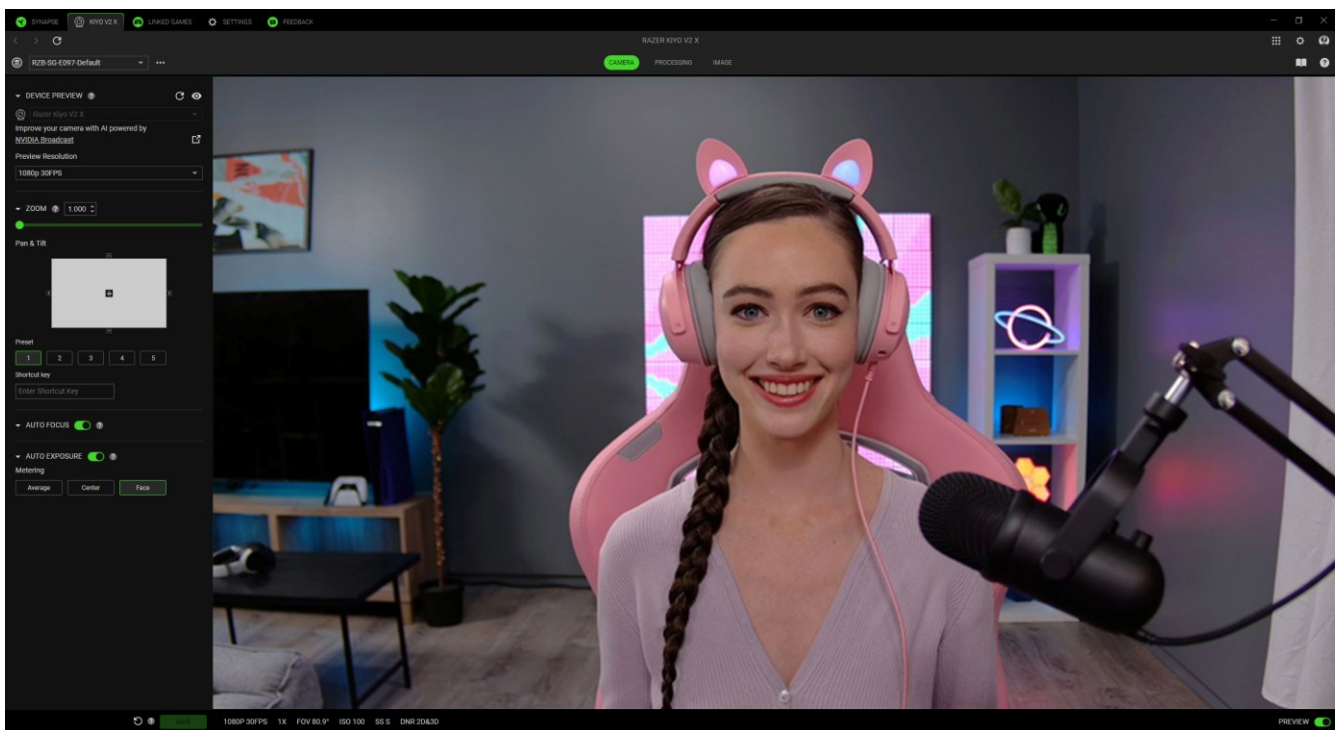

Profile

Profile is a data storage system that keeps all your Razer device settings. By default, the profile name is based on your system's name. Clicking the dropdown bar (▾) will display all profiles for this device so you can quickly switch between them. To add, import, rename, duplicate, export, or delete a profile, press the profile's corresponding Miscellaneous button (⋮).

Device Preview

The Device Preview displays the camera's real-time display when you enable the Preview toggle. It also shows dropdown menus for camera selection and Preview Resolution.

i *To begin customizing the camera's settings, you must first enable the Preview toggle. Other apps won't be able to use the camera when it's active on Razer Synapse.*

Zoom

Adjust how close a subject is or how wide the camera's capture area is using the zoom slider and control which portion is zoomed in using Pan and Tilt. You can save up to five of these settings as presets and assign individual shortcut keys to each preset.

Auto Focus

Toggle between Automatic and Manual focus. If Auto Focus is toggled off, you'll be able to adjust the camera's focus manually using a slider.

Auto Exposure

Set how the camera evaluates how exposed a subject is by allowing it to automatically adjust the highlights and shadows of its captures or manually adjust the camera's sensitivity to lighting.

When enabled, the following metering settings can be selected:

- **Average.** The camera will evaluate the overall scene as basis for a subject's exposure settings.
- **Center.** The camera will evaluate exposure settings using the entire scene, focusing more on the center.
- **Face.** The exposure setting is evaluated using the detected face of a subject in the scene.

When disabled, you'll be able to manually adjust the camera's suggested exposure settings using the slider.

Save

Save and store Razer Synapse settings to your camera and use them on other applications.

Processing

Control the quality of the camera's captures and processing using Low Light Compensation and Noise Reduction.

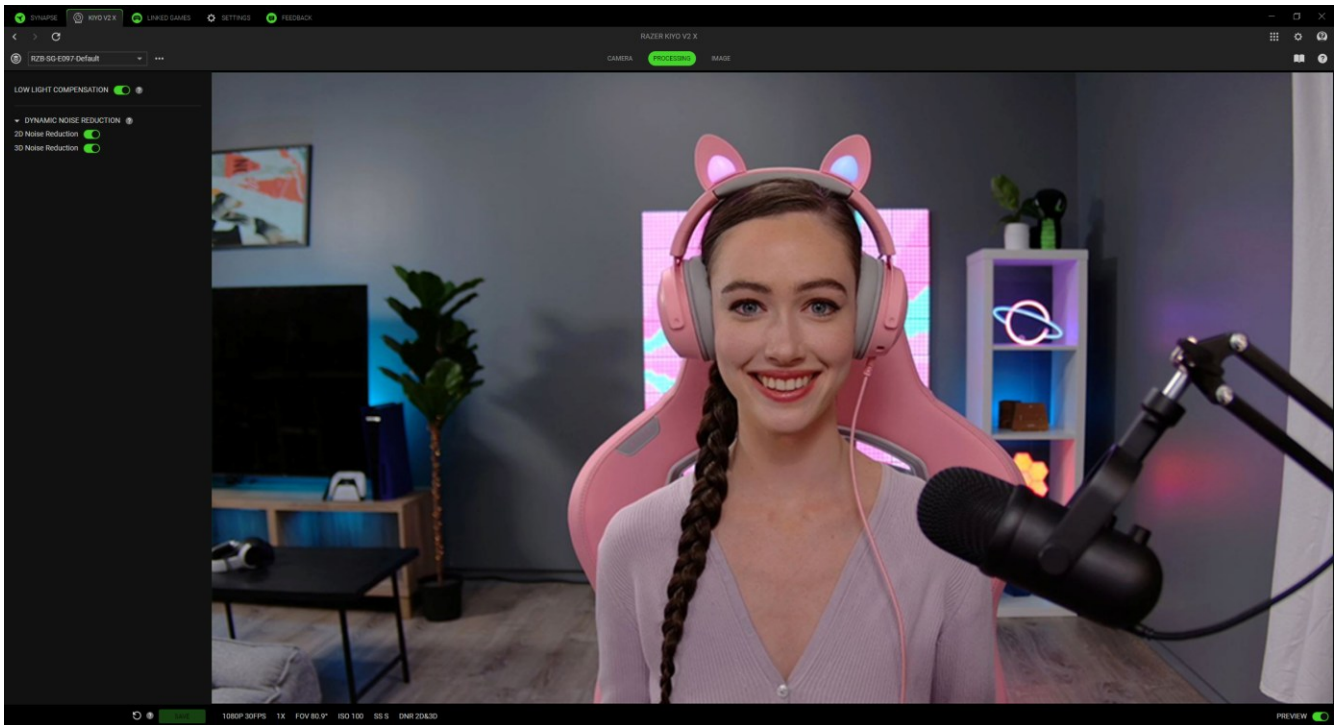

Low Light Compensation

When enabled, the camera will automatically adjust its brightness when capturing in low-light scenes.

Dynamic Noise Reduction

Enable to reduce noise and artifacts and improve overall image quality in low-light scenes. You should disable these features when using the camera in well-lit scenes.

- **2D Noise Reduction.** Prioritize overall noise reduction.
- **3D Noise Reduction.** Reduce noise in motion-blur scenes.

i *The camera's current noise reduction status is indicated at the bottom of the Preview.*

Image

Customize the camera's image settings using presets and tweak it further by customizing other settings as needed.

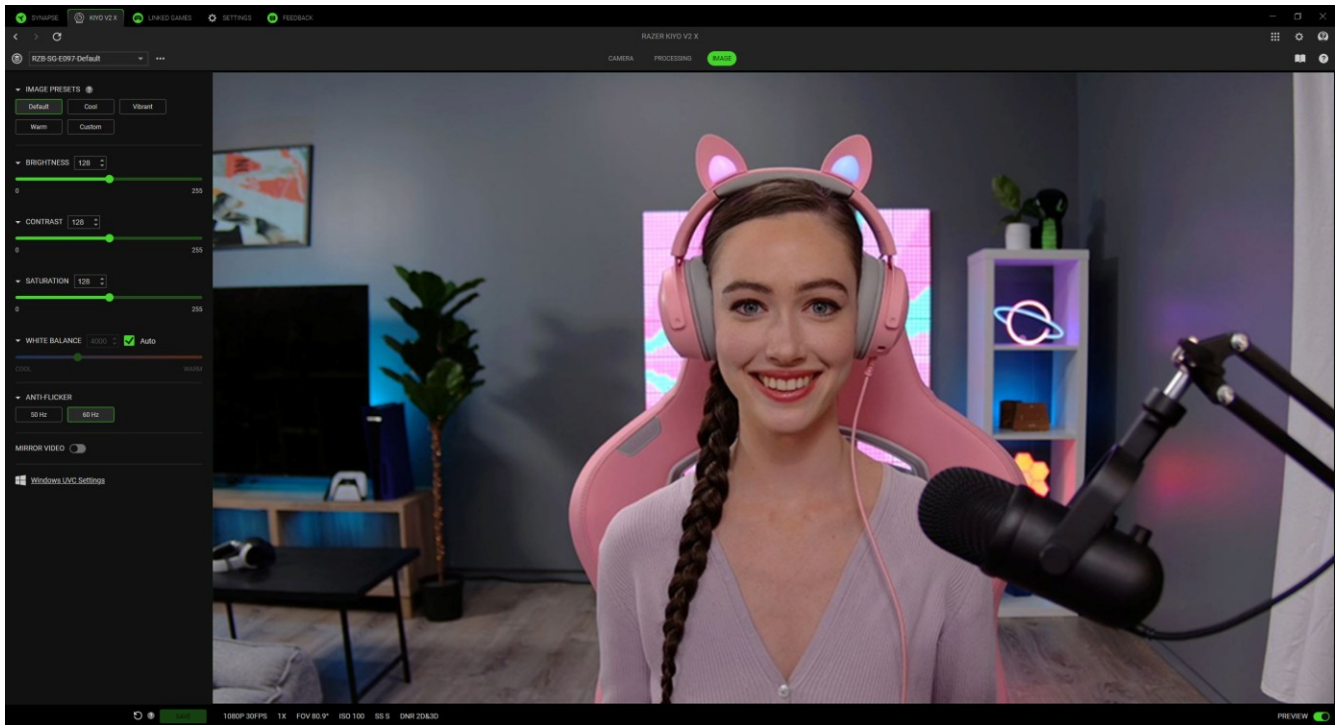

Image Presets

Use a pre-customized image setting for the camera.

Brightness

Control the overall brightness of the camera's captures.

Contrast

Highlight the separation of tones within the camera's captures.

Saturation

Change the color intensity of the camera's captures.

White Balance

Control the color temperature of the camera's light source. By default, this is set to Auto, where the camera determines the best color temperature for its captures.

Anti-flicker

Set the camera's frequency to match the correct frequency of your country.

Mirror Video

Flips the camera feed to reflect what you see in the mirror in the Preview.

Windows UVC Settings

Open your operating system's camera properties window and customize color corrections and camera controls.

LINKED GAMES

The Linked Games tab allows you to add apps, view peripherals linked to apps, or search for listed apps.

Games

The Games subtab enables you to link apps to your peripherals. You can also sort apps based on alphabetical order, last played, or most played. Apps will still be listed here, even if not linked to a Razer device. To add an app that is not listed on the screen, you can use the Add button (+) to search for it manually or use the Scan button (🔍) to search for it automatically. Click the Search button (🔍) to look for a specific game or program from the list.

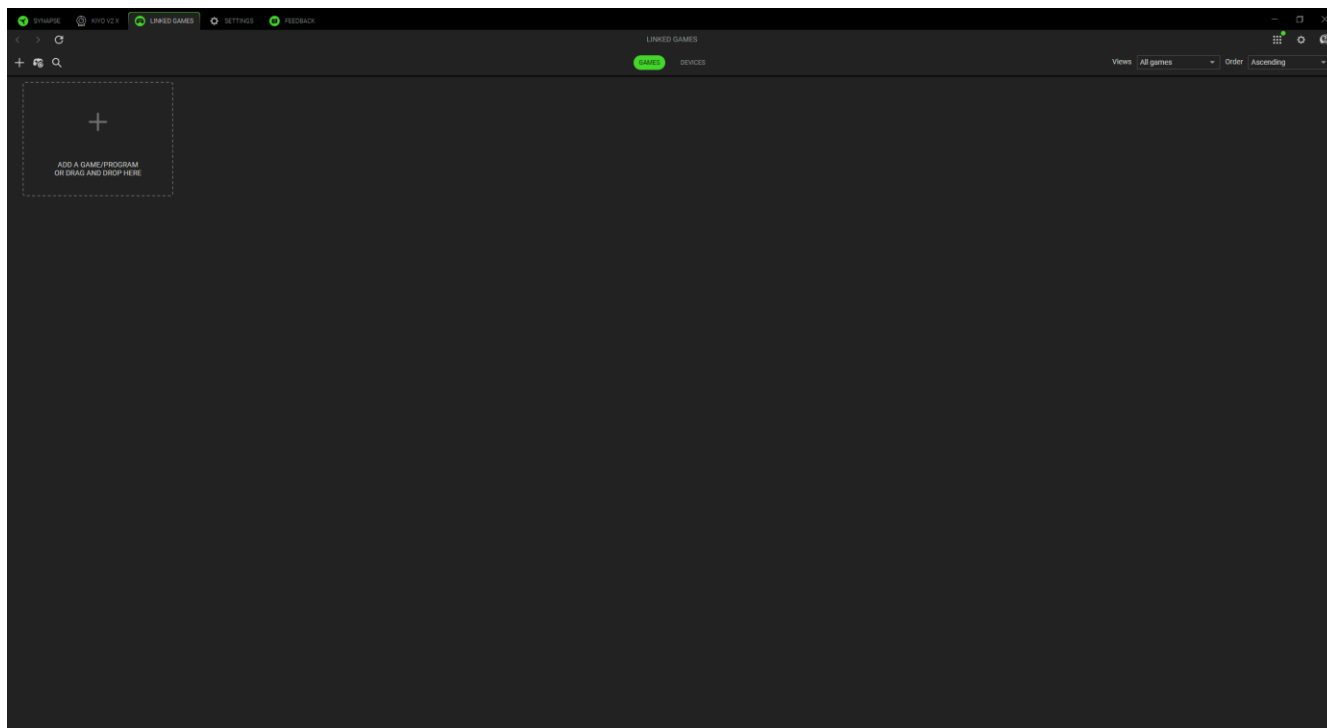

To link an app to your Razer device, click on it from the list and select a device and its profile. This will automatically set your device to the selected profile whenever you launch the app.

Devices

The Devices subtab lets you view your peripherals and determine which apps are linked to them. By selecting a device, you can see a list of linked apps, add new apps, or remove linked apps. You can filter these apps by using the Views and Order dropdown list. To add an app not listed on your peripheral, you can drag and drop the executable file inside the box or use the Add button (+) to open the search window. While inside the search window, you can click the Refresh button (↻) to rescan installed apps, the Search button (🔍) to look for a specific game or program from the list, or the Browse link to search for the app manually.

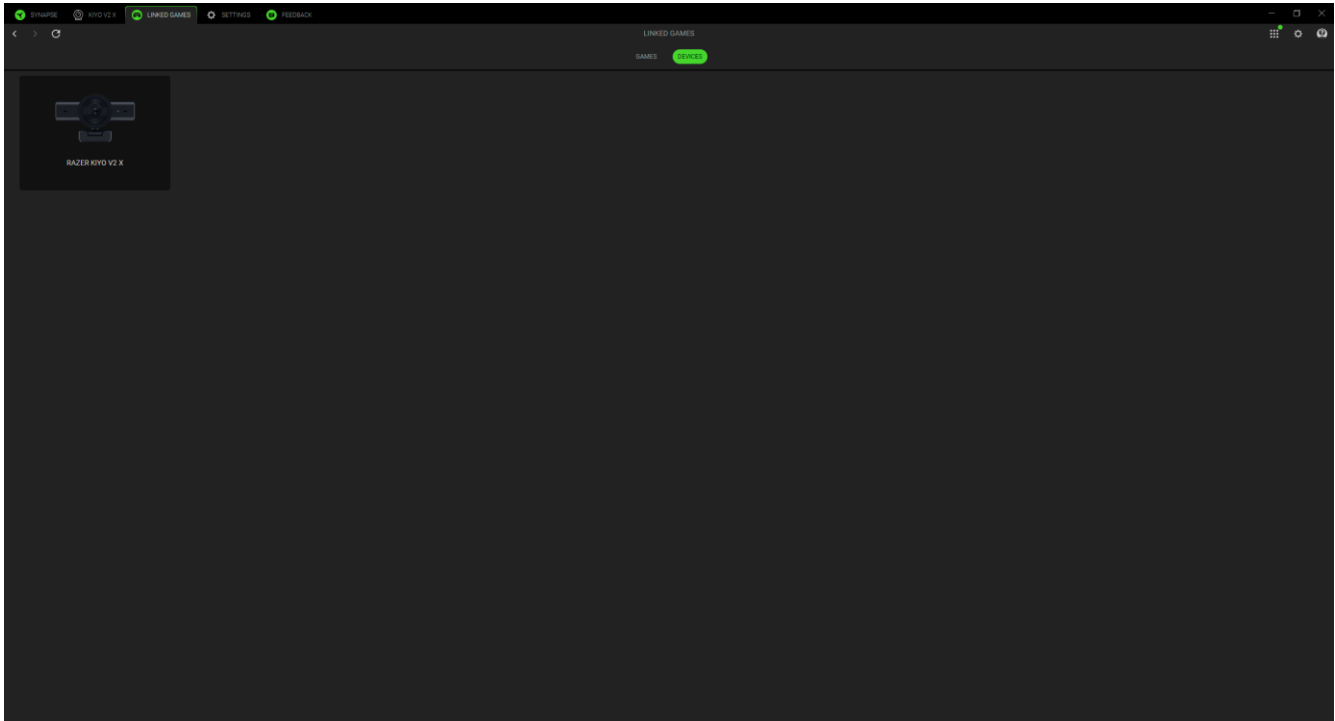

To link an app to your Razer device, click the tick box at the top left corner of the app while inside the search box. This will automatically set your device to the selected profile whenever you launch the app.

SETTINGS

The Settings tab, accessible by clicking the (⚙) button, enables you to configure numerous options as listed below:

Synapse

The Synapse subtab is where you can find options that are specific to the app.

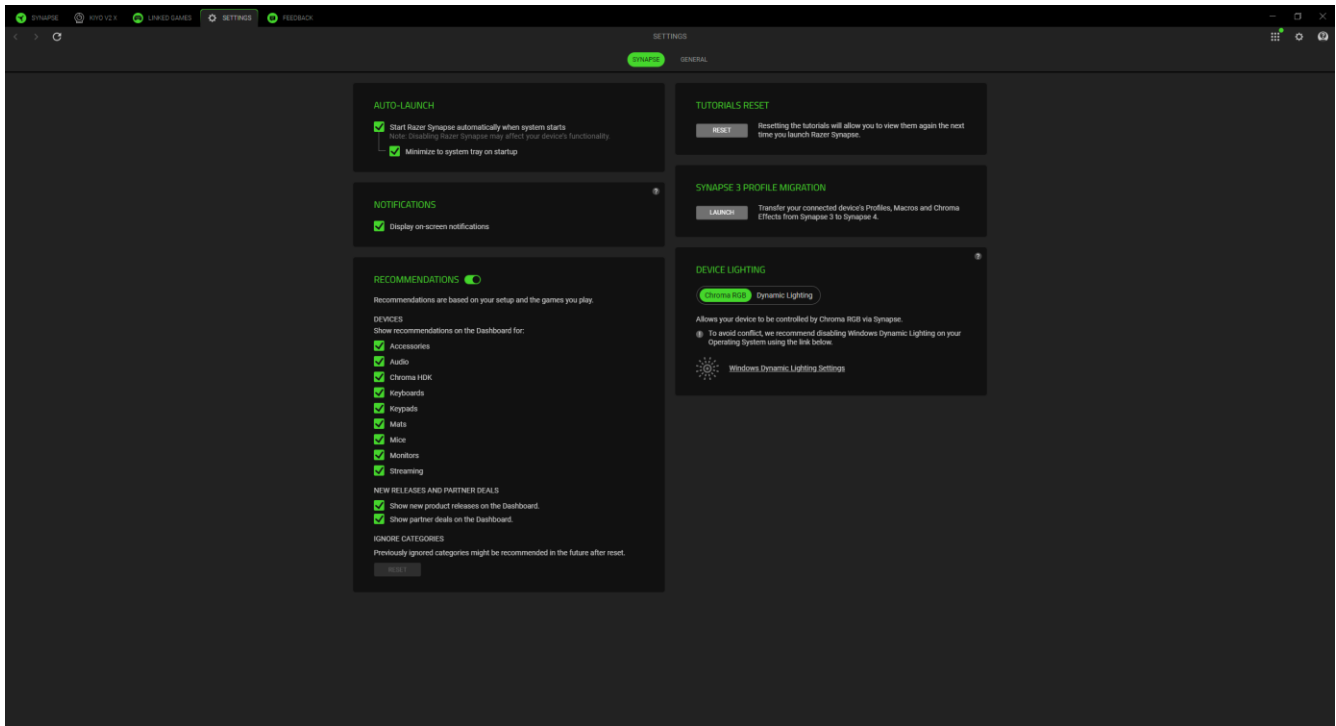

Auto Launch

The Auto Launch option enables you to configure the app's startup behavior.

Notifications

The Notifications option allows the app to display on-screen notifications even if you run full-screen apps.

Recommendations

Recommendations enable us to show the latest products and features on your Dashboard based on your installed devices and linked games.

Tutorials Reset

Selecting the Reset button will reactivate all tutorials that help you acquaint yourself with Razer Synapse's features.

Profile Migration

This function lets you transfer all your device's Profiles, Macros, and Chroma Effects from Synapse 3 to the new Synapse.

Device Lighting

This option lets you choose which app will control the lighting effects on your device.

General

The General subtab is the section where you can access miscellaneous options for your app, as well as find additional information about the software.

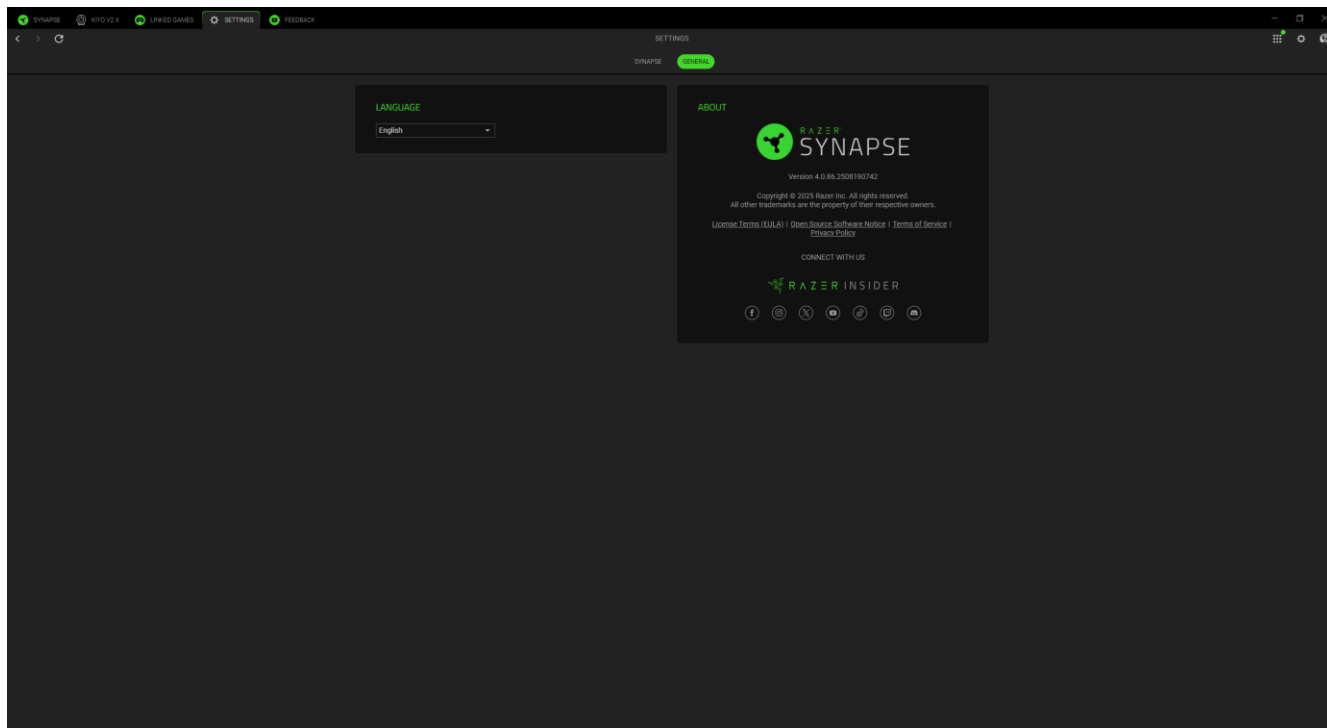

Language

This option lets you change the display language of Razer Synapse.

About

The About section shows the current software version, displays the copyright statement, and provides relevant links for Razer's terms of use. You may also use this option to access Razer's social communities quickly.

FEEDBACK

Help us improve Razer Synapse by giving your comments, suggestions, and problems with the software. You can contact us directly using this tab and even earn rewards for reporting bugs.

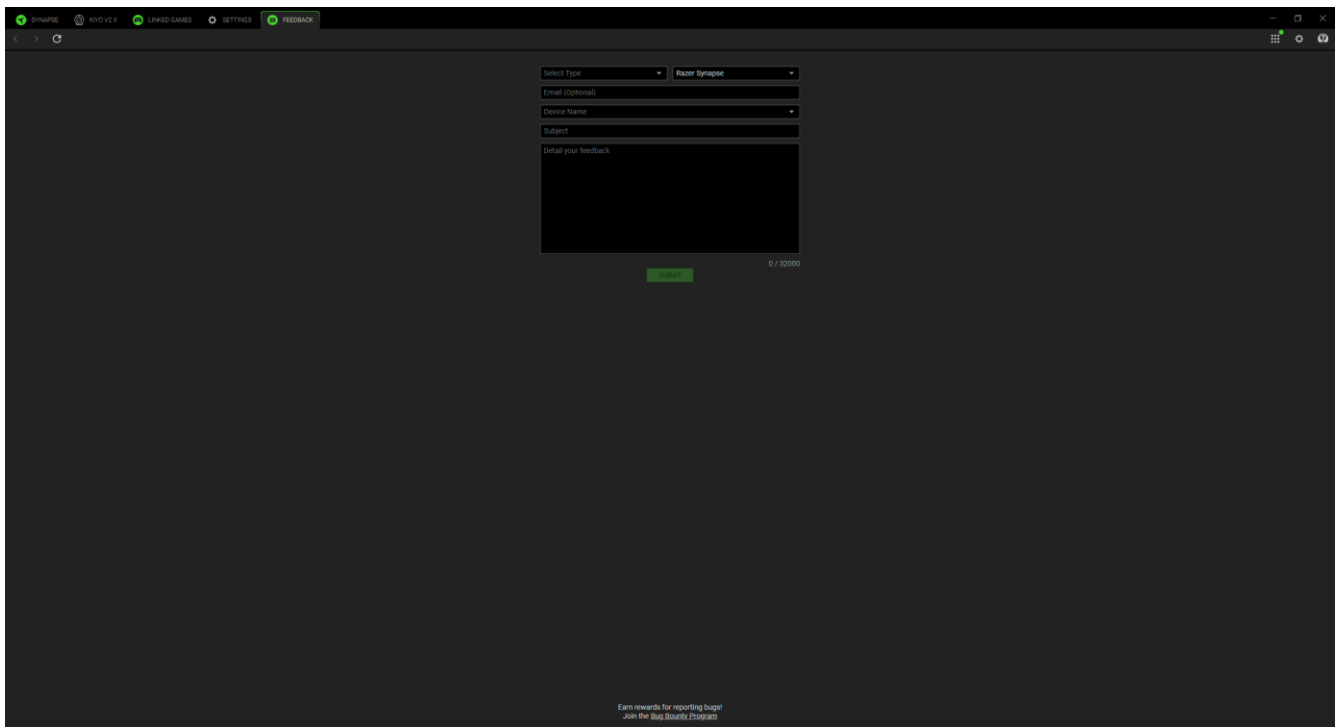

The screenshot shows the Razer Synapse Feedback form in a dark-themed application window. The window title bar includes 'SYNAPSE', 'RPTO 121', 'LINKED LAUNCH', 'SETTINGS', and 'FEEDBACK'. The form fields are as follows:

- Select Type:** A dropdown menu with 'Razer Synapse' selected.
- Email (Optional):** A text input field.
- Device Name:** A dropdown menu.
- Subject:** A text input field.
- Detail your feedback:** A large text area for the main feedback content.

At the bottom right of the form, there is a green 'Submit' button and a character count '0 / 50000'. At the bottom center of the application window, there is a small text prompt: 'Earn rewards for reporting bugs! Join the Bug Bounty Program'.

6. SAFETY AND MAINTENANCE

SAFETY GUIDELINES

In order to achieve maximum safety while using your Razer Kiyo V2 X, we suggest that you adopt the following guidelines:

Should you have trouble operating the device properly and troubleshooting does not work, unplug the device and contact the Razer hotline or go to support.razer.com for assistance.

Do not take apart the device and do not attempt to operate it under abnormal current loads. Doing so will void your warranty.

Do not use or install the device and its components near water, moisture, solvents, or other wet surfaces, nor expose the device to high temperatures or direct sunlight for an extended period of time.

Keep the device away from liquid, humidity or moisture. Operate the device only within the specific temperature range of 0°C (32°F) to 40°C (104°F). Should the temperature exceed this range, unplug and/or switch off the device in order to let the temperature stabilize to an optimal level.

MAINTENANCE AND USE

The Razer Kiyo V2 X requires minimum maintenance to keep it in optimum condition. Once a month we recommend you unplug the device from the computer and clean it using a soft cloth or cotton to prevent dirt buildup. Do not use soap, harsh cleaning agents, or abrasives.

7. LEGALESE

COPYRIGHT AND INTELLECTUAL PROPERTY INFORMATION

©2025 Razer Inc. All rights reserved. Razer, the triple-headed snake logo, Razer logo, “For Gamers. By Gamers.”, and “Powered by Razer Chroma” logo are trademarks or registered trademarks of Razer Inc. and/or affiliated companies in the United States or other countries. All other trademarks are the property of their respective owners.

Windows and the Windows logo are trademarks of the Microsoft group of companies.

Razer Inc. (“Razer”) may have copyright, trademarks, trade secrets, patents, patent applications, or other intellectual property rights (whether registered or unregistered) concerning the product in this guide. Furnishing of this guide does not give you a license to any such copyright, trademark, patent or other intellectual property right. The Razer Kiyo V2 X (the “Product”) may differ from pictures whether on packaging or otherwise. Razer assumes no responsibility for such differences or for any errors that may appear. Information contained herein is subject to change without notice.

LIMITED PRODUCT WARRANTY

For the latest and current terms of the Limited Product Warranty, please visit [razer.com/warranty](https://www.razer.com/warranty).

LIMITATION OF LIABILITY

Razer shall in no event be liable for any lost profits, loss of information or data, special, incidental, indirect, punitive or consequential or incidental damages, arising in any way out of distribution of, sale of, resale of, use of, or inability to use the Product. In no event shall Razer’s liability exceed the retail purchase price of the Product.

GENERAL

These terms shall be governed by and construed under the laws of the jurisdiction in which the Product was purchased. If any term herein is held to be invalid or unenforceable, then such term (in so far as it is invalid or unenforceable) shall be given no effect and deemed to be excluded without invalidating any of the remaining terms. Razer reserves the right to amend any term at any time without notice.