

# USER MANUAL

---

EMD2000SE-T, EMD2000SE-R, EMD2002SE-T, EMD2002SE-R, EMD200DV-T, EMD200DP-T, EMD2000PE-T,  
EMD2000PE-R, EMD2002PE-T, EMD2002PE-R, EMD2000PE-R-P, EMD2002PE-R-P

# EMERALD KVM OVER IP TECHNOLOGY

---

24/7 TECHNICAL SUPPORT AT 1.877.877.2269 OR VISIT [BLACKBOX.COM](http://BLACKBOX.COM)

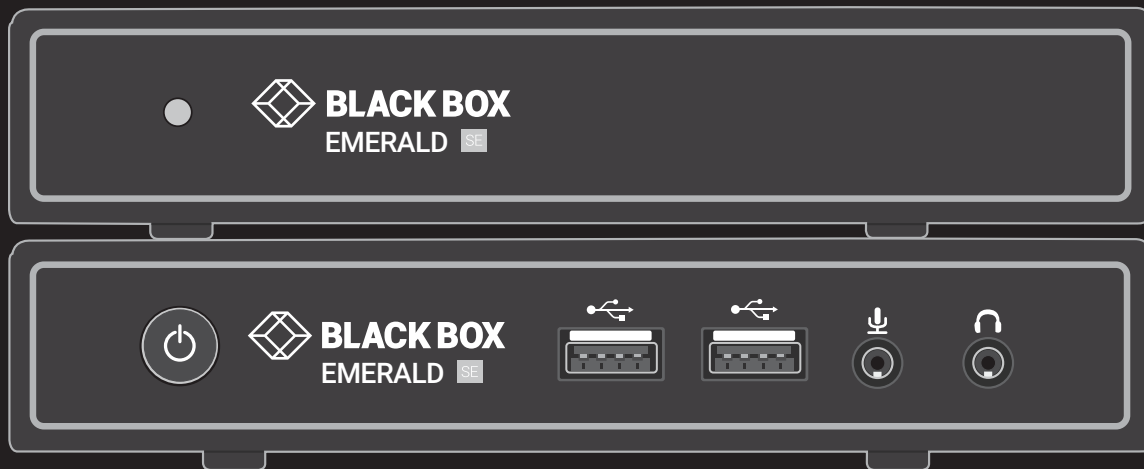

# TABLE OF CONTENTS

<b>1. SPECIFICATIONS.....</b>	<b>5</b>
1.1 General Specifications .....	5
1.2 What's Included in the Kits .....	7
1.3 Licensing .....	8
<b>2. OVERVIEW.....</b>	<b>9</b>
2.1 Emerald System Features.....	9
2.2 Overview of Emerald Devices.....	10
2.2.1 Video.....	11
2.2.2 Audio.....	11
2.2.3 Support for Keyboards, Mice, and USB Devices .....	11
2.2.4 IP Addressing.....	11
2.2.5 Firmware Upgrade.....	12
2.3 Application Examples .....	12
2.3.1 Video, Audio and USB Extension.....	12
2.3.2 Video, Audio and USB Switching.....	13
<b>3. CONFIGURATION .....</b>	<b>14</b>
3.1 Configuration of Receiver .....	14
3.2 Configuration of Transmitter .....	14
3.3 Configuration of Boxilla .....	15
<b>4. MODES OF OPERATION .....</b>	<b>16</b>
4.1 Auto Login .....	16
4.2 Auto Connect.....	16
4.3 Private Connection.....	16
4.4 Shared Connection .....	16
4.5 Video Source Optimization.....	16
<b>5. INSTALLATION .....</b>	<b>17</b>
5.1 Emerald Receiver (EMD2000SE-R, EMD2002SE-R, EMD2000PE-R, EMD2002PE-R, EMD2000PE-R-P, EMD2002PE-R-P) Checklist ..	17
5.2 Emerald Transmitter (EMD2000SE-T, EMD2002SE-T, EMD2000PE-T, EMD2002PE-T) Checklist.....	17
5.3 Emerald SE Transmitter Kit (EMD2000SE-T-K, EMD2002SE-T-K) Checklist .....	17
5.4 Emerald ZeroU DVI or DisplayPort Transmitter (EMD200V-T or EMD200DP-T) .....	17
5.5 Installation Options.....	17
5.6 Connect the Emerald Receiver .....	18
5.6.1 Emerald SE Receiver .....	19
5.6.2 Emerald PE Receiver.....	20
5.7 Connect the Emerald Transmitter.....	22
5.7.1 Emerald SE Transmitter .....	22
5.7.2 Emerald PE Transmitter.....	24
5.8 Connect the Emerald ZeroU DVI or DisplayPort Transmitter .....	26



# TABLE OF CONTENTS

<b>6. NETWORKED INSTALLATION .....</b>	<b>28</b>
6.1 Point-to-Point Installation.....	28
6.2 Unmanaged or Managed Matrix Installation .....	28
<b>7. OPERATION OF EMERALD SYSTEM .....</b>	<b>29</b>
7.1 LED Identification .....	29
7.2 Accessing the System.....	29
<b>8. OSD FUNCTIONS .....</b>	<b>30</b>
8.1 User Types.....	30
8.2 Log On .....	30
8.3 Default Username and Password .....	31
8.4 User Views and Capabilities.....	32
8.5 Connections Screen.....	32
8.5.1 Creating a New Connection .....	33
8.5.2 Connection Favorites .....	34
8.5.3 Connecting .....	35
8.5.4 Edit Connection .....	35
8.5.5 Remove Connection .....	35
8.5.6 Bonding.....	36
8.6 Control Tab.....	36
8.6.1 Preferences .....	37
8.6.2 Network .....	40
8.6.3 System.....	41
8.7 Managing Users .....	49
8.7.1 Add a User.....	50
8.7.2 Auto Log-on.....	50
8.7.3 Edit a User.....	52
8.7.4 Remove a User .....	53
8.8 LACP.....	53
<b>APPENDIX A. EMERALD VIDEO RESOLUTIONS SUPPORTED .....</b>	<b>54</b>
<b>APPENDIX B. CONFIGURING WINDOWS 7 VIRTUAL MACHINES FOR EMERALD .....</b>	<b>55</b>
<b>APPENDIX C. EMERALD NETWORK PROTOCOLS OVERVIEW .....</b>	<b>56</b>



# TABLE OF CONTENTS

APPENDIX D. TROUBLESHOOTING .....	57
APPENDIX E. REGULATORY INFORMATION .....	59
E.1 FCC Statement .....	59
E.2 NOM Statement.....	60
APPENDIX F. DISCLAIMER/TRADEMARKS.....	61
F.1 Disclaimer.....	61
F.2 Trademarks Used in this Manual.....	61



**WARNING (PoE):** The EMD-PE units conform to IEEE 802.3af but do not meet the isolation barrier requirements specified in subsection 33.4.1 – Isolation. The units meet the Safety Requirements of IEC 62368.



## CHAPTER 1: SPECIFICATIONS

## 1.1 GENERAL SPECIFICATIONS

TABLE 1-1. SPECIFICATIONS

SPECIFICATION	DESCRIPTION
<b>Approvals</b>	
Unit	FCC, CE, CSA, RoHS, WEEE
Power Supply	TUV, UL
<b>Physical</b>	
LED Interface	EMD2000SE-T, EMD2000SE-R, EMD2002SE-T, EMD2002SE-R: (1) Power LED button (deactivated, not used); EMD200DV-T, EMD2000PE-T, EMD2000PE-R, EMD2002PE-T, EMD2002PE-R, EMD2000PE-R-P, EMD2002PE-R-P: (1) Power LED (green); NOTE: SE and PE units automatically power on when plugged in; must be powered off at the power source. NOTE: EMD200DV-T can be powered by the USB connectors, or via an optional DC power supply; (1) RJ-45 Speed LED (green, located on top left of RJ-45 connector): Blinks three times when the network connection is 1000 Mbps, Blinks two times when network connection is 100 Mbps, Blinks once when the network connection is 10 Mbps, Not blinking: No Link to network; (1) Activity LED (green, located on top right of RJ-45 connector): Solid green: Link up, Blinking: Activity on the link, OFF: No link
Maximum Distance from GPU to Transmitter	EMD2000SE-T, EMD2002SE-T, EMD2000PE-T, EMD2002PE-T: 16 ft. (5 m), DVI-D and USB limitations; EMD200DV-T: 12" (30.48 cm) via connected cable harness
Maximum Distance between Transmitter and Receiver	328 ft. (100 m), use a network switch to get farther distances
Operating System Support	Microsoft Windows® Vista, XP, Windows 7, Windows 8, Windows 10, Server 2003, Server 2008, Server 2012, Linux®, Mac OS
Connectors	EMD2000SE-T: (1) DVI input, (1) USB Type B female, (1) RJ-45 network, (1) RJ-45 serial, (2) 3.5 mm audio, (1) 2.5 mm barrel for power; EMD2000SE-R: (1) DVI output, (4) USB Type A female, (1) RJ-45 network, (1) DB9 serial, (2) 3.5 mm audio for SPK and MIC, (1) 2.5 mm barrel for power; EMD2002SE-T: (2) DVI input, (1) USB Type B female, (1) RJ-45 network, (1) RJ-45 serial, (2) 3.5 mm audio, (1) 2.5 mm barrel for power; EMD2002SE-R: (2) DVI output, (4) USB Type A female, (1) RJ-45 network, (1) DB9 serial, (2) 3.5 mm audio for SPK and MIC, (1) 2.5 mm barrel for power; EMD200DV-T: (1) DVI input, (2) USB Type A female, (1) RJ-45 network, (1) 3.5 mm audio for speakers, (1) 2.5 mm barrel for power; EMD200DP-T: (1) DisplayPort input, (2) USB Type A female, (1) RJ-45 network, (1) 2.5 mm barrel for power; NOTE: The ZeroU Transmitter can be powered via (2) USB Type A connectors or via an optional DC power adapter. EMD2000PE-T: (1) DVI input, (1) USB Type B female, (1) RJ-45 PoE network, (1) SFP network, (2) 3.5 mm audio, (1) Micro USB connector, (1) 2.5 mm barrel for power; EMD2000PE-R: (1) DVI output, (4) USB Type A female, (1) RJ-45 network, (1) SFP network, (2) 3.5 mm audio for SPK and MIC, (1) Micro USB connector, (1) 2.5 mm barrel for power; EMD2002PE-T: (2) DVI inputs, (1) USB Type B female, (1) RJ-45 PoE network, (1) SFP network, (2) 3.5 mm audio, (1) Micro USB connector, (1) 2.5 mm barrel for power; EMD2002PE-R: (2) DVI outputs, (4) USB Type A female, (1) RJ-45 network, (1) SFP network, (2) 3.5 mm audio for SPK and MIC, (1) Micro USB connector, (1) 2.5 mm barrel for power; EMD2000PE-R-P: (1) DVI output, (4) USB Type A female, (1) RJ-45 PoE network, (1) SFP network, (2) 3.5 mm audio for SPK and MIC, (1) Micro USB connector, (1) 2.5 mm barrel for power; EMD2002PE-R-P: (2) DVI outputs, (4) USB Type A female, (1) RJ-45 PoE network, (1) SFP network, (2) 3.5 mm audio for SPK and MIC, (1) Micro USB connector, (1) 2.5 mm barrel for power

**CHAPTER 1: SPECIFICATIONS****TABLE 1-1 (CONTINUED). SPECIFICATIONS**

SPECIFICATION	DESCRIPTION
<b>Physical (continued)</b>	
Dimensions	EMD2000SE-T, EMD2000SE-R: 1.15" H x 6.2" W x 4.2" D (2.92 x 15.75 x 10.67 cm); EMD2002SE-T: 1.43" H x 6.2" W x 4.2" D (3.65 x 15.75 x 10.67 cm); EMD2002SE-R: 1.15" H x 6.2" W x 4.2" D (2.92 x 15.75 x 10.67 cm); EMD200DV-T: 0.98" H x 2.78" W x 6.12" D (2.5 x 7.07 x 15.55 cm); EMD200DP-T: 0.98" H x 2.78" W x 6.12" D (2.5 x 7.07 x 15.55 cm); EMD2000PE-T, EMD2000PE-R, EMD2000PE-R-P: 1.15" H x 6.2" W, 4.2" D (2.92 x 15.75 x 10.67 cm); EMD2002PE-T: 1.43" H x 6.2" W x 4.2" D (3.65 x 15.75 x 10.67 cm); EMD2002PE-R, EMD2002PE-R-P: 1.15" H x 6.2" W x 4.2" D (2.92 x 15.75 x 10.67 cm)
Weight	EMD2000SE-T, EMD2000SE-R: 1.18 lbs (0.54 kg); EMD2002SE-T: 1.47 lb. (0.67 kg); EMD2002SE-R: 1.36 lb. (0.62 kg); EMD200DV-T: 0.474 lb. (0.215 kg); EMD200DP-T: 0.400 lb. (0.181 kg); EMD2000PE-T, EMD2000PE-R, EMD2000PE-R-P: 1.18 lbs (0.54 kg); EMD2002PE-T: 1.47 lb. (0.67 kg); EMD2002PE-R, EMD2002PE-R-P: 1.36 lb. (0.62 kg)
<b>Operation</b>	
Default IP Address	EMD2000SE-T, EMD2002SE-T, EMD200DV-T, EMD2000PE-T, EMD2002PE-T: 192.168.1.22; EMD2000SE-R, EMD2002SE-R, EMD2000PE-R, EMD2002PE-R, EMD2000PE-R-P, EMD2002PE-R-P: 192.168.1.21
Encryption	Secure Sockets Layer (SSL) over TCP/IP, 128-bit between TX and RX, user set between RX and Hyper-V
Default Username	admin
Default Password	The password is blank by default
DDC Support	Built-in/clone of remote
Switching Time	<1 sec
<b>Power</b>	
Power Source	External in-line power supply (EMD200DV-T optionally powered by USB connectors)
Input Voltage	100–240 VAC, 50/60 Hz
Input Current	0.9 amps maximum
Power Consumption	Unit: 6.5 watts with keyboard and mouse attached; Power supply is 20 W to support USB based powered devices
Heat Dissipation	(5 VDC x 4 amps) x 3.41 = 68.2 BTU/hour maximum (Voltage x Nominal Current) x 3.41 = BTU/hr
Output Connector	2.5-mm barrel
Input Connector	IEC-320, C8
Power Supply Cord Length	6 ft. (1.8 m)
<b>Environmental</b>	
Operating Temperature	32 to 104° F (0 to 40° C)
Storage Temperature	-4 to +140° F (-20 to 60° C)
Operating Humidity	5 to 95%, noncondensing



# CHAPTER 1: SPECIFICATIONS

## 1.2 WHAT'S INCLUDED IN THE KITS

**NOTE:** Does not include local CPU cables, order separately.

EMD2000SE-T includes:

- ◆ (1) Emerald® SE Transmitter, Single-Head
- ◆ (1) 5-VDC Power Supply
- ◆ (1) Power Cord
- ◆ (4) rubber feet

EMD2000SE-R includes:

- ◆ (1) Emerald SE Receiver, Single-Head
- ◆ (1) 5-VDC Power Supply
- ◆ (1) Power Cord
- ◆ (4) rubber feet

EMD2000SE-T-K includes:

- ◆ (1) Emerald SE Transmitter, Single-Head
- ◆ (1) 5-VDC Power Supply
- ◆ (1) Power Cord
- ◆ (4) rubber feet
- ◆ (1) EHN900025U-0006
- ◆ (1) USB05E-0006
- ◆ (1) EJ110-0005

EMD2000SE-K includes:

- ◆ (1) EMD2000SE-T-K
- ◆ (1) EMD2000SE-R

EMD200DV-T includes:

- ◆ (1) EMD200DV-T Transmitter

EMD2000PE-T includes:

- ◆ (1) Emerald PE or PE PoE Transmitter, Single-Head
- ◆ (1) 12-VDC Power Adapter and Power Cord
- ◆ (1) DVI Cable
- ◆ (1) USB 2.0 Type B Cable

EMD2000PE-R or EMD2000PE-R-P includes:

- ◆ (1) Emerald PE or PE PoE Receiver, Single-Head
- ◆ (1) 12-VDC Power Adapter and Power Cord

EMD2002SE-T includes:

- ◆ (1) Emerald SE Transmitter, Dual-Head
- ◆ (1) 5-VDC Power Supply
- ◆ (1) Power Cord
- ◆ (4) rubber feet

EMD2002SE-R includes:

- ◆ (1) Emerald SE Receiver, Dual-Head
- ◆ (1) 5-VDC Power Supply
- ◆ (1) Power Cord
- ◆ (4) rubber feet

EMD2002SE-T-K includes:

- ◆ (1) Emerald SE Transmitter, Dual-Head
- ◆ (1) 5-VDC Power Supply
- ◆ (1) Power Cord
- ◆ (4) rubber feet
- ◆ (2) EHN900025U-0006
- ◆ (1) USB05E-0006
- ◆ (1) EJ110-0005

EMD2002SE-K includes:

- ◆ (1) EMD2002SE-T-K
- ◆ (1) EMD2002SE-R

EMD200DP-T includes:

- ◆ (1) EMD200DP-T Transmitter

EMD2002PE-T includes:

- ◆ (1) Emerald PE or PE PoE Transmitter, Dual-Head
- ◆ (1) 12-VDC Power Adapter and Power Cord
- ◆ (2) DVI Cables
- ◆ (1) USB 2.0 Type B Cable

EMD2002PE-R or EMD2002PE-R-P includes:

- ◆ (1) Emerald PE or PE PoE Receiver, Dual-Head
- ◆ (1) 12-VDC Power Adapter and Power Cord

# CHAPTER 1: SPECIFICATIONS

## 1.3 LICENSING

There are 2 options for managing Emerald Transmitters and Receivers:

- ◆ Option 1 (for small unmanaged matrices): Using built in receiver manager
- ◆ Option 2 (for large managed matrices): Using Boxilla BXAMGR

**NOTE:** For managed installations with more than 32 users, you will need to use Boxilla KVM AV/IT Manager. The basic Boxilla license (BXAMGR) supports 25 users.

Other available licenses for Boxilla are listed below:

- ◆ 50 Users, Devices or Connections (BXAMGR-50)
- ◆ 100 Users, Devices or Connections (BXAMGR-100)
- ◆ 200 Users, Devices or Connections (BXAMGR-200)
- ◆ 300 Users, Devices or Connections (BXAMGR-300)
- ◆ Unlimited Users, Devices or Connections (BXAMGR-ULT)

Available upgrade licenses for Boxilla are listed below:

- ◆ Add 25 Users, Devices or Connections (BXAMGR-LIC-25)
- ◆ Add 100 Users, Devices or Connections (BXAMGR-LIC-100)
- ◆ Add 200 Users, Devices or Connections (BXAMGR-LIC-200)
- ◆ Add 300 Users, Devices or Connections (BXAMGR-LIC-300)
- ◆ Add Unlimited Users, Devices or Connections (BXAMGR-LIC-ULT)

Licenses for Active and Standby Boxilla are listed below:

- ◆ 25 Devices (BXAMGR-LICBAK25)
- ◆ 100 Devices (BXAMGR-LICBAK100)
- ◆ 200 Devices (BXAMGR-LICBAK200)
- ◆ 300 Devices (BXAMGR-LICBAK300)



## CHAPTER 2: OVERVIEW

The Emerald® system provides users with a seamless desktop experience anywhere on a TCP/IP network, while allowing the actual hardware to be securely housed in a corporate data center or in the cloud. Emerald enables the same high fidelity experience of a desktop PC even for media-rich applications, for example, watching videos, photo editing with Photoshop or 3D design with AutoCAD. The remote desktops may be hosted on a physical PC / workstation or may be a virtual desktop hosted on a private server or in the cloud. The Emerald system provides its users with Receivers that communicate with target computer nodes (whether physical PC or virtual desktop) over a standard TCP/IP network. Physical PCs/Workstations/Servers have an Emerald SE or PE Transmitter unit or Emerald ZeroU DVI or DisplayPort Transmitter unit physically connected to provide communication over the TCP/IP network. The performance of Emerald allows them to be deployed on standard corporate networks and even across Wide-Area-Networks (WANs).

Desktop users can access remote keyboard, mouse, video, audio, USB mass storage devices, headsets and other USB devices from the Receiver unit to the remote PC/workstations or Virtual Desktop via the Emerald system.

**NOTE:** Some USB 2.0 devices have been found to be incompatible. Please report these devices to Black Box.

**NOTE:** References to the Emerald system in this document refer to both Receivers (EMD2000SE-R, EMD2002SE-R, EMD2000PE-R, EMD2002PE-R, EMD2000PE-R-P, EMD2002PE-R-P) and Transmitters (EMD2000SE-T, EMD2002SE-T, EMD200DV-T, EMD2000PE-T, EMD2002PE-T). The Emerald ZeroU DVI or DisplayPort Transmitter (EMD200DV-T, EMD200DP-T) can be used in place of the SE Transmitter where rack space is limited.

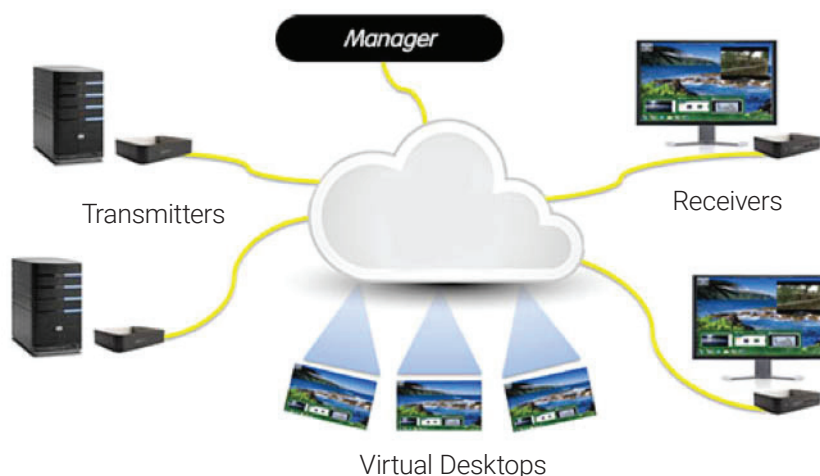

FIGURE 2-1. EMERALD EXAMPLE—INCLUDING PHYSICAL AND VIRTUAL DESKTOPS

### 2.1 EMERALD SYSTEM FEATURES

Emerald leverages state-of-the-art technologies in compression, networking, and latency management. Some of the key features of Emerald are:

- ♦ **Pixel-Perfect Video Quality:** The Emerald system uses a compound compression algorithm to provide a lossless video experience at a low network bandwidth. None of the bandwidth variability and noise effects of analog extension schemes exist. Emerald can support a 1080p HD movie in <40 Mbps.
- ♦ **Uses M/C stream for shared mode** to allow scaling of # of users that can share a transmitter. Analog audio can now be shared in a shared mode connection.
- ♦ **Seamless integration of Physical and Virtual Desktops:** The Emerald system connects to physical PCs, servers, and video sources as well as virtual desktops hosted on servers or in the cloud. This allows seamless connection to physical resources and virtual resources from the same Receiver unit. IT professionals use this capability to optimize their deployments and migrations to cloud services.

## CHAPTER 2: OVERVIEW

- ♦ **High Reliability and Highly Secure:** The Emerald system minimizes maintenance for administrators. The intuitive On-Screen-Display is simple to learn and understand. The individual units have no moving parts to minimize potential for hardware failures. All media streams transmitted between the Emerald devices are encrypted using 128-bit SSL. Password protection is also provided to control access to all administration functions.
- ♦ **Environmentally Optimized:** The Emerald system is optimized to minimize power requirements and eliminate noise. All Receivers and Transmitters consume less than 6 Watts and are completely silent.
- ♦ **Easy Deployment:** The Emerald system is designed to be easily and quickly deployed. No new drivers or software need to be installed on target PCs or Virtual Desktops. The system uses standard networking protocols and cabling. Users and connections are defined using an intuitive On-Screen-Display (OSD). Connections can be made via simple “click on target.” Multiple modes of operation such as private connections, shared connections, auto-login, and auto-connect enable various workflows and collaborations to be supported. Analog audio can now be shared in a shared mode connection.
- ♦ **The Emerald ZeroU DVI or DisplayPort Transmitter** features a small form factor to use zero rack space—you save money when rack space is expensive. This Transmitter can be powered over USB or via an optional power supply.

### 2.2 OVERVIEW OF EMERALD DEVICES

The Emerald family is composed of six Receivers, six Transmitters, and a Boxilla Manager.

**TABLE 2-1. EMERALD MODELS**

RECEIVER	NUMBER OF VIDEO HEADS	USB PORTS	SERIAL	AUDIO	POE	DVI CPU CABLE	USB CPU CABLE
EMD2000SE-R	(1) DVI	(4) USB 2.0 Type A	Yes	Yes	No	Not applicable	Not applicable
EMD2002SE-R	(2) DVI	(4) USB 2.0 Type A	No	Yes	No	Not applicable	Not applicable
EMD2000PE-R	(1) DVI	(4) USB 2.0 Type A	No	Yes	No	Not applicable	Not applicable
EMD2002PE-R	(2) DVI	(4) USB 2.0 Type A	No	Yes	No	Not applicable	Not applicable
EMD2000PE-R-P	(1) DVI	(4) USB 2.0 Type A	No	Yes	Yes	Not applicable	Not applicable
EMD2002PE-R-P	(2) DVI	(4) USB 2.0 Type A	No	Yes	Yes	Not applicable	Not applicable
TRANSMITTER	NUMBER OF VIDEO HEADS	USB PORTS	SERIAL	AUDIO	POE	DVI CPU CABLE	USB CPU CABLE
EMD2000SE-T	(1) DVI	(1) USB 2.0 Type B	Yes	Yes	No	Not included	Not included
EMD2002SE-T	(2) DVI	(1) USB 2.0 Type B	No	Yes	No	Not included	Not included
EMD2000PE-T	(1) DVI	(1) USB 2.0 Type B	No	Yes	Yes	(1) included	Not included
EMD2002PE-T	(2) DVI	(1) USB 2.0 Type B	No	Yes	Yes	(2) included	Not included
EMD200DV-T	(1) DVI	(1) USB 2.0 Type A, (1) USB 2.0 Type A for power only	No	Speakers only	No	Not included	Not included
EMD200DP-T	(1) DisplayPort	(1) USB 2.0 Type A, (1) USB 2.0 Type A for power only	No	Yes, Embedded	No	Not included	Not included
MANAGER	NUMBER OF VIDEO HEADS	USB PORTS	SERIAL	AUDIO	POE	DVI CPU CABLE	USB CPU CABLE
BXAMGR	(1) DVI	(4) USB 2.0 Type A	Yes	Yes	No	Not applicable	Not applicable

Some of the key capabilities and operation of Emerald devices are described next. These capabilities are supported across all Emerald devices.



## CHAPTER 2: OVERVIEW

### 2.2.1 VIDEO

---

The Emerald® system supports 24-bit color depth digital video up to a maximum resolution of 1920 x 1200 at 60 Hz for any video head on both Transmitter and Receiver. One or two DVI-I connectors is provided on the Receiver or Transmitter for cable compatibility, but only digital video is supported. One DVI-I connector is provided on the Boxilla Manager. See Appendix 1 - Emerald Video Resolutions Supported for the list of resolutions currently supported by Emerald. VGA or Analog video can be supported by using the KVGA-DVID VGA to DVI-D converter.

### 2.2.2 AUDIO

---

The Emerald system supports CD-quality stereo audio from the remote workstation (with the Transmitter connected) or virtual desktop to peripheral speakers connected to the USB connector on the Emerald Receiver. The Emerald Transmitter uses its USB interface to capture audio from the remote workstation. This increases audio quality by eliminating analog audio noise issues and removing the need for a sound card in PC/Workstation.

The Emerald Receiver connects audio from a peripheral microphone connected via the USB connector on the Receiver to the remote workstation or a virtual desktop. The Emerald Transmitter uses USB to supply the microphone data to the remote workstation. Higher quality audio can be obtained using USB re-direction for USB headsets or speakers.

The Emerald ZeroU DVI Transmitter has just one audio connector (used to connect speakers). The Emerald ZeroU DisplayPort Transmitter has embedded audio over the DisplayPort connector.

### 2.2.3 SUPPORT FOR KEYBOARDS, MICE AND USB DEVICES

---

USB keyboards and mice are fully supported by the Emerald system. Composite mouse and keyboard devices are supported, along with other types of USB devices such as Flash/Thumb Drives, CD and DVD-ROM drives, printers, pen tablets, touch-panels, and isochronous USB devices such as headsets.

Support for non-keyboard and mice devices is provided on an Emerald Receiver using USB re-direction. This capability can be enabled or disabled by the administrator. In an Emerald Receiver, the first two devices that are not keyboard or mouse are assigned to the USB re-direction channel automatically and passed to the remote computer when connected via a Transmitter. When connecting to a non-Transmitter target (i.e. virtual desktop), up to eight USB devices can be re-directed.

NOTE: A hub can be attached externally to an Emerald Receiver, but a maximum of two devices can be assigned to USB re-direction on connections to Transmitters. Multiple keyboard and mice can additionally be supported—though all use the default drivers on the target PC.

### 2.2.4 IP ADDRESSING

---

The Emerald devices are IP-addressable, giving you the flexibility to locate workstations anywhere within your enterprise and at any distance from your desktop users. The Emerald devices use standard network protocols to transfer data between the remote Workstation/Virtual Desktop and the peripheral devices located at the user's desk. The Emerald system can operate on a network connection of 100 Mbps or 1 Gbps.

The receiver can be configured using a static or DHCP assigned IP address while the transmitter requires a static IP address only.

## CHAPTER 2: OVERVIEW

### 2.2.5 FIRMWARE UPGRADE

---

Upgrade your firmware at any time using an Emerald manager or using a USB flash-drive in an Emerald Receiver unit to ensure that your Emerald system is always running the most current version available. The Emerald devices—Receiver and Transmitter—are upgradable.

## 2.3 APPLICATION EXAMPLES

The Emerald system is built to be flexible so that it can be deployed in many different types of applications such as basic extension, switching applications (sometimes called matrix), cloud-based desktops, control rooms, digital signage, and kiosk applications and other applications in banking, financial services, broadcast, network operations, industrial, government and enterprise computing sectors. Emerald provides the state-of-the art performance by:

- ♦ using digital sources for video and audio, hence removing analog noise issues or other potential environmental issues
- ♦ using advanced optimized compression to enable visually lossless video over standard low-bandwidth networks rather than a proprietary connection or dedicated gigabit networks of many systems

### 2.3.1 VIDEO, AUDIO AND USB EXTENSION

---

Many applications require Video, Audio, or USB extension (or all three together) such as PC back-racking, board-room fit-out, remote monitoring, and digital signage.

The Emerald system is set up to connect the Transmitter to the Receiver straight out of the box on a point-to-point network. The Transmitter and Receiver can be attached to standard Ethernet IP networks to increase the distance between units – within a building, between buildings, or across a country. Only standard Ethernet/IP rules and the maximum latency the application can tolerate need to be considered. If video and/or audio extension only is being used, latency rarely is a consideration as the traffic is typically one-way. When USB-based peripheral devices are also required, a network latency of <50 ms is recommended to avoid user issues with “poor mouse response”, etc. For some applications, such as graphic design network latency, <20 ms may be required to ensure user satisfaction. Latency normally is only an issue when extending across a WAN, because latency inside modern buildings or on dedicated networks is much less than 1 ms.

NOTE: Emerald supports latency of <20 ms.

In Figure 2-2, a typical deployment is shown in a basic extender application. In this deployment, only one Transmitter and Receiver are used to allow remote access to a single workstation.

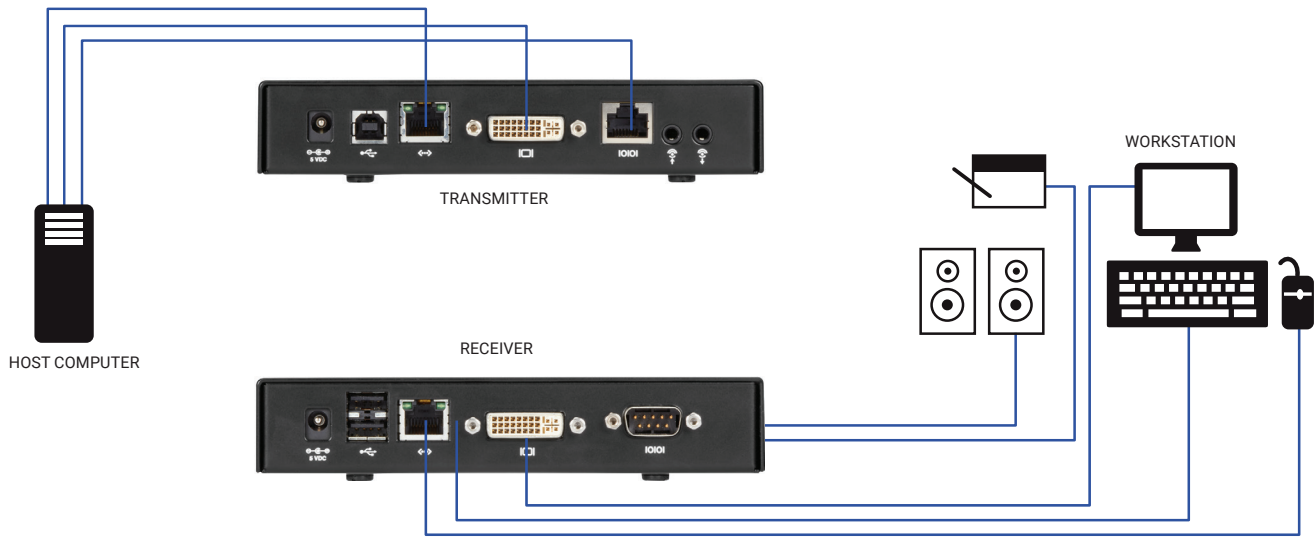

FIGURE 2-2. BASIC EXTENDER APPLICATION

## 2.3.2 VIDEO, AUDIO AND USB SWITCHING

Numerous applications require being able to switch between different target PCs or Virtual Desktops. The user wants to be able to change the source of Video, Audio, or USB extension (or all three together).

Connections can be made to a target using Emerald's intuitive On-Screen-Display (OSD). In Figure 2-3, a larger scale system is shown. This is referred to as a switching or matrix type of deployment. In this deployment, there are several Receivers and Transmitters and a manager, as well as virtual desktops.

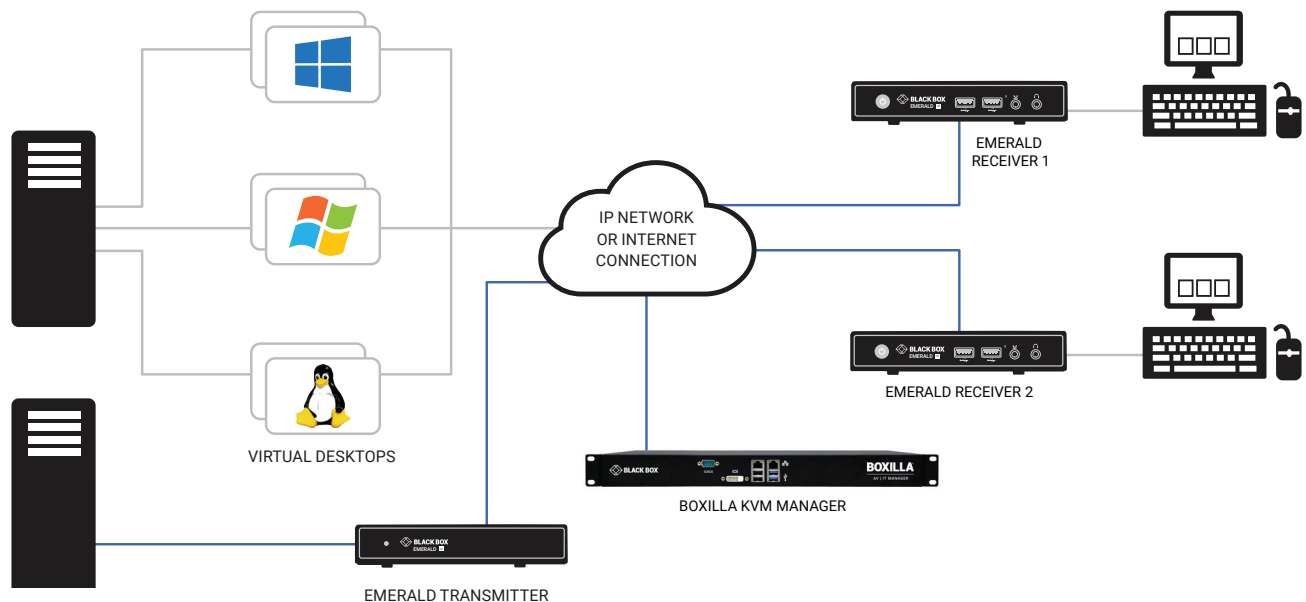

FIGURE 2-3. EMERALD SWITCHING EXAMPLE

## CHAPTER 3: CONFIGURATION

### 3.1 CONFIGURATION OF RECEIVER

An Emerald Receiver connects to a physical PC or a virtual desktop over a TCP/IP network and decrypts and decompresses the streams to provide video, audio, and USB connections to a user. The user is presented with typical PC connections—video out (typically DVI), USB (typically 4 ports of USB 2.0), line out, and microphone in (see individual Receiver's data-sheets for specific ports provided).

The Transmitter-Receiver connection uses Black Box's compound compression algorithm for video called Dynamic Content Optimized Compression (DCOC). This algorithm optimizes compression based on content in the video stream and on available network bandwidth. Standard Microsoft RDP is used for connections to Virtual Desktops. Multiple versions of RDP are supported from RDP 8.1 to legacy versions. This allows Emerald Receivers to connect to Microsoft Hyper-V, VMWare ESX, and Citrix XEN based virtual desktops as well as session host based desktops (previously called Terminal Services).

The Receiver is configured using an On-Screen Display (OSD) built into the Receiver or using the Boxilla Manager. The network settings and unit name among others can be configured for a Receiver. The target connections are defined by their target name or IP address, log-in username/password, and TCP port number to be used. Users can be created and specific connections may be allocated to the different users.

A Receiver user profile is protected by username and password to permit different users to access the same unit securely.

#### Multiplatform support

Emerald is compatible with the following operating systems:

- ♦ Microsoft® Windows Desktop Operating Systems (e.g. Windows 7, Windows 8, Windows 10) and Microsoft Server Operating Systems (e.g., 2003, Server 2008, Server 2012)
- ♦ Linux®
- ♦ Mac OS®

The default keyboard drivers for these operating systems are supported by the Emerald system.

NOTE: For virtual desktops, typically Pro or Enterprise versions of the Windows operating system are required for VDI to support RemoteFX™. See [www.microsoft.com](http://www.microsoft.com) for Terminal Services (RDSH) or VDI (RDVH) requirements.

### 3.2 CONFIGURATION OF TRANSMITTER

An Emerald Transmitter converts the video, audio, and USB connections of a PC or Workstation to a format that can be connected and controlled over a TCP/IP network. The Transmitter connects to the DVI and USB ports of a PC or workstation.

The Transmitter controls the connection to a remote Receiver and manages the flow of information to it. It converts and compresses video and audio information for transmission over standard TCP/IP networks, along with USB peripheral communications. All data communication uses 128-bit encryption.

The Transmitter uses Black Box's compound compression algorithm for video called Dynamic Content Optimized Compression (DCOC). This algorithm optimizes compression and latency on a frame-by-frame basis, depending on content in the video stream and on available network bandwidth. This enables an optimal user experience in challenging network environments.

The Transmitter is configured from an Emerald Receiver or Boxilla Manager. The network settings, unit name, and video quality are among the parameters that can be configured on a Transmitter.

#### Multiplatform support

The Transmitter is connected to the remote workstation via USB and DVI connectors. This enables the Emerald Receiver to interoperate seamlessly with Windows, Linux®, and Macintosh® workstations/servers.



## CHAPTER 3: CONFIGURATION

### 3.3 CONFIGURATION OF BOXILLA MANAGER

In a basic installation, you can configure Emerald via an Emerald receiver's built-in OSD display. For larger installations, a Boxilla Manager (BXAMGR) can manage a network of Emerald Receivers and Transmitters. The BXAMGR can manage 25 transmitters/receivers by default. It can manage an unlimited number of Emerald transmitters/receivers when using an upgrade license.

A Boxilla user profile is protected by username and password to permit different users to access the same unit securely. It maintains the central database that is distributed to all Receivers in the "domain" of the Boxilla (i.e. discovered and added to manager) – called the "managed domain". This distribution ensures that there is no single point of failure in the Emerald system – each Receiver has a copy of the database. This enables each Receiver to continue operation – log users in, make connections as required – even if the Boxilla goes off-line.

Using the intuitive Boxilla web-based interface, one or more administrators can manage potentially thousands of users who are interacting with an almost unlimited number of devices. Boxilla operates as a self-contained compact server unit that can be located anywhere within your network. Boxilla is supplied pre-loaded and is straightforward to deploy, requiring only a network connection and a power input to begin operation.

The current version of Boxilla provides management of Black Box's Emerald system. For more information on Boxilla, refer to the Boxilla user manual.

## CHAPTER 4: MODES OF OPERATION

The Emerald system has various modes of operation such as Auto-Login, Auto-Connect, Private Connection, Shared Connection, and Video Source Optimization modes.

### 4.1 AUTO LOGIN

In Auto-Login Mode, turning on the Emerald Receiver automatically causes a login as a pre-defined user. The user is presented with the permitted connections that have been predefined.

### 4.2 AUTO CONNECT

In Auto-Connect Mode, when a user logs-in to the Emerald Receiver, it causes an automatic connection to their pre-allocated workstation or virtual desktop. Auto-Login and Auto-Connect are defined independent of each other, but can be used together to auto login/auto connect devices that are difficult to reach.

### 4.3 PRIVATE CONNECTION

In Private Connection Mode, when a user makes a connection to a target workstation/virtual desktop, this connection is only accessible by this user. All other users will receive a "busy" message if they attempt to connect to the same workstation/virtual machine. This is the default mode for connections.

### 4.4 SHARED CONNECTION

In Shared Connection Mode, multiple users can connect to the audio and video of the same target computer over the network. They arbitrate for control of the keyboard and mouse of that computer. Non-keyboard and mice devices are not supported on shared connections (such as USB 2.0 devices due to the timing/OS limitations). Analog audio can now be shared in a shared mode connection.

These various modes can be mixed on a particular Receiver and connection. For example Auto-Login and Auto-Connect can be combined to enable an Emerald Receiver to automatically connect to a specific target workstation/virtual desktop when power is applied without any user intervention that might be required for Digital Signage or Kiosk type of deployments.

### 4.5 VIDEO SOURCE OPTIMIZATION

**Off:** In this mode, the transmitter does not perform any additional video functions to manage the video input bandwidth, this mode assumes you are not using any Analog to Digital converters or Temporal Dithering GPU. If you are using converters or have a GPU that does Temporal Dithering, this setting will not work very well as it will saturate the transmitter and cause severe latency.

**DVI Optimized:** This mode is designed to be used with GPUs that support Temporal Dithering. When the GPU updates every pixel on every frame to show a more vibrant video output, the transmitter in this mode can now ignore certain pixel updates to reduce the risk of GPU bandwidth saturation that can lead to severe latency.

#### VGA

**A: VGA High Performance:** When using an analog to digital video converter, these devices can cause video noise to be injected on the signal. The transmitter will view this as a noisy source or a GPU that is using Temporal Dithering. This option is designed more for VGA to DVI/HDMI converters and will perform the function at a Low capacity.

**B: VGA Optimized:** When using an analog to digital video converter, these devices can cause video noise to be injected on the signal. The transmitter will view this as a noisy source or a GPU that is using Temporal Dithering. This option is designed more for VGA to DVI/HDMI converters and will perform the function at a Medium capacity.

**C: VGA Low Bandwidth:** When using an analog to digital video converter, these devices can cause video noise to be injected on the signal. The transmitter will view this as a noisy source or a GPU that is using Temporal Dithering. This option is designed more for VGA to DVI/HDMI converters and will perform the function at a High capacity, filtering the most pixels this setting is considered to be the most aggressive out of the other 2 modes.



## CHAPTER 5: INSTALLATION

### 5.1 EMERALD RECEIVER (EMD2000SE-R, EMD2002SE-R, EMD2000PE-R, EMD2002PE-R) CHECKLIST

Before installing your Emerald SE Receiver, refer to the list below to ensure that you have all the items necessary for installation:

- ◆ Emerald SE or PE Receiver
- ◆ External power supply for the Emerald SE or PE Receiver
- ◆ Power cord
- ◆ Emerald SE or PE Quick Installation Guide (QIG)

### 5.2 EMERALD TRANSMITTER (EMD2000SE-T, EMD2002SE-T, EMD2000PE-T, EMD2002PE-T) CHECKLIST

Before installing your Emerald SE Transmitter, refer to the list below to ensure that you have all the items necessary for installation:

- ◆ Emerald SE or PE Transmitter
- ◆ External power supply for the Emerald SE or PE Transmitter
- ◆ Power cord
- ◆ Emerald SE or PE Quick Installation Guide (QIG)
- ◆ DVI and USB cables (USB cables are not included with the SE or PE, but PE does include one or two DVI cables for single-head or dual-head models)

### 5.3 EMERALD SE TRANSMITTER KIT (EMD2000SE-T-K OR EMD2002SE-T-K) CHECKLIST

Before installing your Emerald SE Transmitter, refer to the list below to ensure that you have all the items necessary for installation:

- ◆ Emerald SE Transmitter
- ◆ External power supply for the Emerald SE Transmitter
- ◆ Power cord
- ◆ DVI cable(s) (One DVI-D cable included for single-head [EMD2000SE-T], two DVI-D cables included for dual-head [EMD2002SE-T])
- ◆ USB A to USB B Device cable
- ◆ Emerald SE Quick Installation Guide (QIG)

### 5.4 EMERALD ZEROU DVI OR DP TRANSMITTER (EMD200DV-T OR EMD200DP-T) CHECKLIST

- ◆ Emerald ZeroU DVI Transmitter (EMD200DV-T) or Emerald ZeroU DisplayPort Transmitter (EMD200DP-T)

### 5.5 INSTALLATION OPTIONS



**WARNING:** To reduce the risk of electric shock or damage to your equipment, disconnect the power from the Emerald device by unplugging the power supply from the electrical outlet. To reduce the risk of electric shock or damage to your equipment, turn on the remote workstation and the Emerald Transmitter in the order described in the following procedures.

You can install the Emerald system either in a point-to-point or networked configuration.

## CHAPTER 5: INSTALLATION



**WARNING:** To avoid potentially fatal shock hazard and possible damage to equipment, please observe the following precautions:

- Test AC outlets at the workstation and monitor for proper polarity and grounding.
- Use only with grounded outlets at both the workstation and monitor. When using a backup Uninterruptible Power Supply (UPS), power the workstation and the Transmitter from the same supply.

**NOTE:** The AC outlet is the main disconnect.



### LASER WARNING

**WARNING:** Laser. If using an optical fiber SFP+ adapter when connecting an Emerald to a switch or other device, the user must observe precautions for working with a Class 1 laser product.



The EMD-PE units conform to IEEE802.3af but do not meet the isolation barrier requirements specified in subsection 33.4.1 – Isolation. The units meet the Safety Requirements of IEC 62368.

## 5.6 CONNECT THE EMERALD RECEIVER

The recommended sequence to connect the receiver is:

1. Connect your keyboard, monitor, mouse, and other peripheral cables to the appropriately labeled ports on the Emerald Receiver. On the dual-head model, video output #1 is closest to the USB ports on the receiver.
2. Connect the UTP cable to the RJ-45 port on the back of the Receiver.
3. Plug the external power supply's 2.5-mm connector into the DC power jack on the rear of the Emerald Receiver.
4. Connect the detachable power cord to the power supply.
5. Plug the power cord into an appropriate wall outlet. The unit automatically powers on.
6. A default connection is available to allow connection to a default Emerald Transmitter. You can use the OSD to add a different connection to a remote Transmitter or virtual desktop. The default Transmitter IP address is 192.168.1.22.
7. Once a Connection has been defined, use the OSD to make connection.

**NOTE:** VGA or analog video monitors can be connected to the Emerald Receiver by using a DVI-D to VGA converter (such as Black Box part number AC1038A).

**CAUTION:** When using PoE to power the Emerald PE Receiver, the appliance will supply up to 1 Watt of power to attached USB devices. If the connected USB devices consume more than 1 Watt in total, you must use the external power supply that was supplied with this appliance. The Receiver may not operate reliability if excess power is drawn.

**CAUTION:** The USB keyboard and mouse must be connected to the rear of the Receiver.

## 5.6.1 EMERALD SE RECEIVER

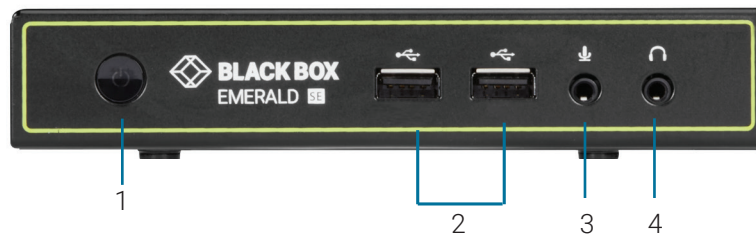

FIGURE 5-1. FRONT VIEW OF EMERALD SE RECEIVER, SINGLE-HEAD (EMD2000SE-R)

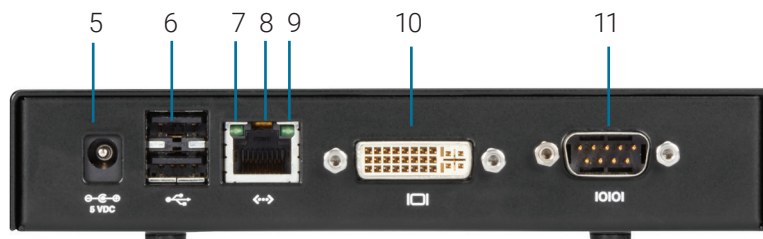

FIGURE 5-2. REAR VIEW OF EMERALD SE RECEIVER, SINGLE-HEAD (EMD2000SE-R)

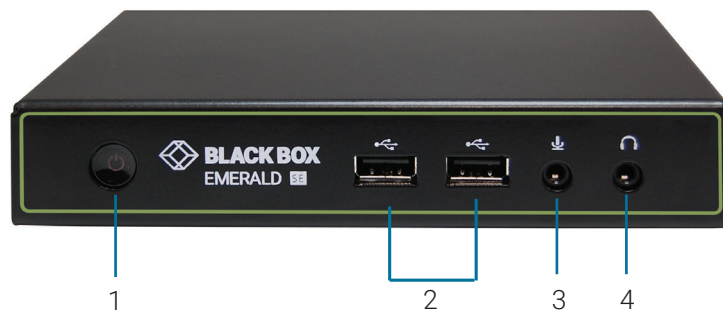

FIGURE 5-3. FRONT VIEW OF EMERALD SE RECEIVER, DUAL-HEAD (EMD2002SE-R)

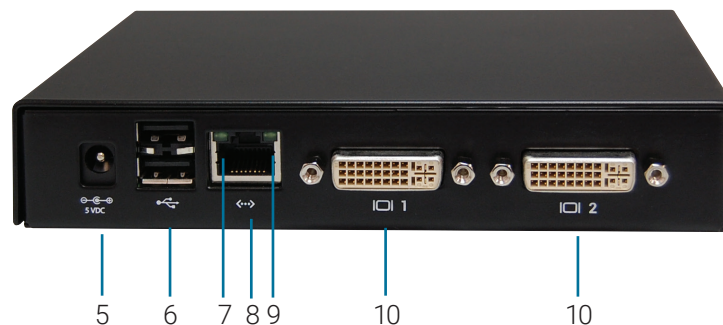

FIGURE 5-4. REAR VIEW OF EMERALD SE RECEIVER, DUAL-HEAD (EMD2002SE-R)

# CHAPTER 5: INSTALLATION

**TABLE 5-1. EMERALD SE RECEIVER COMPONENTS**

NUMBER IN FIGURES 5-1 THROUGH 5-4	COMPONENT	DESCRIPTION
1	Power button	Disabled; NOTE: The unit automatically powers on; it must be turned off at the power source.
2, 6	(4) USB Type A connectors	Link to USB devices
3	(1) 3.5-mm connector	Connects to microphone
4	(1) 3.5-mm connector	Connects to speakers
5	(1) 2.5-mm barrel connector for power	Links to 5-VDC external in-line power supply
7	(1) Link/Activity LED	Lights green when there is activity on the link
8	(1) RJ-45 connector	Links to 10-/100-/1000-Mbps network
9	(1) Link Speed LED	LED blinks green 1= 10 Mbps, 2 = 100 Mbps and 3= 1 Gbps in a 1.5 second interval. No blinking means no valid link
10	(1) or (2) DVI output connectors	Links to DVI output(s)
11	(1) DB9 connector*	Links to RS-232 serial interface

\*Single-head model only

## 5.6.2 EMERALD PE OR PE POE RECEIVER

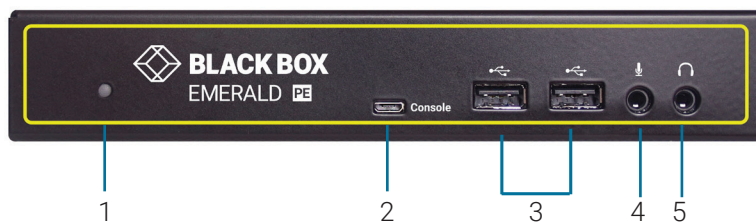

FIGURE 5-5. FRONT VIEW OF EMERALD PE RECEIVER, SINGLE-HEAD (EMD2000PE-R, EMD2000PE-R-P)

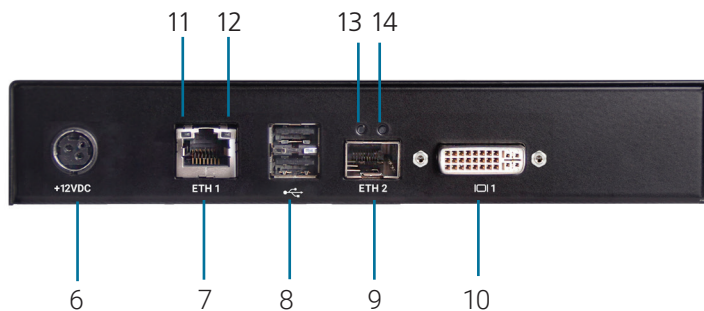

FIGURE 5-6. REAR VIEW OF EMERALD PE RECEIVER, SINGLE-HEAD (EMD2000PE-R, EMD2000PE-R-P)

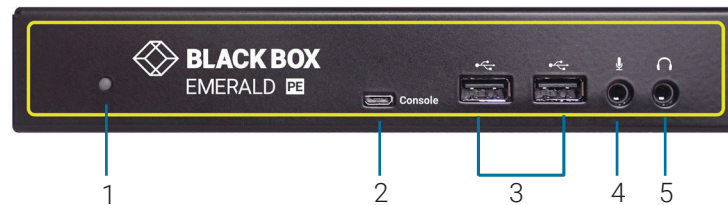

FIGURE 5-7. FRONT VIEW OF EMERALD PE RECEIVER, DUAL-HEAD (EMD2002PE-R, EMD2002PE-R-P)

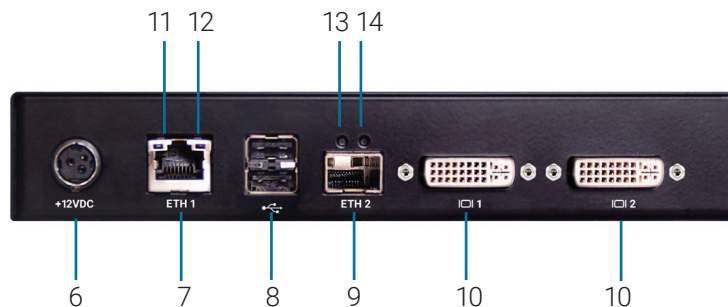

FIGURE 5-8. REAR VIEW OF EMERALD PE RECEIVER, DUAL-HEAD (EMD2002PE-R, EMD2002PE-R-P)

**TABLE 5-2. EMERALD PE OR PE POE RECEIVER COMPONENTS**

NUMBER IN FIGURES 5-5 THROUGH 5-8	COMPONENT	DESCRIPTION
1	Power LED	Lights when power is ON
2	Micro USB connector	Links to console
3	(2) USB Type A connectors	Connect to USB peripherals
4	Microphone	Connects to microphone
5	Speakers	Connects to speakers
6	12 VDC Power In connector	Connects to supplied power adapter
7	RJ-45 port	EMD2000PE-R, EMD2002PE-R: Connects to network; EMD2000PE-R-P, EMD2002PE-R-P: Connects to network and supports Power over Ethernet (PoE)
8	(2) USB Type A connectors	Connect to USB peripherals
9	SFP cage	Holds fiber network SFP module
10	(1) or (2) DVI Video connectors	Connects to monitor(s)
11	TP port Speed LED	Indicates 10/100/1000 Mbps
12	TP port Activity LED	Indicates activity on the link
13	Fiber SFP port Speed LED	Indicates 10/100/1000 Mbps
14	Fiber SFP port Activity LED	Indicates activity on the link

## CHAPTER 5: INSTALLATION

### 5.7 CONNECT THE EMERALD TRANSMITTER

Before connecting the Emerald Transmitter to the remote workstation, ensure that the resolution and the refresh rate of the remote workstation are supported by the Emerald system. Set the screen resolution and refresh rate of the remote workstation. Unsupported settings will cause blank or distorted video at the Receiver.

The recommended sequence to connect the Transmitter is:

1. Turn off the remote workstation.
2. The Emerald Transmitter has one USB connector. Connect it to a corresponding USB port on the remote workstation.
3. Connect the video connector(s) on the Emerald Transmitter to the appropriately labeled port on the workstation(s) using the DVI cable(s).
4. Connect one end of the UTP cable to the Emerald Transmitter's RJ-45 connector and turn on the workstation.
5. Route the other end of the UTP cable to the location you have chosen for the Emerald Receiver. If necessary, you can extend the UTP cable via an Ethernet switch (subject to normal Ethernet cabling practices).
6. Plug the external power supply's 2.5-mm connector into the DC power jack on the rear of the Emerald Transmitter.
7. Connect the detachable power cord to the power supply.
8. Plug the power cord into an appropriate wall outlet. The transmitter powers on automatically.
9. Turn on power for the remote workstation.

NOTE: Use only the power supply provided by Black Box.

#### 5.7.1 EMERALD SE TRANSMITTER



FIGURE 5-9. FRONT VIEW OF THE EMERALD SE TRANSMITTER, SINGLE-HEAD (EMD2000SE-T)

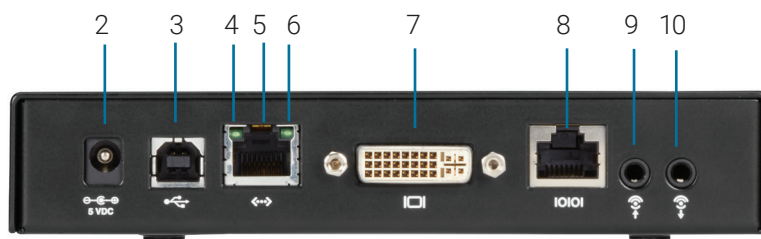

FIGURE 5-10. REAR VIEW OF THE EMERALD SE TRANSMITTER, SINGLE-HEAD (EMD2000SE-T)



FIGURE 5-11. FRONT VIEW OF THE EMERALD SE TRANSMITTER, DUAL-HEAD (EMD2002SE-T)

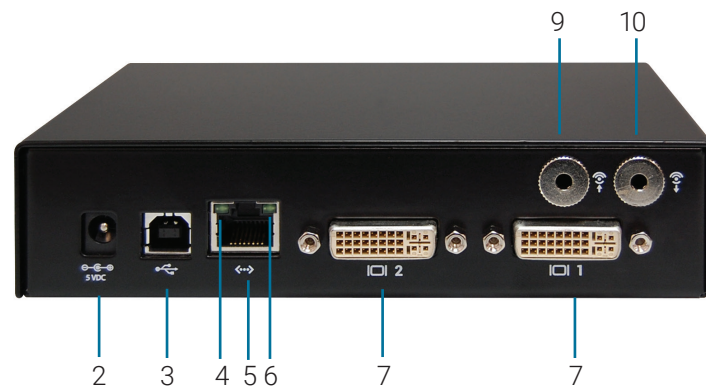

FIGURE 5-12. REAR VIEW OF THE EMERALD SE TRANSMITTER, DUAL-HEAD (EMD2002SE-T)

**TABLE 5-3. EMERALD SE TRANSMITTER COMPONENTS**

NUMBER IN FIGURES 5-9 THROUGH 5-12	COMPONENT	DESCRIPTION
1	Power LED	Disabled; NOTE: The unit automatically powers on; it must be turned off at the power source.
2	(1) 2.5-mm barrel connector for power	Links to 5-VDC external in-line power supply
3	(1) USB Type B connector	Links to USB input source
4	(1) Link/Activity LED	Lights green when there is activity on the link
5	(1) RJ-45 connector	Links to 10-/100-/1000-Mbps network
6	(1) 10/100/1000-Mbps LED	Lights green when data is being transmitted at 1000 Mbps
7	(1) or (2) DVI input connectors	Links to DVI input sources
8	(1) RJ-45 connector*	Links to RS-232 serial interface
9	(1) 3.5-mm connector	Links to audio
10	(1) 3.5-mm connector	Links to audio

\*Single-head model only

# CHAPTER 5: INSTALLATION

## 5.7.2 EMERALD PE OR POE TRANSMITTER

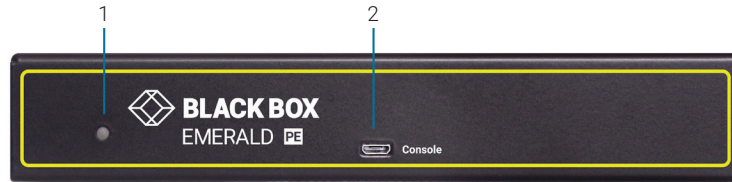

FIGURE 5-13. FRONT VIEW OF THE EMERALD PE TRANSMITTER, SINGLE-HEAD (EMD2000PE-T)

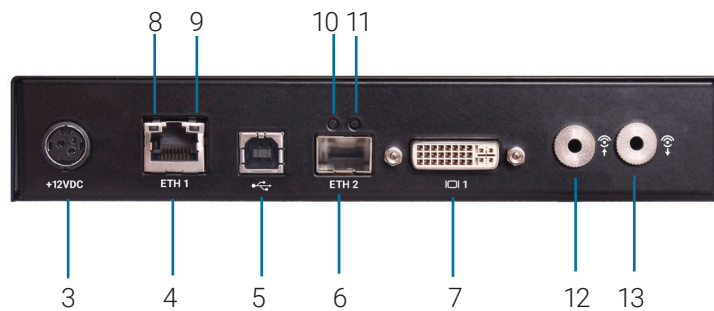

FIGURE 5-14. REAR VIEW OF THE EMERALD PE TRANSMITTER, SINGLE-HEAD (EMD2000PE-T)

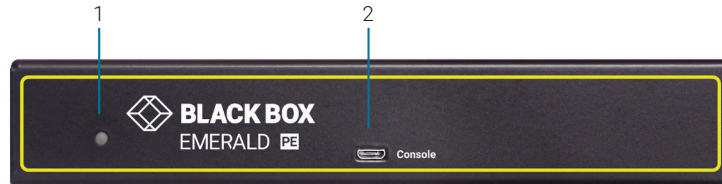

FIGURE 5-15. FRONT VIEW OF THE EMERALD PE TRANSMITTER, DUAL-HEAD (EMD2002PE-T)

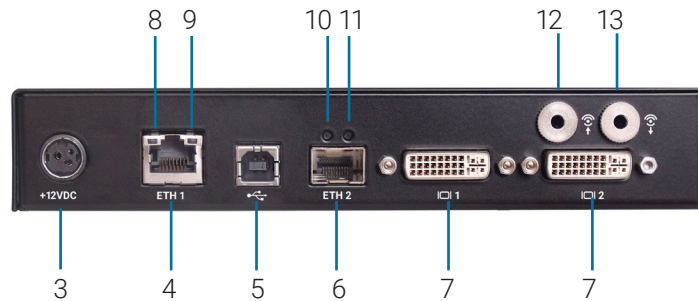

FIGURE 5-16. REAR VIEW OF THE EMERALD PE TRANSMITTER, DUAL-HEAD (EMD2002PE-T)

**TABLE 5-4. EMERALD PE OR PE POE TRANSMITTER COMPONENTS**

NUMBER IN FIGURES 5-13 THROUGH 5-16	COMPONENT	DESCRIPTION
1	Power LED	Lights when power is ON
2	Micro USB connector	Links to console
3	12 VDC Power In connector	Connects to supplied power adapter
4	RJ-45 port	EMD2000PE-T, EMD2002PE-T: Connects to network and supports Power over Ethernet (PoE)
5	USB Type B connector	Connects to PC/workstation USB connector
6	SFP cage	Holds fiber network SFP module
7	(1) or (2) DVI Video connectors	Connect to PC Video
8	TP port Speed LED	Indicates 10/100/1000 Mbps
9	TP port Activity LED	Indicates activity on the link
10	Fiber port Speed LED	Indicates 10/100/1000 Mbps
11	Fiber port Activity LED	Indicates activity on the link
12	Audio Line In	Connects to speakers
13	Audio Line Out	Connects to speakers

## CHAPTER 5: INSTALLATION

### 5.8 CONNECT THE EMERALD ZEROU DVI OR DISPLAYPORT TRANSMITTER

Before connecting the Emerald ZeroU DVI or DisplayPort Transmitter to the remote workstation, ensure that the resolution and the refresh rate of the remote workstation are supported by the Emerald system. Set the screen resolution and refresh rate of the remote workstation. Unsupported settings will cause blank or distorted video at the Receiver.

The recommended sequence to connect the Transmitter is:

1. Turn off the remote workstation.
2. The Emerald ZeroU DVI or DisplayPort Transmitter has two USB connectors. Connect them to the corresponding USB ports on the remote workstation.
3. Connect the DVI or DisplayPort video connector on the Emerald ZeroU DVI or DisplayPort Transmitter to the appropriately labeled port on the workstation using the DVI or DisplayPort cable.
4. Connect one end of the UTP cable to the Emerald ZeroU DVI or DisplayPort Transmitter's RJ-45 connector and turn on the workstation.
5. Route the other end of the UTP cable to the location you have chosen for the Emerald SE Receiver. If necessary, you can extend the UTP cable via an Ethernet switch (subject to normal Ethernet cabling practices).
6. The Emerald ZeroU DVI or DisplayPort Transmitter can be powered via the USB ports. Optionally, plug an external power supply's 2.5-mm connector into the DC power jack on the rear of the Emerald SE Transmitter.

NOTE: The power supply is not included and must be ordered separately (part number EMD2000-PSU).

7. Optionally, connect the detachable power cord to the power supply.
8. Optionally, plug the power cord into an appropriate wall outlet. The transmitter powers on automatically.
9. Turn on power for the remote workstation.

NOTE: Use only the power supply provided by Black Box.

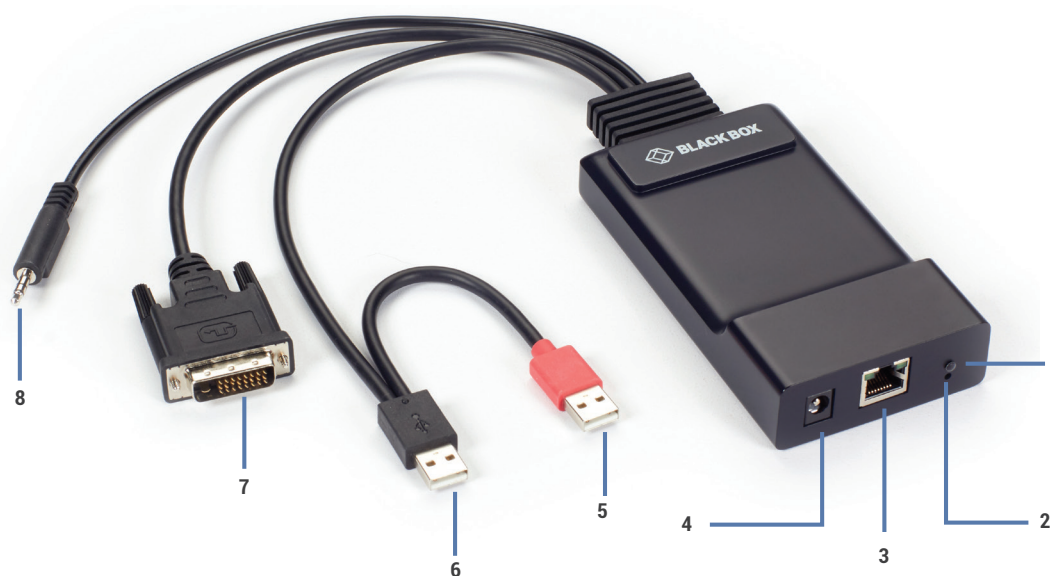

FIGURE 5-9. FRONT VIEW OF THE EMERALD ZEROU DVI TRANSMITTER, SINGLE-HEAD (EMD200DV-T)

## CHAPTER 5: INSTALLATION

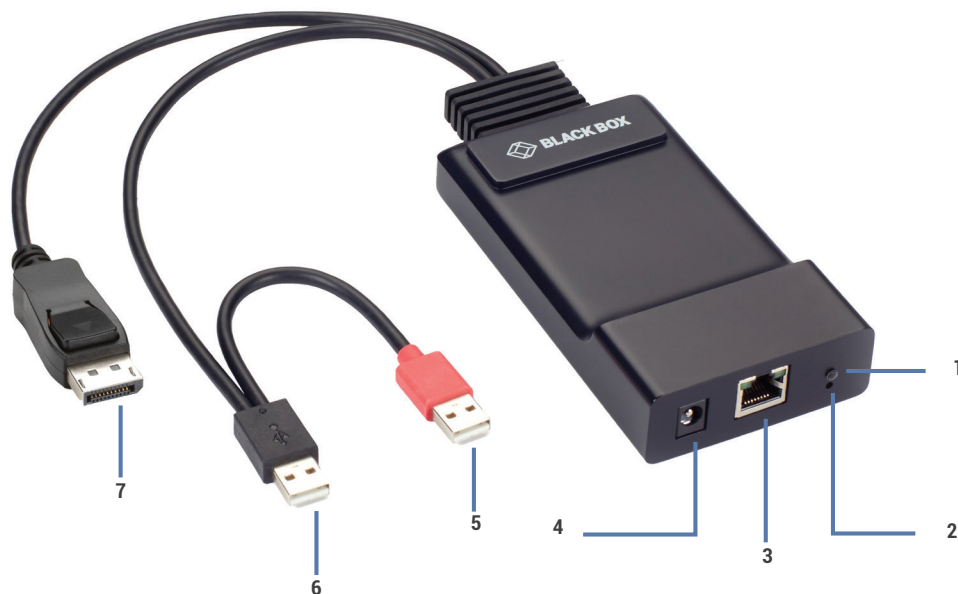

FIGURE 5-10. FRONT VIEW OF THE EMERALD ZEROU DP TRANSMITTER, SINGLE-HEAD (EMD200DP-T)

**TABLE 5-3. EMERALD ZEROU DVI OR DISPLAYPORT TRANSMITTER COMPONENTS**

NUMBER IN FIGURES 5-9 THROUGH 5-10	COMPONENT	DESCRIPTION
1	Power LED	Lights green when power is on
2	Reset button	Press to reset the unit
3	(1) RJ-45 connector	Links to 10-/100-/1000-Mbps network
4	(1) 2.5-mm barrel connector for power	Links to an optional 5-VDC external in-line power supply NOTE: The ZeroU Transmitter can be powered via the USB connectors.
5	(1) USB Type A connector	Connects to PC/workstation or USB power hub
6	(1) USB Type A connector	Connects to PC/workstation USB device
7	(1) DVI or DisplayPort input connector	Links to DVI or DisplayPort input video source NOTE: DisplayPort connector also supports embedded audio
8	(1) 3.5-mm connector	Links to speakers (on DVI model only)

## CHAPTER 6: NETWORKED INSTALLATION

### 6.1 POINT-TO-POINT INSTALLATION

In a point-to-point configuration, no administrator setup of the Emerald Transmitter or the Emerald Receiver is required. This enables you to install the system quickly, directly out-of-the-box. However, in the point-to-point configuration, you can install only one Emerald Transmitter and Emerald Receiver pair on a subnet, and both must be on the same subnet unless a router is present in the network to span subnets.

Also if there are other devices with 192.168.1.21 (default Receiver IP address) or 192.168.1.22 (default Transmitter IP address) on the network, then the IP addresses for Receiver and/or Transmitter should be changed to unused IP addresses.

### 6.2 UNMANAGED OR MANAGED MATRIX INSTALLATION

The following instructions will enable you to install your Emerald Receiver and Emerald Transmitter in a networked configuration. In this installation, multiple Emerald Transmitters and Emerald Receivers are attached via the same Ethernet network. In this case, it is important for each unit to be configured with a unique IP address.

The Emerald Receiver has been preconfigured with factory-default network settings. If you install multiple units on the same network, you will need to assign a unique IP address to each unit or configure the Receiver for DHCP. This can be done via the On-Screen Display (OSD) on the Emerald Receiver and must be carried out before adding multiple devices on the same network.

**TABLE 6-1. EMERALD SYSTEM DEFAULT NETWORK SETTINGS**

COMPONENT	IP ADDRESS	TYPE	DEFAULT GATEWAY	SUBNET MASK
Emerald SE Receiver (EMD2000SE-R, EMD2002SE-R)	192.168.1.21	Static	192.168.1.1	255.255.255.0
Emerald SE Transmitter (EMD2000SE-T, EMD2002SE-T)	192.168.1.22	Static	192.168.1.1	255.255.255.0
Emerald PE Receiver (EMD2000PE-R, EMD2002PE-R)	192.168.1.21	Static	192.168.1.1	255.255.255.0
Emerald PE PoE Transmitter (EMD2000PE-T, EMD2002PE-T)	192.168.1.22	Static	192.168.1.1	255.255.255.0
Emerald PE PoE Receiver (EMD2000PE-R-P, EMD2002PE-R-P)	192.168.1.21	Static	192.168.1.1	255.255.255.0
Emerald ZeroU DVI Transmitter (EMD200DV-T)	192.168.1.22	Static	192.168.1.1	255.255.255.0
Emerald ZeroU DisplayPort Transmitter (EMD200DP-T)	192.168.1.22	Static	192.168.1.1	255.255.255.0
Boxilla Manager (BXAMGR)	192.168.1.24	Static	192.168.1.1	255.255.255.0



## CHAPTER 7: OPERATION OF EMERALD SYSTEM

Operating a workstation through the Emerald system is no different than working directly connected to a PC desktop. All peripherals operate as if directly connected, even though the workstation is located at a distance.

### 7.1 LED IDENTIFICATION

#### Front panel

There is a Power button on the front panel of an Emerald SE unit. This button is disabled. The Emerald PE unit has a power LED but does not have a power button.

NOTE: The SE or PE unit powers on automatically when plugged in and must be turned off at the power source.

The Emerald ZeroU DVI or DP Transmitter unit has a Power LED. It can be powered either via USB or via an optional power supply.

#### Rear panel

Two LEDs are built into the RJ-45 connectors on the Emerald SE Receiver, Emerald SE Transmitter, and Emerald ZeroU DVI or DisplayPort Transmitter. The definition of the operation of these LEDs is shown in Table 7-1.

**TABLE 7-1. RJ-45 CONNECTOR LEDS ON THE REAR PANEL OF THE EMERALD SE RECEIVER AND TRANSMITTER**

LED	STATUS	DESCRIPTION
Activity	Green ON	Linked OK
	Green Flashing	Transmit/Receive activity
	Green OFF	No Link
Link Speed	Blinks green one time	10 Mbps
	Blinks green two times	100 Mbps
	Blinks green three times	1000 Mbps
	No blinking	No valid link

### 7.2 ACCESSING THE SYSTEM

A connection is established using the OSD on an Emerald Receiver or Boxilla Manager. Once you are connected, a series of messages will be displayed on the screen to inform you of the progress of the connection. You will be able to interact with the remote workstation as if it were located at your desk.

NOTE: If the remote workstation is powered off, the Emerald system will display a “black” screen for video when a connection is made.

## CHAPTER 8: OSD FUNCTIONS

The Emerald Receiver and Boxilla Manager incorporate an On-Screen Display (OSD) that allows you to view information about the configuration of your system and potentially also allows for setting connections and configuration parameters such as the IP address, depending on the type of user. The following sections describe the operation common on a Receiver.

### 8.1 USER TYPES

The Emerald system supports three classes of users for Matrix products:

1. Administrator – users of this class have full rights to configure the system. They can create/modify/delete new users and connections, change network settings, etc.
2. Power User – users of this class can modify resolution for connections to virtual desktops and change his/her local password.
3. Standard User – users of this class can only select from a list of pre-defined connections to access and view system information. They cannot change any configuration settings.

### 8.2 LOG ON

A user must log-on to the Emerald Receiver or Boxilla Manager to configure and manage the Emerald system. The log-on screen is shown in Figure 8-1. The username defines the access rights and configuration available to the user.

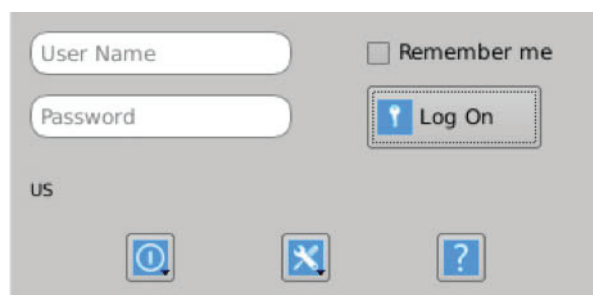

FIGURE 8-1. OSD LOG-ON SCREEN

The fields on this screen are:

- ◆ Username: the username to log-on as defined by the Administrator. Username is case-sensitive.
- ◆ Password: password for the user. Password is case-sensitive.
- ◆ Remember Me: When this box is checked, the unit keeps the username between log-ons and power-cycles. When this box is not checked, the username field is always presented as blank when powered-up and after a log-out. This tick-box only affects the username – the password is never preserved.
- ◆ Power Button: This button allows the user to reboot the client.

## CHAPTER 8: OSD FUNCTIONS

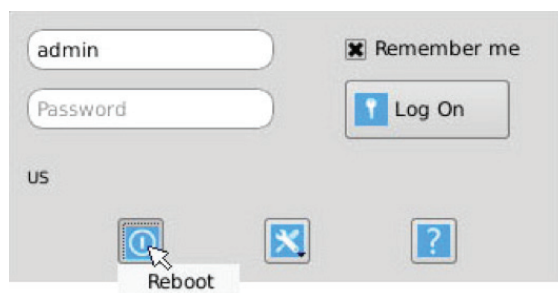

FIGURE 8-2. LOG-ON SCREEN - REBOOT BUTTON

- System Preferences: This button has a drop down menu that allows the user to define system preferences for the Emerald Receiver. Figure 8-3 shows how the keyboard type can be selected.

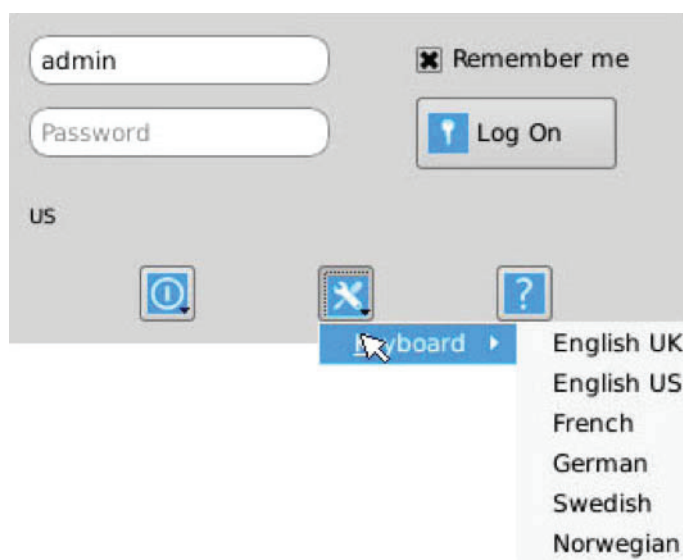

FIGURE 8-3. SETTING SYSTEMS KEYBOARD TYPE

Help: This button opens a pop-up window with help on that screen.

### 8.3 DEFAULT USERNAME AND PASSWORD

The Emerald Receiver ships with a default username of admin with a blank password (i.e. no password). This user cannot be deleted, but the password can be changed.

NOTE: If you create a password for the default Admin account and forget it, there is no way to reset / retrieve it unless using a Boxilla manager. We recommend that the administrator creates a second Admin account for critical systems in case the main Admin account is locked out.

## CHAPTER 8: OSD FUNCTIONS

### 8.4 USER VIEWS AND CAPABILITIES

There are three different types of users in the Emerald System. Your user type will determine what exactly you will see on your OSD. For the purpose of this Manual, we show the screen of an Administrator. This means that some buttons shown here may not be available to other users.

The Emerald comes as an unmanaged system and as a managed system. There are some differences in the OSD for these systems which you may see here..

### 8.5 CONNECTIONS SCREEN

When a user successfully logs on to the Emerald Receiver or Manager, the Connection screen is displayed. This is shown in Figure 8-4. The connections that a user can make are listed in the connection window. The user logged on is shown in the top right corner of the OSD.

NOTE: Default\_TX  
is 192.168.1.22

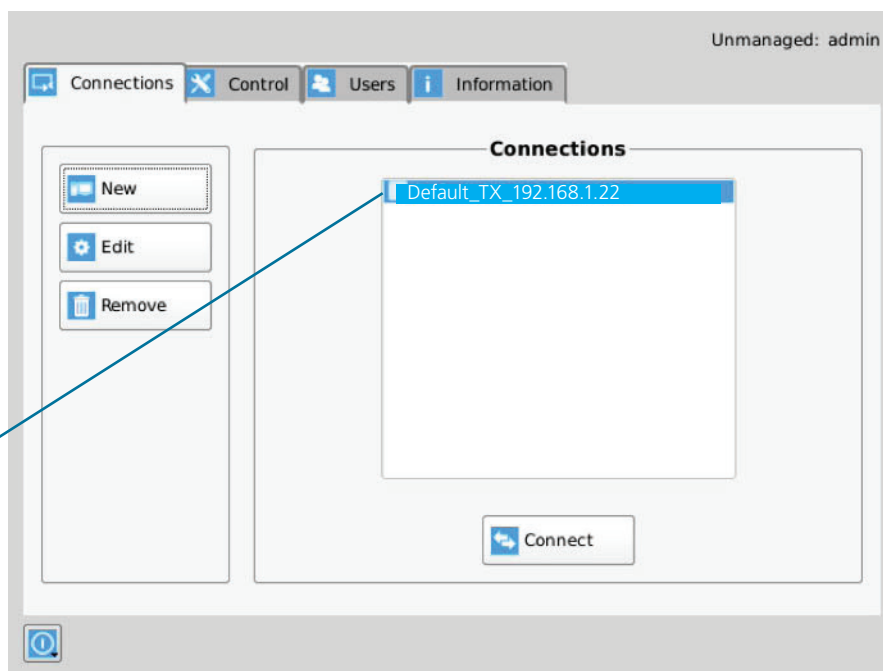

FIGURE 8-4. CONNECTION SCREEN

If the user is an Administrator type, the three buttons on the left (New, Edit, and Remove) will be displayed. These allow the user to create, edit, or remove connections. For Standard User types, no connections can be created, edited, or removed, so these buttons are not displayed or are greyed out.

By default, there is one connection called "Default Tx - 192.168.1.22" that defines a connection to an Emerald Transmitter with its factory defaults. A maximum of 32 connections can be defined for an Emerald Receiver by default, and these connections can be shared by users as defined by an administrator (different users can have the same connection). The number of connections can be increased to unlimited in a managed domain via Boxilla upgrade licenses.

## CHAPTER 8: OSD FUNCTIONS

### 8.5.1 CREATING A NEW CONNECTION

To allow an Emerald Receiver or Manager to connect to a target Emerald Transmitter, an administrator must create a connection. The administrator clicks on the New button on the Connections screen. This causes the New Connections pop-up window to appear as shown in Figure 8-5.

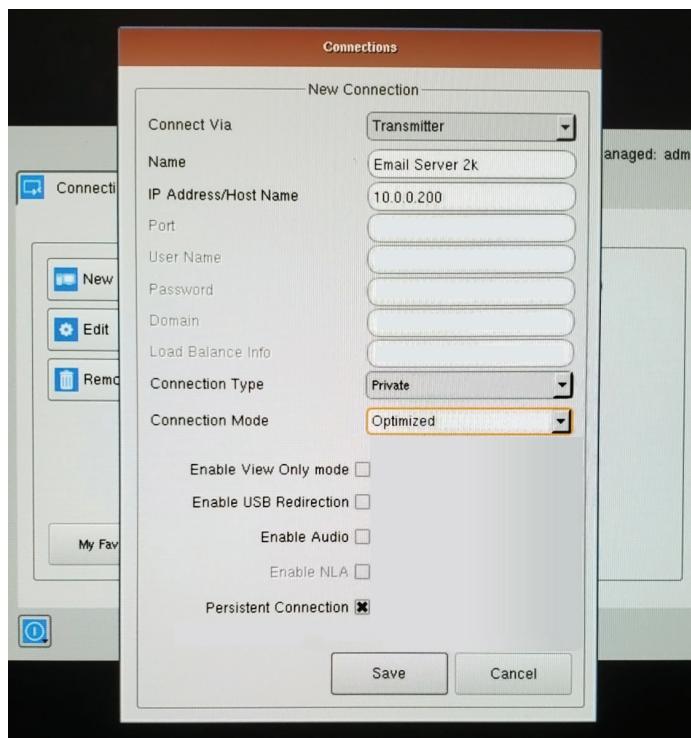

FIGURE 8-5. NEW CONNECTION WINDOW

The fields on this screen are:

- **Name:** this is a unique name for the new connection. The name can be between 1 and 32 characters. The name can be composed of any Alphanumeric characters and special characters except for “ / \ [ ] ; | = , + \* ? < > `”.
- **IP Address/Host Name:** IP Address of Emerald Transmitter (if Connection Via set to Transmitter) or VM in IP v4 format. Alternatively it can be the Host Name if this can be resolved in the local DNS server. Note: Using Host Name will increase the switching time by the time needed to resolve the Host Name to an IP address;
- **Port:** defines the port to be used for the RDP connection for connections via VM Direct or Broker. Uses 3389 by default;
- **Username:** defines username to be used on a VM connection. Only used for connections via VM Direct or Broker. If left “blank” on VM Direct – user will be presented with Windows Login screen on VM;
- **Password:** defines password to be used on a VM connection. Only used for connections via VM Direct or Broker;
- **Domain:** defines domain that a Virtual Machine is part of (if part of a windows domain). Not used for connections to Transmitters.
- **Load Balance Info:** Defines resources on the broker (VM Pool that the receiver will attempt to connect to after user credentials have been validated. Only used on connection via Broker.
- **Connection Type:** Used to define whether a connection is Private or Shared (i.e. other connections of type Shared can join in session and share keyboard, mouse, and video). Only available if connection via set to Transmitter.

## CHAPTER 8: OSD FUNCTIONS

- ◆ **Connection Mode:** To allow users to connect from a 4K Receiver to connect to Emerald SE, PE, and ZeroU transmitters: The connection on the 2K transmitter must be set to Optimized. Go to Connections and create a new connection (or Edit an existing connection). Enter all of the connection details (or confirm they are correct) and a new option can be selected for Compression Mode. For 4K RX to 2K TX: Compression Mode = Optimized. NOTE: Currently you cannot connect a 2K RX to a 4K TX
- ◆ **Enable Extended Desktop:** Remote connections can be extended for dual-head Emerald units by enabling the option Extended Desktop. Enable Extended Desktop setting enables the second video head of a dual head Transmitter. Make sure both the video heads on the Transmitter are connected to the source. Video heads on the receiver are connected to respective monitors.
- ◆ **Enable View Only mode:** View only setting for a connection allows user to monitor what is been transmitted from a source without being able to interact with the source. This feature allows a user or administrator to monitor the actions on the network without accidentally interacting with other users. View only connection is available in both private and shared mode connections with or without analog audio.
- ◆ **Enable USB Redirection:** when set, this enables non-keyboard and non-mice devices (such as tablets and USB headsets) to be redirected for this connection.
- ◆ **Enable Audio:** when set, this enables audio to be supplied to the remote audio connectors.
- ◆ **Enable NLA:** when set, this enables Network Level Authentication requiring that the user be authenticated to the RD Session Host server before the session is created. This is not used for when Connection Via is set to Transmitter.
- ◆ **Persistent Connection:** When turned on, Persistent Connection will constantly try to connect the Receiver with the Transmitters until successful. This is useful when using Emerald for digital signage or an application that does not need a keyboard/mouse to stay connected to a defined source.

### 8.5.2 CONNECTION FAVORITES

Connection favorites provide a quick convenient mechanism for users to switch between their pre-defined connections. Favorites are configured by the administrator where a maximum of 10 favorites can be assigned to users using a combination of hotkey and [0-9].

#### Assigning Connection Favorites

A pre-requisite is that the user exists and has connects assigned.

The following screenshot demonstrates the administrator assigning connections for the user to the available hotkeys. Favorites do not need to be allocated sequentially and hotkeys can be skipped.

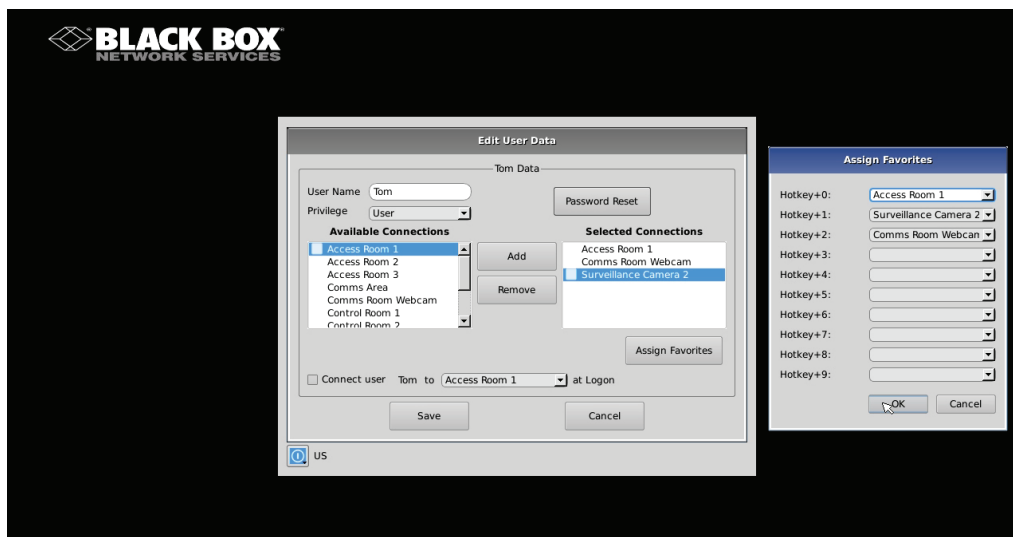

FIGURE 8-6. ASSIGNING CONNECTION FAVORITES

## CHAPTER 8: OSD FUNCTIONS

Listing Connection Favorites:

When a user logs in, they can view their assigned favorites.

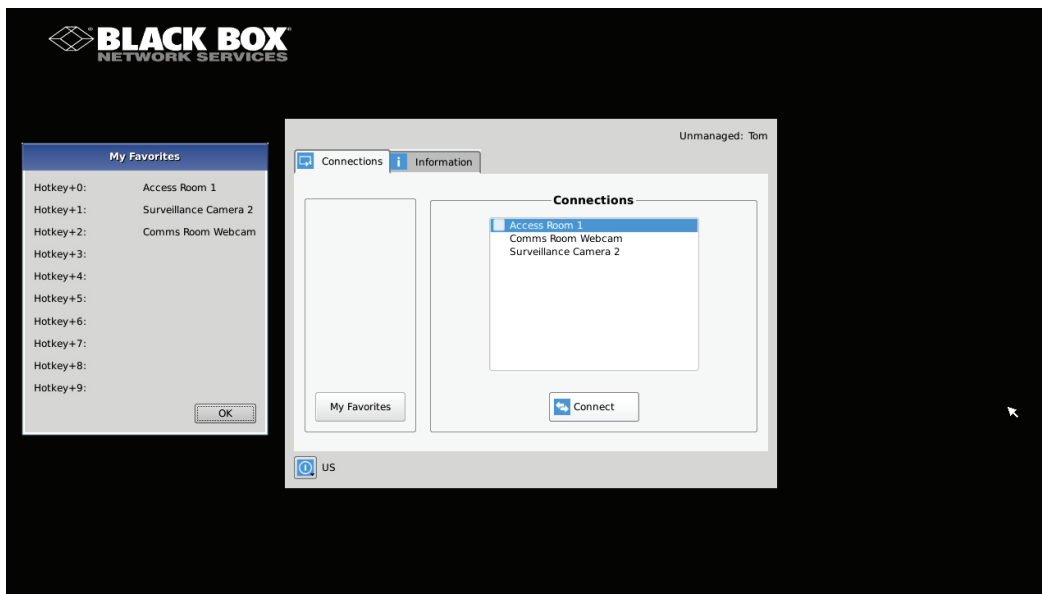

FIGURE 8-7. LISTING CONNECTION FAVORITES

### 8.5.3 CONNECTING

To make a connection, the user highlights the required “connection” in the window and then clicks on the “Connect” button. Alternatively, a user can double-click on the connection. This action causes the Emerald Receiver to attempt to connect to the target remote workstation or virtual machine. If the target is available, the connection will be made.

If another user is already connected to the target defined in the connection, the user will receive a pop-up window indicating the target device is already allocated.

### 8.5.4 EDIT CONNECTION

To edit a connection and change its parameters, an administrator clicks on the Edit button on the Connections screen. The Edit Connections pop-up window appears.

The administrator changes required fields and clicks Save to confirm or Cancel to discard any changes.

### 8.5.5 REMOVE CONNECTION

To remove or delete a connection, an administrator highlights a connection in the list and then clicks on the Remove button on the Connections screen (shown in Figure 8-8). This causes the Remove Connection pop-up window to appear where a user confirms the removal or cancels the attempt.

## CHAPTER 8: OSD FUNCTIONS

### 8.5.6 BONDING

This assumes that setup is complete on Boxilla and a user has permission to connect to a Bonded connection. See the setup instructions in the Boxilla user manual.

When the user selects a “bonded connection” from any Receiver that is part of a bonded group, Receiver 1 will connect to Connection 1 and receiver 2 will connect to connection 2 and so on up to 8.

Connections will all be made assuming they are available using the normal rules – e.g., If one connection is in a private connection and therefore cannot be connected to – all connections within the bond will fail. The user will get an error message from the user station they requested explaining why connection could not be made and will identify the user in private connection.

Once the user has a successful connection, if they disconnect using the OSD, all connections will be terminated.

While the user is in a bonded connection and if they wish to switch one of the receivers to another connection without dropping the full bonded setup, they shall use favorites and this receiver will switch to the desired target without calling the OSD and leaving all other connections in the bonded connection up and running. The exception to this is that favorites cannot be used from receivers that launched connections via Boxilla.

### 8.6 CONTROL TAB

The Control Tab on the OSD enables an administrator to change the configuration of the Emerald system. The Control Tab is shown in Figure 8-8.

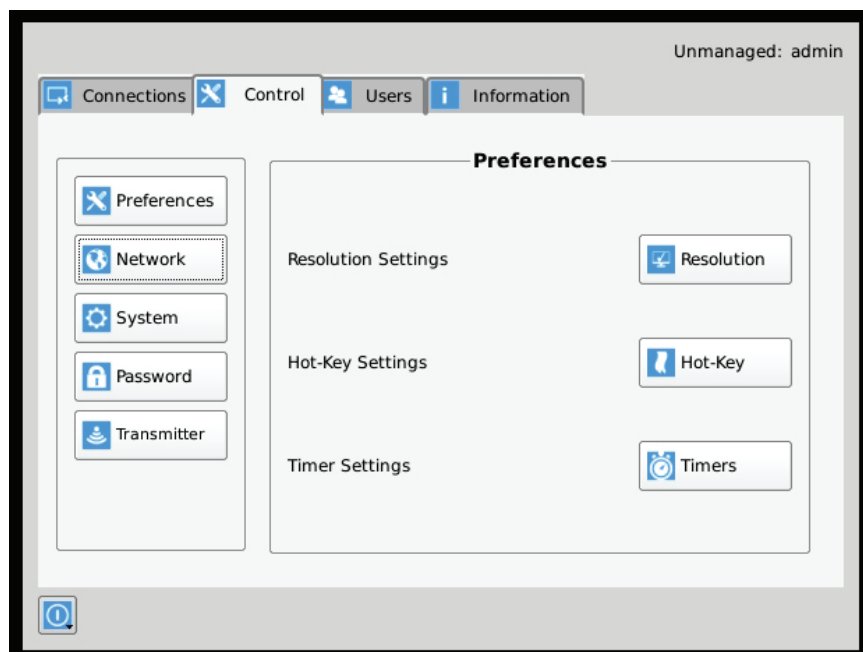

FIGURE 8-8. CONTROL TAB

## CHAPTER 8: OSD FUNCTIONS

There are five functions that can be accessed on this tab:

1. Preferences – allows users to change preference settings for:
  - i. Resolution Settings – allows change of preferred resolution for OSD screens and Virtual connections.
  - ii. Hot-Key Settings – allows changing of the active hot-key for keyboard short-cuts.
  - iii. Timer Settings – allows setting of pre-emption timer and various inactivity timers
2. Network – allows administrator to change network parameters for the Emerald Receiver or Manager.
3. System – allows upgrading of unit firmware, reset unit to factory defaults, and to save/restore unit configuration to a USB drive.
4. Password – change the administrator or user password.
5. Transmitter – allows changing of Transmitter parameters.

### 8.6.1 PREFERENCES

#### Resolution

The Resolution button allows an administrator or power user to set the preferred resolution for the RDP Connection and for the OSD. By default, both the RDP Resolution and the OSD Resolution are set to Auto.

The RDP Connection Resolution allows the resolution to be changed for an RDP connection, (i.e. defines the resolution that the virtual desktop will be accessed with). If the preferred resolution is not supported, the Receiver will use the next highest resolution supported by both monitor and Receiver.

The OSD Resolution is set to Auto by default, but can be changed to the available OSD resolutions if the user wants to set a specific resolution. This setting has no effect when connecting to an Emerald Transmitter.

Click Apply button to save the change.

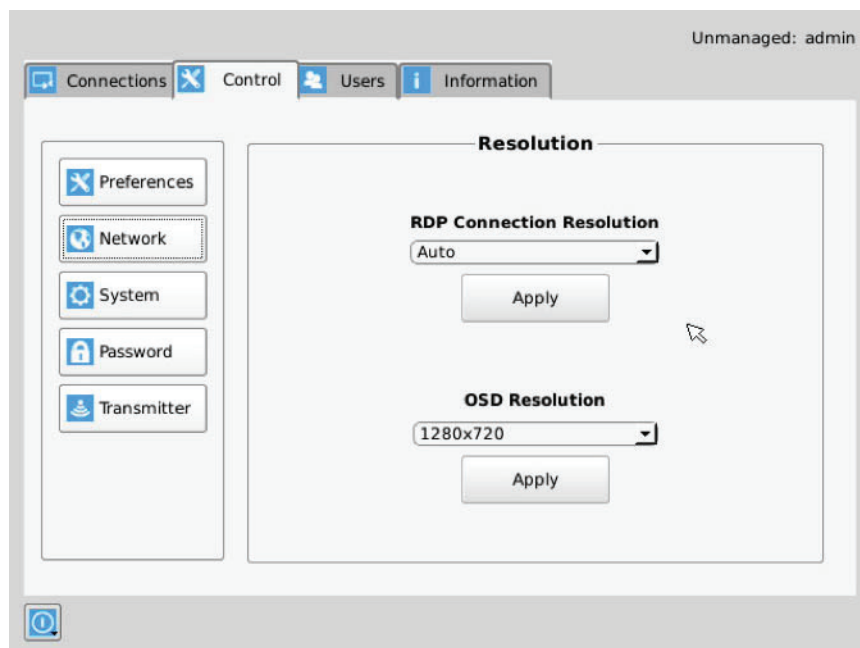

FIGURE 8-9. RESOLUTION SCREEN

## CHAPTER 8: OSD FUNCTIONS

### Hot-Key

The Hot-Key button allows the administrator to change the hot-key configuration. The hot-key is used with the "o" key to terminate the current connection and bring up the OSD. The hot-key with "p" key is used to switch to the previous connection without loading the OSD. Example: PrtScrn, O (default).

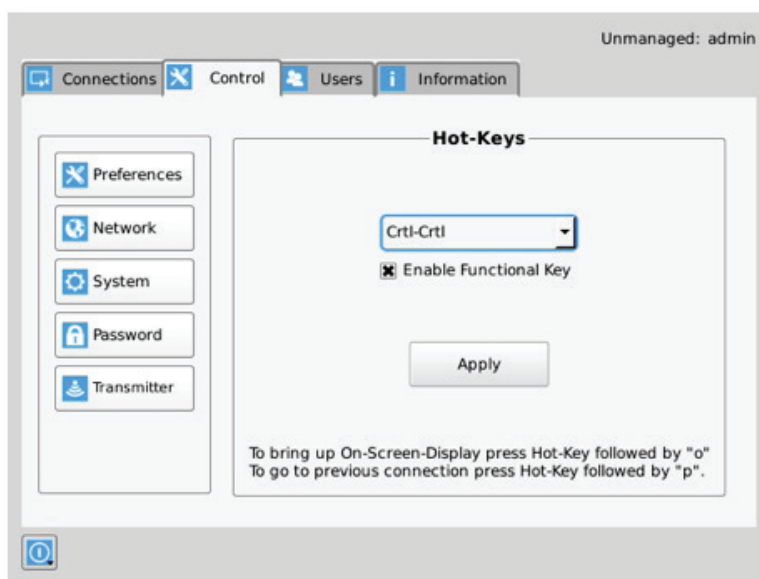

FIGURE 8-10. HOT KEY DEFINITION

The default hot-key is Print-Screen (PrntScrn). The alternatives are shown in the table. Click the Apply button to confirm a hot-key change.

TABLE 8-1. HOTKEY SEQUENCES

SEQUENCE	ACTION
Print Screen (Default)	-press Prnt Scrn key
Ctrl + Ctrl	-press Ctrl key twice within 1 second
Alt + Alt	-press Alt key twice within 1 second
Shift + Shift	-press Shift key twice within 1 second
Open OSD: Hotkey O	Switch to previous target: Hotkey P
Mouse-Left + Right	-press mouse left and right buttons at the same time for 2 seconds

The "Enable Functional Key" tick-box is used to disable the use of the function keys after the hot-key. So only the Hot-Key is required to bring up the OSD. The Enable functional Key is set by default.

## CHAPTER 8: OSD FUNCTIONS

### Timer Settings

There are 2 timer settings available to users as shown in Figure 8-12. By default, they are turned off. If you wish to turn them on, you have to select the desired timer, set the time you wish, and click apply. The three timer settings are:

1. OSD Inactivity Timer – This sets a limit on how long a user can be logged on to the OSD without any keyboard or mouse activity. Once the user reaches the inactivity timer, he/she will be logged out of the OSD. The timer value can be set to a number from 2 to 60 minutes.
2. Connection Inactivity Timer – This sets a limit on how long a user can be connected to a source (virtual machine, Transmitter etc.) without any keyboard or mouse activity. Once the session reaches the inactivity timer, he/she will be logged out of their connection and return to the OSD. The timer value can be set to a number from 2 to 60 minutes.

NOTE: Inactivity occurs when the mouse or keyboard is not pressed or moved for a set period of time.

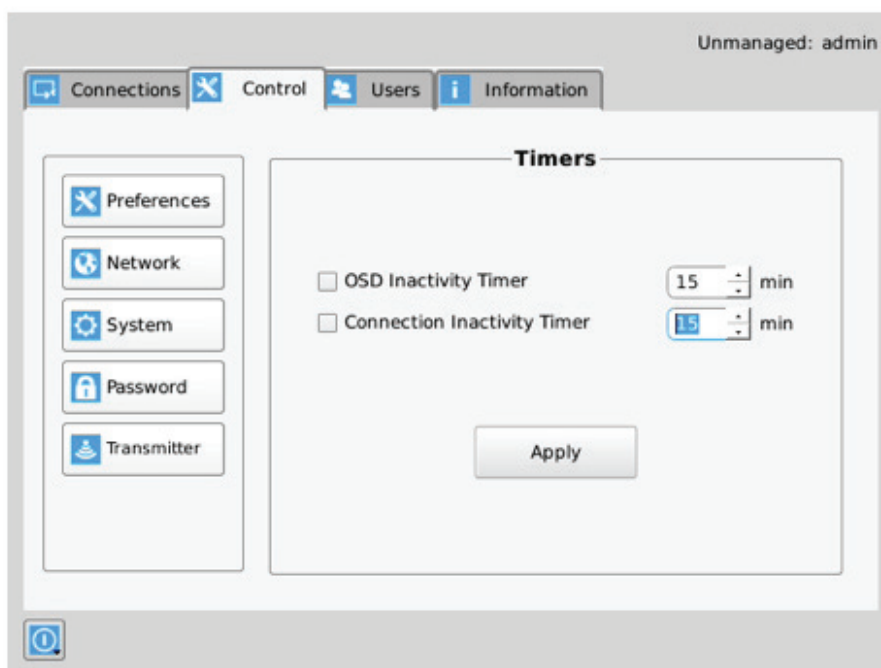

FIGURE 8-11. TIMER SETTINGS

## CHAPTER 8: OSD FUNCTIONS

### 8.6.2 NETWORK

The network screen shown in Figure 8-13 allows an administrator to change the settings for the Emerald Receiver or Manager. The default network setting for the Receiver is a static IP address of 192.168.1.21. It has a Network Mask of 255.255.255.0 and a Gateway 192.168.1.1. If DHCP is selected, the Receiver gets its IP address from the DHCP server. Click the Apply button to confirm any changes to network settings.

NOTE: Only IPv4 addressing supported in current firmware version.

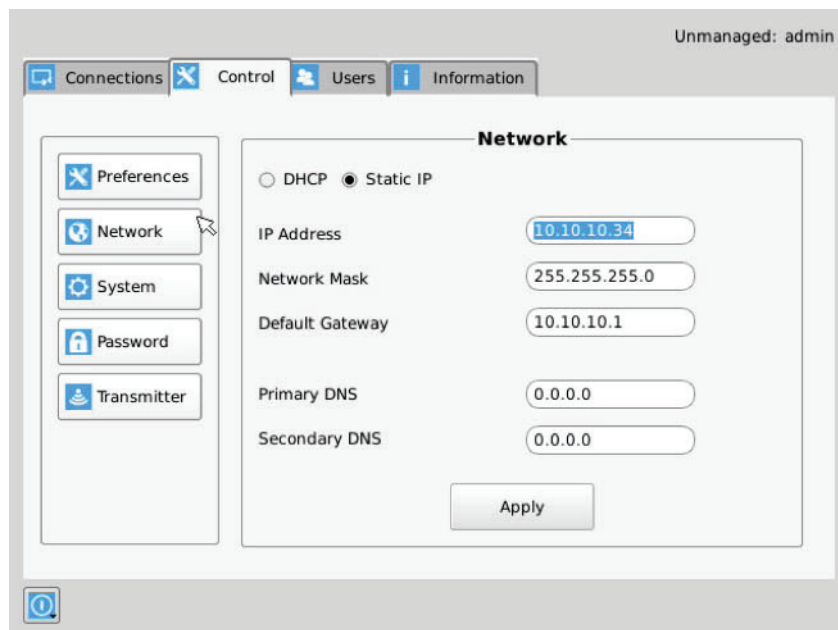

FIGURE 8-12. NETWORK SETTINGS

## CHAPTER 8: OSD FUNCTIONS

### 8.6.3 SYSTEM

The System screen shown in Figure 8-14 allows an administrator to upgrade the firmware in the Emerald Receiver, reset it to factory defaults, import/export the configuration to an external USB drive, and perform a system diagnostic.

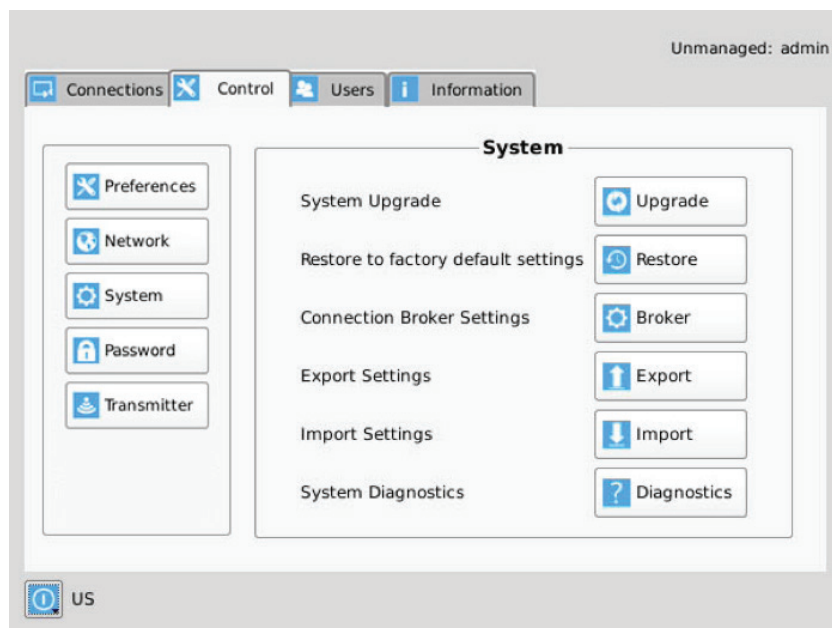

FIGURE 8-13. SYSTEM SCREEN

#### System Upgrade

The Emerald Receiver can be upgraded from a USB Flash drive. Simply take the “firmware.clu” file and place it in the root directory of the flash drive. When you click the Upgrade button, the “valid” upgrade files on the USB drive are displayed. A valid file has the extension .clu – an example is shown in Figure 8-15. If the flash drive isn’t recognized, format the drive using Fat32 file system.



FIGURE 8-14. UPGRADE FILES

## CHAPTER 8: OSD FUNCTIONS

Once the administrator has selected the file and clicked Ok, the system checks that the selected file has no errors before upgrading the Emerald Receiver. The configuration of the unit is preserved through the upgrade.

### Restore Factory Defaults

The administrator can click the Restore button to reset the Receiver back to factory defaults.

### Connection Broker Settings

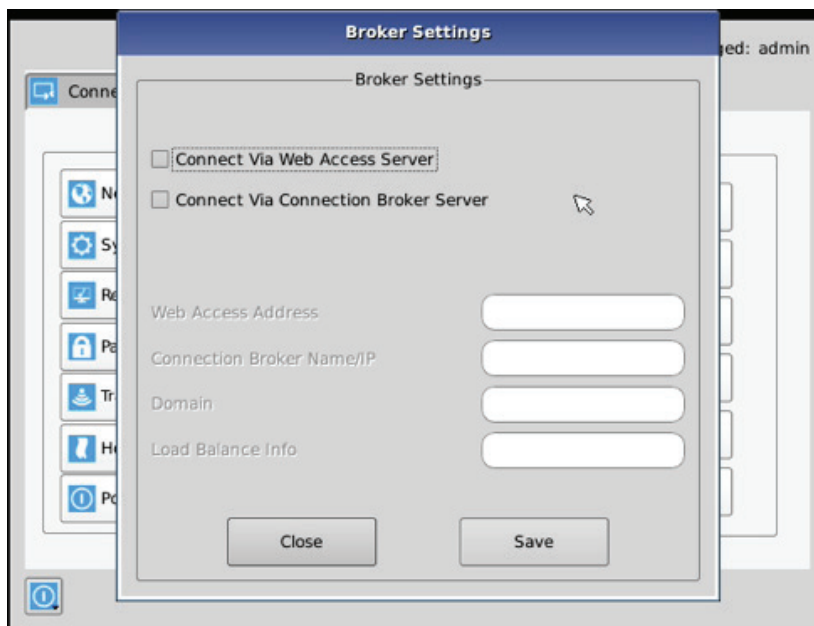

FIGURE 8-15. CONNECTION BROKER SETTING SCREEN

The Web Access Server setting is used to allow access to a local copy of Active Directory. If this setting is configured correctly, then if a user who is not configured in the local database attempts to login, the device will redirect the username and password to the local active directory installation and validate the user credentials.

If the user is validated, the Active Directory Server will return a valid VM pool-name to the device. The device sends this pool-name information to the Connection Broker which then allocates a Virtual Machine to the User, provided a VM is available.

On the Receiver when the user attempts to login, the login will now take the following steps in this order:

1. The login credentials are checked to see if the user is configured locally on the Receiver. Should the user exist, they will be logged in as normal. If not, then step two will occur. If neither "Connect via Web Access Server" nor "Connect via Connection Broker Server" is ticked, the Receiver at login will only attempt to authenticate the user locally. This is the default setting.
2. If the Web Access Settings are configured, the Receiver will attempt to launch a connection to an RD Web Access server. This will allow the user to be Authenticated against the Domain Controller (Active Directory) allowing the user to access Virtual Desktop Pools and Personal Virtual desktops.

To enable the receiver to access an RDWeb server at login, apply the following settings.

1. The Web Access Address should be the login page of the local RD Web Access Server using its IP address, e.g. <https://192.168.10.7/RDWeb/Pages/en-US/login.aspx>.

NOTE: We currently do not support hostnames in the web address so please use the IP of the Web Access server. You must place the full address to the login page of the RD Web Access server ([https://\\*\\*\\*\\*\\*.aspx](https://*****.aspx)).

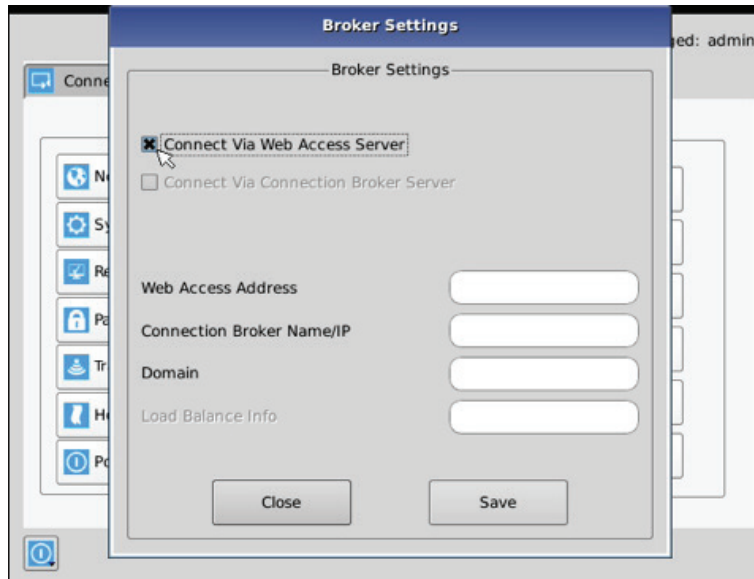

FIGURE 8-16. CONNECTION BROKER SETTINGS FOR WEB ACCESS SERVER

2. Enter the local Connection Broker IP address.
3. Enter in the local domain name.

Alternatively, the user credentials can be validated by using the local Connection Broker. In this case, the User Credentials are sent to the Connection Broker. If accepted, then the broker will return the IP address of a local VM from the pool and a connection is made.

NOTE: We currently do not support hostnames, so use the IP of the connection broker server.

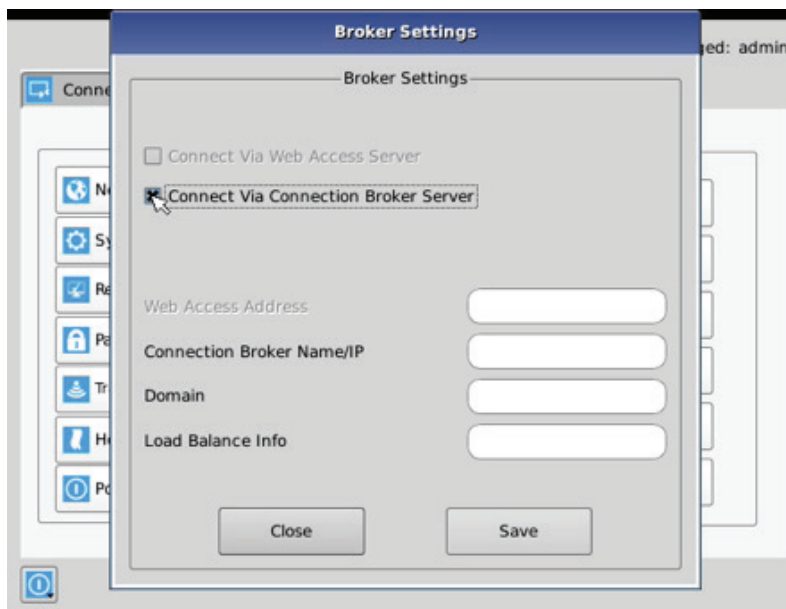

FIGURE 8-17. CONNECTION BROKER SETTINGS FOR CB SERVER

## CHAPTER 8: OSD FUNCTIONS

Tick the box “Connect Via Connection Broker Server” to enable connection using local Connection Broker Server. Then enter the following settings:

1. Enter in the domain name as defined on the local network.
2. Enter in your load balance address as defined in the local server configured, e.g. tsv://VMResource.1.Win7Pool.

### Export Settings

The Export option exports an encrypted version of the Receiver configuration to an attached memory stick. This can be used as a backup mechanism for an individual receiver or manager or it can be used to port configurations from one Receiver to another.

The data in the export file consists of User, Connection and device information from the exporting device.

### Import Settings

The Import option imports an encrypted version of a Receiver configuration from an attached memory stick. This can be used to recover an old backup from the same Receiver or it can be used to port configurations from another Receiver.

The data in the file consists of User, Connection and some device information from the exporting device.

The following settings are not imported.

1. OSD Preferred Resolution
2. Static IP address. In this case, if the importing device is set to static but the import file has a DHCP configuration, then the device configuration is changed to DHCP. Likewise, if the local device was DHCP and the import file was Static, the device configuration is change to Static but with its last configured Static IP address, not that of the imported file. If both local device and import file have a Static IP address configured, there is no change to the device configuration, i.e. the IP address is not changed.

NOTE: If the Import function is on the Manager, then the file must come from another Manager with the same Licensed Capabilities or the import will not proceed.

### System Diagnostics

The diagnostics provides information for Black Box to debug customer encountered issues. When this button is clicked the user is asked to save the diagnostics onto a memory stick in the Receiver unit. This file should be sent back to Black Box for analysis. There is a similar diagnostic that can be run on a transmitter.

### Password

The Password button when clicked allows the current user’s password to be changed. This button is only visible to Administrators.



The image shows a 'Password Change' dialog box. It has a blue title bar with the text 'Password Change'. Below the title bar, there are three text input fields. The first is labeled 'Confirm Your Password', the second is labeled 'New Password', and the third is labeled 'Confirm New Password'. At the bottom of the dialog, there are two buttons: 'Save' and 'Cancel'.

FIGURE 8-18. PASSWORD CHANGE

## CHAPTER 8: OSD FUNCTIONS

### Transmitter Button

The Transmitter button on the Control Tab allows administrators to change the configuration of an Emerald Transmitter (this button is only visible to administrators). The following options are available when the Transmitter button has been activated:

1. Transmitter Information
2. Transmitter Firmware Upgrade
3. Transmitter restore factory defaults
4. Transmitter reboot
5. Transmitter Preferences
6. Network Settings
7. Discover Transmitter IP address

### Configuring a Transmitter

To configure a Transmitter, the IP address must be defined for the target Transmitter. When there is no active IP address defined, the TX Setting window has all the buttons grayed out except for the Apply and Discover buttons.

The IP address for the transmitter can be entered into the field at the top of window and click Apply button to activate. If a valid IP address is entered, the Transmitter settings window makes all the options available for the administrator shown in Figure 8-20.

Alternatively the Discover button can be used to find the IP address of a transmitter. First click the Discover button and follow the instructions. Basically once in discovery mode, the Receiver (or Boxilla Manager) can capture the IP address from a Transmitter once it has been power-cycled.

NOTE: The default network setting for the Transmitter is a static IP address of 192.168.1.22. It has a Network Mask of 255.255.255.0 and a Gateway 192.168.1.1.

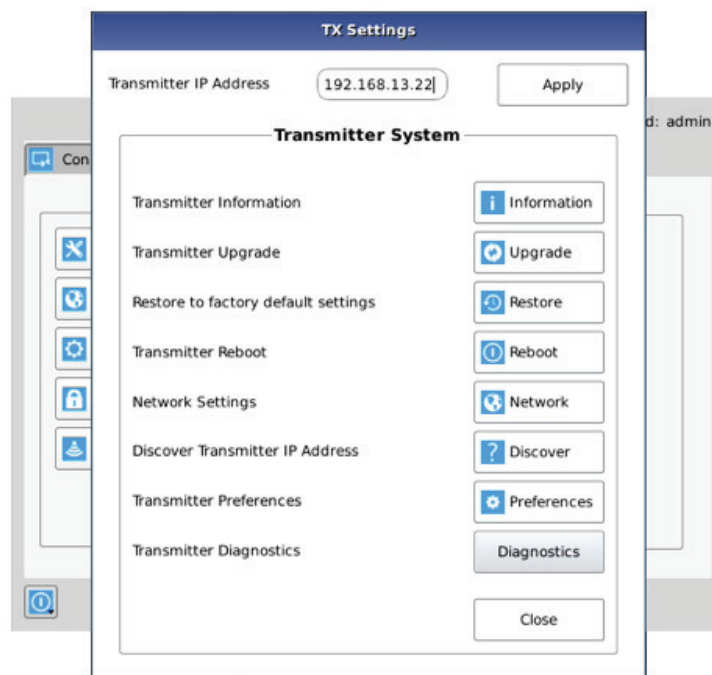

FIGURE 8-19. TRANSMITTER SETTINGS CONFIGURATION WINDOW - ACTIVE IP ADDRESS

## CHAPTER 8: OSD FUNCTIONS

If the IP address of the Receiver and Transmitter are not on the same subnet, a router is required to allow them to communicate. This is true even when the Receiver “discovers” the Transmitter’s IP address. One way to avoid this is to change the Receiver address to be on the same subnet as the Transmitter, make the required configuration changes to the Transmitter, and then change the Receiver back to its required IP address.

### Transmitter Information

The Information button provides Transmitter related information such as Device Model, Serial Number, MAC address, and current Firmware Version to the administrator.

If the active IP address is not the address of a valid Emerald Transmitter or this address is unreachable, an error message is returned.

### Transmitter Upgrade

The administrator can click the Upgrade button to change the firmware on a Transmitter. The upgrade file is selected from the set of files on an attached USB drive. These files will have the extension .clu . The selected file is checked to be a valid Transmitter upgrade file before starting the upgrade. The OSD provides a series of screens to walk the user through the process.

The upgrade can take a few minutes to complete and the power to the Transmitter and the Receiver must not be disconnected during the upgrade. During the upgrade process, the Transmitter may reboot.

If the active IP address is not the address of a valid Emerald Transmitter or this address is unreachable, an error message is returned.

### Transmitter Restore Factory Defaults

The administrator can click the Restore button to reset the Transmitter back to factory defaults. If the active IP address is not the address of a valid Emerald Transmitter or this address is unreachable, an error message is returned.

### Transmitter Reboot

The administrator can click the Reboot button to power-cycle the Transmitter. If the active IP address is not the address of a valid Emerald Transmitter or this address is unreachable, an error message is returned.

### Transmitter Preferences

The administrator can click the Transmitter Preferences to change Video Quality Setting or HID Configuration. When the Transmitter Preferences button is clicked the window shown in Figure 8-21 pops up.

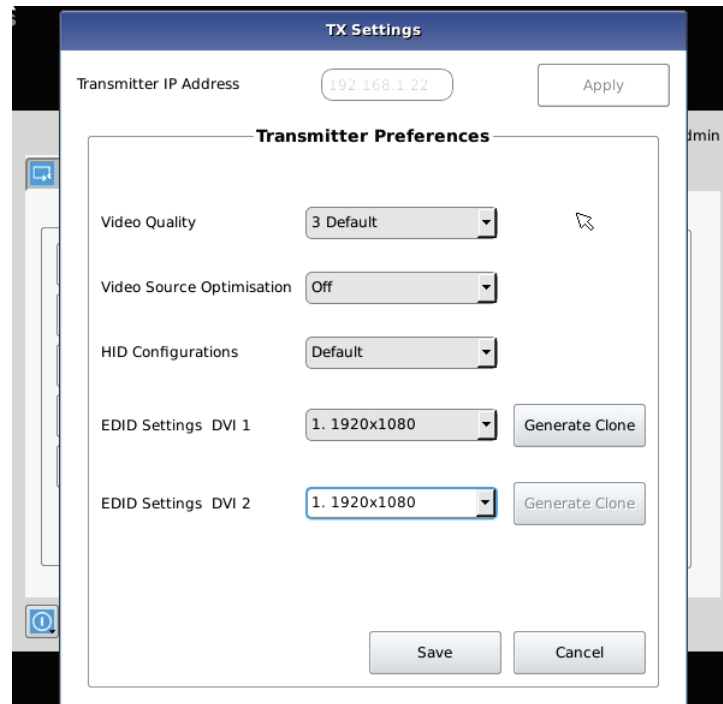

FIGURE 8-20.

## Transmitter Video Quality Settings

1. Best Quality – lossless compression, pixel-perfect mode of operation. Generally needs dedicated network to ensure no frame loss.
2. Visually Lossless Compression – high quality visual image. Some compression on stream to reduce bandwidth to allow operation on standard corporate networks. Compression does not vary based on available network bandwidth, so may lead to some dropped frames during network congestion periods.
3. Optimized Quality (default) – system tuned to maintain visually lossless compression while increasing compression level during periods of network congestion to reduce frame loss. Balances visual quality with frame loss in periods of congestion (i.e. attempts to reduce/eliminate frame loss).
4. Optimized Bandwidth – system tuned to maintain visually lossless compression but increased levels of compression level during periods of network congestion to reduce frame loss. Optimized towards lower bandwidth during congestion periods compared to level 3.
5. Lowest Bandwidth – high level of compression to minimize average network bandwidth. No dynamic change to compression levels – always seeking to reduce bandwidth.

If the active IP address is not the address of a valid Emerald Transmitter or this address is unreachable, an error message is returned.

## HID Configurations

The HID configuration can be set to be default which allows Audio over USB as well as keyboard and mouse connections or Basic HID which provide compatibility with DKM, DCX and older servers that require a keyboard and mouse HID only.

Basic HID is also required to access any computer's BIOS menus.

## Absolute mouse:

This feature can be used to enable interoperability with KM switches with built-in "Glide & Switch" capability such as ServSwitchTC

## CHAPTER 8: OSD FUNCTIONS

and Freedom. For normal usage, where mouse is directly connected to Receiver, then the Default or Basic options should be used.

OSD option:

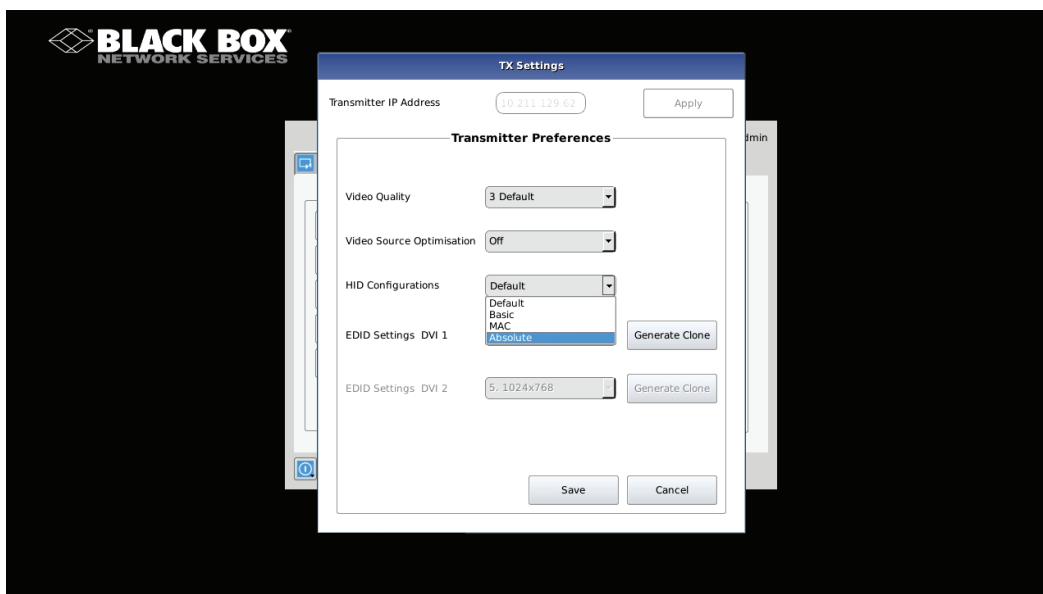

FIGURE 8-21. ABSOLUTE MOUSE OSD OPTION

### Video Source Optimization

The transmitter can be configured to handle different applications by changing the way it handles the video signal if it natively has embedded noise (i.e. from a VGA to DVI converter). You can choose to use “DVI optimized”, “VGA high performance”, “VGA optimized”, or “VGA low bandwidth” settings. You may change these options to get the best performance out of the transmitter.

### EDID Settings

The transmitter can support native EDID options such as “1920x1080”, “1920x1200”, “1680x1050”, “1280x1024”, “1024x768”, or you can choose to use the remote monitor EDID by clicking on the Generate Clone button which will copy the remote EDID to the transmitter. The computer may need to be restarted in order for the settings to work. If you find that changing the EDID settings makes the remote monitor blank out, you may need to select a different option to make it work.

### Transmitter Network Settings

The administrator can click the Network Settings button to edit the Transmitter Network Settings.

To change the IP address settings for a Transmitter, the administrator can enter the new IP address, subnet mask, and gateway, and then click on the Apply button.

## CHAPTER 8: OSD FUNCTIONS

The screenshot shows a web-based configuration window titled "TX Settings". At the top, there is a "Transmitter IP Address" field containing "10.10.10.22" and an "Apply" button. Below this is a section titled "TX Network Settings" which contains a message: "The Transmitter IP Address must be Static". Underneath this message are five input fields: "TX New IP Address" (empty), "TX New Network Mask" (255.255.255.0), "TX New Default Gateway" (empty), "TX Multicast Address" (empty), and "TX Multicast Port" (6003). At the bottom of the "TX Network Settings" section are "Back" and "Apply" buttons.

FIGURE 8-22. TRANSMITTER NETWORK SETTINGS WINDOW

If the new IP address for the Emerald Transmitter is on a different subnet than the Receiver, the Receiver or Manager will not be able to communicate with it without going through a router. This is the case even on a point-to-point link between devices.

If the entered IP address is not the address of a valid Emerald Transmitter or this address is unreachable, an error message is returned.

### Discover Transmitter IP Address

This requires the Transmitter to be connected to the Receiver on a point-to-point link or be the only Transmitter on the attached network. In this case, the administrator can click on the Discover button and follow the wizard to discover the IP address of the attached Transmitter. This is required in the case when an administrator does not know the IP address of the Transmitter.

### Transmitter Diagnostics

The Transmitter provides diagnostics information for Black Box to debug customer encountered issues. When this button is clicked the user is asked to save the diagnostics onto a memory stick in the Receiver unit. Send this file back to Black Box for analysis.

## 8.7 MANAGING USERS

Users are defined in the Emerald system to provide rights to manage the system, rights to connect to different target devices and set parameters for connections. There are three types of users that can be created in an Emerald system.

1. Administrator – users of the class have full rights to configure the system. They can create/modify/delete new users and connections, change network settings, etc.
2. Power User – users of this class can modify resolutions for connections to virtual desktops and change his/her local password.
3. Standard Users – users of this class can only select from a list of pre-defined connections to access and view system information. They cannot change any configuration settings.

## CHAPTER 8: OSD FUNCTIONS

The Emerald Receiver and Boxilla have one default user – admin, which is a member of the administrator group. This user is defined by default and cannot be deleted. An Emerald Receiver or Manager can have a maximum of 32 users defined, unless in a manager domain with an “upgrade” license installed. With the upgrade license installed, unlimited users can be defined.

To manage users, an administrator selects the Users tab (this Tab is only visible to Administrator class users).

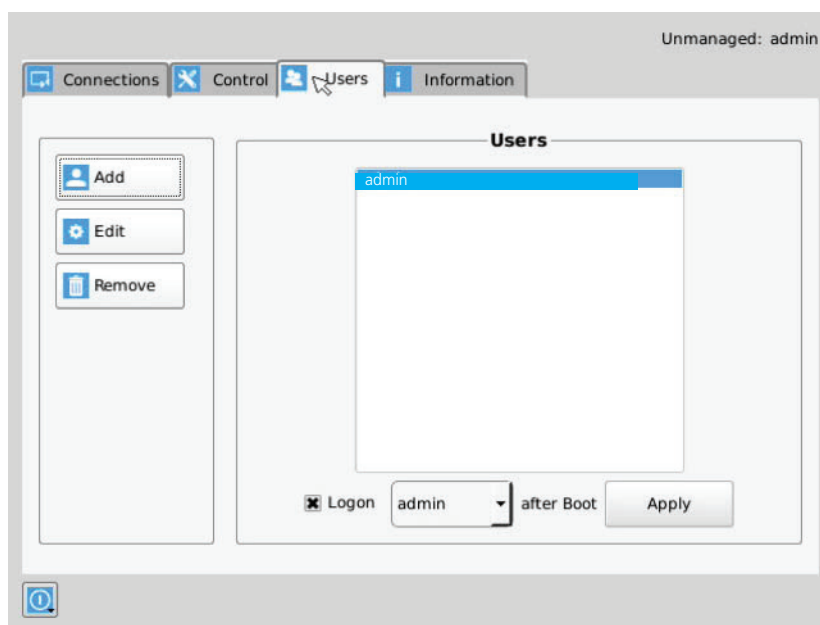

FIGURE 8-23. USER SCREENS

### 8.7.1 ADD A USER

---

To add a user, click the add button. This causes the New-User window to be displayed.

### 8.7.2 AUTO LOG ON

---

When the Log-on button is selected and a user is chosen, this user will be automatically logged on after power is applied to unit or after a reboot.

## CHAPTER 8: OSD FUNCTIONS

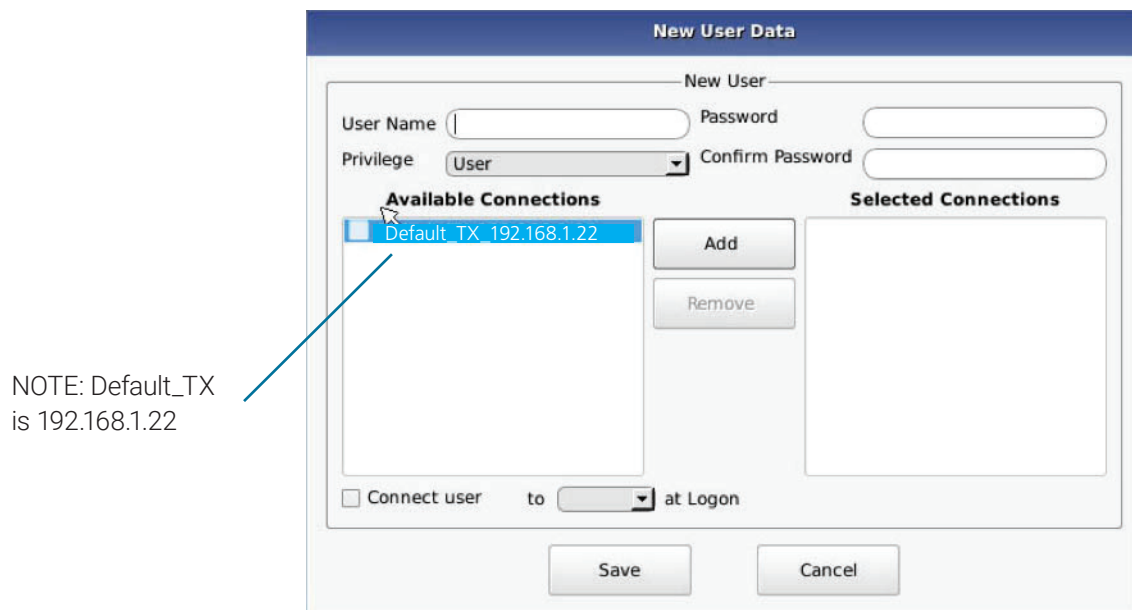

FIGURE 8-24. NEW USER WINDOW

When adding a new user, the following fields are used to define the user:

- ◆ **User Name:** This is a unique name that uses 1–32 characters. The username can be any valid username for a Microsoft O/S. This means the username cannot contain “/ \ [ ] ; | = , + \* ? < > `”.
- ◆ **Password:** This field can be a minimum of 0 characters (i.e. blank) and a maximum of 32 characters. The password can be any valid password for a Microsoft O/S. This means the password cannot contain “/ \ [ ] ; | = , + \* ? < > `”.
- ◆ **Confirm Password:** This field must match the Password field. If there is a mismatch, a message is presented to the user in a pop-up screen.
- ◆ **Privilege:** This field, which is a drop-down list, defines the type of user the new user will be—Administrator or User.
- ◆ **Selected Connections:** The new user must be allocated Connections that he/she can access. These are selected from the Available Connections window by the user selecting a set of connections (click on the connection in the Available Connection window and then click the “Add” button). This causes the selected connections to be “added” to a user’s selected connection window.
- ◆ **Connect to at login:** This tick box defines whether the Emerald Receiver or Manager attempts to connect immediately to the selected connection after a logon by the user. This automatic connection only occurs after a logon. If a user exits the connection, the connection tab is displayed to the user for selection of a connection. This Connect to at Login is only saved when the Save button is clicked. If not clicked and another tab is selected, the changes are ignored. If not ticked, no automatic connection is made on log-in.

Once the new user fields have been filled out, the Save button must be clicked to create the new user. Clicking the Save button causes the validation of the new username checking that it is unique and that the two password entries match. If this validation fails, a pop-up window displays the reason for the failure – and the new user is not created. After dismissing the pop-up window, the user can fix the error and click Save again.

The Cancel button should be clicked if the new user is not to be created.

## CHAPTER 8: OSD FUNCTIONS

### 8.7.3 EDIT A USER

To edit a user, click on the Edit button. This causes the Edit-User window (shown in Figure 8-26) to be displayed.



The screenshot shows the 'Edit User Data' window for the 'admin' user. The window has a title bar 'Edit User Data' and a subtitle 'admin Data'. It contains the following elements:

- User Name:** A text field containing 'admin'.
- Privilege:** A dropdown menu set to 'Administrator'.
- Password Reset:** A button.
- Available Connections:** A list box containing 'Default\_TX\_192.168.1.22'.
- Selected Connections:** A list box containing 'Default\_TX\_192.168.1.22'.
- Buttons:** 'Add' and 'Remove' buttons between the connection lists.
- Connect user:** A checkbox labeled 'Connect user' followed by a dropdown menu showing 'admin to Default\_TX\_192.168.1.2 at Logon'.
- Bottom Buttons:** 'Save' and 'Cancel' buttons.

FIGURE 8-25. EDIT USER WINDOW

This window allows the user privilege type, the permitted connections available, the password, and the auto-connect option to be changed.

The default "admin" account gets access to all connections; this list cannot be modified. Other administrator-type users can have their connection list modified.

Once the changes have been made for a user, they only become active once the Save button has been clicked. The changes can be abandoned by clicking the Cancel button.

## CHAPTER 8: OSD FUNCTIONS

### 8.7.4 REMOVE A USER

To remove a user, highlight the user's name and press "Remove."

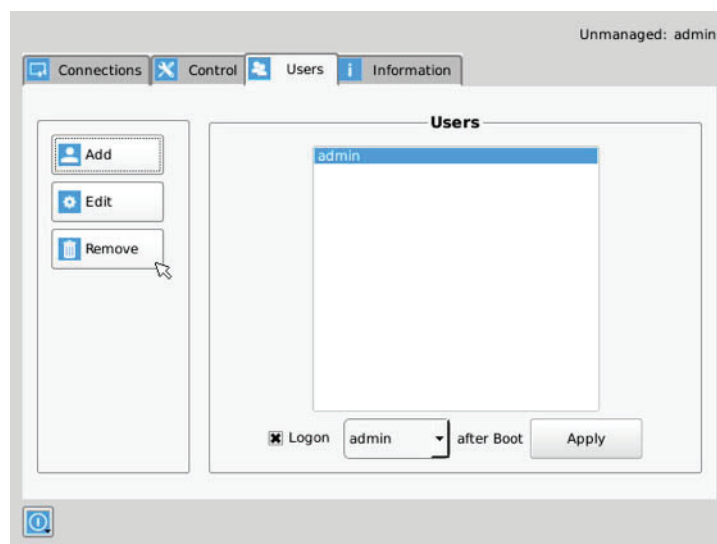

FIGURE 8-26. REMOVE USER

When the Remove button is clicked, a pop-up window is displayed to prompt confirmation that this user is to be deleted. Click the Yes button to remove the user. Clicking the No button causes this action to be aborted and the user is not removed.

NOTE: There must always be a user of the name admin in the Emerald system so the system can always be administrated. When attempting to remove the user, the system checks if the username is admin before it will allow the user to be removed.

## 8.8 LACP

To find out more information about the status of the Emerald network interface(s), the Boxilla administrator can navigate to Devices>>Settings, and click on the "LACP info" panel. This will give a summary of the status of each Emerald NIC interface. Some of the information that can be found on this page is:

Active: Is the Ethernet port currently active

- ♦ Status: If the link is up or down
- ♦ Link Speed: The negotiated speed of the NIC
- ♦ Media: The type of network cable being used
- ♦ LACP: If the data is using LACP traffic

Link Aggregation Control Protocol (LACP) for Ethernet (802.1ax or 802.3ad) provides a way to bundle several physical links into one logical link. This protocol enables a network device to automatically bundle links by sending LACP packets to a directly-connected device that also uses LACP.

## APPENDIX A: EMERALD VIDEO RESOLUTIONS SUPPORTED

The Emerald supports the resolutions listed below:

- ◆ 640 x 480 @ 60 Hz
- ◆ 640 x 480 @ 75 Hz
- ◆ 800 x 600 @ 60 Hz
- ◆ 800 x 600 @ 70 Hz
- ◆ 800 x 600 @ 72 Hz
- ◆ 800 x 600 @ 75 Hz
- ◆ 800 x 600 @ 85 Hz
- ◆ 1024 x 768 @ 60 Hz
- ◆ 1024 x 768 @ 75 Hz
- ◆ 1024 x 768 @ 85 Hz
- ◆ 1280 x 800 @ 60 Hz
- ◆ 1280 x 960 @ 60 Hz
- ◆ 1280 x 960 @ 85 Hz
- ◆ 1280 x 1024 @ 60 Hz
- ◆ 1280 x 1024 @ 75 Hz
- ◆ 1280 x 1024 @ 85 Hz
- ◆ 1366 x 768 @ 60 Hz
- ◆ 1400 x 1050 @ 60 Hz
- ◆ 1440 x 900 @ 60 Hz
- ◆ 1600 x 900 @ 60 Hz
- ◆ 1680 x 1050 @ 60 Hz
- ◆ 1600 x 1200 @ 60 Hz
- ◆ 1680 x 1050 @ 60 Hz
- ◆ 1280 x 720 @ 60 Hz
- ◆ 1920 x 1080 @ 60Hz
- ◆ 1920 x 1200 @ 60 Hz

Emerald also will pass all the above resolutions at refresh frequencies from 15 Hz to 60 Hz. Those with non-defined VESA resolutions will be displayed at 60 Hz even if the incoming resolution is not 60 Hz.



## APPENDIX B. CONFIGURING WINDOWS 7 VIRTUAL MACHINES

A few properties must be configured on a target Windows Virtual Machine for Emerald to connect with it.

On the Windows Virtual Machine click on the Start button and launch a command window. Then launch group policy editor – gpedit.msc.

Start >> Run >> "cmd" >> "gpedit.msc"

Once the Local group Policy editor is open follow this path:

Computer Configuration >> Administrative Templates >> Windows Components >> Remote Desktop Services >> Remote Desktop Session Host >> Remote Session Environment

Ensure the following three policies are set as follows:

1. Optimize visual experience when using RemoteFX.

- ♦ For this policy set both the "Screen Capture Rate" and "Screen Image Quality" to Highest.

2. Configure RemoteFX.

- ♦ Set this policy to enabled

3. Limit maximum color depth.

- ♦ Set this policy to "Client Compatible."

Once the above policies have been applied, reboot the Virtual Machine. It is now enabled for Emerald connections.

There are different settings to optimize the performance of Emerald with different Windows operating systems. These are defined in the application note – Emerald Group Policies for Optimal Performance for Windows Targets.

It is not possible to connect to a transmitter from a computer/laptop running RDP. A receiver is always required.

## APPENDIX C. EMERALD NETWORK PROTOCOLS OVERVIEW

Emerald uses standard IP protocols for communication between Receivers and Transmitters. Port 3389 is used for unicast communications.

For management purposes some other ports are used. The Black Box Discovery protocol used UDP Multicast Group 224.0.1.249 (port 39150). This is sent by the Manager to discover Emerald devices in the network. The router must allow UDP Multicast forwarding to allow devices on subnet different to where Manager is located to be discovered.

Emerald devices respond to the discovery multicast by sending a UDP unicast back to Manager IP address on the same port (Port 39150).

Once an Emerald device is part of the managed domain, the Manager periodically “audits” the device to determine information such as if the device on-line, who is logged into devices, device statistics, etc. These audit requests and responses are unicast UDP to specific IP addresses (responses are sent back to Manager’s IP address) on port 39150.

On power-up, a Transmitter sends out a “here I am” multicast message on multicast group 225.0.0.37 on port 12345.

As part of management configuration, the Manager may communicate to a specific device on port 22 (TCP unicast communications).

Emerald can operate across multiple VLANs or subnets. Basic IP networking rules need to be followed; there should be a router in the network to enable the various devices on different subnets to communicate with each other.

To allow Black Box’s Emerald discovery protocol to operate, Multicast routing should be enabled. Black Box’s Emerald “discovery” protocol is not required for Emerald systems to operate but it is recommended to enable an Emerald Manager to search for devices across the network. If the Emerald SE discovery protocol is not enabled, i.e. router does not have multicast routing enabled, the administrator will have to manually add in all devices not on its subnet, i.e. add in each device individually by its IP address.



## APPENDIX D. TROUBLESHOOTING

This page covers some basic notes & troubleshooting when using the Emerald.

Operating Modes: Connecting to an Emerald transmitter from an RDP client that is from a laptop / computer is not possible; you must use an Emerald receiver for this. An Emerald receiver can connect to an Emerald transmitter and RDP server.

**TABLE D-1. OPERATING MODES CONFIGURATIONS**

USER SIDE	COMPUTER SIDE	OPERATION
Laptop/Computer w/RDP Client	Emerald SE or PE Transmitter or Emerald ZeroU Transmitter	This is not supported and will not work
Emerald SE Receiver	Emerald SE or PE Transmitter or Emerald ZeroU Transmitter	Fully supported
Emerald SE Receiver	RDP Server on VM or OS	Fully supported

Sluggish Mouse: When using the Emerald, you may find that the mouse is not being very responsive, or has a noticeable delay. This can typically occur if the video card is using Dithering technology. You can contact Black Box to get a small utility to disable video card dithering on AMD graphics cards.

Error Codes: The following error codes expanded.

- 1 GENERAL\_ERROR Connection protocol failure. Are units at the correct and compatible software version?
- 2 INIT\_FAIL Can't start protocol. Is the receiver at the correct software version?
- 3 GET\_SOCKET Protocol Start Failure Are units at the correct and compatible software version?
- 4 CREATE\_SESSION\_FAIL Can't create session. Is transmitter connected and powered on?
- 5 CONNECT\_FAIL Can't create session. "Is transmitter connected and powered on? Is port 22 open between units."
- 6 TX\_CHECK\_FAIL Target device is not a transmitter. Is transmitter IP address correct?
- 7 VER\_CHECK\_FAIL Can't read device Version. Is transmitter connected and powered on?
- 8 LED\_FLASH\_FAIL Start LED Flash command failed on remote device Is transmitter connected and powered on?
- 9 FILE\_SEND\_FAIL Can't send upgrade file to transmitter. Is transmitter connected and powered on?
- 10 PERMISSION\_CHANGE\_FAIL Update to change settings on Transmitter Is transmitter connected and powered on?
- 11 EXTRACT\_UPGRADE\_FAIL Failed to extract upgrade file. Is upgrade file correct or damaged?
- 12 RUN\_UPGRADE\_FAIL Upgrade failed Is upgrade file correct or damaged?
- 13 REBOOT\_FAIL Failed to reboot remote device unit. Is remote device connected and powered on?
- 14 FILE\_SEARCH\_FAIL Upgrade file format failed Is upgrade file correct or damaged?
- 15 LISTEN\_ERROR Connection protocol failure. "Are units at the correct and compatible software version? Is transmitter connected and powered on?"
- 16 SOCKET\_OPTION\_ERROR Connection protocol failure. "Are units at the correct and compatible software version? Is transmitter connected and powered on?"
- 17 SOCKET\_BIND\_ERROR Connection protocol failure. "Are units at the correct and compatible software version? Is transmitter connected and powered on?"
- 18 RECVFROM\_ERROR Connection protocol failure. "Are units at the correct and compatible software version? Is transmitter connected and powered on?"
- 19 GET\_INFO\_FAIL Failed to retrieve Info tab from remote device "Are units at the correct and compatible software version? Is transmitter connected and powered on?"
- 20 COMPATIBILITY\_FAIL Upgrade file is incompatible with version on unit Please check release notes for correct version and compatibility information.

## APPENDIX D. TROUBLESHOOTING

- 21 **BRAND\_CHECK\_FAIL** This is not a correct upgrade file for Emerald. Please check release notes for correct version and compatibility information.
- 22 **CLASS\_CHECK\_FAIL** Can't upgrade Transmitter with Receiver file or visa versa. Please check release notes for correct version and compatibility information.
- 23 **PACKAGE\_CHECK\_FAIL** Incorrect upgrade file for this model. Please check release notes for correct version and compatibility information.
- 24 **NO\_UPGRADE\_REQUIRED** No upgrade required. This version of code is already on the device. No upgrade required.



## APPENDIX E. REGULATORY INFORMATION

### E.1 FCC STATEMENT

This equipment has been tested and found to comply with the limits for a Class A digital device, pursuant to part 15 of the FCC Rules. These limits are designed to provide reasonable protection against harmful interference when the equipment is operated in a commercial environment. This equipment generates, uses, and can radiate radio frequency energy and, if not installed and used in accordance with the instruction manual, may cause harmful interference to radio communications. Operation of this equipment in a residential area is likely to cause harmful interference in which case the user will be required to correct the interference at his own expense.

This Class A digital apparatus complies with Canadian ICES-003.

Cet appareil numérique de la Classe A est conforme à la norme NMB-003 du Canada

## APPENDIX E. REGULATORY INFORMATION

### E.2 NOM STATEMENT

1. Todas las instrucciones de seguridad y operación deberán ser leídas antes de que el aparato eléctrico sea operado.
2. Las instrucciones de seguridad y operación deberán ser guardadas para referencia futura.
3. Todas las advertencias en el aparato eléctrico y en sus instrucciones de operación deben ser respetadas.
4. Todas las instrucciones de operación y uso deben ser seguidas.
5. El aparato eléctrico no deberá ser usado cerca del agua—por ejemplo, cerca de la tina de baño, lavabo, sótano mojado o cerca de una alberca, etc.
6. El aparato eléctrico debe ser usado únicamente con carritos o pedestales que sean recomendados por el fabricante.
7. El aparato eléctrico debe ser montado a la pared o al techo sólo como sea recomendado por el fabricante.
8. Servicio—El usuario no debe intentar dar servicio al equipo eléctrico más allá a lo descrito en las instrucciones de operación. Todo otro servicio deberá ser referido a personal de servicio calificado.
9. El aparato eléctrico debe ser situado de tal manera que su posición no interfiera su uso. La colocación del aparato eléctrico sobre una cama, sofá, alfombra o superficie similar puede bloquea la ventilación, no se debe colocar en librerías o gabinetes que impidan el flujo de aire por los orificios de ventilación.
10. El equipo eléctrico debe ser situado fuera del alcance de fuentes de calor como radiadores, registros de calor, estufas u otros aparatos (incluyendo amplificadores) que producen calor.
11. El aparato eléctrico deberá ser conectado a una fuente de poder sólo del tipo descrito en el instructivo de operación, o como se indique en el aparato.
12. Precaución debe ser tomada de tal manera que la tierra física y la polarización del equipo no sea eliminada.
13. Los cables de la fuente de poder deben ser guiados de tal manera que no sean pisados ni pellizcados por objetos colocados sobre o contra ellos, poniendo particular atención a los contactos y receptáculos donde salen del aparato.
14. El equipo eléctrico debe ser limpiado únicamente de acuerdo a las recomendaciones del fabricante.
15. En caso de existir, una antena externa deberá ser localizada lejos de las líneas de energía.
16. El cable de corriente deberá ser desconectado del cuando el equipo no sea usado por un largo periodo de tiempo.
17. Cuidado debe ser tomado de tal manera que objetos líquidos no sean derramados sobre la cubierta u orificios de ventilación.
18. Servicio por personal calificado deberá ser provisto cuando:
  - A: El cable de poder o el contacto ha sido dañado; u
  - B: Objetos han caído o líquido ha sido derramado dentro del aparato; o
  - C: El aparato ha sido expuesto a la lluvia; o
  - D: El aparato parece no operar normalmente o muestra un cambio en su desempeño; o
  - E: El aparato ha sido tirado o su cubierta ha sido dañada.



## APPENDIX F. DISCLAIMER/TRADEMARKS

### F.1 DISCLAIMER

Black Box Network Services shall not be liable for damages of any kind, including, but not limited to, punitive, consequential or cost of cover damages, resulting from any errors in the product information or specifications set forth in this document and Black Box Network Services may revise this document at any time without notice.

### F.2 TRADEMARKS USED IN THIS MANUAL

Black Box and the Double Diamond logo are registered trademarks of BB Technologies, Inc.

Any other trademarks mentioned in this manual are acknowledged to be the property of the trademark owners.







**NEED HELP?  
LEAVE THE TECH TO US**

---

**LIVE 24/7  
TECHNICAL  
SUPPORT**

---

**1.877.877.2269**

