

AVer AmpliWave Lite Audio System

(SA-A5)

— **User Manual** —

The power cord shall be connected to a socket-outlet with earthing connection.

This product is intended to be supplied by a UL Listed Certificate power adapter and power cord, output comply with LPS or PS2, rated 19Vdc, 3.42A min., and Tma 35 degree C min. Please contact manufacturer, UL File owner or AVer for further information and assistance.

Federal Communication Commission Interference Statement

This device complies with Part 15 of the FCC Rules. Operation is subject to the following two conditions: (1) This device may not cause harmful interference, and (2) this device must accept any interference received, including interference that may cause undesired operation.

This equipment has been tested and found to comply with the limits for a Class B digital device, pursuant to Part 15 of the FCC Rules. These limits are designed to provide reasonable protection against harmful interference in a residential installation. This equipment generates, uses and can radiate radio frequency energy and, if not installed and used in accordance with the instructions, may cause harmful interference to radio communications. However, there is no guarantee that interference will not occur in a particular installation. If this equipment does cause harmful interference to radio or television reception, which can be determined by turning the equipment off and on, the user is encouraged to try to correct the interference by one of the following measures:

- Reorient or relocate the receiving antenna.
- Increase the separation between the equipment and receiver.
- Connect the equipment into an outlet on a circuit different from that to which the receiver is connected.
- Consult the dealer or an experienced radio/TV technician for help.

FCC Caution: Any changes or modifications not expressly approved by the party responsible for compliance could void the user's authority to operate this equipment.

This Class B digital apparatus complies with Canadian ICES-003.

Cet appareil numérique de la classe B est conforme à la norme NMB-003 du Canada.

For Wireless Device:

For SAT5 Pendant Microphones:

This equipment complies with FCC radiation exposure limits set forth for an uncontrolled environment. End users must follow the specific operating instructions for satisfying the RF exposure compliance.

For SAR5 Microphone Receiver:

This equipment complies with FCC radiation exposure limits set forth for an uncontrolled environment. This equipment should be installed and operated with minimum distance 20cm between the radiator & your body.

IC Notice

This device contains licence-exempt transmitter(s)/receiver(s) that comply with Innovation, Science and Economic Development Canada's licence-exempt RSS(s). Operation is subject to the following two conditions:

1. This device may not cause interference.
2. This device must accept any interference, including interference that may cause undesired operation of the device.

L'émetteur/récepteur exempt de licence contenu dans le présent appareil est conforme aux CNR d'Innovation, Sciences et Développement économique Canada applicables aux appareils radio exempts de licence. L'exploitation est autorisée aux deux conditions suivantes :

1. L'appareil ne doit pas produire de brouillage;
2. L'appareil doit accepter tout brouillage radioélectrique subi, même si le brouillage est susceptible d'en compromettre le fonctionnement.

For SAT5 Pendant Microphones:

This equipment complies with IC RSS-102 radiation exposure limits set forth for an uncontrolled environment.

Cet équipement est conforme aux limites d'exposition aux rayonnements IC établies pour un environnement non contrôlé.

For SAR5 Microphone Receiver:

This equipment complies with IC RSS-102 radiation exposure limits set forth for an uncontrolled environment. This equipment should be installed and operated with minimum distance 20cm between the radiator & your body.

Cet équipement est conforme aux limites d'exposition aux rayonnements IC établies pour un environnement non contrôlé. Cet équipement doit être installé et utilisé avec un minimum de 20cm de distance entre la source de rayonnement et votre corps.

Europe – EU Declaration of Conformity

This device complies with the essential requirements of the Radio Equipment Directive (2014/53/EU). The following test methods have been applied in order to prove presumption of conformity with the essential requirements of the Radio Equipment Directive (2014/53/EU).

DISCLAIMER

No warranty or representation, either expressed or implied, is made with respect to the contents of this documentation, its quality, performance, merchantability, or fitness for a particular purpose. Information presented in this documentation has been carefully checked for reliability; however, no responsibility is assumed for inaccuracies. The information contained in this documentation is subject to change without notice.

In no event will AVer Information Inc. be liable for direct, indirect, special, incidental, or consequential damages arising out of the use or inability to use this product or documentation, even if advised of the possibility of such damages.

TRADEMARKS

“AVer” is a trademark owned by AVer Information Inc. Other trademarks used herein for description purpose only belong to each of their companies.

COPYRIGHT

©2024 AVer Information Inc. All rights reserved. | July 30, 2024

All rights of this object belong to AVer Information Inc. Reproduced or transmitted in any form or by any means without the prior written permission of AVer Information Inc. is prohibited. All information or specifications are subject to change without prior notice.

More Help

For FAQs, technical support, software and user manual download, please visit:

Non-USA

Download Center: <https://www.aver.com/download-center>

Technical Support: <https://www.aver.com/technical-support>

USA

Download Center: <https://www.averusa.com/education/support>

Technical Support: <https://averusa.force.com/support/s/contactsupport>

Contact Information

Headquarters

AVer Information Inc.

8F, No.157, Da-An Rd., Tucheng Dist.,

New Taipei City 23673, Taiwan

Tel: +886 (2) 2269 8535

USA Branch Office

AVer Information Inc., Americas

44061 Nobel Drive, Fremont, CA 94538, USA

Tel: +1 (408) 263 3828

Toll-free: +1 (877) 528 7824

Europe Branch Office

AVer Information Europe B.V.

Westblaak 134, 3012 KM, Rotterdam, The

Netherlands

Tel: +31 (0) 10 7600 550

Japan Branch Office

アバー・インフォメーション株式会社

〒160-0023 日本東京都新宿区西新宿 3-2-26 立

花新宿ビル 7 階

Tel: +81 (0) 3 5989 0290

お客様サポートセンター(固定電話のみ): +81 (0) 120
008 382

Vietnam Branch Office

Công ty TNHH AVer Information (Việt Nam)

Tầng 5, 596 Nguyễn Đình Chiểu,

P.3, Quận 3,

Thành phố Hồ Chí Minh 700000, Việt Nam

Tel: +84 (0) 28 22 539 211

Hỗ trợ kỹ thuật: +84 (0) 90 70 080 77

Korea Office

한국 에버 인포메이션 (주)

서울시 종로구 새문안로 92

(신문로 1가, 광화문오피시아빌딩) 1831,
1832 호

Tel: +82 (0) 2 722 8535

Contents

Overview	1
Package Contents.....	1
SAB5V2 Streaming Audio Box	1
Pendant Microphones	1
Dimensions	2
Controls and Connections.....	3
SAB5V2 Streaming Audio Box	3
Pendant Microphones	5
Power Connection.....	6
Getting Started	6
Set up Your SAB5V2 Streaming Audio Box	6
Insert the Microphone Receiver (Dongle).....	6
Set up Your Microphone.....	7
Pair Your Pendant Microphone.....	7
Use Your Microphone	8
For Emergencies.....	9
Charge Your Microphone	9
Replace Your Microphone Battery.....	10
Set up Your Speakers	10
Connect Your Speaker Cables	10
Audio Features.....	11
Page Mute.....	11
Audio Output to Assistive Listening Devices (ALD)	12
In the Classroom	13
Hybrid Learning.....	14
Web Application Settings	16
Access to the web application.....	16
Login.....	17

Device Status.....	18
Audio.....	19
Network.....	21
System.....	23
Specification	24
SAB5V2 Streaming Audio Box.....	24
Pendant Microphones	26
Wireless Receiver Dongle.....	27
Environmental Specifications	27
Troubleshooting	28

Overview

Package Contents

SAB5V2 Streaming Audio Box



SAB5V2 Streaming Audio Box

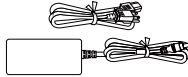

Power Adapter
& Power Cord(s)

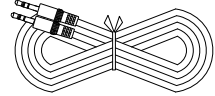

3.5 Stereo to 3.5
Stereo Cable (10m)

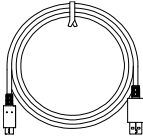

USB 3.0 Type-C to Type-A
Cable (1.83m)



SAB5V2 QR Code Card

Pendant Microphones

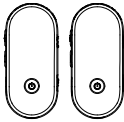

SAT5 Pendant Microphones



Lanyard (x2)

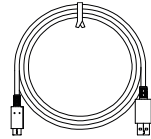

USB 3.0 Type-C to Type-A
Cable (1.5m)

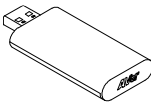

SAR5 Microphone Receiver
(Dongle)

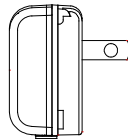

Wall Mount Type Adapter

Dimensions

SAB5V2 Streaming Audio Box

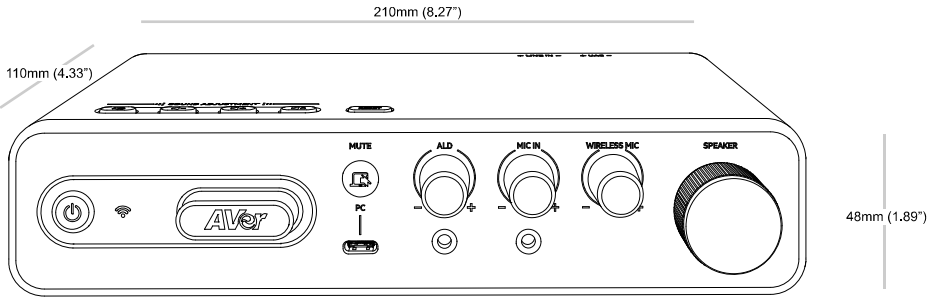

Pendant Microphones

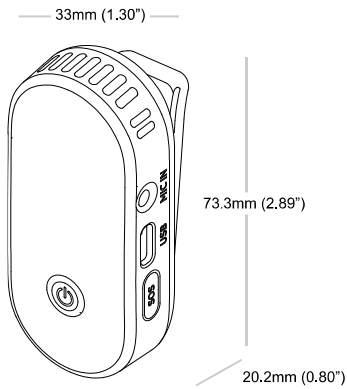

Controls and Connections

SAB5V2 Streaming Audio Box

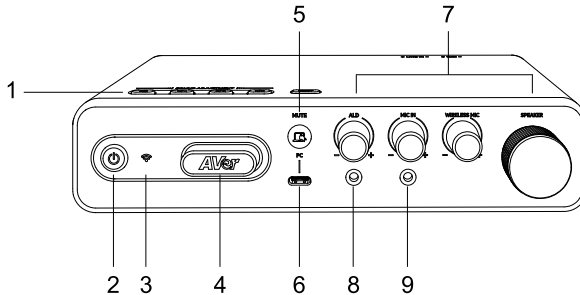

Top Cover

1. Sound Adjustment Buttons

Front Panel

2. Power Button

Short press: Power on.

Long press for 5 seconds: Enter Standby Mode.

- Solid green: Power on
- ★ Flashing green: Start-up
- Solid red: Wake-on-LAN mode (when connected to power)
- ★ Flashing red: Updating firmware
- Solid orange: Input lock mode

3. Status LED

- Solid blue: Microphone(s) is paired
- Off: Microphone(s) isn't paired

4. Microphone Receiver (Dongle) Slot and Plug

5. PC Mute Button

- Solid red: PC is muted
- Off: PC isn't muted

6. PC (USB Type-C) Port

7. Volume Controls:

Assistive Listening Device (ALD) / Mic In / Wireless Mic / Speakers

8. Assistive Listening Device (ALD) Port

9. Mic In Port

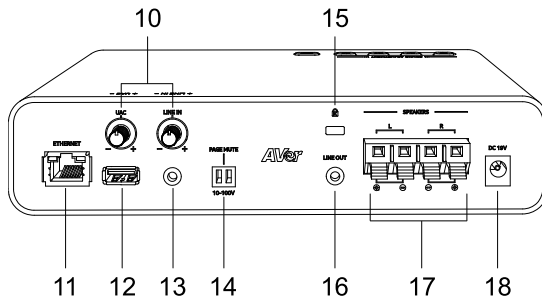

Back Panel

10. Volume Controls:
USB Audio Class (UAC) / Line In
11. Ethernet Port
12. USB Type-A Port
13. Line In Port
14. Page Mute Port
15. Kensington Lock
16. Line Out Port
17. Speaker Push-in Terminal Connector Block
18. DC Power Jack

Pendant Microphones

1. Power/Mute Switch

Press and hold for 3 seconds to turn the microphone on or off.

2. Mic In Port

3. USB Type-C Port

4. Emergency Button (on Teacher Microphone)

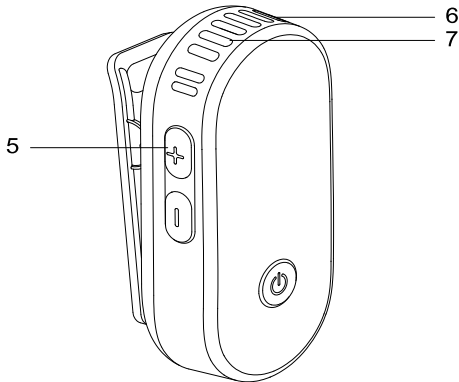
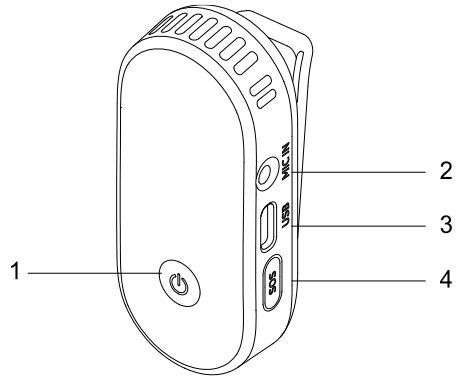

5. Volume Up/Down

6. Battery LED

- Solid green: Normal
- ★ Flashing red: Low battery

7. Status LED

- Solid blue: Paired
- ★ Flashing blue: Not transmitting to a receiver or out of range
- Solid red: Mute
- ★ Flashing red: Low battery

8. Battery Door

9. Lanyard Hook

10. Microphone Clip

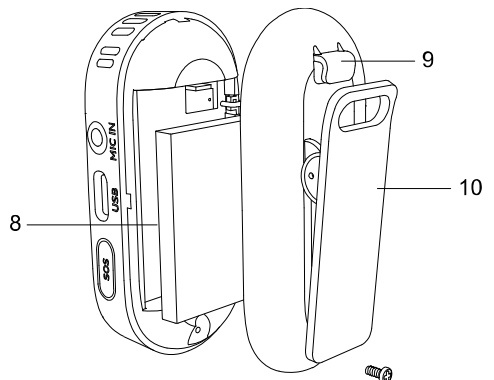

Power Connection

Connect the included power adapter and power cord to a power outlet with earthing connection.

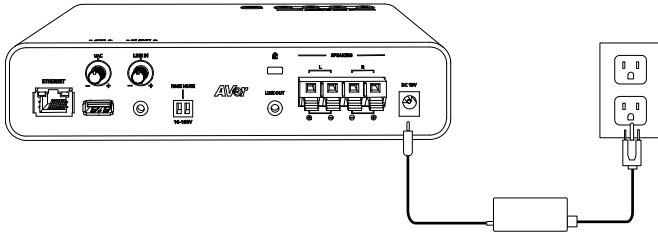

Getting Started

Set up Your SAB5V2 Streaming Audio Box

Insert the Microphone Receiver (Dongle)

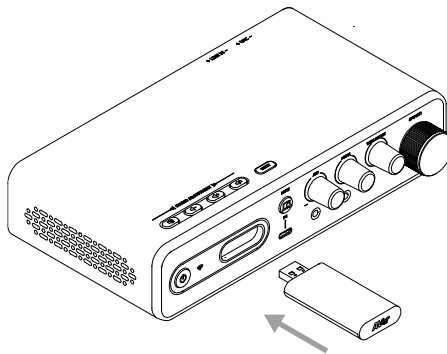

1. Remove the plug and insert the microphone receiver (dongle) included in the AVer AmpliWave Lite Audio System.
2. Short press the Power button to turn on the SAB5V2 Streaming Audio Box.

Notes:

Hot-plugging may damage your device. Please plug in the receiver before powering on and unplug it after powering off.

Set up Your Microphone

Pair Your Pendant Microphone



- Solid blue: Paired
- ★ Flashing blue: Not transmitting to a receiver or out of range

1. Make sure you have inserted the microphone receiver (dongle) and turned on the SAB5V2 Streaming Audio Box.
2. Press and hold the Power/Mute button on the microphone for 3 seconds until you see a solid green light, then release the button to continue the pairing process.
3. Pairing is successful when the status LEDs on both the microphone(s) and the SAB5V2 Streaming Audio Box turn solid blue.

Use Your Microphone

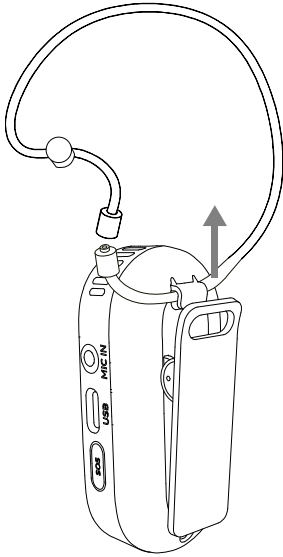

Please follow the instructions below for optimal audio quality.

1. Tuck the lanyard through the hook and pull hard to secure the lanyard. Then wear it around your neck.
2. Adjust the lanyard to position the microphone approximately 15cm (5.9") from mouth.
3. Press and hold the Power/Mute button for 3 seconds to power on > press again to mute > press and hold for 3 seconds to power off.
4. Adjust the volume with the Volume Up/Down buttons on the side of the microphone.
5. The microphone will automatically turn off:
 - When it is out of range and after 3 minutes of trying to connect.
 - After being muted for 30 minutes.

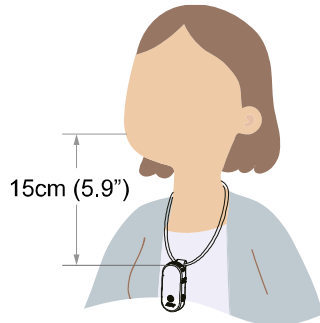
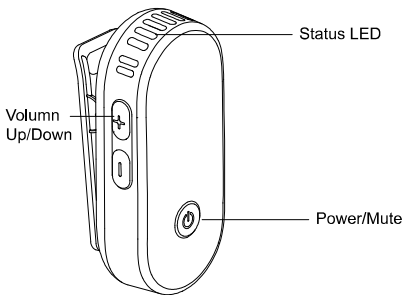

- Solid blue: Paired
- ★ Flashing blue: Not transmitting to a receiver or out of range
- Solid red: Mute
- ★ Flashing red: Low battery

For Emergencies

The emergency feature is only available in the US.

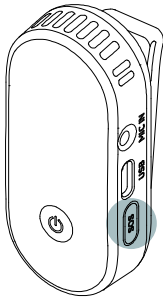

1. Connect the SAB5V2 Streaming Audio Box to your local network with an Ethernet cable and the Device Management software.
2. Press and hold the SOS button on the Teacher Microphone for 3 seconds to broadcast your location.
3. Both status LED and battery LED will flash red.
4. Your microphone will work normally after pressing the button.

★ Status LED and battery LED flash red.

Charge Your Microphone

- It will take less than 3 hours to fully charge your microphones.
- Your microphone can get up to 8-10 hours of talk time on a single charge.
- 10 minutes of charge will provide 1 hour of talk time.

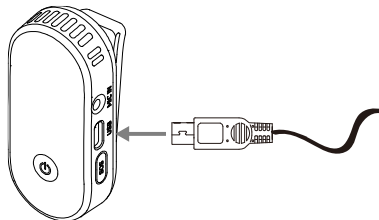

To charge, plug your microphone into a power source using the included USB Type-C cable.

The LED status indicates the following:

- Solid green: Fully charged
- Solid red: Charging

Replace Your Microphone Battery

Notes:

The battery should be replaced by its manufacturer, service technician or a similarly qualified person.

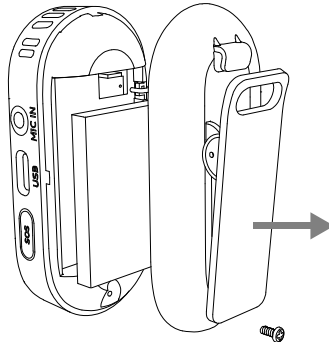

1. Turn off the microphone. Loosen the screw and open the battery door
2. Remove the battery by gently pulling up from the notch on the bottom.
3. Insert the replacement battery, close the battery door, and tighten the screw.

Set up Your Speakers

Connect Your Speaker Cables

1. Read the installation guide of your speakers to make sure it matches the SAB5V2 Streaming Audio Box specifications. Please refer to the [<Specification>](#) for more details.
2. Connect your speakers using standard speaker cables to the push-in terminal connector blocks on the back panel of the Streaming Audio Box.

Notes:

1. For optimal performance, connect the AmpliWave Lite Audio System to two 15W 6-ohm speakers.
2. Maintain the speaker wiring impedance to 6-ohm when connecting to existing speakers or retrofitting a classroom with four ceiling speakers.

Audio Features

Page Mute

When the page mute input terminal sense a strong enough signal, it will automatically mute all other audio inputs sources. This is to allow that everyone can hear the broadcasts from the Public Address System.

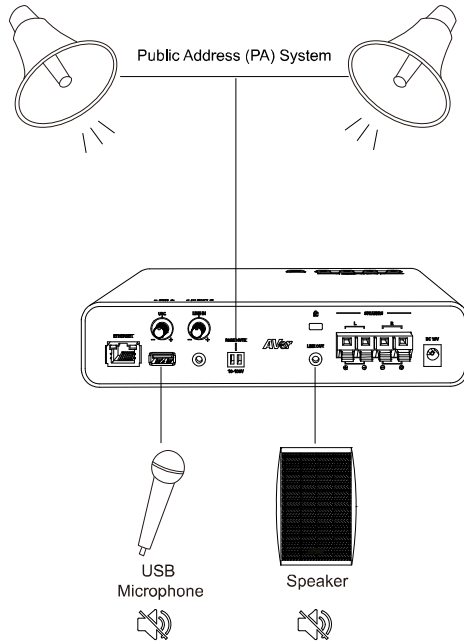

Audio Output to Assistive Listening Devices (ALD)

Assistive listening devices (ALD) can help students hear a teacher speaking across the room or hear a conversation in a noisy room.

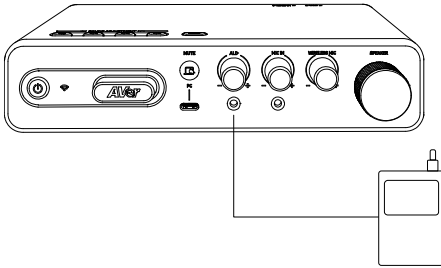

1. Turn the ALD volume control all the way down on the SAB5V2 Streaming Audio Box.
2. Plug your transmitter into the ALD port on the front panel of the SAB5V2 Streaming Audio Box using the included 3.5mm to 3.5mm stereo cable.
3. Speak into the microphone and slowly adjust the volume control for a suitable audio level.

In the Classroom

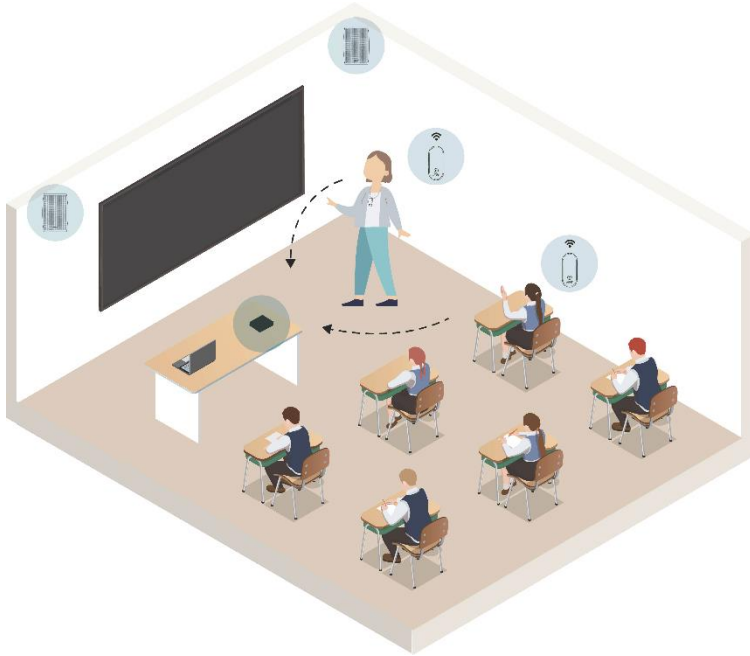

1. Short press to turn on the SAB5V2 Streaming Audio Box. Press and hold the Power/Switch button for 3 seconds to [pair your pendant microphone](#).
2. Or use a wired microphone by:
 - Plugging it into the Mic In port on the pendant microphone that has been paired with the SAB5V2 Streaming Audio Box.
 - Plugging it into the Mic In port on the front panel of the SAB5V2 Streaming Audio Box.

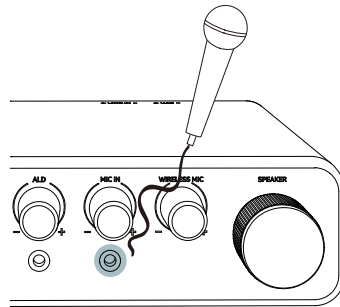
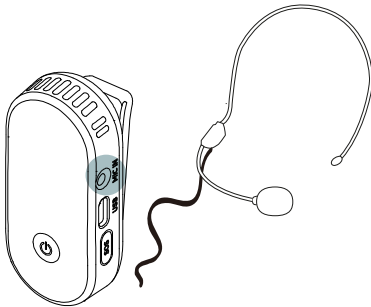

Hybrid Learning

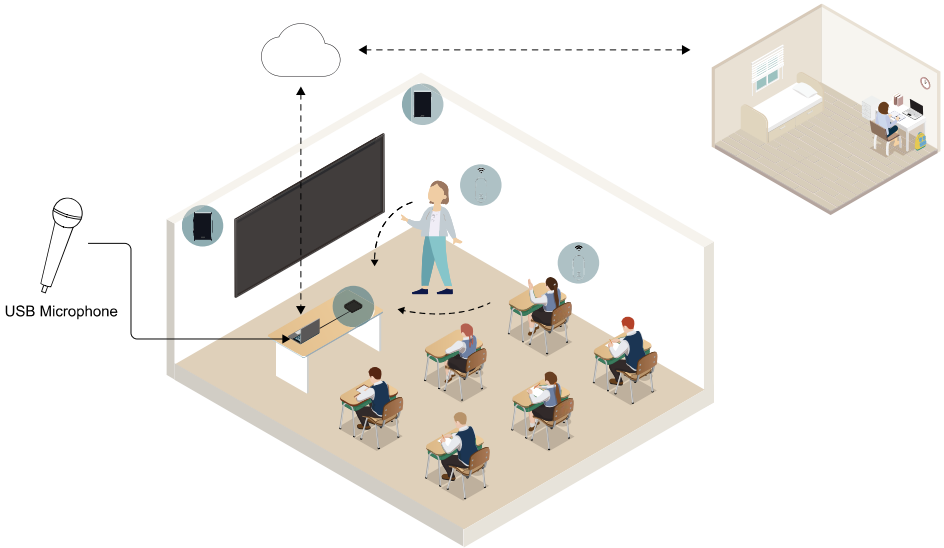

1. Short press to turn on the SAB5V2 Streaming Audio Box. Press and hold the Power/Switch button for 3 seconds to [pair your pendant microphone](#).
2. Connect devices. A slight popping sound during connection is considered a normal phenomenon.

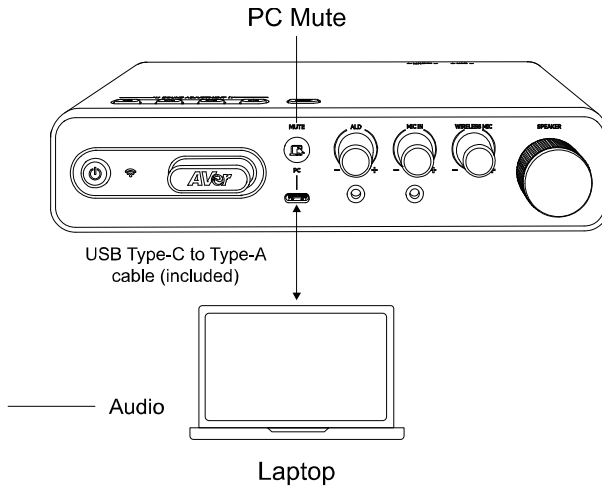

- **USB microphone**

When using your pendant or wired microphone, make sure your USB camera's built-in microphone (if any) is turned off to reduce feedback.

3. Open your video conferencing software, such as Google Meet, Skype, Microsoft Teams or Zoom, and select “SAB5 Series” as the microphone and speaker source.
4. Sound Adjustment Button behaviors:

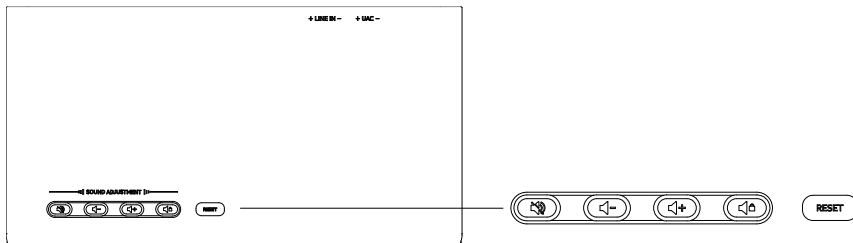

Icon	Action	Function
	Press and release	Mute the whole Audio System.
	Short press	Lower volume in steps.
	Long press	Lower volume continuously.
	Short press	Raise the volume in steps.
	Long press	Raise the volume continuously.
	Press and release	Lock / unlock the current volume settings, except the wireless microphone (RX) input.
RESET	Press and hold (10 seconds)	Reset to factory default settings.

5. How to use the PC Mute button:
 - Press to mute PC speakers and sounds from online students to reduce distraction in class. They will still be able to hear you.

Web Application Settings

Access to the web application

1. Connect your SAB5V2 Streaming Audio box to the power adapter and the Ethernet cable.
2. To find your SAB5V2 Streaming Audio Box IP address, download the **AVer IPCam Utility** from <https://www.aver.com/Downloads/search?q=AVer%20IPCam%20Utility%20for%20Camera%20IP%20Searching> and launch the application.
3. Click **Search** to view all available devices on the screen.
4. Select your **SAB5V2** Streaming Audio Box from the device list to view more information in the Settings field. ,...
5. Double click on the **IPv4 Address** field to open the web application in your internet browser.

The screenshot displays the AVer IPCam Utility interface. At the top, there is a 'Network Device' section with a dropdown menu showing 'Intel(R) Ethernet Connection (12) I219-V' and a 'Search' button. To the right is a 'Login' section with 'User ID' and 'Password' input fields. Below these is a navigation bar with tabs for 'Network Setting', 'Date/Time Setting', 'Maintenance', and 'Import/Export Config'. The main area shows a 'Search Result' table with columns for No., Status, Progress, Model Name, Device Name, FW version, IPv4 Address, MAC Address, and IPv6 Address. The third row is highlighted in orange, showing a device named 'SAB5V2' with IP address '10.100.90.21'. Below the table is a 'Settings' section for the selected device, 'SAB5V2_SOS'. It includes options for 'DHCP' (selected) and 'Static IP'. Network configuration fields include 'Start IP Address' (10.100.90.21), 'End IP Address' (.), 'Subnet Mask' (255.255.255.0), 'Gateway' (10.100.90.254), 'Primary DNS' (10.100.1.6), and 'Secondary DNS' (0.0.0.0). An 'Apply' button is located at the bottom right.

No.	Status	Progress	Model Name	Device Name	FW version	IPv4 Address	MAC Address	IPv6 Address
<input type="checkbox"/> 1	Working		PTC310UV2	AVer	0.1.0000.51 ...	10.100.90.20:80	02:00:70:98:76:05	[]:80
<input type="checkbox"/> 2	Working		FONE700	FONE700	0.0.8300.81	10.100.90.172:80	00:18:1a:60:33:cc	[]:80
<input checked="" type="checkbox"/> 3	Working		SAB5V2	SAB5V2	9.0.0000.00	10.100.90.21:80	00:18:1a:60:4e:aa	[]:80
<input type="checkbox"/> 4	Working		ProAV CAM-P1	ProAV CAM-P1	0.0.9900.09	10.100.90.63:80	00:18:1a:0c:b2:08	[]:80
<input type="checkbox"/> 5	Working		CAM550	CAM550	0.0.8004.71	10.100.90.67:80	00:18:1a:60:41:03	[]:80

Login

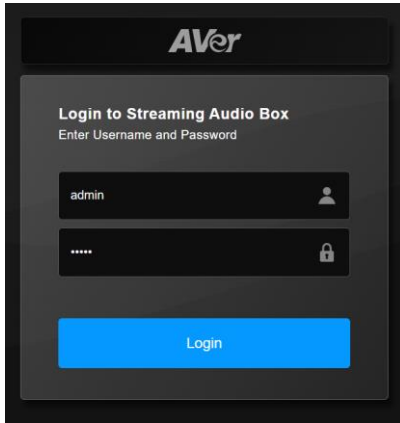

AVer

Login to Streaming Audio Box
Enter Username and Password

admin

.....

Login

1. Enter the default **Username** and **Password**: **admin** / **admin** to log in.

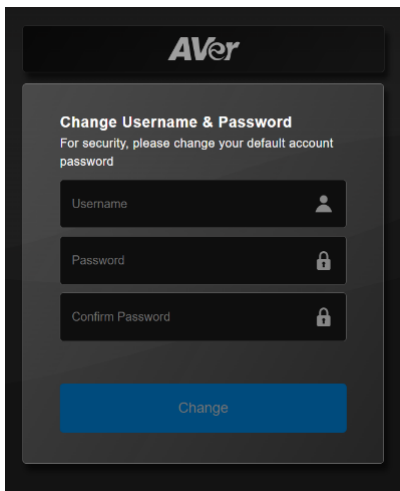

AVer

Change Username & Password
For security, please change your default account password

Username

Password

Confirm Password

Change

2. For first time login, the system will ask you to change your **Username** and **Password**.
3. Read anonymous usage data policy. Select the checkbox to agree, and then click **Done**.
4. Log in with your new **Username** and **Password**. You will see the web application main page.

Device Status

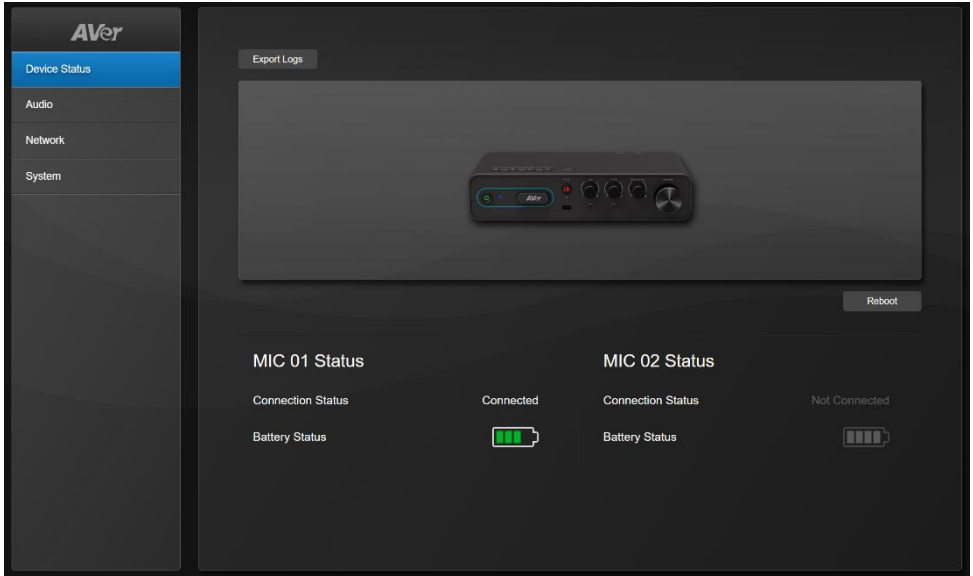

Item	Description
------	-------------

Export Logs	Click to download the logs for current settings to your local files.
-------------	--

Reboot	<ol style="list-style-type: none"> 1. Click to restart your Streaming Audio Box, and click OK on the pop-up window to continue. It may take a few minutes to reboot. 2. Refresh your web browser and log in again when the reboot is finished.
--------	---

View microphone connection status and battery status.

- **Connection Status**
Connected / Not Connected
- **Battery Status**

Icon	Status
	Full battery
	Remaining battery
	Low battery
	Out of battery

Audio

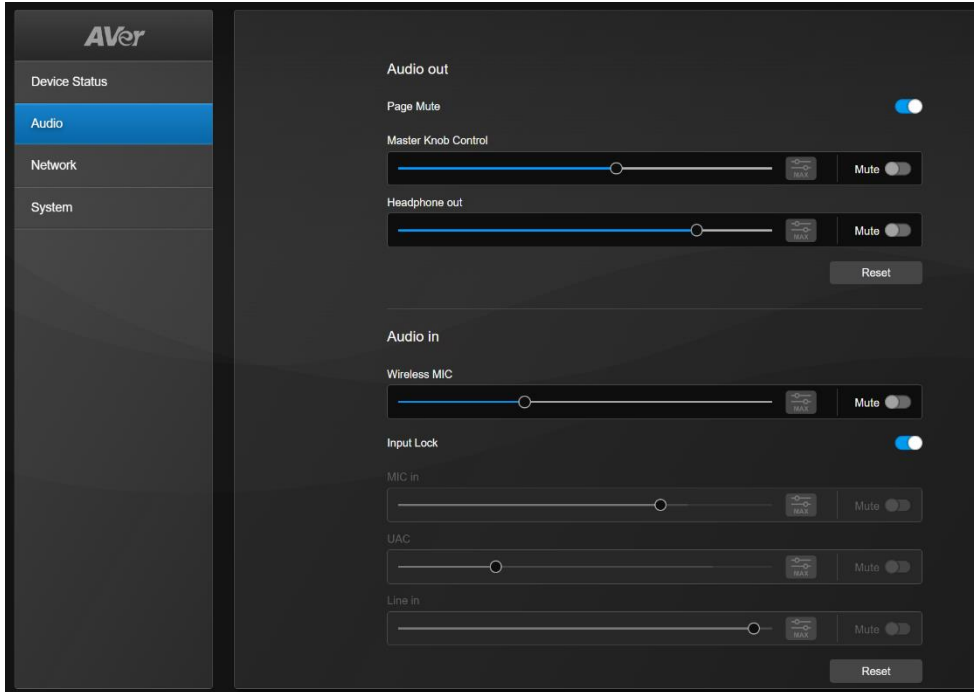

Audio Out

Item	Description
Page Mute	Click the toggle switch to turn on or off the public amplifier mute function. For more information about this function, please refer to <Page Mute> .
Master Knob Control	<ul style="list-style-type: none">● Drag the slider to adjust the volume.● Click Max Volume Setting  to set up the maximum volume. When finished, click OK. You can only adjust the volume in a certain range.● Click the Mute toggle switch to mute or unmute each setting.
Headphone out	
Reset	Click to reset all the settings to factory default values.

Audio In

Item	Description
Input Lock	Click the toggle switch to lock or unlock input settings. When the switch is on, you cannot change MIC in, UAC and Line in values.
Wireless MIC	<ul style="list-style-type: none">● Drag the slider to adjust the volume.
MIC in	<ul style="list-style-type: none">● Click Max Volume Setting  to set up the maximum volume. When finished, click OK. You can only adjust the volume in a certain range.
UAC	
Line in	<ul style="list-style-type: none">● Click the Mute toggle switch to mute or unmute each setting.
Reset	Click to reset all the settings to factory default values.

Network

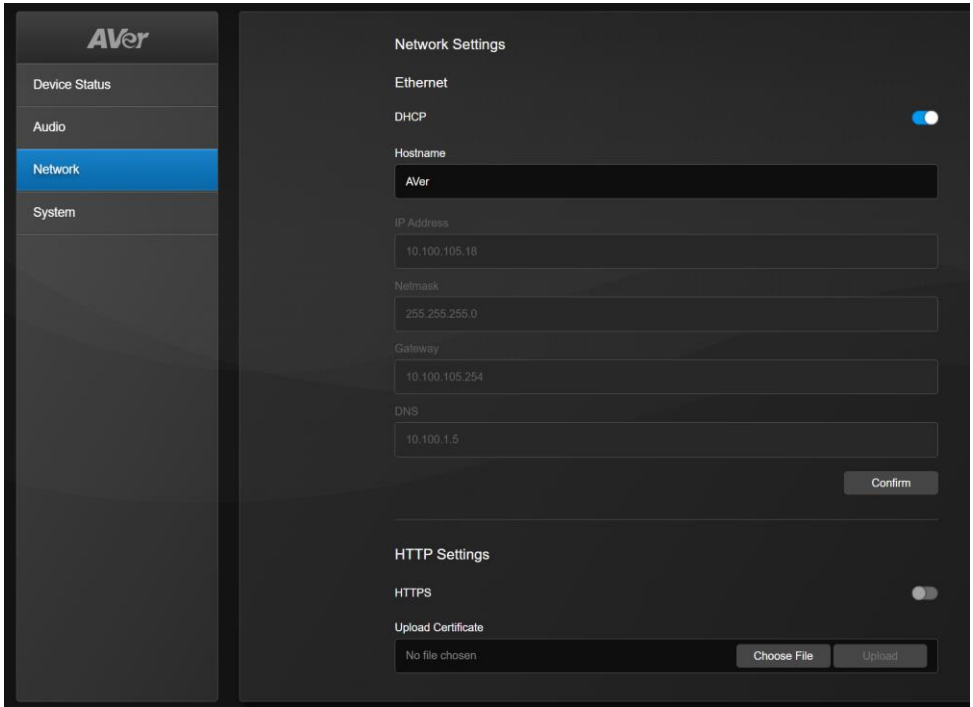

Network Setting

Item	Description
DHCP	Click the toggle switch to switch between DHCP and Static IP. <ul style="list-style-type: none">● DHCP: The system will assign a related IP address to the device.● Static IP: You may manually enter IP Address, Netmask, Gateway and DNS.
Hostname	Click to edit the Hostname . When finished, click Confirm .
IP Address	
Netmask	1. Turn off the DHCP toggle switch to switch to Static IP.
Gateway	2. You may manually enter IP Address , Netmask , Gateway and DNS in the text boxes.
DNS	3. When finished, click Confirm .

HTTPS Settings

Click the **HTTPS** toggle switch to turn on or off the function. When **HTTPS** function is on, it will establish a secure connection between your browser and your Streaming Audio Box.

1. Create a SSL certificate file for encryption and decryption.
2. In **Upload Certificate** setup field, click **Choose File** to select the certificate file on your computer.
3. When finished, click **Upload**.



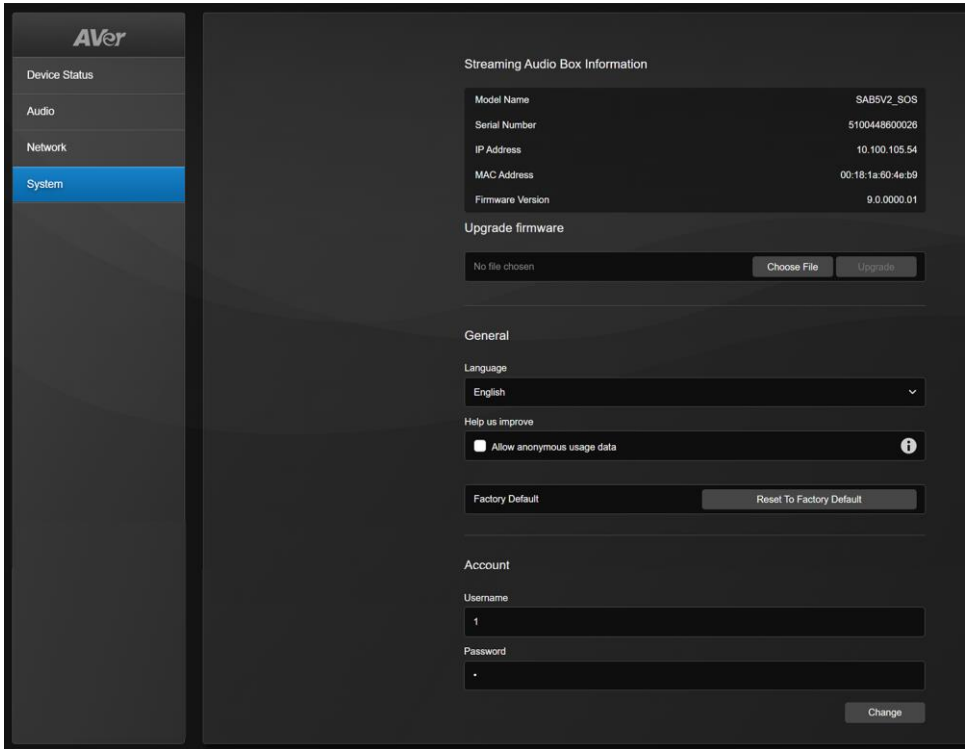

System



Item	Description
Streaming Audio Box Information	View your device information, including Model Name , Serial Number , IP Address , MAC Address , and Firmware Version .
Upgrade Firmware	<ol style="list-style-type: none">1. Download firmware update file from Aver Download Center to your computer.2. Click Choose File to select the firmware update file.3. Click Upgrade to upgrade your device firmware.
Language	Select from the drop-down list to change the system language.
Help us improve	Select or unselect the checkbox to allow or don't allow to send anonymous usage data to AVer.
Factory Default	Click Reset To Factory Default to set all settings to factory default values.
Username	Change the login username in the text box. When finished, click Change .
Password	Change the login password in the text box. When finished, click Change .

Specification

SAB5V2 Streaming Audio Box

DC Power	19V
Standby Mode	<1.5W (WoL)
Power Consumption	65W max.
Dimensions (W x D x H)	210 x 110 x 48.5mm (excluding rubber)
Net Weight	530g ±50g
Power Button	<ul style="list-style-type: none">● Solid green: Power on★ Flashing green: Start-up● Solid red: Wake-on-LAN mode (when connected to power)★ Flashing red: Updating firmware or resetting to factory default.● Solid orange: Input lock mode
Status LED	<ul style="list-style-type: none">● Solid blue: Microphone(s) is paired○ Off: Microphone(s) isn't paired
PC Mute Button	<ul style="list-style-type: none">● Solid red: PC is muted○ Off: PC isn't muted
Top Cover Sound Adjustment Buttons	<ul style="list-style-type: none"> Mute the whole Audio System. Volume down. Volume up. Lock the current volume settings, except the wireless microphone (RX) input.RESET Reset to factory default settings.
PC Port	USB Type-C
ALD Port	3.5mm stereo for assistive listening devices
Mic In Port	3.5mm mono

UAC Port	USB Type-A 2.0
Line In Port	3.5mm stereo
Line Out Port	3.5mm stereo
Speaker Out	6-ohm speaker push-in terminal connector block
Ethernet Port	1
DC Power Jack	19V
Kensington Lock	1
Page Mute Port	1

Pendant Microphones

	Teacher	Student
Style	Pendant with clip and lanyard	
Channels	1	
Transmission Type	Wireless	
Wireless Frequency	2.4 GHz	
Frequency Response	50 Hz - 20 kHz	
Coverage	20m (65 ft.)	
Microphone Capsule	Omni-directional electret condenser	
Battery	Rechargeable and removable Li-ion battery	
Battery Power	3.7V	
Talk Time	8-10 hours	
Charging Time	<3 hours	
Charging Method	USB Type-C	
Dimensions (W x D x H)	Microphone: 33 x 20.2 x 73.3mm (excluding clip) Receiver: 55 x 30 x 10mm	
Net Weight	35g	
Power/Mute Switch	Press and hold the Power/Mute button for 3 seconds to power on > press again to mute > press and hold for 3 seconds to power off.	
Volume	Up/Down buttons	
Safety Alert	SOS button	N/A
Status LED	<ul style="list-style-type: none"> ● Solid blue: Paired ★ Flashing blue: Not transmitting to a receiver or out of range ● Solid red: Mute ★ Flashing red: Initiating an SOS Rescue (Teacher) 	

Battery LED	<p>When in use:</p> <ul style="list-style-type: none"> ● Solid green: Normal ★ Flashing red: Low battery <p>When charging:</p> <ul style="list-style-type: none"> ● Solid green: Fully charged ● Solid red: Charging
Mic In Port	3.5mm stereo
USB Type-C Port	1
Power Rating	5 VDC, 0.4A

Wireless Receiver Dongle

Transmission Type	Wireless
Wireless Frequency	2.4 GHz
Power Rating	5 VDC, 0.5A

Environmental Specifications

Working temp.	0°C - 40°C
Working RH	10% - 90%
Storage temp.	-30°C - 60°C
Storage RH	10% - 90%

Specifications are subject to change without prior notice.

Troubleshooting

Microphone doesn't pair.

- Make sure the SAB5V2 Streaming Audio Box is turned on. A solid green or orange light on the Power button will indicate that it is powered on.
- Make sure the SAB5V2 Streaming Audio Box is not placed in an enclosed space where the Wi-Fi signal may be obstructed.
- Press and hold the Power/Mute button on the microphone for 3 seconds to power off, and try pairing again.



No or low volume from the microphone.

- Make sure the microphone is not muted. A solid red light on top of the microphone indicates that it's muted.
- Adjust the volume with the Volume Up/Down buttons on the side of the microphone.
- Position the microphone approximately 15cm (5.9") from mouth for optimal audio quality.

I hear feedback (squealing).

- The volume may be too high. Adjust the Volume Up/Down buttons on the side of the microphone.
- The microphone may be too close to the speaker. Move the microphone away from the speaker.

No sound for the speaker

- Make sure the SAB5V2 Streaming Audio Box is turned on. A solid green or orange light on the Power button will indicate that it is powered on.
- Check if the SAB5V2 Streaming Audio Box is not muted. If yes, press the Mute Speaker button  on the top of the Audio Box to unmute.
- Make sure the SAB5V2 Streaming Audio Box volume input is unlocked. If you see a solid orange light on the Power button, press the lock/unlock button  to unlock input settings. The Power button will display a solid green light, and try increase speaker volume to resolve the issue.