

Veriton 5800/6800/7800 Series

User's Guide

Copyright © 2005. Acer Incorporated.
All Rights Reserved.

Veriton 5800/6800/7800 Series User's Guide
Original Issue: March 2005

Changes may be made periodically to the information in this publication without obligation to notify any person of such revisions or changes. Such changes will be incorporated in new editions of this manual or supplementary documents and publications. This company makes no representations or warranties, either expressed or implied, with respect to the contents hereof and specifically disclaims the implied warranties of merchantability or fitness for a particular purpose.

Record the model number, serial number, purchase date, and place of purchase information in the space provided below. The serial number and model number are recorded on the label affixed to your computer. All correspondence concerning your unit should include the serial number, model number, and purchase information.

No part of this publication may be reproduced, stored in a retrieval system, or transmitted, in any form or by any means, electronically, mechanically, by photocopy, recording, or otherwise, without the prior written permission of Acer Incorporated.

Veriton 5800/6800/7800 Series Desktop Computer

Model number: _____

Serial number: _____

Purchase date: _____

Place of purchase: _____

Acer and the Acer logo are registered trademarks of Acer Incorporated. Other companies' product names or trademarks are used herein for identification purposes only and belong to their respective companies.

Disposal instructions

Do not throw this electronic device into the trash when discarding. To minimize pollution and ensure utmost protection of the global environment, please recycle it.

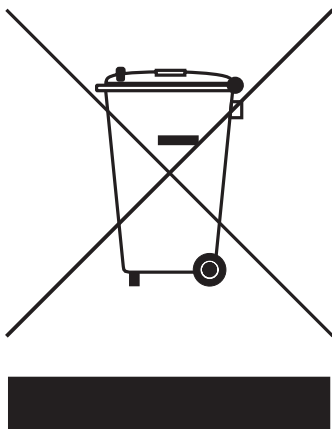

USA

For electronic products containing an LCD/CRT monitor or display:

Lamp(s) inside this product contain mercury and must be recycled or disposed of according to local, state or federal laws. For more information, contact the Electronic Industries Alliance at www.eiae.org. For lamp-specific disposal information, check www.lamprecycle.org.



1 Empowering Technology	1
Acer Empowering Technology	3
Acer eDataSecurity Management	4
Acer eLock Management	5
Acer ePerformance Management	6
Acer eRecovery Management	7
Acer eSettings Management	8
Acer eAcoustics Management	9
2 First things first	11
Specifications	13
Package contents	15
Accessing the User's Guide	15
3 System tour	17
Features	19
Performance	19
Multimedia	19
Connectivity	19
Front panel	20
Rear panel	22
Keyboard	25
Internet/Email/Search keys	26
Multimedia keys	26
Volume control/mute keys	27
Lock keys	27
Cursor keys	28
Windows keys	28
Function keys	29
Palm rest	29
Optical drive	30
Taking care of your CDs and DVDs	32
Hard disk	32
4 Setting up your computer	33
Arranging a comfortable work area	35
Adjusting your chair	35
Positioning your PC	35

Contents

Positioning your monitor	36
Positioning your keyboard	36
Positioning your mouse	36
Connecting peripherals	37
Connecting your mouse and keyboard	37
USB interface	37
PS/2 interface	37
Connecting a monitor	38
Connecting the power cable	39
Turning on your computer	40
Turning off your computer	40
Connecting options	41
Connecting your printer	41
Connecting the modem (optional)	42
Connecting to the network	42
Connecting multimedia devices	43
Connecting USB devices	45
5 Upgrading your computer	47
Installation precautions	49
ESD precautions	49
Preinstallation instructions	49
Post-installation instructions	50
Opening your Veriton 5800	51
To remove the computer cover	51
To replace the computer cover	51
Opening your Veriton 6800/7800	52
To remove the side panel	52
To replace the side panel	53
System boards	54
Mainboard layout	54
Upgrading your computer	56
Installing additional memory	56
To remove a DDR2 DIMM	56
To install a DDR2 DIMM	57
To reconfigure your computer	58
Replacing the Veriton 5800's hard disk	58
Installing an expansion card	59
Replacing the Veriton 6800/7800's hard disk	60

Installing an expansion card	61
6 System utilities	63
Adobe Reader	65
Norton AntiVirus	66
How do I check for viruses?	66
NTI CD&DVD-Maker (for models with CD or DVD Burner)	67
PowerDVD (for models with DVD) How do I open and watch a DVD?	68
BIOS utility	69
Reinstalling programs	69
Using backup (Windows XP only) How do I back up files from my hard drive?	70
Disk defragmenter (Windows XP only) How do I defragment my hard drive?	71
7 Frequently asked questions	73
Frequently asked questions	75
Appendix A: Notices	77
ENERGY STAR guidelines compliance	78
FCC notice	78
Notice: Canadian users	79
Declaration of Conformity for EU countries	79
Modem notices	79
Notice for USA	79
TBR 21	80
Notice for Australia	80
Important safety instructions	80
Macrovision copyright protection notice	82
Lithium battery statement	82
Laser compliance statement	83
Federal Communications Commission Declaration of Conformity	84
Declaration of Conformity for CE marking	85

Appendix B: Taking care of your computer	87
Important tips	88
Cleaning and servicing	88
To clean your computer and keyboard	88
To clean your pointing device	89
To clean your monitor	89
When to contact a service technician	89
Asking for technical assistance	89
Index	91

1 Empowering Technology

Acer's innovative Empowering Technology makes it easy for you to access frequently used functions and manage your new Acer desktop.

Acer Empowering Technology

It features six handy utilities:

- **Acer eDataSecurity Management** protects data with passwords and advanced encryption algorithms.
- **Acer eLock Management** limits access to external storage media.
- **Acer ePerformance Management** improves system performance by optimizing disk space, memory and registry settings.
- **Acer eRecovery Management** backs up/recovers data flexibly, reliably and completely.
- **Acer eSettings Management** accesses system information and adjusts settings easily.
- **Acer eAcoustics Management** regulates fan and processor speeds for a quieter working environment.



For more information, press the < *e* > key to launch the Empowering Technology menu, then click on the appropriate utility and select the Help function.

Acer eDataSecurity Management

Acer eDataSecurity Management is a handy file encryption utility that protects your files from being accessed by unauthorized persons. It is conveniently integrated with Windows Explorer as a shell extension for quick and easy data encryption/decryption and also supports on-the-fly file encryption for MSN Messenger and Microsoft Outlook.

There are two passwords that can be used to encrypt/decrypt a file: the supervisor password and the file-specific password. The supervisor password is a "master" password that can decrypt any file on your system; the file-specific password is assigned when you encrypt each individual file.

The Acer eDataSecurity Management setup wizard will prompt you for a supervisor password and default file-specific password. This file-specific password will be used to encrypt files by default, or you can choose to enter your own file-specific password when encrypting a file.



Note: The password used encrypt a file is the unique key that the system needs to decrypt it. If you lose the password, the supervisor password is the only other key capable of decrypting the file. If you lose both passwords, there will be no way to decrypt your encrypted file! **Be sure to safeguard all related passwords!**

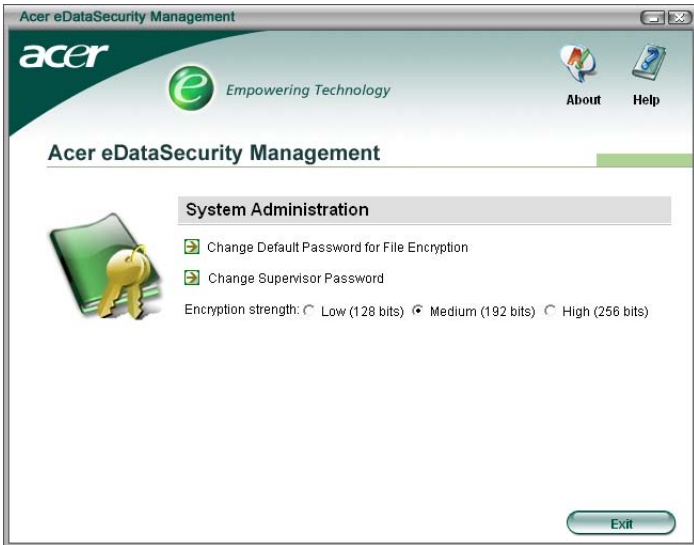

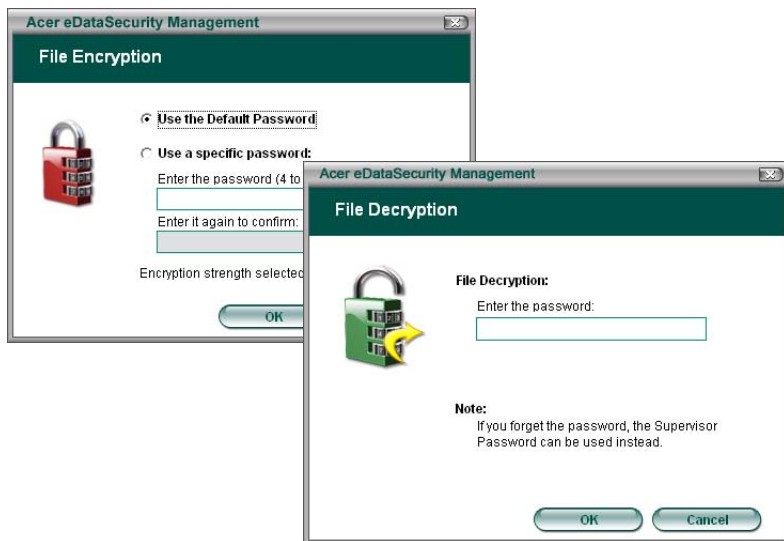

Acer eLock Management

Acer eLock Management is a security utility that allows you to lock up your removable data, optical and floppy drives to ensure that data can't be stolen while your computer is unattended.

- Removable data devices — includes USB disk drives, USB pen drives, USB flash drives, USB MP3 drives, USB memory card readers, IEEE 1394 disk drives and any other removable disk drives that can be mounted as a file system when plugged into the system
- Optical drive devices — includes any kind of CD-ROM or DVD-ROM drives
- Floppy disk drives — 3.5-inch disks only

To activate Acer eLock Management, a password must be set first. Once set, you may apply locks to any of the three kinds of devices. Lock(s) will immediately be set without any reboot necessary, and will remain locked after rebooting, until unlocked.

If you do not set a password, Acer eLock Management will reset back to the initial status with all locks removed.



.....

Note: If you lose your password, there is no method to reset it except by reformatting your computer or taking your PC to an Acer Customer Service Center. Be sure to remember or write down your password.



Acer ePerformance Management

Acer ePerformance Management is a system optimization tool that boosts the performance of your Acer computer. It provides you with the following options to enhance overall system performance:

- Memory optimization — release unused memory and check usage
- Disk optimization — remove unneeded items and files
- Speed optimization — improve the usability and performance of your Windows XP system



Acer eRecovery Management

Acer eRecovery Management is a powerful utility that does away with the need for recovery disks provided by the manufacturer. The Acer eRecovery Management utility occupies space in a hidden partition on your system's HDD. User-created backups are stored on D:\ drive. Acer eRecovery Management provides you with:

- Password protection
- Recovery of applications and drivers
- Image/data backup
 - Back up to HDD (set recovery point)
 - Back up to CD/DVD
- Image/data recovery tools
 - Recover from a hidden partition (factory defaults)
 - Recover from the HDD (most recent user-defined recovery point)
 - Recover from CD/DVD



.....

Note: If your computer did not come with a Recovery CD or System CD, please use Acer eRecovery Management's "System backup to optical disk" feature to burn a backup image to CD or DVD.

Acer eSettings Management

Acer eSettings Management allows you to inspect hardware specifications and to monitor the system health status. Furthermore, Acer eSettings Management enables you to optimize your Windows operating system, so your computer runs faster, smoother and better.

Acer eSettings Management also:

- Provides a simple graphical user interface letting you navigate through the program effortlessly
- Displays general system status and advanced monitoring for power users
- Logs when a hardware component has been removed or replaced
- Permits you to migrate personal settings
- Keeps a history log of all alerts that were previously issued



Acer eAcoustics Management

Acer eAcoustics Management is a utility that allows you to enjoy a quieter system, scaled to your individual performance needs. Acer eAcoustics Management reduces the sound created from your desktop by adjusting system fan speeds. Utilize different profiles, so you can find the optimal balance of system performance and acoustics.



2 First things first

This chapter describes the system specifications and contents of your computer package.

Specifications

Operating system	Microsoft® Windows® XP Professional Microsoft® Windows® XP Home Edition
Platform	Intel® Celeron® with 533 MHz FSB Intel® Pentium® 4 with 800/1066 MHz FSB
Chipset	Intel® 945G Express
System memory	Supporting up to 4 GB of DDR2 667 RAM Dual channels supported on four DIMMs
Drives	Veriton 5800: <ul style="list-style-type: none"> • Two external 5.25" drive bays • Three 3.5" drive bays (two internal, one external) Veriton 6800: <ul style="list-style-type: none"> • Two external 5.25" drive bays • Six 3.5" drive bays (four internal, two external) Veriton 7800: <ul style="list-style-type: none"> • Three external 5.25" drive bays • Six 3.5" drive bays (four internal, two external)
Network interface	Marvell® 88E8052 with gigabit Ethernet Optional PCI modem
I/O interface	Two PS/2 ports 9-pin serial port 25-pin parallel port Eight USB 2.0 ports Ethernet (RJ-45) port VGA port Six audio jacks
I/O expansion	Two PCI slots PCI Express™ x1 slot
Graphics	Integrated graphics with DVMT 3.0 PCI Express™ x16 slot

Audio	Realtek ALC880 with embedded Intel® HDA CODEC
Keyboard	PS/2 or USB multimedia keyboard
Monitor	Choice of Acer CRT or LCD monitors
Security	Acer Empowering Technology Lock pad and intrusion alert
Housing	Veriton 5800 Series: 370 (H) x 130.2 (W) x 435 (D) mm Veriton 6800 Series: 370 (H) x 183 (W) x 450 (D) mm Veriton 7800 Series: 450 (H) x 187 (W) x 495 (D) mm
Management software	Norton AntiVirus™ Acer Empowering Technology
Industry standards	PC2001 SMBIOS (DMI) 2.3.1 PCI 2.3 WFM 2.0 ACPI 2.0 Microsoft® OnNow ENERGY STAR MacroVision
Power supply	300 W
Certification	FCC, CE, C-tick, BSMI, VCCI, CCC, cUL, UL, Nemko, GS (TUV), ENERGY STAR



Note: The specifications listed above are for reference only. The exact configuration of your PC depends on the model purchased.

Package contents

Before you unpack your computer, make sure that you have enough space to set up your computer.

Carefully unpack the carton and remove the contents. If any of the following items are missing or damaged, contact your dealer immediately:

- Veriton series
- Items contained in the accessory box
 - USB or PS/2 keyboard
 - USB or PS/2 mouse
- User's Guide and installation poster
- Other user documentation and third-party software

Accessing the User's Guide

This User's Guide is also available on your computer as an Adobe Acrobat PDF file.

To access the User's Guide (for Windows XP)

- 1 On the Windows XP taskbar, click on the **start** button then select **Help and Support**.
- 2 On the Help and Support Center home page, double-click the Veriton Series Online icon.

3 System tour

This chapter discusses the features and components of your computer.

Features

Here are just a few of your computer's many features:

Performance

- Intel® Celeron® supporting FSB up to 533 MHz, or Intel® Pentium® 4 supporting FSB (front side bus) up to 800/1066 MHz
- Intel® 945G Express chipset
- DDR2 667, 4 DIMM slots, expandable to 4 GB dual-channel memory
- Power management function
- CD-ROM, CD-RW, DVD-ROM, DVD/CD-RW combo, DVD-Dual or DVD-Super multi drive
- High-capacity, Enhanced-IDE hard disk

Multimedia

- Intel® high-definition audio
- Supporting up to 7.1 surround sound, audio CODEC support for 192 KHz quality, multiple streams.
- 3D quality audio system via onboard audio controller
- Audio-in/line-in, audio-out/line-out, headphone-out and microphone-in interfaces

Connectivity

- Two PS/2 interfaces for mouse and keyboard
- One serial port (optional 2nd serial port connection)
- One parallel port
- One VGA port
- Eight Universal Serial Bus (USB) 2.0 ports (four on the front; four on the rear panel)
- High-speed V.92, 56K fax/modem (manufacturing option)
- Gigabit Ethernet LAN support with remote wake-up function

Front panel

Your computer's front panel consists of the following:

Veriton 5800

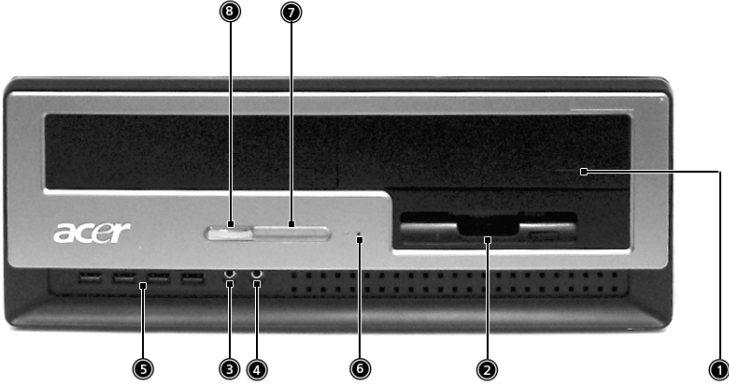



Veriton 6800

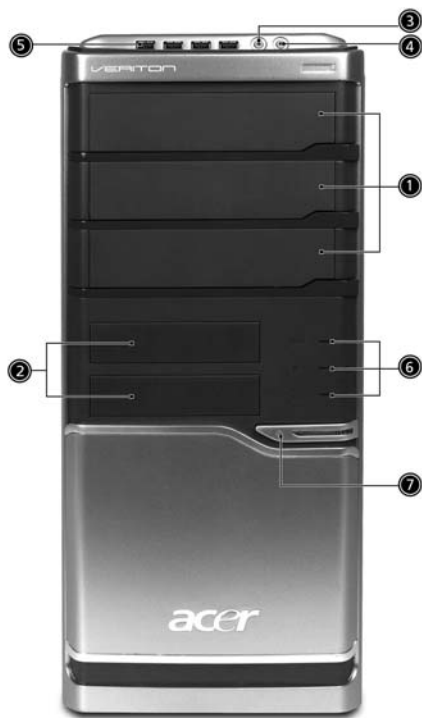

Veriton 7800



Icon	Component	Veriton 5800	Veriton 6800/7800
	5.25" drive bay(s)	1	1
	3.5" floppy drive	2	2
	Microphone-in jack (front)	3	3
	Speaker-out/line-out port	4	4
	USB ports	5	5
	Hardware reset button	6	
	Indicators	7	6
	Power button	8	7

Rear panel

Your computer's rear panel consists of the following:

Veriton 5800

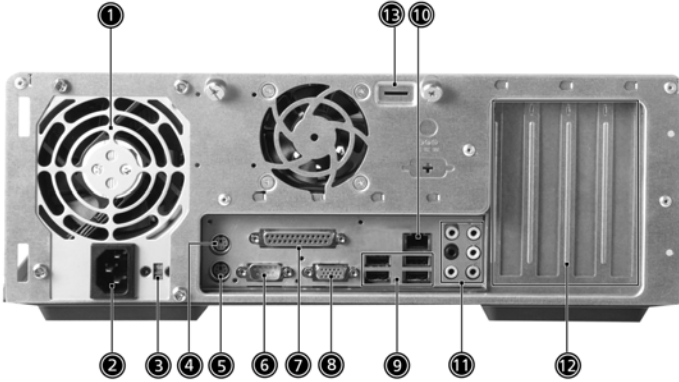



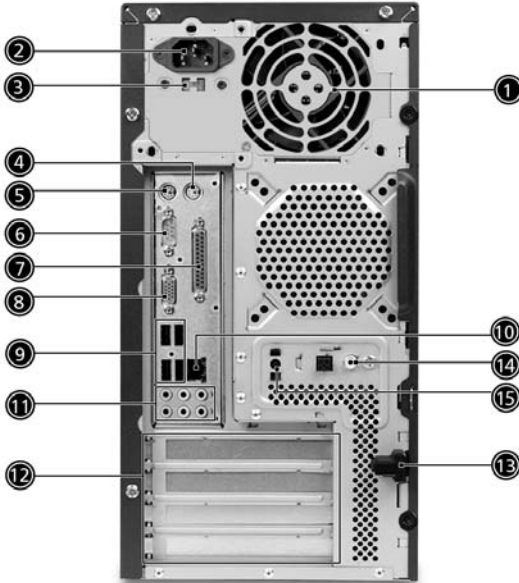

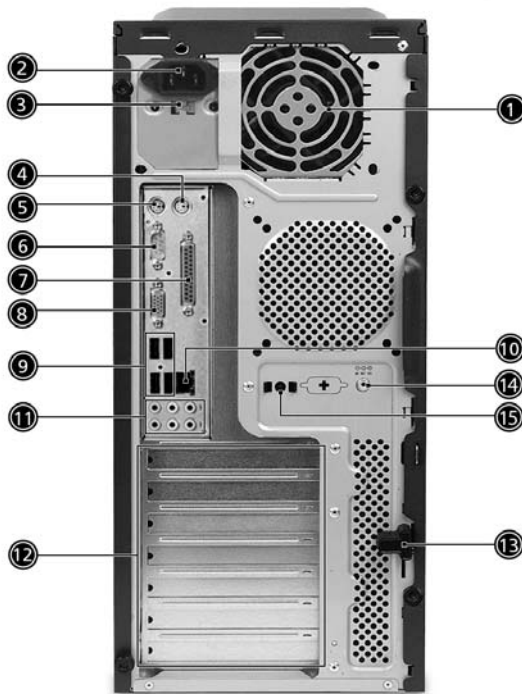

Veriton 6800





Veriton 7800



Icon	Component	Veriton 5800/6800/7800
	Power supply	1
	Power cord socket	2
	Voltage selector switch	3
	PS/2 mouse port	4
	PS/2 keyboard port	5
	Serial port	6
	Parallel/printer port	7
	CRT/LCD monitor port	8
	USB ports	9
	Network port	10

Icon	Component	Veriton 5800/6800/7800
	Audio jack	11
	Expansion slots	12
	Chassis lock pad	13
	Hardware reset button	14

Audio jacks function table

Color/Use	Headphone	1.1 CH	3.1 CH	5.1 CH	7.1 CH
Blue 	Line-in	Line-in	Line-in	Line-in	Line-in
Green 	Headphone	Line-out	Front	Front	Front
Pink 		Mic-in	Mic-in	Mic-in	Mic-in
Orange				Rear	Rear
Black			Center & woofer	Center & woofer	Center & woofer
Gray					Side



.....
Note: See "Connecting peripherals" on page 37 and "Connecting options" on page 41 for more information.

Keyboard

The keyboard has full-sized keys that include separate cursor keys, two Windows keys, four multimedia keys, and 12 function keys.

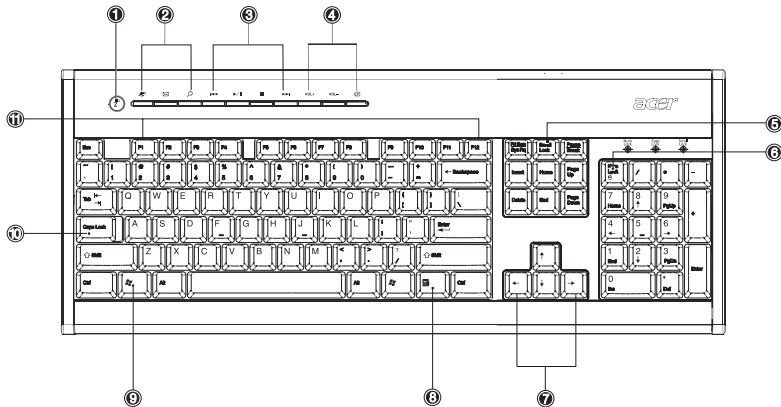

For information on how to connect your keyboard, see **"Connecting your mouse and keyboard"** on page 37.



No.	Description	No.	Description
1	Sleep button	2	Internet/Email/Search keys
3	Multimedia keys	4	Volume control/mute keys
5	Scroll Lock key	6	Num Lock key
7	Cursor keys	8	Application key
9	Windows logo key	10	Caps Lock key
11	Function keys		

Internet/Email/Search keys





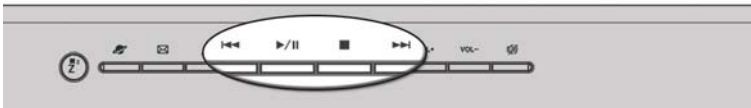

Icon	Key	Description
	Web browser	Launches your current default browser.
	Email	Launches your email application.
	Search	Opens a search window.

Multimedia keys

Allow you to conveniently play, pause, stop, advance or rewind a song or movie using your keyboard.



Icon	Key	Description
	Backward	Press to skip backward to the previous track or video file.
	Play/pause	Press to start playing the audio track or video file. Press again to pause.
	Stop	Press to stop playing the audio track or video file.
	Forward	Press to skip forward to the next track or video file.

Volume control/mute keys

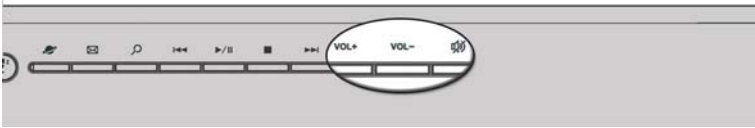

Icon	Key	Description
VOL+	Volume up	Press to increase audio volume.
VOL-	Volume down	Press to decrease audio volume.
	Mute	Toggle sound on/off.

Lock keys

The keyboard has three lock keys which you can toggle on and off to switch between functions.



Lock key	Description
Scroll Lock	When activated, the screen moves one line up or down when you press the up arrow or down arrow, respectively.
Num Lock	When activated, the keypad is set to numeric mode, i.e., the keys function as a calculator (complete with arithmetic operators such as +, -, * and /).
Caps Lock	When activated, all alphabetic characters typed appear in uppercase (same function as pressing Shift + <letter>).



Note: Scroll Lock may not work with some applications.

Cursor keys









The cursor keys, also called the arrow keys, let you move the cursor around the screen. They serve the same function as the arrow keys on the numeric keypad when the Num Lock is toggled off.



Windows keys

The keyboard has two keys that perform Windows-specific functions.



Key	Description
Windows key 	<p>Pressed alone, this key has the same effect as clicking on the Windows Start button; it launches the Start menu. It can also be used with other keys to provide a variety of functions:</p> <ul style="list-style-type: none"> <  > + <Tab> Activates the next Taskbar button. <  > + <E> Opens the My Computer window. <  > + <F1> Opens Help and Support. <  > + <F> Opens the Find: All Files dialog box. <  > + <R> Opens the Run dialog box. <  > + <M> Minimizes all windows. <Shift> + <  > + <M> Undoes the minimize all windows action.
Application key 	<p>This key has the same effect as clicking the right mouse button; it opens the application's context menu.</p>

Function keys

The function keys, F1 - F12, let you perform specific functions, depending on the application that uses them.

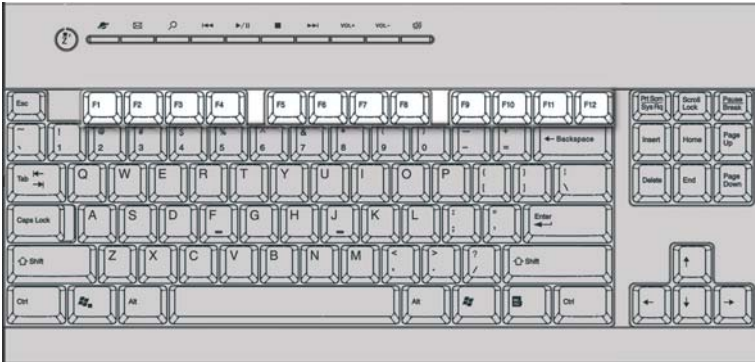

Palm rest

The detachable palm rest provides you with a comfortable place to rest your hands while typing.

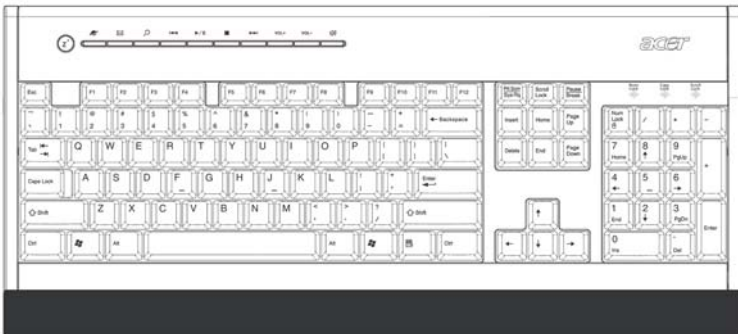

Optical drive

Your computer may come with a CD-ROM, DVD-ROM, DVD/CD-RW combo, DVD-Dual or DVD-Super multi drive. This drive is located on the front panel of your computer. The CD drive allows you to play different types of compact disks (CDs). The DVD drive allows you to play not only old CD-ROMs, CD-I disks, and video CDs, but digital video disks (DVDs) as well. DVD-ROM is a type of disk media with enough storage space for a full-length movie. The CD-RW, DVD-Dual and DVD-super multi drive allow you to record or burn recordable and rewritable disks.

CDs and DVDs, like diskettes, are also compact, lightweight and easy to carry around. However, they are more delicate than diskettes and must be handled with extra care.

To insert a CD or DVD into your computer's CD or DVD drive:

1. Gently push the Eject button located on the front panel.

Veriton 5800



Veriton 6800/7800



2. When the disk tray slides open, place the CD or DVD gently on the tray. Make sure that the label or title side of the disk is facing upward. When holding a disk, hold it by the edges to avoid leaving smudges or fingerprints.

Veriton 5800



Veriton 6800/7800



3. Push the tray and it will close automatically.

Taking care of your CDs and DVDs

- Keep your disk in its case when not in use to avoid scratches or other damage. Any kind of dirt or damage can affect the data on the disk, impair the disk lens reader on the CD or DVD drive, or stop the computer from successfully reading the disk.
- When handling disks, always hold them by the edges to avoid smudges or fingerprints.
- When cleaning disks, use a clean, dust-free cloth and wipe in a straight line from the center to the edge. Do not wipe in a circular motion.
- Clean your CD or DVD drive periodically. You may refer to the Cleaning Kit for instructions. Cleaning kits can be purchased in any computer or electronics shop.

Hard disk

Your computer is pre-installed with a high-capacity Enhanced-IDE (E-IDE) hard disk.

For instructions on how to upgrade or replace your hard disk, see:

"Replacing the Veriton 5800's hard disk" on page 58.

"Replacing the Veriton 6800/7800's hard disk" on page 60.

4 Setting up your computer

This chapter contains step-by-step instructions on how to set up your computer and connect additional peripherals.

Arranging a comfortable work area

Working safely and comfortably begins with the arrangement of your work space and the proper use of equipment. For this reason, it is very important to take time and think about how you are going to arrange your work area. Refer to the diagram on the following page as you set up your system.

Here are some points to consider:

Adjusting your chair

Having the right kind of chair does not necessarily mean you'll be properly supported. It is necessary to adjust your chair to fit your body. Proper body posture will make you more comfortable and productive.

- Avoid tilting your chair. If you have a chair that tilts, lock the tilt knobs so that your chair will not tilt forward or backward while you are using your computer.
- Adjust your chair height in such a way that you can sit on it with your thighs parallel to the floor and your feet resting flat on the floor.
- Rest your body on the chair back. Your torso works harder to maintain balance if you do not rest your body on the chair back.

Positioning your PC

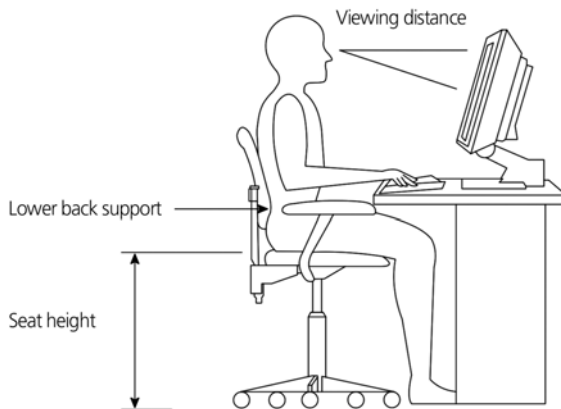

Take note of the following when selecting a location for your computer:

- Do not put your computer near any equipment that might cause electromagnetic or radio frequency interference, such as radio transmitters, televisions, copy machines or heating and air-conditioning equipment.
- Avoid dusty areas and extremes of temperature and humidity.
- You may place your computer beside your desk or under your table, as long as it does not block the space you need for working and moving.

Positioning your monitor

Place your monitor at a comfortable viewing distance, usually 50 to 60 cm away. Adjust the display in such a way that the top of the screen is at or slightly below eye level.

Positioning your keyboard

The location of the keyboard is a very important factor for your posture. Placing it too far away will make your body lean forward, forcing you to sit in an unnatural position. Placing it too high will add tension to your shoulder muscles.

- The keyboard should be placed just above your lap. Adjust the keyboard height by flipping the folding stands located under the keyboard.
- Keep your lower arms parallel to the floor as you type. Your upper arms and shoulders should be relaxed. Then try typing with a light touch. If you feel any shoulder or neck strain, stop for a while and check your posture.
- Position your keyboard in front of your monitor. Putting your keyboard beside your monitor will make you turn your head while you type which could add tension to your neck muscles.

Positioning your mouse

- The mouse should be placed on the same surface as your keyboard so that you can reach it with ease.
- Adjust its position to allow enough space for movement without making you stretch or lean over.
- Use your arm to move the mouse. Do not rest your wrist on the table when moving the mouse.

Connecting peripherals

Setting up your computer is easy. For the most part, you only have four things to connect: the mouse, the keyboard, the monitor, and the power cable.



.....

Note: The peripherals shown in the connections below are for your reference only. Actual device models may vary in select countries.

Connecting your mouse and keyboard

USB interface

Plug your USB mouse or keyboard cable into any of the USB ports  located on the front and rear panels of your computer.

PS/2 interface

Plug the PS/2 mouse and keyboard cable into the PS/2 keyboard port (purple port) and mouse port (green port) located on the rear panel of your computer.



Connecting a monitor

To connect a monitor, simply plug the monitor cable into the monitor port (blue port) located on the rear panel of your computer .



Note: When a VGA card is added to the PCI Express slot, the monitor should be connected to the add-on card and the onboard VGA will be disabled.

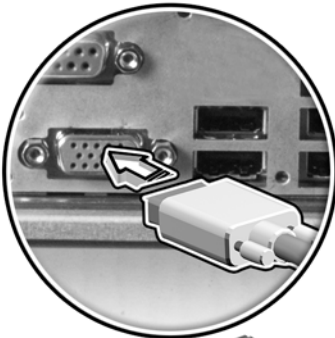
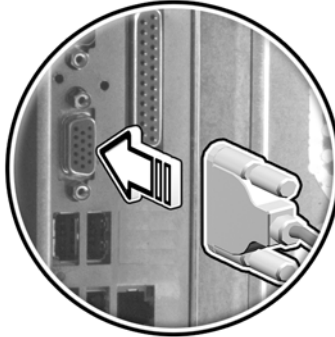

Note: Refer to the monitor manual for additional instructions and information.

Connecting the power cable



Caution: Before you proceed, check the voltage range in your area. Make sure that it matches your computer's voltage setting. If they don't match, change your computer's voltage setting according to your area's voltage range.

Set the voltage selector switch to the voltage range applicable to your area (a). Plug the power cable into the power cable socket located on the rear panel of your computer (b). Then plug the other end of the power cable into a power outlet (c).

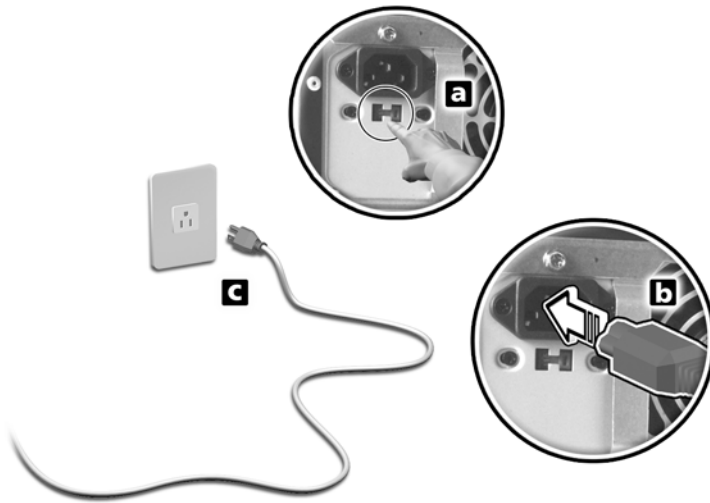

Turning on your computer

After connecting the necessary peripherals and plugging in the power cable, you are now ready to turn the computer on and get to work.

To turn on your computer:

- 1 Turn on all peripherals connected to your computer, such as the monitor, printer, speakers, etc.
- 2 On the front panel of your computer, press the Power button.



Important: Make sure that the power cable is properly plugged into an electrical outlet. If you are using a power strip or an AVR (Auto-Voltage Regulator), make sure that it is plugged in and turned on.

Turning off your computer

To turn off your computer, follow the steps below.

For Windows XP:

- 1 On the Windows XP taskbar, click on the Start button, and click Turn Off Computer, then click Turn Off.
- 2 Turn off all peripherals connected to your computer.

If you cannot shut down your computer normally, press and hold the power button for at least four seconds. Quickly pressing the button may put the computer in suspend mode only.

Connecting options

Connecting your printer

Your computer supports parallel, serial and USB printers.

To connect a parallel printer, plug the printer cable into the parallel port (burgundy port) located on the rear panel of your computer. 





.....
Note: The printer shown below is for your reference only. Actual device model may vary by country.



.....
Note: If you are using a serial printer, connect the printer cable into the serial port located on the rear panel of your computer. In the same manner, connect a USB printer by plugging the printer cable into any of the USB ports located on the front and rear panels.

Connecting the modem (optional)

Set up your modem connection by plugging the telephone line  and handset line  into their corresponding ports on the rear panel of your computer.

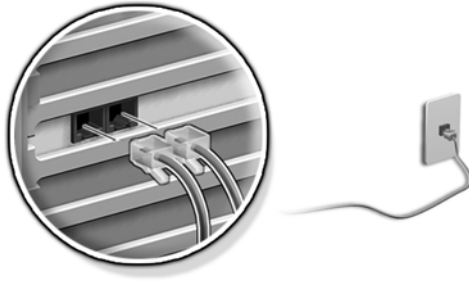

Connecting to the network

You can connect your computer to a Local Area Network (LAN) using a network cable. To do so, simply plug the network cable into the network port  on the rear panel of your computer.

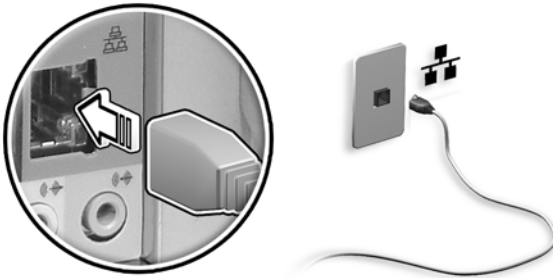

Note: Consult your network system administrator or operating system manual for information on how to configure your network setup.

Connecting multimedia devices

You can connect multimedia devices such as microphones, earphones or headphones, external speakers and audio line-in devices. These devices will let you take advantage of your computer's multimedia features.



.....

Note: The multimedia devices shown below are for reference only. Actual device models may vary in select countries.

Plug the devices in as follows:

- Microphone: Connects to the Microphone-in jacks  (pink jacks) located on the front and rear panels of your computer.

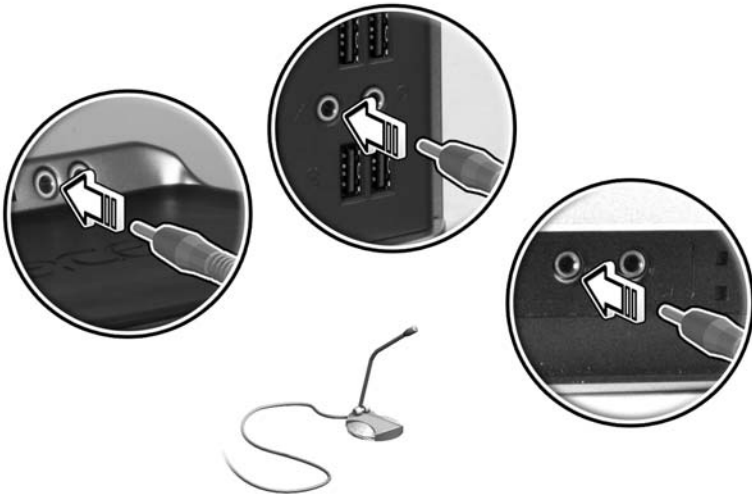

.....

Note: For information on how to configure multimedia devices, consult the documentation that came with each device.

- Earphones, headphones: Connect to the headphone jack  located on the front panel of your computer.



Note: To adjust the headphone volume, use the volume control buttons on the keyboard. You can also adjust the volume by using the volume icon on the taskbar at the bottom of your screen.

- External speakers: Connect to the audio-out/line-out jack  (lime-green jack) located on the rear panel of your computer.

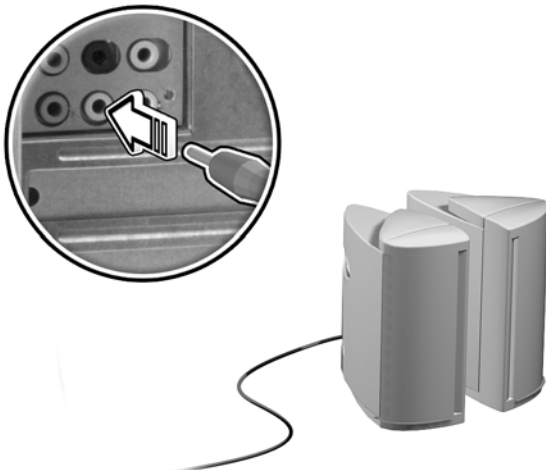

- Audio line-in device: Connects to the audio-in/line-in jack  (light blue jack) located on the rear panel of your computer

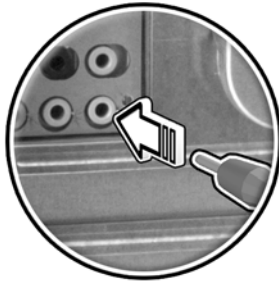

Connecting USB devices

Universal Serial Bus (USB) is a serial bus design capable of cascading peripherals such as a digital camera, keyboard, mouse, joystick, scanner, printer and modem. With USB, complex cable connections can be eliminated.

Your computer comes with eight external USB ports: four on the front and four on the rear panel. These ports support USB 2.0 high-performance external devices such as webcams and digital still cameras. They also allow you to connect additional USB devices to your computer without using up its resources.

To connect a USB device, simply plug the device cable into any of the USB ports  (black) located on the front and rear panels of your computer.

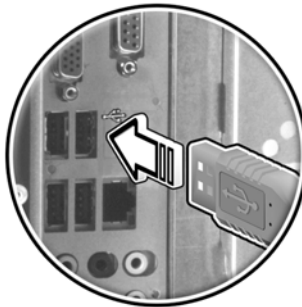



.....
Note: The USB devices shown below are for reference only. Actual device models may vary by geographic region.

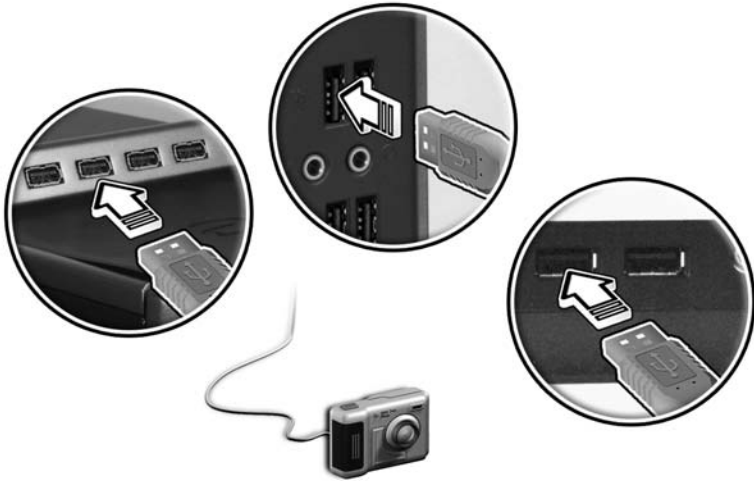

.....
Note: Some USB devices have a built-in USB port which permits you to connect more USB devices.

5 Upgrading your computer

This chapter contains instructions on how to upgrade your computer, and basic information about your system boards that you will find helpful when performing the upgrade process.

Installation precautions

Before you install any computer component, we recommend that you read the following sections. These sections contain important ESD precautions along with preinstallation and post-installation instructions.

ESD precautions

Electrostatic discharge (ESD) can damage your processor, disk drives, expansion boards, and other components. Always observe the following precautions before you install a computer component:

- 1 Do not remove a component from its protective packaging until you are ready to install it.
- 2 Wear a wrist grounding strap and attach it to a metal part of the computer before handling components. If a wrist strap is not available, maintain contact with the computer throughout any procedure requiring ESD protection.

Preinstallation instructions

Always observe the following before you install any component:

- 1 Turn off your computer and all the peripherals connected to it before opening it. Then unplug all cables from the power outlets.
- 2 Open your computer according to the instructions on page 49.
- 3 Follow the ESD precautions described above before handling a computer component.
- 4 Remove any expansion boards or peripherals that block access to the DIMM sockets or component connectors.
- 5 See the following sections for specific instructions on the component you wish to install.



.....

Warning! Not turning off the computer properly before you start installing the components may cause serious damage. Do not attempt the procedures described in the following sections unless you are a qualified service technician.

Post-installation instructions

Observe the following after installing a computer component:

- 1 See to it that the components are installed according to the step-by-step instructions in their respective sections.
- 2 Replace any expansion boards or peripherals that you removed earlier.
- 3 Replace the side panels.
- 4 Connect the necessary cables and turn on your computer.

Opening your Veriton 5800



.....

Caution! Before you proceed, make sure that you have turned off your computer and all peripherals connected to it. Read the **"Preinstallation instructions" on page 49.**

You need to open your computer before you can install additional components. See the following section for instructions:

To remove the computer cover

- 1 Turn off your computer and unplug all cables.
- 2 Place your computer on a flat, steady surface.
- 3 Turn the thumbscrews counterclockwise with your fingers to release the cover.
 - a Hold the cover with both hands.
 - b Slide it back about an inch and then gently lift it upward to detach it.



To replace the computer cover

- 1 Align the cover to the housing frame and then push it in to slide it back into place.
- 2 Secure the cover with the thumbscrews you released earlier.

Opening your Veriton 6800/7800



.....

Caution! Before you proceed, make sure that you have turned off your computer and all peripherals connected to it. Read the **"Preinstallation instructions" on page 49.**

You need to open your computer before you can install additional components. See the following section for instructions:

To remove the side panel

- 1 Turn off your computer and unplug all cables.
- 2 Place your computer on a flat, steady surface.
- 3 Turn the screws counterclockwise with your fingers to release the cover.
- 4 Hold right panel (from rear view) with both hands. Slide it back about an inch and then gently pull it outward to detach it.

Veriton 6800



Veriton 7800



To replace the side panel

- 1 Align the side panel's hinges to the housing frame and then push it in to slide it back into place.
- 2 Secure the side panels with the two screws.

System boards

Mainboard layout

The mainboard becomes accessible once you open your computer. Refer to the section below for the corresponding mainboard layout of your Veriton 5800/6800/7800 series computer model.

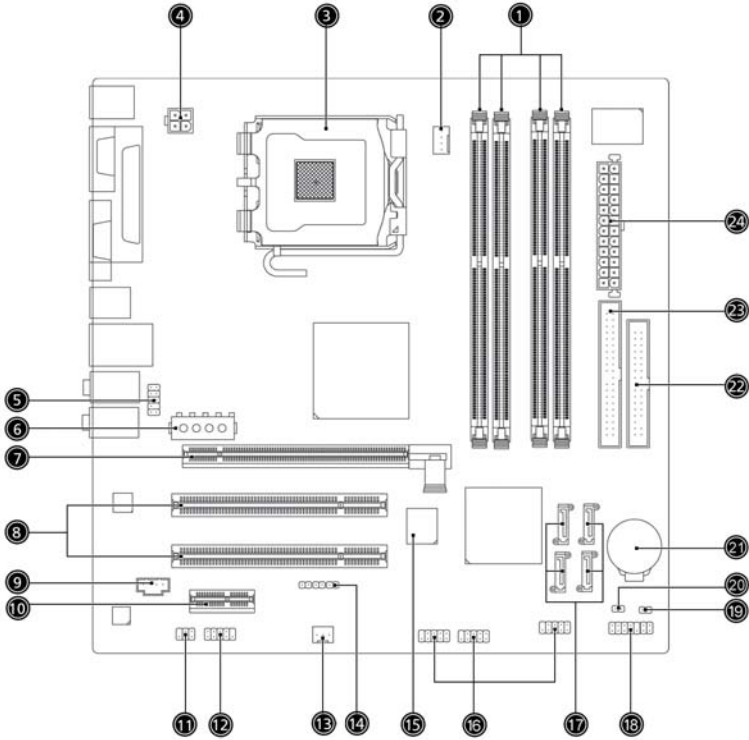

No.	Component	No.	Component
1	4 memory slots	2	CPU fan connector
3	CPU socket	4	ATX 12V power connector
5	USB connectors	6	PCI Express X16 connector
7	2 PCI conventional bus connectors	8	CD audio connector
9	S/PDIF audio connector	10	External COM port connector
11	System fan connector	12	OneButton Recovery connector
13	BIOS	14	USB connectors
15	4 Serial ATA IDE connectors	16	Front LED connector
17	Chassis intrusion connector	18	Clear CMOS jumper No jumper — normal Jumper — clear CMOS
19	Lithium battery	20	Diskette drive connector
21	Parallel ATA IDE connector	22	Main power connector

Upgrading your computer

Certain components of your computer are upgradeable, such as the memory, the hard disk, the CPU and the expansion cards. You need to observe the **"Installation precautions" on page 49** when installing or removing a computer component. However, for safety purposes, we do not recommend that you perform these upgrades yourself. If you want to replace or upgrade any of these components, contact your dealer or a qualified service technician for assistance.



.....

Note: The mainboard model shown in the following figures may not be exactly the same as the one found in your computer.

Installing additional memory

The four 240-pin sockets on the mainboard support Double Data Rate 2 (DDR2) Synchronous Dynamic Random Access Memory (SDRAM)-type DIMMs. You may install 128 MB, 256 MB, 512 MB or 1 GB DIMMs for a maximum memory capacity of 4 GB.

The DDR2 DIMMs require 1.8 volts. You can install PC2 3200/DDR2 400, or PC2 4300/DDR2 533 modules in the DDR2 DIMM sockets. Contact your dealer for qualified DIMM vendors.

Each DDR2 DIMM socket is independent from the other. This independence allows you to install DDR2 DIMMs with different capacities to form different configurations.

To remove a DDR2 DIMM



.....

Note: The DDR2 DIMM has only one notch located toward the center of the module.

- 1 Remove the side panel.
- 2 Locate the DDR2 DIMM socket on the mainboard.

- 3 Press the holding clips on both sides of the DDR2 DIMM socket outward to release the DDR2 DIMM (a). Gently pull the DDR2 DIMM out of the socket (b).

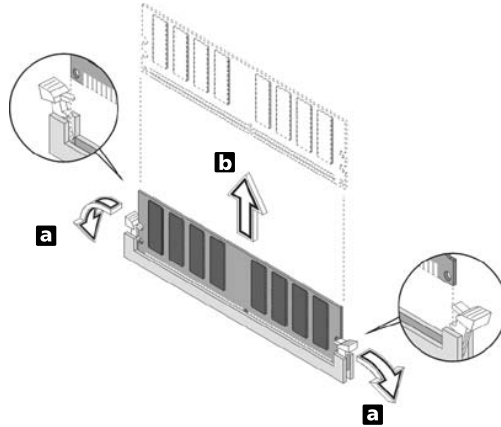

To install a DDR2 DIMM

- 1 Locate the DDR2 DIMM socket on the mainboard.
- 2 Align the DDR2 DIMM with the socket (a). Press the DDR2 DIMM into the socket until the clips lock onto the DDR2 DIMM (b).

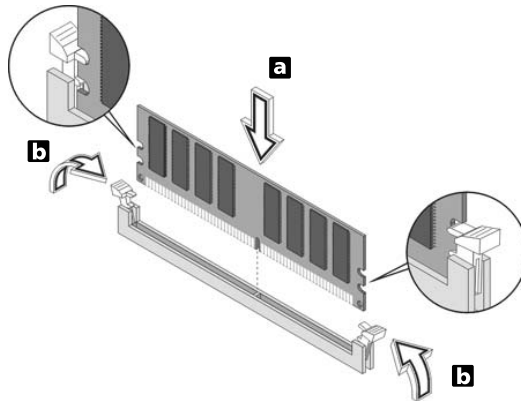

Note: The DDR2 DIMM sockets are slotted to ensure proper installation. If you insert a DDR2 DIMM but it does not fit easily into the socket, turn the DDR2 DIMM around and try to insert it again.

To reconfigure your computer

Your computer automatically detects the amount of memory installed. Run the BIOS utility to view the new value for total system memory and make a note of it.

Replacing the Veriton 5800's hard disk

Follow these steps to replace your computer's hard disk:

- 1 Remove the computer cover.
- 2 Detach all cables connected to the hard disk and pull the hard disk out.
- 3 Remove the drive rails that hold the hard disk to the disk frame and detach the hard disk. Set the drive rails aside.
- 4 Insert the new hard disk into the frame and secure it with drive rails.
- 5 Reattach all cables to the new hard disk.



Note: Make sure that the other ends of the disk cables are securely connected to their corresponding connectors on the mainboard.

- 6 Reinstall the metal bracket frame to the housing.
- 7 Replace the computer cover.

Installing an expansion card

To install an expansion card:

- 1 Remove the computer cover.
- 2 Locate an empty PCI Express or PCI slot on the mainboard.
- 3 Remove the bracket lock that holds the bracket to the computer. Save the lock.

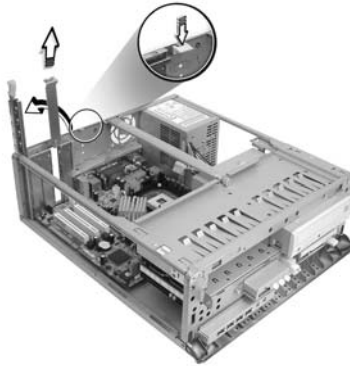

- 4 Pull out the bracket on the housing opposite the selected empty slot.
- 5 Remove the expansion card from its protective packaging.
- 6 Align the card in the empty bracket and then insert it into the slot. Make sure that the card is properly seated.
- 7 Secure the card to your computer with the bracket lock you removed earlier.

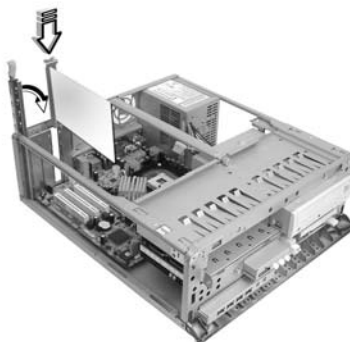

- 8 Replace the computer cover.

When you turn on the computer, BIOS automatically detects and assigns resources to the newly installed devices.

Replacing the Veriton 6800/7800's hard disk

Follow these steps to replace your computer's hard disk:

- 1 Remove the side panel.
- 2 Detach the power and hard disk cables from the hard disk(a). Detach the hard disk from the drive frame (b).

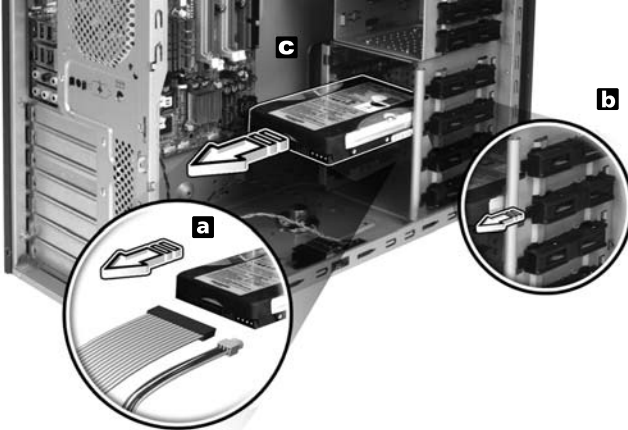

- 3 Insert the new hard disk into the frame (a). Connect the power and hard disk cables to the new hard disk (b).

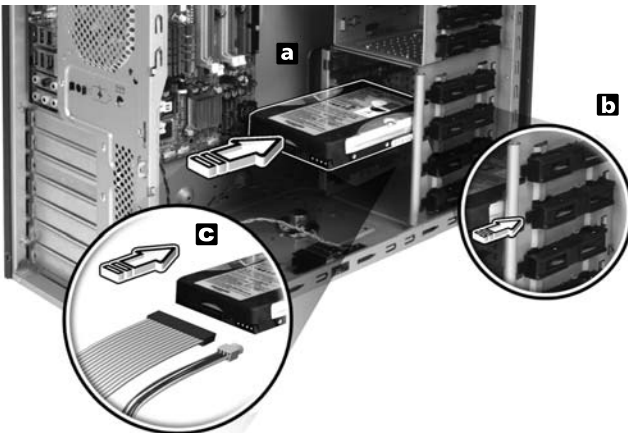

Note: Make sure that the other ends of the disk cables are securely connected to their corresponding connectors on the mainboard.

- 4 Replace the side panel. See "To replace the side panel" on page 53.

Installing an expansion card

To install an expansion card:

- 1 Remove the side panel (see page 52).
- 2 Locate an empty PCI Express or PCI slot on the mainboard.
- 3 Remove the lock that holds the bracket to the computer.
- 4 Pull out the bracket on the housing opposite the selected empty slot.
- 5 Remove the expansion card from its protective packaging.
- 6 Align the card with the empty bracket and then insert it into the slot. Make sure that the card is properly seated.
- 7 Secure the card to your computer with the bracket lock you removed earlier.
- 8 Replace the side panel. See **"To replace the side panel" on page 53.**

When you turn on the computer, BIOS automatically detects and assigns resources to the newly installed devices.

6 System utilities

This chapter describes applications that are preinstalled on your computer.

Depending on the hardware and optional features installed in your computer, your system came bundled with several program utilities designed to streamline your computer's operations. These utilities may include any of the following:

- Adobe Reader
- Norton AntiVirus
- NTI CD-Maker
- PowerDVD
- BIOS utility
- Acer Empowering Technology

If your computer is configured with Microsoft Windows XP, the following utilities can be used to monitor and maintain system health:

- Backup
- Disk Defragmenter

All of the applications that came with your computer are very easy to use. However, if you need more help or information, you may refer to the online help documentation provided in each software application.

Adobe Reader

Adobe Reader is software that lets you view, navigate, browse and print Adobe Portable Document Format (PDF) files on all major computer platforms.



To read a PDF document  you can:

- Simply double click on any file with an icon like that shown above.

or

- 1 On the windows taskbar, click on the Start button, highlight Programs, and select Adobe Reader.
- 2 Once the program is running, select Open from the File menu.
- 3 Select the file you wish to view in the Open file browser and click the Open button.

For more information about Adobe Reader, you may refer to the Adobe Reader Help menu.

Norton AntiVirus

Norton AntiVirus is an anti-virus software that finds and repairs infected files, and protects against viruses to keep your computer data safe and secure.

How do I check for viruses?

A Full System Scan scans all files on your computer. To perform a system scan:

- 1 Start Norton AntiVirus.

Double click on the Norton AntiVirus Icon on the desktop or click on the Start menu in the Windows taskbar, highlight Programs, and select Norton AntiVirus.

- 2 In the Norton AntiVirus main window, click Scan for Viruses.

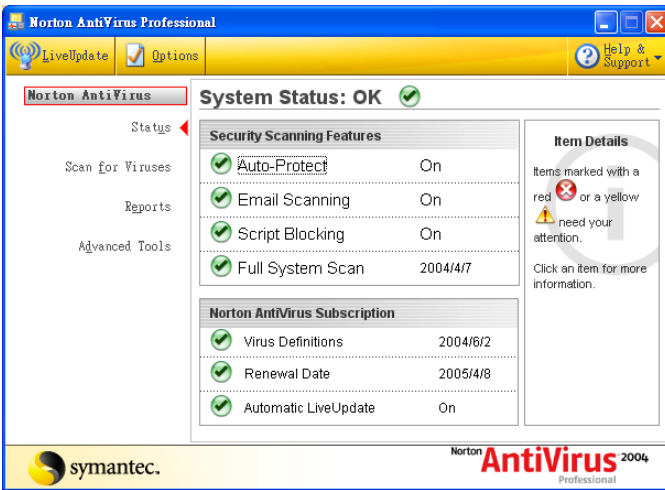

- 3 In the Scan for Viruses panel, click Scan My Computer.

- 4 Under Actions, click Scan.

- 5 When the scan is complete, a scan summary appears. Click Finished.

You can schedule customized virus scans that run unattended on specific dates and times or at periodic intervals. If you are using the computer when the scheduled scan begins, it runs in the background so that you do not have to stop working.

For more information refer to the Norton AntiVirus Help menu.

NTI CD&DVD-Maker (for models with CD or DVD Burner)

The NTI CD&DVD-Maker is optical disk-recording software that allows you to create and copy audio, data and videos to recordable or rewritable optical disks.

To copy an audio or data disk:

- 1 Click the Quick Burning icon  on the desktop.
- 2 Insert the CD you would like to copy into the source drive and a blank disk into the target drive.
- 3 Choose the source and target drives from the pull-down lists.

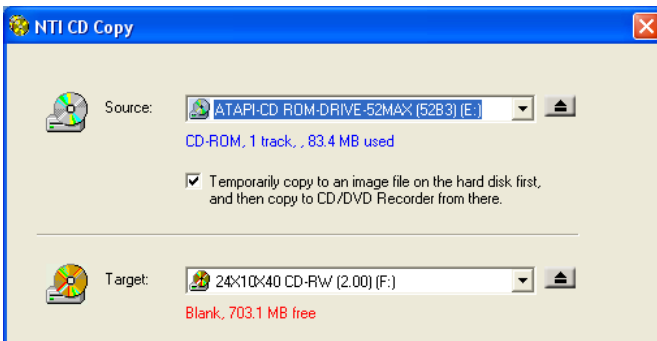

- 4 Click the Start button to begin copying.

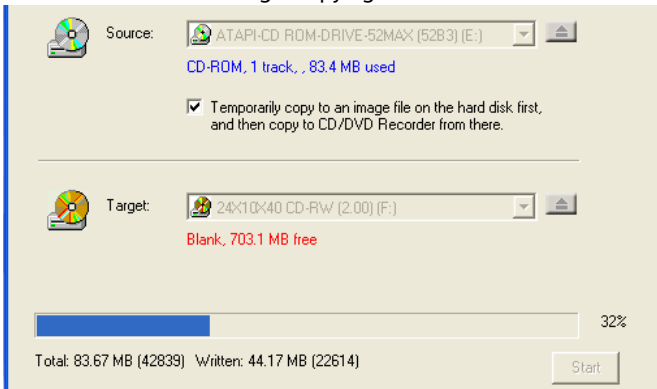

For more information about NTI CD&DVD-Maker and its other features, refer to the NTI CD&DVD-Maker Help menu.

PowerDVD (for models with DVD)

PowerDVD is a high-quality, pure software DVD player that brings high-quality movies and karaoke to your multimedia PC. You can play back high-resolution DVD titles or MPEG-2 files with MPEG-2 video and Dolby Digital (AC-3) audio. PowerDVD provides a complete set of commands for navigation and advanced features such as multi-angle switching, multi-language and multi-subtitle selection, and parental control. It also has the i-Power Internet Enabling feature, which links to online DVD resources via the Power DVD Desktop Portal Page.

How do I open and watch a DVD?

In most cases, when you insert a DVD into your computer's optical drive, PowerDVD will automatically open a viewer window and the control panel and begin playing.



If PowerDVD does not open automatically:

- 1 Click the Start button in the taskbar.
- 2 Highlight All Programs.
- 3 Click the Cyberlink PowerDVD tab.
- 4 Select PowerDVD.

When PowerDVD opens, simply press the play button  to begin playback.

For more information about Cyberlink PowerDVD and its other features, refer to the PowerDVD Help menu.

BIOS utility

The BIOS utility is a hardware configuration program built into your computer's Basic Input/Output System (BIOS). Since most computers are already properly configured and optimized, there is no need to run this utility. However, if you encounter configuration problems and get the "Run Setup" message, you will need to run this utility.



.....

Note: Before you run BIOS, make sure that you have saved all open files. The computer reboots immediately after you exit Setup.

To run the BIOS utility, press the **Del** key on your keyboard during computer boot up.

Reinstalling programs

If you uninstall one of the preinstalled programs and want to reinstall it, do the following:

- 1 Make sure that the system is turned on.
- 2 Insert the System CD into the CD or DVD drive.
- 3 Select the application that you want to reinstall.
- 4 Follow all onscreen instructions until you finish the installation.

Using backup (Windows XP only)

The Backup utility creates copies of information on your hard disk. In the event that the original data on your hard disk is erased or overwritten, or becomes inaccessible because of a hard disk malfunction, you can use the copy to restore your lost or damaged data.

How do I back up files from my hard drive?

To run the Backup utility:

- 1 Click the Start button in the taskbar.
- 2 Highlight All Programs
- 3 Click Accessories
- 4 Select System Tools
- 5 Click Backup

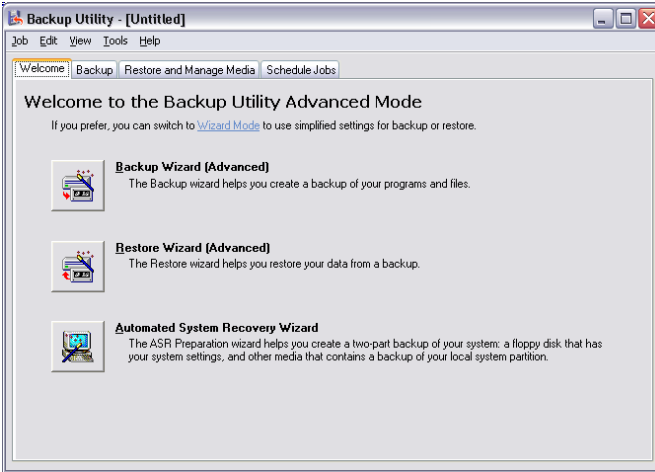

When Backup starts, follow the onscreen instructions to set up your backup profile and schedule.

For more information about Backup, refer to Windows XP help.

Disk defragmenter (Windows XP only)

The disk defragmentation utility consolidates files and folders on your computer's hard disk. This allows your computer to access files and folders and save new data more efficiently. By consolidating your files and folders, the defragmenter also consolidates the volume's free space, making it less likely that new files will be fragmented.

How do I defragment my hard drive?

To run the Disk Defragmenter:

- 1 Click the Start button in the taskbar.
- 2 Highlight All Programs
- 3 Click Accessories
- 4 Select System Tools
- 5 Click Disk Defragmenter

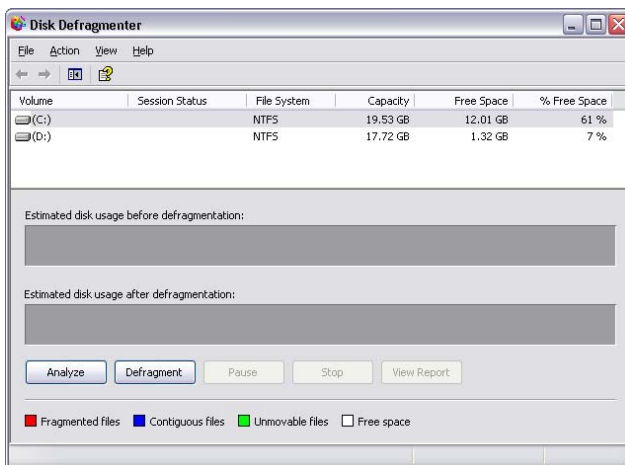

When Disk Defragmenter opens, select a drive/volume and click Analyze. The system will quickly examine the volume and determine whether or not it needs to be defragmented.

For more information about Disk Defragmenter, refer to Windows XP help.

7 Frequently asked questions

This chapter tells you what to do in case your computer is not working properly. However, if a more serious problem arises, contact your dealer or the technical support center (www.acersupport.com) for assistance.

Frequently asked questions

The following questions indicate possible situations that may arise during the use of your computer and each is followed by easy answers and solutions.

I pressed the power switch but the system did not boot up.

Check the LED located above the power switch.

If the LED is not lit, no power is being applied to the system. Try the following:

- Check if the voltage selector switch located on the rear panel of the computer is set to the correct voltage.
- Check if you properly plugged the power cable into an electrical outlet.
- If you are using a power strip or AVR, make sure it is plugged in and turned on.

If the LED is lit, check the following:

- Is a nonbootable (nonsystem) diskette in the floppy drive? If yes, remove or replace it with a system diskette and press **<Ctrl> + <Alt> + ** to restart your computer.
- The operating system files may be damaged or missing. Insert the startup disk you created during Windows setup into the floppy drive and press **<Ctrl> + <Alt> + ** to restart your computer. This will automatically diagnose your system and make necessary fixes. However, if the diagnostic utility still reports a problem, then you may have to perform the recovery process to restore your system to its original default factory settings.



.....
Note: For more information about recovering your system, see "**Acer Empowering Technology**" on page 3.

Nothing appears on the screen.

Your computer's power management function automatically blanks the screen to save power. Just press any key to turn the display back on.

If pressing a key does not work, you can restart your computer. If restarting your computer does not work, contact your dealer or technical support center for assistance.

The printer does not work.

Do the following:

- Make sure the printer is connected to a power outlet and that it is turned on.
- Make sure the printer cable is connected securely to the system's parallel or USB port and the corresponding port on the printer. See "**Connecting your printer**" on page 41 for more information.
- For additional information concerning the printer, refer to the printer's documentation.

No sound comes out from the computer.

Check the following:

- The volume may be muted. Look for the Volume icon on the taskbar. If it is crossed-out, click on the icon and deselect the **Mute** option. You can also press the volume control/mute knob on your USB keyboard to toggle from mute to sound on.
- If headphones, earphones or external speakers are connected to the line-out jack of your computer, the internal or built-in speakers are automatically turned off.

System cannot read diskette, hard disk, CD or DVD information.

Check the following:

- Make sure you are using the correct type of disk.
- Make sure the CD or DVD is inserted into the drive correctly.
- Check if the CD or DVD is clean and unscratched.
- Check your drive by using a good (undamaged) disk. If your drive can not read the information on the good disk there may be a problem with the drive. Contact your dealer or technical support center for assistance.

System cannot write data on the hard disk or CD-R/CD-RW.

Check the following:

- Make sure the diskette or hard disk is not write-protected.
- Make sure you are using the correct type of disk or diskette.

Appendix A: Notices

ENERGY STAR guidelines compliance

As an ENERGY STAR partner, Acer Inc. has determined that this product meets the ENERGY STAR guidelines for energy efficiency.

FCC notice

This device has been tested and found to comply with the limits for a Class B digital device pursuant to Part 15 of the FCC rules. These limits are designed to provide reasonable protection against harmful interference in a residential installation. This device generates, uses, and can radiate radio frequency energy and, if not installed and used in accordance with the instructions, may cause harmful interference to radio communications.

However, there is no guarantee that interference will not occur in a particular installation. If this device does cause harmful interference to radio or television reception, which can be determined by turning the device off and on, the user is encouraged to try to correct the interference by one or more of the following measures:

- Reorient or relocate the receiving antenna.
- Increase the separation between the device and receiver.
- Connect the device into an outlet on a circuit different from that to which the receiver is connected.
- Consult the dealer or an experienced radio/television technician for help.

Notice: Shielded cables

All connections to other computing devices must be made using shielded cables to maintain compliance with FCC regulations.

Notice: Peripheral devices

Only peripherals (input/output devices, terminals, printers, etc.) certified to comply with the Class B limits may be attached to this equipment. Operation with non-certified peripherals is likely to result in interference to radio and TV reception.

Caution

Changes or modifications not expressly approved by the manufacturer could void the user's authority, which is granted by the Federal Communications Commission, to operate this computer.

Operation conditions

This device complies with Part 15 of the FCC Rules. Operation is subject to the following two conditions: (1) this device may not cause harmful interference, and (2) this device must accept any interference received, including interference that may cause undesired operation.

Notice: Canadian users

This Class B digital apparatus complies with Canadian ICES-003.

Remarque à l'intention des utilisateurs canadiens

Cet appareil numérique de la classe B est conforme à la norme NMB-003 du Canada.

Declaration of Conformity for EU countries

Acer hereby declares that this personal PC series is in compliance with the essential requirements and other relevant provisions of Directive 1999/5/EC.

Modem notices

Notice for USA

This equipment complies with Part 68 of the FCC rules. Located on the modem is a label that contains, among other information, the FCC Registration Number and Ringer Equivalence Number (REN) for this equipment. Upon request, you must provide this information to your telephone company.

If your telephone equipment causes harm to the telephone network, the telephone company may discontinue your service temporarily. If possible, they will notify you in advance. But, if advance notice is not practical, you will be notified as soon as possible. You will also be informed of your right to file a complaint with the FCC.

Your telephone company may make changes in its facilities, equipment, operations, or procedures that could affect the proper functioning of your equipment. If they do, you will be notified in advance to give you an opportunity to maintain uninterrupted telephone service.

If this equipment should fail to operate properly, disconnect the equipment from the phone line to determine if it is causing the problem. If the problem is with the equipment, discontinue use and contact your dealer or vendor.



Caution: To reduce the risk of fire, use only No. 26 AWG or larger UL Listed or CSA Certified Telecommunication Line Cord.

TBR 21

This equipment has been approved [Council Decision 98/482/EC — "TBR 21"] for single terminal connection to the Public Switched Telephone Network (PSTN). However, due to differences between the individual PSTNs provided in different countries, the approval does not, of itself, give an unconditional assurance of successful operation on every PSTN termination point. In the event of problems, you should contact your equipment supplier in the first instance.

Notice for Australia

For safety reasons, only connect headsets with a telecommunications compliance label. This includes customer equipment previously labelled permitted or certified.

Important safety instructions

Read these instructions carefully. Save them for future reference.

- 1 Follow all warnings and instructions marked on the product.
- 2 Unplug this product from the wall outlet before cleaning. Do not use liquid cleaners or aerosol cleaners. Use a water-moistened cloth for cleaning.
- 3 Do not use this product near water.
- 4 Do not place this product on an unstable cart, stand or table. If the product falls, it could be seriously damaged.
- 5 Slots and openings are provided for ventilation; to ensure reliable operation of the product and to protect it from overheating. These openings must not be blocked or covered. The openings should never be blocked by placing the product on a bed, sofa, rug or other similar surface. This product should never be placed near or over a radiator or heat register, or in a built-in installation unless proper ventilation is provided.
- 6 This product should be operated from the type of power indicated on the marking label. If you are not sure of the type of power available, consult your dealer or local power company.
- 7 Do not allow anything to rest on the power cord. Do not locate this product where people will walk on the cord.

- 8 If an extension cord is used with this product, make sure that the total ampere rating of the equipment plugged into the extension cord does not exceed the extension cord ampere rating. Also, make sure that the total rating of all products plugged into the wall outlet does not exceed the fuse rating.
- 9 Never push objects of any kind into this product through cabinet slots as they may touch dangerous voltage points or short-out parts that could result in a fire or electric shock. Never spill liquid of any kind onto or into the product.
- 10 Do not attempt to service this product yourself, as opening or removing covers may expose you to dangerous voltage points or other risks. Refer all servicing to qualified service personnel.
- 11 Unplug this product from the wall outlet and refer servicing to qualified service personnel under the following conditions:
 - a When the power cord or plug is damaged or frayed.
 - b If liquid has been spilled onto the product.
 - c If the product has been exposed to rain or water.
 - d If the product does not operate normally when the operating instructions are followed. Adjust only those controls that are covered by the operating instructions, since improper adjustment of other controls may result in damage and will often require extensive work by a qualified technician to restore the product to normal condition.
 - e If the product has been dropped or the case has been damaged.
 - f If the product exhibits a distinct change in performance, indicating a need for service.
- 12 Use only the proper type of power supply cord set (provided in your accessories box) for this unit. It should be a detachable type: UL listed/CSA certified, type SPT-2, rated 7A 125V minimum, VDE approved or its equivalent. Maximum length is 15 feet (4.6 meters).
- 13 Always disconnect all telephone lines from the wall outlet before servicing or disassembling this equipment.
- 14 Avoid using a telephone line (other than the cordless type) during an electrical storm. There may be a remote risk of electric shock from lightning.

Macrovision copyright protection notice

This product incorporates copyright protection technology that is protected by U.S. patents and other intellectual property rights. Use of this copyright protection technology must be authorized by Macrovision, and is intended for home and other limited viewing uses only unless otherwise authorized by Macrovision. Reverse engineering or disassembly is prohibited.

U.S. Patent Nos. 4,631,603; 4,819,098; 4,907,093; 5,315,448; and 6,516,132.

Lithium battery statement

CAUTION

Danger of explosion if battery is incorrectly replaced. Replace only with the same or equivalent type recommended by the manufacturer. Dispose of used batteries according to local regulations. Recycle if possible.

ADVARSEL!

Lithiumbatteri - Eksplosionsfare ved fejlagtig håndtering. Udskiftning må kun ske med batteri af samme fabrikat og type. Léver det brugte batteri tilbage til leverandøren.

ADVARSEL

Eksplosjonsfare ved feilaktig skifte av batteri. Benytt samme batteritype eller en tilsvarende type anbefalt av apparatfabrikanten. Brukte batterier kasseres i henhold til fabrikantens instruksjoner.

VARNING

Explosionsfara vid felaktigt batteribyte. Använd samma batterityp eller en ekvivalent typ som rekommenderas av apparattillverkaren. Kassera använt batteri enligt fabrikantens instruktion.

VAROITUS

Päristö voi räjähtää, jos se on virheellisesti asennettu. Vaihda paristö ainoastaan laitevalmistajan suosittellemaan tyyppiin. Hävitä käytetty paristö valmistajan ohjeiden mukaisesti.

VORSICHT!

Explosionsgefahr bei unsachgemäßen Austausch der Batterie Ersatz nur durch denselben oder einem vom Hersteller empfohlenem ähnlichen Typ. Entsorgung gebrauchter Batterien nach Angaben des Herstellers.

Laser compliance statement

The CD or DVD drive used with this computer is a laser product. The CD or DVD drive's classification label content (shown below) is located on the drive.

CLASS 1 LASER PRODUCT

CAUTION: INVISIBLE LASER RADIATION WHEN OPEN. AVOID EXPOSURE TO BEAM.

APPAREIL A LASER DE CLASSE 1 PRODUIT

LASERATTENTION: RADIATION DU FAISCEAU LASER INVISIBLE EN CAS D'OUVERTURE. EVITER TOUTE EXPOSITION AUX RAYONS.

LUOKAN 1 LASERLAITE LASER KLASSE 1

VORSICHT: UNSICHTBARE LASERSTRAHLUNG, WENN ABDECKUNG GEÖFFNET NICHT DEM STRAHL AUSSETZEN

PRODUCTO LÁSER DE LA CLASE I

ADVERTENCIA: RADIACIÓN LÁSER INVISIBLE AL SER ABIERTO. EVITE EXPONERSE A LOS RAYOS.

ADVARSEL: LASERSTRÅLING VED ÅBNING SE IKKE IND I STRÅLEN.

VARO! LAVATTAESSA OLET ALTTINA LASERSÄTEILYLLE.

WARNING: LASERSTRÅLNING NÅR DENNA DEL ÅR ÖPPNAD ÅLÅ TUIJOTA SÄTEESEENSTIRRA EJ IN I STRÅLEN

WARNING: LASERSTRÅLNING NAR DENNA DEL ÅR ÖPPNADSTIRRA EJ IN I STRÅLEN

ADVARSEL: LASERSTRÅLING NAR DEKSEL ÅPNESSTIRR IKKE INN I STRÅLEN

Federal Communications Commission Declaration of Conformity

This device complies with Part 15 of the FCC Rules. Operation is subject to the following two conditions: (1) This device may not cause harmful interference, and (2) This device must accept any interference received, including interference that may cause undesired operation.

The following local manufacturer/importer is responsible for this declaration:

Product name:	Personal computer
Model:	Veriton 5800/6800/7800
Name of responsible party:	Acer America Corporation
Address of responsible party:	2641 Orchard Parkway San Jose, CA 95134 USA
Contact person:	Mr. Young Kim
Tel:	408-922-2909
Fax:	408-922-2606

Declaration of Conformity for CE marking

Name of manufacturer: Acer Inc.
 Address of manufacturer: 8F, 88, Sec. 1, Hsin Tai Wu Rd.
 Hsichih, Taipei Hsien 221
 Taiwan, ROC
 Declares that product: Personal computer
 Model: Veriton 5800/6800/7800

Conforms to the EMC Directive 89/336/EEC as attested by conformity with the following harmonised standards:

EN55022:1994 /A2: 1997: Limits and Methods of Measurement of Radio Interference characteristics of Information Technology Equipment

EN55024: 1998/A1: 2001: Information technology equipment — Immunity characteristics — Limits and methods of measurement including:

EN61000-4-2: 1995/A1: 1998/A2: 2001	EN61000-4-6: 1996/A1: 2001
EN61000-4-3: 1996/A1: 1998	EN61000-4-8: 1993/A1: 2001
EN61000-4-4: 1995/A2: 2001	EN61000-4-11: 1994/A1: 2001
EN61000-4-5: 1995/A1: 2001	

EN61000-3-2: 2000: Limits for harmonics current emissions

EN61000-3-3: 1995/A1: 2001: Limits for voltage fluctuations and flicker in low-voltage supply systems

Conforms to the Low Voltage Directive 73/23/EEC as attested by conformity with the following harmonised standard:

EN60950: 2000: Safety of Information Technology Equipment Including electrical business equipment. This equipment has been approved to Council Decision 98/482/EC (CTR21) for pan-European single terminal connection to the Public Switched Telephone Network (PSTN).

We, Acer Inc., hereby declare that the equipment bearing the trade name and model number specified above was tested conforming to the applicable Rules under the most accurate measurement standards possible, and that all the necessary steps have been taken and are in force to assure that production units of the same equipment will continue to comply with the requirements.

Easy Lai
 Easy Lai, Director
 Qualification Center
 Product Assurance

03/15/2005
 Date

Appendix B:

Taking care of your computer

Please read the important instructions listed in this section. Following these instructions will help you maximize the durability of your computer.

Important tips

- Do not expose the computer to direct sunlight. Do not place it near sources of heat, such as a radiator.
- Do not expose the computer to temperatures below 0 °C (32 °F), or above 40 °C (104 °F).
- Do not subject the computer to magnetic fields.
- Do not expose the computer to rain or moisture.
- Do not spill water on the computer.
- Do not subject the computer to heavy shock or vibration.
- Do not expose the computer to dust or dirt.
- Never place the system on uneven surfaces.
- Do not step on the power cord or place heavy objects on top of it. Carefully route the power cord and any cables away from foot traffic.
- When unplugging the power cord, do not pull on the cord itself instead pull on the plug.
- The total ampere rating of the equipment plugged in should not exceed the ampere rating of the cord if you are using an extension cord. Also, the total current rating of all equipment plugged into a single wall outlet should not exceed the fuse rating.
- Check the documentation that came with your software programs to see if you can select other combinations of resolution and color. These adjustments could make viewing the screen more comfortable.

Cleaning and servicing

To clean your computer and keyboard

- 1 Turn off the computer and unplug the power cord.
- 2 Use a soft cloth moistened with water and gently wipe the exterior of the computer and the keyboard. Do not use liquid or aerosol cleaners.

To clean your pointing device

To clean a regular mouse (with rubber ball)

- 1 Open the circular cover underneath the mouse.
- 2 Take out the rubber ball and wipe it with a soft, water-moistened cloth.
- 3 Put the ball back and close the cover.

To clean an optical mouse

For users of an optical mouse, refer to the documentation that came with your mouse for maintenance instructions.

To clean your monitor

Make sure that you keep your screen clean. For cleaning instructions, refer to the documentation that came with your monitor.

When to contact a service technician

- If you dropped and damaged the computer.
- If liquid has been spilled onto the computer.
- If the computer is not operating normally.
- If a computer problem persists even after you have checked and done the troubleshooting tips discussed in the **"Frequently asked questions" on page 75.**
- If your problem is not listed in the **"Frequently asked questions" on page 75.**
- If you want to replace or upgrade any of your computer's internal components.

Asking for technical assistance

For technical assistance, contact your local dealer or distributor. You may also access the Web site (www.acersupport.com) for information on how and where to contact the service centers available in your area.

Index

A

- accessing the online User's Guide 15
- applications 65

B

- BIOS utility 69

C

- computer cover
 - remove 51
 - replace 51
- computer maintenance 88
 - cleaning 88
 - servicing 88
- connecting options
 - multimedia devices 43
 - audio line-in device 45
 - earphones/headphones 44
 - external speakers 43
 - microphone 43
 - network 41, 42
 - printer 41
 - serial mouse 42
 - USB devices 45

D

- disk drives
 - CD-ROM/DVD-ROM/CD-RW drive
 - inserting CDs/DVDs 30
 - taking care CDs/DVDs 32
 - hard disk 32

F

- features 19
 - connectivity 19
 - multimedia 19
 - performance 19
- Frequently-asked questions 75
 - blank screen 75
 - no audio 76
 - no sound 76
 - printer not working 76
 - system cannot read disk 76
 - system cannot write to disk 76
 - system did not boot up 75

- front panel 20

I

- internet/suspend key
 - email 26
 - suspend 26
 - web browser 26

K

- keyboard 25

L

- lock keys
 - Caps Lock 27
 - Num Lock 27
 - Scroll Lock 27

M

- mainboard
 - Veriton mainboard 54
- multimedia key
 - forward 26
 - play/pause 26
 - stop 26

N

- NTI 67

P

- PowerDVD 68

R

- rear panel 22
- remove the side panel 52

S

- safety
 - CD-ROM 83
 - FCC notice 78
 - general instructions 80
 - modem notices 79
- setting up computer 35, 37
 - area 35
 - chair 35
 - connecting peripherals
 - external monitor 38
 - power cable 39
 - keyboard 36
 - monitor 36
 - mouse 36

- software 65
 - Norton AntiVirus 66
- system boards 54
 - mainboard 54
- system utilities
 - Acrobat Reader 65
 - Norton AntiVirus 66
 - NTI CD-Maker 67
 - PowerDVD 68
 - reinstalling programs 69

T

- turning off computer 40
 - software shutdown 40
 - suspend mode 40
- turning on computer 40
 - power button 40

U

- upgrade
 - add memory 56
 - install DDR DIMM 57
 - reconfigure computer 58
 - computer 56
 - install an expansion card 59
 - installation precautions
 - post-installation 50
 - open computer
 - reinstall side panel 53
 - replace components
 - memory 56

V

- Veriton mainboard layout 54