

Panasonic®

Model No.
TX-55CR730B
TX-65CR730B

English

Operating Instructions LCD Television



VIERA

For more detailed instructions, please refer to
[eHELP] (Built-in Operating Instructions).

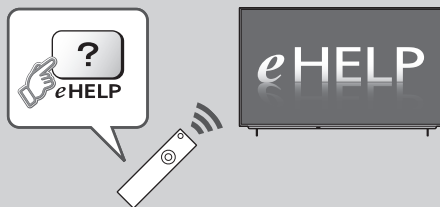

- How to use [eHELP] ➔ (p. 15)

Thank you for purchasing this Panasonic product.

Please read these instructions carefully before operating this product and retain them for future reference.

Please carefully read the "Safety Precautions" of this manual before use.

The images shown in this manual are for illustrative purposes only.



TQB0E2575U



- For information about the trademarks, refer to [eHELP] (Support > Licence).

Contents

Be Sure to Read

Important Notice.....	3
Safety Precautions	3

Quick Start Guide

Accessories	6
Connections	8
Identifying Controls	12
First time Auto Setup	14

Using your VIERA

Watching TV	15
How to Use eHELP	15

Others

FAQs	16
Maintenance	17
Specifications	17

Important Notice

Notice for DVB / Data broadcasting / IPTV functions

This TV is designed to meet the standards (as of August, 2014) of digital services.

- Not all the features are available depending on the country, area, broadcaster, service provider and network environment.
- Compatibility with future services is not guaranteed.
- Check the latest information on the available services at the following website.

<http://panasonic.net/viera/support>

Panasonic does not guarantee operation and performance of peripheral devices made by other manufacturers; and we disclaim any liability or damage arising from operation and/or performance from usage of such other maker's peripheral devices.

The recording and playback of content on this or any other device may require permission from the owner of the copyright or other such rights in that content. Panasonic has no authority to and does not grant you that permission and explicitly disclaims any right, ability or intention to obtain such permission on your behalf. It is your responsibility to ensure that your use of this or any other device complies with applicable copyright legislation in your country. Please refer to that legislation for more information on the relevant laws and regulations involved or contact the owner of the rights in the content you wish to record or playback.

This product is licensed under the AVC patent portfolio license for the personal and non-commercial use of a consumer to (i) encode video in compliance with the AVC Standard ("AVC Video") and/or (ii) decode AVC Video that was encoded by a consumer engaged in a personal and non-commercial activity and/or was obtained from a video provider licensed to provide AVC Video. No license is granted or shall be implied for any other use.

Additional information may be obtained from MPEG LA, LLC.

See <http://www.mpegla.com>.

Transport only in upright position.

Safety Precautions

To help avoid risk of electrical shock, fire, damage or injury, please follow the warnings and cautions below:

■ Mains plug and lead

Warning

If you detect anything unusual, immediately switch off the mains supply switch and remove the mains plug.

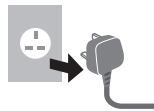

IMPORTANT:

THE MOULDED MAINS PLUG FOR YOUR SAFETY, PLEASE READ THE FOLLOWING TEXT CAREFULLY.

This TV is supplied with a moulded 3-pin mains plug for your safety and convenience.

A 10 amp fuse is fitted in this mains plug. Shall the fuse need to be replaced, please ensure that the replacement fuse has a 10 amp rating and that it is approved by ASTA or BSI to BS1362.

Check for the ASTA mark  or the BSI mark  on the fuse body.

If the mains plug contains a removable fuse cover, you must ensure that it is refitted when the fuse is replaced.

If you lose the fuse cover, the mains plug must not be used until a replacement cover is obtained.

A replacement fuse cover may be purchased from your local dealer.

Do not cut off the mains plug.

Do not use any other type of mains lead except the one supplied with this TV.

The supplied mains lead and moulded plug are designed to be used with this TV to avoid interference and for your safety.

If the mains socket in your home is not suitable, get it changed by a qualified electrician.

If the plug or mains lead becomes damaged, purchase a replacement from an authorised dealer.

How to replace the fuse:

For plug type shown in example 1

Lift out the removable fuse cover with a screwdriver and replace the fuse, then refit it securely into the mains plug.

Example 1



For plug type shown in example 2

Lift open the fuse cover in the mains plug with a screwdriver and replace the fuse, then press the fuse cover down securely.

Example 2

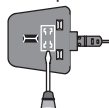

- This TV is designed to operate on AC 220-240 V, 50 / 60 Hz.
- Insert the mains plug fully into the mains socket.
- Ensure that the mains plug is easily accessible.
- Disconnect the mains plug when cleaning the TV.
- Do not touch the mains plug with wet hands.



- Do not damage the mains lead.

- Do not place a heavy object on the lead.



- Do not place the lead near a high temperature object.



- Do not pull on the lead. Hold onto the mains plug body when disconnecting the plug.



- Do not move the TV with the lead plugged into a mains socket.
- Do not twist the lead, bend it excessively or stretch it.
- Do not use a damaged mains plug or mains socket.
- Ensure the TV does not crush the mains lead.
- Do not use any mains lead other than that provided with this TV.

■ Take care

Warning

- Do not remove covers and never modify the TV yourself as live parts are accessible when they are removed. There are no user serviceable parts inside.
- Do not expose the TV to rain or excessive moisture. This TV must not be exposed to dripping or splashing water and objects filled with liquid, such as vases, must not be placed on top of or above the TV.
- Do not insert foreign objects into the TV through the air vents.
- Do not use an unapproved pedestal / mounting equipment. Be sure to ask your local Panasonic dealer to perform the setup or installation of approved wall-hanging brackets.
- Do not apply any strong force or impact to the display panel.
- Ensure that children do not climb on the TV.
- Do not place the TV on sloping or unstable surfaces, and ensure that the TV does not hang over the edge of the base.



- This TV is designed for table-top use.
- Do not expose the TV to direct sunlight and other sources of heat.



To prevent the spread of fire, keep candles or other open flames away from this product at all times



■ Suffocation / Choking Hazard

Warning

- The packaging of this product may cause suffocation, and some of the parts are small and may present a choking hazard to young children. Keep these parts out of reach of young children.
- Do not allow children to handle any small objects such as SD Card. The small object could be swallowed by young children. Remove SD Card immediately after use and store out of reach of young children.



■ Pedestal

Warning

- Do not disassemble or modify the pedestal.

Caution

- Do not use any pedestal other than the one provided with this TV.
- Do not use the pedestal if it becomes warped or physically damaged. If this occurs, contact your nearest Panasonic dealer immediately.
- During setup, make sure that all screws are securely tightened.
- Ensure that the TV does not suffer any impact during installation of the pedestal.
- Ensure that children do not climb onto the pedestal.
- Install or remove the TV from the pedestal with at least two people.
- Install or remove the TV according to the specified procedure.

■ Radio waves

Warning

- Do not use the TV in any medical institutions or locations with medical equipment. Radio waves may interfere with the medical equipment and may cause accidents due to malfunction.
- Do not use the TV near any automatic control equipment such as automatic doors or fire alarms. Radio waves may interfere with the automatic control equipment and may cause accidents due to malfunction.
- Keep at least 15 cm away from the TV if you have a cardiac pacemaker. Radio waves may interfere with the operation of the pacemaker.
- Do not disassemble or alter the TV in any way.

■ Built-in wireless LAN

Caution



- Do not use the built-in wireless LAN to connect to any wireless network (SSID*) for which you do not have usage rights. Such networks may be listed as a result of searches. However, using them may be regarded as illegal access.
*SSID is a name for identifying a particular wireless network for transmission.
- Do not subject the built-in wireless LAN to high temperatures, direct sunlight or moisture.
- Data transmitted and received over radio waves may be intercepted and monitored.
- The built-in wireless LAN uses 2.4 GHz and 5 GHz frequency bands. To avoid malfunctions or slow response caused by radio wave interference when using the built-in wireless LAN, keep the TV away from other devices that use 2.4 GHz and 5 GHz signals such as other wireless LAN devices, microwave ovens, and mobile phones.
- When problems occur due to static electricity, etc., the TV might stop operating to protect itself. In this case, turn the TV off at the Mains power On / Off switch, then turn it back on.
- Additional information for the wireless LAN and access point may be on the following website.
<http://panasonic.net/viera/support>

■ Ventilation

Caution

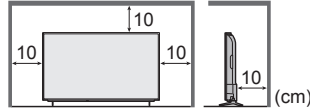
Allow sufficient space (at least 10 cm) around the TV in order to help prevent excessive heat, which could lead to early failure of some electronic components.



- Ventilation should not be impeded by covering the ventilation openings with items such as newspapers, tablecloths and curtains.  
- Whether you are using a pedestal or not, always ensure the vents at the bottom of the TV are not blocked and there is sufficient space to enable adequate ventilation.

■ Moving the TV

Caution

Before moving the TV, disconnect all cables.

- Move the TV with at least two people.

■ When not in use for a long time



Caution

This TV will still consume some power even in the Off mode, as long as the mains plug is still connected to a live mains socket.

- Remove the mains plug from the wall socket when the TV is not in use for a prolonged period of time.

■ Excessive volume

Caution

- Do not expose your ears to excessive volume from the headphones. Irreversible damage can be caused.  
- If you hear a drumming noise in your ears, turn down the volume or temporarily stop using the headphones.

■ Battery for the Remote Control

Caution

- Incorrect installation may cause battery leakage, corrosion and explosion.
- Replace only with the same or equivalent type.
- Do not mix old and new batteries.
- Do not mix different battery types (such as alkaline and manganese batteries).
- Do not use rechargeable batteries (Ni-Cd, etc.).
- Do not burn or break up batteries.
- Do not expose batteries to excessive heat such as sunshine, fire or the like.
- Make sure you dispose of batteries correctly.
- Remove the battery from the unit when not using for a prolonged period of time to prevent battery leakage, corrosion and explosion.



Declaration of Conformity (DoC)

"Hereby, Panasonic Corporation declares that this TV is in compliance with the essential requirements and other relevant provisions of the Directive 1999/5/EC."

If you want to get a copy of the original DoC of this TV, please visit the following website:

<http://www.doc.panasonic.de>

Authorized Representative:

Panasonic Testing Centre

Panasonic Marketing Europe GmbH

Winsbergring 15, D-22525 Hamburg, Germany

This TV is intended to be used in the following countries.

Ireland, United Kingdom

The wireless LAN feature of this TV shall exclusively be used inside buildings.

Accessories

Remote Control

- ➔ (p. 12)
- N2QAYB001010



Pedestal (2)

- ➔ (p. 6)
- R
- L

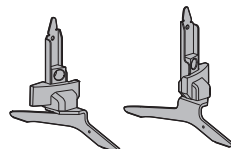

Mains lead

- ➔ (p. 9)

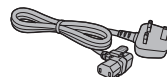

Batteries (2)

- R6
- ➔ (p. 13)



Operating Instructions

Production Registration Leaflet

- Accessories may not be placed all together. Take care not to throw them away unintentionally.
- For information about the optional accessories, refer to [eHELP] (Support > Optional accessories).

Assembling / Removing the pedestal

A Assembly screw (4)



M4 × 12

B Pedestal (R)

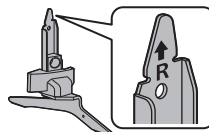

C Pedestal (L)

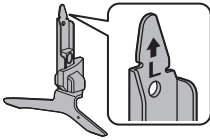

D Screen protective cushion

- This part is beside the TV screen in the packing case.
- Do not dispose this part which is also used for removing pedestal when using the wall-hanging bracket or repacking the TV.

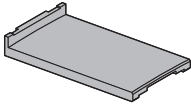

■ Preparations

- 1 Take out the pedestal and the screen protective cushion from the packing case.
- 2 Put the screen protective cushion onto a work table.

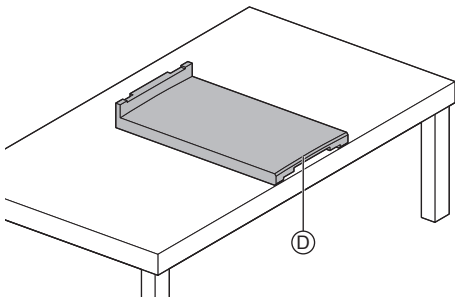

- 3 Put the clean and soft cloth (blanket, etc.) on the screen protective cushion.

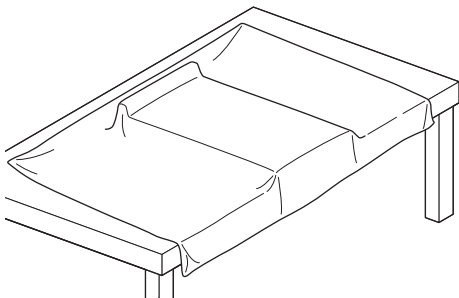

- 4 Take out the TV from the packing case and put the TV onto the work table with the screen panel down.

- Centre the TV screen horizontally on the screen protective cushion.

(View from the side)

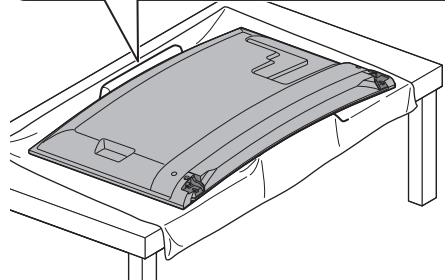
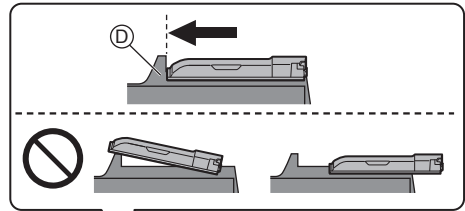

- Use a flat and firm table bigger than the TV.
- Do not hold the screen panel part.
- Make sure not to scratch or break the TV.

■ Assembling the pedestal

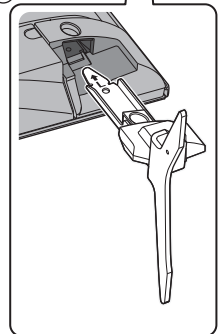
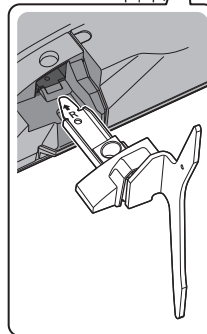
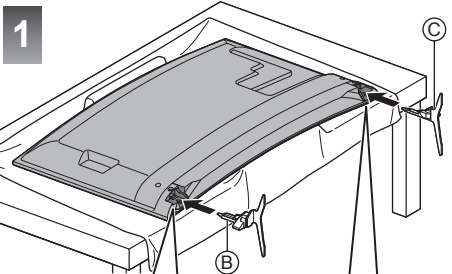

2

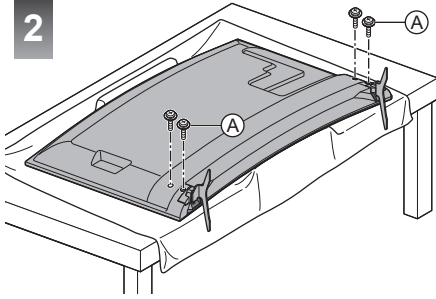

Removing the pedestal from the TV

Be sure to remove the pedestal in the following way when using the wall-hanging bracket or repacking the TV.

- 1 Put the screen protective cushion onto a work table.
- 2 Put the clean and soft cloth on the screen protective cushion.
- 3 Put the TV onto the work table with the screen panel down.
- 4 Remove the assembly screws (A) from the TV.
- 5 Pull out the pedestal from the TV.

Connections

- External equipment and cables shown are not supplied with this TV.
- Please ensure that the unit is disconnected from the mains socket before attaching or disconnecting any cables.
- Check the terminal type and cable plugs are correct for connection.
- Use a fully wired HDMI compliant cable.
- Use a fully wired SCART cable.
- Keep the TV away from electronic equipment (video equipment, etc.) or equipment with an infrared sensor, otherwise distortion of image / sound may occur or operation of other equipment may be affected.
- Please also read the manual of the equipment being connected.

Terminals

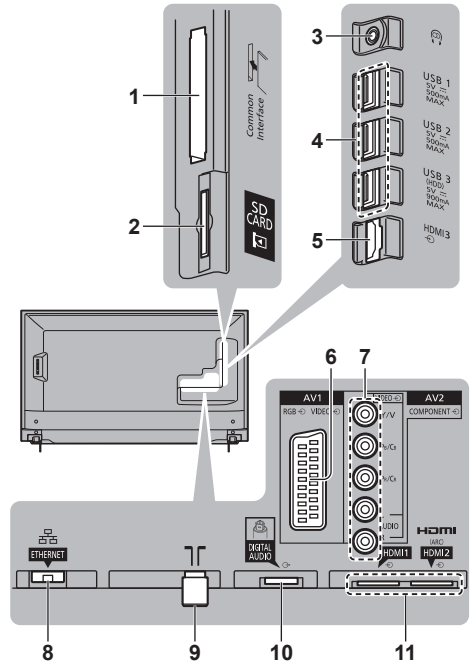

- 1 CI slot ➔ (p. 11)
- 2 SD Card slot
- 3 Headphone jack ➔ (p. 11)
- 4 USB 1 - 3 port
- 5 HDMI3
- 6 AV1 (SCART) ➔ (p. 9)
- 7 AV2 (COMPONENT / VIDEO) ➔ (p. 10)
- 8 ETHERNET ➔ (p. 10)

9 Terrestrial terminal ➔ (p. 9)

10 DIGITAL AUDIO

11 HDMI1 - 2 ➔ (p. 9, 10, 11)

- To watch content in 4K format, use HDMI terminal.
➔ (p. 10)

Basic connections

■ Mains lead

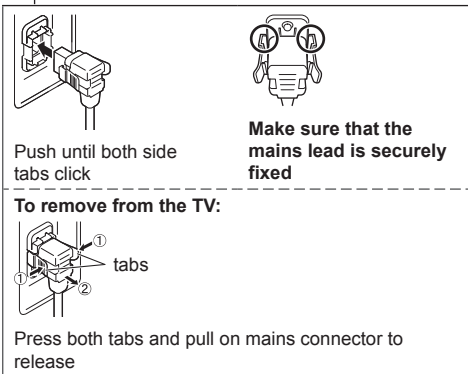
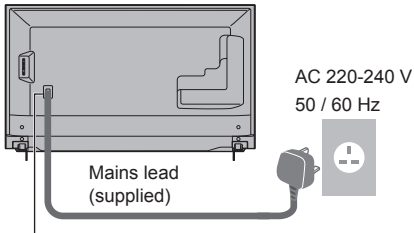

■ Aerial

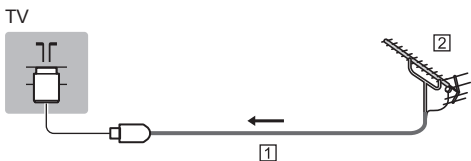

- 1 RF cable
- 2 Terrestrial aerial
 - For DVB, Analogue

AV devices

■ DVD Recorder / VCR

TV

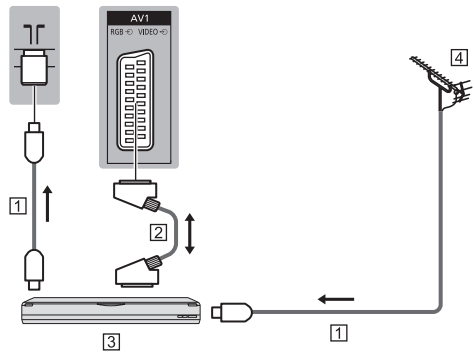

- 1 RF cable
- 2 SCART cable
- 3 DVD Recorder / VCR
- 4 Terrestrial aerial

■ DVD Recorder (VCR) / Satellite receiver

TV

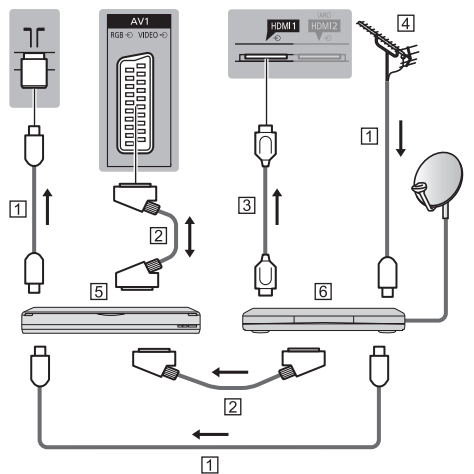

- 1 RF cable
- 2 SCART cable
- 3 HDMI cable
- 4 Terrestrial aerial
- 5 DVD Recorder / VCR
- 6 Satellite receiver

Network

A broadband network environment is required to be able to use internet services.

- If you do not have any broadband network services, please consult your retailer for assistance.
- Prepare the internet environment for wired connection or wireless connection.
- Setup of the network connection will start when first using the TV. ➔ (p. 14)

■ Wired connection

TV

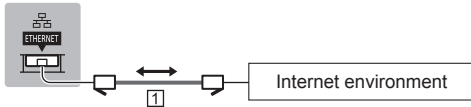

1 LAN cable (Shielded)

- Use Shielded Twist Pair (STP) LAN cable.

■ Wireless connection



1 Built-in wireless LAN

2 Access point

Connections for 4K compatible equipment

TV

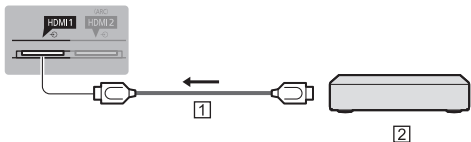

1 HDMI cable

2 4K compatible equipment

- Connect the 4K compatible equipment to HDMI terminal and you can watch contents of 4K format.
- When connecting to HDMI terminal, use a 4K compatible cable.

Other connections

■ DVD Player

(COMPONENT equipment)

TV

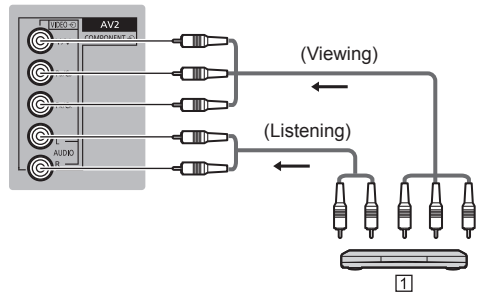

1 DVD Player

■ Camcorder / Game equipment

(VIDEO equipment)

TV

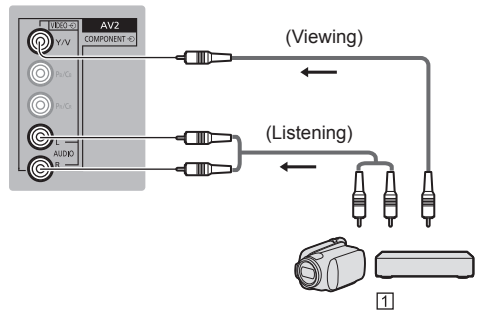

1 Camcorder / Game equipment

■ Amplifier (listening with external speakers)

- Use HDMI2 to connect the TV to an amplifier which has ARC (Audio Return Channel) function.
If connecting to an amplifier without ARC function, use DIGITAL AUDIO.
- To enjoy multi-channel sound from external equipment (e.g. Dolby Digital 5.1ch), connect the equipment to the amplifier. For information about the connections, read the manuals of the equipment and amplifier.

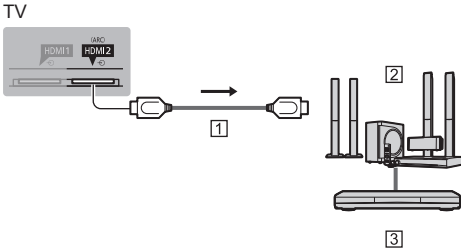

- ① HDMI cable
- ② Amplifier with speaker system
- ③ External equipment (DVD Player, etc.)

■ Headphones

- For information about the volume settings, refer to [eHELP] (Settings > Sound).

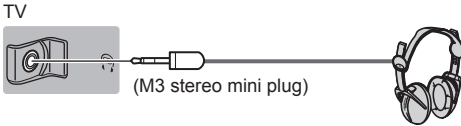

■ Common Interface

- Turn the TV off with Mains Power On / Off switch whenever inserting or removing the CI module.
- If a smart card and a CI module come as a set, first insert the CI module, then insert the smart card into the CI module.
- Insert or remove the CI module completely in the correct direction as shown.
- Normally encrypted channels will appear. (Viewable channels and their features depend on the CI module.)

If encrypted channels do not appear

➔ [Common Interface] in the Setup Menu

- There might be some CI modules in the market with older firmware versions that do not work fully interoperable with this new CI+ v1.3 TV. In this case, please contact your content provider.
- For details, refer to [eHELP] (Functions > Common Interface), read the manual of the CI module, or check with the content provider.

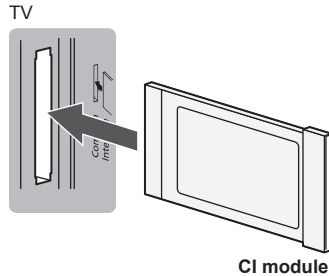

■ USB HDD (for recording)

- Use USB 3 for connecting the USB HDD.
- For details, refer to [eHELP] (Recording).

■ VIERA Link

- Use HDMI1 - 3 for VIERA Link connection.
- For details, refer to [eHELP] (Functions > VIERA Link "HDAVI Control™").

Identifying Controls

Remote Control

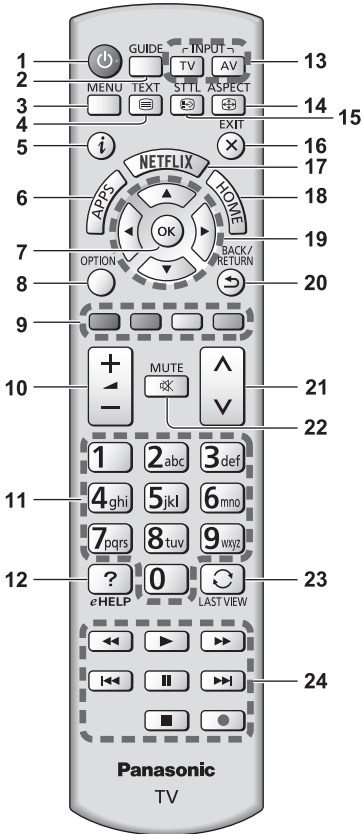

1 Standby On / Off switch

2 TV Guide

- Displays Electronic Programme Guide.

3 [Main Menu]

- Press to access Picture, Sound, Network, Timer, Setup and Help Menus, etc.

4 Text service button

5 Information

- Displays channel and programme information.

6 APPS

- Displays applications list.

7 OK

- Confirms selections and choices.
- Press after selecting channel positions to quickly change channel.

8 [Option Menu]

- Easy optional setting for viewing, sound, etc.

9 Coloured buttons (red-green-yellow-blue)

- Used for the selection, navigation and operation of various functions.

10 Volume Up / Down

11 Numeric buttons

- Changes channel and teletext pages.
- Sets characters.
- When in Standby mode, switches TV on.

12 [eHELP]

- Displays [eHELP] (Built-in Operating Instructions).

13 Input mode selection

- TV - switches to DVB / Analogue mode.
- AV - switches to AV input mode from Input Selection list.

14 Aspect

- Changes aspect ratio.

15 Subtitles

- Displays subtitles.

16 Exit

- Returns to the normal viewing screen.

17 Netflix

- Accesses NETFLIX service directly.
- A broadband network environment is required to be able to use this function fully.
- This service may be stopped or changed without notice.

18 HOME

- Displays Home screen.
- For details, refer to [eHELP] (Read first > Features).

19 Cursor buttons

- Makes selections and adjustments.

20 Return

- Returns to the previous menu / page.

21 Channel Up / Down

22 Sound Mute On / Off

23 Last view

- Switches to previously viewed channel or input mode.

24 Operations for contents, connected equipment, etc.

■ Installing / Removing batteries

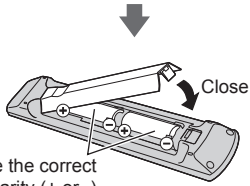
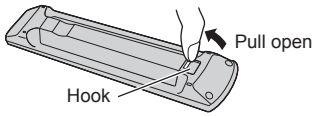

Note the correct polarity (+ or -)

Indicator / Control panel

- When pressing 4, 5, 6 buttons, the control panel guide appears on the right side of the screen for 3 seconds to highlight which button has been pressed.

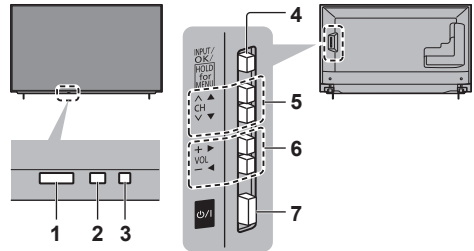

Rear side of the TV

1 Remote control signal receiver

- Do not place any objects between the TV remote control signal receiver and remote control.

2 Ambient sensor

- Senses brightness to adjust picture quality when [Ambient Sensor] in the Picture Menu is set to [On].

3 Power LED

Red: Standby

Green: On

Orange: Standby with some functions (recording, etc.) active

- The LED blinks when the TV receives a command from the remote control.

4 Input mode selection

- Press repeatedly until you reach the desired mode.

[Main Menu]

- Press and hold for about 3 seconds to display main menu.

OK (when in the menu system)

5 Channel Up / Down

- Cursor Up / Down (when in the menu system)

6 Volume Up / Down

- Cursor Left / Right (when in the menu system)

7 Mains power On / Off switch

- Use to switch the mains power.

First time Auto Setup

When the TV is turned on for the first time, it will automatically search for available TV channels and give options to set up the TV.

- These steps are not necessary if the setup has been completed by your local dealer.
- Please complete connections (p. 8 - 11) and settings (if necessary) of the connected equipment before starting Auto Setup. For information about the settings for the connected equipment, read the manual of the equipment.

1 Plug the TV into a live mains socket and turn the power on



- Takes a few seconds to be displayed.

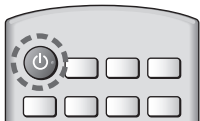

2 Select the following items

Set up each item by following the on-screen instructions.

Example:



■ How to use the remote control



Move the cursor



Access the item / store the setting



Return to the previous item (if available)

Select [Home]

Select [Home] for use in a home viewing environment.

- [Shop] is for shop display.
- To change the viewing environment later on, the set will need to have all settings initialised by accessing Shipping Condition.

Set up the network connection

Select your country

Select your region **UK only**

Auto Setup is now complete and the TV is ready for viewing.

If tuning has failed check the RF cable, and the network connection, and then follow the on-screen instructions.

Note

- The TV goes into Standby mode when no operation is performed for 4 hours if [Auto Standby] in the Timer Menu is set to [On].
- The TV goes into Standby mode when no signal is received and no operation is performed for 10 minutes if [No signal Power off] in the Timer Menu is set to [On].
- To retune all channels
 - ➔ **[Auto Setup] in [Tuning Menu] (Setup Menu)**
- To add the available TV signal mode later
 - ➔ **[Add TV Signal] in [Tuning Menu] (Setup Menu)**
- To initialise all settings
 - ➔ **[Shipping Condition] in [System Menu] (Setup Menu)**

Watching TV

1 Turn power on

⏻/TV (TV)

or

 (Remote Control)

- Mains power On / Off switch should be on. (p. 13)

Displays information bar on the edge of screen for several seconds.

- For information about the operation and settings, refer to [eHELP]. (Read first > Features)

2 Select the mode

TV

- Selectable modes vary depending on the stored channels and selected country.

3 Select a channel

▲ up
▼ down

or

1 2 3
4 5 6
7 8 9
0

- DVB channel position begins from number 1 upward. Analogue channel position numbers are in the 0 - 99 range.

How to Use eHELP

[eHELP] is the detailed operating instructions built into the TV, and gives a more detailed explanation for a better understanding of the operation of each feature.

1 Display [eHELP]

eHELP

or

MENU → [Help] → [eHELP]

- If the [eHELP] has been accessed previously since the TV was turned on, the confirmation screen is displayed to select whether to go to the [First page] or to the [Last viewed page].

2 Select the category and item

Category field
Item field



① select category
② access

③ select item
④ access

Sub item field
Description

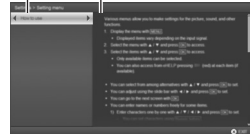

⑤ select sub item
⑥ access

- To return to the previous field



- To scroll the description (if more than 1 page)
While the description is highlighted



- To display the menu related to the description (only for some descriptions)

 (red)

- To check the features of this TV
Read first > Features

FAQs

Before requesting service or assistance, please follow these simple guides to solve the problem.

- For details, refer to [eHELP] (Support > FAQs).

The TV does not switch on

- Check the mains lead is plugged into the TV and the mains socket.
- The fuse in the mains plug may have blown. Replace it with one of an identical rating. ➔ (p. 3)

The TV goes into Standby mode

- Auto power standby function is activated.

The remote control does not work or is intermittent

- Are the batteries installed correctly? ➔ (p. 13)
- Has the TV been switched on?
- The batteries may be running low. Replace them with new ones.
- Point the remote control directly at the TV's remote control signal receiver (within about 7 m and a 30 degree angle of the signal receiver).
- Situate the TV away from sunshine or other sources of bright light so they do not shine on the TV's remote control signal receiver.

No image is displayed

- Check the TV is turned on.
- Check the mains lead is plugged into the TV and the mains socket.
- Check the correct input mode is selected.
- Check the setting of [AV2] ([COMPONENT] / [VIDEO]) in [Input Selection] to match the signal being output by the external equipment.
- Is [Backlight], [Contrast], [Brightness] or [Colour] in the Picture Menu set to the minimum?
- Check all required cables and connections are firmly in place.

An unusual image is displayed

- This TV has a built-in Self Test. Makes a diagnosis of picture or sound problems.
➔ [TV Self Test] (Help Menu)
- Turn the TV off with Mains power On / Off switch, then turn it on again.
- If the problem persists, initialise all settings.
➔ [Shipping Condition] in [System Menu] (Setup Menu)

Parts of the TV become hot

- Parts of the TV may become hot. These temperature rises do not pose any problems in terms of performance or quality.

When pushed with a finger, the display panel moves slightly and makes a noise

- There is a little gap around the panel to prevent damage to the panel. This is not a malfunction.

Check you can get Freeview HD in your area. Text your postcode, followed by your house number or name to **80560***. Or visit **freeview.co.uk**

*e.g. NW96NY1 (Costs no more than a normal text.)

To get the most up to date service from Freeview it is important for Freeview customers to retune from time to time.

How do I re-tune my Freeview TV ?

This is a quick reference. If you have any problems, check the Operating Instructions or ask a friend or family member to show you how. Alternatively, go to your local electrical retailer, contact your local Panasonic dealer or visit **freeview.co.uk/retune**

Re-tuning only takes a few minutes, just follow the steps below:

1. Press the TV button to select DVB mode.
2. Press the MENU button to open the main menu.
3. [Setup] ➔ [DVB Tuning Menu] ➔ [Auto Setup]

Please note: most digital TV recorders will keep your original recordings after running a re-tune but you will need to reset any future recordings.

Maintenance

First, remove the mains plug from the mains socket.

Display panel, Cabinet, Pedestal

Regular care:

Gently wipe the surface of the display panel, cabinet, or pedestal by using a soft cloth to remove dirt or fingerprints.

For stubborn dirt:

- (1) First clean the dust from the surface.
- (2) Dampen a soft cloth with clean water or diluted neutral detergent (1 part detergent to 100 parts water).
- (3) Wring out the cloth firmly. (Please note, do not let liquid enter the TV inside as it may lead to product failure.)
- (4) Carefully wipe moisten and wipe away the stubborn dirt.
- (5) Finally, wipe away all the moisture.

Caution

- Do not use a hard cloth or rub the surface too hard, otherwise this may cause scratches on the surface.
- Take care not to subject the surfaces to insect repellent, solvent, thinner or other volatile substances. This may degrade surface quality or cause peeling of the paint.
- The surface of the display panel is specially treated and may be easily damaged. Take care not to tap or scratch the surface with your fingernail or other hard objects.
- Do not allow the cabinet and pedestal to make contact with a rubber or PVC substance for a long time. This may degrade surface quality.

Mains plug

Wipe the mains plug with a dry cloth at regular intervals. Moisture and dust may cause fire or electrical shock.

Specifications

■ TV

Model No.

55-inch model : TX-55CR730B

65-inch model : TX-65CR730B

Dimensions (W × H × D)

55-inch model

1 236 mm × 772 mm × 248 mm (With Pedestal)

1 236 mm × 727 mm × 124 mm (TV only)

65-inch model

1 454 mm × 906 mm × 355 mm (With Pedestal)

1 454 mm × 850 mm × 143 mm (TV only)

Mass

55-inch model

23.5 kg Net (With Pedestal)

22.5 kg Net (TV only)

65-inch model

32.5 kg Net (With Pedestal)

31.5 kg Net (TV only)

Power source

AC 220-240 V, 50 / 60 Hz

Panel

LED LCD panel

Sound

Speaker output

20 W (10 W + 10 W)

Headphones

M3 (3.5 mm) stereo mini Jack × 1

Connection terminals

AV1 input / output

SCART (Audio/Video in, Audio/Video out, RGB in)

AV2 input (COMPONENT / VIDEO)

VIDEO

RCA PIN Type × 1

1.0 V[p-p] (75 Ω)

AUDIO L - R

RCA PIN Type × 2

0.5 V[rms]

Y

1.0 V[p-p] (including synchronisation)

P_B/C_B, P_R/C_R

±0.35 V[p-p]

HDMI 1 / 2 / 3 input

TYPE A Connectors

HDMI1 / 3: 4K, Content Type, Deep Colour

HDMI2: 4K, Content Type, Audio Return Channel, Deep Colour

- This TV supports "HDAVI Control 5" function.

Card slot

SD Card slot × 1

Common Interface slot (complies with CI Plus) × 1

ETHERNET

RJ45, IEEE802.3 10BASE-T / 100BASE-TX

USB 1 / 2 / 3

USB1 / 2: DC 5 V, Max. 500 mA [Hi-Speed USB (USB 2.0)]

USB3: DC 5 V, Max. 900 mA [SuperSpeed USB (USB 3.0)]

DIGITAL AUDIO output

PCM / Dolby Digital, Fibre optic

Receiving systems / Band name

Check the latest information on the available services at the following website.

<http://panasonic.net/viera/support>

DVB-T / T2

Digital terrestrial services

UK

PAL I

UHF E21 - 68

Ireland

PAL I

VHF A - J

CATV S1 - S20

UHF E21 - E69

CATV S21 - S41 (Hyperband)

PAL 525/60

Playback of NTSC tape from some PAL Video recorders (VCR) or NTSC disc playback from DVD player and recorder

M.NTSC

Playback from M.NTSC Video recorders (VCR)

NTSC (AV input only)

Playback from NTSC Video recorders (VCR)

Aerial input

UK

UHF

Ireland

VHF / UHF

Operating conditions

Temperature

0 °C - 35 °C

Humidity

20 % - 80 % RH (non-condensing)

Built-in wireless LAN

Standard compliance and Frequency range*

IEEE802.11a/n

5.180 GHz - 5.320 GHz, 5.500 GHz - 5.580 GHz, 5.660 GHz - 5.700 GHz

IEEE802.11b/g/n

2.412 GHz - 2.472 GHz

Security

WPA2-PSK (TKIP/AES)

WPA-PSK (TKIP/AES)

WEP (64 bit/128 bit)

*: The frequency and channel differ depending on the country.

Note

- Design and Specifications are subject to change without notice. Mass and Dimensions shown are approximate.
- For information about the power consumption, display resolution, etc., refer to Product fiche.
- For information about the open source software, refer to [eHELP] (Support > Licence).

■ When using the wall-hanging bracket

Please contact your local Panasonic dealer to purchase the recommended wall-hanging bracket.

- Holes for wall-hanging bracket installation
Rear of the TV

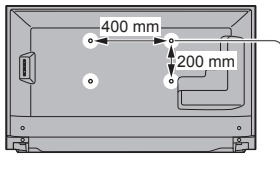

(View from the side)

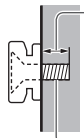

Depth of screw

minimum: 8 mm

maximum: 16 mm

Diameter: M6

Screw for fixing the TV onto the wall-hanging bracket (not supplied with the TV)

Disposal of Old Equipment and Batteries

Only for European Union and countries with recycling systems



These symbols on the products, packaging, and/or accompanying documents mean that used electrical and electronic products and batteries must not be mixed with general household waste.

For proper treatment, recovery and recycling of old products and used batteries, please take them to applicable collection points in accordance with your national legislation.

By disposing of them correctly, you will help to save valuable resources and prevent any potential negative effects on human health and the environment.

For more information about collection and recycling, please contact your local municipality.

Penalties may be applicable for incorrect disposal of this waste, in accordance with national legislation.



Note for the battery symbol (bottom symbol):

This symbol might be used in combination with a chemical symbol. In this case it complies with the requirement set by the Directive for the chemical involved.

Sales and Support Information

Customer Communications Centre

- For customers within the UK: **0344 844 3899**
- For customers within Ireland: **01289 8333**
- Monday – Friday 9:00am – 5:00pm, (Excluding public holidays).
- For further support on your product, please visit our website: www.panasonic.co.uk

Direct Sales at Panasonic UK

- Order accessory and consumable items for your product with ease and confidence by phoning our Customer Communications Centre Monday – Friday 9:00am – 5:00pm, (Excluding public holidays).
- Or go on line through our Internet Accessory ordering application at www.pas-europe.com.
- Most major credit and debit cards accepted.
- All enquiries transactions and distribution facilities are provided directly by Panasonic UK.
- It couldn't be simpler!
- Also available through our Internet is direct shopping for a wide range of finished products. Take a browse on our website for further details.

Customer's Record

The model number and serial number of this product may be found on its rear panel. You should note this serial number in the space provided below and retain this book, plus your purchase receipt, as a permanent record of your purchase to aid in identification in the event of theft or loss, and for Warranty Service purposes.

Model Number

Serial Number

Panasonic UK, a branch of Panasonic Marketing Europe GmbH

Willoughby Road, Bracknell, Berkshire, RG12 8FP

Web Site: <http://www.panasonic.com>

English