



### Product specification (design and specification subject to change without notice)

#### DISPLAY PANEL

Screen Size (Diagonal)	42.5-inch (1080 mm)
Panel type / Backlight	ADS / Direct-LED
Aspect ratio	16:9
Effective Display Area (W x H)	37.1" x 20.9" (941 x 529 mm)
Resolution (H x V)	3840 x 2160
Brightness (Typ)	400 cd/m <sup>2</sup>
Contrast Ratio (Typ)	1200:1
Dynamic Contrast Ratio	50000:1
Max. Display Colors	Approx. 1.06 Billion
Response Time (Typ)	8.0 ms
Viewing Angle (Horizontal / Vertical)	178° / 178° (CR>10)
Panel Life Time* <sup>1</sup> (Typ)	Approx. 50000 hours
Panel Surface Treatment	Anti-glare type (Haze 1%)

\*<sup>1</sup> When the panel lifetime is at 50% of the brightness under the condition of 25 degrees Celsius (+/- 2 degrees Celsius).

\*The LCD panel is made with high-precision technology, but there may be dots that are always lit or dots that are not lit on the display screen. This is not a malfunction, so note that. The percentage of missing dots in this product is 0.00005% or less. (Calculated in sub-pixel units according to ISO09241-307 standards.)

#### CONNECTION TERMINAL

HDMI IN	HDMI Type A Connector x 3 (Compatible with HDCP 2.2)	Linear PCM (Sampling frequency : 48 kHz/44.1 kHz/32 kHz) Compatible with HDCP 2.2
PC IN	Mini D-Sub 15-pin (DDC2B) x 1	RGB : without sync 0.7 V [p-p] (75 Ω) HD/VD : TTL (high impedance)
SERIAL IN	External control terminal D-sub 9pin x 1 (Female), RS-232C Compatible	
AUDIO IN	Stereo Mini Jack (M3) x 1 (PC IN only)	0.5 V [rms]
AUDIO OUT	Pin Jack x 1 Variable (-∞ - 0 dB) (1 kHz 0 dB Input, 10 kΩ Load)	0.5 V [rms]
LAN	RJ45 x 1 RJ45 10BASE-T/100BASE-TX	
USB	USB Type A Connector x 1, DC 5 V/2 A (USB 2.0 is supported)	
RF In (ANTENNA / CABLE)	F connector x1 Standard Modulation Digital : ATSC Analog: NTSC Digital : AIR / 8VSB CABLE / 16QAMor256QAM Analog : Picture / AM Sound / FM	

#### AUDIO

Built in Speaker	20W (10W+10W)
------------------	---------------

#### ELECTRICAL

Power Requirements	AC 110-127 V 60 Hz
Power Consumption	101 W
On Mode Average Power Consumption*	60 W
Power Off Condition	0 W
Stand-by Condition	Approx. 0.5 W
Apparent power	102 W

\*Based on IEC 62087 Ed.2 measurement method

#### MECHANICAL

Dimension (W x H x D) not including handles	38.31" x 22.10" x 2.56" (973 x 562 x 65 mm)
Weight	Approx. 26.1 lbs (11.8 kg)
Bezel Color	Black
Bezel Width	T/R/L/B 0.55" (13.9 mm)
Carton Dimensions (W x H x D)	42.13" x 26.50" x 5.56" (1070 x 673 x 141 mm)
Gross Weight	Approx. 33.1 lbs (15 kg)
Cabinet Material	Front: Metal, Side/Back: Plastic
Pitch for Wall-Hanging	VESA Compliant 7.9" x 7.9" (200 x 200 mm) (Installed by: M6 screws / Screw hole depth: 0.7" (16 mm))

#### INSTALLATION

Orientation	Landscape
Tilting Angle	0 - 20 degrees forward with landscape setting

\*Please contact your sales representative with regard to the tilt angle before installation.

\*When you install the product upright, be sure to make the power lamp of the main body come to the upper side.

#### ENVIRONMENTAL

Operating Environment	Temperature	: 32°F to 104°F (0°C to 40°C) <sup>*1</sup> ; 32°F to 95°F (0°C to 35°C) <sup>*2</sup>
	Humidity	: 20% to 80% (No condensation)
Storage Environment	Temperature	: -4°F to 140°F (-20°C to 60°C)
	Humidity	: 20% to 80% (No condensation)

\*<sup>1</sup> : for up to 4593 ft (1400 m) altitude \*<sup>2</sup> : for between 4593 ft (1400 m) and 9186 ft (2800 m) altitude

• Depending on the temperature or humidity conditions, uneven brightness may be observed. This is not a malfunction.

• This unevenness will disappear while applying current continuously. If not, consult the distributor.

UPC Code	885170385658
----------	--------------

**MAIN FEATURE**

TV tuner (NTSC / ATSC)	Yes
USB Media File Playback Function	Yes
Auto Setup (PC)	Yes
Power Management (HDMI / PC)	Yes
Button lock	Yes
Remote Controller Lock	Yes
Dynamic contrast	Yes
Dynamic backlight control	Yes
Timer setting	Yes
SERIAL control (RS232C)	Yes
LAN control (PLink™)	Yes
HDMI CEC Compatible	Yes
Multi Monitoring & Control Software	Yes
Memory Viewer	Yes
USB Auto-play	Yes
Operating Time*	16h / day

\* In case of running for a long time, the moving image is recommended to be displayed. If you display a still picture for an extended period, the image retention might remain on the screen. However, image retention can gradually disappear by displaying movie images.

**STANDARD (CERTIFICATIONS)**

SAFETY REGULATIONS	ANSI / UL62368-1:2014 CAN / CSA C22.2 No. 62368-1-14
RADIATION REGULATIONS	FCC 47 CFR, Part 15, Subpart B Class B ANSI C63.4-2014 ICES-003
Energy Star	EPA 8.0

**REMOTE CONTROL TRANSMITTER**

Power Requirements	DC 3 V (AAA Size batteries x 2)
Operating distance	Approx. 23 ft (7 m)*
Weight	Approx. 3.2 oz (91 g) including batteries
Dimensions (W x H x D)	1.9" x 1.1" x 7.5" (48 x 27 x 190 mm)

\*When operated directly in front of receptor.

**INCLUDED ACCESSORIES**

- Remote Control
- Batteries (AAA size) x 2
- AC cord (approx. 78.7" (approx. 2 m))
- Clamper x 2
- Operating Instruction Book

**OPTIONAL ACCESSORIES**

Pedestal	TY-ST43PE9
----------	------------

**DIMENSIONS**

Cautions: This drawing is not a scale  
Units : inches (mm)

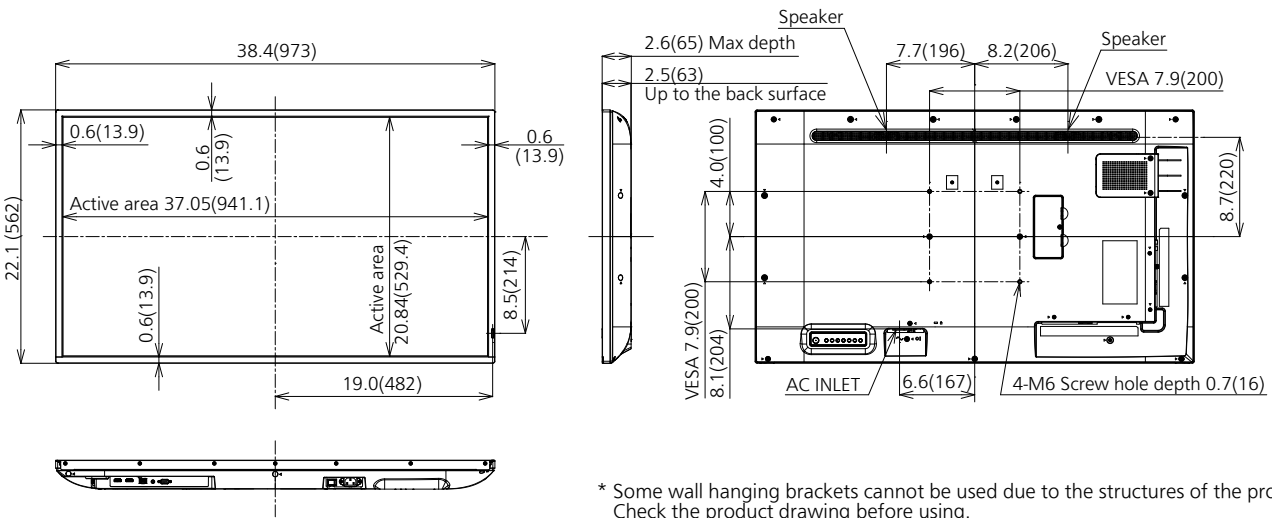

\* Some wall hanging brackets cannot be used due to the structures of the product. Check the product drawing before using.

**CONNECTION TERMINAL**

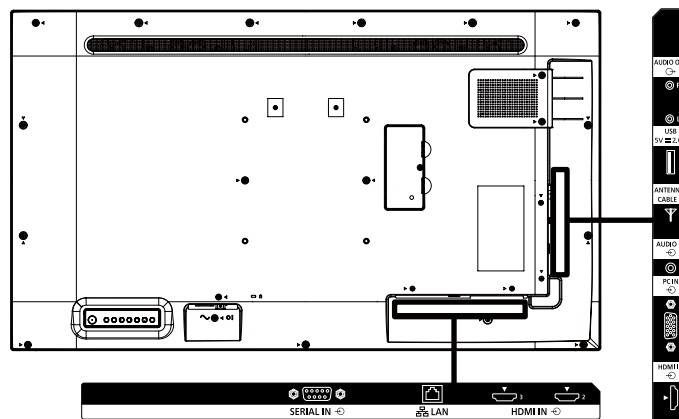

\* Specifications and appearance are subject to change without notice.

## ● List of correspondence signals

### Video Signal

HDMI	
Resolution	Refresh rate (Hz)
640 x 480p	60
720 x 480i	60
720 x 480p	60
720 x 576i	50
720 x 576p	50
1280 x 720p	50
	60
1920 x 1080i	50
	60
1920 x 1080p	24
	25
	30
	50
	60
3840 x 2160p	24
	25
	30
	50
	60
4096 x 2160p	24
	25
	30
	50
60	

### PC Signal

PC / HDMI		✓ : Support - : Not Support	
Resolution	Refresh rate (Hz)	PC	HDMI
640 x 480	60	✓	✓
800 x 600	60	✓	✓
720 x 400	70	✓	✓
1024 x 768	60	✓	✓
1280 x 720	60	✓	✓
1280 x 800	60	✓	✓
1280 x 960	60	✓	✓
1280 x 1024	60	✓	✓
	75	✓	✓
1360 x 768	60	-	✓
1400 x 1050	60	-	✓
1440 x 900	60	✓	✓
1600 x 900	60	✓	✓
1600 x 1200	60	✓	✓
1680 x 1050	60	✓	✓
1920 x 1080	60	✓	✓
1920 x 1200	60	✓	✓
3840 x 2160	30	-	✓
	60	-	✓

● Drawing of terminals

View from back

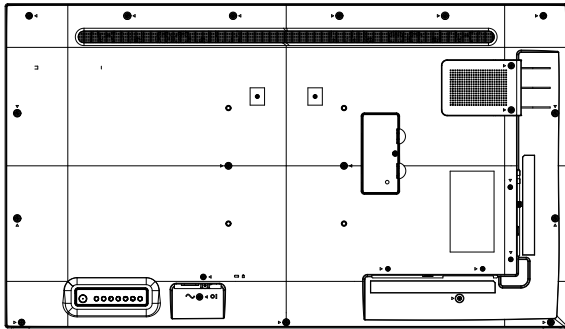

Magnified figure of terminal b

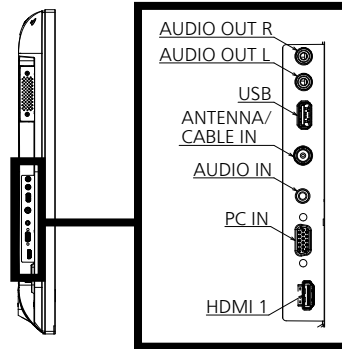

Magnified figure of terminal a

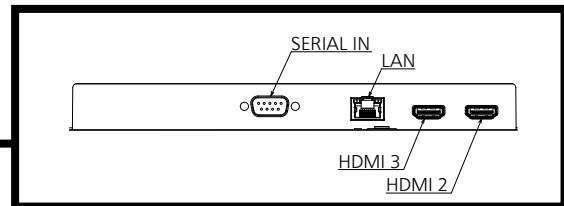
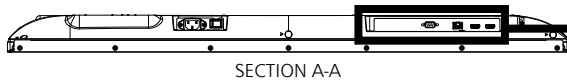

Sectional view of terminal a  
(HDMI 2 / HDMI 3 / LAN / SERIAL IN)

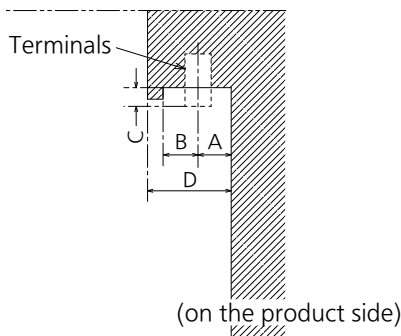

Terminal a  
43CQ2U Terminal (Bottom)

	HDMI	LAN	SERIAL IN
A	0.33 (8.6)	0.39 (10.1)	0.44 (11.4)
B	0.54 (13.9)	0.48 (12.4)	0.43 (11.1)
C	-	-	0.21 (5.2)
D	1.06 (27.0)		

Units : inches (mm)

Sectional view of terminal b  
(AUDIO OUT R / AUDIO OUT L / USB /  
ANTENNA / CABLE IN / AUDIO IN / PC IN / HDMI 1)

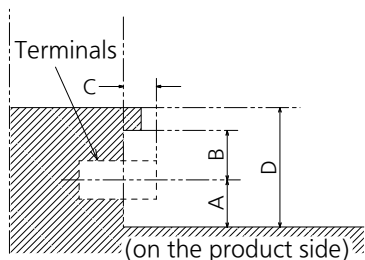

Terminal b  
43CQ2U Terminal (Side)

Units : inches (mm)

	AUDIO OUT	USB	ANTENNA/ CABLE IN	AUDIO IN	PC IN	HDMI
A	0.43 (11.1)	0.42 (10.7)	0.45 (11.5)	0.46 (11.7)	0.44 (11.4)	0.33 (8.6)
B	0.45 (11.5)	0.46 (11.8)	0.43 (11.1)	0.42 (10.9)	0.44 (11.2)	0.54 (13.9)
C	0.20 (5.1)	-	0.44 (11.1)	0.11 (2.7)	0.21 (5.1)	-
D	1.05 (26.7)					

\*Due to the construction of terminal, some types of connecting cable or USB memory device cannot be used.  
Be sure to use connecting cable or USB memory device after confirmation in this drawing.