

# Canon

## TS6400 series

# Getting Started

# Guía de inicio

## Online Setup Configuración en línea

Detailed instructions and videos are available on the Canon website.

Hay vídeos e instrucciones detalladas en el sitio web de Canon.

.....

### Setup a Computer

Configurar un ordenador



<https://ij.start.canon>

### Setup a Smartphone

Configurar un teléfono inteligente



Read **Safety and Important Information** (addendum) first.

Lea primero **Información de seguridad e información importante** (apéndice).



QT63841V01



Installing the Printer.....page 1

Instalación de la impresora .....página 1



Connecting to a Computer, Smartphone or Tablet.....page 4

Conexión con un ordenador, teléfono inteligente o tableta.....página 4

### Holding the Printer

### Cómo sujetar la impresora

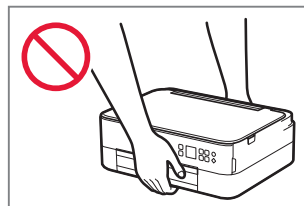
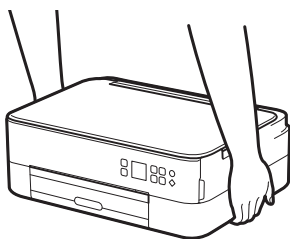

### Instructional Videos

### Vídeos instructivos



3. XXXXXXXXXXXXXXXXXXXX



# Setting Up the Printer

## 1. Box Contents

● FINE Cartridges

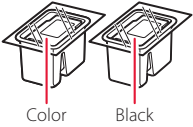

● Power Cord

● Safety and Important Information

● Getting Started (this manual)

## 2. Removing Packing Materials

- 1 Remove and dispose of any packing materials and orange tape.
- 2 Open the scanning unit / cover, remove and dispose of the orange tape and protective material inside.

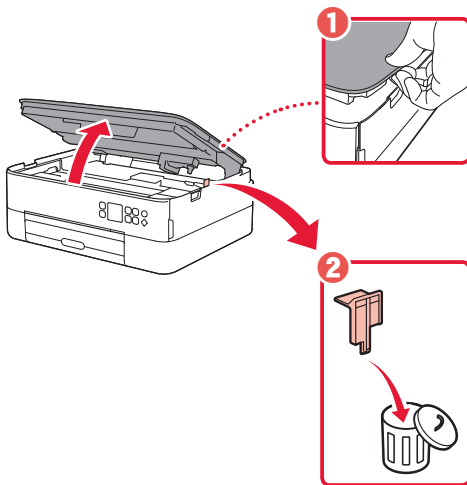

- 3 Close the scanning unit / cover.
  - Open the scanning unit / cover fully and then close it.

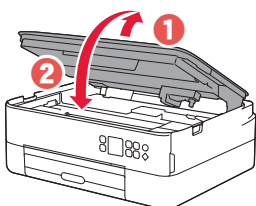

**Caution**  
Watch your fingers.

## 3. Turning on the Printer



- 1 Connect the power cord.

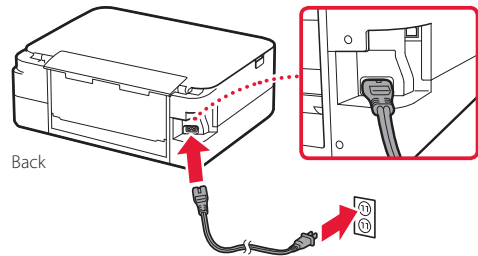

- 2 Press the **ON** button.

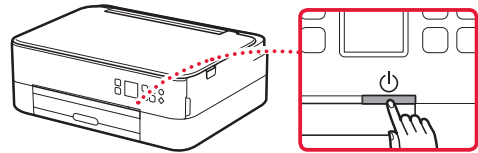

- 3 Use the **▲** and **▼** buttons to select a language, and then press the **OK** button.

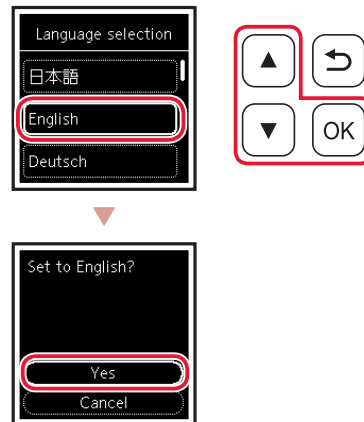

# Setting Up the Printer

## 4. Installing the FINE Cartridges



1 Open the scanning unit / cover.

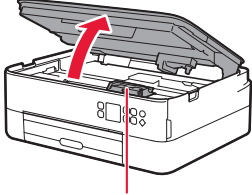

**⚠ Caution**

Do not touch the FINE cartridge holder until it stops moving.

2 Pinch and open the ink cartridge locking cover on the left-hand side.

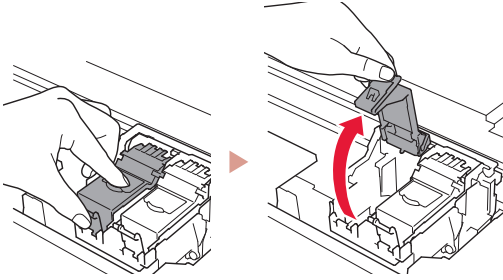

3 Remove the Color FINE cartridge from the container and remove the protective tape.

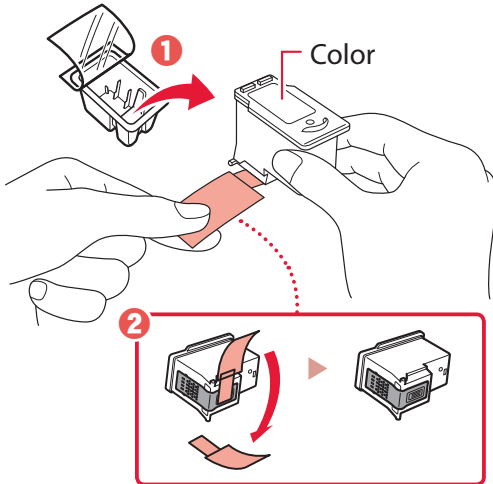

**»»» Important**

- Do not touch the ink on the protective tape. It could stain your hands or surrounding objects.
- Do not touch the areas shown in the figure. Otherwise, the printer may not print correctly.

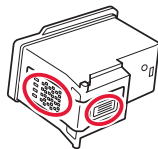

4 Set the Color FINE cartridge in the FINE cartridge holder.

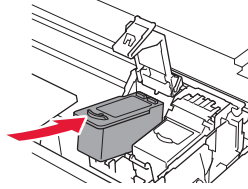

**»»» Important**

Do not bump the FINE cartridge. Doing so may cause a malfunction.

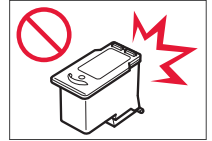

5 Push down the ink cartridge locking cover firmly until it snaps into place to close it completely.

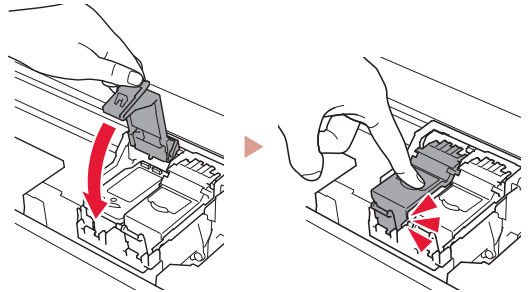

6 Repeat steps 2 to 5 and install the Black FINE cartridge as well, on the right-hand side.

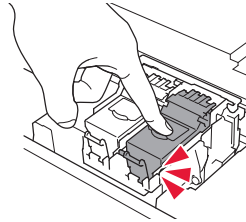

7 Close the scanning unit / cover.

- The printer will start initializing.

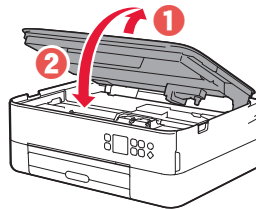

**⚠ Caution**

Watch your fingers.

## 5. Loading Paper



### 1 Press the **OK** button.

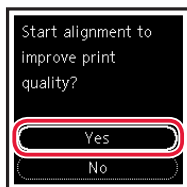

### 2 Remove the cassette from the printer and remove the cassette cover.

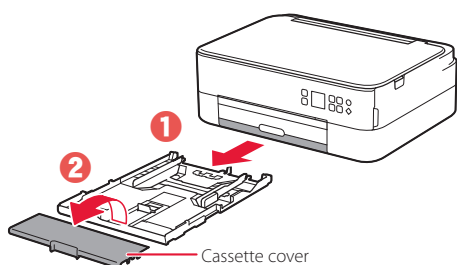

### 3 Slide apart the paper guides.

- Slide the right paper guide to the right edge. Align the front paper guide with the Letter or A4 mark.

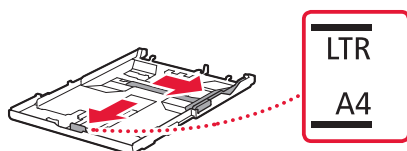

### 4 Load paper.

- Load 2 or more sheets of Letter or A4 sized plain paper.
- Place the paper against the front paper guide, and align the right paper guide to the width of the paper.

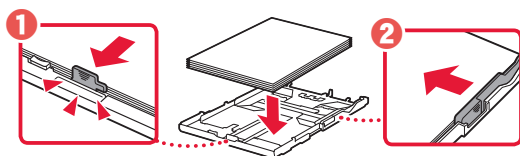

### 5 Attach the cassette cover and replace the cassette.

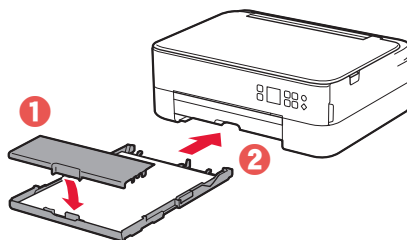

- Look at it from the side to confirm it looks like the diagram.

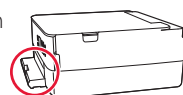

### 6 Pull out the paper output tray.

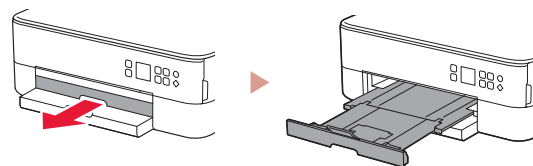

### 7 Press the **OK** button.

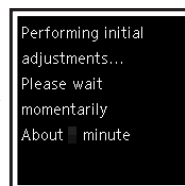
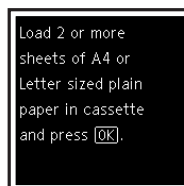

#### ▶▶▶ Note

The alignment process prints out two double sided sheets. Do not pull out the paper or use the printer until alignment is complete.

### 8 Check that the following screen appears.



If you will use the printer without connecting any other devices, setup is now complete.

Select the connection method that best matches how you will use the printer.

- To use the printer without connecting to any other devices
  - ➔ Setup is now complete.
- To use the printer connecting to a computer or smartphone
  - ➔ Proceed to the next page.

## Setting Up the Printer

### What device are you connecting?



Computer



Computer and  
smartphone



Smartphone





## 6-a

### Connecting to a Computer

If you are using multiple computers, perform these steps on each computer.



- 1 Access the Canon website from your computer.  
 <https://ij.start.canon>
- 2 Select  **Set Up**.
- 3 Enter your printer's model name and click **Go**.
- 4 Click **Start**.
- 5 Click **(B) Connecting to a Computer/ Smartphone**.
  - The following steps are for Windows users.

- 6 Click **Download**.
- 7 Run the downloaded file.
- 8 Click **Start Setup**.

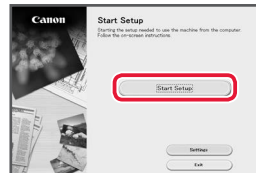

- 9 Follow the on-screen instructions.
  - These operations may take some time.
  - To connect to a smartphone as well, see "6-b. Connecting to a Smartphone" on page 5.

## 6-b Connecting to a Smartphone

If you are using multiple smartphones, perform these steps on each smartphone.



### 1 Install the "Canon PRINT Inkjet/SELPHY" app on your smartphone.



- Search for "Canon PRINT" in App Store, or Google Play.
- Access the Canon website to download the app.



### 2 Open the installed app, and follow the on-screen instructions in the app to add your printer.



---

Once you have added your printer, you can print from your smartphone.

To print photos, see "Loading Photo Paper" on page 6.

---

# Loading Photo Paper

Photo paper can only be loaded in the rear tray.

- 1 Open the rear tray cover and extend the paper support.

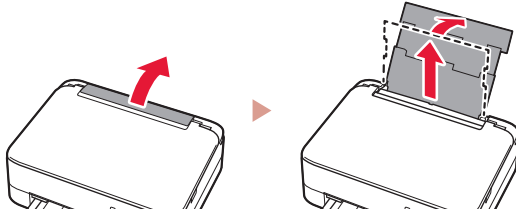

- 2 Open the feed slot cover and slide the right-hand side paper guide to the far right.

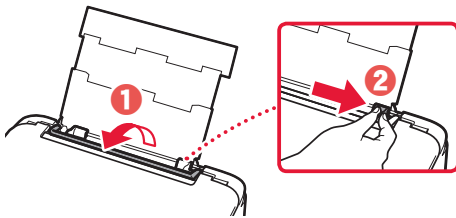

- 3 Load several sheets of photo paper with the print side facing up and slide the side paper guide against the edge of the paper stack.

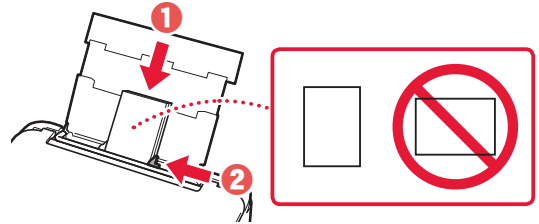

- 4 Close the feed slot cover.
  - Follow the on-screen instructions to set information for the loaded paper.

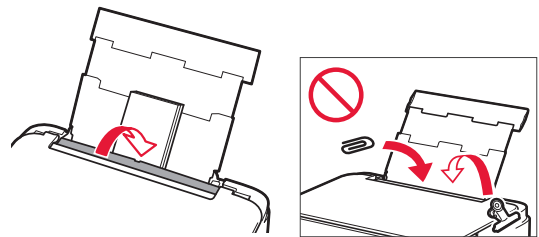

# Copying

- 1 Turn on the printer.
- 2 Load Letter or A4 sized plain paper.
- 3 Open the document cover and place the document face down on the platen. Align the document with the alignment mark (↙).

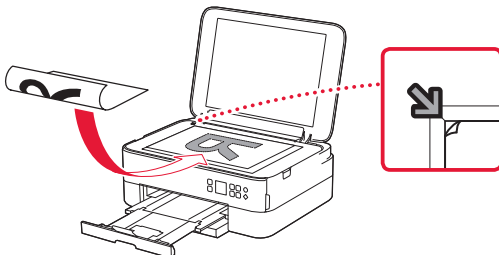

- 4 Close the document cover.
- 5 Press the **OK** button.
- 6 Select **Copy settings**, and then press the **OK** button.
- 7 Specify print settings using the ▲, ▼ and **OK** buttons.



- 8 Press the **Start** button.



# Instalación de la impresora

## 1. Contenido de la caja

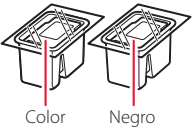
- Cartuchos FINE
  - Cable de alimentación
  - Información de seguridad e información importante
  - Guía de inicio (este manual)
- 
- Color Negro

## 2. Retirar los materiales de protección

- 1 Retire y tire los materiales de protección y la cinta naranja.
- 2 Abra la cubierta/unidad de escaneado, retire y tire la cinta naranja y el material de protección que hay dentro.

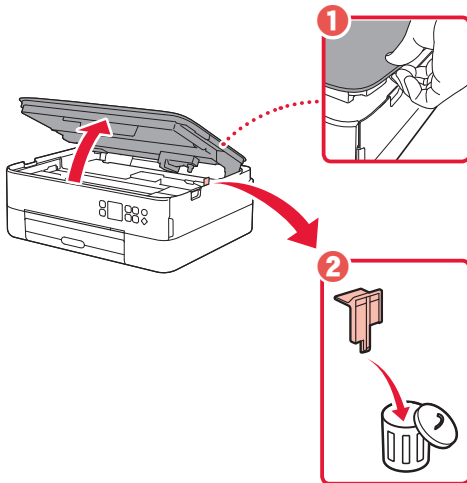

- 3 Cierre la cubierta/unidad de escaneado.
  - Abra la cubierta/unidad de escaneado completamente y luego ciérrala.

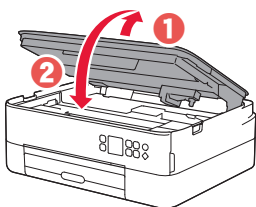

**⚠ Precaución**  
Tenga cuidado con los dedos.

## 3. Encender la impresora



- 1 Conecte el cable de alimentación.

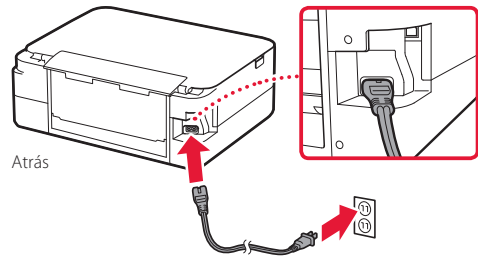

- 2 Pulse el botón **ACTIVADO (ON)**.

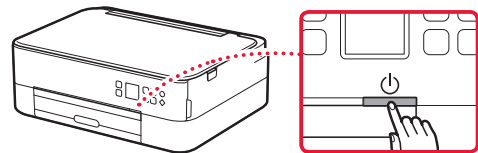

- 3 Utilice los botones ▲ y ▼ para seleccionar un idioma y, a continuación, pulse el botón **OK**.



# Instalación de la impresora

## 4. Instalar los cartuchos FINE



1 Abra la cubierta/unidad de escaneado.

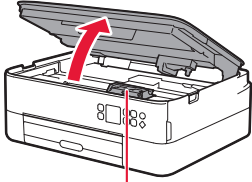

**⚠ Precaución**

No toque el soporte de cartucho FINE hasta que se detenga.

2 Pellizque y abra la tapa de bloqueo del cartucho de tinta del lado izquierdo.

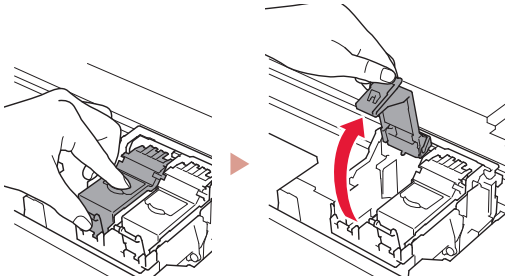

3 Retire el cartucho FINE de color del contenedor y retire la cinta protectora.

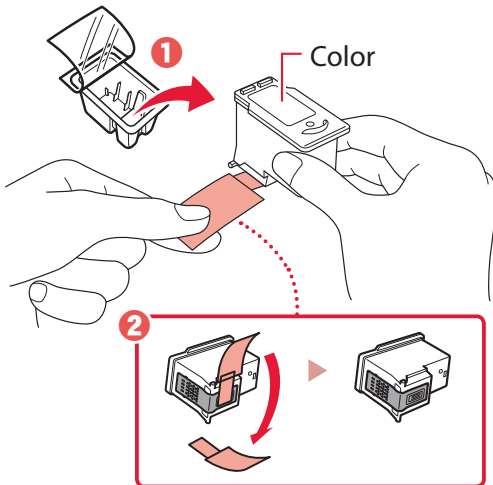

**»»» Importante**

- No toque la tinta de la cinta protectora. Podría manchar sus manos o los objetos que se encuentran a su alrededor.
- No toque las áreas que se muestran en la imagen. Si lo hace, puede que la impresora no imprima correctamente.

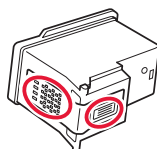

4 Coloque el cartucho FINE de color en el soporte de cartucho FINE.

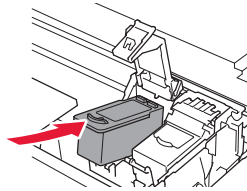

**»»» Importante**

No golpee el cartucho FINE. Si se golpea, puede funcionar mal.

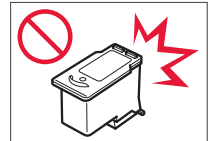

5 Empuje hacia abajo la tapa de bloqueo del cartucho de tinta firmemente hasta que encaje en su lugar para cerrarla por completo.

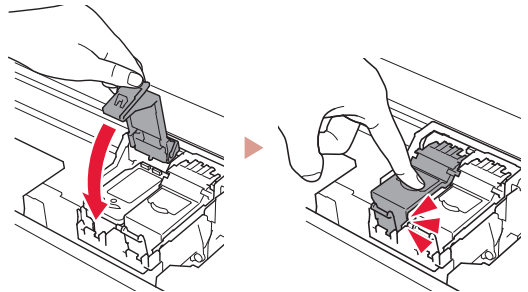

6 Repita los pasos del 2 al 5 e instale el cartucho FINE negro también en el lado derecho.

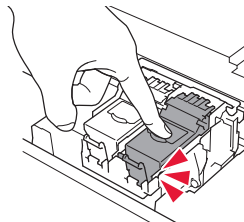

7 Cierre la cubierta/unidad de escaneado.

- La impresora comenzará a iniciarse.

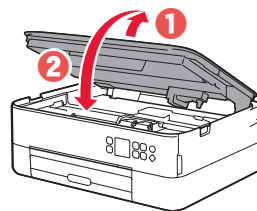

**⚠ Precaución**

Tenga cuidado con los dedos.

## 5. Carga del papel



### 1 Pulse el botón **OK**.

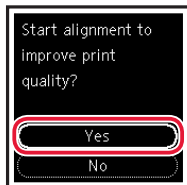

### 2 Retire el cassette de la impresora y retire la cubierta del cassette.

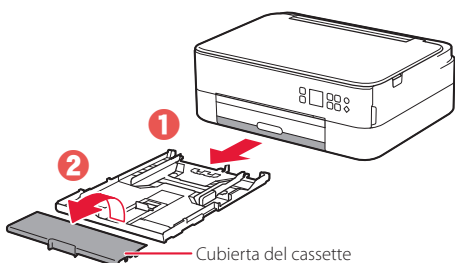

### 3 Separe las guías del papel deslizándolas.

- Deslice la guía del papel derecha hacia el borde derecho. Alinee la guía del papel frontal con la marca Carta o A4.

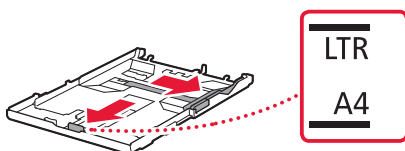

### 4 Cargue el papel.

- Cargue 2 o más hojas de papel Carta o papel normal de tamaño A4.
- Coloque el papel delante de la guía del papel frontal y alinee la guía del papel derecha con el ancho del papel.

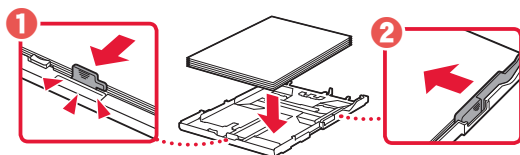

### 5 Coloque la cubierta del cassette e inserte el cassette.

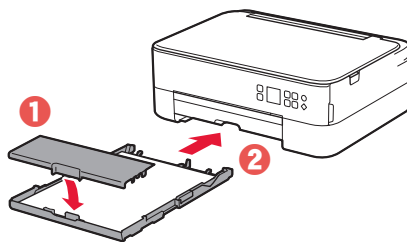

- Mírelo desde el lado para confirmar que está como en el diagrama.

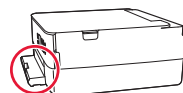

### 6 Extraiga la bandeja de salida del papel.

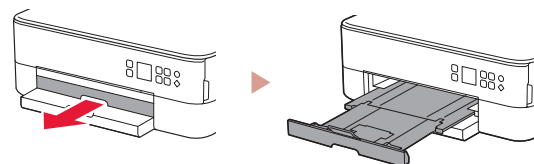

### 7 Pulse el botón **OK**.

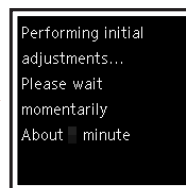
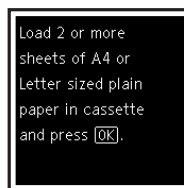

#### »»» Nota

El proceso de alineación imprime dos hojas de doble cara. No extraiga el papel o use la impresora hasta que se haya completado la alineación.

### 8 Compruebe que aparezca la siguiente pantalla.



Si va a utilizar la impresora sin conectar con ningún otro dispositivo, la configuración ya se ha completado.

Seleccione el método de conexión que mejor se adapte al uso de la impresora.

- Para usar la impresora sin conectar con ningún otro dispositivo
  - ➔ Ha finalizado la configuración.
- Para usar la impresora conectándola a un ordenador o un teléfono inteligente
  - ➔ Continúe a la página siguiente.

## ¿Qué dispositivo va a conectar?



Ordenador



Ordenador y  
teléfono inteligente



Teléfono inteligente



### 6-a

## Conectar al ordenador

Si utiliza varios ordenadores, realice estos pasos en cada ordenador.



- 1 Acceda al sitio web de Canon desde el ordenador.

 <https://ij.start.canon>

- 2 Seleccione  **Configurar**.
- 3 Escriba el nombre del modelo de su impresora y haga clic en **Ir**.
- 4 Haga clic en **Iniciar**.
- 5 Haga clic en **(B) Conexión con un ordenador/teléfono inteligente**.
  - Los siguientes pasos son para usuarios de Windows.

- 6 Haga clic en **Descargar**.

- 7 Ejecute el archivo descargado.

- 8 Haga clic en **Iniciar configuración (Start Setup)**.

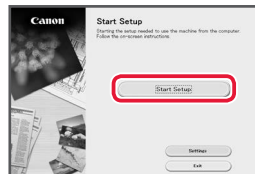

- 9 Siga las instrucciones que aparezcan en pantalla.

- Estas operaciones pueden llevar algún tiempo.
- Para conectar con un teléfono inteligente también, consulte "6-b. Conexión con un teléfono inteligente" en la página 5.

## 6-b

### Conexión con un teléfono inteligente

Si utiliza varios teléfonos inteligentes, realice estos pasos en cada teléfono inteligente.



- 1 Instale la aplicación "Canon PRINT Inkjet/SELPHY" en su teléfono inteligente.



- Busque "Canon PRINT" en App Store o Google Play.
- Acceda al sitio web Canon para descargar la aplicación.



- 2 Abra la aplicación instalada y luego siga las instrucciones en la aplicación para agregar su impresora.



---

Cuando haya agregado la impresora, podrá imprimir desde su teléfono inteligente.  
Para imprimir fotos, consulte "Carga de papel fotográfico" en la página 6.

---

# Carga de papel fotográfico

El papel fotográfico solo se puede cargar en la bandeja posterior.

- 1 Abra la cubierta de la bandeja posterior y extienda el soporte del papel.

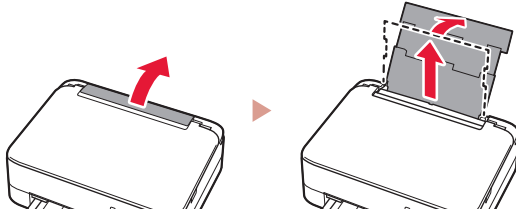

- 2 Abra la cubierta de la ranura de alimentación y deslice la guía del papel del lado derecho totalmente hacia la derecha.

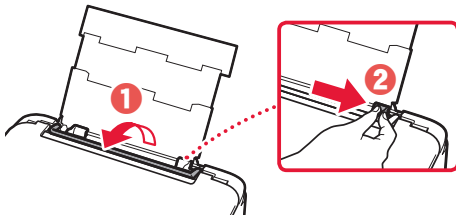

- 3 Cargue varias hojas de papel fotográfico con la cara de impresión hacia arriba y deslice la guía del papel lateral contra el borde de la pila de papel.

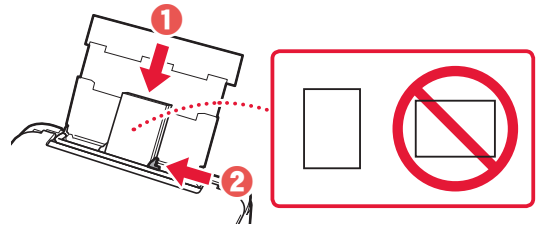

- 4 Cierre la cubierta de la ranura de alimentación.
  - Siga las instrucciones en pantalla para definir la información para el papel cargado.

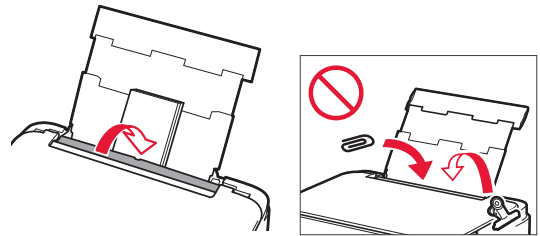

# Copia

- 1 Encienda la impresora.
- 2 Cargue papel Carta o papel normal de tamaño A4.
- 3 Abra la cubierta de documentos y coloque el documento cara abajo en la platina. Alinee el documento con la marca de alineación (↘).

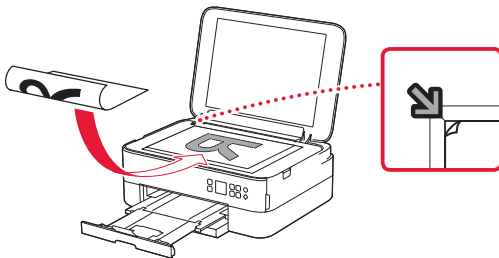

- 4 Cierre la cubierta de documentos.
- 5 Pulse el botón **OK**.
- 6 Seleccione **Configuración de copias (Copy settings)** y, a continuación, pulse el botón **OK**.
- 7 Especifique la configuración de impresión utilizando los botones ▲, ▼ y **OK**.



- 8 Pulse el botón **Iniciar (Start)**.

**How-To Video Library**

**Videoteca sobre procedimientos**

**[www.usa.canon.com/howto/printer](http://www.usa.canon.com/howto/printer)**

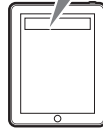



Access Online Manual

Acceso al Manual en línea

From your browser

Desde su navegador



<https://ij.start.canon>

