

**ASUS®**

**VU279HFI Series**

**LCD Monitor**

*User Guide*

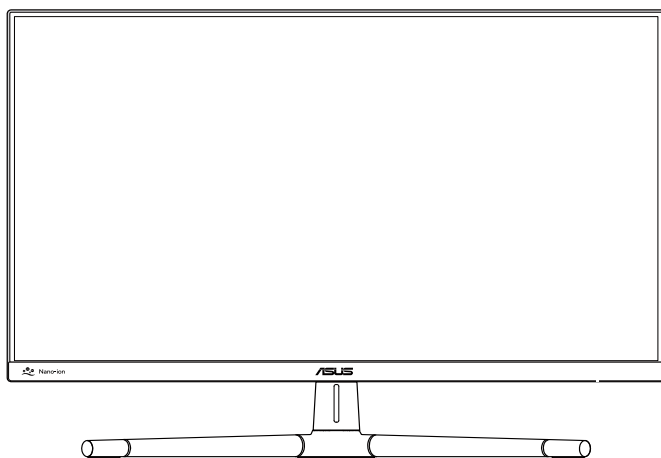

**HDMI™**  
HIGH-DEFINITION MULTIMEDIA INTERFACE

First Edition

September 2024

**Copyright © 2024 ASUSTeK COMPUTER INC. All Rights Reserved.**

No part of this manual, including the products and software described in it, may be reproduced, transmitted, transcribed, stored in a retrieval system, or translated into any language in any form or by any means, except documentation kept by the purchaser for backup purposes, without the express written permission of ASUSTeK COMPUTER INC. ("ASUS").

Product warranty or service will not be extended if: (1) the product is repaired, modified or altered, unless such repair, modification or alteration is authorized in writing by ASUS; or (2) the serial number of the product is defaced or missing.

ASUS PROVIDES THIS MANUAL "AS IS" WITHOUT WARRANTY OF ANY KIND, EITHER EXPRESS OR IMPLIED, INCLUDING BUT NOT LIMITED TO THE IMPLIED WARRANTIES OR CONDITIONS OF MERCHANTABILITY OR FITNESS FOR A PARTICULAR PURPOSE. IN NO EVENT SHALL ASUS, ITS DIRECTORS, OFFICERS, EMPLOYEES OR AGENTS BE LIABLE FOR ANY INDIRECT, SPECIAL, INCIDENTAL, OR CONSEQUENTIAL DAMAGES (INCLUDING DAMAGES FOR LOSS OF PROFITS, LOSS OF BUSINESS, LOSS OF USE OR DATA, INTERRUPTION OF BUSINESS AND THE LIKE), EVEN IF ASUS HAS BEEN ADVISED OF THE POSSIBILITY OF SUCH DAMAGES ARISING FROM ANY DEFECT OR ERROR IN THIS MANUAL OR PRODUCT.

SPECIFICATIONS AND INFORMATION CONTAINED IN THIS MANUAL ARE FURNISHED FOR INFORMATIONAL USE ONLY, AND ARE SUBJECT TO CHANGE AT ANY TIME WITHOUT NOTICE, AND SHOULD NOT BE CONSTRUED AS A COMMITMENT BY ASUS. ASUS ASSUMES NO RESPONSIBILITY OR LIABILITY FOR ANY ERRORS OR INACCURACIES THAT MAY APPEAR IN THIS MANUAL, INCLUDING THE PRODUCTS AND SOFTWARE DESCRIBED IN IT.

Products and corporate names appearing in this manual may or may not be registered trademarks or copyrights of their respective companies, and are used only for identification or explanation and to the owners' benefit, without intent to infringe.

# Contents

Contents .....	iii
Notices.....	iv
TCO certified .....	vi
Safety information .....	vii
Care & Cleaning.....	viii
Takeback Services.....	ix
Product information for EU energy label.....	ix
<b>Chapter 1: Product introduction</b>	
1.1 Welcome! .....	1-1
1.2 Package contents.....	1-1
1.3 Monitor introduction .....	1-2
1.3.1 Front view .....	1-2
1.3.2 Back view.....	1-4
<b>Chapter 2: Setup</b>	
2.1 Assembling the monitor arm/base .....	2-1
2.2 Detaching the arm/base (for VESA wall mount) .....	2-2
2.3 Adjusting the monitor.....	2-3
2.4 Connecting the cables.....	2-4
2.5 Turning on the monitor .....	2-4
<b>Chapter 3: General instructions</b>	
3.1 OSD (On-Screen Display) menu .....	3-1
3.1.1 How to reconfigure.....	3-1
3.1.2 OSD function introduction.....	3-2
3.2 Specifications summary.....	3-10
3.3 Outline dimensions.....	3-12
3.4 Troubleshooting (FAQ).....	3-13
3.5 Supported operating modes .....	3-14

# Notices

## Federal Communications Commission Statement

This device complies with Part 15 of the FCC Rules. Operation is subject to the following two conditions:

- This device may not cause harmful interference, and
- This device must accept any interference received including interference that may cause undesired operation.

This equipment has been tested and found to comply with the limits for a Class B digital device, pursuant to Part 15 of the FCC Rules. These limits are designed to provide reasonable protection against harmful interference in a residential installation. This equipment generates, uses and can radiate radio frequency energy and, if not installed and used in accordance with the instructions, may cause harmful interference to radio communications. However, there is no guarantee that interference will not occur in a particular installation. If this equipment does cause harmful interference to radio or television reception, which can be determined by turning the equipment off and on, the user is encouraged to try to correct the interference by one or more of the following measures:

- Reorient or relocate the receiving antenna.
- Increase the separation between the equipment and receiver.
- Connect the equipment into an outlet on a circuit different from that to which the receiver is connected.
- Consult the dealer or an experienced radio/TV technician for help.



The use of shielded cables for connection of the monitor to the graphics card is required to assure compliance with FCC regulations. Changes or modifications to this unit not expressly approved by the party responsible for compliance could void the user's authority to operate this equipment.

## ENERGY STAR complied product



ENERGY STAR is a joint program of the U.S. Environmental Protection Agency and the U.S. Department of Energy helping us all save money and protect the environment through energy efficient products and practices.

All ASUS products with the ENERGY STAR logo comply with the ENERGY STAR standard, and the power management feature is enabled by default. The monitor and computer are automatically set to sleep after 10 and 30 minutes of user inactivity. To wake your computer, click the mouse or press any key on the keyboard. Please visit <http://www.energystar.gov/powermanagement> for detail information on power management and its benefits to the environment. In addition, please visit <http://www.energystar.gov> for detail information on the ENERGY STAR joint program.



---

NOTE: Energy Star is NOT supported on FreeDOS and Linux-based operating system.

---

## **Canadian Department of Communications Statement**

This digital apparatus does not exceed the Class B limits for radio noise emissions from digital apparatus set out in the Radio Interference Regulations of the Canadian Department of Communications.

This class B digital apparatus complies with Canadian ICES-003.

This Class B digital apparatus meets all requirements of the Canadian Interference - Causing Equipment Regulations.

Cet appareil numérique de la classe B respecte toutes les exigences du Règlement sur le matériel brouiller du Canada.



## **Software Low Blue Light compliance**

ASUS requests every model to pass SW LBL when “Image/ Blue Light Filter” is set to MAX.

Please refer to the following to alleviate eye strains:

- Users should take some time away from the display if working for long hours. It is advised to take short breaks (at least 5 mins) after around 1 hour of continuous working at the computer. Taking short and frequent breaks is more effective than a single longer break.
- To minimize eye strain and dryness in your eyes, users should rest the eye periodically by focusing on objects that are far away.
- Eye exercises can help to reduce eye strain. Repeat these exercises often. If eye strain continues please consult a physician. Eye exercise: (1) Repeating look up and down (2) Slowly roll your eyes (3) Move your eyes diagonal.
- High energy blue light may lead to eye strain and AMD (Age-Related Macular Degeneration). Blue light Filter to reduce 70% (max.) harmful blue light to avoiding CVS (Computer Vision Syndrome).

Blue Light Filter set to MAX. It is in compliance with TÜV Rheinland low blue light Software Solution certification.

## **Flicker-Free technology**

The Monitor adopts Flicker-Free technology, which clears the eye visible flicker, brings comfort viewing experience and preventing users suffer from eye strain and fatigue.

# TCO certified

A third-party certification according to ISO 14024



Toward sustainable IT products



## Say hello to a more sustainable product

IT products are associated with a wide range of sustainability risks throughout their life cycle. Human rights violations are common in the factories. Harmful substances are used both in products and their manufacture. Products can often have a short lifespan because of poor ergonomics, low quality and when they are not able to be repaired or upgraded.

**This product is a better choice.** It meets all the criteria in TCO Certified, the world's most comprehensive sustainability certification for IT products. Thank you for making a responsible product choice, that help drive progress towards a more sustainable future!

Criteria in TCO Certified have a life-cycle perspective and balance environmental and social responsibility. Conformity is verified by independent and approved verifiers that specialize in IT products, social responsibility or other sustainability issues. Verification is done both before and after the certificate is issued, covering the entire validity period. The process also includes ensuring that corrective actions are implemented in all cases of factory non-conformities. And last but not least, to make sure that the certification and independent verification is accurate, both TCO Certified and the verifiers are reviewed regularly.

### Want to know more?

Read information about TCO Certified, full criteria documents, news and updates at [tcocertified.com](https://www.tcocertified.com). On the website you'll also find our Product Finder, which presents a complete, searchable listing of certified products.

## Safety information

- Before setting up the monitor, carefully read all the documentation that came with the package.
- To prevent fire or shock hazard, never expose the monitor to rain or moisture.
- Never try to open the monitor cabinet. The dangerous high voltages inside the monitor may result in serious physical injury.
- If the power supply is broken, do not try to fix it by yourself. Contact a qualified service technician or your retailer.
- Before using the product, make sure all cables are correctly connected and the power cables are not damaged. If you detect any damage, contact your dealer immediately.
- Slots and openings on the back or top of the cabinet are provided for ventilation. Do not block these slots. Never place this product near or over a radiator or heat source unless proper ventilation is provided.
- The monitor should be operated only from the type of power source indicated on the label. If you are not sure of the type of power supply to your home, consult your dealer or local power company.
- Use the appropriate power plug which complies with your local power standard.
- Do not overload power strips and extension cords. Overloading can result in fire or electric shock.
- Avoid dust, humidity, and temperature extremes. Do not place the monitor in any area where it may become wet. Place the monitor on a stable surface.
- Unplug the unit during a lightning storm or if it will not be used for a long period of time. This will protect the monitor from damage due to power surges.
- Never push objects or spill liquid of any kind into the slots on the monitor cabinet.
- To ensure satisfactory operation, use the monitor only with UL listed computers which have appropriate configured receptacles marked between 100-240V AC.
- By means of a power cord connected to a socket-outlet with earthing connection.
- If you encounter technical problems with the monitor, contact a qualified service technician or your retailer.
- Adjustment of the volume control as well as the equalizer to other settings than the center position may increase the ear-/headphones output voltage and therefore the sound pressure level.



---

This symbol of the crossed out wheeled bin indicates that the product (electrical, electronic equipment, and mercury-containing button cell battery) should not be placed in municipal waste. Please check local regulations for disposal of electronic products.

---

## AEEE yönetmeliğine uygundur

### Care & Cleaning

- Before you lift or reposition your monitor, it is better to disconnect the cables and power cord. Follow the correct lifting techniques when positioning the monitor. When lifting or carrying the monitor, grasp the edges of the monitor. Do not lift the display by the stand or the cord.
- Cleaning. Turn your monitor off and unplug the power cord. Clean the monitor surface with a lint-free, non-abrasive cloth. Stubborn stains may be removed with a cloth dampened with mild cleaner.
- Avoid using a cleaner containing alcohol or acetone. Use a cleaner intended for use with the monitor. Never spray cleaner directly on the screen, as it may drip inside the monitor and cause an electric shock.

### The following symptoms are normal with the monitor:

- You may find slightly uneven brightness on the screen depending on the desktop pattern you use.
- When the same image is displayed for hours, an afterimage of the previous screen may remain after switching the image. The screen will recover slowly or you can turn off the Power Switch for hours.
- When the screen becomes black or flashes, or cannot work anymore, contact your dealer or service center to fix it. Do not repair the screen by yourself!

### Conventions used in this guide



**WARNING:** Information to prevent injury to yourself when trying to complete a task.



**CAUTION:** Information to prevent damage to the components when trying to complete a task.



**IMPORTANT:** Information that you **MUST** follow to complete a task.



**NOTE:** Tips and additional information to aid in completing a task.



## Where to find more information

Refer to the following sources for additional information and for product and software updates.

### 1. **ASUS websites**

The ASUS websites worldwide provide updated information on ASUS hardware and software products. Refer to <http://www.asus.com>

### 2. **Optional documentation**

Your product package may include optional documentation that may have been added by your dealer. These documents are not part of the standard package.

### 3. **About Flicker**

[https://www.asus.com/Microsite/display/eye\\_care\\_technology/](https://www.asus.com/Microsite/display/eye_care_technology/)

## Takeback Services

ASUS recycling and takeback programs come from our commitment to the highest standards for protecting our environment. We believe in providing solutions for our customers to be able to responsibly recycle our products, batteries and other components as well as the packaging materials.

Please go to <http://csr.asus.com/english/Takeback.htm> for detail recycling information in different region.

## Product information for EU energy label



VU279HFI

## 1.1 Welcome!

Thank you for purchasing the ASUS® LCD monitor!

The latest widescreen LCD monitor from ASUS provides a broader, brighter and crystal-clear display, plus a host of features that enhance your viewing experience.

With these features, you can enjoy the convenience and delightful visual experience that the monitor brings to you!

## 1.2 Package contents

Check your package for the following items:

- ✓ LCD monitor
- ✓ Monitor arm
- ✓ Monitor base
- ✓ Quick start guide
- ✓ Warranty card
- ✓ Power cord
- ✓ HDMI cable
- ✓ L-shaped screwdriver (optional)
- ✓ 5 screws



---

If any of the above items is damaged or missing, contact your retailer immediately.

---



---

If you need to replace the power cord or the connection cable(s), please contact ASUS customer service.

---

# 1.3 Monitor introduction

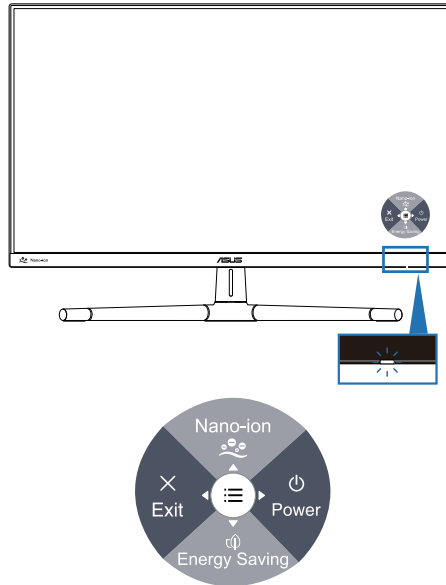

## 1.3.1 Front view



1.  Power (5-way) button/power indicator
  - Turns the monitor on/off.
  - Press the button and move right will shut down the monitor.
  - The color definition of the power indicator is as the below table.

Status	Description
White	On
Amber	Standby mode
Off	Off

2.  Shortcut 1
  - Press the 5-way button to display the OSD menu when the OSD is off.
  - Default: Nano-ion
  - To change the hotkey function, go to the Shortcut > Shortcut 1 menu.

3.  Shortcut 2
  - Press the 5-way button to display the OSD menu when the OSD is off.
  - Default: Energy Saving hotkey
  - To change the hotkey function, go to the Shortcut > Shortcut 2 menu.
4.  Exit (5-way) button:
  - Press this button to display the OSD menu when the OSD is off.
  - Exits the OSD menu.
5.  Menu (5-way) button:
  - Press this button to display the OSD menu when the OSD is off. Press this button again to enter the OSD main menu.
  - Enacts the selected OSD menu items.
  - Increases/Decreases values or moves your selection up/down/left/right.

## 1.3.2 Back view

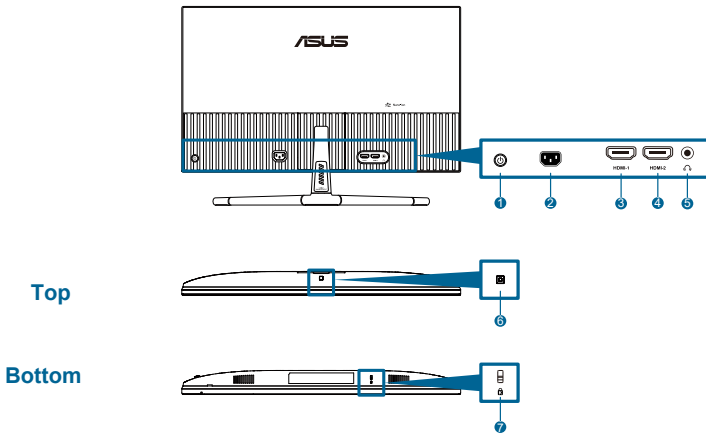

1. **Control (5-ways) button.**
2. **AC-IN port:** This port connects the power cord.
3. **HDMI-1 port:** This port is for connection with an HDMI compatible device.
4. **HDMI-2 port:** This port is for connection with an HDMI compatible device.
5. **Earphone jack:** This port is only available when an HDMI cable is connected.
6. **Ambient Effect Sensor:** Configures the ambient effect settings.
7. **Kensington lock slot.**



## 2.1 Assembling the monitor arm/base

To assemble the monitor base:

1. Have the front of the monitor face down on a table, get the VESA cover lifted.
2. Place the arm hinge of the stand assembly onto its compartment on the rear of the monitor with 4 screws.
3. Attach the base into the arm with screw.
4. Lock the screw, making sure the groove match in line.
5. Assembling the VESA cover.



We recommend that you cover the table surface with soft cloth to prevent damage to the monitor.

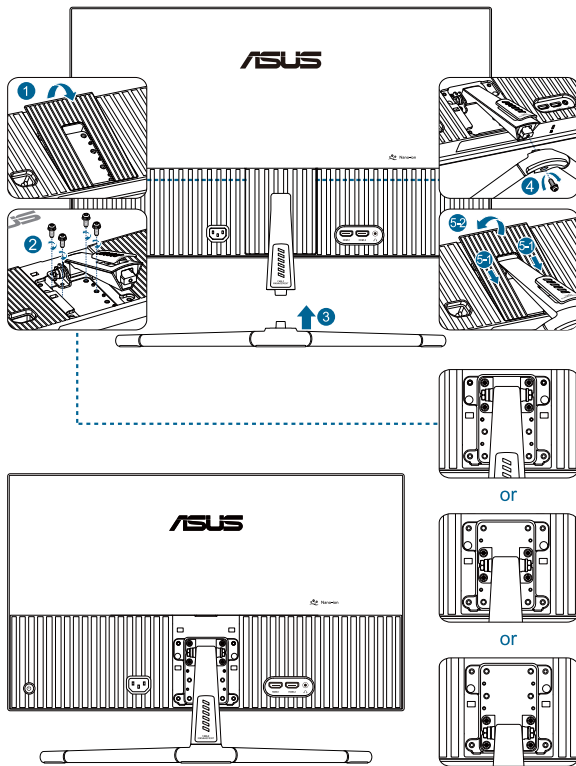

Base screw size: M4 x 12 mm.

## 2.2 Detaching the arm/base (for VESA wall mount)

The detachable arm/base of this monitor is specially designed for VESA wall mount.

To detach the arm/base:

1. Have the front of the monitor face down on a table, get the VESA cover lifted.
2. Use a screwdriver to remove the screw which on the base.
3. Remove the base.
4. Remove the screws on the hinge, then remove the hinge.
5. Assembling the VESA cover.

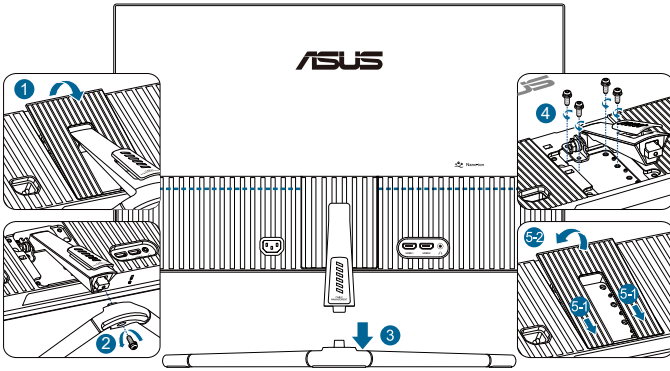

We recommend that you cover the table surface with soft cloth to prevent damage to the monitor.



- The VESA wall mount kit (75 x 75 mm) is purchased separately.
- Use only with UL/CSA/GS Listed Wall Mount Bracket with minimum weight/load bearing capacity of 22.7 kg (50 lb) (Screw size: M4 x 12 mm).



## 2.3 Adjusting the monitor

- For optimal viewing, we recommend that you look at the full face of the monitor, then adjust the monitor to the angle that is most comfortable for you.
- Hold the stand to prevent the monitor from falling when you change its angle.
- The recommended adjusting angle is  $+20^{\circ}$  to  $-5^{\circ}$ .

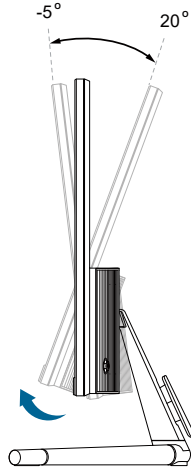

---

It is normal that the monitor slightly shakes while you adjust the viewing angle.

---

## 2.4 Connecting the cables

Connect the cables as the following instructions:

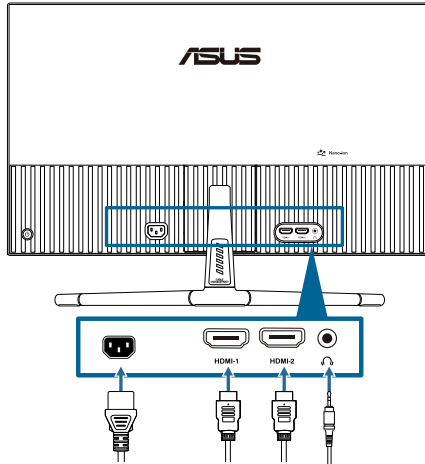

- **To connect the power cord:** Connect one end of the power cord securely to the monitor's AC input port, the other end to a power outlet.
- **To connect the HDMI cable:**
  - a. Plug one end of the HDMI cable to the monitor's HDMI jack.
  - b. Connect the other end of the HDMI cable to your device's HDMI jack.
- **To use the earphone:** connect the end with plug type to the monitor's earphone jack when an HDMI signal is fed.



---

When these cables are connected, you can choose the desired signal from the **Signal** item in the OSD menu.

---





---

If you need to replace the power cord or the connection cable(s), please contact ASUS customer service.

---

## 2.5 Turning on the monitor

Press the power button . See page 1-2 for the location of the power button. The power indicator  lights up in white to show that the monitor is ON.

## 3.1 OSD (On-Screen Display) menu

### 3.1.1 How to reconfigure

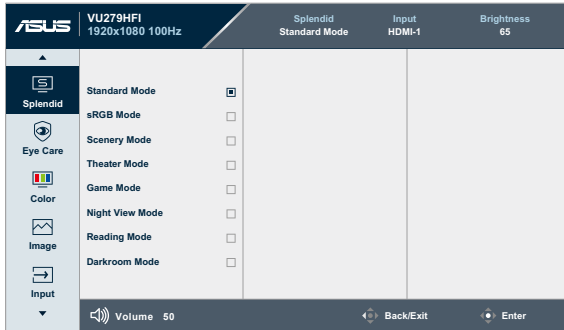

1. Press 5-ways button to display the OSD menu.
2. Press the  Menu button to activate the OSD menu.
3. Press 5-ways button as indicated on the screen to navigate through the functions. Highlight the desired function and press it again to activate it. If the function selected has a sub-menu, move the button up and down to navigate through the sub-menu functions. Highlight the desired sub-menu function and press it to activate it.
4. Move the 5-ways button up and down to change the settings of the selected function.
5. To exit and save the OSD menu, move the 5-ways button left repeatedly until the OSD menu disappears. To adjust other functions, repeat steps 1-4.

### 3.1.2 OSD function introduction

#### 1. Splendid

This function contains 8 sub-functions you can select for your preference. Each mode has the Reset selection, allowing you to maintain your setting or return to the preset mode.

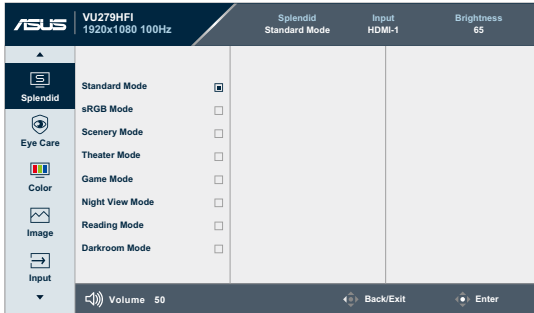

- **Standard Mode:** Best choice for document editing with Splendid Video Enhancement.



---

Standard Mode meets Energy Star<sup>®</sup> requirements.

---

- **sRGB Mode:** Best choice for viewing photos and graphics from PCs.
- **Scenery Mode:** Best choice for scenery photo display with Splendid Video Enhancement.
- **Theater Mode:** Best choice for movies with Splendid Video Enhancement.
- **Game Mode:** Best choice for game playing with Splendid Video Enhancement.
- **Night View Mode:** Best choice for dark-scene games or movies with Splendid Video Enhancement.
- **Reading Mode:** This is the best choice for book reading.
- **Darkroom Mode:** This is the best choice for a weak ambient light environment.



- In the Standard mode, the following function(s) are not user-configurable: Saturation, Sharpness, ASCR.
  - In the sRGB mode, the following function(s) are not user-configurable: Brightness, Contrast, Saturation, Color Temp., Sharpness, ASCR.
  - In the Reading mode, the following function(s) are not user-configurable: Contrast, Saturation, Color Temp., ASCR.
-

## 2. Eye Care

In this function, you can adjust settings to better protect your eyes.

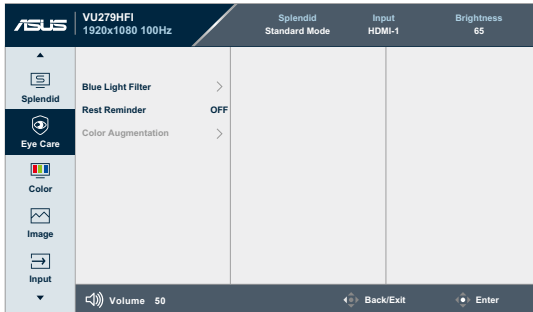

- **Blue Light Filter:** In this function, you can adjust the blue light filter from 0 to Max.
  - \* **0:** No change.
  - \* **Max:** The higher the level, the less blue light is scattered. When blue light filter is activated, the default settings of Standard Mode will be automatically imported. Besides maximum level, the brightness is user-configurable. Maximum is the optimized setting. The brightness function is not user configurable.



---

To activate this function, you need to do the following: turn off Ambient Effect.

---



---

Please refer to the following to alleviate eye strains:

- Users should take some time away from the display if working for long hours. It is advised to take short breaks (at least 5 mins) after around 1 hour of continuous working at the computer. Taking short and frequent breaks is more effective than a single longer break.
  - To minimize eye strain and dryness in your eyes, users should rest the eye periodically by focusing on objects that are far away.
  - Eye exercises can help to reduce eye strain. Repeat these exercises often. If eye strain continues please consult a physician. Eye exercises: (1) Repeating look up and down (2) Slowly roll your eyes (3) Move your eyes diagonal.
  - High energy blue light may lead to eye strain and AMD (Age-Related Macular Degeneration). Blue light filter to reduce 70% (max.) harmful blue light to avoiding CVS (Computer Vision Syndrome) when the user adjusts blue light filter bar to maximum level.
-

- **Rest Reminder:** This function provides you a rest reminder according to how long you set for your working time. For example, if you set a 30-minute working time and there will be a pop up reminder appeared on the upper left corner of the monitor for 5 seconds when time is up. Press any key to make this reminder OSD disappear.



When this function is enabled, the following functions are not available: GamePlus, QuickFit.

- **Color Augmentation:** The adjusting range of color enhancement is from 0 to 100.



This function is not available when sRGB Mode is selected in the Splendid menu.

### 3. Color

Set a desired color setting from this menu.

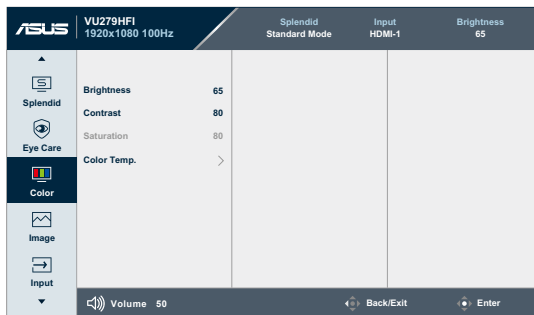

- **Brightness:** The adjusting range is from 0 to 100.



This function is not available when Ambient Effect is enabled.

- **Contrast:** The adjusting range is from 0 to 100.
- **Saturation:** The adjusting range is from 0 to 100.
- **Color Temp.:** Contains 4 modes including **Cool**, **Normal**, **Warm** and **User Mode**.

## 4. Image

Set the image related setting from this menu.

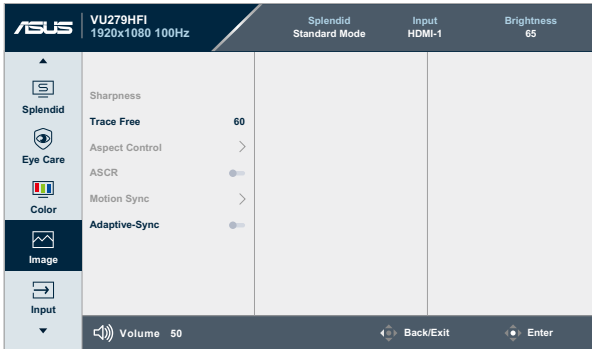

- **Sharpness:** The adjusting range is from 0 to 100.
- **Trace Free:** Adjusts the response time of the monitor.
- **Aspect Control:** Adjusts the aspect ratio to **Full**, or **4:3**.



---

4:3 is only available when input source is in 4:3 format.

---

- **ASCR:** Turns on/off the ASCR (ASUS Smart Contrast Ratio) function.
- **Motion Sync:** Offers a more clear mode while displaying motion pictures. Please note this function only works when the refresh rate is 100Hz. It includes two modes: **Normal Mode** and **Advanced Mode**, which can provide different effects.



- When this function is enabled, the system will automatically reduce the brightness level.
  - If the Adaptive-Sync is enabled, the Motion Sync function is grayed out.
  - To activate this function, you need to do the following: turn off Ambient Effect.
- 

- **Adaptive-Sync:** It can allow a Adaptive-Sync supported graphics source to dynamically adjust display refresh rate based on typical content frame rates for power efficient, virtually stutter free and low-latency display update.



---

This function is not available when Motion Sync is enabled.

---

## 5. Input

In this function, you can select your desired input source.

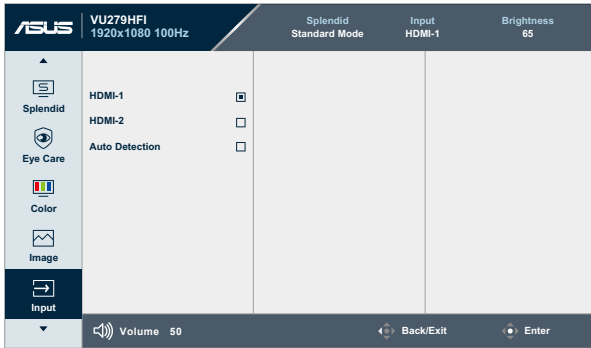

- **Auto Detection:** Automatically detects other active signals when current input signal is inactive.



## 6. Settings

Allows you to adjust the system.

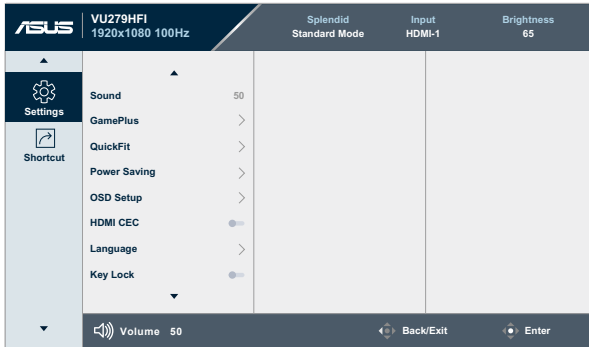

- **Sound:**
  - \* Adjusts **Volume** from 0 to 100.
  - \* **Mute** or **un-Mute** the audio output.
- **GamePlus:** The GamePlus function provides a toolkit and creates a better gaming environment for users when playing different types of games.
  - \* **Corsshair:** The crosshair overlay with different crosshair options lets you choose the one that best suits the game you're playing.
  - \* **Timer:** You can position the timer on the upper left corner of the display so you can keep track of the gaming time.
  - \* **FPS Counter:** The FPS (frames per second) counter lets you know how smooth the game is running.
  - \* **Display Alignment:** Display Alignment displays alignment lines on 4 sides of the screen, serving as an easy and handy tool for you to line up multiple monitors perfectly.

- **QuickFit:** You can have a preview of the document or photo layout directly on screen without printing test copies.
  - \* **Paper size:** You can view the documents in real size on the screen.

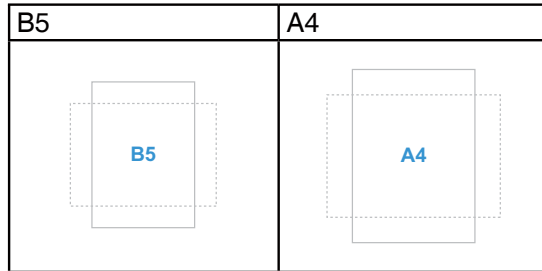

- \* **Photo:** The various real photo sizes displayed provides photographers and other users to accurately view and edit their photos in real size on the screen.

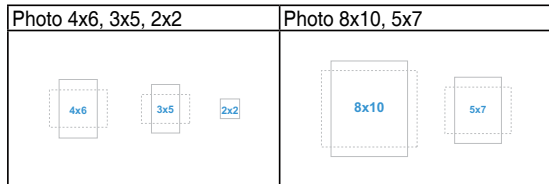

- **Power Saving:** Reduces power consumption. The default setting is “**Deep Level**”. When “**Deep Level**” is selected, the maximum brightness value is fixed and Splendid mode is fixed at “**Standard Mode**”.
- **OSD Setup:**
  - \* Adjusts the OSD timeout from 10 to 120 seconds.
  - \* Enables or disables the DDC/CI function.
  - \* Adjusts the OSD background from opaque to transparent.
- **HDMI CEC: To enable CEC function.**
  - \* If HDMI™ CEC is set to ON: The monitor will automatically power on/off when the Intel NUC is turned on/off.
  - \* Notes: The function can support Intel NUC, ASUS NUC.
- **Language:** There are 23 languages for your selection, including English, French, German, Italian, Spanish, Dutch, Portuguese, Russian, Czech, Croatian, Polish, Romanian, Hungarian, Turkish, Simplified Chinese, Traditional Chinese, Japanese, Korean, Thai, Indonesian, Persian, Ukrainian, Vietnamese.

- **Key Lock:** To disable all function keys. Push the 5-way button down for over 5 seconds to cancel the key lock function.
- **Information:** Shows the monitor information.
- **Power Indicator:** Turns the power LED indicator on/off.
- **Ambient Effect:** Synchronizes display brightness with ambient light changes.



- To activate this function, you need to do the following: turn off Motion Sync and set Blue Light filter to Level 0.
- This function is not available when Ambient Effect Sensor is covered.

- **Nano-ion:** To enable Nano-ion function.
  - \* If Nano-ion is set to ON\_ECO or ON: The Nano-ion function will be enabled. The definition of Nano-ion for the power indicator is as the below table.

Description	With Signal	Without Signal
ON_ECO	Nano-ion: ON Power Indicator: White Flashing	Nano-ion: OFF Power Indicator: Amber
On	Nano-ion: ON Power Indicator: White Flashing	Nano-ion: ON Power Indicator: Amber Flashing

- **All Reset:** “Yes” allows you to restore the default settings.

## 7. Shortcut

Defines the functions for Shortcut 1 and 2 buttons.

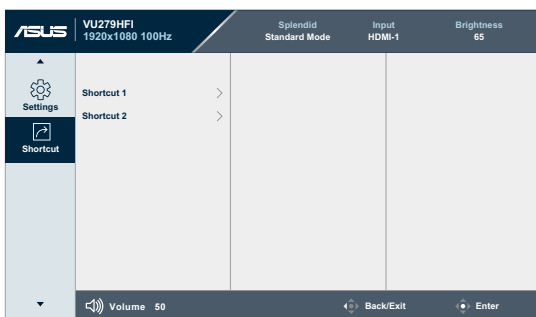

- **Shortcut 1/Shortcut 2:** Selects a function for Shortcut 1 and 2 buttons.



When a certain function is selected or activated, your shortcut key may not support. Available function choices for shortcut: Blue Light Filter, Splendid, Brightness, Contrast, Input Select, Color Temp., Volume, QuickFit, GamePlus, Rest Reminder, Color Augmentation, Energy Saving, Nano-ion.

## 3.2 Specifications summary

<b>Panel Type</b>	TFT LCD
<b>Panel size</b>	27" (16:9, 68.60 cm) wide screen
<b>Max. Resolution</b>	1920 x 1080
<b>Pixel pitch</b>	0.3114 mm x 0.3114 mm
<b>Brightness (Typ.)</b>	250 cd/m <sup>2</sup>
<b>Contrast Ratio (Typ.)</b>	1300:1
<b>Viewing angle (H/V) CR&gt;10</b>	178°/178°
<b>Display colors</b>	16.7 M (RGB 6 bits + Hi-FRC)
<b>Response time</b>	5 ms (GTG)/1 ms (MPRT)
<b>Color temperature selection</b>	4 color temperatures
<b>Digital input</b>	HDMI v1.4 x 2
<b>Digital Output</b>	No
<b>Earphone jack</b>	Yes
<b>Audio input</b>	No
<b>Speaker (Built-in)</b>	No
<b>Power LED</b>	White (On)/Amber (Standby)
<b>Tilt</b>	+20° ~ -5°
<b>VESA wall mount</b>	75 x 75 mm
<b>Kensington lock</b>	Yes
<b>AC input voltage</b>	AC: 100~240V
<b>Power consumption</b>	Power On: 10.28 W**, Standby: ≤ 0.5 W, Power Off: 0.3 W
<b>Temperature (Operating)</b>	0°C~40°C
<b>Temperature (Non-operating)</b>	-20°C~+60°C
<b>Dimension (W x H x D) without stand</b>	611.3 mm x 363.7 mm x 46.5 mm
<b>Dimension (W x H x D) with stand</b>	611.3 mm x 484.5 mm x 202.5 mm (highest) 611.3 mm x 459.5 mm x 202.5 mm (middle) 611.3 mm x 434.5 mm x 202.5 mm (lowest) 690 mm x 138 mm x 431 mm (package)
<b>Weight (Esti.)</b>	4.7 kg (Net); 4.2 kg (Net, without stand); 7.4 kg (Gross)
<b>Multi-languages</b>	23 languages (English, French, German, Italian, Spanish, Dutch, Portuguese, Russian, Czech, Croatian, Polish, Romanian, Hungarian, Turkish, Simplified Chinese, Traditional Chinese, Japanese, Korean, Thai, Indonesian, Persian, Ukrainian, Vietnamese)
<b>Accessories</b>	Quick start guide, warranty card, power cord, HDMI cable, L-shaped screwdriver (optional), 5 screws

## Compliance and Standards

cTUVus, FCC, ICES-3, EPEAT Gold, CB, CE, ErP, WEEE, EU Energy, ISO 9241-307, UkrSEPRO, Ukraine Energy, CU, CCC, CEL, BSMI, RCM, ANZ MEPS, VCCI, PSE, PSB, PC Recycle, J-MOSS, KC, KCC, KMEPS, Energy Star®, TCO, RoHs, CEC, Windows 10/11 WHQL, TÜV Flicker Free, TÜV Low Blue Light, Vietnam MEPS

**\*Specifications are subject to change without notice.**

**\*\*Power consumption of On Mode as defined in Energy Star 8.0 version.**

### 3.3 Outline dimensions

ASUS VU279HF Outline Dimension  
 \*Unit: mm(1/16in)

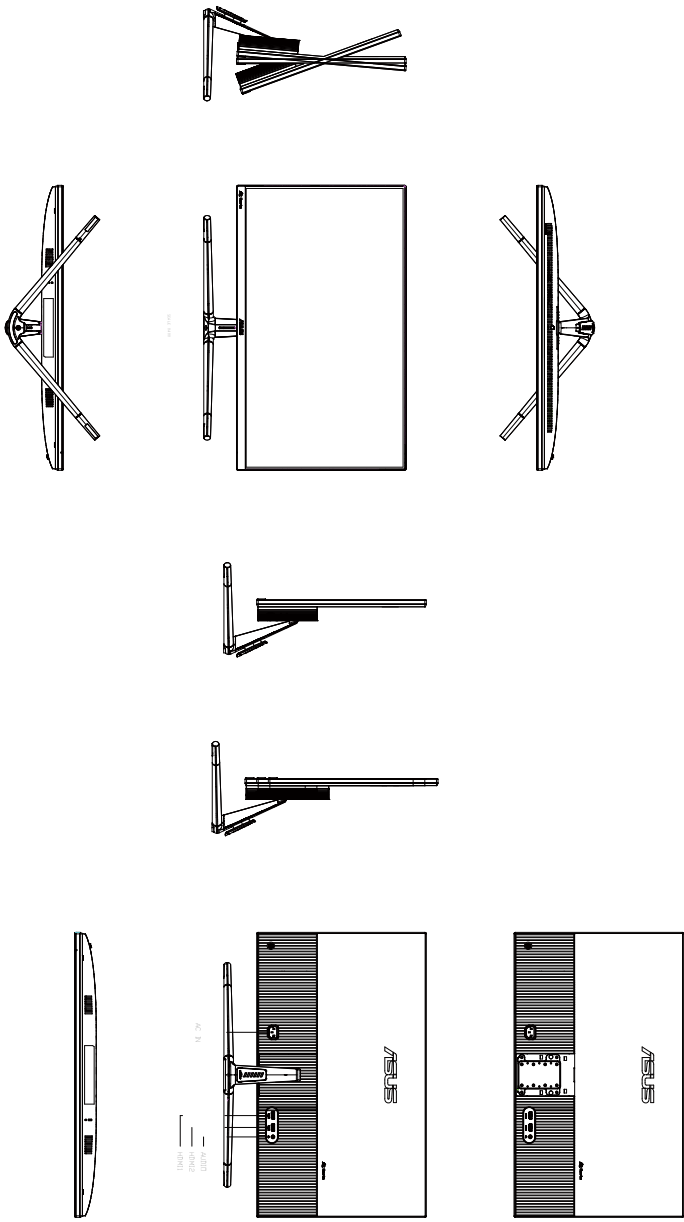

## 3.4 Troubleshooting (FAQ)

Problem	Possible Solution
Power LED is not ON	<ul style="list-style-type: none"><li>• Press the  button to check if the monitor is in the ON mode.</li><li>• Check if the power cord is properly connected to the monitor and the power outlet.</li><li>• Check if the power switch is ON.</li></ul>
The power LED lights amber and there is no screen image	<ul style="list-style-type: none"><li>• Check if the monitor and the computer are in the ON mode.</li><li>• Make sure the signal cable is properly connected the monitor and the computer.</li><li>• Inspect the signal cable and make sure none of the pins are bent.</li><li>• Connect the computer with another available monitor to check if the computer is properly working.</li></ul>
Screen image is too light or dark	<ul style="list-style-type: none"><li>• Adjust the Contrast and Brightness settings via OSD.</li></ul>
Screen image bounces or a wave pattern is present in the image	<ul style="list-style-type: none"><li>• Make sure the signal cable is properly connected to the monitor and the computer.</li><li>• Move electrical devices that may cause electrical interference.</li></ul>
Screen image has color defects (white does not look white)	<ul style="list-style-type: none"><li>• Inspect the signal cable and make sure that none of the pins are bent.</li><li>• Perform All Reset via OSD.</li><li>• Adjust the R/G/B color settings or select the Color Temperature via OSD.</li></ul>
No sound or sound is low	<ul style="list-style-type: none"><li>• Ensure that the HDMI cable is properly connected to the monitor and the computer.</li><li>• Adjust the volume settings of both your monitor and HDMI device.</li><li>• Ensure that the computer sound card driver is properly installed and activated.</li></ul>

## 3.5 Supported operating modes

Resolution Frequency	Horizontal Frequency (KHz)	Vertical Frequency (Hz)	Pixel (MHz)
640 x 480	31.47(N)	59.94(N)	25.18
640 x 480	37.87(N)	72.82(N)	31.5
640 x 480	37.5(N)	75.00(N)	31.5
720 x 400	31.47(N)	70.08(P)	28.32
800 x 600	35.16(P)	56.25(P)	36
800 x 600	37.88(P)	60.32(P)	40
800 x 600	48.08(P)	72.12(P)	50
800 x 600	46.86(P)	75.00(P)	49.5
832 x 624	49.72(P/N)	74.55(P/N)	57.28
848 x 480	31.0(P)	60(P)	33.75
1024 x 768	48.36(N)	60.00(N)	65
1024 x 768	56.476(N)	70.069(N)	75
1024 x 768	60.02(N)	75.00(N)	78.75
1152 x 864	67.5(P/N)	75(P/N)	108
1280 x 720	44.77(N)	60	74.5
1280 x 768	47.8(N)	60(N)	79.5
1280 x 768	60.3(P)	75(P)	102.25
1280 x 800	49.7(N)	60(P)	84.5
1280 x 960	60.00(P)	60.00(N)	108
1280 x 1024	63.98(P)	60.02(P)	108
1280 x 1024	79.98(P)	75.02(P)	135
1366 x 768	47.712(P)	59.79(P)	85.5
1400 x 1050	65.3(N)	60(P)	121.75
1440 x 900	55.94(N)	59.89(P)	106.5
1680 x 1050	65.29(N)	60.00(P)	146.25
1920 x 1080	67.5(P)	60.00(P)	148.5
1920 x 1080	83.925	75	167.85
1920 x 1080	95.54	85	191.08
1920 x 1080	106.875	95	222.3
1920 x 1080	109.004	100	221.28

"P" / "N" stands for "Positive" / "Negative" polarity of incoming H-sync/V-sync (input timing).



**When the monitor is operating in the video mode (ie, not displaying data), the following high definition modes shall be supported in addition to standard definition video.**

<b>Resolution</b>	<b>Vertical Frequency (Hz)</b>
1920 x 1080	50 Hz
	59.94 Hz
	60 Hz
1440 x 480p	59.94 Hz
	60 Hz
1440 x 576p	50 Hz
1280 x 720p	50 Hz
	59.94 Hz
720 x 576p	60 Hz
	50 Hz
720 x 480p	59.94 Hz
	60 Hz
640 x 480p (VGA)	59.94 Hz
	60 Hz