

Jabra GN

USER MANUAL



ENGAGE 45 SE

Technology for life's new rhythm

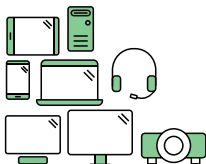

Say hello to a more sustainable product

IT products are associated with a wide range of sustainability risks throughout their life cycle. Human rights violations are common in the factories. Harmful substances are used both in products and their manufacture. Products can often have a short lifespan because of poor ergonomics, low quality and when they are not able to be repaired or upgraded.

This product is a better choice. It meets all the criteria in TCO Certified, the world's most comprehensive sustainability certification for IT products. Thank you for making a responsible product choice, that help drive progress towards a more sustainable future!

Criteria in TCO Certified have a life-cycle perspective and balance environmental and social responsibility. Conformity is verified by independent and approved verifiers that specialize in IT products, social responsibility or other sustainability issues. Verification is done both before and after the certificate is issued, covering the entire validity period. The process also includes ensuring that corrective actions are implemented in all cases of factory non-conformities. And last but not least, to make sure that the certification and independent verification is accurate, both TCO Certified and the verifiers are reviewed regularly.

Want to know more?

Read information about TCO Certified, full criteria documents, news and updates at [tcocertified.com](https://www.tcocertified.com). On the website you'll also find our Product Finder, which presents a complete, searchable listing of certified products.

Learn more about sustainability in Jabra at
jabra.com/about/sustainability

© 2024 GN Audio A/S. All rights reserved. Jabra® is a trademark of GN Audio A/S.

Made in China

MODEL: Model: WHB051BS
WHB050HS
WHB051HS



Declaration of Conformity can be found on
www.jabra.com/doc

REV B

1. Welcome.....	6
2. What's in the box.....	7
2.1 Stereo variant	
2.2 Mono variant	
2.3 Convertible variant	
2.4 Optional accessories	
3. How to wear.....	11
3.1 Stereo/Mono headset	
3.2 Convertible headset	
3.3 How to change the convertible headset EarGel	
3.4 How to adjust the convertible headset EarHook	
3.5 How to change the convertible headset wearing style	
4. First time use	16
4.1 Connect to a desk phone with headset port	
4.2 Connect to a desk phone without a headset port	
4.3 Dock and charge the headset	
5. Base overview.....	20
5.1 Base status LEDs	
5.2 How to adjust the microphone volume for desk phone calls	
5.3 How to find a dial tone for desk phones	

6. Jabra Direct.....	24
6.1 Firmware update	
7. How to use	26
7.1 Stereo/Mono headset overview	
7.2 Convertible headset overview	
7.3 Status LEDs	
7.4 Basic call usage	
7.5 Conference calls	
7.6 Transfer a call from desk phone to headset	
7.7 Transfer a call from headset to desk phone	
7.8 How to change voice notification language	
7.9 How to add a new primary headset	
7.10 How to reset the base	
7.11 How to reset the headset	
8. How to change settings.....	38
9. Support	40
9.1 FAQ	
9.2 How to care for your device	
9.3 Replacement accessories	

1. Welcome

Thank you for using the Jabra Engage 45 SE.
We hope you will enjoy it!

Jabra Engage 45 SE features

- **World's lightest DECT headset**
21 grams (convertible)
- **Avoid disturbances**
Built-in Busylight
- **Use all day long**
Up to 13 hours talk time (stereo/mono)
Up to 9 hours talk time (convertible)
- **Take calls anywhere in the office**
Up to 150 meters/490 feet range
(stereo/mono)
Up to 100 meters/325 feet range
(convertible)
- **Secure confidential calls**
DECT AES 256 bit encryption

2. What's in the box

The Jabra Engage 45 SE comes with one of three different headset styles: stereo, mono, and convertible.

2.1 Stereo variant

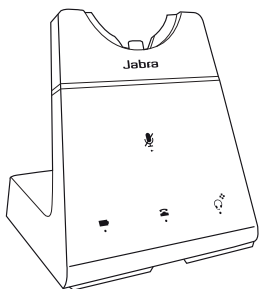

Base

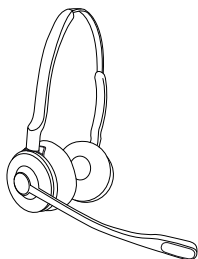

Stereo headset



Power supply

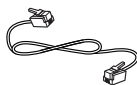

Telephone cable

2.2 Mono variant

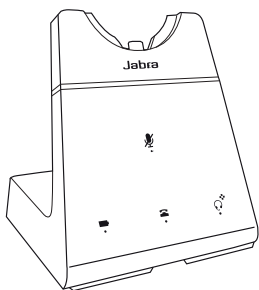

Base

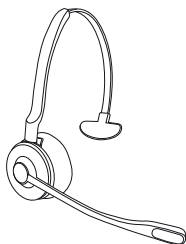

Mono
headset



Power supply

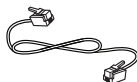

Telephone cable

2.3 Convertible variant

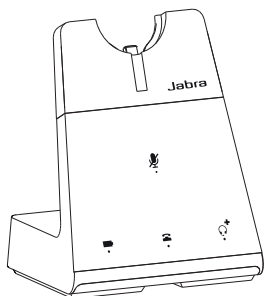

Base

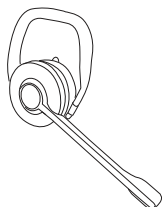

Convertible headset

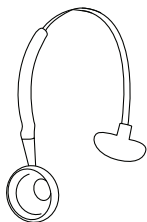

Headband



EarHook

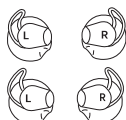

EarGels

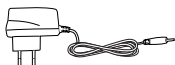

Power supply

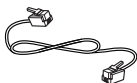

Telephone cable

2.4 Optional accessories

Optional accessories are available at jabra.com/accessories

Neckband for Mono headset

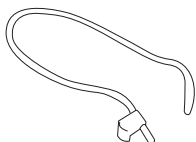

Neckband for Convertible headset

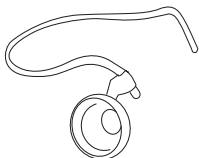

GN1000 handset lifter



Jabra EHS adapter

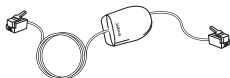

3. How to wear

3.1 Stereo/Mono headset

The headset can be worn with the microphone on the left or the right.

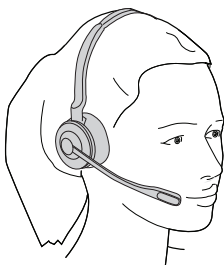

3.2 Convertible headset

The headset can be worn on the left or the right ear.

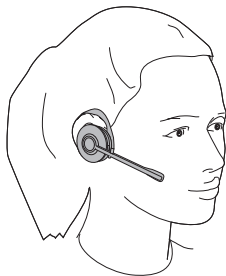

SECURITY NOTE:

On-head sensors can potentially be used to detect the presence of a user.

3.3 How to change the convertible headset EarGel

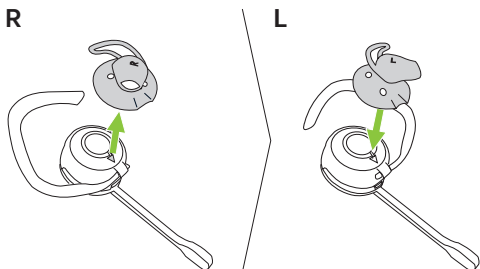
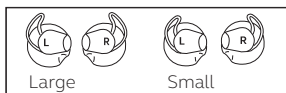

3.4 How to adjust the convertible headset EarHook

1. Adjust the EarHook to fit your specific ear shape.

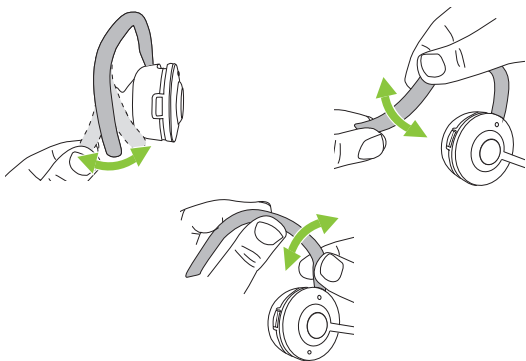

2. Place the headset on your ear.

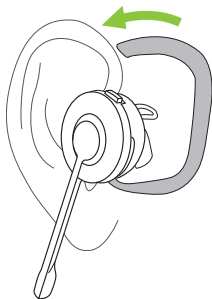

3. Point the microphone towards your mouth.

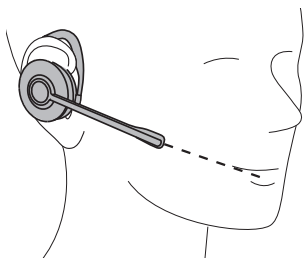

4. Ensure the EarHook is fitted to the back of your ear without a gap. Adjust the EarHook if necessary.

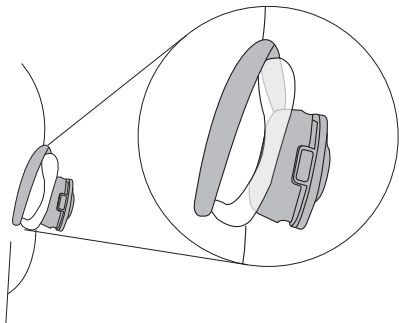

SECURITY NOTE:

Microphones can potentially be used to record private conversations.

3.5 How to change the convertible headset wearing style

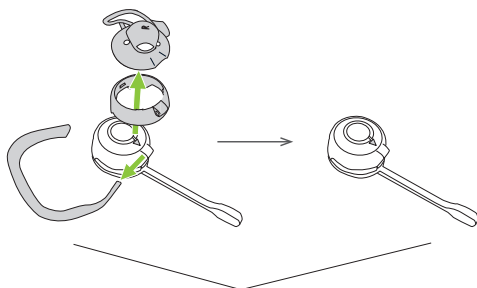

Headband

Neckband

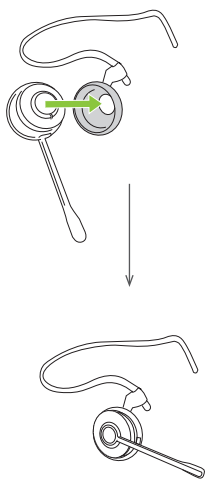
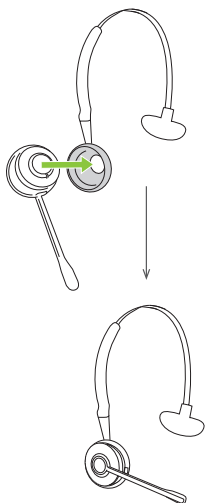

4. First time use

Connect phone



Connect to power



Dock and charge the headset



Make a test call to the connected phone



Wear the headset



Answer the call on your phone

Your Engage is now ready for use

4.1 Connect to a desk phone with headset port

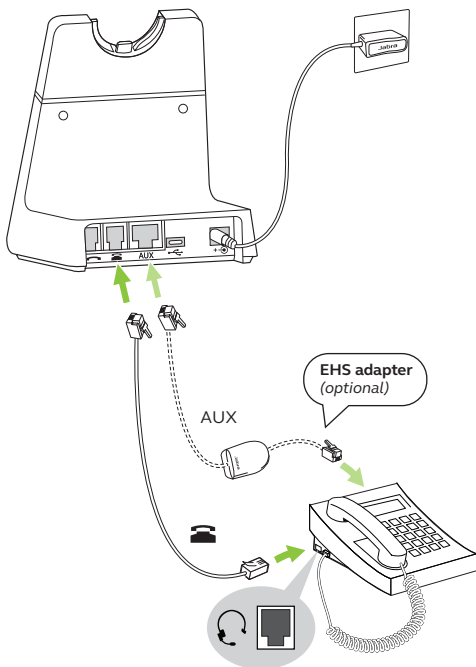

Note: USB-C connection is only used for settings configuration and firmware update.

SECURITY NOTE:

The headset uses DECT Security certification and FIPS 256-bit encryption for DECT connections.

4.2 Connect to a desk phone without a headset port

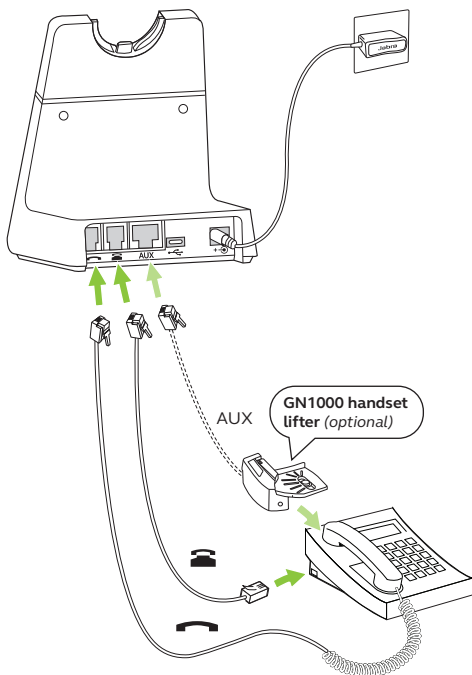

Note: USB-C connection is only used for settings configuration and firmware update.

SECURITY NOTE:

The headset uses DECT Security certification and FIPS 256-bit encryption for DECT connections.

4.3 Dock and charge the headset

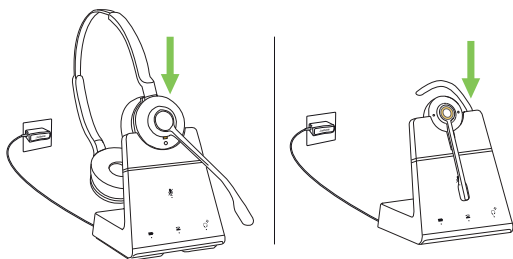

The headset will charge whenever it is docked in a base that is connected to a power supply. The status LED on the headset and the battery icon on the base will pulse to indicate the headset is charging.

The stereo/mono headsets have up to 13 hours of battery, and the convertible headset has up to 9 hours of battery.

All headsets take approx. 1.5 hours to fast charge to full. 40% of the battery will charge in approx. 30 minutes.

5. Base overview

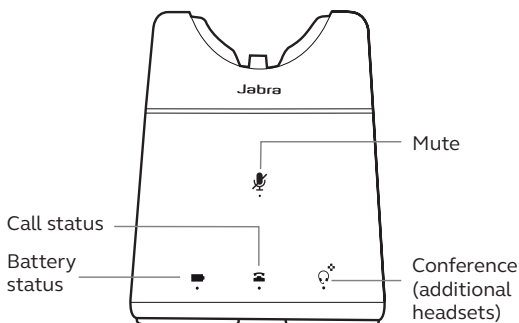

5.1 Base status LEDs

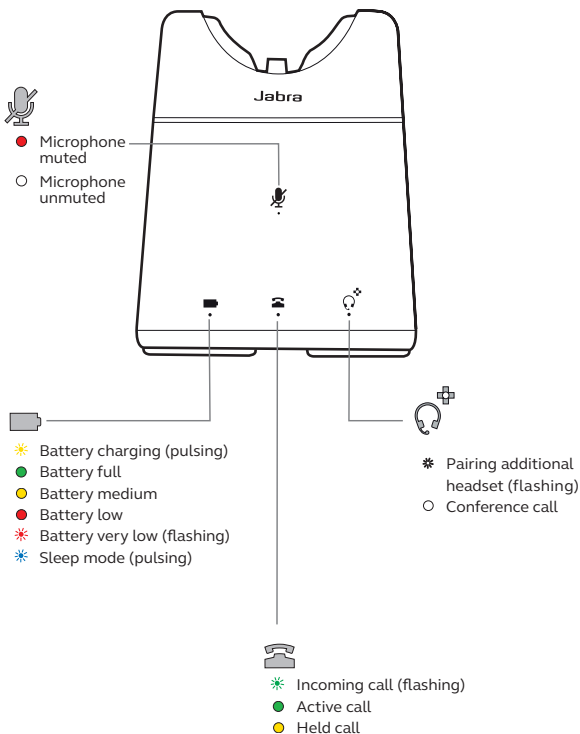

5.2 How to adjust the microphone volume for desk phone calls

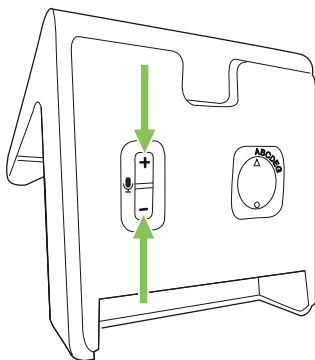

To adjust the desk phone microphone volume, press $+$ or $-$ buttons, located on the bottom of the base.

5.3 How to find a dial tone for desk phones

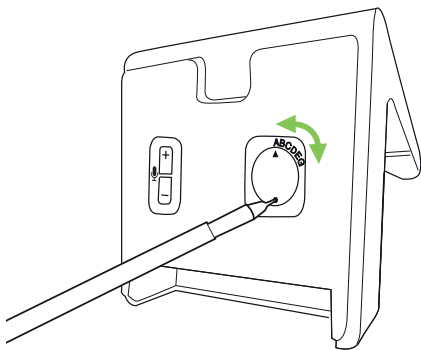

If you cannot hear a dial tone in your desk phone, it may be necessary to adjust the dial tone switch to a different setting.

The dial tone switch is located on the bottom of the base. Use a pointed object to rotate the switch between the different settings, until you do hear a dial tone in the headset. The default setting is A.

6. Jabra Direct

Jabra Direct is computer software designed to support, manage, and enable optimal functionality for your Jabra devices when connected to your computer.



Download via jabra.com/direct

6.1 Firmware update

Before first use, it is recommended to update the headset to the latest firmware using Jabra Direct. Jabra Direct will notify you when there is a firmware update when your device is connected to your computer.

To update the firmware, connect your device to your computer using a USB-C cable (not provided).

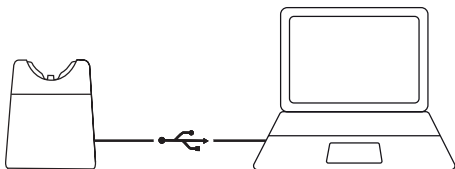

SECURITY NOTE:

There is no encryption for the data exchange between headset and USB devices or ports.

7. How to use

7.1 Stereo/Mono headset overview

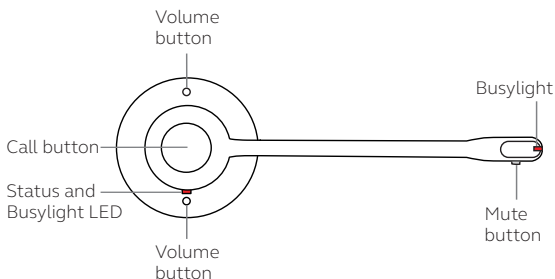

7.2 Convertible headset overview

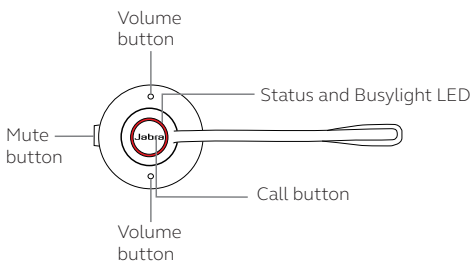

7.3 Status LEDs

Stereo/Mono variant

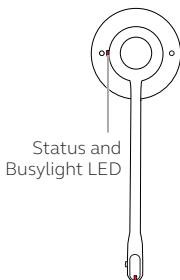

Convertible variant

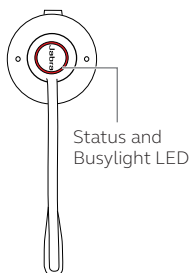

- Busylight
- ☀ Incoming call
- ☀ Headset powering on
- ☀ Headset powering off
- Headset fully charged
- ☀ Headset charging
- ☀ Firmware updating
- ☀ DECT pairing
- DECT connected

7.4 Basic call usage

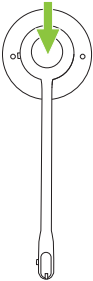
	Function	Action
	Power on	Press the Call button on the headset, or undock the headset from the base
	Power off	Hold the Call button for 4 seconds
	Answer call	Press the Call button or undock the headset
	End call	Press the Call button or dock the headset
	Reject call	Double-press the Call button

Press the **Volume** buttons.

Adjust volume

The convertible headset uses a motion sensor to detect which button is volume up and which is volume down, depending on the headset orientation



Toggle
Busylight

Press both **Volume** buttons
at the same time

Access the
Voice-guided
settings menu

Hold (3 secs) both **Volume**
buttons at the same time

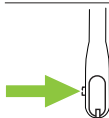

Mute/un-mute
microphone

Press the **Mute** button
(stereo/mono headset)

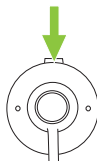

Mute/un-mute
microphone

Press the **Mute** button
(convertible headset)

7.5 Conference calls

Add headset(s) to a conference call

Up to three additional headsets can be connected to one base for conferencing. The primary headset must be in a call state to conference additional headsets.

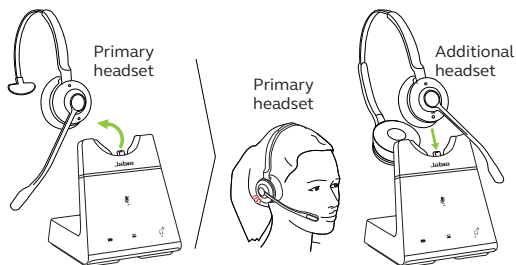

1. Undock the primary headset.
2. Dock an additional headset in the base. It will attempt to pair to the base.
3. A voice notification will play in the primary headset. Press the **Call** button on the primary headset to accept the additional headset to the conference. The audio will now be shared between headsets.

By default, the additional headset will be muted.

Note: It is possible to use for conference calls.

End or leave a conference call

To end the call for all headsets, press the **Call** button on the primary headset, or dock the primary headset in the base.

Additional headsets can leave the conference by pressing the **Call** button on the headset, or by docking the additional headset in the primary headset's base (not the additional headset's base). The conference call will continue for all other headsets.

Permanent conference mode

By default, the conference will end automatically for all additional headsets when the call ends.

It is possible to continue the conference with the additional headsets until the primary headset is docked, by changing this setting in Jabra Direct.

7.6 Transfer a call from desk phone to headset

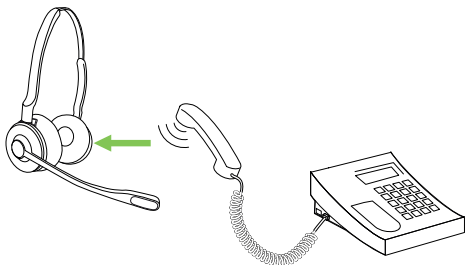

To transfer a call lift the headset from the base, or press the **Call** button on the headset. The call audio will transfer from the desk phone handset to the headset.

If necessary, press the headset button on the desk phone and do not hang up the handset until the call is finished.

7.7 Transfer a call from headset to desk phone

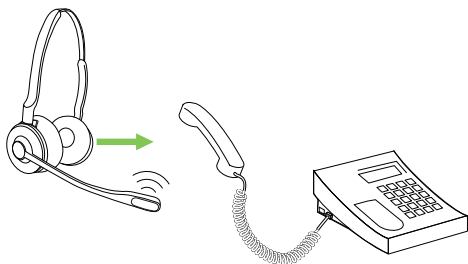

To transfer a call from the headset to a desk phone, lift the desk phone handset and then dock the headset in the base.

The call audio will transfer from the headset to the desk phone if the base is plugged into the handset port on the desk phone, otherwise press the headset button on the desk phone.

7.8 How to change voice notification language

There are 5 available languages for the headset voice notifications: English, German, French, Japanese, and Spanish.

To change language:

1. When not on a call, hold both **Volume** buttons (2 secs) on the headset to access the voice-guided settings menu. The first available setting is the voice notification language.
2. Press the **Volume up** or **Volume down button** to cycle through the available languages.
3. Press the **Call** button to accept the language.
4. Hold both **Volume** buttons (2 secs) on the headset to exit the voice-guided settings menu. The base will reboot and the new setting will be saved.

The language can also be changed using Jabra Direct.

7.9 How to add a new primary headset

It is only possible to have one primary headset for each base. Adding a new primary headset replaces the current primary headset. There are three methods for adding a new primary headset to the base:

A) If the current primary headset is not within range of the base or is turned off, simply dock the new headset in the base. It will become the primary headset. The headset status LED on the base will flash to indicate the new headset is now the primary headset.

B) If the current primary headset is within range of the base and is turned on, and the base is not on a call, dock the new headset in the base and hold the **Call** button (1 sec) on the headset until the headset status LED on the base flashes, indicating that it is now the primary headset.

C) If **Easy pairing** has been enabled in Jabra Direct, and the current primary headset is not on a call, simply dock the new headset in the base. It will become the primary headset. The headset status LED on the base will flash to indicate the new headset is now the primary headset.

7.10 How to reset the base

The base can be reset using Jabra Direct.

To manually reset the base, press and hold the **Volume up** and **Volume down** buttons under the base simultaneously for 3 seconds until all the LEDs on the base light up.

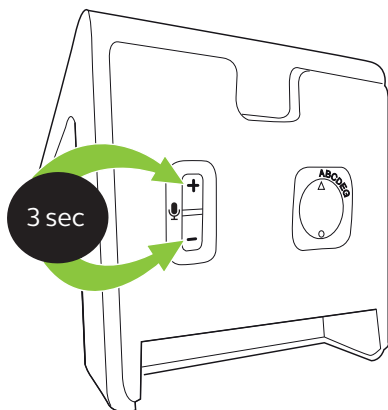

7.11 How to reset the headset

The headset can be reset using Jabra Direct.

To manually reset the headset, press and hold both the **Call** button and the **Volume up** buttons simultaneously for 3 seconds until the status LED flashes pink.

After resetting, dock the headset in the base to complete the pairing.

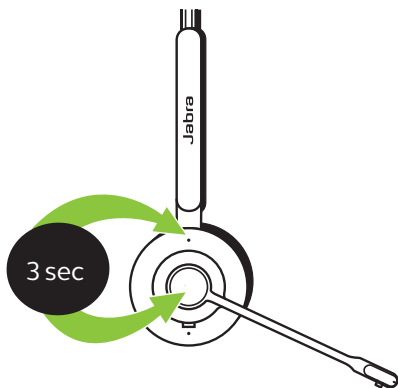



8. How to change settings

Headset and phone settings can be changed using the voice-guided settings menu.

Alternatively, all settings can be changed using Jabra Direct when connecting the base to your computer using a USB-C cable (not provided).

Download Jabra Direct at jabra.com/direct.

Menu Navigation

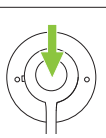
	Access the Voice-guided settings menu	Hold (3 secs) both the Volume up and the Volume down button at the same time
	Cycle through setting options	Press the Volume up or the Volume down button
	Exit the Voice-guided settings menu	Hold (2 secs) both the Volume up and the Volume down button at the same time
	Accept setting option	Press the Call button to accept the announced setting option. You will cycle to the next setting

Settings

Voice notification language	Select the headset voice language from a list of 5 languages
Voice notifications	Select to enable voice notifications
Mute reminder tone	Select to use a periodic audio reminder when the microphone is muted
Range or density	Select if the base should be optimized for improved range, or improved density
Hook lifter type	Select the hook lifter type

9. Support

9.1 FAQ

View the FAQs at jabra.com/support

9.2 How to care for your device

- It is recommended to keep the headset between -5°C and 45°C (23°F and 113°F).
- Do not store the headset for extended periods of time without recharging the battery (max. three months).
- If the headset or base becomes dirty, it is recommended to clean them with a soft, lint-free cloth that has been dampened with clean water.

9.3 Replacement accessories

Replacement or additional accessories can be purchased online at jabra.com/accessories.