

# ViewSonic®



---

## **CDE6502**

### **Commercial Display**

### **User Guide**

---

IMPORTANT: Please read this User Guide to obtain important information on installing and using your product in a safe manner, as well as registering your product for future service. Warranty information contained in this User Guide will describe your limited coverage from ViewSonic Corporation, which is also found on our web site at <http://www.viewsonic.com> in English, or in specific languages using the Regional selection box in the upper right corner of our website. "Antes de operar su equipo lea cuidadosamente las instrucciones en este manual"

---

Model No.: VS16457

## Thank you for choosing ViewSonic

With over 25 years as a world leading provider of visual solutions, ViewSonic is dedicated to exceeding the world's expectations for technological evolution, innovation, and simplicity. At ViewSonic, we believe that our products have the potential to make a positive impact in the world, and we are confident that the ViewSonic product you have chosen will serve you well.

Once again, thank you for choosing ViewSonic !



# Compliance Information

**NOTE:** This section addresses all connected requirements and statements regarding regulations. Confirmed corresponding applications shall refer to nameplate labels and relevant markings on unit.

## FCC Statement

This device complies with Part 15 of the FCC Rules. Operation is subject to the following two conditions: (1) this device may not cause harmful interference, and (2) this device must accept any interference received, including interference that may cause undesired operation.

**NOTE:** This equipment has been tested and found to comply with the limits for a Class A/ Class B digital device, pursuant to Part 15 of the FCC Rules. These limits are designed to provide reasonable protection against harmful interference when the equipment is operated in a commercial environment. This equipment generates, uses, and can radiate radio frequency energy and, if not installed and used in accordance with the instructions, may cause harmful interference to radio communications. Operation of this equipment in a residential area is likely to cause harmful interference in which case the user will be required to correct the interference at his/her own expense.

- Reorient or relocate the receiving antenna.
- Increase the separation between the equipment and receiver.
- Connect the equipment into an outlet on a circuit different from that to which the receiver is connected.
- Consult the dealer or an experienced radio/TV technician for help.

**Warning:** To comply with the limits for the Class A/Class B digital device, pursuant to Part 15 of the FCC Rules, this device must be installed in computer equipment certified to comply with the Class A/Class B limits. All cables used to connect the computer and peripherals must be shielded and grounded. Operation with non-certified computers or non-shielded cables may result in interference to radio or television reception. Changes and modifications not expressly approved by the manufacturer could void the user's authority to operate this equipment.

## For Canada

CAN ICES-3 (A/B)/NMB-3(A/B)

## CE Conformity for European Countries

 The device complies with the EMC Directive 2014/30/EU and Low Voltage Directive 2014/35/EU.

### Following information is only for EU-member states:

The mark shown to the right is in compliance with the Waste Electrical and Electronic Equipment Directive 2012/19/EU (WEEE).

The mark indicates the requirement NOT to dispose of the equipment as unsorted municipal waste, but use the return and collection systems according to local law.

If the batteries, accumulators and button cells included with this equipment, display the chemical symbol Hg, Cd, or Pb, then it means that the battery has a heavy metal content of more than 0.0005% Mercury or more than, 0.002% Cadmium, or more than 0.004% Lead.



## Industry Canada Notice

This device complies with Canadian RSS-210. To prevent radio interference to the licensed service, this device is intended to be operated indoors and away from windows to provide maximum shielding. Equipment (or its transmitting antenna) that is installed outdoors is subject to licensing. The installer of this radio equipment must ensure that the antenna is located or pointed such that it does not emit RF field in excess of Health Canada limits for the general population; consult Safety Code 6, obtainable from Health Canada's website [www.hc-sc.gc.ca/rpb](http://www.hc-sc.gc.ca/rpb).

## R&TTE Compliance Statement

This device complies with the Essential Requirements of the R&TTE Directive of the European Union (1999/5/EC). This equipment meets the following conformance standards:

ETSI EN 300 328

EN 301 489-01

EN 301 489-17

EN 62311

**Notified Countries:** Germany, UK, Netherlands, Belgium, Sweden, Denmark, Finland, France, Italy, Spain, Austria, Ireland, Portugal, Greece, Luxembourg, Estonia, Latvia, Lithuania, Czech Republic, Slovakia, Slovenia, Hungary, Poland and Malta.



# Declaration of RoHS2 Compliance

This product has been designed and manufactured in compliance with Directive 2011/65/EU of the European Parliament and the Council on restriction of the use of certain hazardous substances in electrical and electronic equipment (RoHS2 Directive) and is deemed to comply with the maximum concentration values issued by the European Technical Adaptation Committee (TAC) as shown below:

Substance	Proposed Maximum Concentration	Actual Concentration
Lead (Pb)	0.1%	< 0.1%
Mercury (Hg)	0.1%	< 0.1%
Cadmium (Cd)	0.01%	< 0.01%
Hexavalent Chromium (Cr <sup>6+</sup> )	0.1%	< 0.1%
Polybrominated biphenyls (PBB)	0.1%	< 0.1%
Polybrominated diphenyl ethers (PBDE)	0.1%	< 0.1%
Bis (2-ethylhexyl) phthalate (DEHP)	0.1%	< 0.1%
Butyl benzyl phthalate (BBP)	0.1%	< 0.1%
Dibutyl phthalate (DBP)	0.1%	< 0.1%
Diisobutyl phthalate (DIBP )	0.1%	< 0.1%

Certain components of products as stated above are exempted under the Annex III of the RoHS2 Directives as noted below:

Examples of exempted components are:

1. Mercury in cold cathode fluorescent lamps and external electrode fluorescent lamps (CCFL and EEFL) for special purposes not exceeding (per lamp):
  - (1) Short length ( $\leq 500$  mm): maximum 3.5 mg per lamp.
  - (2) Medium length ( $> 500$  mm and  $\leq 1,500$  mm): maximum 5 mg per lamp.
  - (3) Long length ( $> 1,500$  mm): maximum 13 mg per lamp.
2. Lead in glass of cathode ray tubes.
3. Lead in glass of fluorescent tubes not exceeding 0.2% by weight.
4. Lead as an alloying element in aluminium containing up to 0.4% lead by weight.
5. Copper alloy containing up to 4% lead by weight.
6. Lead in high melting temperature type solders (i.e. lead-based alloys containing 85% by weight or more lead).
7. Electrical and electronic components containing lead in a glass or ceramic other than dielectric ceramic in capacitors, e.g. piezoelectronic devices, or in a glass or ceramic matrix compound.

# Safety Precautions

FOR OPTIMUM PERFORMANCE, PLEASE NOTE THE FOLLOWING WHEN SETTING UP AND USING THE LCD COLOR MONITOR:

- DO NOT REMOVE MONITOR BACK COVER. There are no user serviceable parts inside and opening or removing covers may expose you to dangerous shock hazards or other risks. Refer all servicing to qualified service personnel.
- Do not spill any liquids into the cabinet or use your monitor near water.
- Do not insert objects of any kind into the cabinet slots, as they may touch dangerous voltage points, which can be harmful or fatal or may cause electric shock, fire or equipment failure.
- Do not place any heavy objects on the power cord. Damage to the cord may cause shock or fire.
- Do not place this product on a sloping or unstable cart, stand or table, as the monitor may fall, causing serious damage to the monitor.
- Do not place any objects onto the monitor and do not use the monitor outdoors.
- The inside of the fluorescent tube located within the LCD monitor contains mercury. Please follow the laws or rules of your municipality to dispose of the tube properly.
- Do not bend power cord.
- Do not use monitor in high temperature, humid, dusty, or oily areas.
- If monitor or glass is broken, do not come in contact with the liquid crystal and handle with care.
- Allow adequate ventilation around the monitor, so that heat can properly dissipate. Do not block ventilated openings or place the monitor near a radiator or other heat sources. Do not put anything on top of the monitor.
- The power cable connector is the primary means of detaching the system from the power supply. The monitor should be installed close to a power outlet, which is easily accessible.
- Handle with care when transporting. Save packaging for transporting.
- Please clean the holes of back cabinet to reject dirt and dust at least once a year because of set reliability.
- If using the cooling fan continuously, it's recommended to wipe holes a minimum of once a month.
- When installing the remote control batteries;
  - Align the batteries according to the (+) and (-) indications inside the case.
  - Align the (-) indication of the battery first inside the case.

## **WARNING:**

Usage of other than specified head- or earphones can result in hearing loss due to excessive sound pressures.

**CAUTION:**

Immediately unplug your monitor from the wall outlet and refer servicing to qualified service personnel under the following conditions:

- When the power supply cord or plug is damaged.
- If liquid has been spilled, or objects have fallen into the monitor.
- If the monitor has been exposed to rain or water.
- If the monitor has been dropped or the cabinet damaged.
- If the monitor does not operate normally by following operating instructions.

**Recommended Use****CAUTION:**

- For optimum performance, allow 20 minutes for warm-up.
- Rest your eyes periodically by focusing on an object at least 5 feet away. Blink often.
- Position the monitor at a 90° angle to windows and other light sources to minimize glare and reflections.
- Clean the LCD monitor surface with a lint-free, nonabrasive cloth. Avoid using any cleaning solution or glass cleaner!
- Adjust the monitor's brightness, contrast and sharpness controls to enhance readability.
- Avoid displaying fixed patterns on the monitor for long periods of time to avoid image persistence (after image effects).
- Get regular eye checkups.

**Ergonomics**

To realize the maximum ergonomic benefits, we recommend the following:

- Use the preset Size and Position controls with standard signals.
- Use the preset Color Setting.
- Use non-interlaced signals.
- Do not use primary color blue on a dark background, as it is difficult to see and may produce eye fatigue due to insufficient contrast.

# Table Of Contents

<b>1. Unpacking and Installation</b> .....	<b>1</b>	<b>9. Troubleshooting</b> .....	<b>17</b>
1.1. Unpacking .....	1	<b>10. Technical Specifications</b> .....	<b>18</b>
1.2. Package Contents .....	1	<b>11. RS232 Protocol</b> .....	<b>20</b>
1.3. About Location / Environment .....	1	11.1. Introduction .....	20
1.4. About After-Image .....	2	11.2. Description .....	20
1.5. Cleaning and Maintenance .....	2	11.2.1. Hardware specification .....	20
1.6. Carrying or Moving the display.....	2	11.2.2. Communication Setting ....	20
1.7. Installing the stand (Optional) .....	3	11.2.3. Command Message	
1.8. Mounting on a Wall.....	4	Reference .....	20
1.8.1. VESA Grid .....	4	11.3. Protocol .....	21
<b>2. Parts and Functions</b> .....	<b>5</b>	11.3.1. Set-Function Listing.....	21
2.1. Control Panel .....	5	11.3.2. Get-Function Listing .....	25
2.2. Input/Output Terminals .....	5	11.3.3. Remote Control Pass-	
2.3. Remote Control .....	6	through mode .....	30
2.3.1. General functions .....	6	<b>12. Other Information</b> .....	<b>33</b>
2.3.2. Inserting the batteries in the		Customer Support.....	33
remote control.....	7	Limited Warranty .....	34
2.3.3. Handling the remote		Mexico Limited Warranty .....	36
control.....	7		
2.3.4. Operating range of the			
remote control .....	7		
<b>3. Connections</b> .....	<b>8</b>		
3.1. Cautions Before Connecting .....	8		
<b>4. Operation</b> .....	<b>9</b>		
4.1. Turning the display on or off.....	9		
4.2. Home Menu Overview.....	9		
<b>5. System Settings</b> .....	<b>10</b>		
<b>6. Network Settings</b> .....	<b>11</b>		
<b>7. Menu List</b>			
.....	<b>12</b>		
<b>8. Using USB multi media player</b> .....	<b>14</b>		
8.1. Playing Photo .....	15		
8.2. Playing Music .....	15		
8.3. Playing Movie.....	16		

## Copyright Information

Copyright © ViewSonic Corporation, 2016. All rights reserved.

ViewSonic® and the three birds logo are registered trademarks of ViewSonic Corporation.

ENERGY STAR® is a registered trademark of the U.S. Environmental Protection Agency (EPA). As an ENERGY STAR® partner, ViewSonic Corporation has determined that this product meets the ENERGY STAR® guidelines for energy efficiency.

Disclaimer: ViewSonic Corporation shall not be liable for technical or editorial errors or omissions contained herein; nor for incidental or consequential damages resulting from furnishing this material, or the performance or use of this product.

In the interest of continuing product improvement, ViewSonic Corporation reserves the right to change product specifications without notice. Information in this document may change without notice.

No part of this document may be copied, reproduced, or transmitted by any means, for any purpose without prior written permission from ViewSonic Corporation.

## Product Registration

To meet your future needs, and to receive any additional product information as it becomes available, please register your product on the Internet at: [www.viewsonic.com](http://www.viewsonic.com).

The ViewSonic® Wizard CD-ROM also provides an opportunity for you to print the registration form, which you may mail or fax to ViewSonic.

### For Your Records

<b>Product Name:</b>	CDE6502 ViewSonic Commercial Display
<b>Model Number:</b>	VS16457
<b>Document Number:</b>	CDE6502_UG_ENG Rev. 1A 01-20-16
<b>Serial Number:</b>	_____
<b>Purchase Date:</b>	_____

### Product disposal at end of product life

ViewSonic respects the environment and is committed to working and living green. Thank you for being part of Smarter, Greener Computing.

Please visit ViewSonic website to learn more.

USA & Canada: <http://www.viewsonic.com/company/green/recycle-program/>

Europe: <http://www.viewsoniceurope.com/uk/support/recycling-information/>

Taiwan: <http://recycle.epa.gov.tw/recycle/index2.aspx>

# 1. Unpacking and Installation

## 1.1. Unpacking

- This product is packed in a carton, together with the standard accessories.
- Any other optional accessories will be packed separately.
- Due to the size and weight of this display it is recommended for two people to move it.
- After opening the carton, ensure that the contents are complete and in good condition.

## 1.2. Package Contents

Please verify that you received the following items with your package content:

- LCD display
- CD ROM
- Remote control with AAA batteries
- Power cord (1.8 m)
- Quick Start Guide

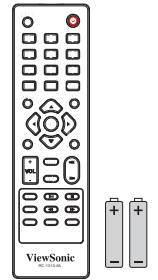
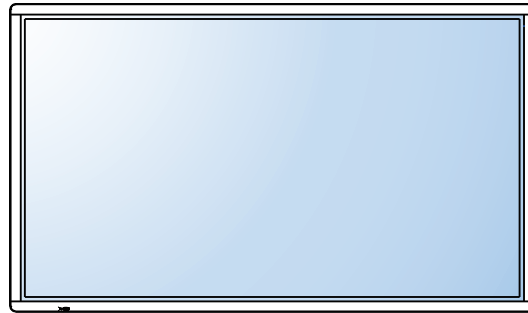

Remote Control and AAA Batteries

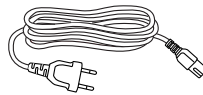

Power Cord

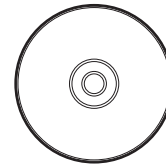

CD ROM

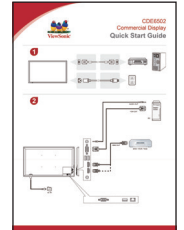

Quick Start Guide

\* The supplied power cord varies depending on destination.

### NOTES:

- For all other regions, apply a power cord that conforms to the AC voltage of the power socket and has been approved by and complies with the safety regulations of the particular country.
- You might like to save the package box and packing material for shipping the display.

## 1.3. About Location / Environment

Do not use in hot and cold rooms (locations)

- When the unit is used in rooms (locations) with low temperature, the picture may leave trails or appear slightly delayed. This is not a malfunction, and the unit will recover when the temperature returns to normal.
- Do not leave the unit in a hot or cold location. Also, do not leave the unit in a location exposed to direct sunlight or near a heater, or in high humidity, as this may cause the cabinet to deform and the screen to malfunction, and affect the display's performance.
- Environment condition:  
Operating temperature: 5°C – 35°C  
Operating humidity: 20 – 80 % ( no moisture condensation ) Storage temperature: -15°C – 45°C  
Storage humidity: 10 – 80 % Atmospheric pressure: 86 kPa ~106 kPa

## 1.4. About After-Image

The extended use of fixed image program material can cause a permanent afterimage on the screen.

This background image is viewable on normal programs in the form of a stationary fixed image. This type of irreversible screen deterioration can be limited by observing the following steps:

- A. Reduce the brightness/contrast setting to a minimum viewing level.
- B. Do not display the fixed image for extended periods of time.
- C. Turn the power off when not in actual use.

Important Information Regarding Use of Video Games, Computers, Captions or Other Fixed Image Displays.

- Do not allow a still picture to be displayed for an extended period, as this can cause a permanent after-image to remain on the screen.  
Examples of still pictures include logos, video games, computer images, teletext and images displayed in 4:3 mode.

### CAUTIONS:

- The permanent after-image on the screen resulting from fixed image use is not an operating defect and as such is not covered by the warranty.
- This product is not designed to display fixed images for extended periods of time.

## 1.5. Cleaning and Maintenance

To clean this unit, wipe with a soft, dry cloth.

Clean the cabinet with a soft, lint-free cloth, If the cabinet is especially dirty, moisten a soft, lint-free cloth in a weak detergent solution, squeeze the excess moisture from the cloth, then wipe the cabinet with the cloth. Use a clean cloth to dry the cabinet.

- Clean the screen with a soft, lint-free cloth.
- Use eyeglass cleaner to remove stubborn dirt from the screen.
- Never use alcohol, paint thinner or benzine to clean this unit.

## 1.6. Carrying or Moving the display

- When you move the display , hold the frame of the display .
- Be aware of the danger or harm which may caused by carrying or moving the display , as the bezel is very thin.
- When transporting, do not subject the unit to shocks or vibration, or excessive force.

## 1.7. Installing the stand (Optional)

If the stand is provided, please read these instructions thoroughly before attempting this installation.

### CAUTIONS:

- Make sure that you handle your Display very carefully when attempting assembly or removal of the stand. If you are not sure of your ability to do this, or of your ability to use the tools necessary to complete this job, refer to a professional installer or service personnel. The manufacturer is not responsible for any damages or injuries that occur due to mishandling or improper assembly.
- When using a table or bench as an aid to assembly, make sure that you put down a soft cushion or covering to prevent accidental scratching or damage to your Display's finish.
- Before attempting assembly or removal of the stand, unplug the AC power cord.

### To install the stand:

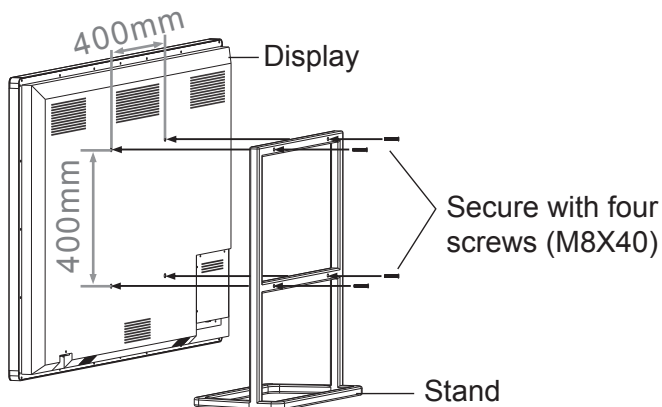

1. Remove the stand from the box and place it on a table or bench. You must pay attention to the direction of the stand. The wide portion of the stand should go towards the front of the display.
2. Lay your display flat (screen down) on the edge of a table or bench. Make sure that you put down a soft cushion or cloth so that your display is not scratched.
3. Put the stand column close to the back of the display, align the screw holes on the stand column with the holes in the display, then secure the stand to the display with four provided screws.

### NOTES:

- The appearance of this product in these illustrations may differ from your actual product, and is for comparative purposes only.
- We may change the design and specifications without notice.



## 1.8. Mounting on a Wall

To mount this display to a wall, you will have to obtain a standard wall-mounting kit. We recommend using a mounting interface that complies with UL1678 standard in North America.

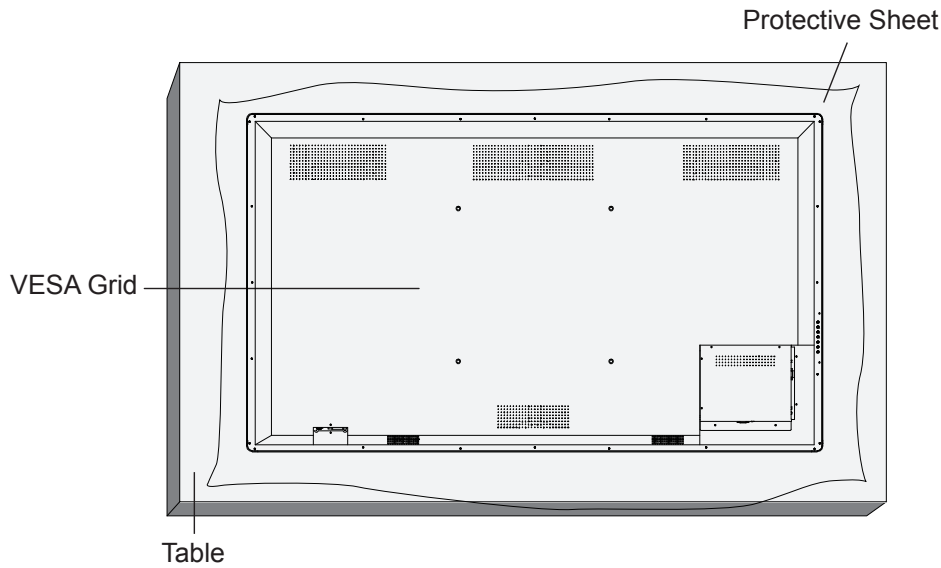

1. Lay a protective sheet on a table, which was wrapped around the display when it was packaged, beneath the screen surface so as not to scratch the screen face.
2. Ensure you have all accessories for mounting this display (wall mount, ceiling mount, table stand, etc).
3. Follow the instructions that come with the base mounting kit. Failure to follow correct mounting procedures could result in damage to the equipment or injury to the user or installer. Product warranty does not cover damage caused by improper installation.
4. For the wall-mounting kit, use M8 mounting screws (having a length 15-25 mm longer than the thickness of the mounting bracket) and tighten them securely.
5. Unit without base weight = **W** Kg. The equipment and its associated mounting means still remain secure during the test. For use only with UL Listed Wall Mount Bracket with minimum weight/load: **W** Kg.

Model Name	W (kg)
CDE6502	47

**Note:** You must remove the stand before wall mounting.

### 1.8.1. VESA Grid

Model Name	Vesa Grid
CDE6502	400(H) x 400(V)mm

#### Caution:

To prevent the display from falling:

- For wall or ceiling installation, we recommend installing the display with metal brackets which are commercially available. For detailed installation instructions, refer to the guide received with the respective bracket.
- To lessen the probability of injury and damage resulting from fall of the display in case of earthquake or other natural disaster, be sure to consult the bracket manufacturer for installation location.

## 2. Parts and Functions

### 2.1. Control Panel

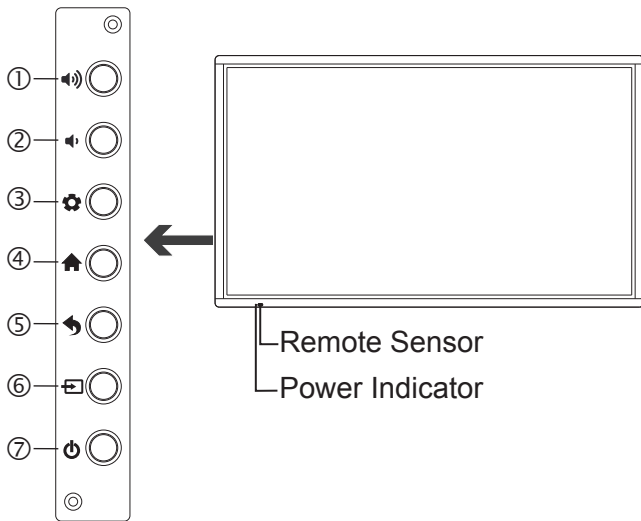

- ① : Press the button to volume up.
- ② : Press the button to volume down.
- ③ : Press the button to open the setting menu.
- ④ : Press the button to display desktop (Home page) on the screen.
- ⑤ : Press the button to return to previous menu.
- ⑥ : Press the button to display input source menu or exit the menu screen. To confirm or enter a sub-menu during Menu operation.
- ⑦ : Switch the display power on or standby.

### 2.2. Input/Output Terminals

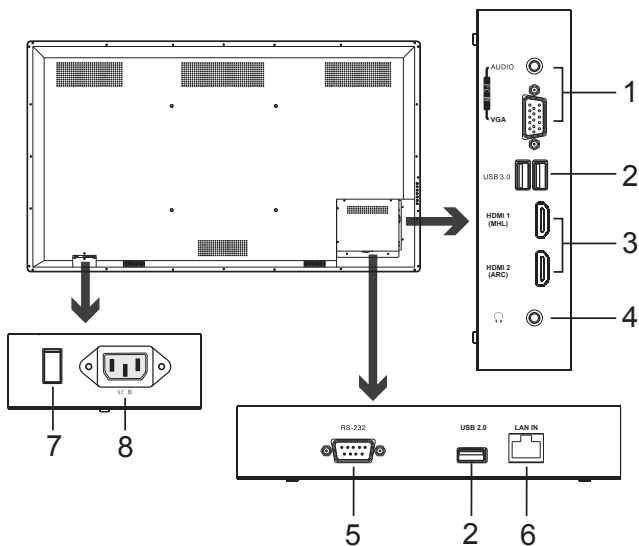

1. **PC IN**  
Enable connection to PC or other external devices with VGA/AUDIO ports.
  2. **USB 2.0/3.0**  
USB standard interface, enable connection to USB 2.0, USB 3.0 standard devices. When connecting, please select the appropriate port.
  3. **HDMI1/2 Input**  
To connect with those equipments with HDMI or DVI interface. HDMI1(MHL): Connect an MHL - enabled device such as a cell phone to this jack to view the external device's screen on your display. HDMI2(ARC): Connect an ARC-enabled home theater receiver to this jack.
  4.   
Connect headphones to this jack. The display is the current audio output.
  5. **RS-232**  
For service, software upgrades and the other uses.
  6. **LAN IN**  
Enable connection to cable and log on to Internet.
  7. **Power Switch**  
Push to (1) to connect the power, push to (O) to cut off.
- Note:** Power switch can not be covered, and should keep the power switch can be conveniently operated.
8. **AC IN**  
Plug the AC cord into this jack and into a power outlet. (~100-240V 50Hz/60Hz)

## 2.3. Remote Control

### 2.3.1. General functions

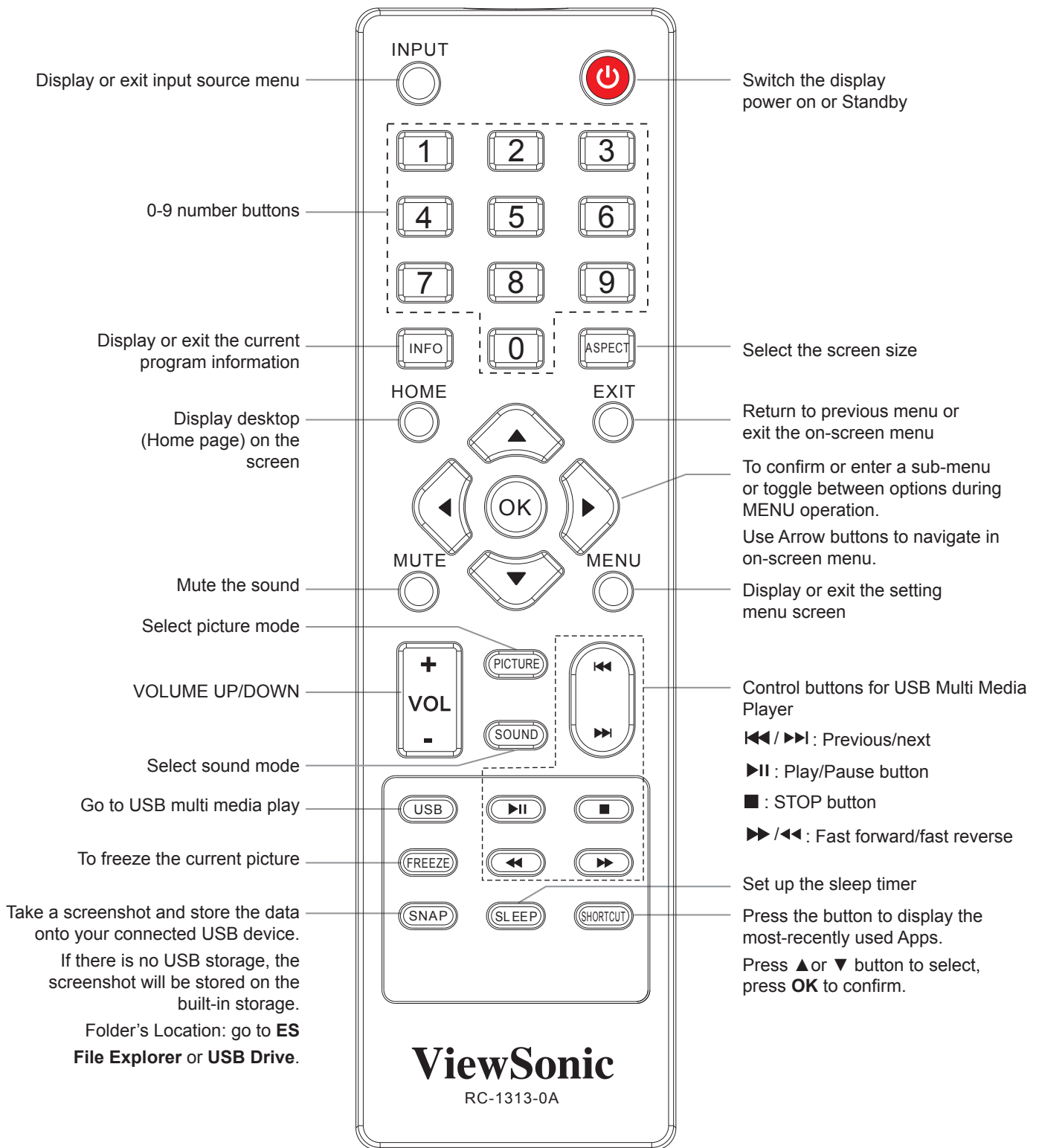

#### Notes:

- This operation manual provides a description based on operating functions with the remote control.
- In different mode, some buttons may have different function.

### 2.3.2. Inserting the batteries in the remote control

#### To install remote control batteries:

1. Open the battery cover.
2. Insert two AAA batteries into the battery compartment. Make sure that the + and – symbols on the batteries match the + and – symbols in the battery compartment.
3. Replace the cover.

#### Battery precautions:

Improper use of batteries can result in a leakage of chemicals and/or explosion. Be sure to follow the instructions below.

- Place batteries with their terminals corresponding to the (+) and (–) indications.
- Different types of batteries have different characteristics. Do not mix batteries of different types.
- Different types of batteries have different characteristics. Do not mix batteries of different types.
- Do not mix old and new batteries. Mixing old and new batteries can shorten the life of new batteries and/or cause old batteries to leak chemicals.
- Remove batteries as soon as they are non-operable. Chemicals that leak from batteries can cause a rash. If chemical leakage is found, wipe with a cloth.
- Dispose of batteries in a proper manner.
- If the remote control is not used for an extended period of time, remove the batteries.
- The batteries shall not be exposed to excessive heat such as sunshine, fire or the like.

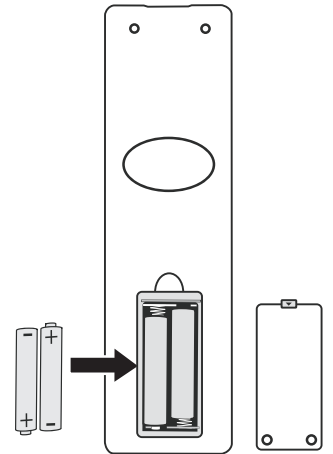

### 2.3.3. Handling the remote control

- Do not subject to strong shock.
- Do not allow water or other liquid to splash the remote control.
- If the remote control gets wet, wipe it dry immediately.
- Avoid exposure to heat and steam.
- Other than to install the batteries, do not open the remote control.

### 2.3.4. Operating range of the remote control

Use the remote control by pointing it towards the remote sensor on the front of your display. Objects between the remote control and the remote sensor may prevent proper operation.

#### Cautions regarding use of remote control

Improper use of batteries can result in a leakage of chemicals and/or explosion. Be sure to follow the instructions below.

- Do not expose the remote control to shock. In addition, do not expose the remote control to liquids, and do not place in an area with high humidity.
- Do not install or place the remote control under direct sunlight. The heat may cause deformation of the unit.
- The remote control may not work properly if the remote sensor window of the main unit is under direct sunlight or strong lighting. In such a case, change the angle of the lighting or the display set, or operate the remote control closer to the remote sensor window.

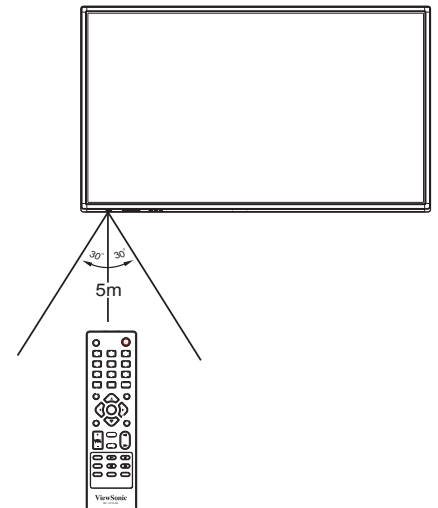

### 3. Connections

#### 3.1. Cautions Before Connecting

- When connecting an external device to the display, make sure that the display and the device are turned off.
- Check the plugs at the ends of cables to make sure that they are the correct type before you try plugging them into jacks on the display.
- Make sure that all plugs are securely inserted into the jacks. Loose connections can result in image or color problems.
- The illustration of the external device may be different depending on your model.
- Refer to the operating manual of the external device as well.

1. Connect the female plug to the AC socket on the unit.
2. Connect the male plug to the wall outlet as illustrated.

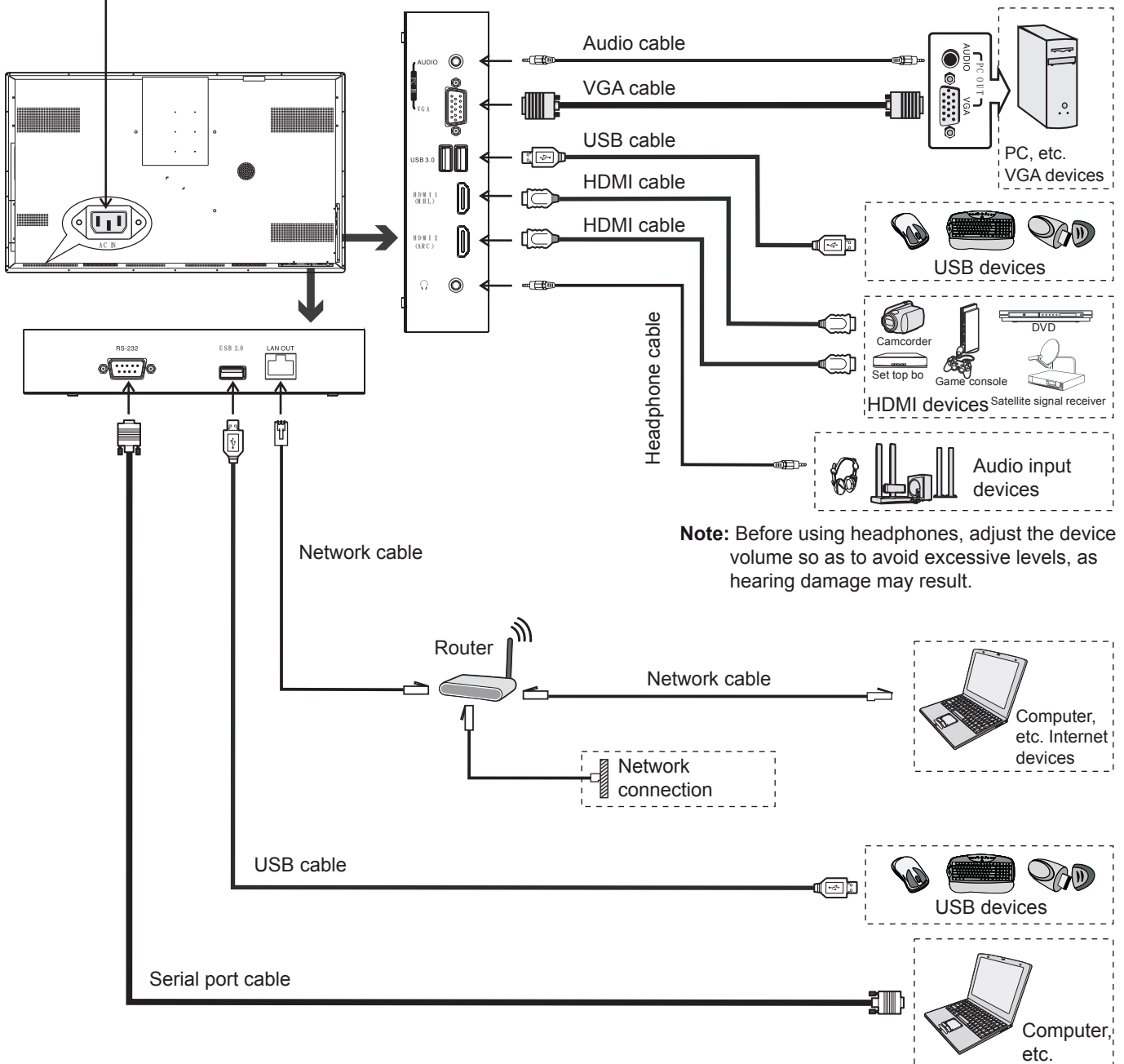

**Notes:**

- This product should be operated only from the type of power source indicated on the marking label.
- Always unplug the AC cord from power outlet when not using for a long period of time.









## 4. Operation

### 4.1. Turning the display on or off

1. Plug the power cord into an AC power outlet. Press **Power Switch** on the display.
2. Now the display is in standby mode. Wait a moment until the power indicator lights up, then press **POWER**  to turn on the display. (Be sure to wait for a few seconds before pressing POWER button. If you promptly press POWER button then the display may not respond or act wrongly.)
3. Press  button again to turn off the display and put the display in standby mode.  
To cut off the power completely, press **Power Switch** on the display.

**Note:** If the display does not receive a displaying signal for a certain time, the display goes into standby mode.

### 4.2. Home Menu Overview

1. Press **HOME** button and the **HOME** menu screen display.
2. Press  or  button to select desktop menu option, press **OK** to confirm.
3. Press     button to move the cursor, press **OK** to confirm
4. Press **EXIT** button to return to previous menu or exit the menu.

#### Show all applications

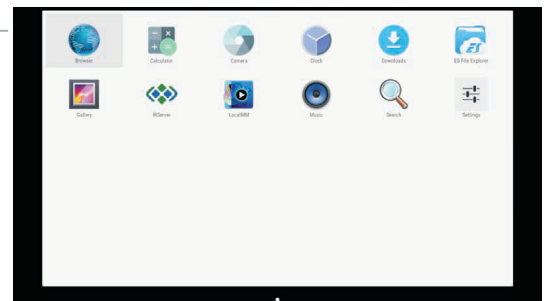

**Note:** When using the app Camera, store the data onto your connected USB device. If there is no USB store, it will be stored on the built-in storage.  
Folder's Location: go to **ES File Explorer** or **USB Drive**.

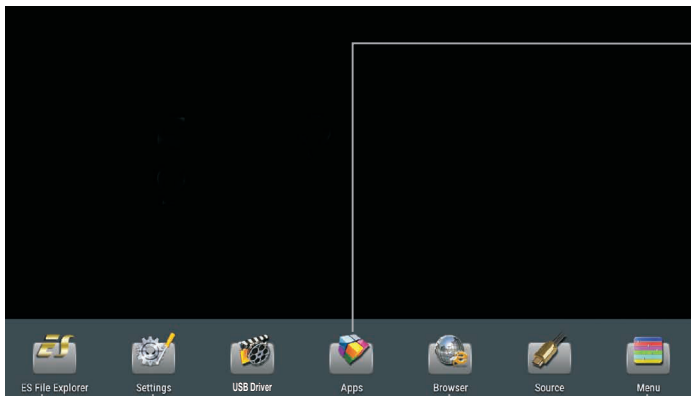

ES File Explorer

Go to your **web Browser**

Open the **System Setup** menu.

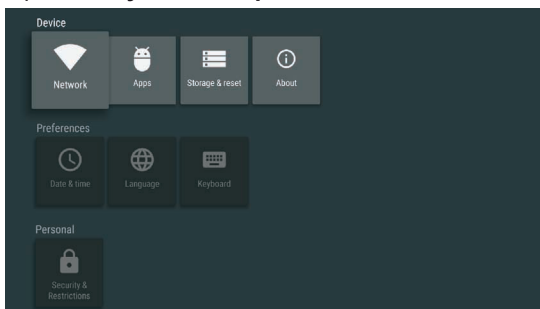

Go to your **USB multi-media player**.

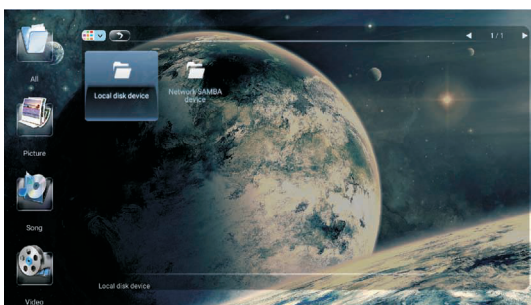

Switch to the display menu screen



Switch to different input source, i.e. HDMI, VGA, etc.

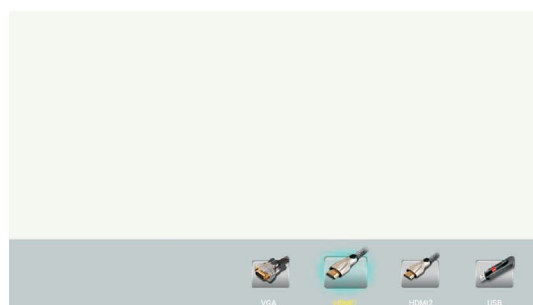

**Note:** The layout of menu may vary upon different models you purchased.

## 5. System Settings

1. Press ▲▼◀▶ button to select desktop menu option, press **OK** to confirm.
2. Press **EXIT** button to return to previous menu or exit the menu.

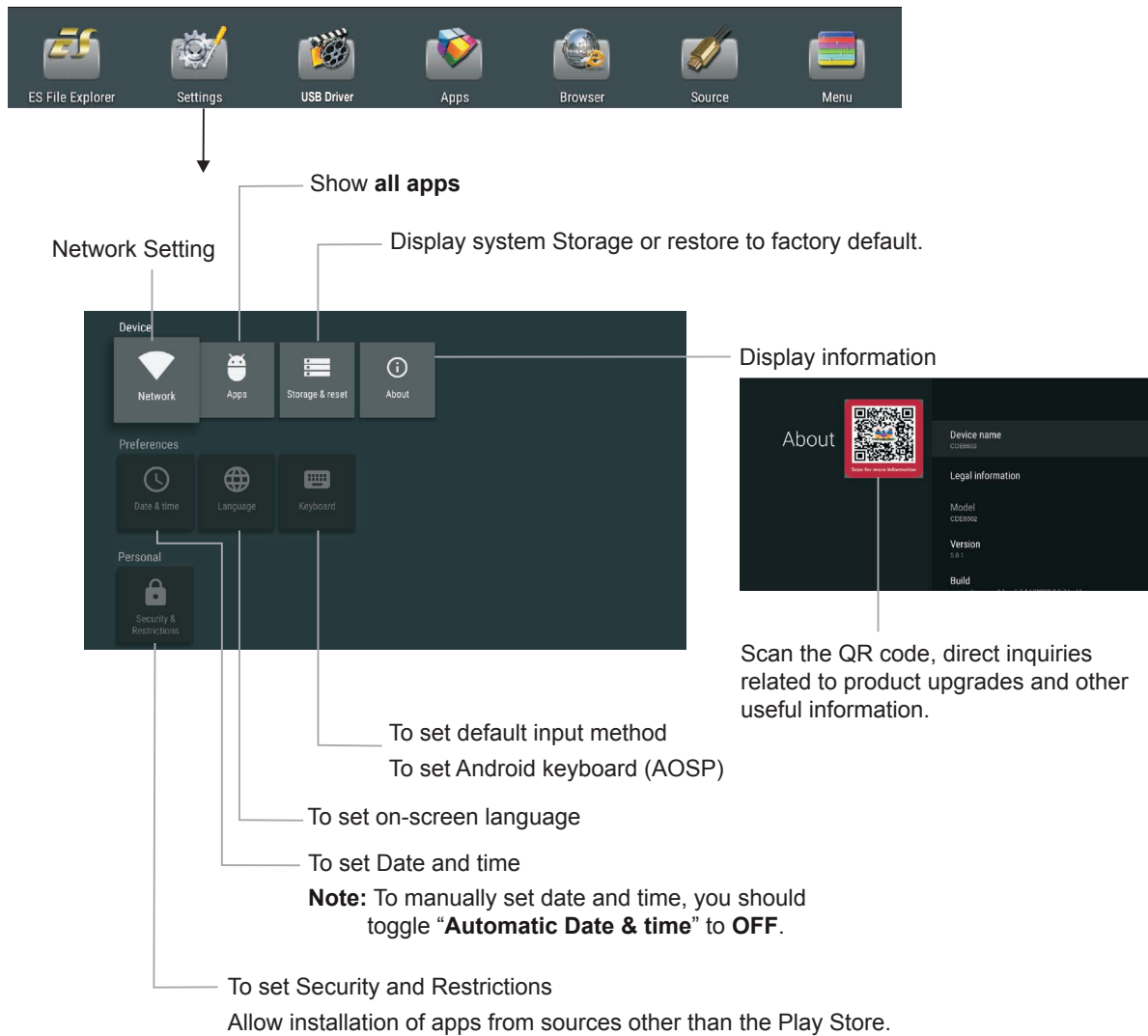

## 6. Network Settings

1. Press ▲▼◀▶ button to select desktop menu option, press OK to confirm.
2. Press EXIT button to return to previous menu or exit the menu.

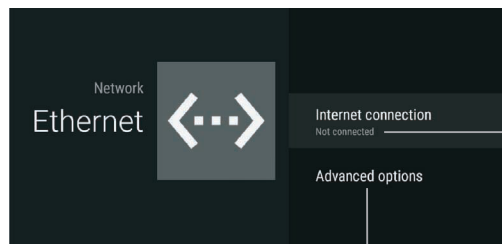
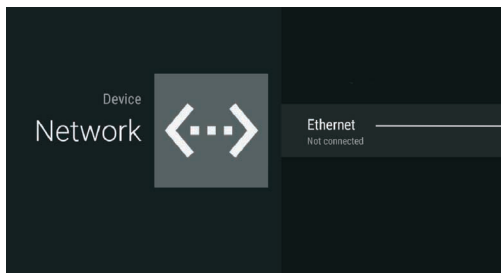
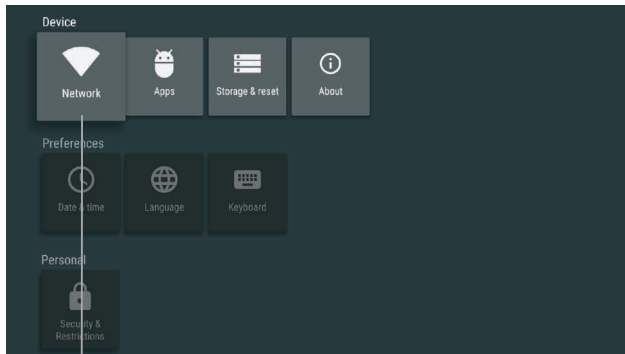

Display current net state

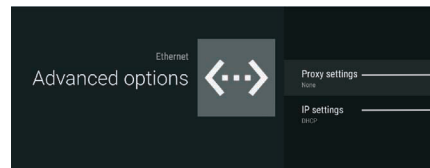

Proxy setting  
IP settings



## 7. Menu List



Picture	Picture Mode	Select your favourite picture mode for each input.	
	Contrast	Adjust the contrast.	
	Brightness	Adjust the brightness.	
	Hue	Adjust the image hue. (Only for NTSC system)	
	Sharpness	Adjust the sharpness.	
	Saturation	Adjust the color saturation.	
	Anti-Flicker	Turn on/off the Anti-Flicker function.	
	Backlight	Set up the overall brilliance of the screen. The Anti-Flicker select Off, you can set the level of the Backlight as your desired.	
	Screen	Clock	Adjust the screen size.
		Phase	Adjust the focus of stable images.
		H-Position	Move the image right or left.
		V-Position	Move the image up or down.
		Auto Tune	Automatically adjust the image settings such as position and phase.
	Color temperature	Select the color temperature.	
Bluelight Filter	Reduce the bluelight disturbance to sight, protect sight health. The Color temperature select User, you can set the level of the Bluelight Filter as your desired.		
Zoom Mode	Select the aspect ratio (display proportions) according to your video signal type or personal preference <b>[16:9]</b> / <b>[4:3]</b> / <b>[Panorama]</b> / <b>[Just Scan]</b> / <b>[Zoom1]</b> / <b>[Zoom2]</b>		
OverScan	Adjust the reproduction ratio, you may activate this function to obtain a cleaner picture.		
Image NR	Select the noise reduction mode to reduce picture noise.		



Sound	Sound Mode	Select your favourite sound mode for each input.
	Bass	Adjust Bass (low sounds).
	Treble	Adjust Treble (high sounds).
	Balance	Adjust volume level of right and left speakers.
	Surround	Turn the Surround sound effect on or off.
	Alone	Press <b>OK</b> to turn off the picture on your display and listen to the program audio only.



Setting	MHL Auto Switch	Select <b>ON</b> to automatically switch to the MHL input when it connected.	
	Menu Timeout	Select OSD menu display time.	
	Data / Time	Display Date and Time.	
	Off Timer	With Off Timer function On, the display will automatically turn off at a preset time.	
	On Timer	With On Timer function On, the display will automatically turn on at a preset source at a preset time. Highlight <b>Period</b> item, press ◀ or ▶ button to select <b>Once</b> , <b>Everyday</b> , <b>Mon.~Fri.</b> , <b>Mon.~Sat.</b> or <b>Sat.~Sun.</b>	
	Sleep Time	Set the duration of time until the display automatically goes into Standby mode. [Off] / [10 Minutes] / [20 Minutes] / [30 Minutes] / [60 Minutes] / [90 Minutes] / [120 Minutes] / [180 Minutes] / [240 Minutes].	

Select **Lock** menu, press **OK** to access the menu. Now a password is required to input. (The default password is 0000. The unit provides a super password “2580”.)

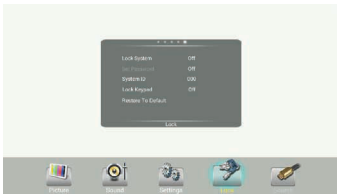

Lock	Set Password	Password settings.
	System ID	Setting the device ID. (The ID must be in the range of 0-255, but 138, 168 are unused ID.)
	Lock Keypad	The display buttons is locked. <b>OFF</b> : Select to enable the panel buttons. <b>ON</b> : Select to disable the panel buttons.
	LowerPower Standby	Set to <b>ON</b> , the display goes into lower power standby mode, turn off the picture and audio. RS232 can wake up and turn on the display.
	Restore To Default	Reset all settings to factory defaults.

## 8. Using USB multi media player

You can connect a USB storage device to your display to view compatible photo, movie or play compatible music so that the sound can be output from the display's speaker.

To use USB multi media player, please go to USB source by pressing USB button. Or you can press Home button to display Home Page and then select **USB Drive** icon to access.

### Notes:

- Never remove the USB storage device or turn off the display while using the USB storage device.
- It is recommended that you back up your USB device data.
- The USB menu may vary in different situation.
- If you want to pull out the USB device, please exit USB mode first. For instructions on using your USB device, refer to the user's manual of your USB device.
- Please name your files in English. Otherwise the file names can not be shown correctly.
- Certain types of USB device may not be compatible with this display.

### USB multi media interface introduction

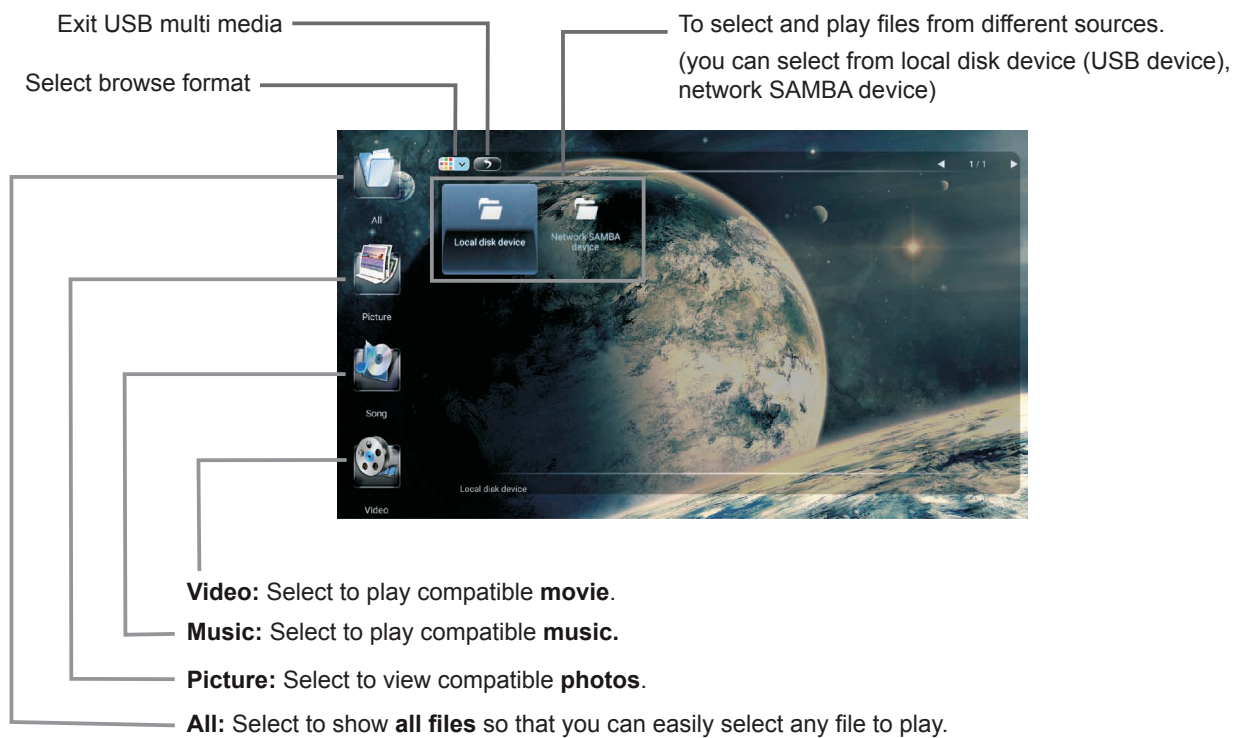

## 8.1. Playing Photo

With the photo viewer, you can view compatible photos (in JPG, BMP or PNG format). Also you can zoom, rotate photo, etc.

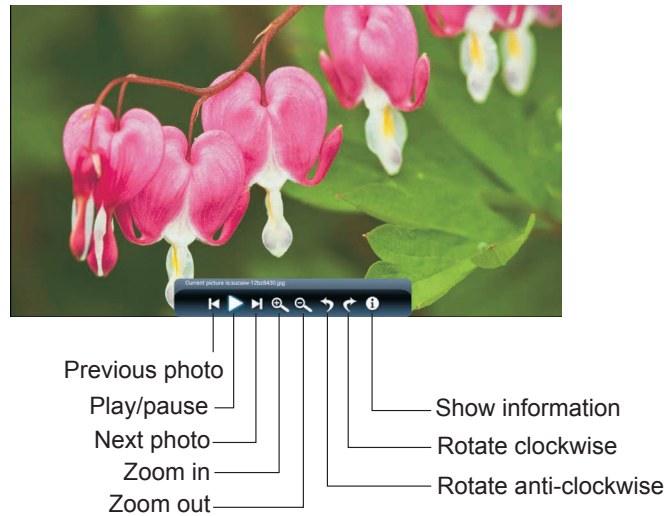

**Notes:** You can also use  $\blacktriangleleft/\blacktriangleright$  (Play/Pause),  $\blacksquare$  (STOP),  $\lll$  (Previous),  $\ggg$  (Next) on the remote control to operate.

## 8.2. Playing Music

With the USB music player, you can play compatible music (in MP3 or AAC format).

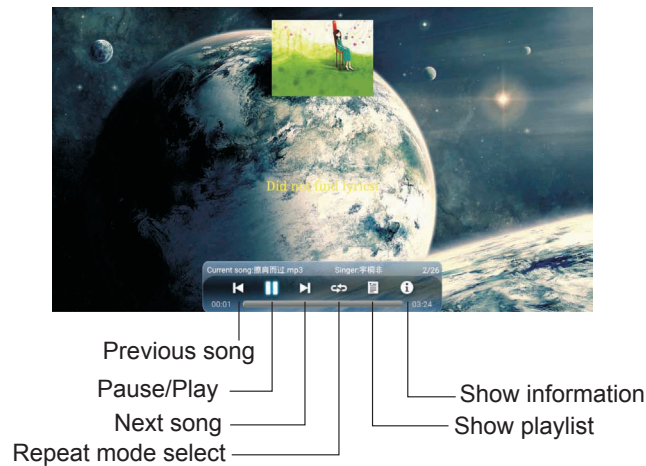

repeat to play single music, repeat to play all music files in current folder when it plays to the end, no repeat when it plays to the end.

**Notes:** You can also use  $\blacktriangleleft/\blacktriangleright$  (Play/Pause),  $\blacksquare$  (STOP),  $\lll$  (Previous),  $\ggg$  (Next) on the remote control to operate.

### 8.3. Playing Movie

With the USB movie player, you can play compatible movie (in AVI, MPG, MPEG, DAT, MP4, TS, RM/RMVB, or MKV/MOV format).

THE FOLLOWING **PREVIEW** HAS BEEN APPROVED FOR  
**ALL AUDIENCES**  
BY THE MOTION PICTURE ASSOCIATION OF AMERICA, INC.

THE FILM ADVERTISED HAS BEEN RATED  
**PG-13** PARENTS STRONGLY CAUTIONED  
SOME MATERIAL MAY BE INAPPROPRIATE FOR CHILDREN UNDER 13  
SEQUENCES OF INTENSE ACTION AND VIOLENCE

Playing: 100008C...1080p.mov 1/4 11 times speed  
00:01 01:19

Previous movie  
Fast reverse  
Play/pause  
Fast forward  
Next movie  
Adjust the volume  
AB Section repeat  
Playing settings  
Show information  
Show playlist

Skip to specific point by input time  
Current time : 00:00:20  
Total time : 00:05:53  
00:00:00

A-B Section repeat  
Section replay OFF  
Set starting point A  
Set ending point B

Now AB repeat starts.  
To cancel, highlight **Section replay** and toggle it to **OFF**.

Playing settings  
video subtitle close  
breakpoint play close  
video track  
Change Confirm Exit

## 9. Troubleshooting

If, after reading these operating instructions, you have additional questions related to the use of your display, please call the services center in your local area.

Before calling service, please check the symptoms and follow suggested solutions.

### Remote Control

Problem	Possible Solutions
Remote control does not operate	<ul style="list-style-type: none"><li>• The batteries could be weak. Replace the batteries.</li><li>• Check the orientation of the batteries.</li><li>• Make sure the power cord is plugged in.</li></ul>

### Video and Audio

Problem	Possible Solutions
No picture (screen not lit), No sound	<ul style="list-style-type: none"><li>• Make sure the power cord is plugged in.</li><li>• Press POWER on the display or on the remote control.</li></ul>
Dark, poor or no picture (Screen lit), good sound	<ul style="list-style-type: none"><li>• Select a proper picture mode.</li><li>• Adjust the brightness in the video setting.</li></ul>
No color/dark picture/abnormal color	<ul style="list-style-type: none"><li>• Adjust the color saturation in the video setting.</li></ul>
Dotted lines or stripes	<ul style="list-style-type: none"><li>• Move the display away from noise sources such as cars, neon signs, or hair dryers.</li></ul>
Good picture, no sound	<ul style="list-style-type: none"><li>• The sound may be muted. Press MUTE again to cancel.</li></ul>
Audio noise	<ul style="list-style-type: none"><li>• Communication problems may occur if infrared communication equipment (e.g., infrared cordless headphones) is used near the display. Move the infrared communication equipment away from the display until the noise is eliminated.</li></ul>

### General

Problem	Possible Solutions
Some items can't be accessed	<ul style="list-style-type: none"><li>• If a setting option appears in gray, this indicates that the settings option is unavailable in current input mode.</li></ul>
Remote control command is not effect in some cases.	<ul style="list-style-type: none"><li>• During the timing of USB device detection (i.e. when the display is turned on with USB device connected, or when you plug in USB device during display working), the display may not act by remote control buttons in such case. Wait some time, then it is OK.</li></ul>
Control buttons do not operate	<ul style="list-style-type: none"><li>• Disconnect the power cord and wait for a few seconds. Then re-plug the power cord and turn on the unit again.</li></ul>
POWER button responds slowly after power is connected.	<ul style="list-style-type: none"><li>• When you push POWER SWITCH to power on the display, in about 3 seconds the POWER button starts to respond after pressed.</li></ul>

**Note:** If your problem is not solved, turn your unit off and then on again.

**Cautions:** Never attempt to repair a defective display yourself.

## 10. Technical Specifications

### Display:

Item	Specifications
Screen Size (Active Area)	64.5" (163.9 cm) LCD
Aspect Ratio	16:9
Number of pixels	1920 (H) x 1080 (V)
Pixel pitch	0.744 (H) x 0.744 (V) [mm]
Displayable colors	1.07B colors
Brightness (typical)	350 cd/m <sup>2</sup>
Contrast ratio (typical)	4000:1
Viewing angle	178 degrees

### In/Out Terminals:

Item	Specifications
Speaker Output	Internal Speakers 10W (L) + 10W (R) [RMS]/16Ω 1 Way 1 Speaker System 82 dB/W/M/160 Hz ~ 13 KHz
Earphone Output	3.5mm phone jack x 1 5mW (Max) / 2 Channel (L+R)
Audio Input	3.5mm phone jack x 1 0.5V [rms] (Normal) / 2 Channel (L+R)
RS232C	RS232C in/RS232C out
RJ-45	RJ-45 Jack x 1 (8 pin) 10/100 LAN Port
HDMI Input	HDMI Jack x 2 (Type A) (18 pin) Digital RGB: TMDS (Video + Audio) MAX: Video - 720p, 1080p, 1920 x 1080/60 Hz (WUXGA) Audio - 48 KHz/ 2 Channel (L+R) Supports LPCM only
VGA Input	D-Sub Jack x 1 (15 pin) Analog RGB: 0.7V [p-p] (75Ω), H/CS/V: TTL (2.2kΩ), SOG: 1V [p-p] (75Ω) MAX: 720p, 1080p, 1920 x 1080/60 Hz (WUXGA)

**General:**

Item	Specifications
Power Supply	100V-240V, 50/60Hz (AC)
Power Consumption (Max)	180W
Power Consumption (typ.)	150W
Power Consumption (Standby & Off)	<0.5W
Dimensions (With Stand) [W x H x D]	1512 x 930 x 250 mm
Dimensions (Without Stand) [W x H x D]	1512 x 888 x 81 mm
Weight (With Stand)	63 Kg
Weight (Without Stand)	47 Kg
Gross Weight (Without Stand)	57 Kg

**Environmental Condition:**

Item	Specifications	
Temperature	Operational	5°C – 35°C
	Storage	-15°C – 45°C
Humidity	Operational	20 – 80 % ( no moisture condensation)
	Storage	10 – 80 %
Atmospheric pressure		86 kPa ~106 kPa

**Internal Speaker:**

Item	Specifications
Type	1 Way 1 Speaker
Input	10 W (RMS)
Impedance	8Ω
Output Sound Pressure	82 dB/W/M
Frequency Response	160 Hz ~ 13 KHz

**Note:**

1. Design and specifications are subject to change without notice.
2. Weight and dimensions shown are approximate.
3. Specifications and external appearance may be changed for the sake of improvement.



# 11. RS232 Protocol

## 11.1. Introduction

This document describes the hardware interface spec and software protocols of RS232 interface communication between ViewSonic Commercial TV / Digital Signage and PC or other control unit with RS232 protocol.

The protocol contains three sections command:

- Set-Function
- Get-Function
- Remote control pass-through mode

✘ In the document below, “PC” represents all the control units that can send or receive the RS232 protocol command.

## 11.2. Description

### 11.2.1. Hardware specification

Viewsonic TV communication port on the rear side:

- (1) Connector type: DSUB 9-Pin Male
- (2) Pin Assignment

Male DSUB 9-Pin  
(outside view)



Pin #	Signal	Remark
1	NC	
2	RXD	Input to Commercial TV or DS
3	TXD	Output from Commercial TV or DS
4	NC	
5	GND	
6	NC	
7	NC	
8	NC	
9	NC	
frame	GND	

\* Use of crossover (null modem) cable required for use with PC

[Special case]3.5mm barrel connector

Pin #	Signal	Remark
Tip	TXD	Output from Commercial TV or DS
Ring	RXD	Input to Commercial TV or DS
Sleeve	GND	

### 11.2.2. Communication Setting

- Baud Rate Select: 9600bps (fixed)
- Data bits: 8 bits (fixed)
- Parity: None (fixed)
- Stop Bits: 1 (fixed)

### 11.2.3. Command Message Reference

PC sends to Monitor command packet followed by “CR”. Every time PC sends control command to the Monitor, the Monitor shall respond as follows:

1. If the message is received correctly it will send “+” (02Bh) followed by “CR” (00Dh)
2. If the message is received incorrectly it will send “-” (02Dh) followed by “CR” (00Dh)

## 11.3. Protocol

### 11.3.1. Set-Function Listing

The PC can control the TV/DS for specific actions. The Set-Function command allows you to control the TV/DS behavior in a remote site through the RS232 port. The Set-Function packet format consists of 9 bytes.

#### Set-Function description:

<b>Length:</b>	Total Byte of Message excluding "CR".
<b>TV/DS ID</b>	Identification for each of TV/DS (01~98; default is 01) ID "99" means to apply the set command for all connected displays. Under such circumstances, only ID#1 display has to reply. The TV/DS ID can be set via the OSD menu for each TV/DS set.
<b>Command Type</b>	Identify command type, "s" (0x73h) : Set Command "+" (0x2Bh) : Valid command Reply "- " (0x2Dh) : Invalid command Reply
<b>Command:</b>	Function command code: One byte ASCII code.
<b>Value[1~3]:</b>	Three bytes ASCII that defines the value.
<b>CR</b>	0x0D

#### Set-Function format

##### Send: (Command Type="s")

Name	Length	ID	Command Type	Command	Value1	Value2	Value3	CR
Byte Count	1 Byte	2 Byte	1 Byte	1 Byte	1 Byte	1 Byte	1 Byte	1 Byte
Bytes order	1	2~3	4	5	6	7	8	9

**NOTE:** For VT2405LED-1 and VT3205LED, the set "Power on" command is the exception

##### Reply: (Command Type="+" or "-")

Name	Length	ID	Command Type	CR
Byte Count	1 Byte	2 Byte	1 Byte	1 Byte
Bytes order	1	2~3	4	5

#### NOTE:

- The reply for "Power on" command is the exception for VT2405LED-1 and VT3205LED. It's 0x322B0D ( 2+<CR>).
- When PC applies command to all displays (ID=99), only the #1 set needs to reply by the name of ID=1.

#### Example1: Set Brightness as 76 for TV-02 and this command is valid

##### Send (Hex Format)

Name	Length	ID	Command Type	Command	Value1	Value2	Value3	CR
Hex	<u>0x38</u>	<u>0x30</u> <u>0x32</u>	<u>0x73</u>	<u>0x24</u>	<u>0x30</u>	<u>0x37</u>	<u>0x36</u>	<u>0x0D</u>

##### Reply (Hex Format)

Name	Length	ID	Command Type	CR
Hex	<u>0x34</u>	<u>0x30</u> <u>0x32</u>	<u>0x2B</u>	<u>0x0D</u>

**Example2: Set Brightness as 176 for TV-02 and this command is NOT valid Send (Hex Format)**

Name	Length	ID	Command Type	Command	Value1	Value2	Value3	CR
Hex	<u>0x38</u>	<u>0x30</u> <u>0x32</u>	<u>0x73</u>	<u>0x24</u>	<u>0x31</u>	<u>0x37</u>	<u>0x36</u>	<u>0x0D</u>

**Reply (Hex Format)**

Name	Length	ID	Command Type	CR
Hex	<u>0x34</u>	<u>0x30</u> <u>0x32</u>	<u>0x2D</u>	<u>0x0D</u>

**Set function table:**

Set Function	Length	ID	Command Type	Command		Value Range (Three ASCII bytes)	Comments
				Code (ASCII)	Code (Hex)		
Power on/off (standby)	8		s	!	21	000: STBY 001: ON	Controlled power status: ON or Standby
Input Select	8		s	"	22	004 : HDMI 014 : HDMI2 006 : VGA1(PC)	1. No need for USB 2. For the case of two more same sources, the 2nd digital is used to indicate the extension.
Contrast	8		s	#	23	000 ~ 100	
Brightness	8		s	\$	24	000 ~ 100	
Sharpness	8		s	%	25	000 ~ 100	
Color	8		s	&	26	000 ~ 100	
Tint	8		s	'	27	000 ~ 100	
Color Mode	8		s	)	29	000 : Normal 001 : Warm 002 : Cold 003 : Personal	
Bass	8		s	.	2E	000 ~ 100	Sets Bass value
Treble	8		s	/	2F	000 ~ 100	Sets Treble value
Balance	8		s	0	30	000 ~ 100	Sets Balance position
Picture Size	8		s	1	31	000 : FULL 001 : NORMAL 002 : CUSTOM 003 : DYNAMIC 004 : REAL	
OSD Language	8		s	2	32	000 : English 001 : French 002 : Spanish	
Power Lock	8		s	4	34	000 : Unlock 001 : Lock	
Volume	8		s	5	35	000 ~ 100 900 : Volume down (-1) 901 : Volume up (+1)	
Mute	8		s	6	36	000: OFF 001: ON (mute)	
Button Lock	8		s	8	38	000 : Unlock 001 : Lock	

Menu Lock	8		s	>	3E	000 : Unlock 001 : Lock	
Key Pad	8		s	A	41	000 : UP 001 : DOWN 002 : LEFT 003 : RIGHT 004 : ENTER 005 : INPUT 006 : MENU/EXIT	
Remote Control	8		s	B	42	000: Disable	<b>Disable:</b> RCU has no effect on Monotor.
						001: Enable	<b>Enabled:</b> RCU controls the Monitor. This is the power up default on the Monitor.
						002: Pass through	<b>Pass through:</b> RCU has no effect on Monitor and all RCU command codes are transmitted to PC via the RS232 port.
Date	8		s	V	56	0xx: Year 1xx: Month+Day (See example in Note)	For specific models only
Time	8		s	W	57	0xx: Hour+Min 10x: Sec (See example in Note)	For specific models only
Factory reset	8		s	~	7E	0	Rests Monitor to factory setting

**NOTE:**

**1. Behavior at lock modes**

Lock Mode	Behavior
Button Lock	<ol style="list-style-type: none"> <li>1. Lock all buttons on the front panel and RCU, except for “Power”</li> <li>2. All the SET functions should be workable via RS32, even the ones with according hot key in RCU like Mute,...etc.</li> </ol>
MENU Lock	<ol style="list-style-type: none"> <li>1. Lock “MENU’ key of front panel and RCU</li> <li>2. The Factory and Hospitality modes should not be blocked for the model using MENU-combined key to enter these two modes. Alternative approach will be indicated separately if any limitation by model.</li> </ol>
POWER Lock	<ol style="list-style-type: none"> <li>1. Lock “POWER” key on the front and RCU.</li> <li>2. The SET_POWER on/off should be workable via RS232, but does not mean the POWER lock will be released under this case.</li> <li>3. Can not be unlocked by reset in OSD setting</li> <li>4. Will auto AC power-on in power-lock</li> <li>5. Under power-lock, the set will not enter power saving when no PC signal and neither not turn off when no other video signals after 15min.</li> </ol>
Remote control disable	Lock the RCU keys, but keep the front panel buttons workable.

**2. Example for value setting of SET\_TV channel DTV**

012-0: 0x 30 31 32

012-1: 0x 30 31 42

1012-2: 0x 41 31 52

1512-3: 0x 46 31 62

**3. Tiling definition of H Monitors/ V Monitors/ and Position**

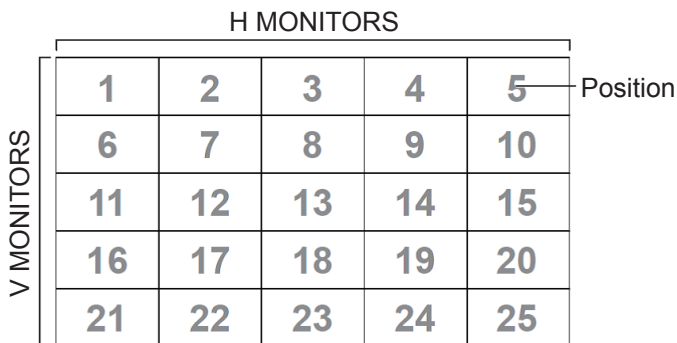

**4. Date & Time format definition**

	Value 1	Value 2	Value 3
Date	0: Year	Year code of the first 2 digis	Year code of the last 2 digis
	1: Month+Day	Month code	Day code
Time	0: Hour(24-hr format)+Min	Hour code	Minute code
	1: Sec	0	Second code

Hex code (in hex) = Original data (in dec) + 20

Date & Time	Code (ASCII)	Code (Hex)	Date & Time	Code (ASCII)	Code (Hex)	Date & Time	Code (ASCII)	Code (Hex)	Date & Time	Code (ASCII)	Code (Hex)
0	space	20	16	6	36	32	R	52	48	h	68
1	!	21	17	7	37	33	S	53	49	i	69
2	"	22	18	8	38	34	T	54	50	p	70
3	#	23	19	9	39	35	U	55	51	q	71
4	\$	24	20	@	40	36	V	56	52	r	72
5	%	25	21	A	41	37	W	57	53	s	73
6	&	26	22	B	42	38	X	58	54	t	74
7	'	27	23	C	43	39	Y	59	55	u	75
8	(	28	24	D	44	40	`	60	56	v	76
9	)	29	25	E	45	41	a	61	57	w	77
10	0	30	26	F	46	42	b	62	58	x	78
11	1	31	27	G	47	43	c	63	59	y	79
12	2	32	28	H	48	44	d	64			
13	3	33	29	I	49	45	e	65			
14	4	34	30	P	50	46	f	66			
15	5	35	31	Q	51	47	g	67			

Month: 1~12

Day: 1~31

Hour: 00~23

Min.: 00~59

Sec: 00~59

## 5. Set Date & Time example

Date: 2015-1/31

Time: 16:27:59

Send: 0x 38 30 31 73 56 30 40 35 0D (Year "20" "15")

Send: 0x 38 30 31 73 56 31 21 51 0D (Month "1", Day "31")

Send: 0x 38 30 31 73 57 30 36 47 0D (Hour "16", Min "27")

Send: 0x 38 30 31 73 57 31 30 79 0D ("0", Sec "59")

### 11.3.2. Get-Function Listing

The PC can interrogate the TV/DS for specific information. The Get-Function packet format consists of 9 bytes which is similar to the Set-Function packet structure. Note that the "Value" byte is always = 000

**Get-Function description:**

**Length:** Total Byte of Message excluding "CR".  
**TV/DS ID** Identification for each of TV/DS (01~98; default is 01).  
**Command Type** Identify command type,  
 "g" (0x67h) : Get Command  
 "r" (0x72h) : Valid command Reply  
 "-" (0x2Dh) : Invalid command Reply  
**Command:** Function command code: One byte ASCII code.  
**Value[1~3]:** Three bytes ASCII that defines the value.  
**CR** 0x0D

**Get-Function format****Send: (Command Type="g")**

Name	Length	ID	Command Type	Command	Value1	Value2	Value3	CR
Byte Count	1 Byte	2 Byte	1 Byte	1 Byte	1 Byte	1 Byte	1 Byte	1 Byte
Bytes order	1	2~3	4	5	6	7	8	9

**NOTE:** "Power STBY status" is the exception for VT2405LED-1 and VT3205LED.**Reply: (Command Type="r" or "-")***If the Command is valid, Command Type = "r"*

Name	Length	ID	Command Type	Command	Value1	Value2	Value3	CR
Byte Count	1 Byte	2 Byte	1 Byte	1 Byte	1 Byte	1 Byte	1 Byte	1 Byte
Bytes order	1	2~3	4	5	6	7	8	9

**NOTE:** The reply for "Power STBY status" command is the exception for VT2405LED-1 and V3205LED. It's 0x36 72 6C 30 30 30 0D ( 6rl000<CR>).*If the Command is Not valid, Command Type="-"*

Name	Length	ID	Command Type	CR
Byte Count	1 Byte	2 Byte	1 Byte	1 Byte
Bytes order	1	2~3	4	5

**Example1: Get Brightness from TV-05 and this comm and is valid. The Brightness value is 67.****Send (Hex Format)**

Name	Length	ID	Command Type	Command	Value1	Value2	Value3	CR
Hex	<u>0x38</u>	<u>0x30</u> <u>0x35</u>	<u>0x67</u>	<u>0x62</u>	<u>0x30</u>	<u>0x30</u>	<u>0x30</u>	<u>0x0D</u>

**Reply (Hex Format)**

Name	Length	ID	Command Type	Command	Value1	Value2	Value3	CR
Hex	<u>0x38</u>	<u>0x30</u> <u>0x35</u>	<u>0x72</u>	<u>0x62</u>	<u>0x30</u>	<u>0x36</u>	<u>0x37</u>	<u>0x0D</u>

**Example2: Get Brightness from TV-05, but the Brightness command ID is error and it is NOT in the command table.**

**Send (Hex Format)**

Name	Length	ID	Command Type	Command	Value1	Value2	Value3	CR
Hex	<u>0x38</u>	<u>0x30</u> <u>0x35</u>	<u>0x67</u>	<u>0XD3</u>	<u>0x30</u>	<u>0x30</u>	<u>0x30</u>	<u>0x0D</u>

**Reply (Hex Format)**

Name	Length	ID	Command Type	CR
Hex	<u>0x34</u>	<u>0x30</u> <u>0x35</u>	<u>0x2D</u>	<u>0x0D</u>

**Get function table:**

Get Function	Length	ID	Command Type	Command		Value Range (Three ASCII bytes)	Comments
				Code (ASCII)	Code (Hex)		
Get-Contrast	8		g	a	61	000 ~ 100	Gets Contrast value
Get-Brightness	8		g	b	62	000 ~ 100	Gets Brightness value
Get-Sharpness	8		g	c	63	000 ~ 100	Gets Sharpness value
Get-Color	8		g	d	64	000 ~ 100	Gets Color value
Get-Tint	8		g	e	65	000 ~ 100	Gets Tint value
Get-Volume	8		g	f	66	000 ~ 100	Gets Volume value
Get-Mute	8		g	g	67	000: OFF (unmuted) 001: ON (muted)	Gets Mute ON/OFF status
Get-Input select	8		g	j	6A	000~	See Set-function table
Get-Power status : ON/STBY	8		g	l	6C	000: STBY 001: ON	
Get-Remote control	8		g	n	6E	000 : Disable 001 : Enable 002 : Pass through	
Get-Power Lock	8		g	o	6F	000 : Unlock 001 : Lock	
Get-Button Lock	8		g	p	70	000 : Unlock 001 : Lock	
Get-Menu Lock	8		g	q	71	000 : Unlock 001 : Lock	
Get-ACK	8		g	z	7A	000	This command is used to test the communication link.
Get-Thermal	8		g	0	30	000~100: 0~+100 deg C -01~-99: -1~-99 deg C	For specific models only
Get-Power on/off log	8		g	1	31	000 (See below note)	For specific models only
Get-Date	8		g	2	32	000 (See the Set-Date command)	For specific models only
Get- Time	8		g	3	33	000 (See the Set-Time command)	For specific models only



**NOTE:**

1. Power on/off log data is replied as 6 sequential strings in following order.

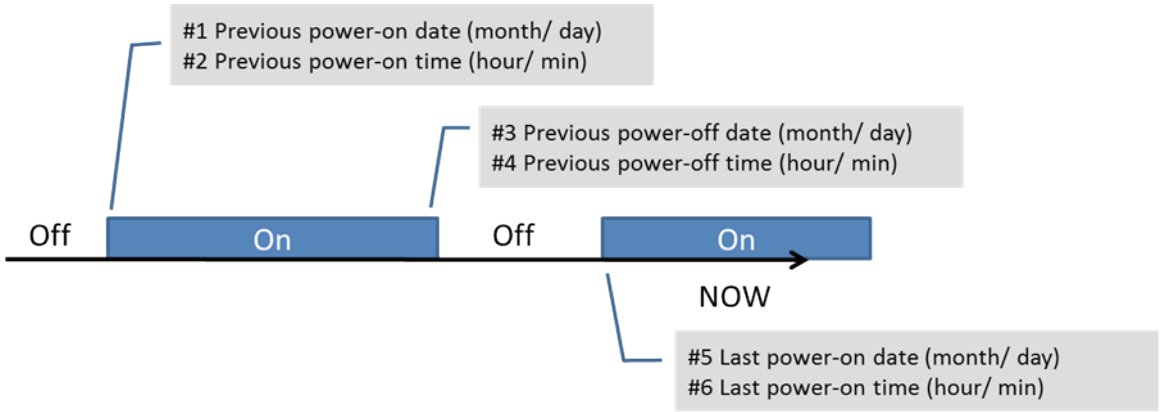

2. Time log data definition

Value 1	Value 2	Value 3
On/ Off indicator	Month code	Day code
0: Off		
1: On	Hour code	Minute code

Hex code (in hex) = Original data (in dec) + 20

Date & Time	Code (ASCII)	Code (Hex)	Date & Time	Code (ASCII)	Code (Hex)	Date & Time	Code (ASCII)	Code (Hex)	Date & Time	Code (ASCII)	Code (Hex)
0	space	20	16	6	36	32	R	52	48	h	68
1	!	21	17	7	37	33	S	53	49	i	69
2	"	22	18	8	38	34	T	54	50	p	70
3	#	23	19	9	39	35	U	55	51	q	71
4	\$	24	20	@	40	36	V	56	52	r	72
5	%	25	21	A	41	37	W	57	53	s	73
6	&	26	22	B	42	38	X	58	54	t	74
7	'	27	23	C	43	39	Y	59	55	u	75
8	(	28	24	D	44	40	`	60	56	v	76
9	)	29	25	E	45	41	a	61	57	w	77
10	0	30	26	F	46	42	b	62	58	x	78
11	1	31	27	G	47	43	c	63	59	y	79
12	2	32	28	H	48	44	d	64			
13	3	33	29	I	49	45	e	65			
14	4	34	30	P	50	46	f	66			
15	5	35	31	Q	51	47	g	67			

Month: 1~12

Day: 1~31

Hour: 00~23

Min.: 00~59

### 3. Get Time log data example

Assumed the power-on/off record of display#01 as below

2014-8/31 08:00 On

2014-8/31 22:00 Off

2014-9/1 10:30 On

2014-9/1 11:00 To send "GET-Time log" command

Send: 0x 38 30 31 67 31 30 30 30 0D

Reply:

- #1 0x 38 30 31 72 31 31 28 51 0D (On 8/31)
- #2 0x 38 30 31 72 31 31 28 20 0D (On 08:00)
- #3 0x 38 30 31 72 31 30 28 51 0D (Off 8/31)
- #4 0x 38 30 31 72 31 30 42 20 0D (Off 22:00)
- #5 0x 38 30 31 72 31 31 29 21 0D (On 9/1)
- #6 0x 38 30 31 72 31 31 30 50 0D (On 10:30)

#### 4. Get Date & Time example

Assumed the current date/time of display#01 as below

Date: 2015-1/31

Time: 16:27:59

Send: 0x 38 30 31 67 32 30 30 30 0D (Get Date)

Reply:

#1 0x 38 30 31 72 32 30 40 35 0D (Year "20" "15")

#2 0x 38 30 31 72 32 31 21 51 0D (Month "1", Day "31")

Send: 0x 38 30 31 67 33 30 30 30 0D (Get Time)

Reply:

#1 0x 38 30 31 72 33 30 36 47 0D (Hour "16", Min "27")

#2 0x 38 30 31 72 33 31 30 79 0D ("0", Sec "59")

#### 11.3.3.Remote Control Pass-through mode

When the PC sets the TV/DS to Remote Control Pass through mode, the TV/DS will send a 7-byte packet (followed by "CR") in response to RCU button activation. Note, that in this mode the RCU shall have no effect on the TV/DS function. For example: "Volume+" will not change the volume in the LCD but only sends "Volume+" code to PC over the RS232 port.

#### IR Pass Through-Function format

Reply: (Command Type="p")

Name	Length	ID	Command Type	RCU Code1 (MSB)	RCU Code2 (LSB)	CR
Byte Count	1 Byte	2 Byte	1 Byte	1 Byte	1 Byte	1 Byte
Bytes order	1	2~3	4	5	6	7

#### Example1: Remote Control pass-through when "VOL+" key is pressed for TV-05 Send (Hex Format)

Name	Length	ID	Command Type	Command	Value1	CR
Hex	<u>0x36</u>	<u>0x30</u> <u>0x35</u>	<u>0x70</u>	<u>0x31</u>	<u>0x30</u>	<u>0x0D</u>

Key	Code (HEX)
1	01
2	02
3	03
4	04
5	05
6	06
7	07
8	08
9	09
0	0A
-	0B
RECALL (LAST)	0C
INFO (DISPLAY)	0D
	0E
ASPECT (ZOOM, SIZE)	0F
VOLUME UP (+)	10
VOLUME DOWN (-)	11
MUTE	12
CHANNEL/PAGE UP (+)/ BRIGHTNESS+	13
CHANNEL/PAGE DOWN (-)/ BRIGHTNESS-	14
POWER	15
SOURCES (INPUTS)	16
	17
	18
SLEEP	19
MENU	1A
UP	1B
DOWN	1C
LEFT (-)	1D
RIGHT (+)	1E
OK (ENTER, SET)	1F
EXIT	20
	21
	22
	23
	24
	25
	26
	27
	28
	29
	2A
	2B
RED ■ (F1)	2C
GREEN ■ (F2)	2D
YELLOW ■ (F3)	2E
BLUE ■ (F4)	2F

**NOTE:**

1. This IR-pass-through code is different from the RCU key code.
2. Special control sequence for POWER key under IR-pass through mode.
  - 2-1. When TV/DS is OFF and receives the IR POWER code: TV/DS will turn itself on, then forward the POWER code to the host via RS232.
  - 2-2. When TV/DS is ON and receives the IR POWER code: TV/DS will forward the POWER code to the host via RS232, then turn off itself.
  - 2-3. When SET-POWER LOCK is enabled, the TV/DS will not respond to POWER key pressing.
3. The VOLUME UP and VOLUME DOWN code will repeatedly output when you press and hold the keys.

## 12. Other Information

### Customer Support

For technical support or product service, see the table below or contact your reseller.

**NOTE:** You will need the product serial number.

Country/Region	Website	T = Telephone C = CHAT ONLINE	Email
Australia New Zealand	www.viewsonic.com.au	AUS= 1800 880 818 NZ= 0800 008 822	service@au.viewsonic.com
Canada	www.viewsonic.com	T (Toll-Free)= 1-866-463-4775 T (Toll)= 1-424-233-2533	service.ca@viewsonic.com
Europe	www.viewsoniceurope.com	www.viewsoniceurope.com/uk/support/call-desk/	
Hong Kong	www.hk.viewsonic.com	T= 852 3102 2900	service@hk.viewsonic.com
India	www.in.viewsonic.com	T= 1800 419 0959	service@in.viewsonic.com
Korea	ap.viewsonic.com/kr/	T= 080 333 2131	service@kr.viewsonic.com
Latin America (Argentina)	www.viewsonic.com/la/	C= <a href="http://www.viewsonic.com/la/soporte/servicio-tecnico">http://www.viewsonic.com/la/soporte/servicio-tecnico</a>	soporte@viewsonic.com
Latin America (Chile)	www.viewsonic.com/la/	C= <a href="http://www.viewsonic.com/la/soporte/servicio-tecnico">http://www.viewsonic.com/la/soporte/servicio-tecnico</a>	soporte@viewsonic.com
Latin America (Columbia)	www.viewsonic.com/la/	C= <a href="http://www.viewsonic.com/la/soporte/servicio-tecnico">http://www.viewsonic.com/la/soporte/servicio-tecnico</a>	soporte@viewsonic.com
Latin America (Mexico)	www.viewsonic.com/la/	C= <a href="http://www.viewsonic.com/la/soporte/servicio-tecnico">http://www.viewsonic.com/la/soporte/servicio-tecnico</a>	soporte@viewsonic.com
Nexus Hightech Solutions, Cincinnati #40 Desp. 1 Col. De los Deportes Mexico D.F. Tel: 55) 6547-6454 55) 6547-6484 Other places please refer to <a href="http://www.viewsonic.com/la/soporte/servicio-tecnico#mexico">http://www.viewsonic.com/la/soporte/servicio-tecnico#mexico</a>			
Latin America (Peru)	www.viewsonic.com/la/	C= <a href="http://www.viewsonic.com/la/soporte/servicio-tecnico">http://www.viewsonic.com/la/soporte/servicio-tecnico</a>	soporte@viewsonic.com
Macau	www.hk.viewsonic.com	T= 853 2870 0303	service@hk.viewsonic.com
Middle East	ap.viewsonic.com/me/	Contact your reseller	service@ap.viewsonic.com
Puerto Rico & Virgin Islands	www.viewsonic.com	T= 1-800-688-6688 (English) C= <a href="http://www.viewsonic.com/la/soporte/servicio-tecnico">http://www.viewsonic.com/la/soporte/servicio-tecnico</a>	service.us@viewsonic.com soporte@viewsonic.com
Singapore/ Malaysia/ Thailand	www.viewsonic.com.sg	T= 65 6461 6044	service@sg.viewsonic.com
South Africa	ap.viewsonic.com/za/	Contact your reseller	service@ap.viewsonic.com
United States	www.viewsonic.com	T (Toll-Free)= 1-800-688-6688 T (Toll)= 1-424-233-2530	service.us@viewsonic.com

# Limited Warranty

## ViewSonic® LCD Commercial Display

### What the warranty covers:

ViewSonic warrants its products to be free from defects in material and workmanship, under normal use, during the warranty period. If a product proves to be defective in material or workmanship during the warranty period, ViewSonic will, at its sole option, repair or replace the product with a like product. Replacement product or parts may include remanufactured or refurbished parts or components.

### Who the warranty protects:

This warranty is valid only for the first consumer purchaser.

### What the warranty does not cover:

1. Any product on which the serial number has been defaced, modified or removed.
2. Damage, deterioration or malfunction resulting from:
  - a. Accident, misuse, neglect, fire, water, lightning, or other acts of nature, unauthorized product modification, or failure to follow instructions supplied with the product.
  - b. Any damage of the product due to shipment.
  - c. Removal or installation of the product.
  - d. Causes external to the product, such as electrical power fluctuations or failure.
  - e. Use of supplies or parts not meeting ViewSonic's specifications.
  - f. Normal wear and tear.
  - g. Any other cause which does not relate to a product defect.
3. Any product exhibiting a condition commonly known as "image burn-in" which results when a static image is displayed on the product for an extended period of time.
4. Removal, installation, one way transportation, insurance, and set-up service charges.

### How to get service:

1. For information about receiving service under warranty, contact ViewSonic Customer Support (Please refer to Customer Support page). You will need to provide your product's serial number.
2. To obtain warranty service, you will be required to provide (a) the original dated sales slip, (b) your name, (c) your address, (d) a description of the problem, and (e) the serial number of the product.
3. Take or ship the product freight prepaid in the original container to an authorized ViewSonic service center or ViewSonic.
4. For additional information or the name of the nearest ViewSonic service center, contact ViewSonic.

**Limitation of implied warranties:**

There are no warranties, express or implied, which extend beyond the description contained herein including the implied warranty of merchantability and fitness for a particular purpose.

**Exclusion of damages:**

ViewSonic's liability is limited to the cost of repair or replacement of the product. ViewSonic shall not be liable for:

1. Damage to other property caused by any defects in the product, damages based upon inconvenience, loss of use of the product, loss of time, loss of profits, loss of business opportunity, loss of goodwill, interference with business relationships, or other commercial loss, even if advised of the possibility of such damages.
2. Any other damages, whether incidental, consequential or otherwise.
3. Any claim against the customer by any other party.
4. Repair or attempted repair by anyone not authorized by ViewSonic.

**Effect of state law:**

This warranty gives you specific legal rights, and you may also have other rights which vary from state to state. Some states do not allow limitations on implied warranties and/or do not allow the exclusion of incidental or consequential damages, so the above limitations and exclusions may not apply to you.

**Sales outside the U.S.A. and Canada:**

For warranty information and service on ViewSonic products sold outside of the U.S.A. and Canada, contact ViewSonic or your local ViewSonic dealer.

The warranty period for this product in mainland China (Hong Kong, Macao and Taiwan Excluded) is subject to the terms and conditions of the Maintenance Guarantee Card.

For users in Europe and Russia, full details of warranty provided can be found in [www.viewsoniceurope.com](http://www.viewsoniceurope.com) under Support/Warranty Information.



# Mexico Limited Warranty

## ViewSonic® LCD Commercial Display

### What the warranty covers:

ViewSonic warrants its products to be free from defects in material and workmanship, under normal use, during the warranty period. If a product proves to be defective in material or workmanship during the warranty period, ViewSonic will, at its sole option, repair or replace the product with a like product. Replacement product or parts may include re-manufactured or refurbished parts or components.

### Who the warranty protects:

This warranty is valid only for the first consumer purchaser.

### What the warranty does not cover:

1. Any product on which the serial number has been defaced, modified or removed.
2. Damage, deterioration or malfunction resulting from:
  - a. Accident, misuse, neglect, fire, water, lightning, or other acts of nature, unauthorized product modification, or failure to follow instructions supplied with the product.
  - b. Any damage of the product due to shipment.
  - c. Removal or installation of the product.
  - d. Causes external to the product, such as electrical power fluctuations or failure.
  - e. Use of supplies or parts not meeting ViewSonic's specifications.
  - f. Normal wear and tear.
  - g. Any other cause which does not relate to a product defect.
3. Any product exhibiting a condition commonly known as "image burn-in" which results when a static image is displayed on the product for an extended period of time.
4. Removal, installation, one way transportation, insurance, and set-up service charges.

### How to get service:

For information about receiving service under warranty, contact ViewSonic Customer Support (Please refer to the attached Customer Support page). You will need to provide your product's serial number, so please record the product information in the space provided below on your purchase for your future use. Please retain your receipt of proof of purchase to support your warranty claim.

#### For Your Records

Product Name: \_\_\_\_\_

Model Number: \_\_\_\_\_

Document Number: \_\_\_\_\_

Serial Number: \_\_\_\_\_

Purchase Date: \_\_\_\_\_

Extended Warranty Purchase? \_\_\_\_\_ (Y/N)

If so, what date does warranty expire? \_\_\_\_\_

1. To obtain warranty service, you will be required to provide (a) the original dated sales slip, (b) your name, (c) your address, (d) a description of the problem, and (e) the serial number of the product.
2. Take or ship the product in the original container packaging to an authorized ViewSonic service center.
3. Round trip transportation costs for in-warranty products will be paid by ViewSonic.

### Limitation of implied warranties:

There are no warranties, express or implied, which extend beyond the description contained herein including the implied warranty of merchantability and fitness for a particular purpose.

### Exclusion of damages:

ViewSonic's liability is limited to the cost of repair or replacement of the product. ViewSonic shall not be liable for:

1. Damage to other property caused by any defects in the product, damages based upon inconvenience, loss of use of the product, loss of time, loss of profits, loss of business opportunity, loss of goodwill, interference with business relationships, or other commercial loss, even if advised of the possibility of such damages.
2. Any other damages, whether incidental, consequential or otherwise.
3. Any claim against the customer by any other party.
4. Repair or attempted repair by anyone not authorized by ViewSonic.

<b>Contact Information for Sales &amp; Authorized Service (Centro Autorizado de Servicio) within Mexico:</b>	
<b>Name, address, of manufacturer and importers:</b> México, Av. de la Palma #8 Piso 2 Despacho 203, Corporativo Interpalmas, Col. San Fernando Huixquilucan, Estado de México Tel: (55) 3605-1099 <a href="http://www.viewsonic.com/la/soporte/index.htm">http://www.viewsonic.com/la/soporte/index.htm</a>	
<b>NÚMERO GRATIS DE ASISTENCIA TÉCNICA PARA TODO MÉXICO: 001.866.823.2004</b>	
<b>Hermosillo:</b> Distribuciones y Servicios Computacionales SA de CV. Calle Juarez 284 local 2 Col. Bugambillas C.P: 83140 Tel: 01-66-22-14-9005 E-Mail: <a href="mailto:disc2@hmo.megared.net.mx">disc2@hmo.megared.net.mx</a>	<b>Villahermosa:</b> Compumantenimietnos Garantizados, S.A. de C.V. AV. GREGORIO MENDEZ #1504 COL, FLORIDA C.P. 86040 Tel: 01 (993) 3 52 00 47 / 3522074 / 3 52 20 09 E-Mail: <a href="mailto:compumantenimientos@prodigy.net.mx">compumantenimientos@prodigy.net.mx</a>
<b>Puebla, Pue. (Matriz):</b> RENTA Y DATOS, S.A. DE C.V. Domicilio: 29 SUR 721 COL. LA PAZ 72160 PUEBLA, PUE. Tel: 01(52).222.891.55.77 CON 10 LINEAS E-Mail: <a href="mailto:datos@puebla.megared.net.mx">datos@puebla.megared.net.mx</a>	<b>Veracruz, Ver.:</b> CONEXION Y DESARROLLO, S.A DE C.V. Av. Americas # 419 ENTRE PINZÓN Y ALVARADO Fracc. Reforma C.P. 91919 Tel: 01-22-91-00-31-67 E-Mail: <a href="mailto:gacosta@qplus.com.mx">gacosta@qplus.com.mx</a>
<b>Chihuahua</b> Soluciones Globales en Computación C. Magisterio # 3321 Col. Magisterial Chihuahua, Chih. Tel: 4136954 E-Mail: <a href="mailto:Cefeo@soluglobales.com">Cefeo@soluglobales.com</a>	<b>Cuernavaca</b> Compusupport de Cuernavaca SA de CV Francisco Leyva # 178 Col. Miguel Hidalgo C.P. 62040, Cuernavaca Morelos Tel: 01 777 3180579 / 01 777 3124014 E-Mail: <a href="mailto:aquevedo@compusupportcva.com">aquevedo@compusupportcva.com</a>
<b>Distrito Federal:</b> QPLUS, S.A. de C.V. Av. Coyoacán 931 Col. Del Valle 03100, México, D.F. Tel: 01(52)55-50-00-27-35 E-Mail : <a href="mailto:gacosta@qplus.com.mx">gacosta@qplus.com.mx</a>	<b>Guadalajara, Jal.:</b> SERVICRECE, S.A. de C.V. Av. Niños Héroes # 2281 Col. Arcos Sur, Sector Juárez 44170, Guadalajara, Jalisco Tel: 01(52)33-36-15-15-43 E-Mail: <a href="mailto:mmiranda@servicrece.com">mmiranda@servicrece.com</a>
<b>Guerrero Acapulco</b> GS Computación (Grupo Sesicomp) Progreso #6-A, Colo Centro 39300 Acapulco, Guerrero Tel: 744-48-32627	<b>Monterrey:</b> Global Product Services Mar Caribe # 1987, Esquina con Golfo Pérsico Fracc. Bernardo Reyes, CP 64280 Monterrey N.L. México Tel: 8129-5103 E-Mail: <a href="mailto:aydeem@gps1.com.mx">aydeem@gps1.com.mx</a>
<b>MÉRIDA:</b> ELECTROSER Av Reforma No. 403Gx39 y 41 Mérida, Yucatán, México CP97000 Tel: (52) 999-925-1916 E-Mail: <a href="mailto:rrrb@sureste.com">rrrb@sureste.com</a>	<b>Oaxaca, Oax.:</b> CENTRO DE DISTRIBUCION Y SERVICIO, S.A. de C.V. Murguía # 708 P.A., Col. Centro, 68000, Oaxaca Tel: 01(52)95-15-15-22-22 Fax: 01(52)95-15-13-67-00 E-Mail: <a href="mailto:gpotai2001@hotmail.com">gpotai2001@hotmail.com</a>
<b>Tijuana:</b> STD Av Ferrocarril Sonora #3780 L-C Col 20 de Noviembre Tijuana, Mexico	<b>FOR USA SUPPORT:</b> ViewSonic Corporation 14035 Pipeline Ave. Chino, CA 91710, USA Tel: 800-688-6688 (English); 866-323-8056 (Spanish); E-Mail: <a href="http://www.viewsonic.com">http://www.viewsonic.com</a>



**ViewSonic®**