

QSFP-100G-ESR4-S-AO

Cisco® QSFP-100G-ESR4-S Compatible TAA Compliant 100GBase-SR4 QSFP28 Transceiver (MMF, 850nm, 300m, MPO, DOM)

Features

- SFF-8665 Compliance
- MPO Connector
- Commercial Temperature 0 to 70 Celsius
- Multi-mode Fiber
- Hot Pluggable
- Excellent ESD Protection
- Metal with Lower EMI
- RoHS Compliant and Lead Free

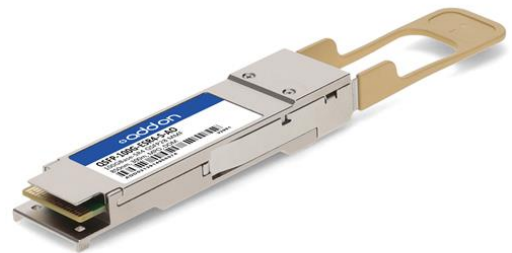

Applications

- 100GBase Ethernet
- Access and Enterprise

Product Description

This Cisco® QSFP-100G-ESR4-S compatible QSFP28 transceiver provides 100GBase-SR4 throughput up to 300m over OM4 multi-mode fiber (MMF) using a wavelength of 850nm via an MPO connector. It is guaranteed to be 100% compatible with the equivalent Cisco® transceiver. This easy to install, hot swappable transceiver has been programmed, uniquely serialized and data-traffic and application tested to ensure that it will initialize and perform identically. Digital optical monitoring (DOM) support is also present to allow access to real-time operating parameters. This transceiver is Trade Agreements Act (TAA) compliant. We stand behind the quality of our products and proudly offer a limited lifetime warranty.

AddOn's transceivers are RoHS compliant and lead-free.

TAA refers to the Trade Agreements Act (19 U.S.C. & 2501-2581), which is intended to foster fair and open international trade. TAA requires that the U.S. Government may acquire only "U.S. – made or designated country end products."



Absolute Maximum Ratings

Parameter	Symbol	Min.	Typ.	Max.	Unit
Storage Ambient Temperature	T _{stg}	-40	+100		°C
Relative Humidity - Storage	RH _s	0	95		%
Relative Humidity - Operating	RH _o	0	85		%
Module Supply Voltage	V _{CC}	-0.5	3.6		V

Notes:

- Exceeding the Absolute Maximum Ratings may cause irreversible damage to the device. The device is not intended to be operated under the condition of simultaneous Absolute Maximum Ratings, a condition which may cause irreversible damage to the device.

Recommended Operating Conditions

Parameter	Symbol	Min.	Typ.	Max.	Unit
Case Operating Temperature	T _{case}	0	+25	+70	°C
Module Supply Voltage	V _{CC}	3.14	3.3	3.46	V
Module Supply Current	I _{IN}		540		mA
Signaling Speed Per Channel	S		25.78		Gb/s

Notes:

- Temperature Range = C

Electrical Interfaces

Parameter	Symbol	Min.	Typ.	Max.	Unit	Notes
Transmitter						
Tx_Data Differential Input Voltage	V _{IN}	200		900	mV	
Tx_Data Differential Input Impedance	Z _{IN}		100		Ω	
Differential Input Return Loss	SDD11	Compatible with IEEE P802.3bm			dB	1
Differential to Common Mode Conversion Loss	SCD11	10			dB	1
Receiver						
Rx_Data Differential Output Voltage	V _{OUT}		480		mV	
Rx_Data Differential Output Impedance	Z _{OUT}		100		Ω	
Differential Output Return Loss		Per IEEE P802.3bm			dB	1
Common Mode Output Return Loss		Per IEEE P802.3bm			dB	1

Notes:

- 10MHz to 19GHz

Optical Characteristics

Parameter	Symbol	Min.	Typ.	Max.	Unit	Notes
Transmitter						
Average Launch Power, each lane	POUT	-8.4	-	2.4	dBm	1
Optical modulation Amplitude, each lane	OMA	-6.4	-	3	dBm	
Extinction Ratio	ER	2	-	-	dB	
Optical Output with Tx OFF	POFF	-	-	-30	dBm	
Center Wavelength	λ	840	850	860	nm	
RMS Spectral Width	$\Delta\lambda$	-	-	0.6	nm	
Optical return loss tolerance	ORL	-	-	12	dB	
Transmitter eye mask margin (Hit ratio 1.5×10^{-3} hits per sample)		5	-	-	%	
Receiver						
Average power at receive input, each lane	P_{IN}	-	-	2.4	dBm	
Unstressed receiver sensitivity, each lane (max)	Sen	-	-	-7.2	dBm	2
Center Wavelength	λ	840	850	860	nm	
Receiver Reflectance	RFL	-	-	-12	dB	
Rx_LOS of Signal - Assert	P_A	-30	-	-	dBm	
Rx_LOS of Signal - Deassert	P_D	-	-	-7.5	dBm	
Rx_LOS of Signal - Hysteresis	P_{Hy}	0.5	-	-	dB	

Notes:

1. Average Optical Output
2. Average received power where the BER = 5×10^{-5} , measured with a PRBS $2^{31}-1$ test pattern@25.78Gb/s

Block Diagram

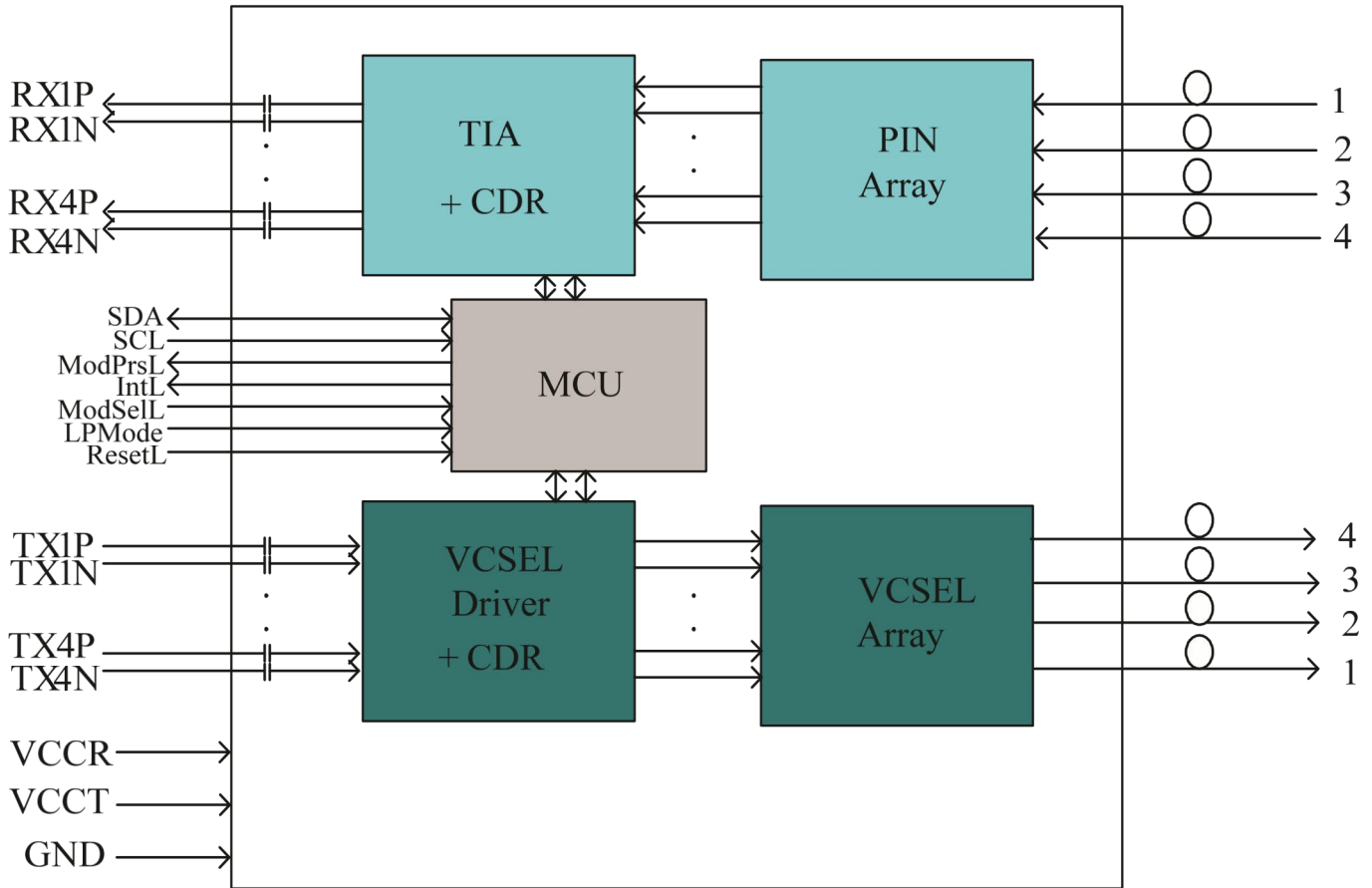

QSFP Monitoring Interface

Monitoring is available on the QSFP28 AOC modules. A 2-wire serial interface provides user to contact with module. The module provides real-time per channel received power monitoring (optional), per channel transmitted laser bias current monitoring, supply voltage and temperature monitoring.

The memory is structured as a single address, multiple page approach. The address is given as A0h. The structure of the memory is shown in followed figure. The memory space is arranged into a lower, single page, address space of 128 bytes and multiple upper address space pages of 128 bytes each. This structure permits timely access to addresses in the lower page, e.g. Interrupt Flags and Monitors. Less time critical entries, e.g. serial ID information and threshold settings are available with the Page Select function.

2-Wire Serial Address: 1010000x

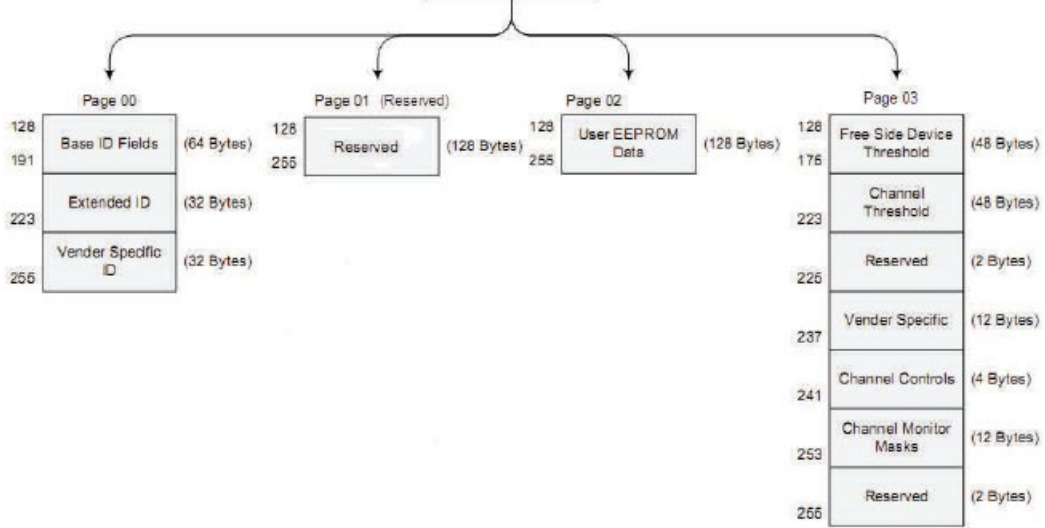
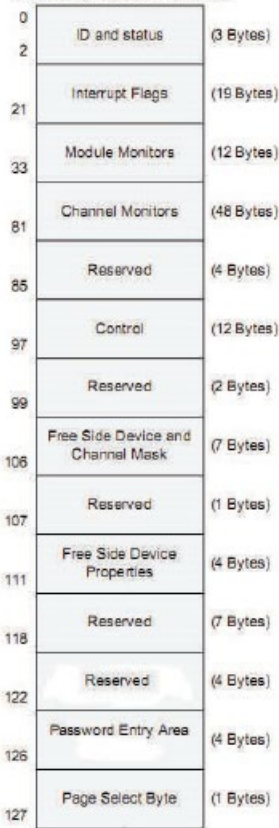

I²C Memory Map (Upper memory map Page00-Serial ID: Data Fields, Unlisted Fields are Blank / Empty)

IIC Addr	Size (byte)	Name	Description	Values (HEX)
128	1	Identifier	Identifier Type of serial Module	11
129	1	Ext. Identifier	Extended Identifier of Serial Module	CC
130	1	Connector	Code for connector type	0C
131-138	8	Specification compliance	Code for electronic compatibility or optical compatibility	80 00 00 00 40 40 02 08
139	1	Encoding	Code for serial encoding algorithm	05
140	1	BR, nominal	Nominal bit rate, units of 100 Mbps	FF
141	1	Extended rate select	Tags for extended rate select compliance	00
142	1	Length (SMF)	Link length supported for SMF fiber in km (note 1)	00
143	1	Length (OM3 50 um)	Link length supported for EBW 50/125 um fiber (OM3), units of 2m (note 1)	00
144	1	Length (OM2 50 um)	Link length supported for 50/125 um fiber (OM2), units of 1m (note 1)	00
145	1	Length (OM1 62.5 um)	Link length supported for 62.5/125 um fiber (OM1), units of 1m (note 1)	00
146	1	Length (Copper/AOC)	Link length of copper or active cable, units of 1 m	96
147	1	Device tech	Device technology	00
148-163	16	Vendor name	QSFP+ vendor name (ASCII)	"Hisense "
164	1	Extended Module	Extended Module codes for Module	10
165-167	3	Vendor OUI	QSFP+ vendor IEEE company ID	AC_4A_FE
168-183	16	Vendor PN	Part number provided by QSFP+ vendor (ASCII)	LTA8532-PC+
184-185	2	Vendor rev	Revision level for part number provided by vendor (ASCII)	01
186-187	2	Wave length	Nominal laser wavelength (wavelength=value/20 in nm)	42 68
188-189	2	Wavelength tolerance	Guaranteed range of laser wavelength(+/-value) from nominal wavelength. (wavelength Tol. =value/200 in nm)	07 D0
190	1	Max case temp.	Maximum case temperature in degrees C	46
191	1	CC_BASE	Check code for base ID fields (addresses 128-190)	00
192-195	4	Options	Rate Select, TX Disable, TX Fault, LOS, Warning indicators for: Temperature, VCC, RX power, TX Bias	02 07 C8 98
196-211	16	Vendor SN	Serial number provided by vendor (ASCII)	Programmed by Factory
212-219	8	Date Code	Vendor's manufacturing date code	Programmed by Factory
220	1	Monitoring Type	Indicates which types of monitoring are implemented (if any) in the Module. Bit 1,0 Reserved	0C
221	1	Enhanced Options	Indicates which optional enhanced features are implemented in the Module.	00
222	1	BR,nominal	Units of 250M	67
223	1	CC_EXT	Check code for the Extended ID Fields (addresses 192-222)	
224-255	32	Vendor Specific EEPROM		

I²C Memory Map (Module and Channel Thresholds)

IIC Addr	Byte	Name	Description	Values
128-129	2	Case temp High Alarm (°C)	MSB at low address	80
130-131	2	Case temp Low Alarm (°C)	MSB at low address	-10
132-133	2	Case temp High Warning (°C)	MSB at low address	75
134-135	2	Case temp Low Warning (°C)	MSB at low address	-5
136-143	8	Reserved	MSB at low address	
144-145	2	Vcc High Alarm (V)	MSB at low address	3.63
146-147	2	Vcc Low Alarm (V)	MSB at low address	2.97
148-149	2	Vcc High Warning (V)	MSB at low address	3.465
150-151	2	Vcc Low Warning (V)	MSB at low address	3.135
152-159	8	Reserved		
160-175	16	Reserved		
176-177	2	RX Power High Alarm (dBm)	MSB at low address	5.4
178-179	2	RX Power Low Alarm (dBm)	MSB at low address	-13.3
180-181	2	RX Power High Warning (dBm)	MSB at low address	2.4
182-183	2	RX Power Low Warning (dBm)	MSB at low address	-10.3
184-185	2	Tx Bias High Alarm (mA)	MSB at low address	12
186-187	2	Tx Bias Low Alarm (mA)	MSB at low address	0
188-189	2	Tx Bias High Warning (mA)	MSB at low address	10
190-191	2	Tx Bias Low Warning (mA)	MSB at low address	0
192-193	2	TX Power High Alarm (dBm)	MSB at low address	5.4
194-195	2	TX Power Low Alarm (dBm)	MSB at low address	-11.4
196-197	2	TX Power High Warning (dBm)	MSB at low address	2.4
198-199	2	TX Power Low Warning (dBm)	MSB at low address	-8.4

Pin Assignment

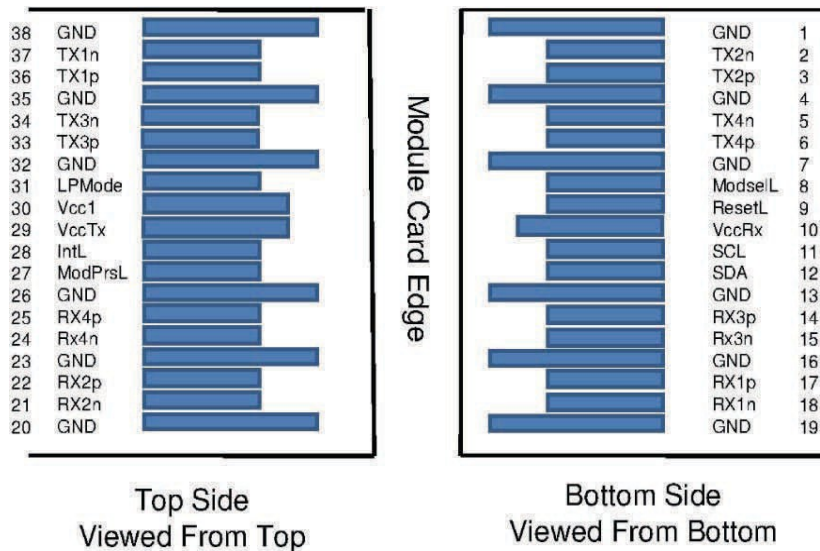

Pin Descriptions

Pin	Symbol	Name/Descriptions	Ref.
1	GND	Ground	
2	Tx2n	Transmitter Inverted Data Input	
3	Tx2p	Transmitter Non Inverted Data Input	
4	GND	Ground	
5	Tx4n	Transmitter Inverted Data Input	
6	Tx4p	Transmitter Non Inverted Data Input	
7	GND	Ground	
8	ModselL	Module Select	
9	ResetL	Module Reset	
10	V _{CC} Rx	Receiver +3.3V DC Power Supply	
11	SCL	I ² C Serial Clock	
12	SDA	I ² C Serial Data	
13	GND	Ground	
14	Rx3p	Receiver Non Inverted Differential Output	
15	Rx3n	Receiver Inverted Differential Output	
16	GND	Ground	
17	Rx1p	Receiver Non Inverted Differential Output	
18	Rx1n	Receiver Inverted Differential Output	
19	GND	Ground	
20	GND	Ground	
21	Rx2n	Receiver Inverted Differential Output	
22	Rx2p	Receiver Non Inverted Differential Output	
23	GND	Ground	
24	Rx4n	Receiver Inverted Differential Output	
25	Rx4p	Receiver Non Inverted Differential Output	
26	GND	Ground	
27	ModPrsL	Module Present	
28	IntL	Interrupt	
29	V _{CC} Tx	Transmitter +3.3V DC Power Supply	
30	V _{CC1}	+3.3V DC Power Supply	
31	LPMoD	Low Power Mode	
32	GND	Ground	
33	Tx3p	Transmitter Non Inverted Data Input	
34	Tx3n	Transmitter Inverted Data Input	
35	GND	Ground	
36	Tx1p	Transmitter Non Inverted Data Input	
37	Tx1n	Transmitter Inverted Data Input	
38	GND	Ground	

Electrical Interface

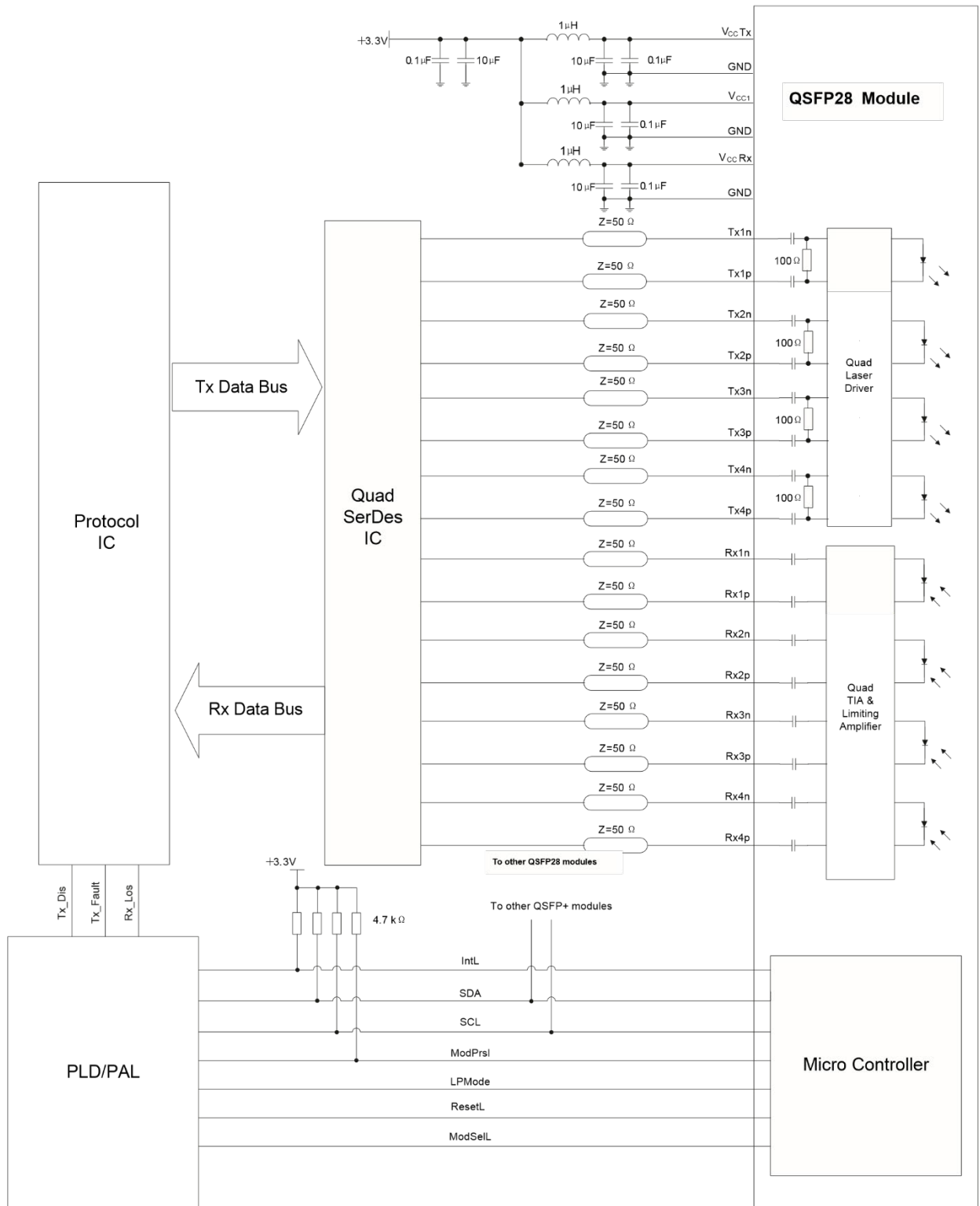

Mechanical Dimensions

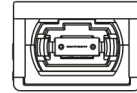
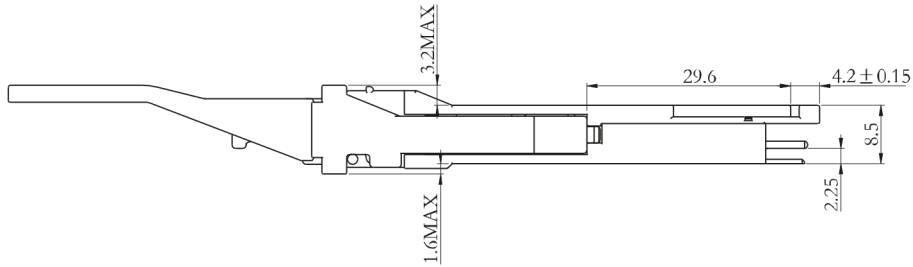
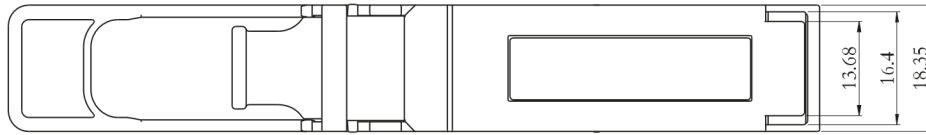

Plug hidet

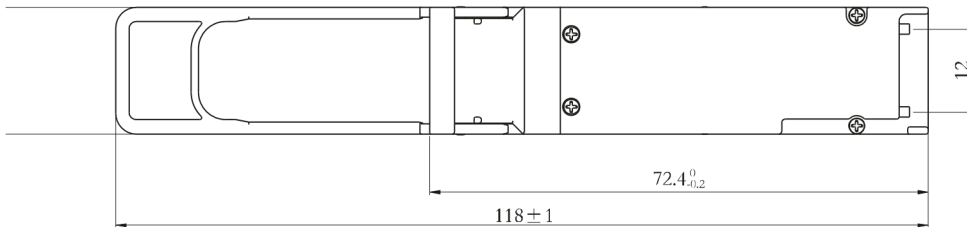

Dimensions are mm
Tolerance is ± 0.1 mm
Others according to MSA Drawir

Warnings

Handling Precautions:

This device is susceptible to damage as a result of electrostatic discharge (ESD). A static free environment is highly recommended. Follow guidelines according to proper ESD procedures.

Laser Safety:

Radiation emitted by laser devices can be dangerous to human eyes. Avoid eye exposure to direct or indirect radiation.

About AddOn Networks

In 1999, AddOn Networks entered the market with a single product. Our founders fulfilled a severe shortage for compatible, cost-effective optical transceivers that compete at the same performance levels as leading OEM manufacturers. Adhering to the idea of redefining service and product quality not previously had in the fiber optic networking industry, AddOn invested resources in solution design, production, fulfillment, and global support.

Combining one of the most extensive and stringent testing processes in the industry, an exceptional free tech support center, and a consistent roll-out of innovative technologies, AddOn has continually set industry standards of quality and reliability throughout its history.

Reliability is the cornerstone of any optical fiber network and is engrained in AddOn's DNA. It has played a key role in nurturing the long-term relationships developed over the years with customers. AddOn remains committed to exceeding industry standards with certifications from ranging from NEBS Level 3 to ISO 9001:2005 with every new development while maintaining the signature reliability of its products.

U.S. Headquarters

Email: sales@addonnetworks.com

Telephone: +1 877.292.1701

Fax: 949.266.9273

Europe Headquarters

Email: salesupportemea@addonnetworks.com

Telephone: +44 1285 842070