



HP DesignJet Z2600 PostScript® Printer
HP DesignJet Z5600 PostScript® Printer

User guide

Edition 1

© Copyright 2016 HP Development Company, L.P.

Legal notices

The information contained herein is subject to change without notice.

The only warranties for HP products and services are set forth in the express warranty statement accompanying such products and services. Nothing herein should be construed as constituting an additional warranty. HP shall not be liable for technical or editorial errors or omissions contained herein.



IPv6-ready

Trademarks

Adobe®, Acrobat®, Adobe Photoshop® and Adobe® PostScript® 3™ are trademarks of Adobe Systems Incorporated.

ENERGY STAR and the ENERGY STAR mark are registered U.S. trademarks.

Microsoft® and Windows® are U.S. registered trademarks of Microsoft Corporation.

PANTONE® is Pantone, Inc.'s check-standard trademark for color.

Table of contents

1 Introduction	1
Safety precautions	2
HP Start-Up Kit	3
Using this document	3
The printer's main features	5
The printer's main components	6
The front panel	9
Printer software	10
Web Services	11
Turn the printer on and off	11
The printer's internal prints	12
2 Installing the software	13
Choose which connection method to use	14
Connect the printer to your network	14
Connect a computer to the printer by network (Windows)	15
Uninstall the printer software (Windows)	16
Connect a computer to the printer by network (Mac OS X)	16
Uninstall the printer software (Mac OS X)	18
Set up one-click printing with HP DesignJet Click Printing Software	18
3 Setting up the printer	19
Introduction	20
Set up your Web-connected printer	20
Web Services manual configuration	20
Paper suitability options	22
Turn nesting on and off	22
Turn usage information on and off	23
Turn email notifications on and off	24
Turn alerts on and off (Windows only)	24
Control access to the printer	24
Require account ID	26
Set Windows driver preferences	26

4 Personalizing the printer	27
Change the language of the front-panel display	28
Access the HP DesignJet Utility	28
Access the Embedded Web Server	28
Change the language of the HP DesignJet Utility	29
Change the language of the Embedded Web Server	29
Change the sleep mode setting	29
Turn the buzzer on and off	29
Change the front-panel display brightness	29
Change the units of measurement	29
Configure network settings	30
Change the graphic language setting	31
Manage Printer security	31
Change your printer's email address	31
5 Paper handling	32
General advice	33
Load a roll onto the spindle	33
Load a roll into the printer	35
Unload a roll	38
Load a single sheet	39
Unload a single sheet	40
Sensitive-paper mode	42
View information about the paper	42
Paper presets	43
Printing paper info	45
Move the paper	46
Maintain paper	46
Change the drying time	46
Turn the automatic cutter on and off	46
Feed and cut the paper	47
6 Working with two rolls (Z5600 only)	48
The uses of a multiroll printer	48
How the printer allocates jobs to paper rolls	48
7 Printing	50
Introduction	51
Print from a USB flash drive	51
Print from a computer using the Embedded Web Server or HP DesignJet Utility	52
Print from a computer using a printer driver	53
Advanced print settings	54

8 Web-connected printing	65
Print by email	65
9 Job queue management	66
The job queue in the front panel	66
The job queue in the Embedded Web Server or HP DesignJet Utility	69
10 Color management	73
Introduction	74
How colors are represented	74
A summary of the color management process	74
Color calibration	74
Color management from printer drivers	76
Color management from the printer driver	78
Color management from the Embedded Web Server	79
Color management from the front panel	81
11 Practical printing examples	82
Print a draft for revision with the correct scale	83
Print a document with the correct colors	83
Print a project	88
Print a presentation	91
Print and scale from Microsoft Office	95
12 Retrieving printer usage information	97
Get printer accounting information	98
Check usage statistics	98
Check usage statistics for a job	98
Request accounting data by email	99
13 Handling ink cartridges and printheads	101
About the ink cartridges	102
Check the ink cartridges status	102
Remove an ink cartridge	102
Insert an ink cartridge	104
About the printheads	105
Check the printhead status	105
Remove a printhead	105
Insert a printhead	108
14 Maintaining the printer	111
Check printer status	112
Clean the exterior of the printer	112

Maintain the ink cartridges	112
Move or store the printer	112
Update the firmware	113
Update the software	114
Printer maintenance kits	114
Secure Disk Erase	114
15 Accessories	116
How to order supplies and accessories	117
Introduction to the accessories	121
16 Troubleshooting paper issues	122
The paper cannot be loaded successfully	123
The paper type is not in the driver	124
The printer printed on the wrong paper type	125
Automatic cut not available	126
On hold for paper	126
The roll paper will not advance	127
The paper has jammed	127
A strip stays on the output tray and generates jams	130
The printer displays out of paper when paper is available	131
Prints do not fall neatly into the basket	131
The sheet stays in the printer when the print has been completed	131
The paper is cut when the print has been completed	131
The cutter does not cut well	131
The roll is loose on the spindle	131
Recalibrate the paper advance	132
17 Troubleshooting print-quality issues	134
General advice	135
Print quality troubleshooting wizard	135
Horizontal lines across the image (banding)	136
Thin vertical lines across the image	137
The whole image is blurry or grainy	137
The paper is not flat	137
The print is scuffed or scratched	138
Ink marks on the paper	138
Black ink comes off when you touch the print	139
Edges of objects are stepped or not sharp	139
Edges of objects are darker than expected	140
Bronzing	140
Horizontal lines at the end of a cut sheet print	140
Vertical lines of different colors	140

White spots on the print	140
Colors are inaccurate	141
The image is incomplete (clipped at the bottom)	142
The image is clipped	142
Some objects are missing from the printed image	143
Lines are too thick, too thin or missing	143
Lines appear stepped or jagged	144
Lines print double or in the wrong colors	144
Lines are discontinuous	144
Lines are blurred	145
Line lengths are inaccurate	145
The Image Diagnostics Print	146
If you still have a problem	148
18 Troubleshooting ink cartridge and printhead issues	149
Cannot insert an ink cartridge	150
Ink cartridge status messages	150
Cannot insert a printhead	150
The front-panel display recommends reseating or replacing a printhead	150
Clean the printheads	151
Clean the printhead drop detector	151
Align the printheads	153
Printhead status messages	155
19 Troubleshooting general printer issues	156
The printer will not start	157
The printer does not print	157
The printer seems slow	157
Communication failures between computer and printer	158
Cannot access the HP DesignJet Utility	158
Cannot access the Embedded Web Server	158
Cannot connect to the Internet	159
Web Services issues	159
Automatic file system check	159
Alerts	160
20 Front-panel error messages	161
The system error log	163
21 HP Customer Care	164
Introduction	165
HP Professional Services	165
HP Proactive Support	166

Customer Self Repair	166
Contact HP Support	166
22 Printer specifications	168
Functional specifications	169
Physical specifications	170
Memory specifications	170
Power specifications	171
Ecological specifications	171
Environmental specifications	171
Acoustic specifications	171
Glossary	172
Index	175

1 Introduction

- [Safety precautions](#)
- [HP Start-Up Kit](#)
- [Using this document](#)
- [The printer's main features](#)
- [The printer's main components](#)
- [The front panel](#)
- [Printer software](#)
- [Web Services](#)
- [Turn the printer on and off](#)
- [The printer's internal prints](#)

Safety precautions

Follow at all times the precautions and warnings below to use the printer safely. Do not carry out any operations or procedures other than as described in this document, because doing so may result in death, serious personal injuries, or fire.

Mains connection

- Use the power-supply voltage specified on the label. Avoid overloading the printer's electrical outlet with multiple devices. Doing so can cause a fire or an electric shock hazard.
- Ensure that the printer is well grounded. Failure to ground the printer may result in electric shock, fire, and susceptibility to electromagnetic interference.
- Use only the electrical cord supplied by HP with the printer. Do not damage, cut, or repair the power cord. A damaged power cord can cause fire or electric shock. Replace a damaged power cord with an HP-approved power cord.
- Insert the power cord securely and completely into the wall socket and printer inlet. A poor connection can cause a fire or an electric shock hazard.
- Never handle the power cord with wet hands. Doing so may cause an electric shock hazard.
- Observe all warnings and instructions marked on the product.

Printer operation

- Do not allow metal or liquids (except those used in HP Cleaning Kits) to touch the internal parts of the printer. Doing so may cause fire, electric shock, or other serious hazards.
- Never insert your hand into the printer while it is printing. Moving parts inside the printer may cause injuries.
- Ventilation measures for your location, whether office, copy room, or printer room, should meet local environmental health and safety (EHS) guidelines and regulations.
- Unplug the product from the wall before cleaning.

Printer servicing

- There are no operator-serviceable parts inside the product. Refer servicing to qualified service personnel; see [Contact HP Support on page 166](#).
- Do not disassemble or repair the printer yourself. There are hazardous voltages inside the printer that can cause a fire or electric shock hazard.
- Internal fan blades are hazardous moving parts. Disconnect the printer before servicing.

Caution

Turn off the printer and unplug the power cord from the power outlet in any of the following cases:

- There is smoke or an unusual smell coming from the printer
- The printer is making an unusual noise not heard during normal operation
- A piece of metal or a liquid (not part of cleaning and maintenance routines) touches internal parts of the printer
- During a thunderstorm
- During a power failure

- The power cord or plug is damaged
- The printer has been dropped
- The printer is not operating normally

HP Start-Up Kit

The HP Start-Up Kit is the DVD that comes with your printer; it helps you to download the printer's software and documentation from the Internet. You need an active Internet connection for this purpose.

Using this document

This document can be downloaded from <http://www.hp.com/go/Z2600/manuals> or <http://www.hp.com/go/Z5600/manuals>.

Introduction

This chapter provides a brief introduction to the printer and its documentation for new users.

Use and maintenance

These chapters help you carry out normal printer procedures and include the following topics.

- [Installing the software on page 13](#)
- [Setting up the printer on page 19](#)
- [Personalizing the printer on page 27](#)
- [Paper handling on page 32](#)
- [Working with two rolls \(Z5600 only\) on page 48](#)
- [Printing on page 50](#)
- [Web-connected printing on page 65](#)
- [Job queue management on page 66](#)
- [Color management on page 73](#)
- [Practical printing examples on page 82](#)
- [Retrieving printer usage information on page 97](#)
- [Handling ink cartridges and printheads on page 101](#)
- [Maintaining the printer on page 111](#)

Troubleshooting

These chapters help you solve problems that may occur while printing and include the following topics.

- [Troubleshooting paper issues on page 122](#)
- [Troubleshooting print-quality issues on page 134](#)
- [Troubleshooting ink cartridge and printhead issues on page 149](#)

- [Troubleshooting general printer issues on page 156](#)
- [Front-panel error messages on page 161](#)

Accessories, support and specifications

The chapters [Accessories on page 116](#), [HP Customer Care on page 164](#), and [Printer specifications on page 168](#) contain reference information, including customer care, the printer specifications and part numbers for paper types, ink supplies and accessories.

Glossary

The [Glossary on page 172](#) contains definitions of printing and HP terms used in this documentation.

Index

In addition to the table of contents, there is an alphabetical index to help you to find topics quickly.

Warnings and Cautions

The following symbols are used in this manual to ensure the proper use of the printer and to prevent the printer from being damaged. Follow the instructions marked with these symbols.

 **WARNING!** Failure to follow the guidelines marked with this symbol could result in serious personal injury or death.

 **CAUTION:** Failure to follow the guidelines marked with this symbol could result in minor personal injury or damage to the printer.

The printer's main features

Your printer is a color inkjet printer designed for printing high-quality images on paper up to 610 mm (24 in) wide in the Z2600 printer, or up to 1118 mm (44 in) wide in the Z5600 printer. Some major features of the printer are shown below:

- Print resolution of up to 2400 × 1200 optimized dpi, from a 1200 × 1200 dpi input, using the **Best** print-quality option, the **Maximum Detail** option and photo paper
- The printer can be controlled from its front panel or from a remote computer using the Embedded Web Server or the HP DesignJet Utility
- Touch-sensitive front panel in color, with an intuitive graphical user interface
- Job previews in the front panel
- Job previews on remote computers
- Includes Web-connected features such as automatic firmware updates and HP email printing
- Driverless printing: Files in common graphical formats can be printed directly without needing a printer driver. Just insert a USB flash drive or use the printer's Embedded Web Server.
- Paper flexibility and automatic easy load, see [Paper handling on page 32](#), with information and presets accessible from the front panel and the HP DesignJet Utility
- Handles cut-sheet and roll paper
- Six-ink system
- Accurate and consistent color reproduction with automatic color calibration
- Economode for printing economically
- Two rolls loaded at once (Z5600 only) provide fast and easy switching between different rolls, or long runs of unattended printing
- High productivity features such as job previewing and nesting using HP DesignJet Click Printing Software or the printer's Embedded Web Server
- Ink and paper usage information available from the Embedded Web Server, see [Access the Embedded Web Server on page 28](#)
- Access to the online HP Support Center (see [HP Support Center on page 165](#))

The printer's main components

The following front and rear views of the printer illustrate the main components.

Front view

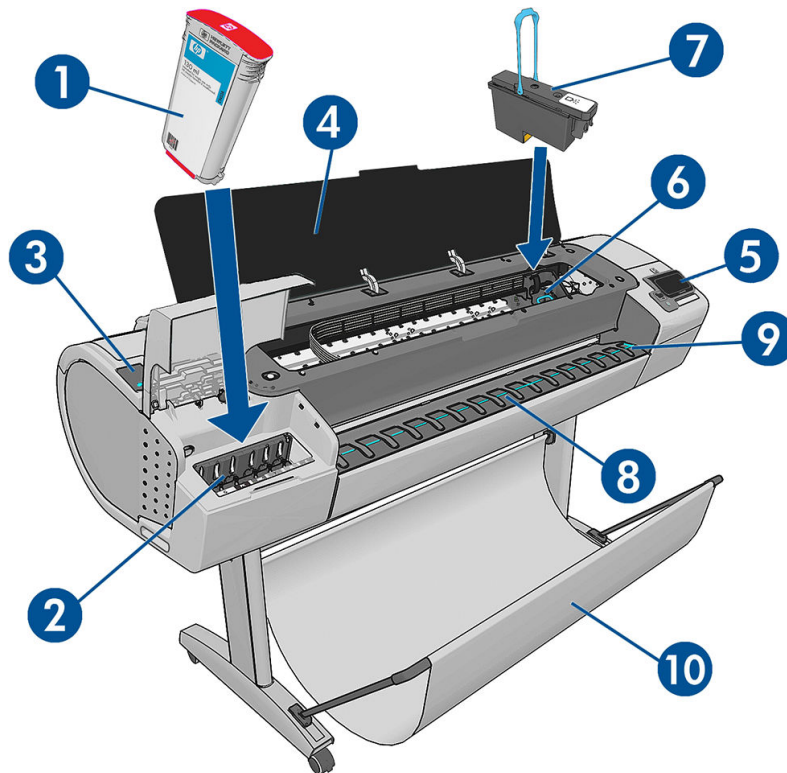

1. Ink cartridge
2. Ink cartridge slots
3. Blue lever
4. Window
5. Front panel
6. Printhead carriage
7. Printhead
8. Output tray
9. Paper alignment lines
10. Basket

Rear view

 **NOTE:** This illustration shows the Z5600.

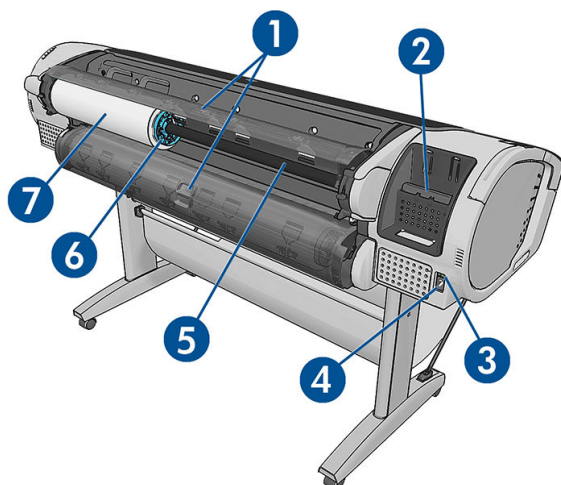

1. Roll cover
2. Communication ports
3. Power switch
4. Power socket
5. Spindle
6. Spindle stop
7. Paper roll

 **NOTE:** The upper roll is roll 1 and the lower roll is roll 2.

Communication ports

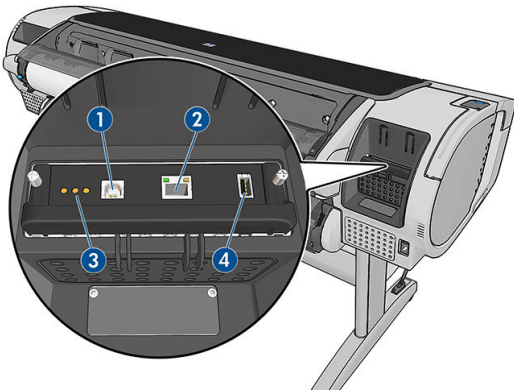

1. Hi-Speed USB device port, not available in Z2600 or Z5600
2. Gigabit Ethernet port, to connect to a network
3. Diagnostic LEDs, to be used by service engineers
4. Hi-Speed USB host port, intended for connecting an accessory

There is another Hi-Speed USB host port on the other side of the printer, beside the front panel, intended for connecting a USB flash drive.

The wall spacers

If you place the printer with its back against a wall, lower the two wall spacers at the rear of the printer to ensure that the rear of the printer is a minimum distance from the wall. Otherwise, you may experience paper advance problems.

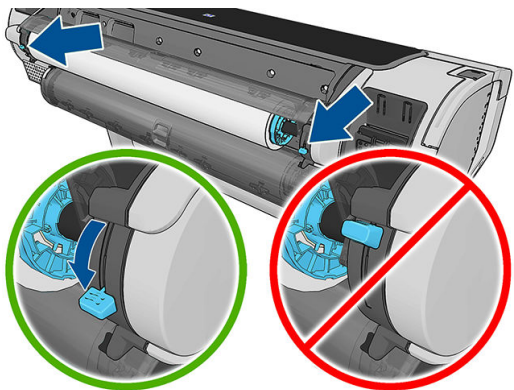

The front panel

The front panel is located on the front right of the printer. It gives you complete control of your printer: from the front panel, you can print, view information about the printer, change printer settings, perform calibrations and tests, and so on. The front panel also displays alerts (warning and error messages) when needed.









1. A Hi-Speed USB host port, intended for connecting a USB flash drive, which can provide files to be printed. When a USB flash drive is inserted, a USB icon  is displayed on the front panel's home screen.
2. The front panel itself: a touch-sensitive screen with a graphical user interface.
3. The **Power** key, with which you can turn the printer on or off. The key is illuminated when the printer is on. It flashes when the printer is in transition between on and off.









The front panel has a large central area to display dynamic information and icons. On the left and right sides you can see up to six fixed icons at different times. Normally they are not all displayed at the same time.



Left and right fixed icons

- Press  to return to the home screen.
- Press  to view help about the current screen.
- Press  to go to the previous item.
- Press  to go to the next item.
- Press  to go back to the previous screen. This does not discard any changes made in the current screen.
- Press  to cancel the current process.

Home screen dynamic icons

The following items are displayed only on the home screen.

- Press  to view information about printer status, change printer settings, or initiate actions such as loading paper or replacing ink supplies. A smaller warning icon appears if there are actions that need to be performed.
- To the right of the above button is a message showing the printer status or the most important current alert. Press this message to see a list of all current alerts, with an icon indicating the severity of each alert.
- Press  to display the printer's email address. You can send files to that address to print them.
- Press  to print a file from a USB flash drive. See [Printing on page 50](#).
- Press  to view information about the USB flash drive(s). This icon appears only when one or more USB flash drives are inserted.
- Press  to view and manage the job queue. A smaller warning icon appears if there are jobs on hold. See [Job queue management on page 66](#).
- While a PostScript or PDF job is printing, the Adobe PDF icon  is displayed; pressing it has no effect.

If the printer is left idle for some time, it goes into sleep mode and switches off the front-panel display. To change the time that elapses before sleep mode, press , then , then **Setup > Front panel options > Sleep mode wait time**. You can set a time between 1 and 240 minutes; the default time is 20 minutes.

The printer wakes from sleep mode and switches on the front-panel display whenever there is some external interaction with it.

Information about specific uses of the front panel can be found throughout this document.

Printer software

The following software is provided with your printer:

- PostScript, PCL3, and HP-GL/2 drivers for Windows
- PostScript and PCL3 drivers for Mac OS X
- The Embedded Web Server and (alternatively) the HP DesignJet Utility allow you to:
 - Manage the printer from a remote computer
 - View the status of the ink cartridges, the printheads and the paper
 - Access the HP Support Center, see [HP Support Center on page 165](#)
 - Update the printer's firmware, see [Update the firmware on page 113](#)
 - Perform calibrations and troubleshooting
 - Submit print jobs

- Manage the job queue, see [Job queue management on page 66](#)
- View job accounting information, see [Retrieving printer usage information on page 97](#)
- Change various printer settings
- Manage email notifications
- Change permissions and security settings

See [Access the Embedded Web Server on page 28](#) and [Access the HP DesignJet Utility on page 28](#).

 **NOTE:** New versions of all printer software can be expected to appear from time to time. In some cases, when you receive your printer there may already be later versions available on HP's website of some of the software provided with it.

Web Services

Your printer can be connected to the Web, providing various benefits:

- Automatic firmware updates (see [Update the firmware on page 113](#))
- Print to your printer by sending it an email message with the file to be printed as an attachment. PDF, TIFF, and JPG files are supported.

To take advantage of these benefits, your printer must be connected to the Internet.

For the latest information, see <http://www.hpconnected.com>.

Turn the printer on and off

 **TIP:** The printer can be left powered on without wasting energy. Leaving it on improves response time and overall system reliability. When the printer has not been used for a certain period of time (the default time is determined by Energy Star), it saves power by going into sleep mode. However, any interaction with the printer's front-panel display, or sending a new job to print, returns it to active mode, and it can resume printing immediately. To change the sleep mode time, see [Change the sleep mode setting on page 29](#).

 **NOTE:** In sleep mode, the printer performs maintenance service to the printheads from time to time. This avoids long preparation times after long idle periods. Therefore, it is strongly recommended to leave the printer powered on or in sleep mode to avoid wasting ink and time.

If you wish to turn the printer on or off or reset the printer, the normal and recommended method is to use the **Power** key on the front panel.

However, if you plan to store the printer for a long period or the **Power** key does not seem to work, you are recommended to turn it off using the power switch at the rear.

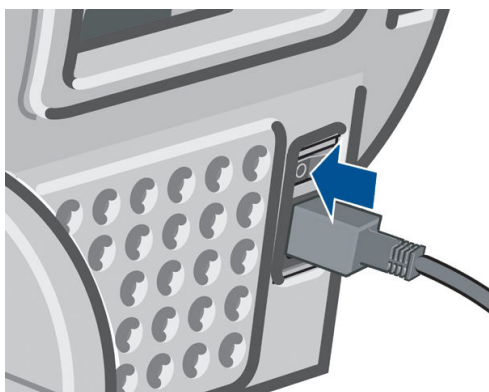

To turn it back on, use the power switch at the rear.



When the printer is powered back on, it takes about three minutes to initialize and check and prepare the printheads. Preparing the printheads takes about 75 seconds. However, if the printer has been off for six weeks or more, preparing the printheads could take up to 45 minutes.

The printer's internal prints

The internal prints give various kinds of information about your printer. They can be requested from the front panel.

Before requesting any internal print, check that the printer and the paper are ready for printing.

- The loaded paper should be at least A3 landscape—420 mm (16.53in) wide—otherwise the print may be clipped.
- The front panel should be displaying the **Ready** message.

To print any internal print, press , then , then scroll down to **Internal prints** and press it, then select the internal print you want. The following internal prints are available.

- **Demo prints** (show some of the capabilities of the printer):
 - **Print fine arts demo**
 - **Print retail demo 1**
 - **Print retail demo 2**
 - **Print drawing demo**
 - **Print GIS map**
- **User information prints:**
 - **Print usage report:** Shows estimates of the total number of prints, number of prints by paper type, number of prints by print-quality option and total amount of ink used per color (the accuracy of these estimates is not guaranteed)
 - **Print HP-GL/2 palette:** Shows the color or grayscale definitions in the currently selected color palette
 - **Print PS font list:** Shows PostScript fonts available
- **Service information print:** Provides information needed by service engineers

2 Installing the software

- [Choose which connection method to use](#)
- [Connect the printer to your network](#)
- [Connect a computer to the printer by network \(Windows\)](#)
- [Uninstall the printer software \(Windows\)](#)
- [Connect a computer to the printer by network \(Mac OS X\)](#)
- [Uninstall the printer software \(Mac OS X\)](#)
- [Set up one-click printing with HP DesignJet Click Printing Software](#)

Choose which connection method to use

The following methods can be used to connect your printer.



Connection type	Speed	Cable length	Other factors
Gigabit Ethernet	Very fast; varies according to network traffic	Long: 100 m (328 ft)	Requires extra equipment (switches)
Jetdirect print server (optional accessory)	Moderate; varies according to network traffic	Long: 100 m (328 ft)	Requires extra equipment (switches) Provides additional features See http://www.hp.com/go/jetdirect for more details

 **NOTE:** The printer provides a single RJ-45 connector port for a network connection. In order to meet Class A limits, the use of shielded I/O cables is required.



 **NOTE:** The speed of any network connection depends on all components used in the network, which can include network interface cards, routers, switches and cables. If any one of these components cannot operate at high speed, you will have a low-speed connection. The speed of your network connection can also be affected by the total amount of traffic from other devices on the network.



Connect the printer to your network



The printer is able to configure itself automatically for most networks, in a similar way to any computer in the same network. The first time you connect it to a network, this process may take a few minutes.

Once the printer has a working network configuration, you can check its network address from the front panel: press , then .

Network configuration

For more details about the current network configuration, go to the front panel and press , then , then **Connectivity > Network connectivity > Gigabit Ethernet > Modify configuration**; or, for Jetdirect, **Connectivity > Network connectivity > Jetdirect EIO > Modify configuration**. From here it is possible, though not normally necessary, to change the settings manually; this can also be done remotely using the Embedded Web Server or the HP DesignJet Utility.

 **TIP:** You may find it helpful to print out the full printer network configuration on paper. This can be done from the front panel: press , then , then **Internal prints > Service information prints > Print connectivity config**. If you do not print out the full network configuration, consider making a note of the printer's IP address and network name.

If you accidentally misconfigure the printer's network settings, you can restore the network settings to their factory values from the front panel: press , then , then **Connectivity > Network connectivity > Gigabit Ethernet > Restore factory settings**; or, for Jetdirect, **Connectivity > Network connectivity > Jetdirect EIO > Restore factory settings**. Then you must restart the printer. This automatically provides a working network configuration for most networks. The printer's other settings remain unchanged.

Using IPv6

Your printer supports almost all network connectivity features using IPv6, just as it does using IPv4. To make full use of IPv6, you may need to connect your printer to an IPv6 network in which there are IPv6 routers and servers.

In most IPv6 networks, the printer will configure itself automatically as follows, and no user configuration is necessary:

1. The printer assigns itself a link-local IPv6 address (which starts with “fe80::”).
2. The printer assigns itself stateless IPv6 addresses as indicated to it by any IPv6 routers on the network.
3. If no stateless IPv6 addresses can be assigned, the printer will try to obtain IPv6 addresses using DHCPv6. It will also do so if the routers instruct it to do so.

The stateless and DHCPv6 IPv6 addresses can be used to access the printer, and in most IPv6 networks this will be appropriate.

The link-local IPv6 address works only in the local subnet. Although it is possible to access the printer using this address, it is not recommended.

It is possible to assign a manual IPv6 address to the printer, using the front panel or the Embedded Web Server. It is also possible to disable IPv6 completely in the printer. However, it is not possible to disable IPv4 in the printer, and therefore it is not possible to configure the printer as IPv6-only.

 **NOTE:** In typical IPv6 use, your printer will have multiple IPv6 addresses, although it has only one IPv4 address.

 **TIP:** You will generally find it easier to use IPv4 unless you have a specific need to use IPv6.

Most of the current PC operating systems and HP printing and imaging devices have IPv6 enabled by default.

Using IPSec

Your printer supports IPSec.

However, successful IPSec configuration requires advanced network expertise, and is beyond the scope of this document. For IPSec to work, the printer's IPSec configuration must exactly match that of the other devices in your network. Any discrepancy will prevent communication with your printer until the configuration is corrected or IPSec is disabled. For more information on IPSec configuration, download the file **IPsec_Admin_Guide.pdf** from <http://www.hp.com/go/Z2600/manuals> or <http://www.hp.com/go/Z5600/manuals>.

Connect a computer to the printer by network (Windows)

The following instructions apply if you intend to print from software applications using a printer driver. See [Printing on page 50](#) for alternative ways of printing.

Before you begin, check your equipment:

- The printer should be set up and on.
- The Ethernet switch or router should be on and functioning correctly.
- The printer and the computer should be connected to the network (see [Connect the printer to your network on page 14](#)).

Now you can proceed to install the printer software and connect to your printer.

Printer software installation

1. Make a note of the printer's IP address from the front panel (see [Access the Embedded Web Server on page 28](#)).
2. Insert the HP Start-up Kit DVD into your computer.
3. In the window that opens on your screen, click **Download**. You will be taken to the HP DesignJet Z2600 and Z5600 drivers webpage.



4. In your Web browser, select Windows or Mac OS X software, then choose which specific software you want to install (by default, all of it).

The drivers can also be downloaded from <http://www.hp.com/go/Z2600-Z5600/drivers>.

If your computer fails to find any printers on the network, the **Printer Not Found** window is displayed, which helps you to try to find your printer. If you have a firewall in operation; you may have to disable it temporarily in order to find the printer. You also have the options of searching for the printer by its hostname, IP address, or MAC address.

In some cases, when the printer is not in the same sub-net as the computer, specifying the printer's IP address may be the only successful option.

Uninstall the printer software (Windows)

Use the Control Panel to uninstall the software, in the same way as you can uninstall any other software.

Connect a computer to the printer by network (Mac OS X)

You can connect your printer to a network under Mac OS X by using the following methods:

- Bonjour
- TCP/IP

 **NOTE:** The printer does not support AppleTalk.

The following instructions apply if you intend to print from software applications using a printer driver. See [Printing on page 50](#) for alternative ways of printing.

Before you begin, check your equipment:

- The printer should be set up and on.
- The Ethernet switch or router should be on and functioning correctly.
- The printer and the computer should be connected to the network (see [Connect the printer to your network on page 14](#)).

Now you can proceed to install the printer software and connect to your printer.

Bonjour or TCP/IP connection

1. Go to the front panel and press . Note the mDNS service name of your printer.
2. Insert the HP Start-up Kit DVD into your computer.
3. Open the DVD icon on your desktop.
4. In the window that opens on your screen, click **Download**. You will be taken to the HP DesignJet Z2600 and Z5600 drivers webpage.

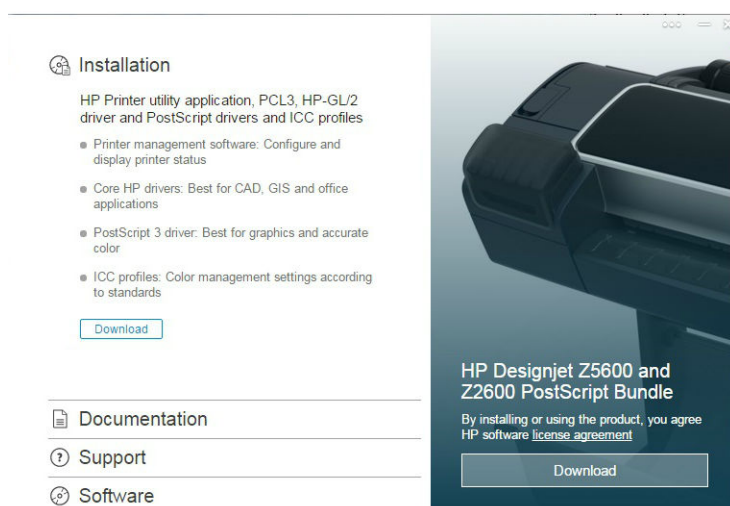

5. In your Web browser, select Windows or Mac OS X software, then choose which specific software you want to install (by default, all of it).
6. When the software has been installed, the HP DesignJet Utility Setup Assistant starts automatically, to set up a connection to your printer. Follow the instructions on your screen.
7. When you reach the Add Device screen, look for your printer's mDNS service name (which you noted in step 1) in the Printer Name column.

If you find the right name, scroll sideways if necessary to see the Connection Type column, and check that it shows **Bonjour**. Then highlight that line. Otherwise, continue searching further down the list.

Click **Continue**.

8. Continue following the instructions on the screen. Click **Go back** to return to the Add Device screen if you want to connect another printer to the network. When you reach the Summary screen, click **Done** to exit.
9. When the HP DesignJet Utility Setup Assistant has finished, you can remove the DVD from the computer.

If the printer driver is already installed, the HP DesignJet Utility Setup Assistant can be run at any time from the DVD.

The drivers can also be downloaded from <http://www.hp.com/go/Z2600-Z5600/drivers>.

Uninstall the printer software (Mac OS X)

During the installation procedure, you have the option to install the HP Uninstaller application in your system. This should be available under HP in the system Applications folder.

 **IMPORTANT:** The HP Uninstaller application will uninstall all HP software installed in your system.

To delete the print queue only, select the **Print & Scan** dialog from the system preferences. Select the name of the printer and click the **-** button.

Set up one-click printing with HP DesignJet Click Printing Software

During software installation, you have the option to download HP DesignJet Click Printing Software. Available for both Windows and Mac OS X, this application radically simplifies the printing experience.

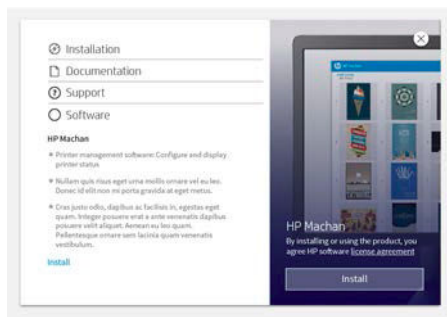

After auto-discovering your printers, you can quickly prepare your PDF, JPEG, TIFF, and HP-GL/2 documents, using the real-time print preview and error checks to avoid reprints.

 **TIP:** Automatic nesting can help you to optimize paper usage and cut costs.

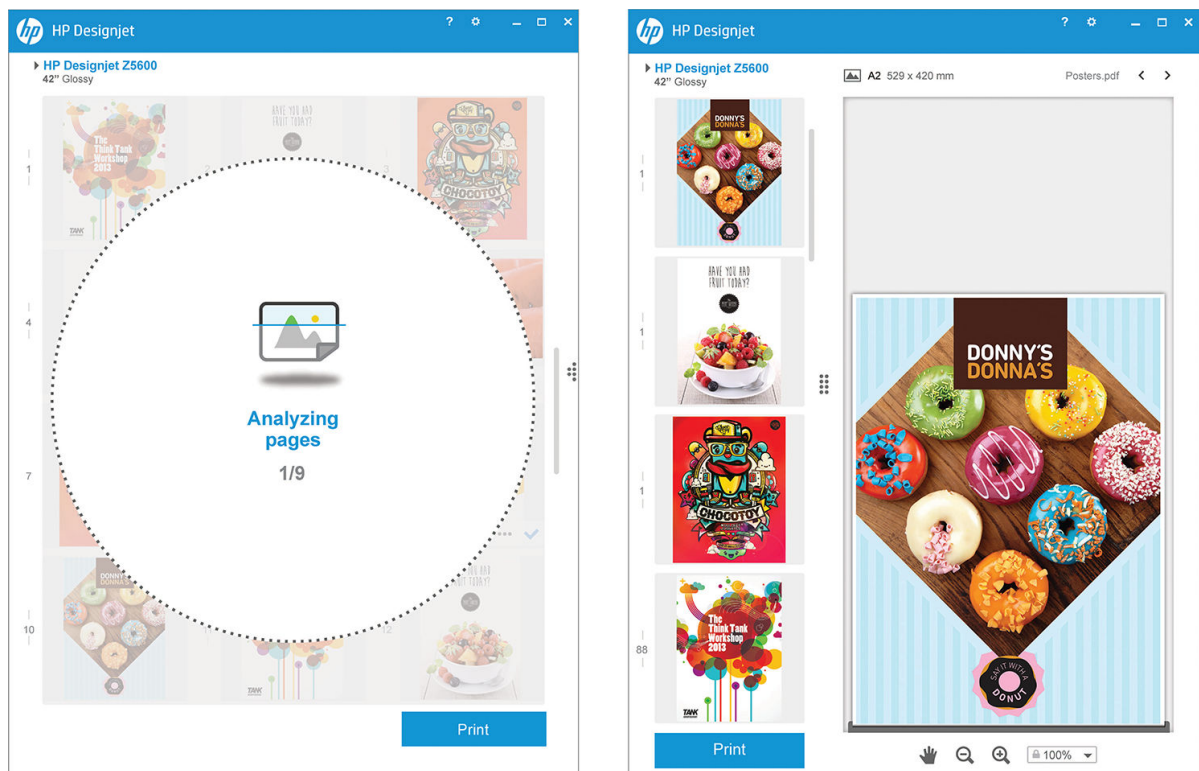

HP DesignJet Click Printing Software can also be downloaded from <http://www.hp.com/go/designjetclick>.

3 Setting up the printer

- [Introduction](#)
- [Set up your Web-connected printer](#)
- [Web Services manual configuration](#)
- [Paper suitability options](#)
- [Turn nesting on and off](#)
- [Turn usage information on and off](#)
- [Turn email notifications on and off](#)
- [Turn alerts on and off \(Windows only\)](#)
- [Control access to the printer](#)
- [Require account ID](#)
- [Set Windows driver preferences](#)

Introduction



This chapter describes various printer settings that the printer administrator may wish to control as soon as a new printer is assembled and ready for use.

Set up your Web-connected printer

Your printer can connect to the Internet to benefit from the following Web Services (see also [Web Services on page 11](#)):

- Automatic firmware updates
- Use HP ePrint to print by email

To set up your printer for Web Services, follow these steps, explained in more detail below:

1. Make sure that your printer is correctly connected to the Internet.
2. Run the Connectivity Wizard: At the front panel, press , then , then **Connectivity > Connectivity wizard**.

If you cannot find the Connectivity Wizard in the menu, update your firmware and then try again.

If the Wizard downloads new firmware, the printer may need to restart.

 **TIP:** When the Wizard displays your printer code and email address, you are recommended to make a note of them.

3. If you are the printer administrator, you can log in at HP Connected (<http://www.hpconnected.com>) to customize your printer's email address.

Congratulations, you now have completed Web Services setup. HP ePrint is ready to use.

For the latest information, support, and terms of use of HP Connected, see <http://www.hpconnected.com> (check for availability in your region).

Web Services manual configuration

The Connectivity Wizard (see [Set up your Web-connected printer on page 20](#)) is normally sufficient for Web Services configuration, but there are also facilities for manual configuration if you wish to use them.

Configure the printer's Internet connection

You can configure the printer's Internet connection from the Embedded Web Server or from the front panel.

 **NOTE:** If an administrator password has been set, it will be required to change these settings. Thus, the administrator can prevent the printer from being connected to the Internet, if desired.

- **In the Embedded Web Server:** select **Setup > Internet connection**.
- **Using the front panel:** press , then , then **Connectivity > Internet connectivity**.

The following settings are available:

- **Enable Internet connection:** The default value is **Yes**.
- **Proxy > Enable proxy:** Enable or disable a proxy server.
- **Proxy > Address:** Enter the proxy address, empty by default.



- **Proxy > Primary port:** Enter the proxy port number, zero by default.
- **Proxy > Restore factory settings:** Return to the initial default settings.

If you have trouble with your Internet connection, see [Cannot connect to the Internet on page 159](#).

Configure firmware updates

You can choose from the Embedded Web Server or from the front panel whether and how to download firmware updates.

 **NOTE:** If an administrator password has been set, it will be required to change these settings.

- **In the Embedded Web Server:** select **Setup > Firmware update**.
- **Using the front panel:** press , then , then **Updates > Firmware update**.

The following settings are available:

- **Check:** If you select **Automatically** (the default setting), the printer will check automatically every week (or after the printer has been restarted seven times, whichever happens first) whether new firmware is available. If you select **Manually**, the printer will not check automatically; you can check manually whenever you like.
- **Download:** If you select **Automatically** (the default setting), the printer will automatically download new firmware whenever it becomes available. If you select **Manually**, you will be asked to approve each download.

 **NOTE:** Downloading the firmware does not mean that you have installed it in your printer. To install the new firmware, you must confirm the installation manually.

- **Firmware update information:** Information about the firmware currently installed
- **Firmware update history:** A list of firmware versions that have been installed in the printer. It is usually possible to reinstall the version immediately before the version that is currently installed, if you have some problem with the current version.

Set remote printing preferences

At the front panel, press , then , then **Setup > Printing preferences** to define the default properties of jobs sent to your printer from remote locations.

- **Printer margins:** Choose between **Clip from contents** and **Add to content**.
- **Color:** Choose between **Color** and **Grayscale** printing.
- **Print quality:** Choose between **Best**, **Normal**, and **Fast**.
- **Roll:** Choose between **Roll 1**, **Roll 2** (Z5600 only), and **Save paper**, which automatically chooses the narrowest roll on which the print will fit.
- **Jobs:** Choose between **On hold** and **Direct print**. By default, jobs from the cloud are **On hold**. If you choose **Direct print**, the front panel will not ask for permission before printing.





Paper suitability options

Paper mismatch action

If the paper currently loaded in the printer is not suitable for a particular job, the printer can either put the job on hold until some suitable paper is loaded, or it can ignore the problem and print the job on the unsuitable paper. There are several ways in which the loaded paper may be considered unsuitable:



- The paper type is not as specified for the job
- The paper source (roll 1, roll 2 or sheet) is not as specified for the job
- The paper size is smaller than specified for the job

You can set the printer's behavior in such cases from the front panel.

- Press , then , then **Setup > Job management options > Paper mismatch action > Print anyway** if you want such jobs to print on whatever paper is loaded. This is the default option when printing from a software application or from the Embedded Web Server; but it does not work when printing from a USB flash drive, nor when copying.
- Press , then , then **Setup > Job management options > Paper mismatch action > Put job on hold** if you want such jobs to be put on hold. The printer will send an alert whenever a job is put on hold.

When a job is put on hold for paper, it is kept in the printer queue until some suitable paper is loaded (in which case, all jobs waiting for that paper type can be printed). Meanwhile, other jobs with different requirements can continue printing.

Roll switching options (Z5600 only)

If two rolls are loaded, both of which are suitable for the job, the roll will be chosen according to your preferences. These can be set from the front panel: press , then , then **Setup > Printing preferences > Paper options > Roll switching options**.

- **Minimize paper waste.** If this option is chosen, the printer will choose the narrowest roll that meets all the criteria, to avoid wasting paper due to trimming. This is the default option.
- **Minimize roll changes.** If this option is chosen, the printer will choose the roll that is currently active, to avoid wasting time with a roll switch.
- **Use roll with less paper.** If this option is chosen, the printer will choose the roll that has the least paper.

 **NOTE:** This option is effective only if you have enabled **Printing paper info** (see [Printing paper info on page 45](#)). Otherwise, it has the same effect as **Minimize paper waste**.

 **NOTE:** In order to switch from one roll to another, the printer needs to cut the active roll. Therefore, automatic roll switching is not possible when the active roll cannot be cut by the automatic cutter.



Turn nesting on and off

Nesting means automatically printing images or document pages side by side on the paper when feasible, rather than one after the other. This is done to avoid wasting paper. See [Nest jobs to save roll paper on page 61](#).

To turn nesting on or off, you must first make sure that the job queue is enabled (see [Turn off the job queue on page 68](#) or [Turn off the job queue on page 72](#)) and the start of printing is set to **After Processing** (see

[Select when to print a job in the queue on page 66](#) or [Select when to print a job in the queue on page 70](#)).

Then:

- **In the HP DesignJet Utility for Windows:** select **Settings > Job Management > Nest**.
- **In the HP DesignJet Utility for Mac OS X:** select **Printer Settings > Configure Printer Settings > Job Management > Nest**.
- **In the Embedded Web Server:** select **Setup > Printer settings > Job management > Nest**.
- **Using the front panel:** press , then , then **Setup > Job management > Nest options > Enable nesting**.

In each case, you will see the following options:

- **In order:** pages are nested in the order in which they are sent to the printer. The nested pages are printed as soon as one of three conditions is met:
 - The next page will not fit on the same row as the other pages already nested.
 - No page has been sent to the printer during the specified wait time.
 - The next page is incompatible with the pages already nested (see [Nest jobs to save roll paper on page 61](#)).
- **Optimized order:** pages are not necessarily nested in the order in which they are sent to the printer. When it receives an incompatible page, the printer holds it and waits for compatible pages to complete the nest. The nested pages are printed as soon as one of three conditions is met:
 - The next page will not fit on the same row as the other pages already nested.
 - No page has been sent to the printer during the specified wait time.
 - The incompatible-page queue is full. The printer can queue up to six incompatible pages while nesting compatible pages. If it receives a seventh incompatible page, the nest is printed as it is.
- **Off:** nesting is disabled. This is the default option.

The nesting wait time can be set at the front panel: press , then , then **Setup > Job management > Nest options > Select wait time**.

 **TIP:** **Optimized order** uses the minimum amount of paper; however, it may take longer to print because the printer waits for compatible pages to arrive.

Turn usage information on and off

The printer can send usage information periodically by email. You can request this in the following ways:

- **In the HP DesignJet Utility for Windows:** select **Settings > Accounting**.
- **In the HP DesignJet Utility for Mac OS X:** select **Printer Settings > Configure Printer Settings > Accounting**.
- **In the Embedded Web Server:** select **Setup > Printer settings > Accounting**.

In each case, you must set the following options:

- **Send accounting files: On** (the default is **Off**)
- **Send accounting files to:** a valid email address
- **Send accounting files every:** choose a number of days (1–60) or a number of prints (1–500)

You must also ensure that the email server has been configured. To configure the email server using the Embedded Web Server, select **Setup > Email server**, and fill in the following fields:

- **SMTP server:** the IP address of the outgoing mail server (SMTP) that will process all email messages from the printer. If the mail server requires authentication, email notifications will not work.
- **Printer email address:** each email message sent by the printer must include a return address, which does not need to be a real, functional email address, but it should be unique, so that recipients of the message can identify the printer that sent it.

Turn email notifications on and off

In order to receive email notifications from the printer, you must have configured the email server (see [Turn usage information on and off on page 23](#)).

You can turn specific email notifications on or off by selecting **Notifications** from the **Setup** tab of the Embedded Web Server.

Turn alerts on and off (Windows only)

Printer alerts warn you when there is a printer problem that you can correct by taking action, or when one of your printing jobs changes its status. The alerts are displayed by the printer's front panel, by the HP DesignJet Utility, by the printer driver and by the Embedded Web Server.

You can tell the printer which kinds of alerts you would like to see (if any). To access the alert settings:



- Select **Alert Settings** in the Device List page of the HP DesignJet Utility for Windows.
- Select **Alert Settings** in any alert page displayed by the HP DesignJet Utility for Windows.
- Right-click the system tray icon of the HP DesignJet Utility for Windows, and select **Alert Settings**.

You can change the settings in the following ways:

- Turn all alerts on or off.
- Turn job status alerts on or off.
- Turn on or off printer alerts for problems that stop the printer from printing.
- Turn on or off printer alerts for problems that do not stop the printer from printing.
- Turn on printer alerts in all circumstances, or only when you are trying to print to the printer affected by the problem.

Control access to the printer

Front-panel security settings

From the front panel, you can press , then , then **Setup > Security**, to control some of the features of the printer.

- **USB drive:** Enable or disable the use of a USB flash drive.
- **Firmware upgrade from USB:** Enable or disable firmware updates from a USB flash drive.
- **Enable Internet connection:** Enable or disable the Internet connection.

 **NOTE:** If you disable it, you also disable automatic firmware updates.

- **Printer access control:** Enable, disable, or change the administrator password.

If an administrator password has been set, it must be given in order to perform the following operations:

- Change the security settings (including the administrator password itself)
- Change the configuration of the Internet connection
- Change the Automatic Firmware Update configuration
- Enable or disable automatic downloading and/or installation of automatic firmware updates
- Restore an earlier firmware version
- Reset factory defaults

 **NOTE:** The administrator password can contain only characters that appear on the front panel's on-screen keyboard. If you set a new password with the Embedded Web Server, it will reject characters that do not appear in that limited character set.

Embedded Web Server security settings



From the Embedded Web Server, you can select **Setup > Security** to control access to the printer in various ways:

- Specify separate administrator and guest passwords to control access to the Embedded Web Server
- Enable or disable Ethernet connection to the printer
- Enable or disable various groups of front panel operations
- Use the same security settings that are available in the front panel (see above)

 **NOTE:** An administrator password may be required.

 **NOTE:** For more information, see the Embedded Web Server's online help.

Disable your HP ePrint connection

You can disable the connection to HP ePrint if required for security. At the front panel, press , then , then **Connectivity > HP ePrint > HP ePrint settings > HP ePrint connectivity** and select **Disable**.

Disable just puts the remote printing function on hold. If you want to resume using it, you just need to re-enable it in the same menu. No more setup steps are required.

If you want to disable remote printing permanently, select **Disable permanently**. To use remote printing again, you will need to set it up again from scratch (see [Set up your Web-connected printer on page 20](#)).

 **NOTE:** You can prevent non-administrators from changing these options by setting an administrator password in the Embedded Web Server (**Setup > Security**).

Require account ID

If you want to keep records of printer usage by different user accounts, you can set your printer to require an account ID for each job.

- **In the HP DesignJet Utility for Windows:** select **Settings > Accounting > Require account ID**.
- **In the HP DesignJet Utility for Mac OS X:** select **Printer Settings > Configure Printer Settings > Accounting > Require account ID**.

If this setting is turned on, the account ID field will be mandatory and jobs with no account ID will be kept "on hold for accounting".

The account ID can be set in the printer driver when sending the job. If the job is set "on hold for accounting" by the printer, you can introduce the account ID in the HP DesignJet Utility by going to the **Job Center > Job Queue** and clicking the job that is on hold. A window with a text box will be displayed and you can enter the account ID into it.

Set Windows driver preferences





You can change some default settings in your printer driver according to your own preferences, for instance to set color emulation or paper-saving options. To do this, press the **Start** button on your computer's screen, then select **Printers and Faxes**. In the Printers and Faxes window, right-click your printer's icon, and select **Printing Preferences**. Any settings you change in the Printing Preferences window will be saved as default values.

4 Personalizing the printer

- [Change the language of the front-panel display](#)
- [Access the HP DesignJet Utility](#)
- [Access the Embedded Web Server](#)
- [Change the language of the HP DesignJet Utility](#)
- [Change the language of the Embedded Web Server](#)
- [Change the sleep mode setting](#)
- [Turn the buzzer on and off](#)
- [Change the front-panel display brightness](#)
- [Change the units of measurement](#)
- [Configure network settings](#)
- [Change the graphic language setting](#)
- [Manage Printer security](#)
- [Change your printer's email address](#)

Change the language of the front-panel display

There are two possible ways to change the language of the front-panel menus and messages.

- If you can understand the current front-panel display language, press , then , then **Setup** > **Front panel options** > **Select language**.
- If you cannot understand the current front-panel display language, start with the printer powered off. Press the **Power** key to turn it on. When you see icons appear on the front panel, press  and then . The front panel acknowledges this sequence by turning the icons on and off rapidly.

Whichever method you used, the language selection menu should now appear on the front-panel display. Press your preferred language.

Access the HP DesignJet Utility

The HP DesignJet Utility enables you to manage your printer from a computer with a TCP/IP or Jetdirect connection.

- **Under Windows**, start the HP DesignJet Utility from your desktop shortcut or from **Start** > **All Programs** > **HP** > **HP DesignJet Utility** > **HP DesignJet Utility**. This launches the HP DesignJet Utility, showing the printers installed on your computer.
- **Under Mac OS X**, launch the HP DesignJet Utility from your dock shortcut or by selecting **STARTUP_DISK** > **Library** > **Printers** > **hp** > **Utilities** > **HP DesignJet Utility**. This launches the HP DesignJet Utility, showing the printers installed on your computer.

When you select your printer in the left pane, everything that appears in the right pane is specific to that printer.

If you have followed these instructions but failed to get through to the HP DesignJet Utility, see [Cannot access the HP DesignJet Utility on page 158](#).

Access the Embedded Web Server

The Embedded Web Server enables you to manage your printer remotely using an ordinary Web browser running on any computer.



To access the Embedded Web Server directly, you must have a TCP/IP connection to your printer.

The following browsers are known to be compatible with the Embedded Web Server:

- Internet Explorer 7 for Windows XP, and later
- Safari 3 for Mac OS X 10.5, and later
- Firefox 3.6 and later
- Google Chrome 7 and later

The Adobe Flash plugin version 7 or later is recommended for viewing job previews.

To access the Embedded Web Server on any computer, open your Web browser and give the IP address of your printer.

You can see your printer's IP address on the front panel by pressing  and then .

If you have followed these instructions but failed to get through to the Embedded Web Server, see [Cannot access the Embedded Web Server on page 158](#).

Change the language of the HP DesignJet Utility

The HP DesignJet Utility can work in the following languages: English, Portuguese, Spanish, Catalan (Windows only), French, Dutch, Italian, German, Polish, Russian, Simplified Chinese, Traditional Chinese, Korean and Japanese.



- **Under Windows**, select **Tools > Set Language** and select a language from the list.
- **Under Mac OS X**, the language is changed as for any other application. In **System Preferences**, select **Language & Region** and re-launch the application.

Change the language of the Embedded Web Server



The Embedded Web Server can work in the following languages: English, Portuguese, Spanish, Catalan, French, Italian, German, Russian, Simplified Chinese, Traditional Chinese, Korean and Japanese. It uses whichever language you have specified in your Web browser's options. If you have specified a language that it cannot support, it works in English.

To change the language, you must change your Web browser's language setting. For example, in Internet Explorer version 6, go to the **Tools** menu and select **Internet Options, Languages**. Then ensure that the language you want is at the top of the list in the dialog box.



Change the sleep mode setting

If the printer is left switched on but unused for a certain period of time, it goes automatically into sleep mode to save power. To change the time the printer waits before it goes into sleep mode, go to the front panel and press , then , then **Setup > Front panel options > Sleep mode wait time**. Select the wait time you want and then press **OK**; you can set the time from 1 to 240 minutes. The default time is 20 minutes.

Turn the buzzer on and off

To turn the printer's buzzer on or off, go to the front panel and press , then , then **Setup > Front panel options > Buzzer**, and select on or off. By default, the buzzer is set to on.

Change the front-panel display brightness

To change the brightness of the front-panel display, press , then , then **Setup > Front panel options > Display brightness**, and select a value you want. Press **OK** to set the value. The default brightness is set to 50.

Change the units of measurement

To change the units of measurement in the front-panel display, press , then , then **Setup > Front panel options > Unit selection**, and select **English** or **Metric**. By default the units are set to metric.

Configure network settings

You can view and configure the network settings from the Embedded Web Server, the HP DesignJet Utility or the front panel.

To do so with the Embedded Web Server, select the **Setup** tab, then **Networking** (on the right side of the screen).

With the HP DesignJet Utility under Windows, select the **Settings** tab, then **Network Settings**. Under Mac OS X, select **Configuration > Network Settings**.

The following settings are available.

- **IP Configuration method:** Specify the way to set an IP address, selecting **BOOTP**, **DHCP**, **Auto IP** or **Manual**.
- **Host name:** Specify the IP name of the printer. The name may contain up to 32 ASCII characters.
- **IP address:** Specify the IP address of the printer. Duplicate IP addresses on a TCP/IP network will cause communication to fail.



 **TIP:** Make sure that the combination of IP address, subnet mask and default gateway is valid. If these three fields are inconsistent, you may not be able to connect to the printer at all until you fix the problem from the front panel.

TIP: If you change the current IP address and click **Apply**, the browser loses the current connection to the printer because it is pointing to the old address. To reconnect, browse to the new IP address.

- **Subnet mask:** Specify a subnet mask, which determines which bits specify the network and which bits uniquely specify the node within the network.
- **Default gateway:** Specify the IP address of a router or computer that is used to connect to other networks or sub-networks. If none exist, use the IP address of the computer or the IP address of the printer.
- **Domain name:** Specify the name of the DNS domain in which the printer resides (for example, support.hp.com).

 **NOTE:** The domain name does not include the host name: it is not the fully qualified domain name, such as printer1.support.hp.com.

- **Idle timeout:** Specify the time that an idle connection is allowed to remain open when a remote computer is waiting for the printer. The default value is 280 seconds. If set to zero, the timeout is disabled and the connection is allowed to remain open indefinitely.
- **Default IP:** Specify the IP address to use when the printer is unable to obtain an IP address from the network when powered on or when reconfigured to use BOOTP or DHCP.
- **Send DHCP requests:** Specify whether DHCP requests are transmitted when a legacy default IP address or a default Auto IP is assigned.

To configure the same network settings from the front panel, press , then , then **Connectivity > Network connectivity > Gigabit Ethernet > Modify configuration**.

You have various other options available from the **Connectivity > Network connectivity > Advanced** menu.



- **I/O timeout:** Specify the time that an idle connection is allowed to remain open when the printer is waiting for a remote computer. The default value is 30 seconds. If set to zero, the timeout is disabled and the connection is allowed to remain open indefinitely.
- **Allow SNMP:** Specify whether SNMP is permitted.

- **Embedded Web Server > Allow EWS:** Specify whether the Embedded Web Server is enabled.
- **Web Services > HP DesignJet Utility software:** View the HP DesignJet Utility software settings.
- **Web Services > Color and paper management:** View the color and paper management settings.
- **Restore factory settings:** restore the initial default values of the network settings.

Change the graphic language setting

You can change the graphic language setting from the HP DesignJet Utility with the following steps.

1. **Under Windows,** select the **Settings** tab then **Printer settings > Printing preferences**.
Under Mac OS X, select **Printer settings > Configure printer settings > Printing preferences**.
2. Select one of the following options.
 - Select **Automatic** to let the printer determine which type of file it is receiving. This is the default setting; it works for most software applications. You should not normally need to change it.
 - Select **HP-GL/2** only if you are sending a file of that type directly to the printer, without going through a printer driver.
 - Select **PDF** only if you are sending a file of that type directly to the printer, without going through a printer driver.
 - Select **PostScript** only if you are sending a file of that type directly to the printer, without going through a printer driver.
 - Select **TIFF** only if you are sending a file of that type directly to the printer, without going through a printer driver.
 - Select **JPEG** only if you are sending a file of that type directly to the printer, without going through a printer driver.

You can change the graphic language setting from the front panel. Press , then , then **Setup > Advanced printing preferences > Graphics language**. Select the desired option.

 **NOTE:** If the graphic language is set from the HP DesignJet Utility, it overrides the front panel setting.

Manage Printer security

When you have set up Web Services, the printer is in unlock mode. In unlock mode, anyone who knows your printer's email address can print to your printer by just sending a file to it. Although HP provides a spam filtering service, you should be careful about giving out your printer's email address, as everything sent to that address may be printed on your printer.

If you are the printer administrator, you can manage Printer security or change your printer status to lock mode by visiting HP Connected at <http://www.hpconnected.com>. You can also customize your printer's email address and manage print jobs from there. At your first visit, you will need to create an account at HP Connected.

Change your printer's email address

You can change your printer's email address at HP Connected: <http://www.hpconnected.com>.

5 Paper handling

- [General advice](#)
- [Load a roll onto the spindle](#)
- [Load a roll into the printer](#)
- [Unload a roll](#)
- [Load a single sheet](#)
- [Unload a single sheet](#)
- [Sensitive-paper mode](#)
- [View information about the paper](#)
- [Paper presets](#)
- [Printing paper info](#)
- [Move the paper](#)
- [Maintain paper](#)
- [Change the drying time](#)
- [Turn the automatic cutter on and off](#)
- [Feed and cut the paper](#)

General advice

⚠ CAUTION: Before starting a paper loading process, ensure you have enough room around the printer, both in front and behind.

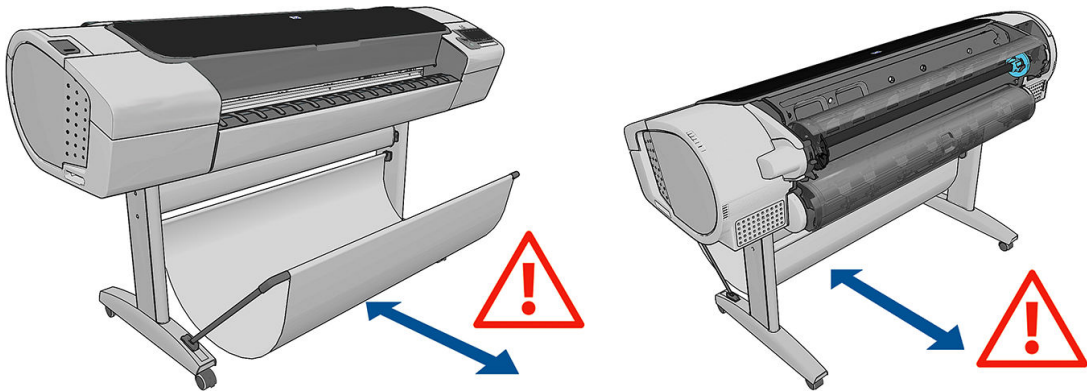

⚠ CAUTION: Make sure the printer wheels are locked (the brake lever is pressed down) to prevent the printer from moving.

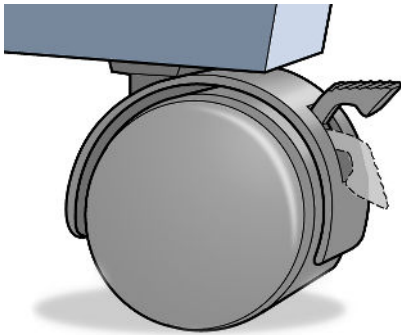

⚠ CAUTION: All paper must be 280 mm (11 in) or longer. A4 and letter paper cannot be loaded in landscape orientation.

💡 TIP: For photo paper wear cotton gloves to avoid transferring oils onto the paper.

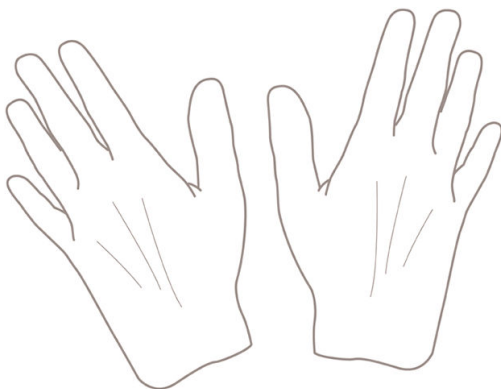

⚠ CAUTION: Keep the basket closed throughout the loading process.

Load a roll onto the spindle

1. Open the roll cover.

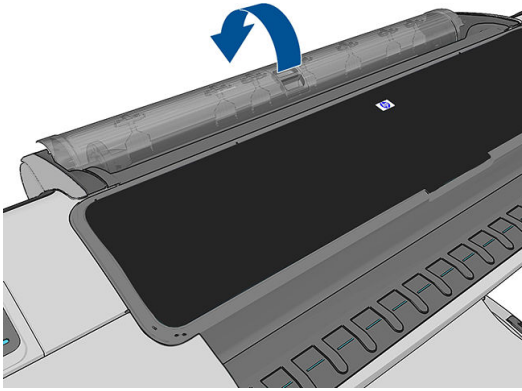

2. Remove the black end of the spindle from the printer, then the blue end.

⚠ CAUTION: Be sure to remove the black end first. Removing the blue end first could damage the black end.

⚠ WARNING! Do not insert your fingers into the spindle supports during the removal process.

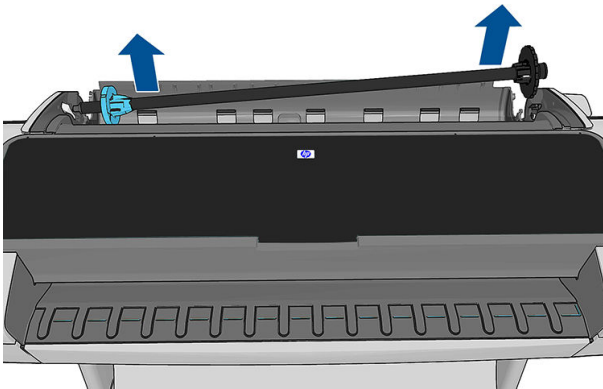

3. The spindle has a stop at each end to keep the roll in position. The blue stop can be removed to mount a new roll; it slides along the spindle to hold rolls of different widths. Remove the blue paper stop from the end of the spindle.

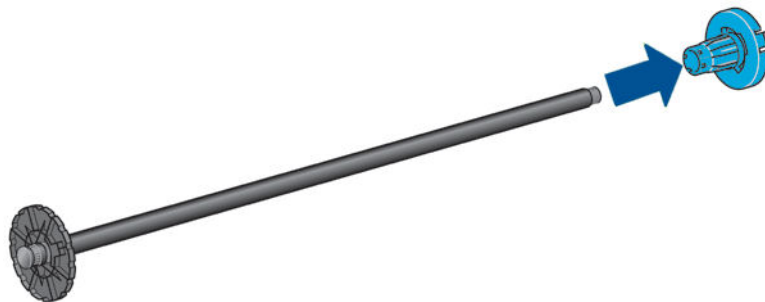

4. If the roll is long; rest the spindle horizontally on a table and load the roll on the table.

💡 TIP: You may need two people to handle a large roll.

- Slide the new roll onto the spindle. Make sure the paper type is oriented as shown. If it is not, remove the roll, turn it 180 degrees and slide it back on to the spindle. There are labels on the spindle showing the correct orientation.

 **NOTE:** From the back of the printer, the blue stopper is inserted into the right-side holder.

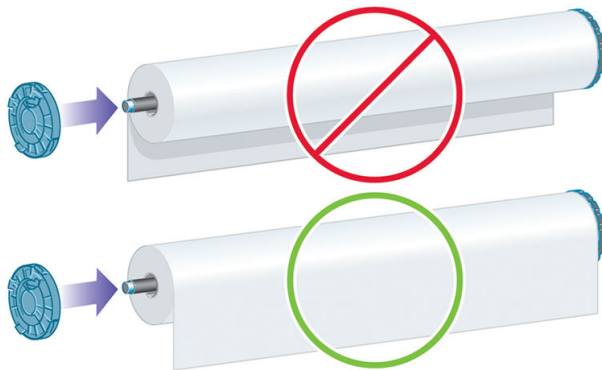

Ensure both ends of the roll are as close to the spindle stops as possible.

- Put the blue paper stop on to the open end of the spindle, and push it towards the end of the roll.

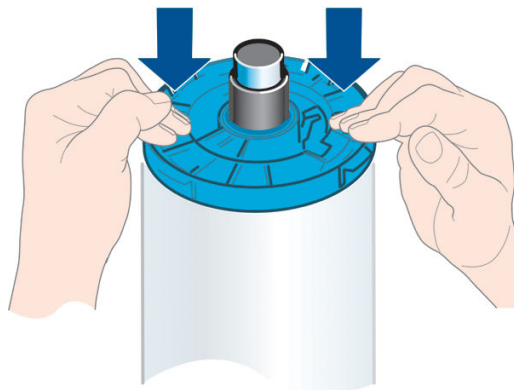



- Ensure the blue paper stop is pushed in as far as it goes; until both ends are against the stoppers.

If you are a regular user of different paper types, you can change rolls more quickly if you preload rolls of different paper types on different spindles. Extra spindles are available for purchase, see [Accessories on page 116](#).

Load a roll into the printer

To start this procedure, you must have a roll loaded on the spindle. See [Load a roll onto the spindle on page 33](#).

 **TIP:** Do not try to open both roll covers at once; this may cause problems. Always close one cover before opening the other.

 **NOTE:** The first three steps below are optional: you can start with step 4. However, in this case the printer will not keep track of the length of the roll, and will print no barcode on the roll when it is next unloaded. So you are recommended to follow all the steps, starting with step 1, unless you have turned off the **Printing paper info** option. See [Printing paper info on page 45](#).

- From the front panel, press , then the roll icon, then **Load**.

Alternatively, press , then , then **Paper > Paper load > Load roll 1** or (Z5600 only) **Load roll 2**.

If the roll you have selected is already loaded, you have to wait while it is automatically unloaded.

 **NOTE:** If the loaded paper cannot be automatically cut by the printer, you are asked to unload it manually.

You should stand behind the printer when loading the lower roll (roll 2). You may stand behind or in front of the printer when loading the upper roll (roll 1).

 **CAUTION:** If your height is less than 1.6 m (5 ft 3 in), loading a roll while standing in front of the printer may cause back pain or other physical problems.

2. Z5600 only: If you start to load roll 1 while roll 2 is already loaded, roll 2 is withdrawn to the standby position, so that it can be printed on again without reloading whenever required.

 **NOTE:** If roll 2 cannot be automatically cut by the printer, it is not moved to the standby position; instead, you are asked to unload it manually.

 **NOTE:** If at any time you open a roll cover while that roll is in the standby position, the roll is unloaded, and you will have to reload it the next time you want to print on it.

3. Open the roll cover, if it is not already open.
4. Rest the spindle's black end on the left side roll holder. Do not put the end completely into the roll holder.

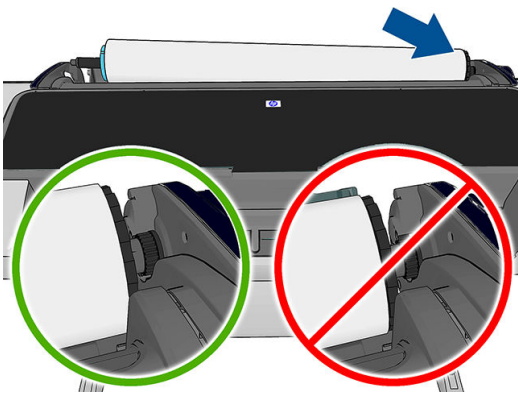

5. Rest the blue end of the spindle on the right side roll holder.

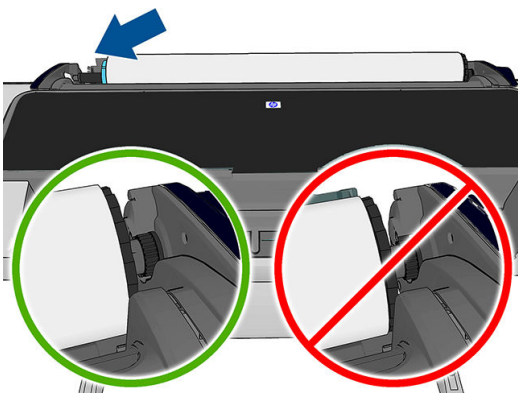

6. With both hands, push the spindle into both roll holders at the same time.
7. If the edge of the roll is not straight or torn (sometimes due to tape used to hold end of the roll), pull the paper slightly and cut a straight edge.

8. Insert the edge of the paper into the printer.

⚠ WARNING! Do not push your fingers inside the printer's paper path.

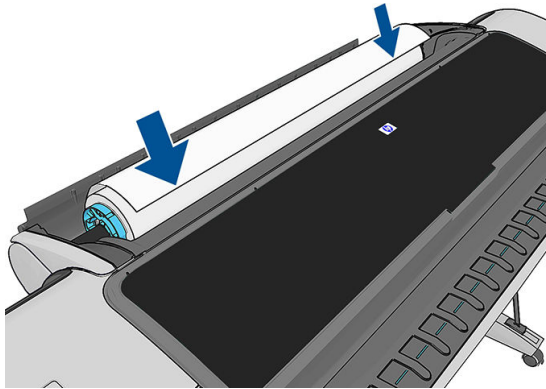

💡 TIP: When loading the upper roll, avoid inserting roll paper into the cut-sheet slot. If you do so, the printer beeps and the front panel asks you to remove the paper.

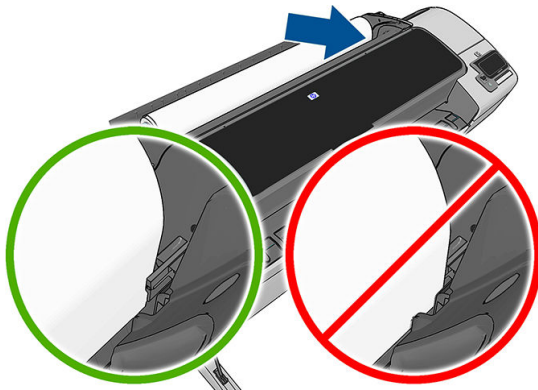

9. Roll the paper into the printer until you feel resistance and the paper flexes slightly. When the printer detects the paper, it feeds it in automatically.

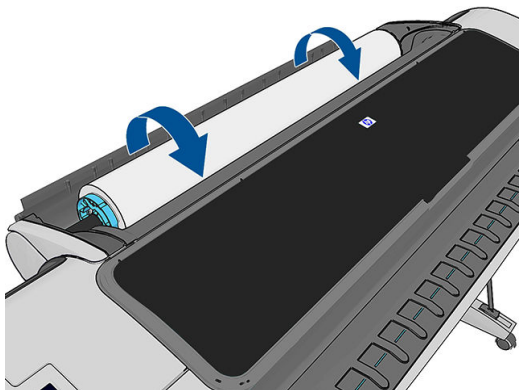

10. If the leading edge of the paper has a barcode, the printer reads and then cuts off the barcode; you should remove and discard the cut strip of paper.
11. If the leading edge of the paper has no barcode, the front panel prompts you to select the paper category and type.

💡 TIP: If you have loaded a paper type whose name does not appear in the paper list, see [The paper type is not in the driver on page 124](#).

12. If the **Printing paper info** option is enabled, the front panel may ask you to specify the length of the roll. See [Printing paper info on page 45](#).
13. The printer checks the alignment and measures the width, then the front panel prompts you to close the roll cover.

If the roll is not correctly aligned, follow the instructions on the front-panel display.

Uncuttable paper (canvas)

Some paper types, such as canvas, cannot be cut by the automatic cutter. This has the following consequences:

- The automatic cutter is automatically disabled.
- The front panel reports on the home screen and in the paper tab that automatic cutting is not available.
- The roll cannot be moved to the standby position.
- The roll cannot be unloaded automatically: it must be unloaded manually.
- Automatic roll-switching is disabled, and any job sent to a standby roll is put on hold for paper until the uncuttable roll is unloaded.
- The **Printing paper info** option is automatically disabled; see [Printing paper info on page 45](#).

 **NOTE:** If you have an unexpected issue at any stage of the paper loading process, see [The paper cannot be loaded successfully on page 123](#).

Unload a roll

Before unloading a roll, check whether there is paper on the roll or if the roll is out of paper, and follow the appropriate procedure as described below.

Quick procedure with paper on the roll

If there is paper on the roll, just open the roll cover, and the roll is unloaded automatically, unless the roll is uncuttable (in which case, see [Manual unload procedure on page 39](#)).

 **NOTE:** When the roll is unloaded in this way, no barcode is printed on it, so the printer will not know the length of the roll when it is next loaded. See [Printing paper info on page 45](#).

 **NOTE:** If you open the cover of roll 1 while a sheet is loaded, the sheet is also unloaded.

Front panel procedure with paper on the roll

If there is paper on the roll, you can unload it from the front panel.

1. Press , then the roll icon, then **Unload**.

Alternatively, press , then , then **Paper > Paper unload > Unload roll 1** or (Z5600 only) **Unload roll 2**.

2. You may need to open the roll cover.
3. If the paper is uncuttable, see [Manual unload procedure on page 39](#).

Roll out of paper procedure

If the end of the paper is no longer attached to the core, use the following procedure.



1. If you have already started the unload process, press  on the front panel to cancel that procedure.
2. Lift the blue lever on the left. If the front panel displays a warning about the lever, ignore it.
3. Pull out the paper from the printer. Pull from wherever the paper is accessible; the back of the printer is recommended. You may need to open the roll cover.
4. Lower the blue lever.

Manual unload procedure

Paper types that cannot be cut by the automatic cutter must be unloaded manually.

1. Open the roll cover.
2. Lift the blue lever on the left.
3. Rewind the paper by turning the spindle manually, until the paper is removed from the printer.
4. Lower the blue lever.
5. Close the roll cover.

Load a single sheet

1. Ensure that the cover of roll 1 is closed. If it is opened while a sheet is loaded, the sheet will be immediately unloaded.
2. At the front panel, press  then the roll 1 icon, then **Load > Load sheet**.
Alternatively, press , then , then **Paper > Paper load > Load sheet**.
3. If a roll is already loaded, you have to wait while it is withdrawn to the standby position; it can be printed on again without reloading as soon as the sheet paper has been unloaded.

 **NOTE:** If at any time you open a roll cover while that roll is in the standby position, the roll will be automatically unloaded, and you will have to reload it the next time you want to print on it.

 **NOTE:** If the roll is uncuttable, the front panel gives instructions for unloading it manually.

4. Select your paper category and type.

 **TIP:** If you have loaded a paper type whose name does not appear in the paper list, see [The paper type is not in the driver on page 124](#).

5. When prompted by the front panel, insert the sheet into the cut-sheet slot on the right side of the printer.

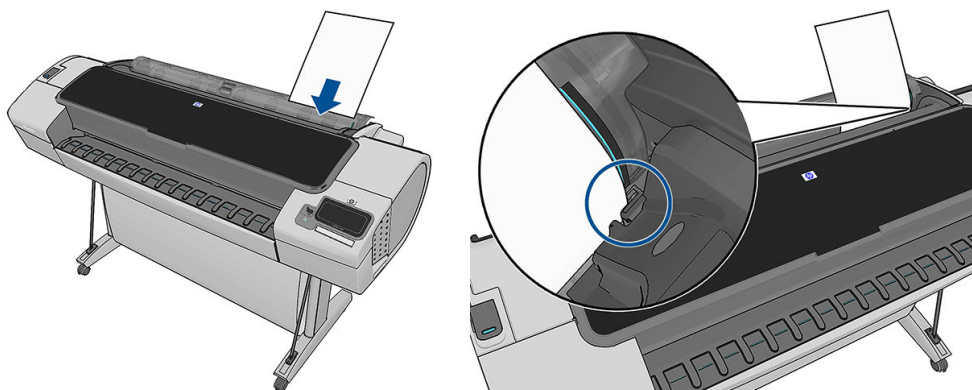

Load your sheet aligned with the load line and insert until the paper will not continue; with thicker sheets, you feel resistance.

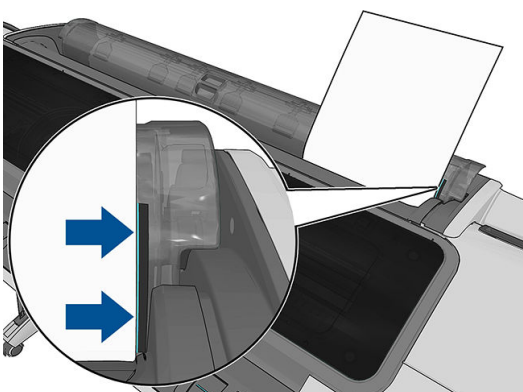

WARNING! Do not push your fingers inside the printer's paper path.

6. Press the **OK** key on the front panel to feed the paper into the printer. Guide the sheet into the printer; this is especially important with thicker papers.
7. The printer checks the alignment and measures the sheet.

NOTE: Depending on the length of the sheet, it feeds out the front of the printer.

8. If the length of the sheet is more than 600 mm (23 in), the front panel prompts you to check that the rear of the sheet is hanging backwards over the roll cover (and not forwards over the printer window).
9. If the sheet is not correctly aligned, you may be asked to correct the alignment. Follow the instructions on the front-panel display.

NOTE: If you have an unexpected problem at any stage of the paper loading process, see [The paper cannot be loaded successfully on page 123](#).

Unload a single sheet

To unload a single sheet after printing, you can simply pull the sheet free from the front of the printer.

To unload a sheet without printing, go to the front panel and press  then the roll 1 icon, then **Unload > Unload sheet**.

Alternatively, press , then , then **Paper > Paper unload > Unload sheet**.

The sheet unloads out of the front of the printer; either catch it manually or allow it to fall into the basket.

Sensitive-paper mode

The printer's sensitive-paper mode is designed to ensure the highest-quality prints on paper particularly vulnerable to deformations or scratches, such as film.

Sensitive-paper mode can be enabled in two different ways:

- When you load a roll, by using the **Load roll 1/2 as sensitive paper** front-panel options
- When the roll is already loaded, by using the **Treat roll 1/2 as sensitive paper** front-panel options.

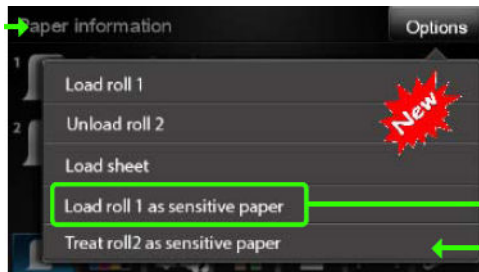

The front panel guides you through a step-by-step process. At the end, you are asked to keep the roll cover open while sensitive-paper mode is active. Apart from that, you can print on the selected roll as usual.

Sensitive-paper mode remains active until the roll runs out of paper, or until it is unloaded in the usual way.

When sensitive-paper mode is active, it is indicated with an icon  on the front panel's paper information screen.



Notes

- Sensitive-paper mode cannot be enabled on two rolls at the same time.
- When a roll is loaded or treated as sensitive paper, it cannot be parked by the printer. This means that no other paper will be available for printing as long as sensitive-paper mode is active.
- If a second roll is loaded while sensitive-paper mode is active:
 - The second roll is indicated as temporarily disabled on the front panel's paper information screen.
 - Any job to be printed on the disabled roll will be kept in the job queue as "on hold for paper".
 - The disabled roll is enabled when the sensitive-paper roll is unloaded.

View information about the paper

To view the loaded paper information, press  then the roll icon.

The following information is displayed on the front panel:

- Paper type you have selected
- Roll or sheet status
- Width of the paper in millimeters (estimated)
- Length of the paper in millimeters (estimated)

If no paper is loaded, the message **Out of paper** is displayed.

The same information is displayed in the HP DesignJet Utility for Windows (**Overview** tab > **Supplies Status** tab), the HP DesignJet Utility for Mac OS X (Information group > **Printer Status** > **Supplies Details**) and the Embedded Web Server (upper-right corner).

Paper presets

Each supported paper type has its own characteristics. For optimum print quality, the printer changes the way it prints on each different paper type. For example, some may need more ink and some may require a longer drying time. So the printer must be given a description of the requirements of each paper type. This description is called the *paper preset*. The paper preset contains the ICC profile, which describes the color characteristics of the paper; it also contains information on other characteristics and requirements of the paper that are not directly related to color. Existing paper presets for your printer are already installed in the printer's software.

However, as it is inconvenient to scroll through a list of all paper types available, your printer contains paper presets only for the most commonly used paper types. If you have a paper type for which your printer has no preset, you cannot select that paper type in the front-panel display.

There are two ways to assign a preset for a new paper type.

- Import a paper preset that you have downloaded from the Web. See [To install a downloaded paper preset on page 43](#).
- Create your own paper preset using the HP Color Center. See [To create your own paper preset on page 44](#).

 **NOTE:** You can use a maximum of 30 custom and additional paper types. To delete a custom or additional paper preset, go to the Color Center and select **Paper Preset Management** > **Delete Paper Preset**. In the HP DesignJet Utility for Mac OS X, select **Paper Preset Management** > **Delete Paper Preset**.

To install a downloaded paper preset

1. After finding the right paper preset at <http://www.hp.com/go/Z2600/paperpresets>, <http://www.hp.com/go/Z5600/paperpresets>, or the paper manufacturer's Web site, click the **Download Now** button and save the paper preset (an **.oms** file) on your computer.

 **NOTE:** If you do not find the paper preset you want on the Web, you may find that it has been added to the latest firmware for your printer. You can check the firmware release notes for information, see [Update the firmware on page 113](#).

2. Before starting to install the new preset, make sure that the printer is idle and the print queue is stopped. Installing a new paper preset will interrupt any printing that is in progress.
3. Start the HP DesignJet Utility or the Embedded Web Server.
 - In the HP DesignJet Utility for Windows, select the **Color Center** and then **Import Paper Preset**.
 - In the HP DesignJet Utility for Mac OS X, select **Import Paper Preset**.
 - In the Embedded Web Server, select the **Setup** tab, then **Paper preset management**, then the **Import** tab.

4. On the Import page, select the paper preset file that you downloaded in step 1.
5. Click the **Update** button and wait for the update process to finish. It may take some time. The printer will automatically restart when the update is complete; wait until it has restarted and the front panel indicates that it is ready.
6. Check that the new paper type appears in the **Additional paper** or **Custom paper** category in your printer's front panel.
7. Under Mac OS X only, synchronize the new paper type with the driver by opening the HP DesignJet Utility. Select your printer, then **Paper Preset Management** and **Synchronize Paper Presets** ( button).

Now that you have imported the paper preset, you can select the paper type from the front panel and from the Mac OS X driver. The ICC profile for the new paper type is ready to use by your application.

To create your own paper preset

Before using a custom paper type with your printer, you should add a paper preset for the new paper. You can create a new paper preset using the HP Color Center in the HP DesignJet Utility.

The paper preset name will appear in the printer driver and the front panel.

To create a paper preset, you can follow this simple procedure:

1. Go to the **Color Center** tab in the HP DesignJet Utility for Windows, or **Paper Preset Management** in the HP DesignJet Utility for Mac OS X.
2. Select **Create New Paper Preset** (Windows) or press the **+** button (Mac OS X).
3. Enter your paper's name.

 **TIP:** The paper's commercial name is likely to be the most understandable for other users of the printer.

4. Select a paper category from the drop-down menu. The paper category determines the amount of ink used and other basic printing parameters. For more information, see the online help  in the Color Center, and <http://www.hp.com/go/Z2600/paperpresets> or <http://www.hp.com/go/Z5600/paperpresets>. The available categories are:
 - **Bond and Coated Paper:** Fiber-based, thin papers with a matte surface. These papers use matte black ink, relatively low ink limits and high carriage position.
 - **Photo Paper:** Photo-base, relatively thick papers with a variety of finishing from matte to satin to glossy. These papers use photo black ink, with the exception of Photo Matte Papers, relatively high ink limits and low carriage position, with the exception of Baryte and Photo Matte Papers. Generally they will print with the starwheels up.
 - **Backlit:** Synthetic translucent materials that use photo black with high ink limits, high carriage position and starwheels up.
5. Click **Next** under Windows, **Continue** under Mac OS.
6. Load your custom paper, see [Load a roll into the printer on page 35](#) or [Load a single sheet on page 39](#). You will find the paper name in the **Custom paper** category in the front panel.
7. Choose the ICC profile name in the Color Center. This is the name you will use to select the profile in your application.

If you wish, use the **Change Printing Properties** button to change the following properties:

- **Paper Thickness:** This is relevant to carriage height or platen gap. You should choose **High** if your paper weighs over 250 g/m² or if it does not have a plastic coating.
- **Dry Time:** The recommendation is to use **Automatic** by default and move to **Extended** if needed.
- **Starwheels:** Print with the starwheels up or down.
- **Cutter:** Enable or disable the cutter.
- **Global Ink Limit:** Initially it can be left as it is and modified later on, based on printing results.

Some paper types are available with different ink limits (less/normal/more ink). Ink limits are generally proportional to color gamut volume, but a higher ink limit can cause printing artifacts (bleed, coalescence, etc.) in some cases. HP papers have fine-tuned ink limits while other papers use generic ink limits.

 **NOTE:** When an option is grayed out, that means that it is not available for the selected paper type.

8. Click **Next** under Windows, **Continue** under Mac OS.
9. If the paper type permits, the printer performs a color calibration (about 10 minutes).

Now that you have created the paper preset, you will be able to select the paper type from the front panel and from the Mac OS X driver under the **Custom paper** category. The ICC profile for the new paper type will be ready to use by your application.

You can export the new paper preset to your computer and use it on other HP DesignJet printers of the same model. In the Color Center, select **Paper Preset Management > Export Paper Preset**, then follow the instructions on the screen. In the HP DesignJet Utility for Mac OS X, select **Paper Preset Management > Export Paper Preset**. To install the preset on another printer, see [To install a downloaded paper preset on page 43](#).

Printing paper info



Enable the **Printing paper info** option to record the printer's estimate of the remaining roll length, paper width and type. The information is a combination of barcode and text that is printed on the leading edge of the roll when the paper is unloaded from the printer.



 **NOTE:** The paper-length estimate is available only if the printer registered the amount of paper that was on the roll when you loaded it. To provide this information to the printer, specify the roll length on the front panel when loading the paper, or load a roll that has the paper-data barcode printed on it.

 **NOTE:** The barcode and text are printed on the roll only when the loading and unloading processes are started from the front panel's Paper menu.

 **NOTE:** This option can be expected to work only with papers that are completely opaque and cuttable. It may fail with transparent or translucent papers; it is disabled when an uncuttable paper type is loaded.

To enable the **Printing paper info** option, go to the front panel and press , then , then **Setup > Printing preferences > Paper options > Enable printing paper info**.

 **NOTE:** Enabling this option slightly changes the paper loading and unloading procedures.

Move the paper

If the printer is idle (ready to print), you can move the paper forwards or backwards from the front panel. You may want to do this in order to have more or less white space between the last print and the next one.

To move the paper, press , then , then **Paper > Move paper**.

Maintain paper

To maintain paper quality, follow the recommendations below.

- Store rolls covered by another piece of paper or cloth
- Store cut sheets covered and clean or brush them before loading them in the printer
- Clean input and output platens
- Always keep the window of your printer closed

 **NOTE:** Photo and coated paper requires careful handling, see [The print is scuffed or scratched on page 138](#).

Change the drying time

You may wish to change the drying time setting to suit special printing conditions such as multiple prints where time is of higher importance or when you need to be sure ink is dry before handling.

Press , then , then **Setup > Print retrieval > Select drying time**. You can select:

- **Extended**, to set a longer than recommended time to ensure ink is completely dry
- **Optimal**, to set the default and recommended time for your selected paper (this is the default setting)
- **Reduced**, to set a shorter than recommended time when quality is of lower importance
- **None**, to disable the drying time and remove your print as soon as it finishes printing



 **CAUTION:** If the ink is not dry when the print is removed it could leave ink in the output tray and marks on the print.

 **NOTE:** If you cancel the drying time during a print, the printer may not feed and cut the paper right away due to the printhead maintenance, which runs in parallel. If the dry time is zero, the printer cuts the paper and then performs the printhead maintenance. However, if the dry time is greater than zero, the printer does not cut the paper until after the printhead maintenance has completed.



Turn the automatic cutter on and off

To turn the printer's paper cutter on or off:



- From the HP DesignJet Utility for Windows, select the **Settings** tab and change the **Cutter** option in **Printer Settings > Advanced**.
- From the HP DesignJet Utility for Mac OS X, select **Printer Settings > Configure Printing Settings > Advanced** and change the **Cutter** option.

- From the Embedded Web Server, select the **Setup** tab, then **Printer Settings > Advanced**, and change the **Cutter** option.
- From the front panel, press , then , then **Setup > Print retrieval > Enable cutter** and change the cutter option.



The default setting is **On**.

-
-  **NOTE:** If the cutter is turned off, it will not cut the paper between jobs, but it will continue to cut the paper on loading, unloading and switching between rolls.
 -  **NOTE:** The printer knows that some paper types, such as canvas, cannot be cut by the automatic cutter; and it will not try to cut them even if the cutter is turned on.
 -  **TIP:** To cut roll paper while the automatic cutter is disabled, see [Feed and cut the paper on page 47](#).
-



Feed and cut the paper

If you go to the front panel and press , then , then **Paper > Form feed and cut**, the printer advances the paper and makes a straight cut across the front edge. There are several possible reasons why you might want to do this.

- To trim the leading edge of the paper if it is damaged or not straight.
- To feed and cut the paper when the automatic cutter has been disabled.
- To cancel the waiting time and print the available pages immediately, if the printer is waiting to nest more pages.

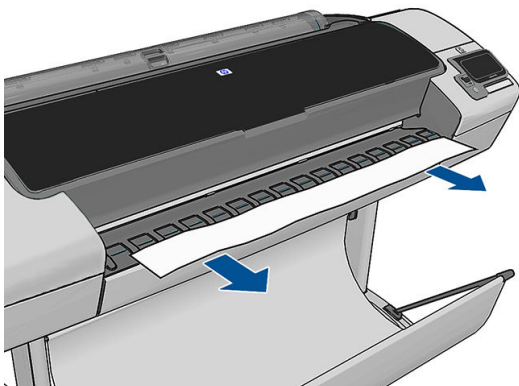
-
-  **NOTE:** The printheads are serviced after each print, and the paper cannot be cut until the process completes, so you may notice a delay.
 -  **NOTE:** Some paper types cannot be cut by the automatic cutter. In this case, the printer advances the paper without trying to cut it.
 -  **CAUTION:** Remove the cut piece from the output tray. If strips or short prints are left in the output tray the printer could jam.
-



-
-  **NOTE:** Photo and coated paper requires careful handling, see [The print is scuffed or scratched on page 138](#).
 -  **TIP:** To move the paper without cutting it, see [Move the paper on page 46](#).
-

6 Working with two rolls (Z5600 only)



- [The uses of a multiroll printer](#)
- [How the printer allocates jobs to paper rolls](#)

The uses of a multiroll printer

A multiroll printer can be useful in several different ways:

- The printer can automatically switch between different paper types according to your needs.
- The printer can automatically switch between different paper widths according to your needs. This enables you to save paper by printing smaller images on narrower paper.
- If you load two identical rolls into the printer, you can leave it printing unattended for a long time, because it can switch from one roll to the other automatically when the first is exhausted. See [Unattended printing/overnight printing on page 63](#).

The current status of both rolls is shown on the front panel if you press .

-
-  **NOTE:** Bear in mind that a **protected roll** is protected from use unless the roll number or its paper type are specifically requested. See [Roll protection on page 63](#).
 -  **NOTE:** If the active roll cannot be cut by the automatic cutter, automatic switching is disabled, and jobs sent to the standby roll are put on hold for paper until the uncuttable roll is manually unloaded.
 -  **NOTE:** When you print from a USB flash drive, multiroll printing is considerably simplified: either you specify manually which roll you want to use, or you can select **Save paper**, in which case the printer chooses the narrowest roll on which the print will fit. You cannot specify the paper type.
-

How the printer allocates jobs to paper rolls

When you submit a print job from the Embedded Web Server or the printer driver, you can specify (using the **Paper type** or **Type is** option) that you want it to be printed on a particular paper type; you can even specify (using the **Paper source**, **Source is** or **Paper Feed** option) that you want it to be printed on a particular roll (1 or 2). The printer will try to satisfy these requirements, and it will also look for a paper roll large enough to print the image without clipping.

- If both rolls are suitable for the job, the roll will be chosen according to the roll switching policy. See [Roll switching options \(Z5600 only\) on page 22](#).
- If just one of the rolls is suitable for the job, it will be printed on that roll.
- If neither roll is suitable for the job, it will be put on hold for paper, or printed on an unsuitable roll, depending on the paper mismatch action. See [Paper mismatch action on page 22](#).

The printer driver for Windows will tell you which paper types and widths are currently loaded in the printer, and on which rolls.

Here are some settings that may be used in typical situations.



NOTE: The **Type is** and **Source is** settings are in the printer driver and the Embedded Web Server; the **Roll switching policy** is set in the front panel.

- With different paper types loaded:
 - **Type is:** select the paper type you require
 - **Source is:** Automatically select / Predetermined
 - **Roll switching policy:** doesn't matter
- With different paper widths loaded:
 - **Type is:** Use Printer Settings
 - **Source is:** Automatically select / Predetermined
 - **Roll switching policy:** Minimize paper waste



TIP: You can also save paper in some cases by rotating or nesting your images. See [Use paper economically on page 61](#).

- With identical rolls loaded:
 - **Type is:** Use Printer Settings
 - **Source is:** Automatically select / Predetermined
 - **Roll switching policy:** Minimize roll changes

7 Printing

- [Introduction](#)
- [Print from a USB flash drive](#)
- [Print from a computer using the Embedded Web Server or HP DesignJet Utility](#)
- [Print from a computer using a printer driver](#)
- [Advanced print settings](#)

Introduction

You can choose to print in the following different ways, depending on your circumstances and preferences.

- Print a TIFF, JPEG, HP-GL/2, RTL, PDF, or PostScript file directly from a USB flash drive. See [Print from a USB flash drive on page 51](#).
- Print a file that is already in the job queue. See [Reprint a job from the queue on page 67](#).
- Print a TIFF, JPEG, HP-GL/2, RTL, PDF, or PostScript file directly from a computer connected to the printer, using the Embedded Web Server or the HP DesignJet Utility. See [Print from a computer using the Embedded Web Server or HP DesignJet Utility on page 52](#).
- Print any kind of file from a computer connected to the printer, using a software application that can open the file, and a printer driver supplied with your printer. See [Print from a computer using a printer driver on page 53](#).

Print from a USB flash drive

1. Insert a USB flash drive containing one or more TIFF, JPEG, HP-GL/2, RTL, PDF, or PostScript files into one of the printer's USB ports.

 **NOTE:** The use of USB flash drives with your printer may be disabled by the administrator: see [Control access to the printer on page 24](#).

2. At the front panel, go to the home screen and press .

3. Select the file to be printed. Files that can be printed are indicated with a file-type icon:

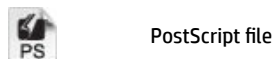



Files that cannot be printed are indicated with .

You can press folders to browse their contents.

4. The default print settings are displayed. If you want to change them, press **Settings**. The following settings are available:
 - **Size** allows you to resize the print in two different ways: to a percentage of its original size, or to fit a particular paper size. The default is 100% (its original size).
 - **Color** allows you to choose color or grayscale printing.

- **Print quality** allows you to set the print quality to **Best**, **Normal** or **Fast**.
- **Roll** allows you to specify printing on roll 1 or roll 2, or you can choose **Save paper**, which automatically chooses the narrowest roll on which the print will fit.
- **Rotation** allows you to rotate the print by any multiple of 90°, or you can choose **Automatic**, which rotates the print automatically if that will save paper.
- **Printer margins** offers two options:
 - **Clip from contents** clips the margins from the original image.
 - **Add to contents** adds the margins to the original image.

 **NOTE:** If you change the settings in this way, the changed settings apply to the current job but are not saved permanently. You can change the default settings by pressing , then , then **Print from USB preferences**.

5. To display a preview of the printed job on the front panel, press .

When the preview is displayed, you can press it to zoom in on it. Press it again to zoom out.

6. When you are satisfied with the print settings, press **Start**.
7. If two rolls are loaded, you can choose to print on either roll, or you can let the printer choose automatically.

 **NOTE:** The printer will automatically rotate the image by 90° if it can save paper by doing so.

8. After printing, you can choose to print another file or go to the job queue. If you print another file immediately without returning to the home screen, the temporary settings used for the previous file are used again.

Print from a computer using the Embedded Web Server or HP DesignJet Utility

You can print files in this way from any computer that can access the printer's Embedded Web Server. See [Access the Embedded Web Server on page 28](#).

From the Embedded Web Server, select the **Main** tab and then **Submit job**. From the HP DesignJet Utility, select **Job Center** > **Submit Job**. You will see the window below.

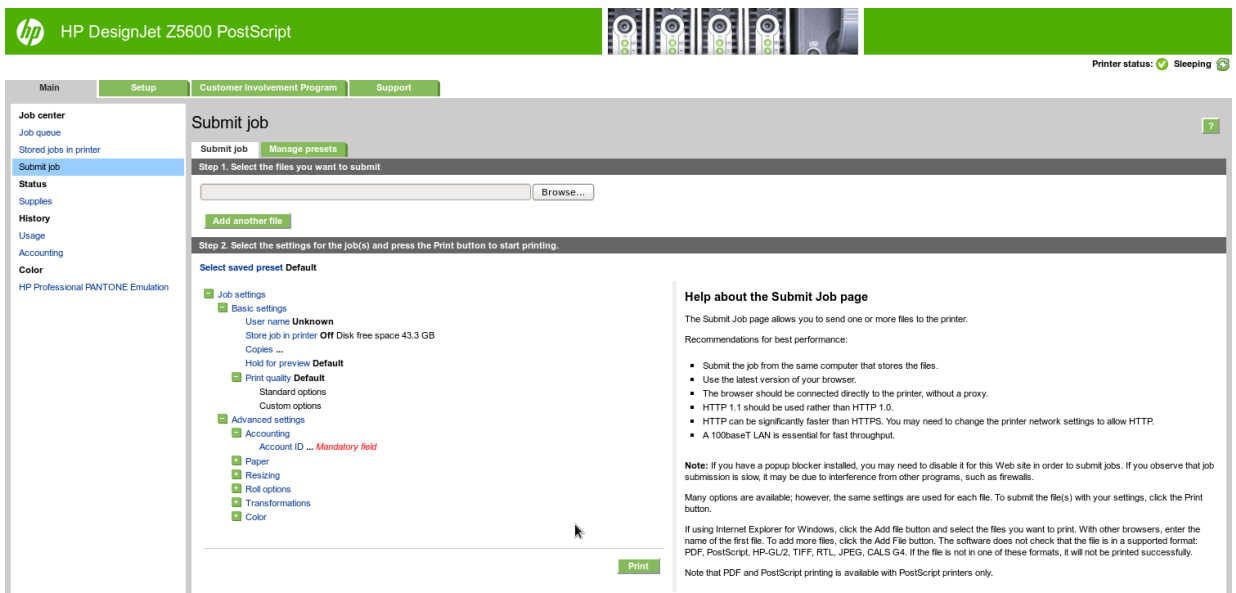

Press the **Add another file** button to choose the files from your computer that you want to print. The files must be in one of the following formats:

- HP-GL/2
- RTL
- TIFF
- JPEG
- PDF
- PostScript



NOTE: When you print to a file, the file should be in one of the above formats, but its name may have an extension such as **.plt** or **.prn**.

If the files are not in one of these formats, they will not be printed successfully.

If the jobs have been generated with the appropriate settings (such as page size, rotation, resizing and number of copies), you can just press the **Print** button and they will be sent to the printer.

If you need to specify printing settings, go to the **Job settings** section and select the options you need. Each option has explanatory text on the right, so that you can understand the behavior of each setting. Remember that, if you leave the setting as **Default**, the setting saved in the job will be used. If the job contains no setting, the setting in the printer will be used.

If you have chosen some non-default settings and expect to reuse the same group of settings in the future, you can save them all under a single name from the **Manage presets** tab, and recall them using that name later.

Print from a computer using a printer driver

This is the traditional way of printing from a computer. The correct printer driver must be installed on the computer (see [Installing the software on page 13](#)), and the computer must be connected to the printer.

When the printer driver has been installed and the computer is connected to the printer, you can print from a software application by using the application's own **Print** command and selecting the correct printer.

Advanced print settings

The rest of this chapter explains the various print settings that you can use when printing with a printer driver, the Embedded Web Server or the HP DesignJet Utility. These methods offer a relatively large number of settings in order to satisfy all requirements.

 **TIP:** In general you are recommended to use the default settings unless you know that they do not meet your requirements.

TIP: If you intend to reuse a particular group of settings repeatedly, you can save those settings under a name of your own choice and recall them later. A saved group of settings is known as a 'quick set' in the Windows printer driver, and as a 'preset' in the Embedded Web Server.

Select print quality

The printer has various print-quality options because best-quality printing requires some loss of speed, while fast printing implies some reduction in print quality.



Therefore, the standard print-quality selector is a slider that allows you to choose between quality and speed. With some paper types, you can choose a compromise position between the two.

Alternatively, you can select from the custom options: **Best**, **Normal** and **Fast**. If you select **Fast**, you can also select **Economode**, which uses a lower rendering resolution and consumes less ink. It therefore increases printing speed even further, but reduces print quality. **Economode** can be selected only from the custom options (not from the slider).

There is also a supplementary custom option that may have an effect on print quality: **Maximum detail**. See [High-quality printing on page 59](#).

 **NOTE:** In the Windows driver dialog, the rendering resolution for your job is displayed in the Custom Print Quality Options dialog box (select **Custom options** and then **Settings**). In the Mac OS X Print dialog, select **Show Presets** in the presets list, then choose the **Paper/Quality** list.

You can select print-quality options in the following ways:

- **In the Windows driver dialog:** go to the **Paper/Quality** tab and look at the Print Quality section. If you select **Standard Options**, you will see a simple slider with which you can select speed or quality. If you select **Custom Options**, you will see the more specific options described above.
- **In the Mac OS X Print dialog:** go to the **Paper/Quality** panel and look at the Quality Options section. If you select **Standard** quality options, you will see a simple slider with which you can select speed or quality. If you select **Custom** quality options, you will see the more specific options described above.
- **On the Embedded Web Server's Submit Job page:** select **Basic settings** > **Print quality**. If you then select **Standard options**, you can choose between **Speed** and **Quality**. If you select **Custom options**, you will see the more specific options described above.
- **Using the front panel:** press , then , then **Setup** > **Printing preferences** > **Print quality**.

 **NOTE:** If the print quality is set from your computer, it overrides the print-quality setting in the front panel.

 **NOTE:** You cannot change the print quality of pages that the printer is already receiving or has already received (even if they have not started to print yet).



Select paper size

The paper size can be specified in the following ways.

 **NOTE:** The paper size specified here should be the paper size in which the document was created. It is possible to rescale the document to a different size for printing. See [Rescale a print on page 57](#).

- **In the Windows driver dialog:** select the **Paper/Quality** tab, then select your paper size from the **Document Size** list.
- **In the Mac OS X Page Setup dialog:** select your printer from the **Format for** list, then select your paper size from the **Paper Size** list.

 **NOTE:** If your application offers no **Page Setup** dialog, use the **Print** dialog.

- **On the Embedded Web Server's Submit Job page:** select **Advanced settings > Paper > Page size > Standard**.
- **Using the front panel:** press , then , then **Setup > Printing preferences > Paper options > Select paper size**.

 **NOTE:** If the paper size is set from your computer, it overrides the paper size setting in the front panel.

Custom paper sizes

If you want to choose a paper size that is not included in the list of standard paper sizes, there are various different ways to specify it.

Use the Windows printer driver

1. Select the **Paper/Quality** tab.
2. Press the **Custom** button.
3. Enter the name and dimensions of your new paper size.
4. Press **OK**. The new paper size is automatically selected.

A custom paper size created in this way has the following characteristics:

- The paper size is permanent. It will not disappear if the driver is closed or the computer is turned off.
- The paper size is local to the printer queue. It will not be seen from other printer queues in the same computer.
- In Domain server networks, the paper size is local to the computer. It will not be seen from other computers sharing the printer queue.
- In Workgroup networks, the paper size will be shared among all the computers sharing the printer queue.
- If the printer queue is deleted, the paper size is deleted with it.

Use Windows forms

1. From the Start menu, or from the Control Panel, select **Printers and Faxes**.
2. From the **File** menu, select **Server Properties**.
3. In the **Forms** tab, check the **Create a new form** box.
4. Enter the name and dimensions of your new paper size. Leave the margins as 0.00.
5. Press the **Save Form** button.
6. Go to the printer driver, and select the **Paper/Quality** tab.

7. Select **More...** from the drop-down list of paper sizes.
8. Select your new paper size from the group of Custom sizes.

A custom paper size created in this way has the following characteristics:

- The paper size is permanent. It will not disappear if the driver is closed or the computer is turned off.
- Restricted users cannot create paper forms. The “manage documents” role in the Windows Active Directory is the minimum required.
- The paper size is local to the computer. It will be seen in all the printer queues that have been created on the computer and that support paper of that size.
- If a printer queue is shared, this paper size will appear in all the client computers.
- If a printer queue is shared from another computer, this paper size will **not** appear on the driver’s document size list. A Windows form in a shared queue needs to be created in the server.
- If the printer queue is deleted, the paper size is not deleted.

Use the Mac OS X printer driver

1. Go to the **Page Setup** dialog.



NOTE: If your application offers no **Page Setup** dialog, use the **Print** dialog.

2. Select **Paper Size > Manage Custom Sizes**.

Use the Embedded Web Server

1. Go to the **Submit Job** page.
2. Select **Advanced settings > Paper > Page size > Custom**.

Select margins options

By default, the printer leaves a 5 mm margin between the edges of your image and the edges of the paper (increased to 17 mm at the foot of cut-sheet paper). However, you can change this behavior in several ways.

- **In the Windows driver dialog:** select the **Paper/Quality** tab and then the **Margins/Layout** button.
- **In the Mac OS X Print dialog:** select the **Margins/Layout** panel.
- **On the Embedded Web Server's Submit Job page:** select **Advanced settings > Paper > Layout/Margins**.

You will then see at least some of the following options.



NOTE: Under Mac OS X, the available margins options depend on the paper size selected. For instance, for borderless printing you must select a paper size name that includes the words “no margins”.

- **Standard.** Your image will be printed on a page of the size you have selected, with a narrow margin between the edges of the image and the edges of the paper. The image should be small enough to fit between the margins.
- **Oversize.** Your image will be printed on a page slightly larger than the size you have selected. If you cut off the margins, you will be left with a page of the size you selected, with no margins remaining between your image and the edges of the paper.
- **Clip Contents By Margins.** Your image will be printed on a page of the size you have selected, with a narrow margin between the edges of the image and the edges of the paper. In this case, if the image is the same size as the page, the printer assumes that the extreme edges of the image are either white or

unimportant, and do not need to be printed. This may be useful when your image already contains a border.

- **Borderless.** Your image will be printed on a page of the size you have selected, with no margins. The image is slightly enlarged to ensure that no margin is left between the edges of the image and the edges of the paper. If you select **Automatically by Printer**, this enlargement is done automatically. If you select **Manually in Application**, you must select a custom page size slightly larger than the page on which you intend to print. See also [Print with no margins on page 60](#).

Print on loaded paper

To print a job on whichever paper is loaded in the printer, select **Use Printer Settings** in the Paper Type option of your printer driver.

- **In the Windows driver dialog:** select the Paper/Quality tab, then select **Use Printer Settings** in the Paper Type drop-down list.
- **In the Mac OS X Print dialog:** select the Paper/Quality panel, then select **Any** in the Paper Type drop-down list.





NOTE: **Use Printer Settings** (Windows) or **Any** (Mac OS X) is the default Paper Type selection.

Rescale a print

You can send an image to the printer at a certain size but tell the printer to rescale it to a different size (normally larger). This may be useful:

- If your software does not support large formats
- If your file is too large for the printer's memory—in this case, you can reduce the paper size in your software and then scale it up again using the front-panel option

You can rescale an image in the following ways:

- **In the Windows driver dialog:** go to the **Features** tab and look at the Resizing Options section.
 - The **Print document on** option adjusts the image size to the paper size you have selected. For example, if you have selected ISO A2 as the paper size and you print an A3-sized image, it is enlarged to fit the A2 paper. If the ISO A4 paper size is selected, the printer reduces a larger image to fit the A4 size.
 - The **% of actual size** option enlarges the printable area of the original paper size (the page minus the margins) by the percentage indicated, then adds the margins to create the output paper size.
- **In the Mac OS X Print dialog:** select the **Finishing** panel, then **Print document on**, and select the paper size to which you want to scale the image. For example, if you have selected ISO A2 as the paper size and you print an A3-sized image, it is enlarged to fit the A2 paper. If the ISO A4 paper size is selected, the printer reduces a larger image to fit the A4 size.
- **On the Embedded Web Server's Submit Job page:** select **Advanced settings > Resizing**.
 - The **Standard** and **Custom** options adjust the image size to the standard or custom paper size you have selected. For example, if you have selected ISO A2 as the paper size and you print an A4-size image, it is enlarged to fit the A2 paper. If the ISO A3 paper size is selected, the printer reduces a larger image to fit the A3 size.
 - The **% of actual size** option enlarges the printable area of the original paper size (the page minus the margins) by the percentage indicated, then adds the margins to create the output paper size.
- **Using the front panel:** press , then , then **Setup > Printing preferences > Paper options > Resize**.



If you are printing to a single sheet, you must ensure that the image can actually fit onto the sheet, otherwise the image will be clipped.

Change the treatment of overlapping lines

 **NOTE:** This topic applies only when printing an HP-GL/2 job.

The merge option controls the overlapping lines in an image. There are two settings:

- **Off:** where the lines cross, only the color of the top line is printed. This is the default setting.
- **On:** where the lines cross, the colors of the two lines merge.

To turn merge on, go to the front panel and press , then , then **Setup > Printing preferences > HP-GL/2 options > Enable merge**. You can set the merge option from your software in some applications. Settings in your software override the front-panel settings.



Preview a print

Previewing a print on the screen allows you to check the layout of the print before printing, which may help you to avoid wasting paper and ink on a bad print.



- To preview a print under Windows, you have the following options:
 - Use your application's print preview option.
 - Check the **Show preview before printing** option, which you can find in the driver's **Paper/Quality** tab and **Features** tab. This preview is provided by the Embedded Web Server and will appear in a Web browser window.
- To preview a print under Mac OS X, you have the following options:
 - Use your application's print preview option.
 - There is no **Preview** button at the bottom of the Print dialog box in the latest versions of Mac OS X. A print preview is always shown at the upper left of the Print dialog box for most applications.
 - Click **Pause** in the job queue window, send the job to print, and select **Add to Printer**. Then double-click the job in the job queue window.
 - Choose the **HP Print Preview** option from the **PDF** menu at the bottom of the Print dialog box. The print preview is displayed by a separate HP Print Preview application.
- To preview a print using the Embedded Web Server, select **Basic settings > Hold for preview**.

Print a draft

You can specify fast draft-quality printing in the following ways:

- **In the Windows driver dialog:** go to the **Paper/Quality** tab and look at the Print Quality section. Move the print-quality slider to the extreme left ('Speed').
- **In the Mac OS X Print dialog:** go to the **Paper/Quality** panel and move the print-quality slider to the extreme left ('Speed').
- **On the Embedded Web Server's Submit Job page:** select **Basic settings > Print quality > Standard options > Speed**.
- **Using the front panel:** press , then , then **Setup > Printing preferences > Print quality > Select quality level > Fast**.



You can specify even faster draft-quality printing by using Economode, as follows. This is intended mainly for documents containing only text and line drawings.

- **In the Windows driver dialog:** go to the **Paper/Quality** tab and look at the Print Quality section. Select **Custom Options**, then set the quality level to **Fast** and check the **Economode** box.
- **In the Mac OS X Print dialog:** go to the **Paper/Quality** panel and set the quality options to **Custom**, then set quality to **Fast** and check the **Economode** box.
- **On the Embedded Web Server's Submit Job page:** select **Basic settings > Print quality > Custom**. Set **Quality level** to **Fast**, and **Economode** to **On**.
- **Using the front panel:** press , then , then **Setup > Printing preferences > Print quality > Enable economode**.

 **NOTE:** If the print quality is set from your computer, it overrides the print-quality setting in the front panel.

High-quality printing



You can specify high-quality printing in the following ways:

- **In the Windows driver dialog:** go to the **Paper/Quality** tab and look at the Print Quality section. Move the print-quality slider to the extreme right ('Quality').
- **In the Mac OS X Print dialog:** go to the **Paper/Quality** panel and move the print-quality slider to the extreme right ('Quality').
- **On the Embedded Web Server's Submit Job page:** select **Basic settings > Print quality > Standard options > Quality**.
- **Using the front panel:** press , then , then **Setup > Printing preferences > Print quality > Select quality level > Best**.

 **NOTE:** If the print quality is set from your computer, it overrides the print-quality setting in the front panel.

If you have a high-resolution image

If your image has a resolution greater than the rendering resolution (which you can see in the Custom Print Quality Options box under Windows), print sharpness may be improved by selecting the Maximum Detail option. This option is available only if you are printing on glossy paper and you have selected **Best** print quality.

- **In the driver dialog (Mac OS X Print dialog):** select Custom instead of Standard print-quality options, then check the **Maximum Detail** box.
- **On the Embedded Web Server's Submit Job page:** select **Basic settings > Print quality > Custom**. Set **Quality level** to **Best**, and **Maximum detail** to **On**.
- **Using the front panel:** press , then , then **Setup > Printing preferences > Print quality > Enable maximum detail**.

 **NOTE:** The Maximum Detail option results in slower printing with photo papers, but it does not increase the amount of ink used.

Print in gray shades

You can convert all colors in your image to shades of gray: see [Printing in grayscale on page 77](#).

Print with no margins

Printing with no margins (to the edges of the paper) is known as borderless printing. This can be done only on rolls of glossy paper.

In order to be sure of leaving no margins, the printer prints slightly past the edges of the paper. Any ink deposited outside the paper is absorbed by the sponge situated in the platen.

You can request printing with no margins in the following ways:

- **In the Windows driver dialog:** select the **Paper/Quality** tab and press the **Margins/Layout** button. Then select **Borderless**.
- **In the Mac OS X Page Setup dialog:** select a paper size name that includes the words “no margins”. Then, in the **Print** dialog, select **Margins/Layout > Borderless**.



NOTE: If your application offers no **Page Setup** dialog, use the **Print** dialog.

- **On the Embedded Web Server's Submit Job page:** select **Advanced settings > Paper > Layout/Margins > Borderless**.

When you select **Borderless**, you must also select one of the following Image Enlargement options:

- **Automatically by printer** means that the printer automatically enlarges your image slightly (normally by a few millimeters in each direction) in order to print over the edges of the paper.
- **Manually in application** means that you must enlarge the image yourself in your application, and select a custom paper size that is slightly larger than the actual paper size.



NOTE: If the first print job after loading paper is a borderless job, the printer may trim the leading edge of the paper before printing.

At the end of a borderless print, the printer normally cuts the print slightly inside the image area to ensure that the print is borderless. It then cuts the paper again so that no residual part of the image is included in the next print. However, if the job is cancelled, or if there is white space at the bottom of the image, only a single cut is made.

Print with crop lines

Crop lines indicate where the paper should be cut to reduce it to your selected page size. You can print crop lines with individual jobs in the following ways:

- **In the Windows driver dialog:** select the **Features** tab, then **Crop lines**.
- **In the Mac OS X Print dialog:** select the **Finishing** panel, then **Crop lines**.
- **On the Embedded Web Server's Submit Job page:** select **Advanced settings > Roll options > Enable crop lines > Yes**.

Alternatively, you can choose to print crop lines with all jobs by default:

- **In the Embedded Web Server:** select **Setup > Printer settings > Job management > Use crop lines when printing > On**.
- **Using the front panel:** press , then , then **Setup > Printing preferences > Paper > Enable crop lines > On**.

To print crop lines with nested jobs (see [Nest jobs to save roll paper on page 61](#)), you must select a different option:

- **In the Embedded Web Server:** select **Setup > Printer settings > Job management > Use crop lines when nest is enabled > On**.
- **Using the front panel:** press , then , then **Setup > Job management > Nest options > Enable crop lines > On**.

Use paper economically

Here are some recommendations for making economical use of paper:

- If you are printing relatively small images or document pages, you can use nesting to print them side by side instead of one after another. See [Nest jobs to save roll paper on page 61](#).
- You may be able to save some roll paper by using the following options:
 - **In the Windows driver dialog:** select the **Features** tab and then **Remove top/bottom blank areas** and/or **Rotate by 90 degrees** or **Autorotate**.
 - **In the Mac OS X Print dialog:** select the **Finishing** panel, then **Remove Blank Areas** and/or **Rotate by 90 degrees**.
 - **On the Embedded Web Server's Submit Job page:** select **Advanced settings > Roll options > Remove top/bottom blank areas** and/or **Rotate**.
- If you check the print preview on your computer before printing, you can sometimes avoid wasting paper on prints containing obvious mistakes. See [Preview a print on page 58](#).

Nest jobs to save roll paper

Nesting means automatically printing images or document pages side by side on the paper, rather than one after the other. This is done to avoid wasting paper.

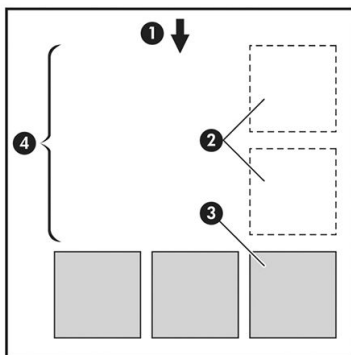

1. Direction of paper flow
2. Nesting off
3. Nesting on
4. Paper saved by nesting

When does the printer try to nest pages?

When both of the following are true:

- The printer is loaded with roll paper, not sheet paper.
- The printer's **Nest** option is turned on. See [Turn nesting on and off on page 22](#).

What pages can be nested?



All pages can be nested, unless they are so large that two of them cannot fit side by side on the roll, or unless there are too many of them to fit into the remaining length of the roll. A single group of nested pages cannot be split between two rolls.

Which pages qualify for nesting?

In order to be in the same nest, the individual pages must be compatible in all of the following ways:

- All pages must have the same print quality setting (**Economode**, **Fast**, **Normal** or **Best**).
- The **Maximum Detail** setting must be the same on all pages.
- The **Layout/Margins** setting must be the same for all pages.
- The **Mirror Image** setting must be the same for all pages.
- The **Rendering Intent** must be the same for all pages.
- The **Cutter** setting must be the same for all pages.
- The color adjustment settings must be the same for all pages. See [Color adjustment options on page 76](#).
- Pages must be all color, or all grayscale: not some in color and some in grayscale.
- All pages must be in one or other of the following two groups (the two groups cannot be mixed in the same nest):
 - HP-GL/2, RTL, TIFF, JPEG
 - PostScript, PDF
- JPEG and TIFF pages with resolutions greater than 300 dpi may not nest with other pages in some cases.

How long does the printer wait for another file?

So that the printer can make the best nest possible, it waits after a file has been received to check whether a subsequent page will nest with it or with pages already in the queue. This waiting period is the nest wait time; the factory default nest wait time is 2 minutes. This means that the printer waits for up to 2 minutes after the last file is received before printing the final nest. You can change this waiting time from the printer's front panel: press , then , then **Setup > Job management options > Nest options > Select wait time**. The available range is 1 to 99 minutes.

While the printer is waiting for nesting to time out, it displays the remaining time on the front panel.

Use ink economically

Here are some recommendations for making economical use of ink.

- For draft prints, use plain paper and move the print-quality slider to the left end of the scale ('Speed'). For further economy, select custom print quality options, then select **Fast** and **Economode**.
- Clean the printheads only when needed, and clean only those printheads that need cleaning. Cleaning the printheads can be useful, but it uses a small amount of ink.

- Leave the printer permanently turned on so that it can maintain the printheads in good condition automatically. This regular printhead maintenance uses a small amount of ink. However, if it is not done, the printer may need to use much more ink later to restore the health of the printheads.
- Wide prints make more efficient use of ink than narrow prints, because printhead maintenance uses some ink, and its frequency is related to the number of passes made by the printheads. Therefore, nesting jobs can save ink as well as saving paper (see [Nest jobs to save roll paper on page 61](#)).

Roll protection

If you choose to protect a roll, jobs will be printed on it only if the job explicitly specifies the roll number or the paper type loaded on the roll. This may be useful, for example, in the following cases.

- To stop people from accidentally printing unimportant jobs on expensive paper.
- To avoid printing on a particular roll when printing from AutoCAD without interacting with the HP printer driver.

To protect a roll, go to the front panel and press , then , then **Setup > Printing preferences > Paper options > Roll protection**.

 **NOTE:** If you protect a roll, then later unload the current roll and load a new one, the new roll remains protected. You are protecting the roll number, not one specific roll of paper. That roll number will remain protected until you cancel the protection.

 **TIP:** If you print without specifying a roll number or paper type, you will not be able to print on any protected roll.

Unattended printing/overnight printing



The printer is well suited to long, unattended print jobs, having multiple rolls plus robust and consistent image quality.

Here are some recommendations to help you deal with a long queue of printing jobs.

- If feasible, use brand-new long rolls of paper.
- If you want to print on partly-used rolls, you can check the paper type and the remaining length in the Embedded Web Server or in the front panel, to confirm that you have enough paper to print all your jobs.

 **NOTE:** Information on the remaining length is available only if you told the printer the length of the roll when you loaded it, or if the printer read the length of the roll from the barcode printed on it.

- Load two rolls of paper suitable for your jobs. If the printer finishes one roll, it will automatically switch to the other.
- If you intend to use two rolls, avoid using uncuttable paper (such as canvas) for the first roll, because then the printer will be unable to switch to the other roll.
- Check that you have paper wide enough to print all of your jobs. Any jobs that are too wide may be put on hold for paper if the paper mismatch action is set to **Put job on hold** (see [Paper mismatch action on page 22](#)).
- Check the ink levels remaining in your ink cartridges.
- When you have submitted your print jobs, you can use the Embedded Web Server from a remote location to monitor their status.

- Drying time should be set to **Optimal**.
- Press , then , then **Setup > Printing preferences > Paper options > Roll switching options > Minimize roll changes** or **Use roll with less paper**.

We recommend the following settings, depending on the paper type and what kind of prints you are making.

Recommended settings for unattended printing

Print type	Print mode	Max Detail	Drying time	Paper types
Lines	Normal	Off	Optimal	Coated, Bond, Heavyweight Coated, Glossy
Lines and fills	Normal	Off	Optimal	Coated, Bond, Heavyweight Coated, Glossy
Maps	Best	Off	Optimal	Coated, Heavyweight Coated, Glossy
Renderings, photographs	Best	Off	Optimal	Coated, Heavyweight Coated, Glossy

8 Web-connected printing

Your printer can be connected to the Web, providing various benefits:

- Automatic firmware updates (see [Update the firmware on page 113](#))
- Print to your printer by sending it an email message with the file to be printed as an attachment. PDF, TIFF, and JPG files are supported.

For the latest information, see <http://www.hp.com/go/designjetprinters>.

Print by email

After you have enabled Web Services, you can print to your printer by email. Just check the Web Services menu, the ePrint menu, or press the  icon in the home screen header to show the email address of your printer, then send the file you want to print to that email address as an attachment.

In this way, you can print from anywhere with an Internet connection, without needing any printer driver. There are a few limitations that you should bear in mind:

- The attached files to be printed must be in PDF, JPEG, or TIFF format.
- The maximum file size is 10 MB, but your email server may have a lower limit.
- Files are printed in the original document size (at 100% scale), in normal quality, in color, and normally in portrait orientation (some printers may offer autorotation).
- The paper type is set to plain paper. If some other paper type is loaded, the printer may either print it anyway or put it on hold, depending on the paper mismatch action (see [Paper mismatch action on page 22](#)).

9 Job queue management

- [The job queue in the front panel](#)
- [The job queue in the Embedded Web Server or HP DesignJet Utility](#)

The job queue in the front panel

To see the job queue on the front panel, press  on the home screen.

Job queue page

The job queue page shows all jobs that are available in the job queue. It includes jobs that are being received, parsed, rendered, printed and already printed.

Each line shows the name of the job and its status. For more information on a particular job, including a preview of the job, press the line showing the job.

Jobs that cannot be completed for any reason appear at the top of the queue.

Job preview

The printer generates a JPEG file for each incoming job, which can be displayed as a preview of the job. Job preview is available once the job is processed.

 **NOTE:** Do not try to preview a job with more than 64 pages, which may cause software problems.

To preview a job, first press the name of the job in the job queue. The front panel displays a page of information about the job. Then press  to see the preview.



 **NOTE:** Previews may be blocked by an administrator, in which case you will not be able to see them.

When the preview is displayed, you can press it to zoom in on it. Press it again to zoom out.

You can also press  to preview the previous job, or  to preview the next job.

Select when to print a job in the queue

 **NOTE:** The When To Start Printing options cannot be used with PostScript jobs.

You can select at what point you want to print a file you have in the queue. Press , then , then **Setup > Job management options > When to start printing.**

There are three options you can select:

- When **After Processing** is selected, the printer waits until the whole page has been processed and then it starts to print. This is the slowest setting but ensures the best print quality in large or complex prints.
- When **Immediately** is selected, the printer prints the page as it is processed. This is the quickest setting, but the printer may stop halfway through a print to process data. This setting is not recommended for complex images with dense color.
- When **Optimized** is selected (this is the default setting), the printer calculates the best time to begin printing the page. It is usually the best compromise between the **After Processing** and **Immediately** settings.

Prioritize a job in the queue

You can select a job in the queue and make it the next one to be printed. After selecting the job, press **Move to front**.

If nesting is turned on, the prioritized job may still be nested with others. If you really want this job to be printed next, and not nested with others, first turn nesting off and then move it to the front of the queue as described above.

In the following cases, the **Move to front** button is not displayed:

- The job is already at the front of the queue.
- The job is on hold—in this case the **Resume printing** button is displayed instead.
- The job has finished—in this case the **Reprint** button is displayed instead.
- The job has some error condition.

Pause a job in the queue

If you select the job in the queue that is currently printing, you will see a **Pause** button, which you can press to pause printing. The **Pause** button then changes to a **Resume** button, which you can press to resume printing.

Alternatively, you can press the **Options** button at the top right of the job queue screen, and then press **Pause printing**.

Reprint a job from the queue

To reprint an already-printed job, select the job from the queue, then select **Reprint**.

When reprinting a print job, you cannot change the print settings, because the job has already been rasterized.

Delete a job from the queue

Under normal circumstances, there is no need to delete a job from the queue after printing it, as it will just fall off the end of the queue as more files are sent. However, if you have sent a file in error, and want to avoid printing it, you can simply select the job and then press **Delete**.

 **NOTE:** If an administrator password has been set, it will be required.

In the same way, you can delete a job that has not been printed yet.

If the job is currently being printed (its status is **printing**), you can press **Cancel** and then **Delete**.

Delete all jobs

To delete all jobs in a queue, press the **Options** button at the top right of the job queue screen, and then press **Delete all jobs**.



NOTE: If an administrator password has been set, it will be required.

Turn off the job queue

To turn off the job queue, press , then , then **Setup > Job management options > Queue > Off**.

The job queue in the Embedded Web Server or HP DesignJet Utility

The HP DesignJet Utility provides a different way of accessing the Embedded Web Server's job management facilities, but the facilities are exactly the same whether you use the Embedded Web Server or the HP DesignJet Utility.

To see the queue in the Embedded Web Server, select **Job queue** in the **Main** tab.

Job queue page

By default, access to the job queue is open to all users. An administrator can set a password so that users are required to enter a password for:

- Seeing job previews
- Canceling or deleting jobs

The job queue page shows all jobs that are available in the print queue. The print queue includes jobs that are being received, parsed, rendered, printed and already printed.

The Embedded Web Server displays the following information for each print job:

- **Preview:** Click the icon to see the job preview. The job preview is available once the job is processed.
- **File name:** Click the file name to see the properties of the job.
- **Status:** Gives the current job status.
- **Pages:** Number of pages in the job.
- **Copies:** Number of copies printed.
- **Date:** Date and time the printer received the job.
- **User:** The user's name.

Jobs in the queue can be sorted by any of the information items (except Preview) by clicking on the title of the corresponding column. You can perform the following operations on one or all jobs in the queue:

- **Cancel:** Cancels the selected jobs. You are asked to confirm before the job is canceled. The job remains stored in the printer, but will not be printed unless you click **Reprint**.
- **Hold:** Holds the select jobs until you click **Continue** to print.
- **Continue:** All selected jobs, which are on hold, continue printing.
- **Reprint:** Prints more copies of a job. Type the number of copies (default 1, maximum 99) and click **Print**.
- **Move to front:** Sends all selected jobs to the top of the job queue.
- **Delete:** Deletes selected jobs from the job queue. You are asked to confirm before the job is deleted.



NOTE: The **Delete** operation can be disabled by an administrator.

- **Refresh:** Refreshes the page, ensuring the information is updated.



NOTE: The job queue page does not automatically update.

Job preview

The printer generates a JPEG file for each incoming job, which can be displayed as a preview of the job. Job preview is available once the job is processed.

 **NOTE:** Do not try to preview a job with more than 64 pages, which may cause software problems.

To reach the preview page, click the magnifying glass icon, which appears in the Preview column on the job queue page. The preview page shows the following job details along with a thumbnail preview of the job:

- **File name:** The file name of the job.
- **Loaded paper:** The type of paper loaded in the printer.
- **Job dimensions:** The dimensions of the job.

To see a larger preview of the job, click either the job thumbnail or the magnifying glass icon, which appears on the right-hand side of the printer image.

 **NOTE:** Browsers without the Adobe Flash plug-in show the job image as yellow shaded. Browsers that have the Adobe Flash plug-in version 7 and above show an enhanced preview of the job image inside the paper loaded in the printer.

Select when to print a job in the queue

 **NOTE:** The When To Start Printing options cannot be used with PostScript jobs.

You can select at what point you want to print a file you have in the queue. Select the **Setup** tab, then **Printer settings > Start printing**.

There are three options you can select:

- When **After Processing** is selected, the printer waits until the whole page has been processed and then it starts to print. This is the slowest setting but ensures the best print quality in large or complex prints.
- When **Immediately** is selected, the printer prints the page as it is processed. This is the quickest setting, but the printer may stop halfway through a print to process data. This setting is not recommended for complex images with dense color.
- When **Optimized** is selected (this is the default setting), the printer calculates the best time to begin printing the page. It is usually the best compromise between the **After Processing** and **Immediately** settings.

Prioritize a job in the queue

You can select any job in the queue and make it the next one to be printed. After selecting the job, click **Reprint**.

If nesting is turned on, the prioritized job may still be nested with others. If you really want this job to be printed next, and not nested with others, first turn nesting off and then move it to the front of the queue as described above.

Delete a job from the queue

Under normal circumstances, there is no need to delete a job from the queue after printing it, as it will just fall off the end of the queue as more files are sent. However, if you have sent a file in error, and want to avoid printing it, you can simply select the job and then select **Delete**.

In the same way, you can delete a job that has not been printed yet.

If the job is currently being printed (its status is **printing**), you can select **Cancel** and then **Delete**.

Reprint or copy a job in the queue

To reprint or make extra copies of any job in the queue, select the job in the Embedded Web Server and click the **Reprint** icon, then specify the number of copies you want. The job will be moved to the top of the queue.

To make more than one print of a non-printed job in the queue from the front panel, select the job and choose **Copies**, then specify the number of copies required. This overrides any value set by your software.

 **NOTE:** If **Rotate** was **On** when you sent the file, every copy will be rotated.

 **NOTE:** You cannot use this method for PCL3 jobs. To reprint old jobs that are PCL3, you may be able to use your operating system's printer spooler, if you have already set the spooler to save old jobs. This facility depends on your operating system.

 **NOTE:** When reprinting a print job, you cannot change the print settings, because the job has already been rasterized.

Job status messages

These are the possible job status messages, approximately in the order in which they may be seen:

- **Receiving:** the printer is receiving the job from the computer
- **Waiting to process:** the job has been received by the printer and is waiting to be rendered (for jobs submitted through the Embedded Web Server only)
- **Processing:** the printer is parsing and rendering the job
- **Preparing to print:** the printer is performing writing system checks before printing the job
- **Waiting to print:** the job is waiting for the print engine to become free to proceed with printing
- **Waiting for nest:** the printer is set up with Nesting=On and is waiting for other jobs in order to complete the nest and proceed with printing
- **On hold:** the job was sent with the **on hold for preview** option and is on hold

 **NOTE:** Do not send a job for preview with more than 64 pages, this may cause the driver software to crash.

 **NOTE:** If the printer hangs up while printing a job, and the queue facility is turned on, the partially printed job will appear in the queue as **on hold** when the printer is next turned on. When you resume the job, it will start printing at the page at which it was interrupted.

- **On hold for paper:** the job cannot be printed because the right paper is not loaded in the printer, or because the active roll is uncuttable and so the printer cannot automatically switch to the standby roll. Load the required paper, see [Paper handling on page 32](#), and click **Continue** to resume the job.
- **On hold for accounting:** the job cannot be printed because the printer requires all jobs to have an account ID: enter the account ID and then click **Continue** to resume the job

 **TIP:** To set an account ID, see [Require account ID on page 26](#).

- **Printing**
- **Drying**
- **Cutting paper**
- **Ejecting page**
- **Canceling:** the job is being canceled, but will remain in the printer job queue
- **Deleting:** the job is being deleted from the printer
- **Printed**
- **Canceled:** the job has been canceled by the printer

- **Canceled by user**
- **Empty job:** the job does not contain anything to print

Reactivate a job on hold

When the printer puts a job on hold you receive an alert, see [Alerts on page 160](#), which explains why the job is on hold. Follow the instructions on the screen to remove the hold and continue printing.

Turn off the job queue

To turn off the job queue, select the **Setup** tab, then **Printer settings > Job management > Queue** and select **Off**.

10 Color management

- [Introduction](#)
- [How colors are represented](#)
- [A summary of the color management process](#)
- [Color calibration](#)
- [Color management from printer drivers](#)
- [Color management from the printer driver](#)
- [Color management from the Embedded Web Server](#)
- [Color management from the front panel](#)

Introduction

Color management is performed using a set of software tools that allow you to reproduce a color as accurately as possible on any display or printing device.

In addition, your printer has been engineered with advanced hardware and software features to ensure predictable and dependable results.

- Color calibration for consistent colors
- The Photo Black ink provides pure blacks when printing on photo papers
- Color emulation of other HP DesignJet printers

How colors are represented

Color is usually represented as an array of numbers: three numbers in the RGB color model or four in the CMYK color model. These numbers are a measure of the base colors used in a mixture to create a given color. RGB means that we are using a mixture of Red, Green, and Blue to create any specific color. In the case of CMYK, the mixture is of Cyan, Magenta, Yellow, and Key (where Key means black, for historical reasons).

Most monitors use the RGB color model, while most printers use the CMYK color model.

An image can be converted from one color model to another, but in general the conversion is not perfect. Your printer uses the RGB color model: the same color model that is used by your monitor.

This simplifies but does not completely solve the problem of matching colors. Each device represents colors a little differently from another device, even if they use the same color model. However, color management software can adjust the colors in an image according to the characteristics of the particular device, using a color profile of the device, in order to achieve correct colors.

A summary of the color management process

To get the accurate and consistent colors that you want, you should follow these steps for each paper type that you use.



1. Color-calibrate the paper type, for consistent colors. Calibration should be repeated every now and then (see [Color calibration on page 74](#)). In addition, you may wish to calibrate immediately before a particularly important print job for which color consistency is vital.
2. When printing, select the correct paper preset for the paper type you are using. The paper preset contains the color profile as well as various other characteristics of the paper. See [Paper presets on page 43](#).

Color calibration

Color calibration enables your printer to produce consistent colors with the particular printheads, inks and paper type that you are using, and under your particular environmental conditions. After color calibration, you can expect to get similar prints from any two different printers situated in different geographical locations.

Some paper types cannot be calibrated. For all other paper types, calibration should be done in any of the following circumstances:

- Whenever a printhead is replaced
- Whenever a new paper type is introduced that has not yet been calibrated with the current set of printheads
- Whenever the environmental conditions (temperature and humidity) change significantly

You can check the color calibration status of the currently loaded paper at any time by pressing  and then  on the front panel. The status may be one of the following:

- **Recommended:** the paper has not been calibrated.



NOTE: Whenever you update the printer's firmware, the color calibration status of all papers is reset to **Recommended**.



- **Obsolete:** the paper has been calibrated, but the calibration is now out of date because a printhead has been replaced, and should be repeated.
- **Done:** the paper has been calibrated, and the calibration is up to date.
- **Disabled:** this paper cannot be calibrated.



NOTE: Color calibration cannot be performed on plain paper, nor on any kind of transparent material.

You can also check the color calibration status by using the HP DesignJet Utility.

You can start color calibration in the following ways:

- From the HP DesignJet Utility for Windows: select **Color Center > Calibrate paper**, and choose the paper to be calibrated.
- From the HP DesignJet Utility for Mac OS X: select **Paper Preset Management**, choose the paper to be calibrated, press the  button and select **Calibrate Paper**.
- From the front panel: press , then , then **Image quality maintenance > Calibrate color**.

The calibration process is fully automatic and can be performed unattended after you have loaded paper of the type you wish to calibrate—which should be wider than 355 mm (14 in). If you have more than one roll loaded, the printer will ask which roll you want to use for the calibration.

The process takes about 3–5 minutes and consists of the following steps.

1. A calibration chart is printed, which contains patches of each ink used in your printer.



2. The chart is allowed to dry for a period of time that depends on the paper type, so that the colors have time to stabilize.
3. The chart is scanned and measured.
4. From the measurements, the printer calculates the necessary correction factors to apply for consistent color printing on that paper type. It also calculates the maximum amount of each ink that can be applied to the paper.

Color management from printer drivers

Color management options

The aim of color management is to reproduce colors as accurately as possible on all devices: so that, when you print an image, you see very similar colors as when you view the same image on your monitor.

There are two basic approaches to color management for your printer:

- **Application-Managed Colors:** in this case your application program must convert the colors of your image to the color space of your printer and paper type, using the ICC profile embedded in the image and the ICC profile of your printer and paper type.
- **Printer-Managed Colors:** in this case your application program sends your image to the printer without any color conversion, and the printer converts the colors to its own color space. The details of this process depend on the graphics language that you are using.
 - **PostScript:** the PostScript interpreter module performs the color conversion using the profiles stored in the printer and any additional profiles sent with the PostScript job. This kind of color management is done when you are using the PostScript driver and you specify printer color management or when you send a PostScript, PDF, TIFF or JPEG file directly to the printer through the Embedded Web Server. In either case you have to select the profiles to use as default (in case the job doesn't specify any) and the rendering intent to apply.
 - **Non-PostScript (PCL3, HP-GL/2, CALS/G4):** the color management is done using a set of stored color tables. ICC profiles are not used. This method is somewhat less versatile than the alternatives, but is a little simpler and faster, and can produce good results with standard HP paper types. This kind of color management is done when you send a PCL3, HP-GL/2, or CALS/G4 file directly to the printer through the Embedded Web Server.



NOTE: The printer can convert only the following color spaces to its own color space using the stored color tables: Adobe RGB and sRGB if you are using Windows, Adobe RGB if you are using Mac OS X.

You are recommended to consult the HP Support Center (see [HP Support Center on page 165](#)) to see how to use the color management options of your particular application.

To choose between **Application-Managed Colors** and **Printer-Managed Colors**:

- **In the Windows driver dialog:** select the **Color** tab.
- **In the Mac OS X Print dialog:** select the **Color Matching** panel. **Vendor Matching** or **In Printer** corresponds to **Printer-Managed Colors** mode. **ColorSync** should be used only if you cannot choose **Application-Managed Colors** in your application print dialog.
- **In some applications:** you can make this choice in the application.

Color adjustment options

The aim of color management is to print accurate colors. If you perform color management correctly, then you should be able to print accurate colors with no need of any manual color adjustments.

However, manual adjustments may be useful in the following situations:

- If your color management is not working correctly for some reason
- If you want colors that are subjectively pleasing rather than accurate

The printer driver provides different adjustment facilities depending on whether you are printing in color or in grayscale.

Printing in color

You can adjust the colors of your print under Windows:

- **In the Windows driver dialog:** select the **Color** tab, ensure that the **Advanced color adjustments** box is checked, then press the **Settings** button beside it.

You can then make adjustments using a lightness slider and three color sliders.

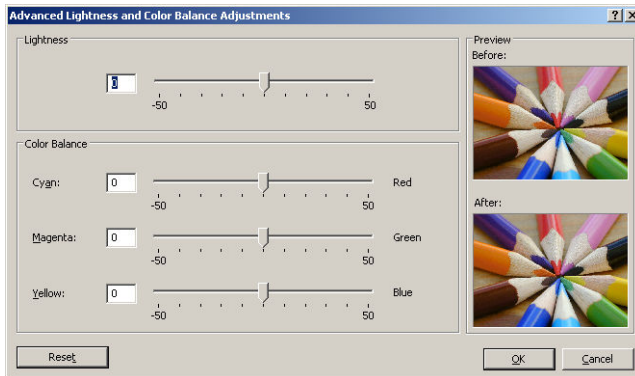

- The lightness slider simply makes the whole print lighter or darker.
- The color sliders can be used to fade or emphasize each of the primary colors in the print. The primary colors may be red, green and blue; or cyan, magenta and yellow; depending on the color model used in the image.

The **Reset** button restores each slider to its default central position.

Printing in grayscale

You can convert all colors in your image to shades of gray in the following ways:

- **In your application program:** many programs provide this option.
- **In the Windows driver dialog:** go to the **Color** tab and look at the Color Options section. Select **Print in Grayscale**.
- **In the Mac OS X Print dialog:** go to the **Color Options** panel and select **Grayscale** from the Mode drop-down list.
- **On the Embedded Web Server's Submit Job page:** select **Color**, then set **Color/Grayscale** to **Print In Grayscale**.

You can adjust the gray balance of your print under Windows:

- **In the Windows driver dialog:** select the **Color** tab, ensure that the **Advanced color adjustments** box is checked, then press the **Settings** button beside it.

You can then make adjustments using separate controls for highlights, midtones, and shadows.

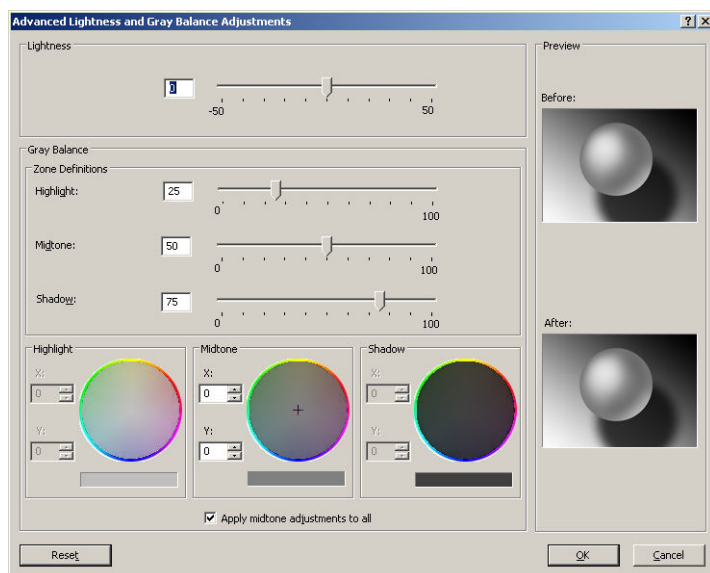

- The lightness slider simply makes the whole print lighter or darker. This slider is available in the same window as the other grayscale controls.
- The zone definition sliders can be used to define what you mean by highlight, midtone, and shadow.
- The other controls for highlight, midtone, and shadow can be used to adjust the gray balance of highlights, midtones, and shadows respectively.

The **Reset** button restores each control to its default setting.

Color management from the printer driver

HP Professional PANTONE Emulation

When you use a named PANTONE color in an image, your application will normally send to the printer a CMYK or RGB approximation to that color. But the application does not take the printer or the paper type into account, it merely produces a generic approximation of the PANTONE color, which will look different on different printers and on different papers.

HP Professional PANTONE Emulation can do a much better job by taking into account the characteristics of the printer and the paper type. The results look as similar to the original PANTONE colors as is possible on a given printer using a given paper type. This technology is designed to produce emulations similar to those set up manually by prepress professionals.

To use HP Professional PANTONE Emulation, all you have to do is to turn it on. In fact, it is normally on by default.

- **In the Windows driver dialog:** go to the **Color** tab and select **HP Professional PANTONE Emulation**.
- **In the Mac OS X Print dialog:** go to the **Color Options** panel and select **HP Professional PANTONE Emulation**.

You can also use the Embedded Web Server to print a swatch book showing emulations of PANTONE colors as made by your printer, together with a measure of the color difference (ΔE) between each emulation and the original PANTONE spot color. So HP Professional PANTONE Emulation not only provides the closest match that can be achieved on your printer; it also gives clear information on how close the emulation is to the original spot color. See [Printing PANTONE swatch books on page 80](#).

Color emulation

Your printer can emulate the color behavior of other devices: RGB devices such as monitors, and CMYK devices such as presses and printers.

You can set color emulation in the following ways:

- **In the Windows driver dialog:** select the **Color** tab, and **Printer Managed Colors**.
- **In the Mac OS X Print dialog:** select the **Color Matching** panel, then select **In Printer**. Color emulation is supported only by the PostScript driver in Mac OS X.

For a good emulation, the printer needs a specification of the colors these devices can reproduce. The standard way of encapsulating such information is in ICC profiles. As part of the solution, we provide the most common standards for the different devices.

The options are as follows.

RGB color emulation

Your printer is provided with the following color profiles:

- **None (Native):** no emulation, for use when the color conversion is done by the application or operating system, and therefore the data arrive at the printer already color-managed.
- **sRGB IEC61966-2.1** emulates the characteristics of the average PC monitor. This standard space is endorsed by many hardware and software manufacturers, and is becoming the default color space for many scanners, printers and software applications.
- **ColorMatch RGB** emulates the native color space of Radius Pressview monitors. This space provides a smaller gamut alternative to Adobe RGB (1998) for print production work.
- **Apple RGB** emulates the characteristics of the average Apple monitor, and is used by a variety of desktop publishing applications. Use this space for files that you plan to display on Apple monitors, or for working with old desktop publishing files.
- **Adobe RGB (1998)** provides a fairly large gamut of RGB colors. Use this space if you need to do print production work with a broad range of colors.

Color management from the Embedded Web Server

Submit Job options

When you send jobs to the printer using the Embedded Web Server's **Submit Job** page, you have the following color management options.

If you leave an option set to **Default**, the setting saved in the job will be used. If the job contains no setting, the front-panel setting in the printer will be used.

All jobs

- **Color/Grayscale:** you can choose to print in color or in shades of gray.
- **Default RGB source profile:** you can choose from a selection of RGB source profiles recognized by the printer.

PostScript or PDF jobs only

- **Default CMYK source profile:** you can choose from a selection of CMYK source profiles recognized by the printer. Default: **US Coated SWOP v2**.
- **Rendering intent:** you can select the rendering intent.
- **Black point compensation:** you can turn black point compensation on or off.
- **HP Professional PANTONE Emulation:** you can turn HP Professional PANTONE Emulation on or off.

Rendering intent

Rendering intent is one of the settings used when doing a color transformation. As you probably know, some of the colors you want to print may not be reproducible by the printer. The rendering intent allows you to select one of four different ways of handling these so-called out-of-gamut colors.

- **Saturation (graphics):** best used for presentation graphics, charts or images made up of bright, saturated colors.
- **Perceptual (images):** best used for photographs or images in which colors blend together. It tries to preserve the overall color appearance.
- **Relative colorimetric (proofing):** best used when you want to match a particular color. This method is mainly used for proofing. It guarantees that, if a color can be printed accurately, it will be printed accurately. The other methods will probably provide a more pleasing range of colors but do not guarantee that any particular color will be printed accurately. It maps the white of the input space to the white of the paper on which you are printing.
- **Absolute colorimetric (proofing):** the same as relative colorimetric, but without mapping the white. This rendering is also used mainly for proofing, where the goal is to simulate the output of one printer (including its white point).

Perform black point compensation

The black point compensation option controls whether to adjust for differences in black points when converting colors between color spaces. When this option is selected, the full dynamic range of the source space is mapped into the full dynamic range of the destination space. It can be very useful in preserving shadows when the black point of the source space is darker than that of the destination space. This option is allowed only when the **Relative colorimetric** rendering intent is selected (see [Rendering intent on page 80](#)).



Printing PANTONE swatch books



You can use the Embedded Web Server or the HP DesignJet Utility to print a swatch book showing emulations of PANTONE colors as made by your printer, together with a measure of the color difference (ΔE) between each emulation and the original PANTONE spot color.

To print a swatch book, select the Embedded Web Server's **Main** tab, then **HP Professional PANTONE Emulation**. Select the PANTONE stock to emulate, and one or more strips of PANTONE colors that you want to print. You can select color strips from more than one PANTONE stock. When you have selected all the colors you want, press the **Next** button. The next window displays your selection; you can press **Print** to print that selection, or **Back** to change the selection.



Color management from the front panel

You can color-calibrate the loaded paper type from the front panel by pressing , then , then **Image quality maintenance > Calibrate color**. See [Color calibration on page 74](#).

The other color options in the front panel can all be found by pressing , then , then **Printing preferences > Color options** (they can also be found under **Advanced printing preferences**).

 **NOTE:** These front panel settings can all be overridden by the printer driver or Embedded Web Server job submission settings.

All jobs

- **Color/Grayscale:** you can choose to print in color or in shades of gray. Default: **Print in color**.
- **Select RGB source profile:** you can choose from a selection of RGB source profiles recognized by the printer. Default: **sRGB IEC 1966-2.1**.

PostScript and PDF jobs only

- **Select CMYK source profile:** you can choose from a selection of CMYK source profiles recognized by the printer. Default: **US Coated SWOP v2**.
- **Select rendering intent:** you can select the rendering intent. Default: **Perceptual**.
- **Black point compensation:** you can turn black point compensation on or off. Default: **On**.
- **HP Professional PANTONE Emulation:** you can turn HP Professional PANTONE Emulation on or off. Default: **On**.

11 Practical printing examples

- [Print a draft for revision with the correct scale](#)
- [Print a document with the correct colors](#)
- [Print a project](#)
- [Print a presentation](#)
- [Print and scale from Microsoft Office](#)

Print a draft for revision with the correct scale

This section demonstrates how to print a draft for revision with the correct scale from Adobe Acrobat.

Using Adobe Acrobat

1. In the Acrobat window, bring the mouse cursor to the bottom left corner of the document pane to check the page size.

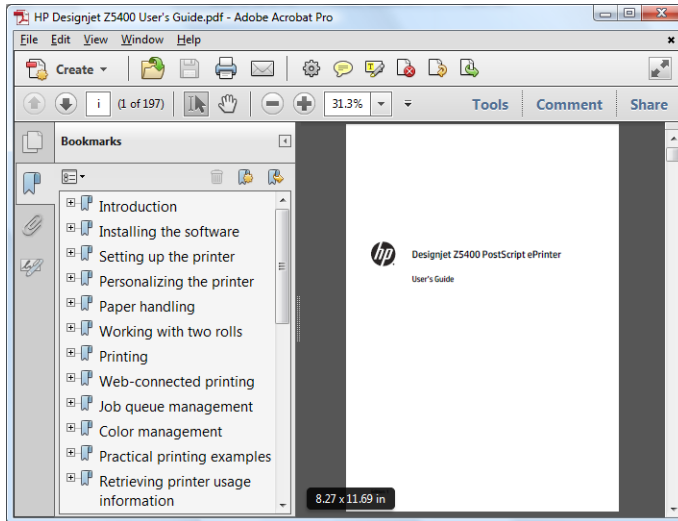

2. Select **File > Print** and ensure that **Page Scaling** is set to **None**.

 **NOTE:** The page size will **not** be automatically selected according to the drawing size.

3. Press the **Properties** button and then select the **Paper/Quality** tab.
4. Choose whatever **Document Size** and **Print Quality** you want to use. If you want to define a new custom paper size, press the **Custom** button.

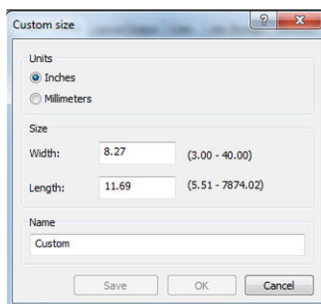

5. Select the **Features** tab, and then **Autorotate**.
6. Click **OK**, and check that the print preview in the Print dialog box seems correct.

Print a document with the correct colors

This section demonstrates how to print a document from Adobe Acrobat, with the emphasis on color management.

Using Adobe Acrobat Reader

Acrobat Reader is the most basic application for PDF files; several color management tools common in more sophisticated applications are not explicitly present, and work by default with presets that cannot be

changed. For example, there is no way to select a working color space; a default color space, most likely sRGB, is applied. This color space is used for screen display, for example. Also, as an alternative color profile when no other is specified by a file, as will be explained later.

Acrobat Reader print dialog

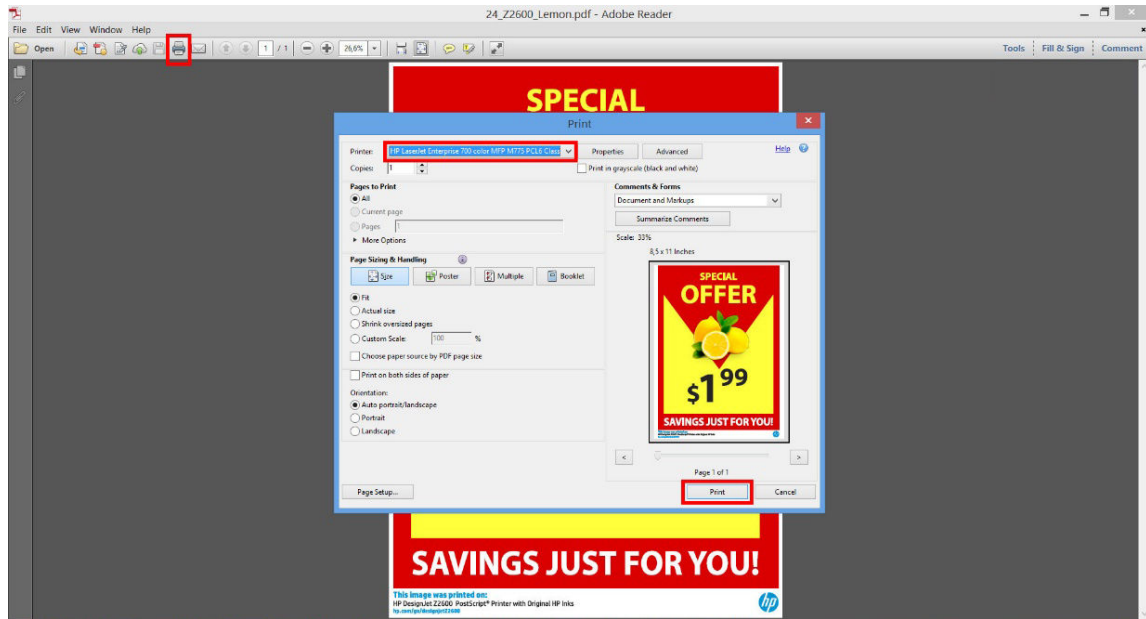

The printing process is very simple.

1. Select the printer and driver from the **Printer** drop-down menu in the Print dialog box. Driver settings can be adjusted by clicking the **Properties** button.

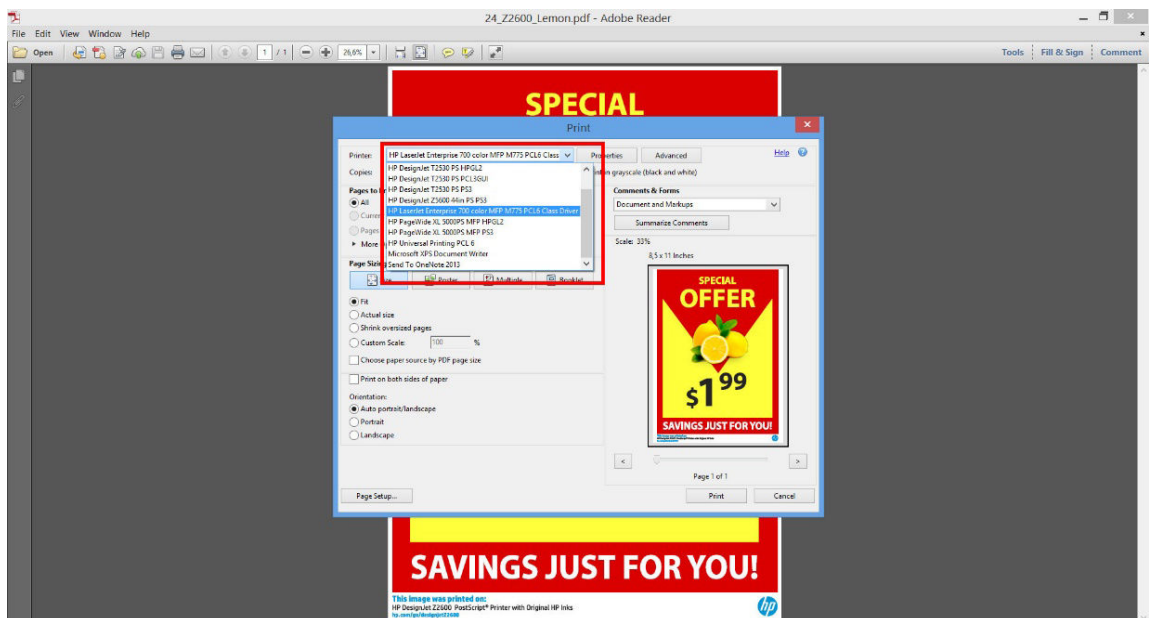

2. Adjust the color settings in the driver properties window.

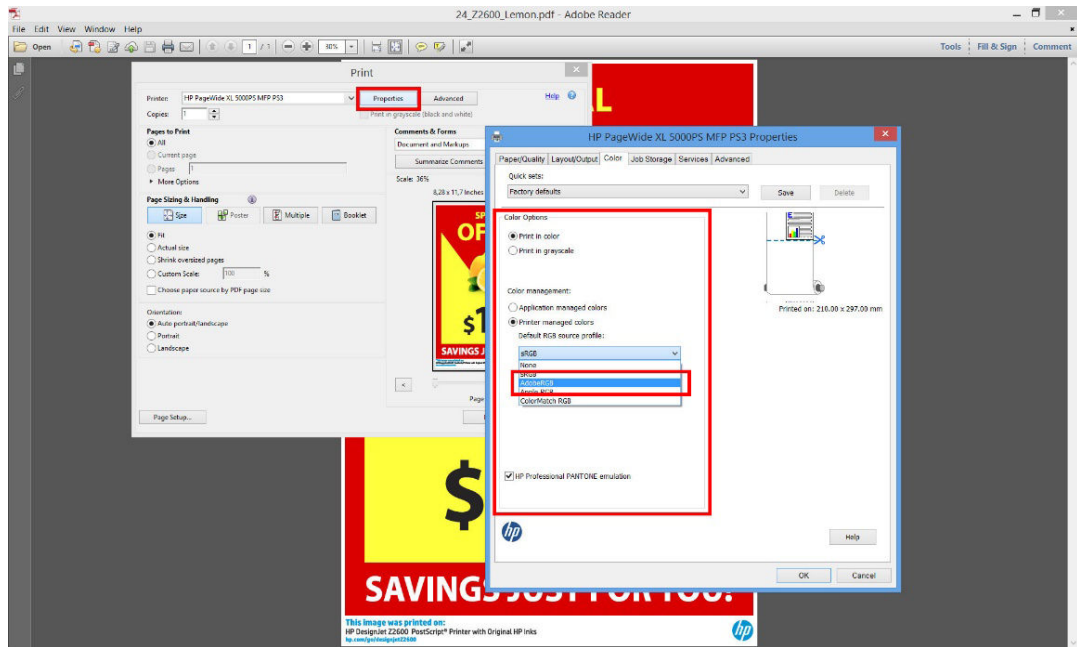

3. Click the **Advanced** button in the Print dialog box to set color management options. Check the box **Let printer determine colors**; and HP recommends checking the other color-management boxes, which preserve the purity of particular colors: **Treat grays as K-only grays**, **Preserve Black**, and **Preserve CMYK Primaries**.

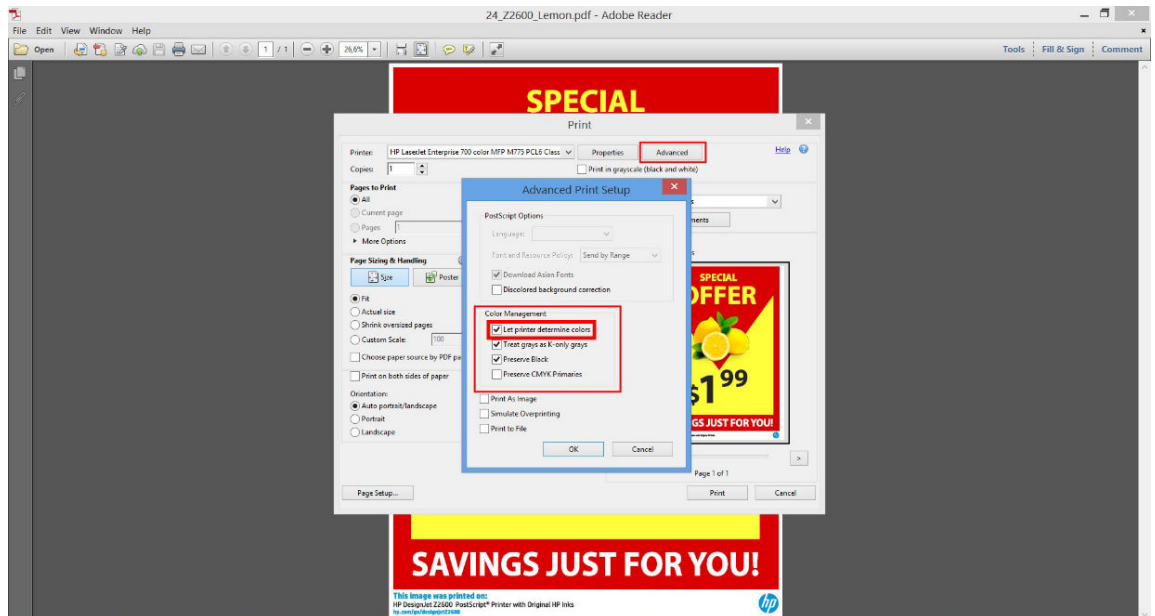

4. If the document contains several color profiles and you are not sure what the result will be, you can flatten the document first and print it as seen on the screen. To do this, check the box **Print As Image** in the Advanced Print Setup dialog box. In this case, the rasterization is performed by Acrobat Reader before calling the driver; whereas, if you do not check this box, the rasterization is performed by the driver. So checking the box may have a visible effect on the look of the printed document.

Using Adobe Acrobat Pro

Acrobat Pro is a professional application that allows full color management. This section briefly describes the options to select a working color space, convert images to a desired color space, and print.

1. PDF files may not contain a color profile. In the absence of a color profile, Acrobat uses a working color space by default. To choose a working color space, first click **Edit > Preferences**.



2. In the Preferences dialog box, you can choose RGB, CMYK, and grayscale working color spaces.

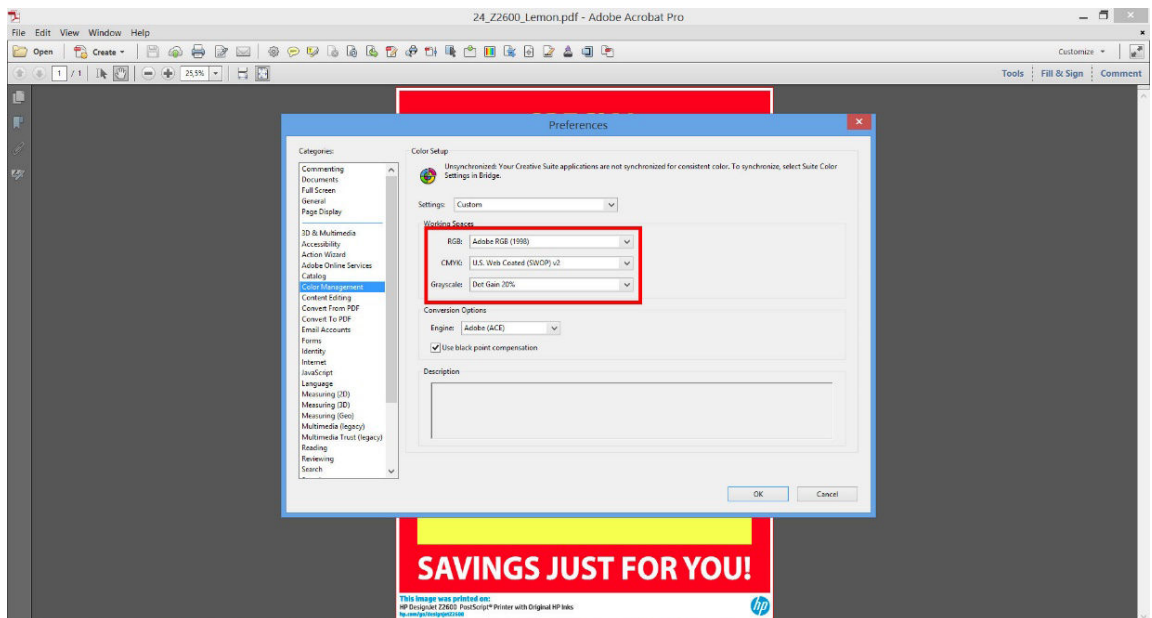

- PDF files can contain elements with different color profiles. Some may have color profiles, some may not. The working color space will affect only those without a color profile. If you want to attach a specific color profile to the document, you must convert the contents of the document as follows. First, select **Convert Colors** from **View > Tools > Print Production** or by clicking the icon in the status bar.

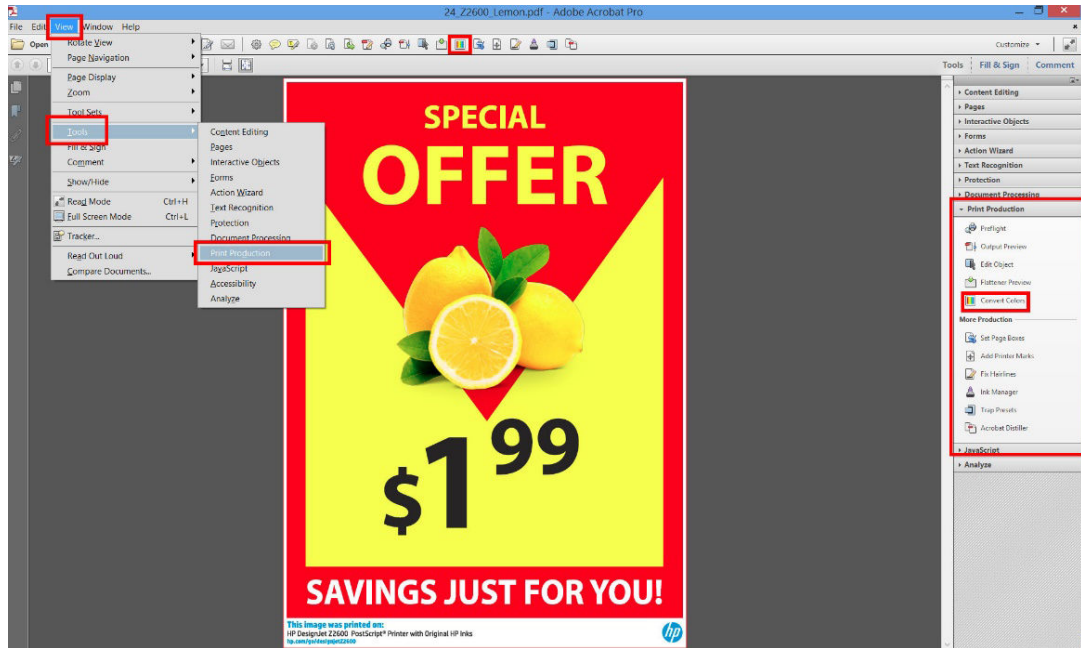

- Select the elements you want to convert by specifying matching criteria (object type and/or color type) and then the conversion attributes. If you want to change the embedded color profile, you can select **Any Object** and **Any Colorspace** in the Matching Criteria section. In the Conversion Attributes section you can choose, for example, to embed an Adobe RGB (1998) profile by selecting it as the **Conversion Profile**, checking the **Embed** box, clicking the **OK** button, and saving the file to keep the changes. The saved file will have an embedded Adobe RGB color profile.

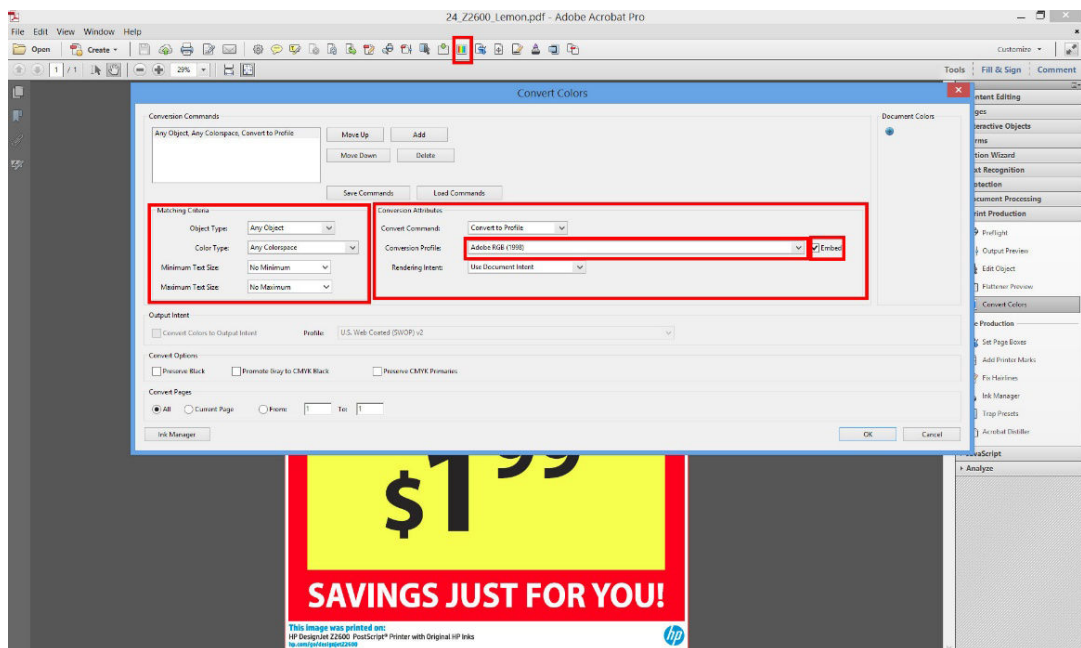

- To print the document, choose a printer from the Print dialog box, click the **Properties** button, and set the color options in the **Color** tab.

 **IMPORTANT:** Select **Print in color** and **Printer managed colors**.

You can also select a default color profile, which will be used for any elements that lack a color profile. HP suggests:

- RGB: Choose sRGB or Adobe RGB; the latter tends to provide more vivid colors.
- CMYK: Choose Coated FOGRA39 or US Web Coated (SWOP) v2.

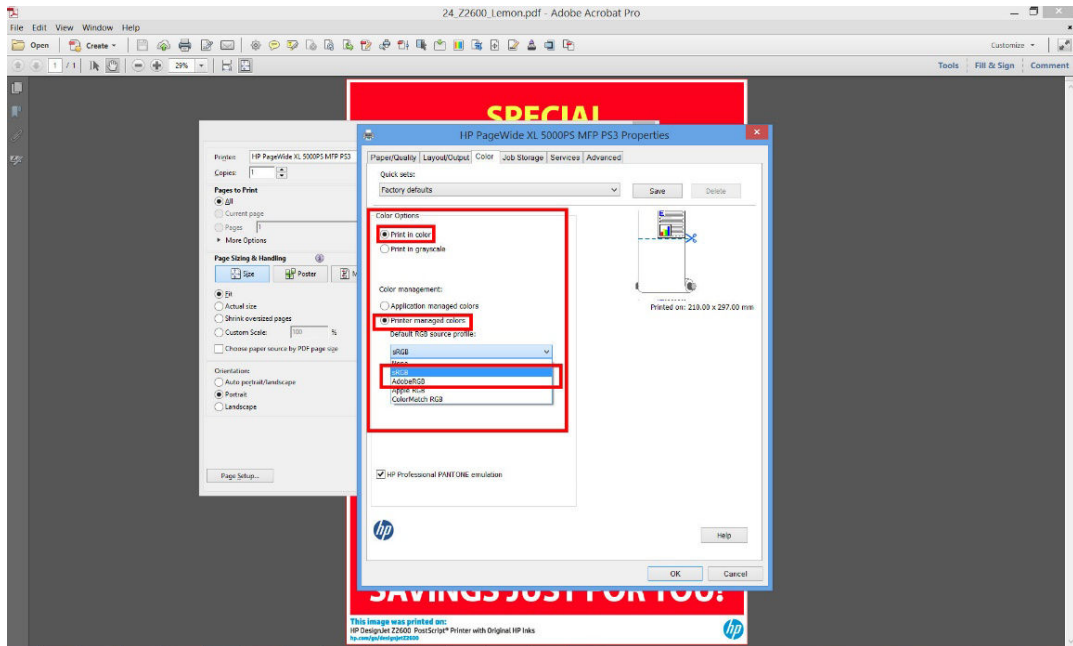

6. Press the **Advanced** button in the Print dialog box, set **Color Handling** to **Printer Color Management**, and click **OK**.

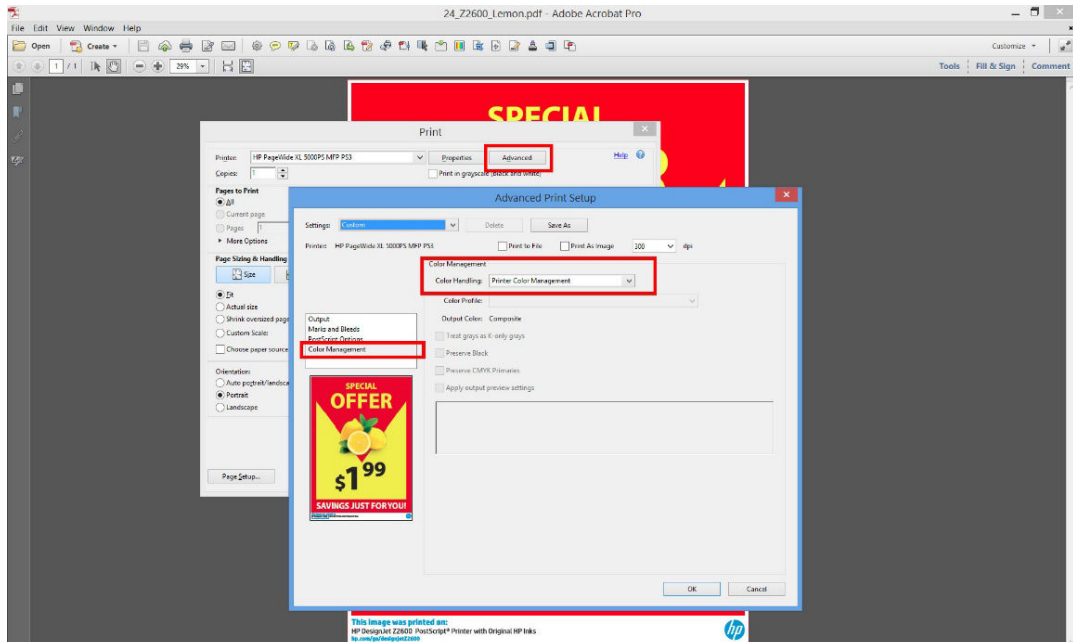

7. In the Print dialog box, click the **Print** button to print the document.

Print a project

This section demonstrates how to print a project from AutoCAD and the Embedded Web Server.

Using AutoCAD

1. The AutoCAD window can show a model or layout. Normally a layout is printed rather than the model.

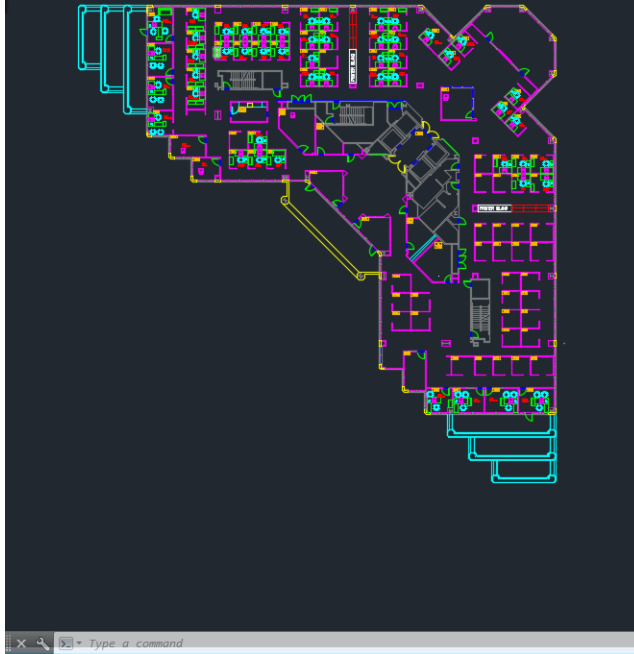

2. Click the Plot icon at the top of the window.

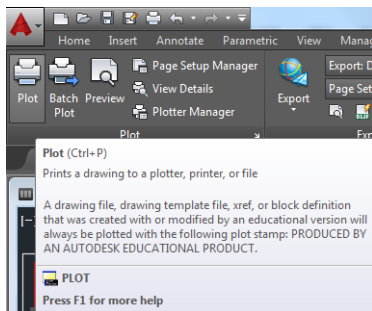

3. The Plot window opens.
4. You can see further options by pressing the circular button in the lower right corner of the window.

 **NOTE:** The Quality option here does not refer to the final print quality but to the quality of AutoCAD viewport objects that are sent for printing.

5. Press the **Properties** button.
6. Select the **Device and Document Settings** tab, and press the **Custom Properties** button.
7. In the **Paper/Quality** tab, check the **Show preview before printing** box, and select the paper type that you intend to use.

 **NOTE:** If you select neither the paper source nor the paper type, the printer will not print on any protected roll (see [Roll protection on page 63](#)).

8. Select the print quality (your own choice between speed and quality of printing).

- If you intend to print on roll paper, you must decide where the printer should cut the paper. Press the **Margins/Layout** button and select **Clip contents by margins**.

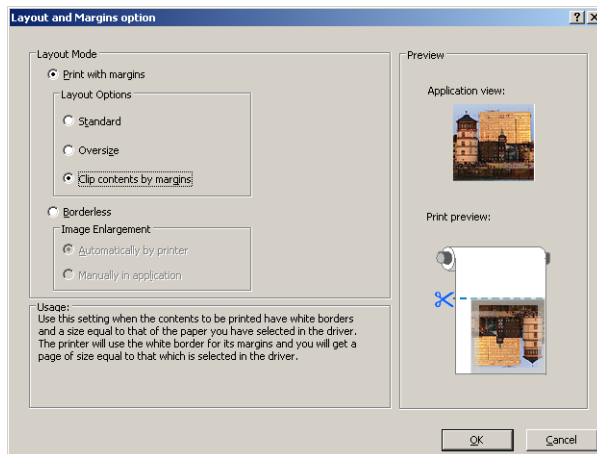

- Select the **Features** tab, then select the **Autorotate** and **Crop lines** options. Autorotation can help to avoid wasting paper, and the crop lines will show you where to cut the paper after printing.
- Press the **OK** button and save your configuration changes to a PC3 file.
- When you have pressed the **OK** button in the Plot window, the printer will construct a print preview.

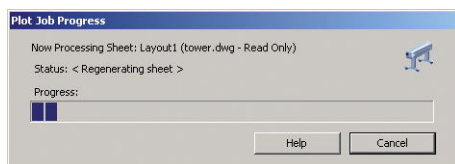

Preview in progress

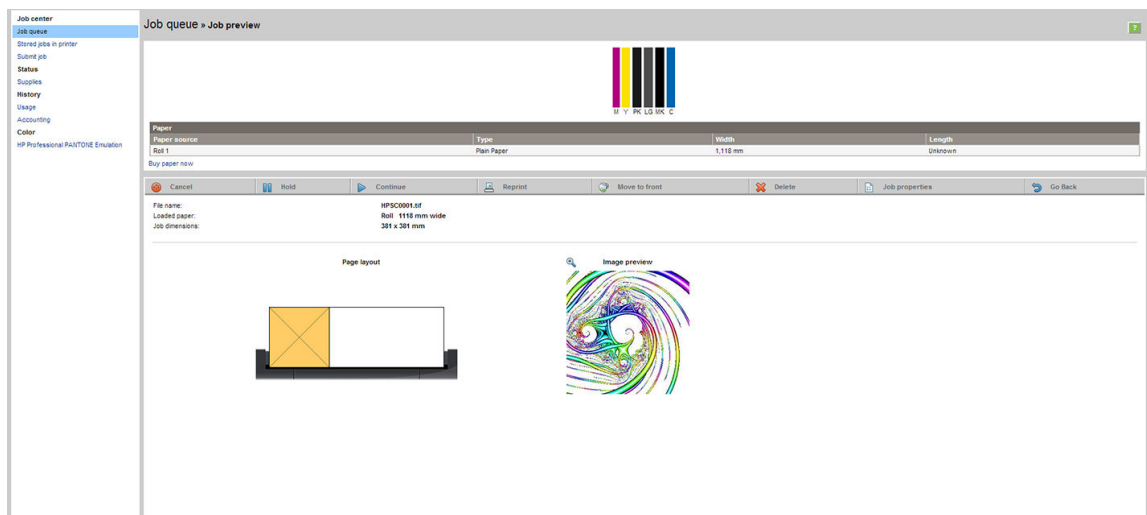

Using the Embedded Web Server to submit files

From the HP DesignJet Utility or the Embedded Web Server, select **Job Center > Submit Job**. With some Web browsers, you will see the window below; with other Web browsers, the mechanism for adding files is slightly different.

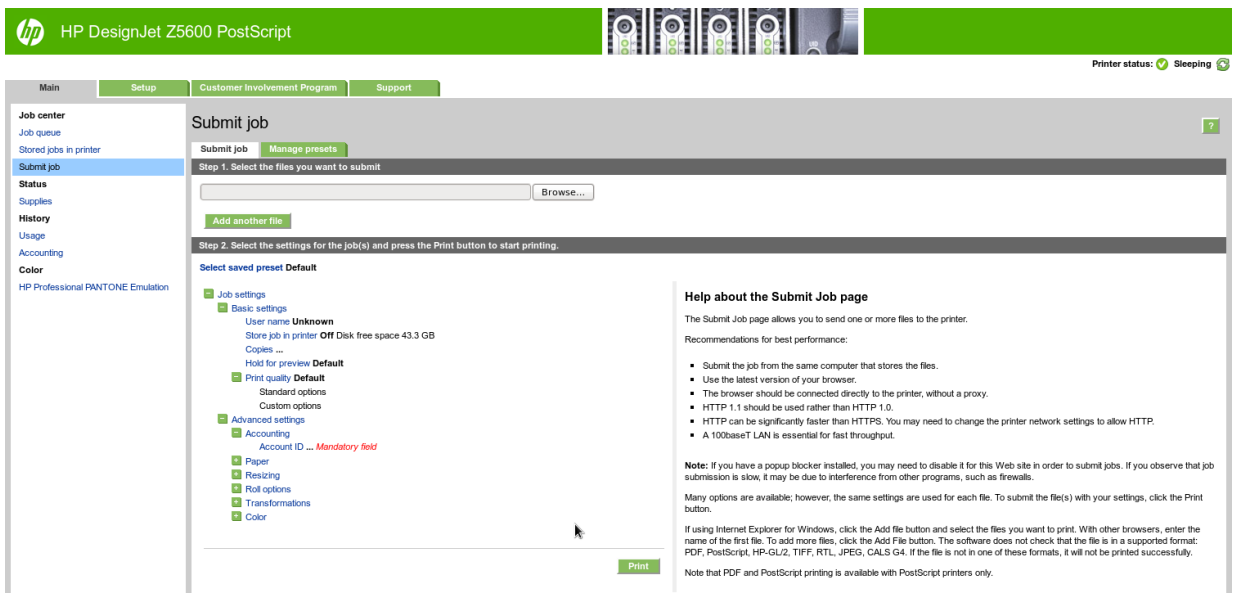

Press the **Add files** button (or **Choose File, Add another file**) to choose the files from your computer that you want to print. The files must be in one of the following formats:

- PDF
- PostScript
- TIFF
- JPEG
- HP-GL/2
- RTL



NOTE: When you print to a file, the file should be in one of the above formats, but its name may have an extension such as **.plt** or **.prn**.

If the files are not in one of these formats, they will not be printed successfully.

If the jobs have been generated with the appropriate settings (such as page size, rotation, resizing and number of copies), you can just press the **Print** button and the project will be sent to the printer.

If you need to specify printing settings, go to the **Job settings** section and select the options you need. Each option has explanatory text on the right, so that you can understand the behavior of each setting. Remember that, if you leave the setting as **Default**, the setting saved in the job will be used. If the job contains no setting, the setting in the printer will be used.

Using clip contents by margins

You can select this margins option from **Advanced settings > Paper > Layout/Margins > Print with margins > Layout > Clip contents by margins**.

Use this option when the contents to be printed have white borders and a size equal to that of the paper you have selected. The printer will use the white border for its margins and you will get a page of size equal to that which is selected in the driver.

Print a presentation

This section demonstrates how to print a presentation from AutoCAD and from Photoshop.

Using AutoCAD

1. Open the AutoCAD file and select a layout.

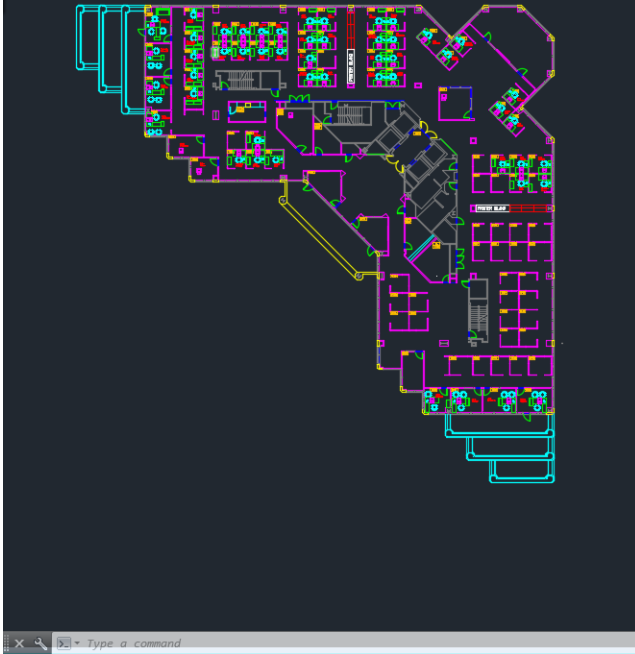

2. Click the Plot icon at the top of the window.

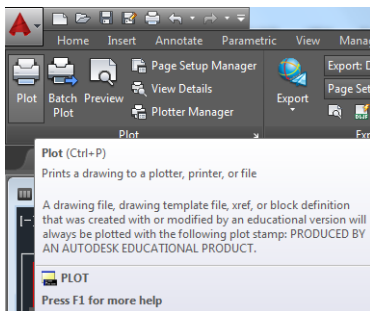

3. Ensure that the correct printer is selected, then press the **Properties** button.
4. Select the **Device and Document Settings** tab, and press the **Custom Properties** button.
5. In the **Paper/Quality** tab, check the **Show preview before printing** box, and select the paper type that you intend to use.

 **NOTE:** If you select neither the paper source nor the paper type, the printer will not print on any protected roll (see [Roll protection on page 63](#)).

6. Select the print quality (your own choice between speed and quality of printing).

7. If you intend to print on roll paper, you must decide where the printer should cut the paper. Press the **Margins/Layout** button and select **Clip contents by margins**.

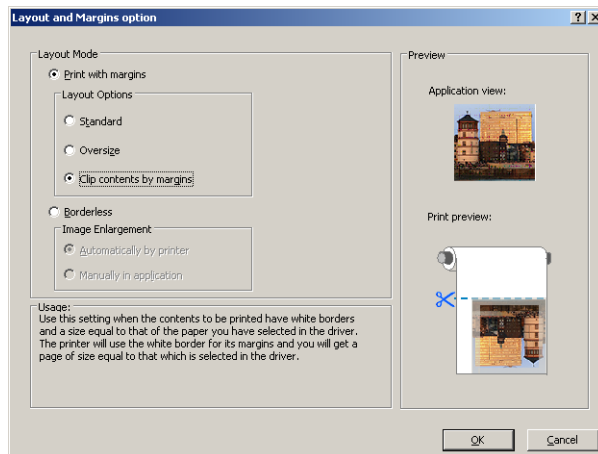

8. If you are using photo or glossy paper, you can select **Borderless** printing.

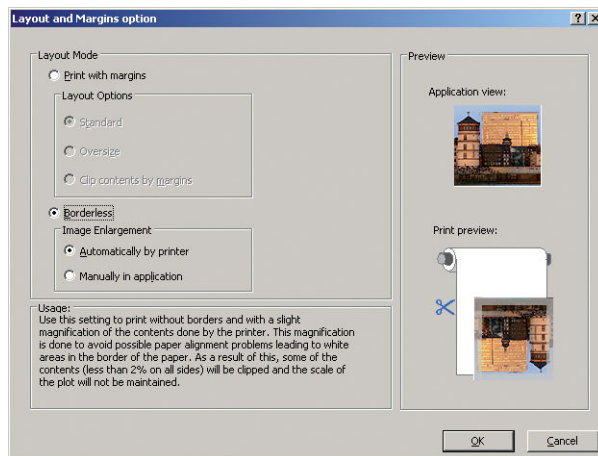

9. Select the **Features** tab, then select the **Autorotate** and **Crop lines** options. Autorotation can help to avoid wasting paper, and the crop lines will show you where to cut the paper after printing.
10. Press the **OK** button and save your configuration changes to a PC3 file.

- When you have pressed the **OK** button in the Plot window, the printer will construct a print preview.

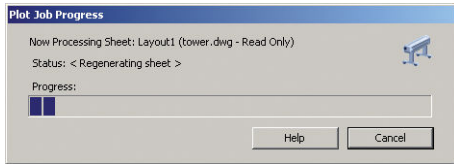

Preview in progress

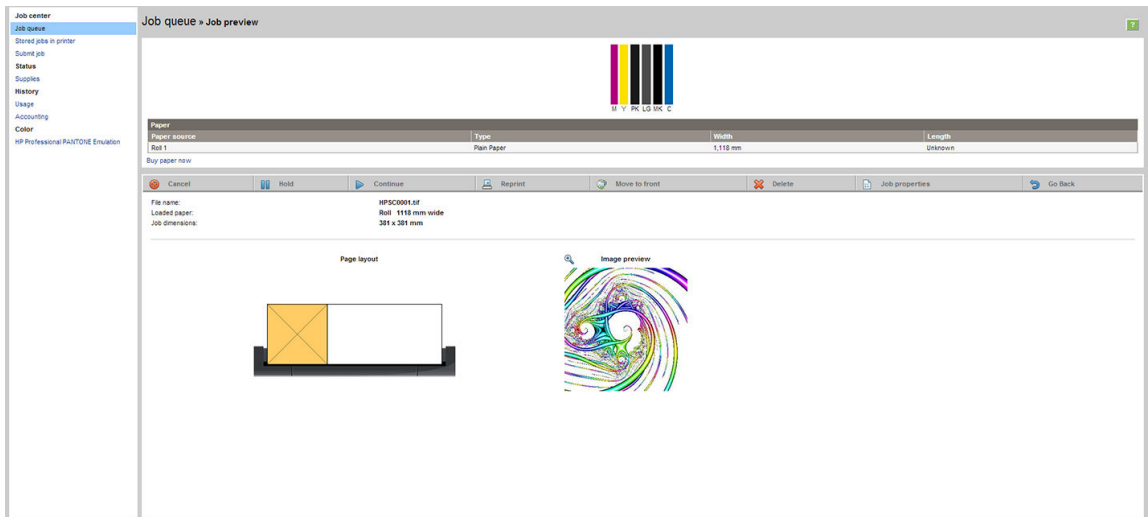

Using Adobe Photoshop

- In Photoshop, select **File > Print** and then select your printer.
- Select **Print settings**, then the **Paper/quality** tab.
- Choose from the available paper sizes.

If you do not find the paper size that you intend to use, press the **Custom** button. Enter the width, the length and the name of your custom paper size. Press the **Save** and **OK** buttons.

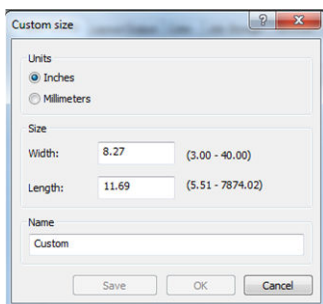

- Select **Show preview before printing**. You may also wish to change the default paper source, paper type and print quality.
- In the **Color** tab, the default color management option is **Printer managed colors**, and this is the correct option because you have already selected **Printer Manages Colors** in Photoshop.

Print and scale from Microsoft Office

This section demonstrates how to print and scale from Microsoft Office 2013.

Using PowerPoint

1. Select **File > Print**, and select the name of your printer.
2. Select **Printer properties > Features > Print document on** to scale the document to a particular size.
3. Select the **Paper/Quality** tab, then select **Paper Source** and **Paper Type**.
4. Select **Margins/Layout**, then select **Clip contents by margins** to keep the size.

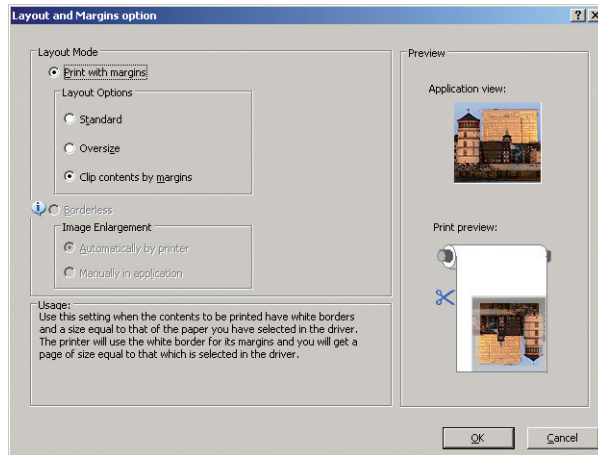

Using Project

1. Select **File > Page Setup > Print**.

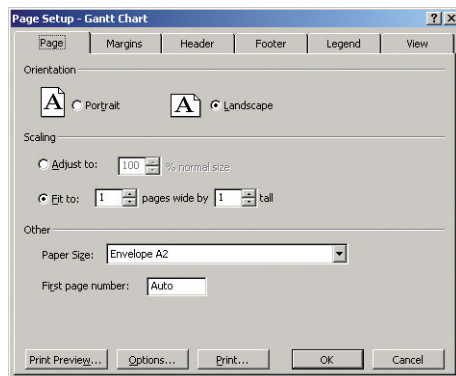

2. Select your printer's name, then **Close**.

3. Select **Page Setup**, and choose the **Paper Size** you want.

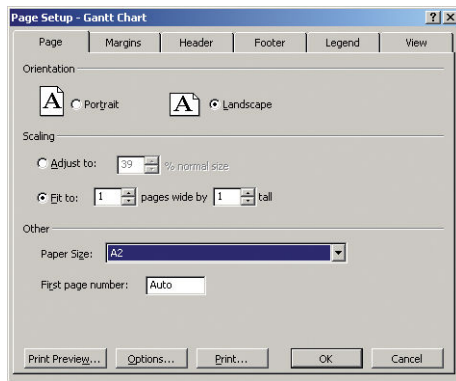

4. Select **Options** to go to the printer driver. The default options in the **Paper/Quality** tab are probably suitable: **Paper source: Printer auto select** and **Paper Type: Use Printer Settings**.
5. Select **Features > Print document on** to scale the document to a particular size. Alternatively, you can scale the document in Project.

Using Excel

1. Select **File > Print**. Select your printer's name, then click the back arrow to leave the **File** menu.
2. Select the **PAGE LAYOUT** tab, then **Size**, and choose the paper size you want.

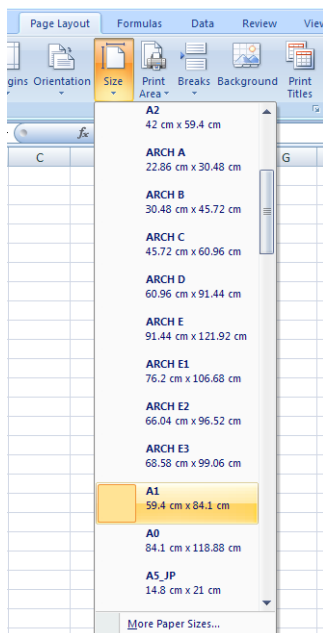

3. Select **File > Print > Printer properties** to go to the printer driver. In the **Paper/Quality** tab, select **Paper source, Paper Type** and **Print Quality**.
4. Select **Features > Print document on** to scale the document to a particular size. Alternatively, you can scale the document in Excel.

12 Retrieving printer usage information

- [Get printer accounting information](#)
- [Check usage statistics](#)
- [Check usage statistics for a job](#)
- [Request accounting data by email](#)

Get printer accounting information

There are various different ways of getting accounting information from your printer.

- View printer usage statistics for the whole lifetime of the printer, see [Check usage statistics on page 98](#).
- View ink and paper usage for each of your recent jobs by using the HP DesignJet Utility, see [Check usage statistics for a job on page 98](#). If the HP DesignJet Utility is not available, see [Access the HP DesignJet Utility on page 28](#).
- Request accounting data by email. The printer sends data in XML at regular intervals to a specified email address; the data may be interpreted and summarized by a third-party application, or displayed as an Excel spreadsheet. See [Request accounting data by email on page 99](#).
- Use a third-party application to request printer status, printer usage or job accounting data from the printer through the Internet. The printer provides data in XML to the application whenever requested. HP provides a Software Development Kit to facilitate the development of such applications.

Check usage statistics

There are various ways of checking your printer's usage statistics.

 **NOTE:** The accuracy of the usage statistics is not guaranteed.

From the Embedded Web Server



1. Access the Embedded Web Server, see [Access the Embedded Web Server on page 28](#).
2. Go to the **Main** tab.
3. Select **History > Usage**.

From the HP DesignJet Utility

1. Access the HP DesignJet Utility, see [Access the HP DesignJet Utility on page 28](#).
2. Under Windows, go to the **Overview** tab and click the **Printer usage** link.

Under Mac OS X, select **Printer Usage** and click the **Lookup** button.

From the front panel

1. Press .
2. Press .
3. Press **Internal prints**.
4. Press **User information prints**.
5. Press **Print usage report**.

Check usage statistics for a job

There are two ways to check usage statistics for a particular job.

 **NOTE:** The accuracy of the usage statistics is not guaranteed.

Accounting statistics with the HP DesignJet Utility

1. Access the HP DesignJet Utility, see [Access the HP DesignJet Utility on page 28](#).
2. Under Windows, select **Job center** to view information regarding the most recent jobs, then click the **Accounting** link.

Under Mac OS X, select **Job Accounting** and click the **Look Up** button.

Accounting statistics with the Embedded Web Server

1. Access the Embedded Web Server, see [Access the Embedded Web Server on page 28](#).
2. Go to the **Main** tab.
3. Select **History > Accounting**.

Request accounting data by email

1. Obtain the IP address of the outgoing mail server (SMTP) from your IT department; this is required in order to send email messages.
2. Ensure that the outgoing email server is configured to enable relaying of email messages that the printer will send.
3. Open your Web browser and connect to the printer's Embedded Web Server.
4. Select the **Setup** tab.
5. From the Configuration menu in the left-hand column, select **Date & Time**.
6. Ensure that the printer's date and time have been set correctly.
7. From the Configuration menu, select **Email server**.
8. Enter the IP address of the outgoing mail server (SMTP).
9. Specify an email address for the printer. The latter does not need to be a valid email address, because the printer will not receive messages; but it should have the form of an email address. It serves to identify the printer when it sends email messages.
10. From the Configuration menu, select **Printer settings**.
11. In the Accounting section, if you set **Require account ID** to **On**, then every time someone sends a print job to the printer, he or she must provide an account ID: for example, an ID corresponding to his or her department or to a specific project or client. If someone sends a job without providing an account ID, the printer will hold the unidentified job in the queue without printing it until an account ID is provided.

If you set **Require account ID** to **Off**, then the printer will print all jobs whether or not they have an account ID.
12. Set **Send accounting files** to Enabled.
13. Set **Send accounting files to** to the email address (or addresses) to which you want the accounting information sent. This may be an address that you have created specifically to receive automatically generated messages from the printer.
14. Set **Send accounting files every** to the frequency with which you want the information sent, choosing a specific number of days or prints.
15. You may want to set **Exclude personal information from accounting email** to **On**, so that the accounting messages will not contain personal information. If this option is **Off**, information such as user name, job name, and account ID will be included.

When you have completed the above steps, the printer will send accounting data by email with the frequency that you specified. The data are provided in XML and can easily be interpreted by a third-party program. The data provided on each print job include when the job was submitted, when the job was printed, the printing time, the type of image, the number of pages, the number of copies, the paper type and size, the amount of each color of ink used and various other attributes of the job. Accounting data are also provided on scan and copy jobs.

You can download an Excel template from HP's Web site (<http://www.hp.com/go/designjet/accounting>) that will enable you to display the XML data more readably in the form of a spreadsheet.

Analysis of the accounting data will enable you to bill customers precisely and flexibly for the use of your printer. You can, for instance:

- Bill each customer for the total amount of ink and paper used by that customer over a particular period.
- Bill each customer separately per job.
- Bill each customer separately for each project, broken down by job.



NOTE: In some circumstances Excel may lose or misplace the decimal point in a number: for instance, the number 5.1806 may be misunderstood as 51806 and displayed as 51,806. This is an Excel problem that cannot be solved by HP.

13 Handling ink cartridges and printheads

- [About the ink cartridges](#)
- [Check the ink cartridges status](#)
- [Remove an ink cartridge](#)
- [Insert an ink cartridge](#)
- [About the printheads](#)
- [Check the printhead status](#)
- [Remove a printhead](#)
- [Insert a printhead](#)

About the ink cartridges



Ink cartridges store the ink and are connected to the printheads, which distribute the ink on the paper. To purchase additional cartridges, see [Accessories on page 116](#).

 **CAUTION:** Observe precautions when handling ink cartridges because they are ESD-sensitive devices (see the [Glossary on page 172](#)). Avoid touching pins, leads and circuitry.

 **NOTE:** This printer is not designed to use continuous ink systems. To resume printing, remove any continuous ink system and install genuine HP (or compatible) ink cartridges.

 **NOTE:** This printer is designed for ink cartridges to be used until they are empty. Refilling cartridges prior to depletion might cause your printer to fail. If this happens, insert a new cartridge (either genuine HP or compatible) to continue printing.

Check the ink cartridges status

To view the ink levels of your ink cartridges, press  on the front panel, then . There is a **Replace ink cartridges** option on the ink information page in case you want to do so (see also [Remove an ink cartridge on page 102](#)).

To get more information on your ink cartridges, you can press the color of the cartridge on which you want information.

You can also get this information from the HP DesignJet Utility.

For an explanation of the ink cartridge status messages, see [Ink cartridge status messages on page 150](#).

HP DesignJet Utility procedures

- In the HP DesignJet Utility for Windows, go to the **Overview** tab, each cartridge's status is under **Supplies Status > Cartridges**.
- In the HP DesignJet Utility for Mac OS X, select **Printer Status** in the Information group.

Remove an ink cartridge

There are two occasions when you need to remove an ink cartridge.

- The ink cartridge is very low and you want to replace it with a full cartridge for unattended printing (you can use up the remaining ink in the first cartridge at a more convenient time).
- The ink cartridge is empty or faulty, and you must replace it to continue printing.



 **CAUTION:** Do not try to remove an ink cartridge while printing.

CAUTION: Remove an ink cartridge only if you are ready to insert another one.

CAUTION: Make sure the printer wheels are locked (the brake lever is pressed down) to prevent the printer from moving.

 **NOTE:** When a cartridge runs out of ink, the current job is not automatically cancelled: unless you cancel it manually, it will resume printing when the empty cartridge has been replaced. If there is a delay in replacing the cartridge, you may see some banding on the print.

1. From the front panel, press , then , then **Replace ink cartridges**.

Alternatively, press , then , then **Ink > Replace ink cartridges**.

2. Open the ink cartridge cover on the left-hand side of the printer.

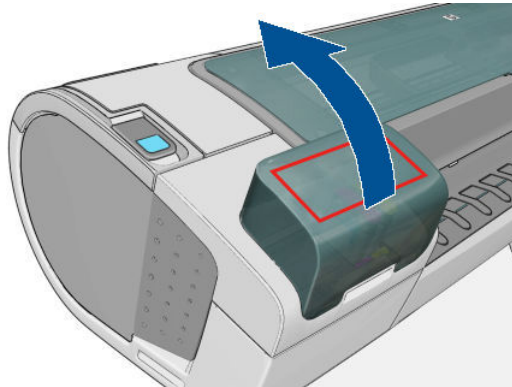

3. Grip the cartridge you wish to remove.

4. Pull the cartridge straight up.

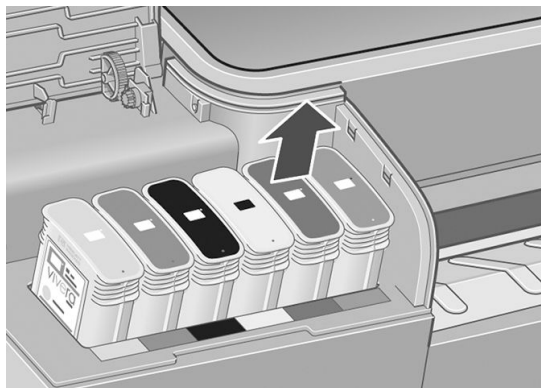

 **NOTE:** Avoid touching the end of the cartridge that is inserted into the printer, as there may be ink on the connection.

 **NOTE:** Avoid storing partially used ink cartridges.

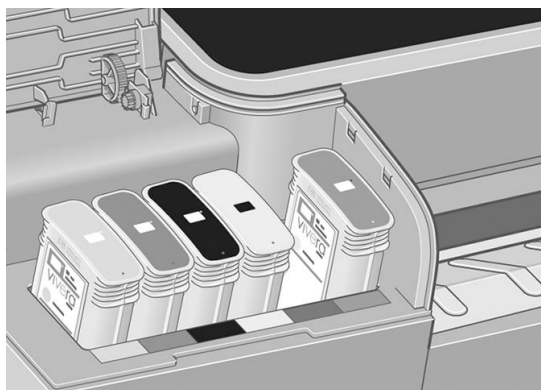

5. The front-panel display identifies the missing ink cartridge.

Insert an ink cartridge

1. Before removing the cartridge from its wrapping, shake it vigorously.
2. Unwrap the new ink cartridge, find the label identifying the ink color. Check that the letter or letters (in these illustrations, M for magenta) marking the empty slot, matches the letter or letters on the cartridge label.
3. Insert the ink cartridge into its slot.

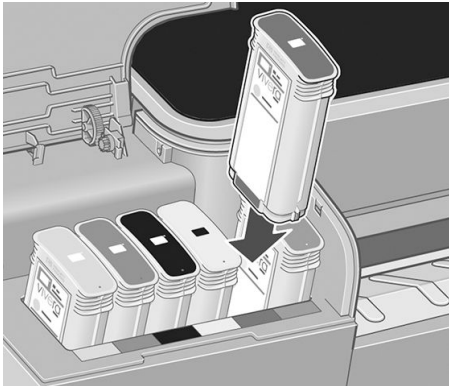

4. Push the cartridge into the slot until it snaps into position. You should hear a beep and see confirmation that the cartridge has been inserted.

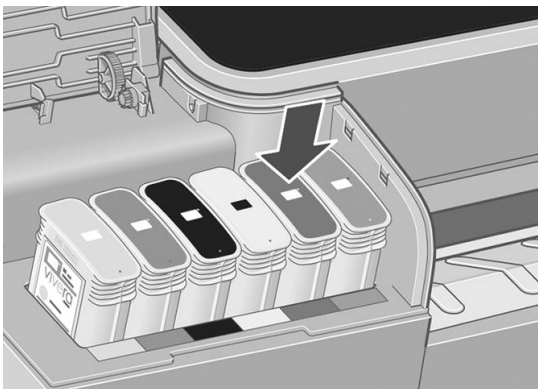

If you have difficulty, see [Cannot insert an ink cartridge on page 150](#).

5. When all cartridges have been inserted, close the cover.

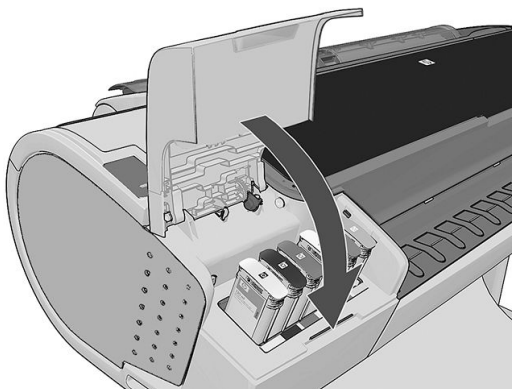

6. The front-panel display confirms that all cartridges have been correctly inserted.



About the printheads

The printheads are connected to the ink cartridges and jet ink onto the paper.

CAUTION: Observe precautions when handling printheads because they are ESD-sensitive devices (see the [Glossary on page 172](#)). Avoid touching pins, leads and circuitry.

Check the printhead status

The printer automatically checks and services the printheads after each print. Follow the steps below to get more information on your printheads.

1. From the front panel, press  then , then the printhead on which you want information.
2. The front panel displays:
 - Colors
 - Product name
 - Product number
 - Serial number
 - Status, see [Front-panel error messages on page 161](#)
 - Volume of ink it has used
 - Warranty status

You can also get most of this information from the HP DesignJet Utility.

For an explanation of the printhead status messages, see [Printhead status messages on page 155](#).

If the warranty status is **See warranty note**, this indicates that non-HP ink is being used. See the *Legal Information* document provided with your printer for details of the warranty implications.

Remove a printhead

CAUTION: Make sure the printer wheels are locked (the brake lever is pressed down) to prevent the printer from moving.

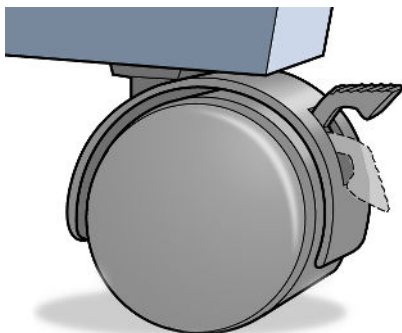

CAUTION: Printhead replacement must be performed with the printer powered on.

1. From the front panel, press , then , then **Replace printheads**.

Alternatively, press , then , then **Ink > Replace printheads**.

2. The printer moves the carriage into the correct position.

⚠ CAUTION: If the carriage is left in the removal position for more than three minutes without inserting or removing any printheads, it tries to move back to its normal position in the right-hand end.

3. When the carriage has stopped moving, the front-panel display asks you to open the window.

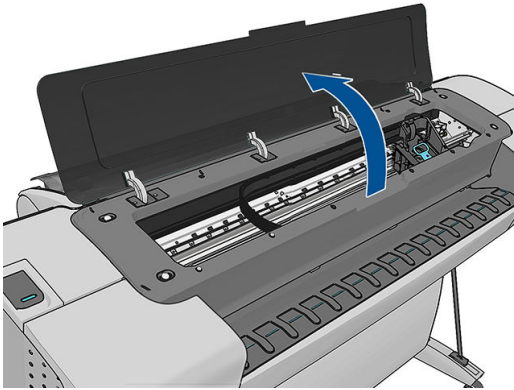

4. Locate the carriage on the right side of the printer.
5. Pull the handle up and toward you to release the wire loop.

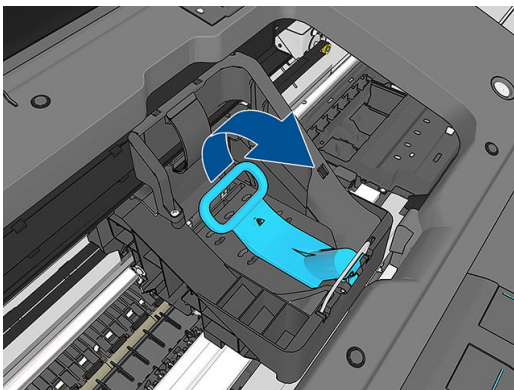

6. Push the handle back to raise the lid.

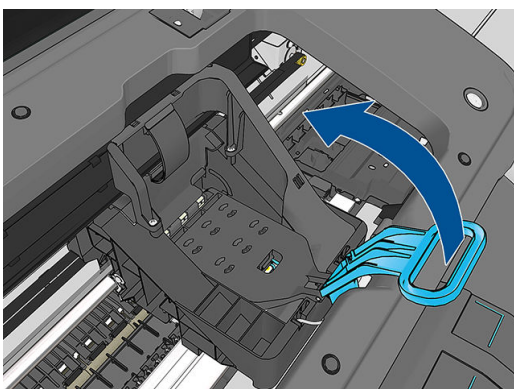

7. This gives you access to the printheads.

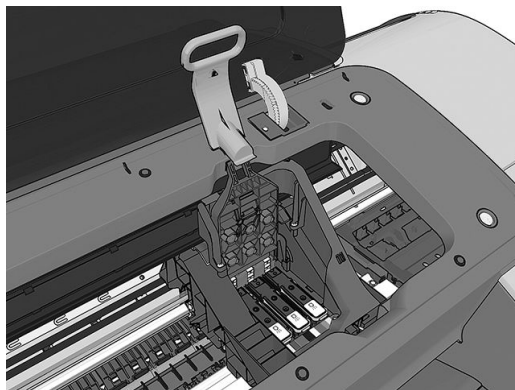

8. To remove a printhead, lift up the blue handle.

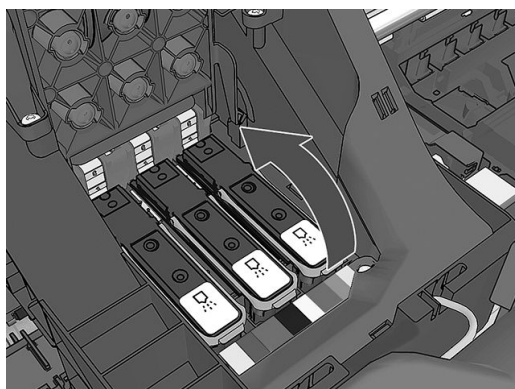

9. Using the blue handle, use steady force to disengage the printhead.

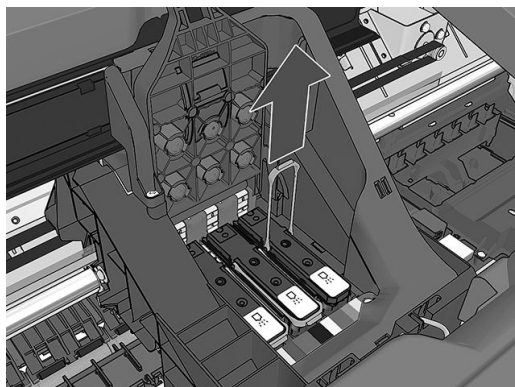

10. Pull the blue handle upward until the printhead is released from the carriage.

CAUTION: Do not pull abruptly because this can damage the printhead.

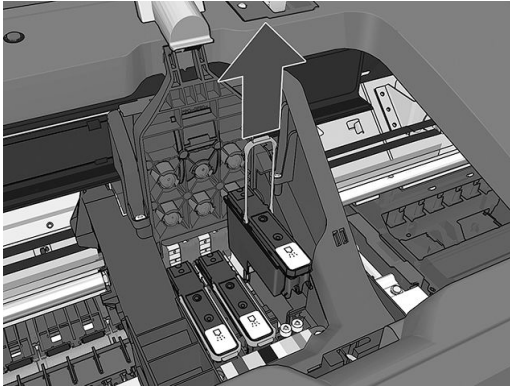

11. The front-panel display identifies the missing printhead.

Insert a printhead

NOTE: You cannot insert a new printhead successfully if either of the connected ink cartridges is empty, or nearly empty. In this case, you should replace the ink cartridge before inserting the new printhead.

1. Remove the orange protective caps by pulling them down.

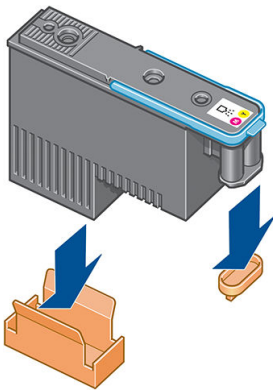

2. The printhead is designed to prevent you from accidentally inserting it into the wrong slot. Check that the colored label on the printhead matches the colored label of the carriage slot into which the printhead is to be inserted.

3. Insert the new printhead into its correct slot in the carriage.

⚠ CAUTION: Insert the printhead slowly and vertically, straight down. It may be damaged if you insert it too fast, or at an angle, or if you rotate it as you insert it.

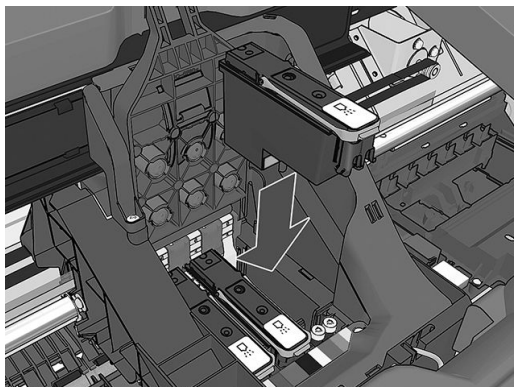

4. Push down as indicated by the arrow shown below.

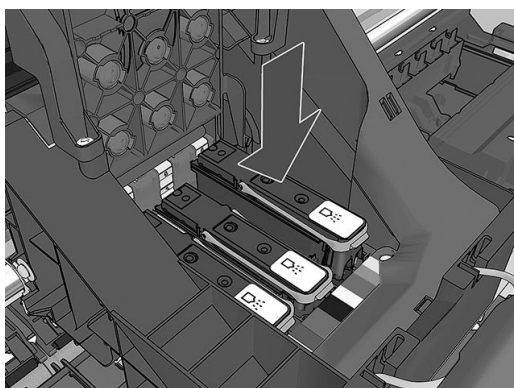

⚠ CAUTION: When installing the new printhead there may be some resistance, so you need to press it down firmly but smoothly. You should hear a beep and see confirmation on the front-panel display that the printhead has been inserted. If you have difficulty, see [Cannot insert a printhead on page 150](#).

5. Insert all other printheads that need to be installed, and close the carriage lid.

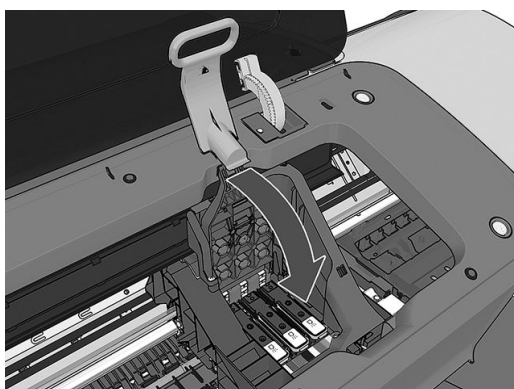

6. Ensure the end of the blue handle catches the wire loop on the near side of the carriage.

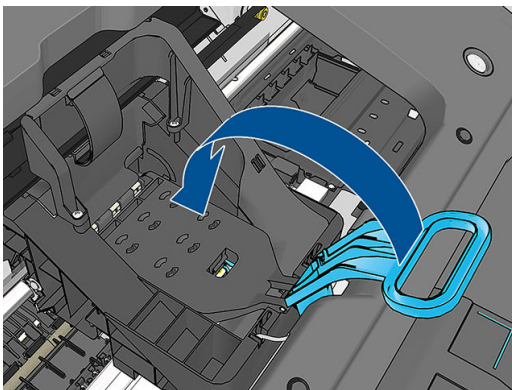

7. Lower the handle to rest on the carriage cover.

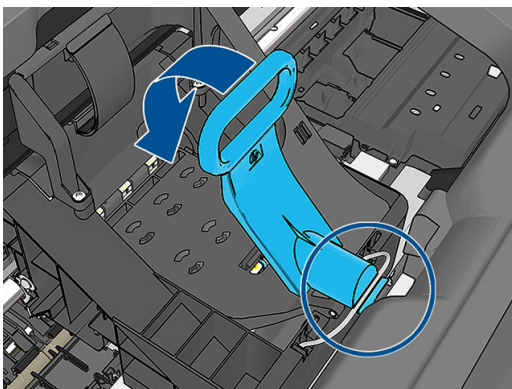

When all the printheads have been inserted correctly and are accepted by the printer, the printer beeps.

 **NOTE:** If the printer does not beep when you insert the printhead and the **Replace** message appears on the front-panel display, the printhead may need to be reinserted.

8. Close the window.

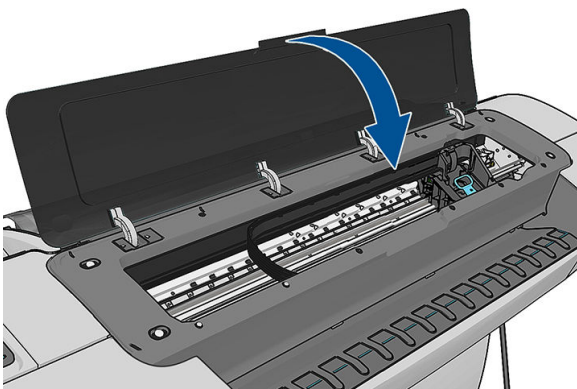

9. The front-panel display confirms that all printheads are correctly inserted. The printer starts checking and preparing the printheads. The default routine process, when all printheads are changed, takes 20 minutes. If the printer finds problems in preparing the printheads, it takes longer, up to 45 minutes. For a single printhead insertion, the times vary between 2 and 40 minutes. After all printheads are checked and prepared, the printhead realignment procedure runs automatically if paper is loaded, see [Align the printheads on page 153](#).
10. You are recommended to perform a color calibration after inserting a new printhead. See [Color calibration on page 74](#).

14 Maintaining the printer

- [Check printer status](#)
- [Clean the exterior of the printer](#)
- [Maintain the ink cartridges](#)
- [Move or store the printer](#)
- [Update the firmware](#)
- [Update the software](#)
- [Printer maintenance kits](#)
- [Secure Disk Erase](#)

Check printer status

You can check the current status of the printer in various ways:

- If you start the HP DesignJet Utility and select your printer, you see a page of information describing the status of the printer and its paper and ink supplies.
- If you access the Embedded Web Server, you see information about the general status of the printer. The Supplies page in the **Main** tab describes the status of the paper and ink supplies.
- At the front panel, you can press  for information about paper, ink levels, ink cartridges, and printheads. If there is a current problem, you are taken automatically to the area with the most urgent problem.

If there are any current alerts, the upper row of the home screen shows the top-priority alert. Press the alert message to see a list of all current alerts.

Clean the exterior of the printer

Clean the outside of the printer and all other parts of the printer that you regularly touch as part of normal operation with a damp sponge or a soft cloth and a mild household cleaner such as non-abrasive liquid soap.

 **WARNING!** To avoid an electric shock, make sure that the printer is turned off and unplugged before you clean it. Do not let water get inside the printer.

 **CAUTION:** Do not use abrasive cleaners on the printer.

Maintain the ink cartridges

During the normal lifetime of a cartridge, no specific maintenance is required. However, in order to maintain the best print quality, replace a cartridge when it reaches its expiration date. The printer's front panel notifies you when any cartridge reaches its expiration date.

You can also check a cartridge's expiration date at any time: see [Check printer status on page 112](#).

See also [Handling ink cartridges and printheads on page 101](#).

Move or store the printer

If you need to move or store the printer, prepare it correctly to avoid possible damage to it. To prepare the printer, follow the instructions below.

1. Do not remove the ink cartridges or printheads.
2. Make sure that no paper is loaded.
3. Make sure that the printer is idle.
4. Disconnect any cables connecting the printer to a network or a computer.

If you need to leave the printer turned off for a long time, follow the additional steps below.

1. Turn off the power using the **Power** key on the front panel.
2. Also turn off the power switch at the rear of the printer.
3. Disconnect the printer's power cable.

 **CAUTION:** If you turn the printer upside down, ink could escape into the printer and cause serious damage.

When the printer is turned back on, it takes about three minutes to initialize itself and to check and prepare the printheads. Preparing the printheads normally takes just over a minute. However, if the printer has been off for a six weeks or more, preparing the printheads could take up to 45 minutes.

 **CAUTION:** If the printer remains off for a long period of time, the printheads may become unusable. In this case, you need to replace the printheads with new ones.

 **TIP:** Because preparing and purging the printheads uses both time and ink, you are strongly recommended to leave the printer always on or in sleep mode, whenever possible, to maintain the health of the printheads. In both cases, the printer wakes up from time to time to maintain the printheads. Thus you can avoid going through lengthy preparation processes before using your printer.

 **NOTE:** If the printer is left on without printing, every six hours it advances the paper slightly to avoid the pinchwheels leaving marks on the paper.

Update the firmware

The printer's various functions are controlled by firmware that resides in the printer.

From time to time firmware updates will be available from your support representative. These updates increase the printer's functionality, enhance its features, and may correct minor problems.

 **IMPORTANT:** You are strongly recommended to update the firmware periodically in order to take advantage of the latest developments.

There are various ways of downloading and installing firmware updates; you can choose whichever you find most convenient. They can be divided into two categories: automatic and manual updates.

 **NOTE:** The firmware includes a set of the most commonly used paper presets. Extra paper presets can be downloaded separately; see [Paper presets on page 43](#).

Automatic firmware updates

Automatic firmware updates are a convenience that is possible with Web-connected printers. Your printer can automatically download the latest firmware release and install it for you.

Important notes

- Your printer must be connected to the Internet; see [Set up your Web-connected printer on page 20](#).
- To configure automatic firmware updates, you can use the front panel or the Embedded Web Server; see [Set up your Web-connected printer on page 20](#).
- If an administrator password has been set, it will be required to change these settings.
- A firmware update package can be large; you may want to consider whether there are any implications for your network or Internet connection. Downloads made with a Jetdirect adaptor are slower than those made with the built-in Ethernet adaptor.
- A firmware update is downloaded in the background: the printer can be printing at the same time. However, it cannot be installed in the background: printing must stop.

Manual firmware updates

Manual firmware updates can be performed in the following ways:

- Using the Embedded Web Server, select the **Firmware update maintenance** tab and then **Firmware update**. Press **Check now** to check whether new firmware is available. If new firmware is available, some

information about the new firmware is displayed, and you are given the opportunity to download and install it.

- Using the HP DesignJet Utility under Windows, select your printer, the **Support** tab and then **Firmware Update**.
- Using the HP DesignJet Utility under Mac OS X, select **Firmware Update** in the Support group.
- Using HP Web Jetadmin, with which you can make manual firmware updates or request automatic updates.
- Using a USB flash drive. Download the firmware file from <http://www.hp.com/go/Z2600/firmware> or <http://www.hp.com/go/Z5600/firmware> into the USB flash drive and insert it into the Hi-Speed USB host port beside the front panel. A firmware update assistant will appear on the front panel to guide you through the update process.

Update the software

To update printer drivers and other software for your printer, go to <http://www.hp.com/go/Z2600/drivers> or <http://www.hp.com/go/Z5600/drivers>.

If your operating system is Windows, HP Software Update regularly offers to update your software automatically.

Printer maintenance kits

Three maintenance kits are available for your printer, containing components that may need to be replaced after long use. When one of them is needed, a message is displayed on the front panel and by the HP DesignJet Utility.

When you see the message, you should contact HP Support (see [Contact HP Support on page 166](#)) and request the maintenance kit. The kits are installed by service engineers only.

Secure Disk Erase

The printer's hard disk is used as a temporary storage area for print jobs. The Secure Disk Erase facility can completely erase your information from the hard disk to protect it from unauthorized access. You can choose to erase particular files, or the whole hard disk.

Secure Disk Erase provides three different levels of security:

- **Non-Secure Fast Erase:** all pointers to the information are erased. The information itself remains on the hard disk until the disk space it occupies is needed for other purposes, and it is then overwritten. While it remains on the disk, it is difficult for most people to access, but may be accessed using software designed for the purpose. This is the normal method in which files are erased on most computer systems; it is the fastest method but the least secure.
- **Secure Fast Erase:** all pointers to the information are erased, and the information itself is also overwritten with a fixed character pattern. This method is slower than Non-Secure Fast Erase, but more secure. It may still be possible to access fragments of the erased information by using special tools to detect residual magnetic traces.
- **Secure Sanitizing Erase:** all pointers to the information are erased, and the information itself is repetitively overwritten using an algorithm designed to eliminate any residual traces. This is the slowest method, but the most secure. Secure Sanitizing Erase meets the US Department of Defense 5220-22.m requirements for clearing and sanitization of disk media. This is the default security level when using Secure Disk Erase.

Secure Disk Erase is one of the facilities provided by Web JetAdmin, which is HP's free Web-based print management software: see <http://www.hp.com/go/webjetadmin>.

If you have difficulty in using Secure Disk Erase from Web JetAdmin, contact HP Support: see [Contact HP Support on page 166](#).



NOTE: If you choose to erase the whole hard disk, you may be asked to restart the printer several times during the process, which will take about 6 hours with Secure Disk Erase or 24 hours with Secure Sanitizing Erase.

15 Accessories

- [How to order supplies and accessories](#)
- [Introduction to the accessories](#)

How to order supplies and accessories

There are two alternative ways to order supplies or accessories for your printer:

- Visit <http://www.hpmedia.com> on the Web.
- Contact HP Support (see [Contact HP Support on page 166](#)).

The rest of this chapter lists the available supplies and accessories, and their part numbers.

Order ink supplies

The following ink supplies can be ordered for your printer.

Ink cartridges

Cartridge	Product number
HP 745 130-ml Magenta Ink Cartridge	F9J95A
HP 745 130-ml Yellow Ink Cartridge	F9J96A
HP 745 130-ml Cyan Ink Cartridge	F9J97A
HP 745 130-ml Photo Black Ink Cartridge	F9J98A
HP 745 130-ml Matte Black Ink Cartridge	F9J99A
HP 745 130-ml Chromatic Red Ink Cartridge	F9K00A
HP 745 300-ml Magenta Ink Cartridge	F9K01A
HP 745 300-ml Yellow Ink Cartridge	F9K02A
HP 745 300-ml Cyan Ink Cartridge	F9K03A
HP 745 300-ml Photo Black Ink Cartridge	F9K04A
HP 745 300-ml Matte Black Ink Cartridge	F9K05A
HP 745 300-ml Chromatic Red Ink Cartridge	F9K06A

Printheads

Printhead	Product number
HP 744 Photo Black and Cyan Printhead	F9J86A
HP 744 Magenta and Yellow Printhead	F9J87A
HP 744 Matte Black and Chromatic Red Printhead	F9J88A

Order paper

The following paper types are currently provided for use with your printer.

 **NOTE:** This list is likely to change over the course of time. For the latest information, see <http://www.hpmedia.com>.

 **NOTE:** Paper types that HP does not support may nevertheless be compatible with your printer.

Key to availability:

- (A) indicates papers available in Asia (excluding Japan)
- (C) indicates papers available in China
- (E) indicates papers available in Europe, the Middle East and Africa
- (J) indicates papers available in Japan
- (L) indicates papers available in Latin America
- (N) indicates papers available in North America

If the part number is not followed by parentheses, the paper is available in all regions.

Roll paper

Paper type	g/m ²	Length	Width	Product number
HP Photographic Paper				
HP Premium Instant-dry Gloss Photo Paper	260	22.9 m (75 ft)	610 mm (24 in)	Q7991A
			914 mm (36 in)	Q7993A
			1067 mm (42 in)	Q7995A
HP Premium Instant-dry Satin Photo Paper	260	22.9 m (75 ft)	610 mm (24 in)	Q7992A
			914 mm (36 in)	Q7994A
			1067 mm (42 in)	Q7996A
HP Everyday Instant-dry Gloss Photo Paper	235	30.5 m (100 ft)	610 mm (24 in)	Q8916A
			914 mm (36 in)	Q8917A
			1067 mm (42 in)	Q8918A
HP Everyday Instant-dry Satin Photo Paper	235	30.5 m (100 ft)	610 mm (24 in)	Q8920A
			914 mm (36 in)	Q8921A
			1067 mm (42 in)	Q8922A
HP Universal Instant-dry Gloss Photo Paper	200	30.5 m (100 ft)	610 mm (24 in)	Q6574A
			914 mm (36 in)	Q6575A
			1067 mm (42 in)	Q6576A
			61 m (200 ft)	Q8754A
HP Universal Instant-dry Satin Photo Paper	200	30.5 m (100 ft)	610 mm (24 in)	Q6579A
			914 mm (36 in)	Q6580A
			1067 mm (42 in)	Q6581A
			61 m (200 ft)	Q8755A
HP Premium Matte Photo Paper	210	30.5 m (100 ft)	610 mm (24 in)	CG459B
			914 mm (36 in)	CG460B
HP Backlit Material				
HP Premium Vivid Color Backlit Film	285	30.5 m (100 ft)	914 mm (36 in)	C8747A
			1067 mm (42 in)	C8748A
HP Self-Adhesive Material				

Roll paper (continued)

Paper type	g/m ²	Length	Width	Product number
HP Everyday Adhesive Matte Polypropylene	120	22.9 m (75 ft)	610 mm (24 in)	C0F18A
	168 with liner		914 mm (36 in)	C0F19A
			1067 mm (42 in)	C0F20A
HP Everyday Adhesive Gloss Polypropylene	120	22.9 m (75 ft)	914 mm (36 in)	C0F28A
	168 with liner		1067 mm (42 in)	C0F29A
HP Universal Adhesive Vinyl	150	20 m (66 ft)	914 mm (36 in)	C2T51A
	290 with liner		1067 mm (42 in)	C2T52A
HP Colorfast Adhesive Vinyl	190	12.2 m (40 ft)	914 mm (36 in)	C0F08A
	345 with liner			
HP Banner and Sign Material				
HP Opaque Scrim	460	15.2 m (50 ft)	610 mm (24 in)	Q8675C
			914 mm (36 in)	Q1898C
			1067 mm (42 in)	Q1899C
HP Premium Matte Polypropylene	140	22.9 m (75 ft)	914 mm (36 in)	C2T53A (AEN)
			1067 mm (42 in)	C2T54A (AEN)
HP Everyday Matte Polypropylene	120	30.5 m (100 ft)	610 mm (24 in)	CH022A
			914 mm (36 in)	CH023A
			1067 mm (42 in)	CH025A
		61 m (200 ft)	914 mm (36 in)	CH024A
HP Durable Semi-gloss Display Film	265	15.2 m (50 ft)	914 mm (36 in)	Q6620B
HP Durable Banner with DuPont Tyvek	133	22.9 m (75 ft)	914 mm (36 in)	C0F12A
			1067 mm (42 in)	C0F13A
HP Bond and Coated Paper				
HP Super Heavyweight Plus Matte Paper	210	30.5 m (100 ft)	610 mm (24 in)	Q6626B
			914 mm (36 in)	Q6627B
			1067 mm (42 in)	Q6628B
HP Universal Bond Paper	80	45.7 m (150 ft)	594 mm (23.39 in) (A1)	Q8003A
			610 mm (24 in)	Q1396A
			914 mm (36 in)	Q1397A
			1067 mm (42 in)	Q1398A
		91.4 m (300 ft)	594 mm (23.39 in) (A1)	Q8004A
			841 mm (33.11 in) (A0)	Q8005A
		175 m (574 ft)	914 mm (36 in)	Q8751A
HP Bright White Inkjet Paper	90	45.7 m (150 ft)	419 mm (16.5 in)	Q1446A

Roll paper (continued)

Paper type	g/m ²	Length	Width	Product number
			594 mm (23.39 in) (A1)	Q1445A
			610 mm (24 in)	C1860A
			610 mm (24 in)	C6035A
			841 mm (33.11 in) (A0)	Q1444A
			914 mm (36 in)	C6036A
			914 mm (36 in)	C1861A
			91.4 m (300 ft)	914 mm (36 in)
HP Heavyweight Coated Paper	130	30.5 m (100 ft)	610 mm (24 in)	C6029C
			914 mm (36 in)	C6030C
			1067 mm (42 in)	C6569C
			67.5 m (225 ft)	1067 mm (42 in)
HP Coated Paper	90	45.7 m (150 ft)	420 mm (16.54 in) (A2)	Q1443A
			594 mm (23.39 in) (A1)	Q1442A
			610 mm (24 in)	C6019B
			841 mm (33.11 in) (A0)	Q1441A
			914 mm (36 in)	C6020B
			1067 mm (42 in)	C6567B
91.4 m (300 ft)	914 mm (36 in)	C6980A		
HP Fine Art Printing Material				
HP Artist Matte Canvas	390	15.2 m (50 ft)	610 mm (24 in)	E4J54B
			914 mm (36 in)	E4J55B
			1067 mm (42 in)	E4J56B
			1118 mm (44 in)	E4J57A
HP Matte Litho-realistic Paper	269	30.5 m (100 ft)	610 mm (24 in)	K6B77A
			914 mm (36 in)	K6B78A

Order accessories

The following accessories can be ordered for your printer.

Name	Product number
HP DesignJet 24-inch Roll Feed Spindle	CQ783A
HP DesignJet 44-inch Roll Feed Spindle	Q6709A
HP DesignJet 3-in Spindle Adaptor Kit	CN538A
HP Jetdirect 640n Print Server	J8025A
HP DesignJet HD Scanner	CQ654C

Introduction to the accessories

Spindle

With extra spindles, you can change rapidly from one paper type to another.

Jetdirect print server

Jetdirect print servers support extra connectivity and security options beyond those provided in the standard Ethernet interface built into the printer.

16 Troubleshooting paper issues

- [The paper cannot be loaded successfully](#)
- [The paper type is not in the driver](#)
- [The printer printed on the wrong paper type](#)
- [Automatic cut not available](#)
- [On hold for paper](#)
- [The roll paper will not advance](#)
- [The paper has jammed](#)
- [A strip stays on the output tray and generates jams](#)
- [The printer displays out of paper when paper is available](#)
- [Prints do not fall neatly into the basket](#)
- [The sheet stays in the printer when the print has been completed](#)
- [The paper is cut when the print has been completed](#)
- [The cutter does not cut well](#)
- [The roll is loose on the spindle](#)
- [Recalibrate the paper advance](#)

The paper cannot be loaded successfully

- Ensure that no paper is already loaded.
- Ensure that the paper is far enough inside the printer: you should feel the printer grab the paper.
- Do not attempt to straighten the paper during the aligning process, unless instructed to do so by the front-panel display. The printer automatically attempts to straighten the paper.
- The paper may be crumpled, or warped, or may have irregular edges.
- It can be difficult to insert a particularly stiff paper from the upper roll. Try moving it to the lower roll.

General unsuccessful roll load issues

- If the paper does not load, the leading edge of the paper may not be straight or clean and needs to be trimmed. Remove the initial 2 cm (1 in) from the roll and try again. This may be necessary even with a new roll of paper.
- Ensure the roll ends are tight against the spindle ends.
- Check that the spindle is correctly inserted.
- Check that the paper is correctly loaded on the spindle, and that it loads over the roll towards you.
- Check that all roll end plugs have been removed.
- Check that the paper is wound tightly on the roll.
- Do not touch the roll or paper at during the alignment process.
- When loading a roll, the roll cover must remain open until the front panel prompts you to close it.
- When loading the upper roll, avoid inserting the paper into the cut sheet slot.

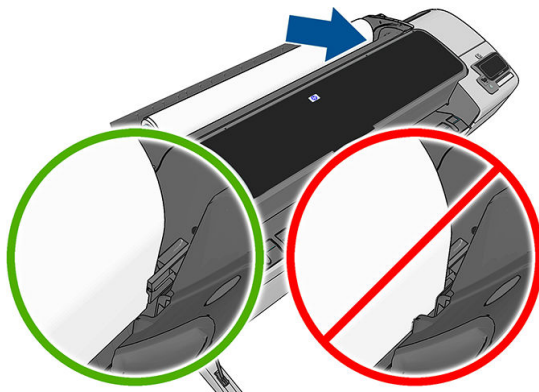

Unsuccessful roll load

If the paper has not been inserted straight, the front panel displays the following instructions.

1. When prompted by the front-panel display, lift the blue lever on the left. The printer attempts to straighten the roll.
2. When prompted by the front-panel display, lower the blue lever. The printer checks the alignment. If the roll is aligned, the printer prompts you to close the roll cover, and you are now ready to print.

If the roll is still not aligned, the front panel displays an error and instructions to start again.

If you would like to start the load process again, cancel the process on the front panel and rewind the roll from the end of the spindle until the edge is removed from the printer.



NOTE: If the roll has become loose around the core, the printer cannot load the paper.

Unsuccessful sheet load



- Guide the sheet, especially thick papers, when the printer initially feeds the sheet.
- Ensure that the sheet is aligned with the reference line on the roll cover.
- Do not attempt to straighten the sheet during the loading process, unless instructed to by the front-panel display.
- Do not use hand-cut sheets, which may be of irregular shapes. Use only purchased sheets.

In case of any problem, follow the instructions given on the front-panel display.

If you would like to start the load process again, cancel the process on the front panel; the printer ejects the sheet from the front of the printer.

Paper loading error messages

Here is a list of front-panel messages related to paper loading, with the suggested corrective action.

Front-panel message	Suggested action
Close the roll cover when the paper load is finished	Close the roll cover when the paper load is finished.
Lever lifted	During the load process the blue lever was lifted. This prevents the printer from loading the paper. Follow the instructions on the front-panel display.
Paper incorrectly loaded	The paper has not been loaded correctly. Lift the blue lever, remove the paper and lower the lever.
Paper loaded with too much skew	During the paper load process the printer detected that the paper had too much skew. Follow the instructions on the front-panel display.
Paper loose around core	The end of the roll has become loose around the core. Tighten the paper to the core or insert a new roll.
Paper not detected	During the paper load process the printer did not detect any paper. Ensure the paper is inserted fully and is not transparent.
Roll cover closed during paper load process	Do not close the roll cover until you are prompted to do so by the front panel.
Sheet too big	During the load process the printer has detected that the sheet of paper is either too wide or too long to be loaded correctly. Press  to stop the load process. See Functional specifications on page 169 .
Sheet too small	During the load process the printer detected that the sheet of paper is too narrow or too short to be loaded in the printer. Press  to stop the load process. See Functional specifications on page 169 .
Upper roll load and paper is inserted through the single sheet path	Avoid inserting roll paper into the cut sheet slot.

The paper type is not in the driver

To work with a paper not in the driver, you can use your paper as one of the presets already in the driver, however, you must identify whether your paper is transparent or translucent, glossy or matte.



NOTE: For glossy paper, it is important to use a glossy paper type, as matte black ink does not print well on glossy paper.

Glossy paper

If your paper is a photo paper, use the **Photo Paper** category. For glossy or high-gloss paper select paper type **Photo Gloss Paper**. For Semi-gloss, Satin, Pearl or Luster finishes, select paper type **Semi-gloss/Satin Paper**.

To increase gamut on photo paper, select paper type **HP Universal High-gloss Photo Paper** or **HP Universal Semi-gloss Photo Paper**, depending on the finish.

Matte Paper

Your paper type selection for matte paper depends on the paper's ink absorption capacity. To select a paper category and type, first identify if your paper is general purpose or photographic. Then select the recommended paper types.

General-purpose paper

- For natural tracing papers, select paper type **Natural Tracing Paper < 65 g/m²** or **Natural Tracing Paper > 65 g/m²**, depending on the weight of the paper.
- For thin papers (< 90 g/m²) uncoated papers (for example plain paper or bright white paper) select paper type **Bond and Coated Paper > Plain Paper**.
- For light coated papers (< 110 g/m²), select paper type **Bond and Coated Paper > HP Coated Paper**.
- For heavyweight coated papers (< 200 g/m²), select paper type **Bond and Coated Paper > Heavyweight Coated Paper**.
- For cockle-free very thick coated papers (> 200 g/m²), select paper type **Bond and Coated Paper > Super Heavyweight Coated Paper**.

Photographic paper

For photographic paper, select paper type **Photo Paper > Photo Matte Paper**.

Black ink is easily removed when touched

This happens when your paper is incompatible with matte black ink. To use non-matte black ink, select paper type **Photo Paper > Photo Gloss Paper**.

After printing, the paper has wrinkles or there is too much ink

This happens when too much ink is used. To use less ink, select a thinner category. Matte paper categories from thinnest to thickest are:

- Plain Paper
- Coated Paper
- Heavyweight Coated Paper
- Super Heavyweight Coated Paper

For other image quality problems, see [Troubleshooting print-quality issues on page 134](#).

The printer printed on the wrong paper type

If the printer prints your job before you were able to load your desired paper, you may have **Use Printer Settings** or **Any** selected for the Paper Type in the printer driver. When either of these is selected, the printer will print immediately on whichever paper is loaded. Load your desired paper, see [Paper handling on page 32](#), and select your paper type specifically in the driver.

- **In the Windows driver dialog:** select the **Paper/Quality** tab, then select your paper type from the Paper Type list.
- **In the Mac OS X Print dialog:** select the **Paper/Quality** panel, then select your paper type from the Paper Type list.



NOTE: Use **Printer Settings** (Windows) or **Any** (Mac OS X) is the driver default.

Automatic cut not available

Some paper types, such as canvas, cannot be cut by the automatic cutter. When such a paper type is loaded and active, the printer cannot switch automatically to the other roll: the active roll must first be unloaded manually.

On hold for paper

Based on a set of conditions that you can set when sending a job (see [Paper mismatch action on page 22](#)), the printer will decide which of the loaded rolls of paper is more suitable to print the job. If there is no roll of paper available that meets all the conditions, the printer will put the job on hold for paper. You can manually resume the job, forcing it to print on a paper other than the one originally specified, otherwise it will stay on hold.



NOTE: When an uncuttable roll is active, every job sent to any other paper source is put on hold until you manually unload the uncuttable roll.

Which criteria are used to decide on which roll a job will be printed?

When a user sends a job, the desired paper type can be set (in the driver or in the Embedded Web Server). The printer will print the job on a roll of paper of the chosen paper type that is large enough to print the drawing without clipping. If there is more than one roll on which the job could be printed meeting all the criteria, the roll will be chosen according to your preferences. These can be set from the front panel: see [Roll switching options \(Z5600 only\) on page 22](#).

When is a job put on hold for paper?

If the paper mismatch action is set to **Put job on hold** (see [Paper mismatch action on page 22](#)), a job is put on hold for paper in the following cases:

- The paper type that has been selected by the user is not currently loaded on the specified roll—or on either of the rolls, if no roll has been specified.
- The paper type that has been selected by the user is loaded on the specified roll, but the drawing is too large to fit on the roll—or on either of the rolls, if no roll has been specified.

If I load a new roll of paper, will jobs that were on hold for paper be automatically printed?

Yes. Every time a new roll of paper is loaded, the printer will check if there are any jobs on hold for paper that could be printed on the loaded roll.

I don't like jobs being put on hold for paper. Can I prevent it?

Yes, this can be done from the front panel: see [Paper mismatch action on page 22](#).

I set the option “Paper mismatch action” to Print anyway, but some jobs are still put on hold

If the **Show print preview** option is selected in the driver or the Embedded Web Server, jobs are put on hold until you have checked the preview and resumed the job. Check that the **Show print preview** option is not checked in the driver, and that there are no pending preview windows waiting for confirmation to continue printing.

My job is exactly as wide as the roll of paper that is loaded on the printer, but is put on hold for paper

Margins are managed in different ways depending on the file type:

- For HP-GL/2 and HP RTL files, by default, margins are included inside the drawing, so a 914 mm (36 in) HP-GL/2 and HP RTL file can be printed on a 914 mm (36 in) roll of paper and will not be put on hold for paper.
- For other file formats, such as PostScript, PDF, TIFF, or JPEG, the printer assumes that margins need to be added outside the drawing (as, in many cases, these formats are used for photographs and other images that do not include margins). This means that, to print a 914 mm (36 in) TIFF, the printer needs to add margins, and the drawing needs 925 mm (36.4 in) of paper to be printed; this would cause the job to be put on hold if the paper that is loaded on the printer is only 914 mm (36 in) wide.

If you wish to print these file formats without adding extra margins outside of the drawing, the **Clip contents by margins** option can be used. This option will force the margins to be set inside of the drawing, so a 914 mm (36 in) TIFF can be printed on a 914 mm (36 in) roll of paper without being put on hold. However, if there is no white space already included in the drawing's borders, some contents could be clipped because of the margins.

The roll paper will not advance

If you have pushed the printer up against a wall, the roll may be touching the wall at the rear of the printer. Use the wall spacers to ensure a minimum distance between printer and wall. See [The wall spacers on page 8](#).

The paper has jammed

When a paper jam occurs, you normally see the **Possible paper jam** message in the front-panel display.

1. Power off the printer at the front panel and also switch it off at the rear.

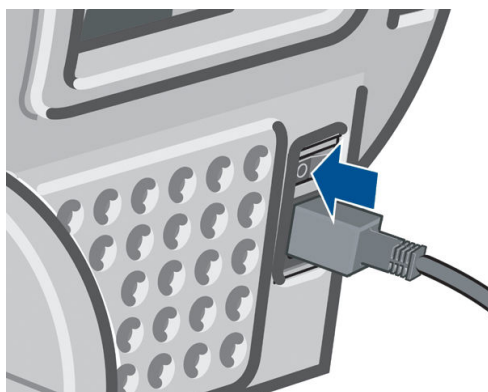

2. Open the window.

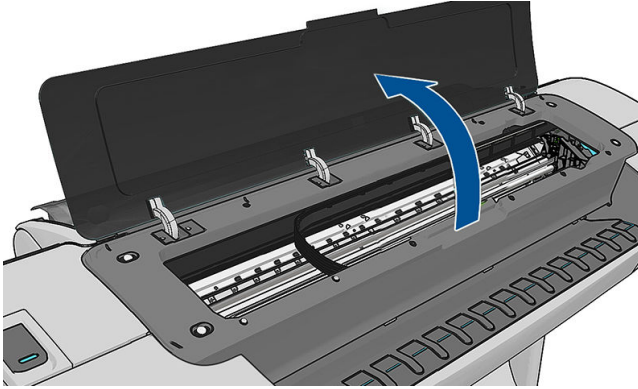

3. Try to move the printhead carriage out of the way.

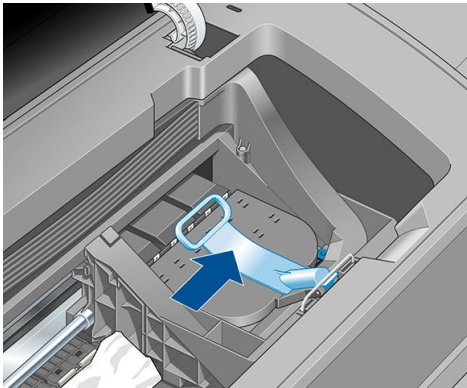

4. Lift the blue lever as far up as it will go.

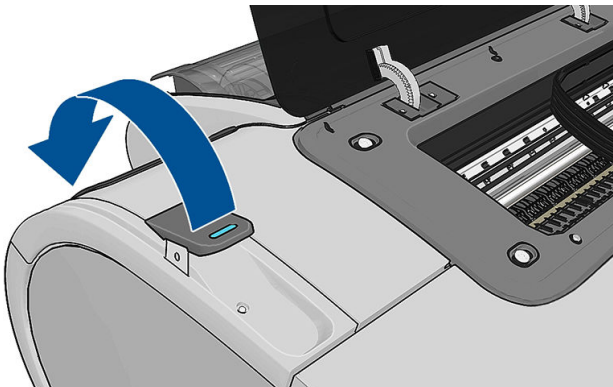

5. Carefully remove any of the jammed paper that you can lift up and out from the top of the printer.

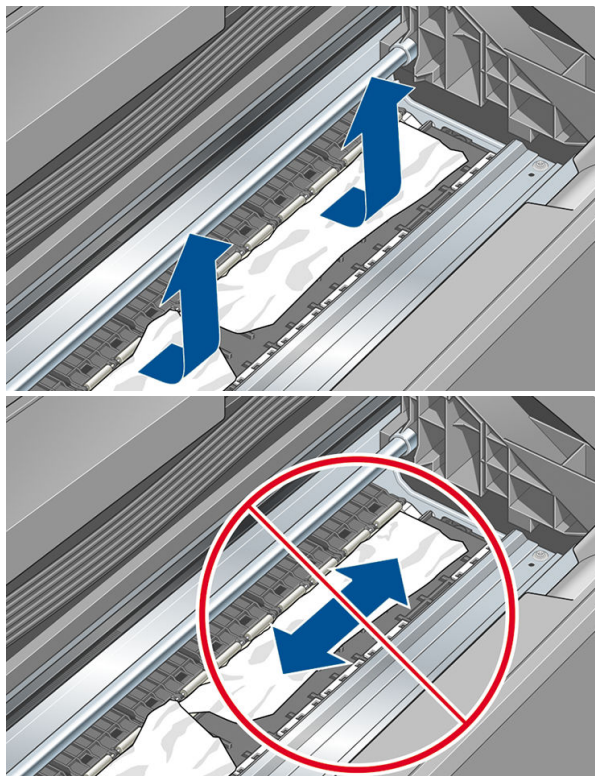

⚠ CAUTION: Do not move the paper sideways, as it could damage the printer.

6. Rewind the roll. If the paper is stuck and cannot be rewound further, cut it from the roll.

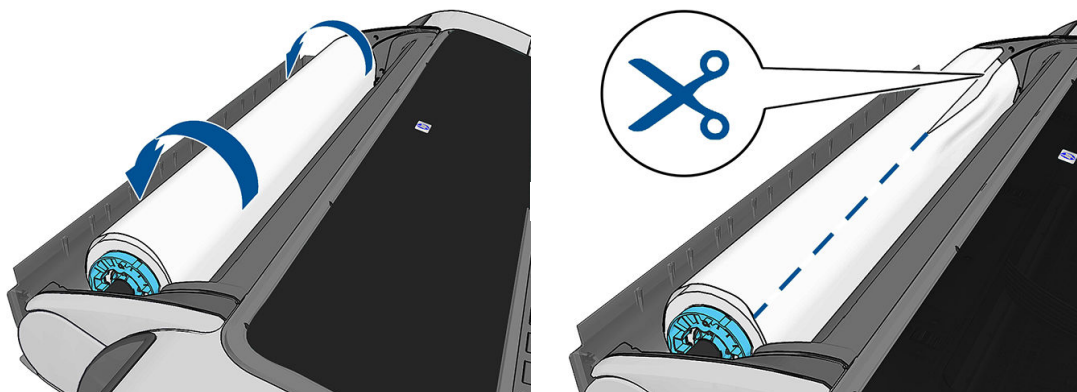

7. Remove all pieces of paper from the rear of the printer.

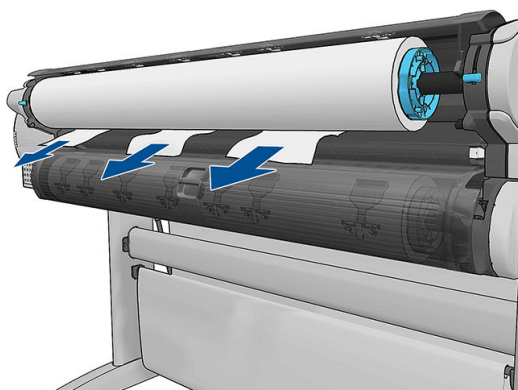

8. Lower the blue lever.

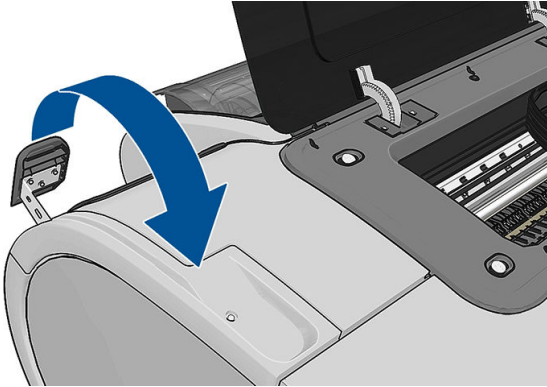

9. Close the window.

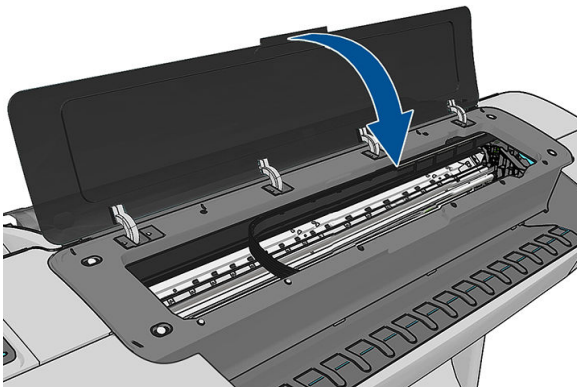

10. Switch on the printer.

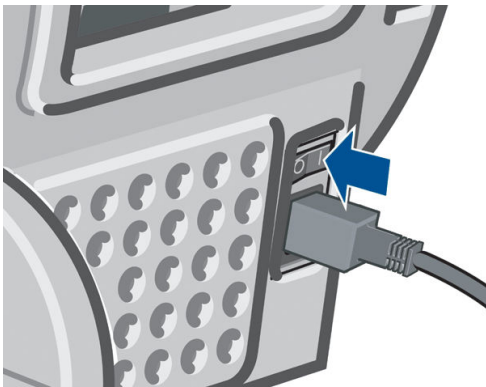

11. Reload the roll, or load a new sheet see [Paper handling on page 32](#).



NOTE: If you find that there is still some paper causing an obstruction within the printer, restart the procedure and carefully remove all pieces of paper.

A strip stays on the output tray and generates jams

If a small piece of paper (200 mm or smaller) has been cut, such as before (if new roll) and after a full-bleed print or after the front-panel option **Form feed and cut** has been used, the cut strip remains in the output tray. Only when the printer is not printing, reach into the tray and remove the strip.

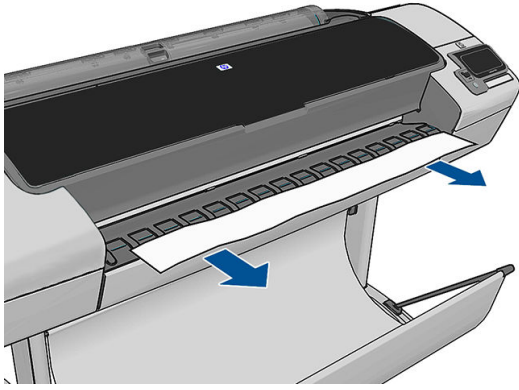

The printer displays out of paper when paper is available

If the roll has become loose from its core, it will not feed correctly and the printer will not load the paper. If possible, tighten the paper to its core or load a new roll.

Prints do not fall neatly into the basket

- Ensure the basket is correctly installed.
- Ensure the basket is open.
- Ensure the basket not full.
- Paper often tends to curl near the end of a roll, which can cause output problems. Load a new roll, or remove prints manually as they are completed.

The sheet stays in the printer when the print has been completed

The printer holds the paper to allow the print to dry after printing, see [Change the drying time on page 46](#). If the paper is only partially ejected after the drying time, gently pull the sheet out of the printer. If the automatic cutter is disabled, use the **Form feed and cut** option in the front panel, see [Feed and cut the paper on page 47](#).

The paper is cut when the print has been completed

By default the printer cuts the paper after the drying time has been completed, see [Change the drying time on page 46](#). You can disable the cutter, see [Turn the automatic cutter on and off on page 46](#).

The cutter does not cut well

By default, the printer is set to cut the paper automatically after the drying time has been completed. If the cutter is turned on but not cutting correctly, check that the cutter rail is clean and clear of any obstacles.

If the cutter is turned off, **Form feed and cut** only advances the paper. Use it to move the print far enough out of the front of the printer, until it is convenient to cut manually with a straight edge or scissors.



The roll is loose on the spindle

The roll may need to be replaced or reloaded.

Recalibrate the paper advance

Accurate paper advance is important to image quality because it is part of controlling the proper placement of dots on the paper. If the paper is not advanced the proper distance between printhead passes, light or dark bands appear in the print and image grain may increase.

The printer is calibrated to advance correctly with all the papers appearing in the front panel. When you select the type of loaded paper, the printer adjusts the rate at which to advance the paper while printing. However, if you are not satisfied with the default calibration of your paper, you may need to recalibrate the rate at which the paper advances. See [Troubleshooting print-quality issues on page 134](#) for steps to determine if paper advance calibration will solve your issue.



You can check the paper advance calibration status of the currently loaded paper from the front panel at any time by pressing , then , then **Image-quality maintenance > Calibration Status**. The status may be one of the following.

- **DEFAULT:** This status appears when loading any paper that has not been calibrated. HP papers in the Front Panel have been optimized by default and unless you experience image quality problems in your printed image such as banding or graininess it is not recommended to recalibrate the paper advance.
- **OK:** This status indicates that the loaded paper has been calibrated before. However you may need to repeat the calibration if you experience image quality problems such as banding or graininess in your printed image.





NOTE: Whenever you update the printer's firmware, the paper advance calibration values are reset to factory default, see [Update the firmware on page 113](#).



CAUTION: Transparent papers and films must be calibrated by pressing , then , then **Image-quality maintenance > Paper advance calibration > Adjust paper advance**, from step four in Recalibrating the paper advance procedure.



Recalibrating the paper advance procedure

1. From the front panel, press , then , then **Image-quality maintenance > Paper advance calibration > Calibrate paper advance**. The printer automatically recalibrates the paper advance and prints a paper advance calibration image.
2. Wait until the front panel displays the status screen and re-print your print.



NOTE: The recalibration procedure takes approximately three minutes. Do not worry about the paper advance calibration image. The front-panel display shows any errors in the process.

If you are satisfied with your print continue using this calibration for your paper type. If you see improvement in your print, continue with step three. If you are dissatisfied with the recalibration, return to the default calibration, see [Return to default calibration on page 133](#).

3. If you would like to fine-tune the calibration or are using a transparent paper, press , then , then **Image-quality maintenance > Paper advance calibration > Adjust paper advance**.

4. Select the percentage of change from –100% to +100%. To correct light banding, decrease the percentage.

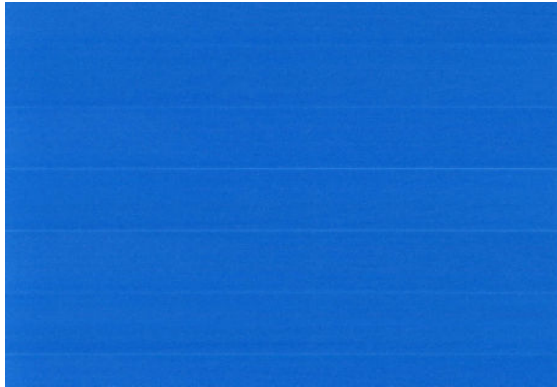

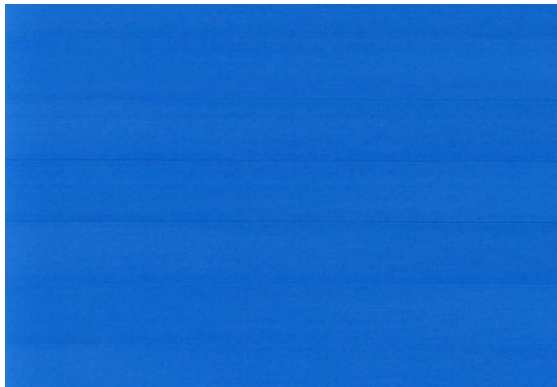

To correct dark banding, increase the percentage.



5. Press **OK** on the front panel, to save the value.
6. Wait until the front panel displays the status screen and reprint your print.

Return to default calibration

Returning to the default calibration sets all the corrections made by the paper advance calibration to zero. To return to the default paper advance calibration value, you must reset the calibration.

1. From the front panel, press , then , then **Image-quality maintenance > Paper advance calibration > Reset paper advance**.
2. Wait until the front panel displays the operation has completed successfully.

17 Troubleshooting print-quality issues

- [General advice](#)
- [Print quality troubleshooting wizard](#)
- [Horizontal lines across the image \(banding\)](#)
- [Thin vertical lines across the image](#)
- [The whole image is blurry or grainy](#)
- [The paper is not flat](#)
- [The print is scuffed or scratched](#)
- [Ink marks on the paper](#)
- [Black ink comes off when you touch the print](#)
- [Edges of objects are stepped or not sharp](#)
- [Edges of objects are darker than expected](#)
- [Bronzing](#)
- [Horizontal lines at the end of a cut sheet print](#)
- [Vertical lines of different colors](#)
- [White spots on the print](#)
- [Colors are inaccurate](#)
- [The image is incomplete \(clipped at the bottom\)](#)
- [The image is clipped](#)
- [Some objects are missing from the printed image](#)
- [Lines are too thick, too thin or missing](#)
- [Lines appear stepped or jagged](#)
- [Lines print double or in the wrong colors](#)
- [Lines are discontinuous](#)
- [Lines are blurred](#)
- [Line lengths are inaccurate](#)
- [The Image Diagnostics Print](#)
- [If you still have a problem](#)

General advice

When you have any print-quality problem:

- To achieve the best performance from your printer, use only genuine manufacturer's supplies and accessories, whose reliability and performance have been thoroughly tested to give trouble-free performance and best-quality prints. For details of recommended papers, see [Order paper on page 117](#).
- Make sure that the paper type selected in the front panel is the same as the paper type loaded into the printer (see [View information about the paper on page 42](#)). At the same time, check that the paper type has been calibrated. Also make sure that the paper type selected in your software is the same as the paper type loaded into the printer.

CAUTION: If you have the wrong paper type selected, you could experience poor print quality and incorrect colors, and perhaps even damage to the printheads.

- Check that you are using the most appropriate print-quality settings for your purposes (see [Printing on page 50](#)). You are likely to see lower print quality if you have moved the print-quality slider to the 'Speed' end of the scale, or set the custom quality level to **Fast**.
- Check that your environmental conditions (temperature, humidity) are in the recommended range. See [Environmental specifications on page 171](#).
- Check that your ink cartridges and printheads have not passed their expiration dates: see [Maintain the ink cartridges on page 112](#).

Print quality troubleshooting wizard

The Print Quality Troubleshooting Wizard can help with the following problems:

- Horizontal lines across the image (banding)
- The whole image is blurry or grainy
- Lines are too thick, too thin or missing
- Colors are inaccurate

To start the wizard:

- **From the HP DesignJet Utility for Windows:** go to the **Support** tab, and select **Print quality troubleshooting**.
- **From the HP DesignJet Utility for Mac OS X:** select **Print quality troubleshooting** in the Support group.
- **From the Embedded Web Server:** go to the **Support** tab, select **Troubleshooting**, then select **Print quality troubleshooting**.

Most common print quality issues resolution

Select defect

You may be experiencing **banding**, **graininess**, **poor line quality** or **color inaccuracy** problems similar to the ones shown in the images below. Please select the option that best represents your problem and press the Next button to enter the corresponding troubleshooting process.



Banding Graininess Poor line quality Color inaccuracy

If you see other image quality problems such as non-flat paper, ink bleeds from lines, print smudges when touched, etc., please refer to the:

- [Printer User's Guide](#)

If you want to download detailed step-by-step guides that will help you to get the right layout and color for your prints, please refer to the:

- [HP Knowledge Center](#)

Defect detail

- Roll over the images to obtain more specific information about the corresponding defect.

Next ►



Exit

Alternatively, or if you have other print quality problems, you can continue reading this chapter.

Horizontal lines across the image (banding)

If your printed image suffers from added horizontal lines as shown (the color may vary):



1. Check that the paper type you have loaded corresponds to the paper type selected in the front panel and in your software. See [View information about the paper on page 42](#).
2. Check that you are using appropriate print-quality settings for your purposes (see [Printing on page 50](#)). In some cases, you can overcome a print-quality problem merely by selecting a higher print-quality level. For instance, if you have set the Print Quality slider to **Speed**, try setting it to **Quality**. If you change the print-quality settings, you may wish to reprint your job at this point in case the problem has been solved.
3. Print the Image Diagnostics Print. See [The Image Diagnostics Print on page 146](#).
4. If the printheads are working correctly, go to the front panel and press , then , then **Image-quality maintenance > Calibration Status** to see the paper advance calibration status. If the status is **DEFAULT**, try performing paper advance calibration: see [Recalibrate the paper advance on page 132](#).

If the problem persists despite all the above actions, contact your customer service representative for further support.





Thin vertical lines across the image

If you see thin, straight, vertical lines separated by about 5 cm (2 in), across the whole width of the roll in prints with dark area fills, try selecting sensitive-paper mode for that roll. See [Sensitive-paper mode on page 42](#).



The whole image is blurry or grainy



1. Check that the paper type you have loaded corresponds to the paper type selected in the front panel and in your software. See [View information about the paper on page 42](#).
2. Check that you are printing on the correct side of the paper.
3. Check that you are using appropriate print-quality settings (see [Printing on page 50](#)). In some cases, you can overcome a print-quality problem merely by selecting a higher print-quality level. For instance, if you have set the Print Quality slider to **Speed**, try setting it to **Quality**. If you change the print-quality settings, you may wish to reprint your job at this point in case the problem has been solved.
4. Go to the front panel and press , then , then **Image-quality maintenance > Calibration Status** to see the printhead alignment status. If the status is PENDING, you should align the printheads. See [Align the printheads on page 153](#). After alignment, you may wish to reprint your job in case the problem has been solved.
5. Go to the front panel and press , then , then **Image-quality maintenance > Calibration Status** to see the paper advance calibration status. If the status is DEFAULT, you should perform paper advance calibration: see [Recalibrate the paper advance on page 132](#).

If the problem persists despite all the above actions, contact your customer service representative for further support.

The paper is not flat

If the paper does not lie flat when it comes out of the printer, but has shallow waves in it, you are likely to see defects in the printed image, such as vertical stripes. This can happen when you use thin paper that becomes saturated with ink.



1. Check that the paper type you have loaded corresponds to the paper type selected in the front panel and in your software. See [View information about the paper on page 42](#).
2. Try changing to a thicker paper type, such as HP Heavyweight Coated Paper or HP Super Heavyweight Plus Matte Paper.
3. Select a paper type that is slightly thinner than the paper you have loaded; this will persuade the printer to use less ink. Here are some example paper types in ascending order of thickness: Plain Paper, Coated Paper, Heavyweight Coated Paper, Super Heavyweight Plus Matte Paper.

The print is scuffed or scratched

The black ink pigment can be scuffed or scratched when touched by a finger, a pen or some other object. This is particularly noticeable on coated paper.

Glossy paper may be extremely sensitive to the basket or to anything else that it contacts soon after printing, depending on the amount of ink used and the environmental conditions at the time of printing.

To reduce the risk of scuffs and scratches:

- Handle prints carefully.
- Avoid stacking prints on top of each other.
- Catch your prints as they are cut from the roll and do not let them fall into the basket. Alternatively, leave a sheet of paper in the basket so that freshly printed sheets do not make direct contact with the basket.

Ink marks on the paper

This problem can occur for several different reasons.

Horizontal smears on the front of coated paper

If a lot of ink is used on plain or coated paper, the paper absorbs the ink quickly and expands. As the printheads move over the paper, the printheads may come into contact with the paper and smear the printed image. This problem is normally seen only on cut sheets of paper (not on roll paper).

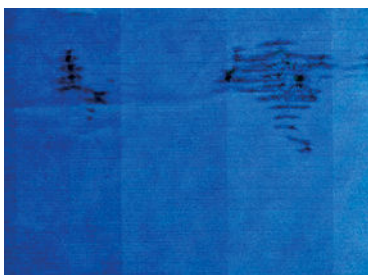

Whenever you notice this problem, cancel the printing job immediately. Press  and also cancel the job from your computer application. Soaked paper can damage the printheads.

Try the following suggestions to avoid this problem:

1. Check that the paper type you have loaded corresponds to the paper type selected in the front panel and in your software. See [View information about the paper on page 42](#).
2. Use a recommended paper type (see [Order paper on page 117](#)) and the correct print settings.
3. If using sheet paper, try rotating the sheet 90 degrees. The orientation of the paper fibers may affect performance.
4. Try changing to a thicker paper type, such as HP Heavyweight Coated Paper and HP Super Heavyweight Plus Matte Paper.
5. Select a paper type that is slightly thinner than the paper you have loaded; this will persuade the printer to use less ink. Here are some example paper types in ascending order of thickness: Plain Paper, Coated Paper, Heavyweight Coated Paper, Super Heavyweight Plus Matte Paper.
6. Try to increase the margins by relocating the image to the center of the page using your software application.

Ink marks on the back of the paper

This can happen after a lot of borderless printing, especially with non-standard paper sizes. Ink residues on the platen are likely to mark the back of the paper.

Clean the platen with a soft cloth. Clean each rib separately without touching the foam between the ribs.

Black ink comes off when you touch the print

This problem may be caused by printing with matte black ink on glossy paper. The printer will not use matte black ink if it knows that the paper will not retain it. To be sure of avoiding matte black ink, you can select Photo Glossy Paper as the paper type (in the Photo Paper category).

Edges of objects are stepped or not sharp

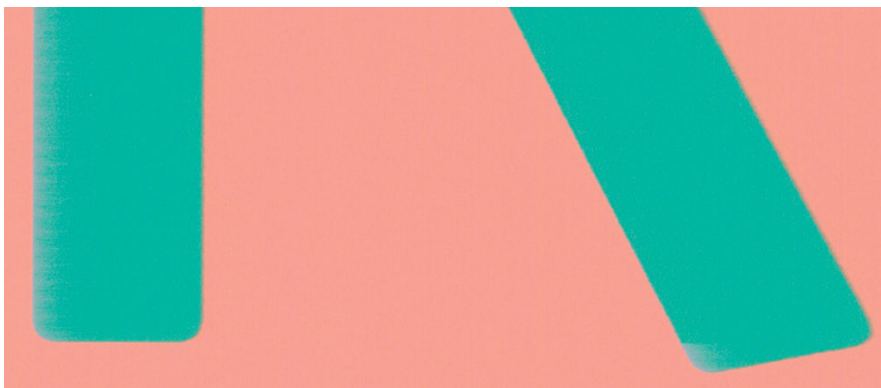

If edges of objects or lines appear to be poorly defined or lighter in density, and you have already set the print-quality slider to **Quality** in the driver dialog, select the custom print-quality options, and try setting the quality level to **Normal**. See [Printing on page 50](#).

Edges of objects are darker than expected



If edges of objects seem darker than expected, and you have already set the print-quality slider to **Quality** in the driver dialog, select the custom print-quality options, and try setting the quality level to **Normal**. See [Printing on page 50](#).

Bronzing

If you are printing on photo paper in grayscale, and you experience a gloss differential problem when fluorescent light is directly reflected towards you from the print, producing 'bronzed' reflections from the ink, try one of the following:

- If using standard print quality options, ensure that the slider is set to **Quality** (see [Printing on page 50](#)).
- Try selecting in the driver the **Full set of inks** option instead of **Black and gray inks only**.
- Display the print vertically or behind glass.

Horizontal lines at the end of a cut sheet print

This type of defect affects only the end of a print, within approximately 30 mm of the trailing edge of the paper. You may see some very thin horizontal lines across the print.

To avoid this problem:

1. Print the Image Diagnostics Print. See [The Image Diagnostics Print on page 146](#).
2. Consider printing with roll paper.
3. Consider using larger margins around your image.

Vertical lines of different colors

If your print has vertical bands of different colors along it:

1. Try using thicker paper, choosing from the recommended paper types such as HP Heavyweight Coated Paper and HP Super Heavyweight Paper. See [Order paper on page 117](#).
2. Try using higher print-quality settings (see [Printing on page 50](#)). For instance, if you have set the Print Quality slider to **Speed**, try setting it to **Quality**.

White spots on the print



You may notice white spots on the print. This is probably due to paper fibers, dust or loose coating material. To avoid this problem:

1. Try cleaning the paper manually with a brush before printing, to remove any loose fibers or particles.
2. Always keep the cover of your printer closed.
3. Protect your paper rolls and sheets by storing them in bags or boxes.

Colors are inaccurate





If the colors of your print do not match your expectations, try the following:

1. Check that the paper type you have loaded corresponds to the paper type selected in the front panel and in your software. See [View information about the paper on page 42](#). Also, press , then , then **Image-quality maintenance > Calibration Status** to check the color calibration status. If the status is PENDING or OBSOLETE, you should perform color calibration: see [Color calibration on page 74](#). If you have made any changes, you may wish to reprint your job in case the problem has been solved.
2. Check that you are printing on the correct side of the paper.
3. Check that you are using appropriate print-quality settings (see [Printing on page 50](#)). If you have selected the **Speed** or **Fast** options, you may not get the most accurate colors. If you change the print-quality settings, you may wish to reprint your job at this point in case the problem has been solved.
4. If you are using Application Color Management, check that the color profile you are using corresponds to the selected paper type and print-quality settings. If you have doubts about which color settings to use, see [Color management on page 73](#).
5. If the problem consists of color differences between your print and your monitor, follow the instructions in the “How to calibrate your monitor” section of the HP Color Center. At this point, you may wish to reprint your job in case the problem has been solved.
6. Print the Image Diagnostics Print. See [The Image Diagnostics Print on page 146](#).
7. Try using the color adjustment options to produce the colors you want. See [Color adjustment options on page 76](#).

If the problem persists despite all the above actions, contact your customer service representative for further support.

The image is incomplete (clipped at the bottom)

- Did you press  before all the data were received by the printer? If so, you have ended the data transmission and will have to print the page again.
- The **I/O timeout** setting may be too short. This setting determines how long the printer waits for the computer to send more data, before deciding that the job is finished. From the front panel, increase the **I/O timeout** setting to a longer period and then send the print again. Press , then , then **Setup > Connectivity > Network connectivity > Advanced > Select I/O timeout**.
- There may be a communications problem between your computer and the printer. Check your USB or network cable.
- Check to make sure that your software settings are correct for your current page size (for example, long-axis prints).
- If you are using network software, make sure it has not timed out.

The image is clipped

Clipping normally indicates a discrepancy between the actual printable area on the loaded paper and the printable area as understood by your software. You can often identify this kind of problem before printing by previewing your print (see [Preview a print on page 58](#)).

- Check the actual printable area for the paper size you have loaded.
printable area = paper size – margins
- Check what your software understands to be the printable area (which it may call "printing area" or "imageable area"). For example, some software applications assume standard printable areas that are larger than those used in this printer.
- If you have defined a custom page size with very narrow margins, the printer may impose its own minimal margins, clipping your image slightly. You may want to consider using a larger paper size, or borderless printing (see [Select margins options on page 56](#)).
- If your image contains its own margins, you may be able to print it successfully by using the **Clip Contents by Margins** option (see [Select margins options on page 56](#)).
- If you are trying to print a very long image on a roll, check that your software is capable of printing an image of that size.
- If you try to print an image larger than your software can handle, the bottom of the image may be clipped. To print the whole image, try these suggestions:
 - Save the file in another format, such as TIFF or EPS, and open it with another application.
 - Use a RIP to print the file.
- You may have asked to rotate the page from portrait to landscape on a paper size that is not wide enough.
- If necessary, reduce the size of the image or document in your software application, so it fits between the margins.

Some objects are missing from the printed image

Large quantities of data may be necessary to print a high-quality large-format print job, and in some specific workflows there may be issues that can lead to some objects missing from the output. Here are some suggestions to help you to avoid this problem.

- Select a smaller page size and scale to the desired final page size in the driver or in the front panel.
- Save the file in another format, such as TIFF or EPS, and open it with another application.
- Use a RIP to print the file.
- Reduce the resolution of bitmap images in your application software.
- Select a lower print quality in order to reduce the resolution of the printed image.





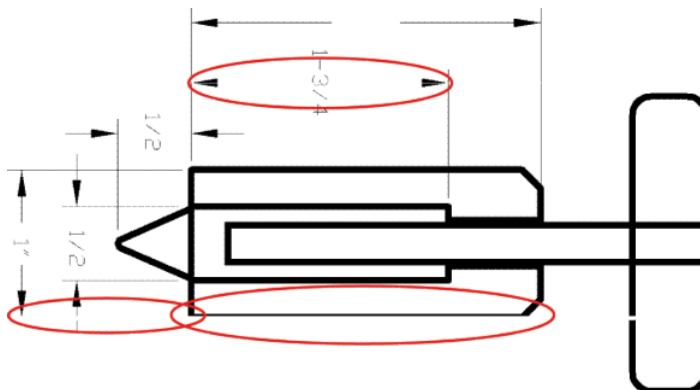

NOTE: If you are working under Mac OS X, not all of these options are available.

These options are suggested for troubleshooting purposes and may adversely affect the final output quality or the time necessary to generate the print job. Therefore, they should be cancelled if they do not help to solve the problem.

Lines are too thick, too thin or missing



1. Check that the paper type you have loaded corresponds to the paper type selected in the front panel and in your software. See [View information about the paper on page 42](#).
2. Check that you are using appropriate print-quality settings for your purposes (see [Printing on page 50](#)). Select the custom print-quality options in the driver dialog, and try turning on the **Maximum detail** option (if available). You may wish to reprint your job at this point in case the problem has been solved.
3. If the resolution of your image is greater than the printing resolution, you may notice a loss of line quality.
4. If lines are too thin or missing, print the Image Diagnostics Print. See [The Image Diagnostics Print on page 146](#).
5. If the problem remains, go to the front panel and press , then , then **Image-quality maintenance > Calibration Status** to see the printhead alignment status. If the status is PENDING, you should align the printheads. See [Align the printheads on page 153](#). After alignment, you may wish to reprint your job in case the problem has been solved.
6. Go to the front panel and press , then , then **Image-quality maintenance > Calibration Status** to see the paper advance calibration status. If the status is DEFAULT, you should perform paper advance calibration: see [Recalibrate the paper advance on page 132](#).

If the problem persists despite all the above actions, contact your customer service representative for further support.

Lines appear stepped or jagged

If lines in your image appear stepped or jagged when printed:

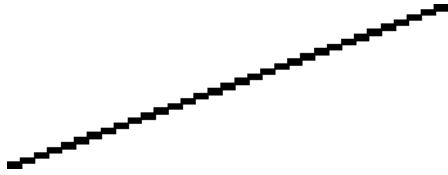

1. The problem may be inherent in the image. Try to improve the image with the application you are using to edit it.
2. Check that you are using appropriate print-quality settings. See [Printing on page 50](#).
3. Select the custom print-quality options in the driver dialog, and turn on the **Maximum detail** option (if available).

Lines print double or in the wrong colors

This problem can have various visible symptoms:

- Colored lines are printed double, in different colors.

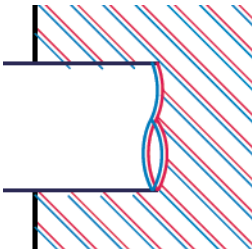

- The borders of colored blocks are wrongly colored.



To correct this kind of problem:

1. Reseat the printheads by removing them and then reinserting them. See [Remove a printhead on page 105](#) and [Insert a printhead on page 108](#).
2. Align the printheads. See [Align the printheads on page 153](#).

Lines are discontinuous

If your lines are broken in the following way:



1. Check that you are using appropriate print-quality settings. See [Printing on page 50](#).
2. Reseat the printheads by removing them and then reinserting them. See [Remove a printhead on page 105](#) and [Insert a printhead on page 108](#).
3. Align the printheads. See [Align the printheads on page 153](#).

Lines are blurred



Humidity can cause ink to soak into the paper, making the lines blurred and fuzzy. Try the following:

1. Check that your environmental conditions (temperature, humidity) are suitable for high-quality printing. See [Environmental specifications on page 171](#).
2. Check that the paper type selected in the front panel is the same as the paper type you are using. See [View information about the paper on page 42](#).
3. Try changing to a heavier paper type, such as HP Heavyweight Coated Paper or HP Super Heavyweight Plus Matte Paper.
4. Select a paper type that is slightly thinner than the paper you have loaded; this will persuade the printer to use less ink. Here are some example paper types in ascending order of thickness: Plain Paper, Coated Paper, Heavyweight Coated Paper, Super Heavyweight Plus Matte Paper.
5. If you are using glossy paper, try changing to a different type of glossy paper.
6. Align the printheads. See [Align the printheads on page 153](#).

Line lengths are inaccurate

If you have measured your printed lines and find that the lengths are not sufficiently accurate for your purposes, you can try to improve line length accuracy in the following ways.

1. Print on HP Matte Film, for which your printer's line length accuracy is specified. See [Functional specifications on page 169](#).

Polyester film is about ten times more dimensionally stable than paper. However, using film that is thinner or thicker than HP Matte Film will reduce line length accuracy.



2. Set the Print Quality slider to **Quality**.

- Maintain the room at a steady temperature between 10 and 30°C (50 and 86°F).
- Load the roll of film and let it rest for five minutes before printing.
- If you are still not satisfied, try recalibrating the paper advance. See [Recalibrate the paper advance on page 132](#).

The Image Diagnostics Print

The Image Diagnostics Print consists of patterns designed to highlight printhead reliability problems. It helps you to check the performance of the printheads that are currently installed in your printer, and whether any printhead suffers from clogging or other problems.

To print the Image Diagnostics Print:

- Use the same paper type that you were using when you detected a problem.
- Check that the selected paper type is the same as the paper type loaded into the printer. See [View information about the paper on page 42](#).
- At the printer's front panel, press , then , then select **Image-quality maintenance > Print diagnostic image**.

It takes about two minutes to print the Image Diagnostics Print.

The print is divided into two parts, both of which test printhead performance.

- Part 1 (top) consists of rectangles of pure colors, one for each printhead. This part represents the print quality that you will get from each color.
- Part 2 (bottom) consists of small dashes, one for each nozzle on each printhead. This part complements the first, and aims more specifically to detect how many faulty nozzles each printhead has.

Look carefully at the print. The names of the colors are shown above the rectangles and in the center of the patterns of dashes.

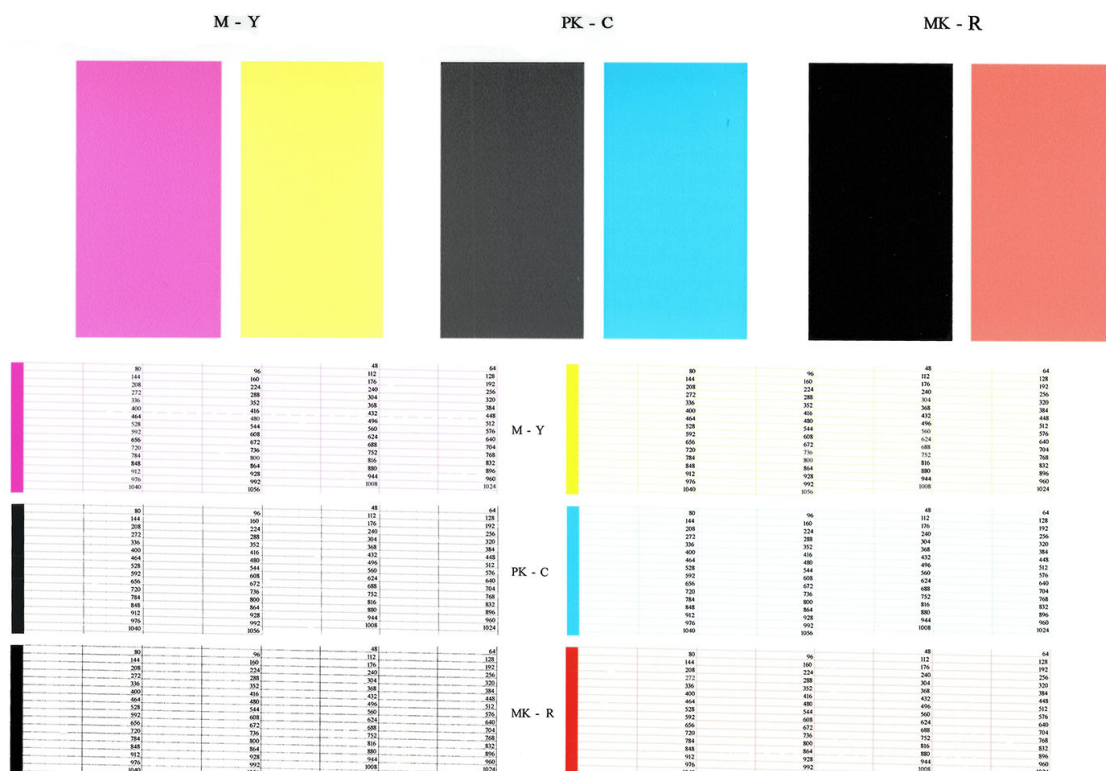

First look at the upper part of the print (part 1). Each colored rectangle should be a uniform color without any horizontal lines across it.

Then look at the bottom part of the print (part 2). For each individual colored pattern, check that most of the dashes are present.

If you see horizontal lines in part 1 and also missing dashes in part 2 for the same color, the printhead responsible needs cleaning. However, if the rectangles look solid, do not worry about just a few missing dashes in part 2; these are acceptable because the printer can compensate for a few clogged nozzles.

Here is an example of a gray printhead in a good state:

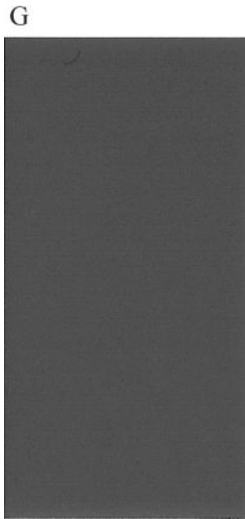

And here is an example of the same printhead in a bad state:

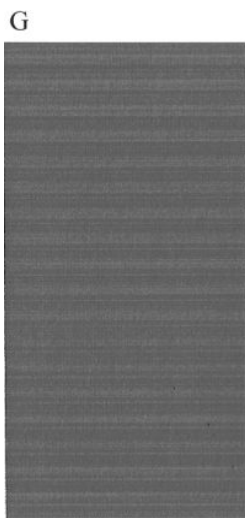

Corrective action

1. Clean any faulty printheads (see [Clean the printheads on page 151](#)). Then reprint the Image Diagnostics Print to see whether the problem has been solved.
2. If the problem remains, clean the printheads again, and reprint the Image Diagnostics Print to see whether the problem has been solved.
3. If the problem remains, consider cleaning your printheads manually (see [Clean the printheads on page 151](#)). You could also try reprinting your current print job, in case it now prints satisfactorily.

4. If the problem remains, try cleaning the printhead drop detector. The printer normally notifies you when this is necessary, but it may be worth trying even if the printer has not suggested it. See [Clean the printhead drop detector on page 151](#).
5. If the problem still remains, replace any persistently faulty printheads (see [Handling ink cartridges and printheads on page 101](#)), or contact HP Support (see [Contact HP Support on page 166](#)).

If you still have a problem

If you still experience print-quality problems after applying the advice in this chapter, here are some further things that you can do:

- Try using a higher print-quality option. See [Printing on page 50](#).
- Check the driver you are using to print with. If it is a non-HP driver, consult the driver vendor about the problem. You could also try using the correct HP driver, if feasible. The latest HP drivers can be downloaded from <http://www.hp.com/go/Z2600/drivers> or <http://www.hp.com/go/Z5600/drivers>.
- If you are using a non-HP RIP, its settings may be incorrect. See the documentation that came with the RIP.
- Check that your printer's firmware is up to date. See [Update the firmware on page 113](#).
- Check that you have the right settings in your software application.

18 Troubleshooting ink cartridge and printhead issues

- [Cannot insert an ink cartridge](#)
- [Ink cartridge status messages](#)
- [Cannot insert a printhead](#)
- [The front-panel display recommends reseating or replacing a printhead](#)
- [Clean the printheads](#)
- [Clean the printhead drop detector](#)
- [Align the printheads](#)
- [Printhead status messages](#)

Cannot insert an ink cartridge

1. Check that you have the correct type of cartridge (model number).
2. Check that the colored label on the cartridge is the same color as the label on the slot.
3. Check that the cartridge is correctly oriented, with the letter or letters marking the cartridge label right-side up and readable.

 **CAUTION:** Never clean inside the ink cartridge slots.

Ink cartridge status messages

These are the possible ink cartridge status messages:

- **OK:** The cartridge is working normally, with no known problems.
- **Missing:** There is no cartridge present, or it is not correctly connected to the printer.
- **Low:** The ink level is low.
- **Very low:** The ink level is very low.
- **Empty:** The cartridge is empty.
- **Reseat:** You are recommended to remove the cartridge and then reinsert it.
- **Replace:** You are recommended to replace the cartridge with a new cartridge.
- **Expired:** It is past the cartridge's expiration date.
- **Non-HP:** The cartridge contains ink not made by HP.
- **Wrong:** The cartridge family or model is wrong, or it has been inserted wrongly.
- **Altered:** The cartridge has been altered (refilled).

Cannot insert a printhead

1. Check that you have the correct type of printhead (model number).
2. Check that you have removed the two orange protective caps from the printhead.
3. Check that the colored label on the printhead is the same color as the label on the slot.
4. Check that the printhead is correctly oriented (compare with the others).
5. Check that you have correctly closed and latched the printhead cover, see [Insert a printhead on page 108](#).

The front-panel display recommends reseating or replacing a printhead

1. From the front panel, turn the power off then on.
2. Check the front-panel display message, if it shows the ready message, the printer is ready to print. If the problem remains continue with the next step.
3. Remove the printhead, see [Remove a printhead on page 105](#).

4. Clean the electrical connections on the backside of the printhead with a lint free cloth. You can carefully use a mild rubbing alcohol if moisture is needed to remove residue. Do not use water.

CAUTION: This is a delicate process and may damage the printhead. Do not touch the nozzles on the bottom side of the printhead, especially not with any alcohol.

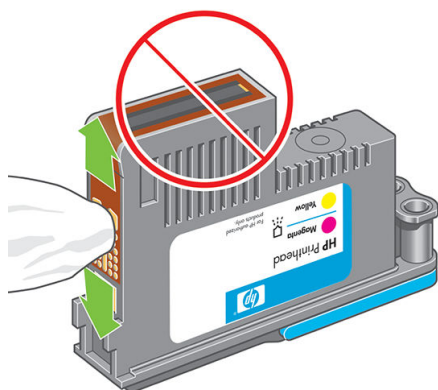

5. Reinsert the printhead, see [Insert a printhead on page 108](#).
6. Check the front-panel display message. If the problem remains, try a new printhead.

Clean the printheads

As long as the printer is kept turned on, automatic cleaning is performed periodically. This ensures there is fresh ink in the nozzles and prevents nozzle clogs, which ensures color accuracy. If you have not already done so, see [The Image Diagnostics Print on page 146](#) before proceeding.

To clean the printheads, go to the front panel and press , then , then **Image-quality maintenance** >

Clean printheads. If you have gone through the Image Quality Diagnostic print process, you know which colors are failing. Select the pair of printheads which contain the failing colors. If you are not sure which colors to clean, you can also select to clean all printheads. Cleaning all printheads takes about nine minutes. Cleaning a single pair of printheads takes about six minutes.

 **NOTE:** Cleaning all printheads uses more ink than cleaning a single pair.

Clean the printhead drop detector

The printhead drop detector is a sensor that detects which nozzles on the printheads are not printing in order to substitute them for good printing nozzles. If particles, such as fibers, hair or paper pieces, block the sensor print-quality is affected.

When the front panel displays a warning message that the clean process is needed, you are recommended to clean the printhead drop detector. If you do not clean the printhead drop detector immediately, the printer continues working normally, however, the front panel display continues to show the warning.

CAUTION: Wear gloves to avoid getting ink on your hands.

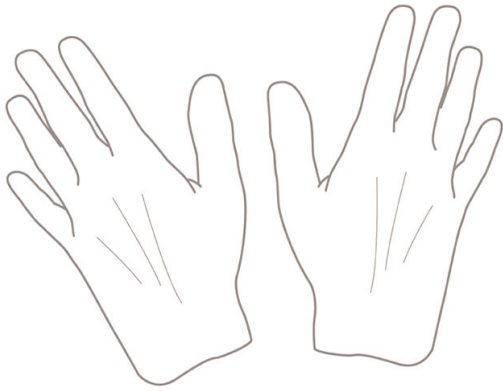

1. Turn off the printer at the front panel.
2. To avoid an electric shock, switch the printer off and unplug it.

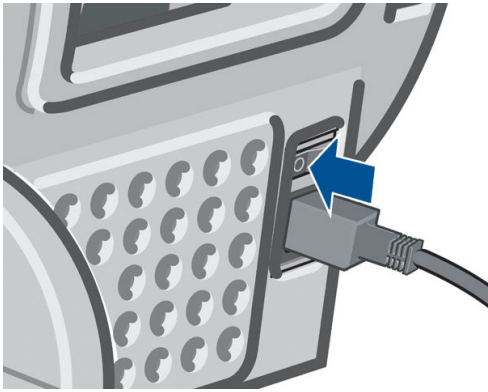

3. Open the window.

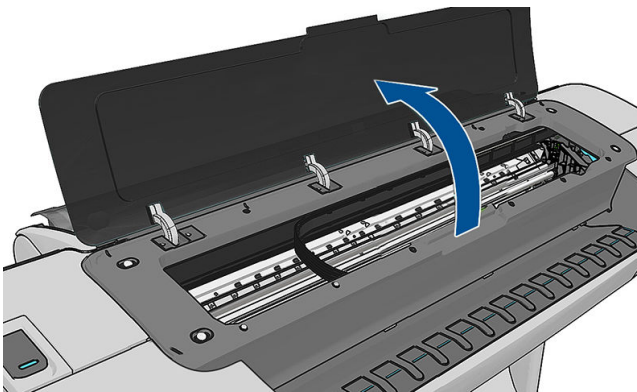

4. Find the printhead drop detector beside the stored printhead carriage.

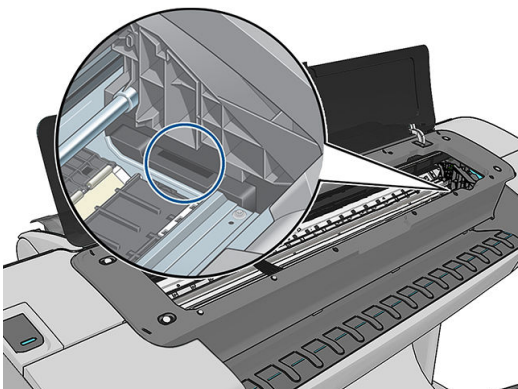

5. Remove any debris blocking the printhead drop detector.
6. With a dry, lint-free cloth, wipe the surface of the drop detector to remove any non-visible debris.

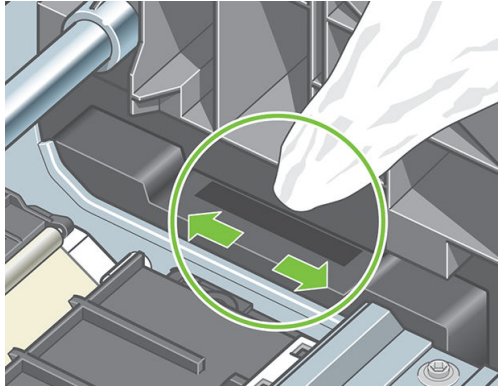

7. Close the window.

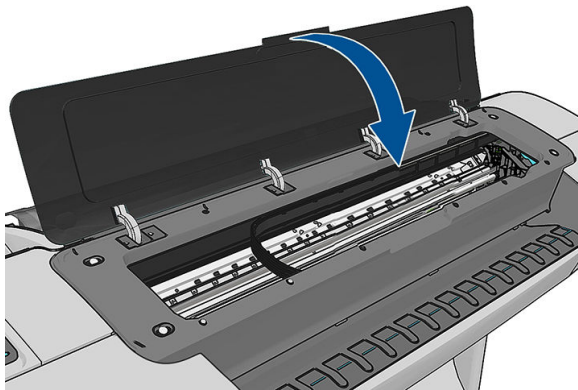

8. Plug in and switch on the printer.

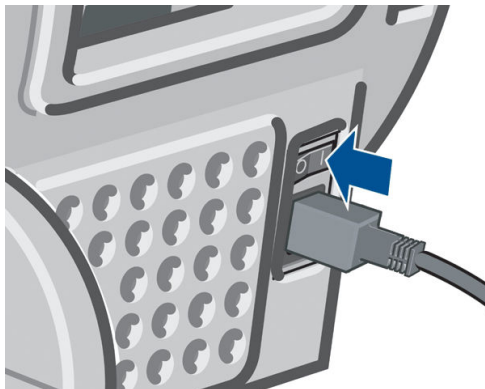



9. Power the printer on at the front panel.

Align the printheads

Precise alignment between printheads is essential for accurate colors, smooth color transitions and sharp edges in graphical elements. Your printer has an automatic printhead alignment process which runs whenever a printhead has been accessed or replaced.



In cases where the paper has jammed or you are experiencing problems with color accuracy, see [Color management on page 73](#); you may need to align the printheads.

 **NOTE:** If the paper has jammed, it is recommended that you reinsert the printheads and initiate the realignment procedure by pressing , then , then **Image-quality maintenance > Align printheads**.

 **CAUTION:** Do not use transparent or semi-transparent paper to align the printheads.

Reinsert printheads procedure

1. If the realignment process is running and the wrong paper is loaded, press  on the front panel.

 **CAUTION:** Do not print if the realignment process has been canceled. You can restart the alignment by pressing , then , then **Image-quality maintenance > Align printheads**.

2. Load the paper you wish to use, see [Paper handling on page 32](#). You can use a roll that is at least 610 mm (24 in) wide or a cut sheet that is A2 landscape or larger.

 **CAUTION:** Do not use transparent or semi-transparent paper to align the printheads.

3. Remove and re-insert all the printheads, see [Remove a printhead on page 105](#) and [Insert a printhead on page 108](#). This starts the printhead alignment procedure.
4. Ensure the window is closed, as a strong light source near the printer during printhead realignment can affect alignment.

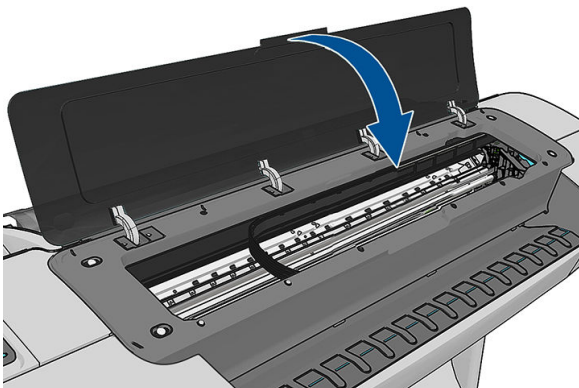

5. The process takes about six minutes. Wait until the front-panel display shows the process complete before using the printer.



 **NOTE:** The printer prints a calibration image. Do not worry about the image. The front-panel display shows any errors in the process.

Image-quality maintenance menu procedure

1. Load the paper you wish to use, see [Paper handling on page 32](#). You can use a roll or cut sheet, however, it must be A3 landscape or larger (420 by 297 mm).

 **CAUTION:** Do not use transparent or semi-transparent paper to align the printheads.

2. From the front panel, press , then , then **Image-quality maintenance > Align printheads**. The printer checks to see if it has enough paper to run the realignment.

3. If the loaded paper is satisfactory, the printer runs the realignment and prints a realignment pattern. Ensure the window is closed, as a strong light source near the printer during printhead realignment can affect alignment.

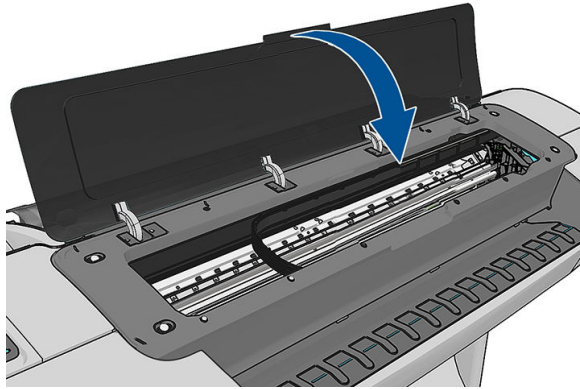

4. The process takes about five minutes. Wait until the front-panel display shows the process complete before using the printer.

Scanning errors during alignment

If the alignment process fails, a Scanning problems message appears on the front panel. This means that the alignment has not completed successfully. Therefore the printer is not aligned and the alignment should be repeated before printing with good image quality. The problem may be due to:

- The paper used was not valid, repeat the alignment with valid paper
- Printhead health problems, clean printheads, see [Clean the printheads on page 151](#)
- The alignment was done with the window open, repeat the alignment with the window closed

If the problem persists after using valid paper, cleaning the printheads and keeping the window closed, there may be a failure in the scanning system needing repair; or the printheads, although clean, may not work and need to be replaced.

Printhead status messages

These are the possible printhead status messages:

- **OK:** the printhead is working normally, with no known problems
- **Missing:** there is no printhead present, or it is not correctly installed in the printer.
- **Test printhead separately:** you are recommended to test the printheads individually to find the failing printhead. Remove all the printheads and insert them alone one by one, closing the latch and the carriage cover after every insertion. The front-panel display indicates the failing one showing the reset or replace message.
- **Reset:** you are recommended to remove the printhead and then reinsert it. If that fails, clean the electrical connections, see [The front-panel display recommends reseating or replacing a printhead on page 150](#). If that fails, replace the printhead with a new printhead, see [Remove a printhead on page 105](#) and [Insert a printhead on page 108](#).
- **Replace:** the printhead is failing. Replace the printhead with a working printhead, see [Remove a printhead on page 105](#) and [Insert a printhead on page 108](#).
- **Replacement incomplete:** a printhead replacement process has not completed successfully, re-launch the replacement process and let it finish completely (it is not needed to change the printheads).
- **Remove:** the printhead is not a suitable type for use in printing.

19 Troubleshooting general printer issues

- [The printer will not start](#)
- [The printer does not print](#)
- [The printer seems slow](#)
- [Communication failures between computer and printer](#)
- [Cannot access the HP DesignJet Utility](#)
- [Cannot access the Embedded Web Server](#)
- [Cannot connect to the Internet](#)
- [Web Services issues](#)
- [Automatic file system check](#)
- [Alerts](#)

The printer will not start

If the printer will not start (the front panel is blank or the diagnostic LEDs are all off), you are recommended to replace the firmware, in the following way.

1. Go to the HP Support Center (see [HP Support Center on page 165](#)) and download the firmware.
2. Save the firmware on a USB flash drive. Ideally, the USB flash drive should be empty and formatted with the FAT filesystem.
3. Ensure that the printer is turned off. Connect the USB flash drive to the Hi-Speed USB host port beside the front panel, then turn the printer on.
4. The printer takes about a minute to read the firmware file, then asks you to remove the USB flash drive.
5. The printer automatically installs the new firmware and restarts.

The printer does not print

If all is in order (paper loaded, all ink components installed and no file errors), there are still reasons why a file you have sent from your computer may not start printing when expected:

- You may have an electrical power problem. If there is no activity at all from the printer, and the front panel does not respond, check that the power cable is connected correctly and that there is power available at the socket.
- You may be experiencing unusual electromagnetic phenomena, such as strong electromagnetic fields or severe electrical disturbances, which can cause the printer to behave strangely or even stop working. In this case, turn off the printer using the **Power** key on the front panel and unplug the power cord, wait until the electromagnetic environment has returned to normal, then turn it on again. If you still experience problems, contact your support representative.
- Nesting may be on, and the printer is waiting for the specified nest wait time before calculating the appropriate nests. In this case, the front panel shows the remaining time needed for nesting.
- You may have the wrong graphic language setting, see [Change the graphic language setting on page 31](#).
- You may not have installed in your computer the correct driver for your printer, see the *Assembly instructions*.
- If you are printing on a sheet, you must specify Manual Feed as the paper source in your printer driver.
- The printer may be holding the job for paper or accounting information, see [Job status messages on page 71](#).
- You may have requested a print preview from your printer driver. This is a function you can use to check that the image is the one you want. In this case, the preview is displayed on your screen, and you must click the **Print** button to start printing.

The printer seems slow

Here are some possible explanations.

- Did you set the print-quality to **Best** or **Max Detail**? Best-quality and maximum detail prints take longer.
- Did you specify the correct paper type when loading the paper? Some paper types require more time for printing; for example, photo and coated papers require more drying time between passes. To find out the printer's current paper type setting, see [View information about the paper on page 42](#).

- If your printer is connected by network, check that all components used in the network (network interface cards, hubs, routers, switches, cables) are capable of high-speed operation. Is there a lot of traffic from other devices on the network?
- Did you specify **Extended** drying time in the front panel? Try changing the drying time to **Optimal**.

Communication failures between computer and printer

Some symptoms are:

- The front-panel display does not show the **Receiving** message when you have sent an image to the printer.
- Your computer displays an error message when you are trying to print.
- Your computer or printer hangs (stays idle), while communication is taking place.
- Your printed output shows random or inexplicable errors (misplaced lines, partial graphics etc.)

To solve a communication problem:

- Ensure that you have selected the correct printer in your application, see [Printing on page 50](#).
- Ensure that the printer works correctly when printing from other applications.
- Remember that very large prints may take some time to receive, process and print.
- If your printer is connected to your computer through any other intermediate devices, such as switch boxes, buffer boxes, cable adapters, cable converters, etc., try using it when connected directly to your computer.
- Try another interface cable.
- Ensure that the graphic language setting is correct, see [Change the graphic language setting on page 31](#).
- If the printer is connected by network, check that your printer has a static IP address. If it is using DHCP, the IP address may change every time it is turned on, in which case the driver may not be able to find it.

Cannot access the HP DesignJet Utility

If you have not done so already, read [Access the HP DesignJet Utility on page 28](#).

From the front panel, press , then , then **Setup > Connectivity > Advanced > Web Services > Printer utility software > Enabled**.

If you still cannot connect, switch the printer off and back on with the **Power** key on the front panel.

Cannot access the Embedded Web Server

If you have not done so already, read [Access the Embedded Web Server on page 28](#).

From the front panel, press , then , then **Setup > Connectivity > Advanced > Embedded Web Server > Allow EWS > On**.

If you are using a proxy server, try bypassing the server and accessing the Web server directly.

- In Internet Explorer 6 for Windows, go to **Tools > Internet Options > Connections > LAN Settings**, and check the **Bypass proxy server for local addresses** box. Alternatively, for more precise control, click the

- Advanced** button and add the printer's IP address to the list of exceptions, for which the proxy server is not used.
- In Safari for Mac OS X, go to **Safari > Preferences > Advanced** and click the **Proxies: Change Settings** button. Add the printer's IP address or its domain name to the list of exceptions, for which the proxy server is not used.





If you still cannot connect, switch the printer off and back on with the **Power** key on the front panel.

Cannot connect to the Internet



If your printer has difficulty in connecting to the Internet, it may start the Connectivity Wizard automatically. You can also start the wizard manually at any time.

- From the Embedded Web Server: select **Support > Connectivity troubleshooting > Connectivity wizard**.

 **NOTE:** You cannot change connectivity settings from the Embedded Web Server.

- From the front panel: Press , then , then **Connectivity > Connectivity wizard**.
- From the front panel: Press , then , then **Internal prints > Service information prints > Print connectivity config**. In this case, the results are printed out.

 **NOTE:** The results printed out are from the last run of the Connectivity wizard, so you must already have run the Connectivity wizard in order to get any results.

The Connectivity Wizard performs a series of tests automatically. You can also choose to perform individual tests. From the front panel, press , then , then **Connectivity > Diagnostics & troubleshooting > Diagnostics & troubleshooting**. The following options are available.

- **All tests**
- **Network connectivity test:** Check the printer's connection to the local area network.
- **Internet connectivity test:** Check the printer's connection to the Internet.
- **HP Connected test:** Check the printer's connection to HP Connected.
- **Firmware update test:** Check the printer's connection to HP's firmware update servers.

If any test fails, the printer describes the problem and recommends how to solve it. You can modify settings and rerun the test, unless you are using the Embedded Web Server or the settings are protected.

Web Services issues

For any issues with HP ePrint, see HP Connected: <http://www.hpconnected.com>.

Automatic file system check

When you turn on the printer, you will occasionally see a front panel display similar to the one shown below.

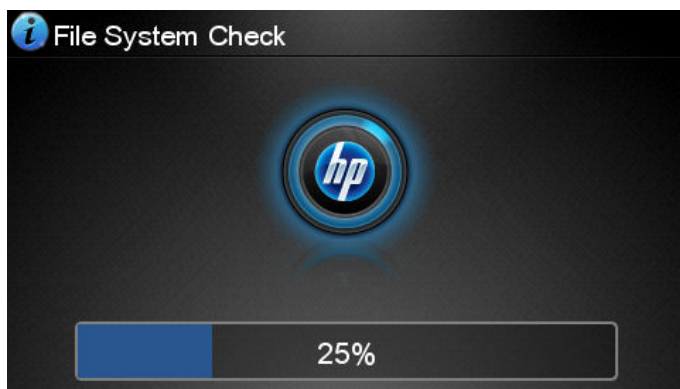

A file system check is taking place; it can take up to 40 minutes. Please wait until it finishes.

CAUTION: If you turn the printer off before the file system check has finished, the file system could be seriously damaged, making the printer's hard disk unusable. In any case, the file system check will restart from the beginning whenever you turn the printer on again.

A file system check is scheduled every 90 days, in order to maintain the hard disk's file system integrity.

NOTE: When the printer is powered back on, it takes about three minutes to initialize and check and prepare the printheads. However, it can take up to 40 under some conditions, for example, when the printer has not been used for a long period of time and requires more time to prepare the printheads.

Alerts

Your printer can communicate two types of alerts:

- **Errors:** Mainly alerting you to the fact that the printer is unable to work normally. However, in the printer driver, errors can also alert you to conditions that could ruin the print, such as clipping, even if the printer is able to print.
- **Warnings:** Alert you when the printer needs attention either for an adjustment, such as a calibration or for a possible unprintable situation, such as a preventive maintenance or low ink.

There are four different alerts communicators within your printer's system.

- **Front-panel display:** The front panel shows only the most relevant alert at a time. In the case of a warning, it disappears after a timeout. There are permanent alerts, such as "ink cartridge low on ink", that reappear when the printer becomes idle and there is not another more severe alert.

TIP: From the front panel display you can configure paper mismatch alerts, see [Paper suitability options on page 22](#).

- **Embedded Web Server:** The upper-right corner of the Embedded Web Server window shows the printer status. If there is an alert in the printer, the status shows the alert text.
- **Driver:** The driver shows alerts. The driver warns about job configuration settings that may produce a problem in the final output. If the printer is not ready to print, it displays a warning.
- **HP DesignJet Utility:** To see alerts, go to the **Overview** tab and review the **Items needing attention** list on the right-hand side.

By default, alerts are displayed only when you are printing. If alerts are enabled and there is a problem that prevents a job from completing, you see a pop-up window, which explains the reason for the problem. Follow the instructions to achieve your required result.

20 Front-panel error messages

Occasionally you may see one of the following messages appear on the front-panel display. If so, follow the advice in the Recommendation column.

If you see an error message that does not appear here, and you feel in doubt about the correct response, or if the recommended action does not seem to solve the problem, contact HP Support. See [Contact HP Support on page 166](#).

Text messages

Message	Recommendation
[Color] cartridge altered	Check the cartridge.
[Color] cartridge has expired	Replace the cartridge. See Handling ink cartridges and printheads on page 101 .
[Color] cartridge is low on ink	Ensure that you have a new cartridge of the same color ready.
[Color] cartridge is missing	Insert a cartridge of the correct color. See Handling ink cartridges and printheads on page 101 .
[Color] cartridge is out of ink	Replace the cartridge. See Handling ink cartridges and printheads on page 101 .
[Color] cartridge is very low on ink	Ensure that you have a new cartridge of the same color ready.
[Color] printhead is missing	Insert the correct printhead. See Handling ink cartridges and printheads on page 101 .
Cutter replacement advised	Contact HP Support to replace the cutter. See Contact HP Support on page 166 .
Job queue notification	Cancel, resume or delete the job. See Job queue management on page 66 .
Maintenance #1 advised	Contact HP Support. See Contact HP Support on page 166 .
Maintenance #2 advised	Contact HP Support. See Contact HP Support on page 166 .
Maintenance #3 advised	Contact HP Support. See Contact HP Support on page 166 .
Paper loaded incorrectly: remove paper	Remove the paper and try to reload it.
Paper mispositioned: remove paper	Remove the paper and try to reload it.
Paper path error: incorrectly loaded	Unload and reload the paper.
Paper path error: misaligned	Unload and reload the paper.
Printhead replacement incomplete. Restart it.	Restart the printhead replacement process.
Printheads need individual testing. Do replacement	Check the printheads using the Image Diagnostics Print (see The Image Diagnostics Print on page 146) and replace any that are not working correctly.

Text messages (continued)

Message	Recommendation
Remove [color] printhead	Remove the incorrect printhead and insert a new printhead of the correct type (color and number). See Handling ink cartridges and printheads on page 101 .
Replace [color] cartridge	Replace the cartridge. See Handling ink cartridges and printheads on page 101 .
Replace [color] printhead	Remove the non-functional printhead and insert a new printhead of the correct type (color and number). See Handling ink cartridges and printheads on page 101 .
Reseat [color] cartridge	Remove and reinsert the same cartridge. See Handling ink cartridges and printheads on page 101 .
Reseat [color] printhead	Remove and reinsert the same printhead, or try cleaning the electrical connections. If necessary, insert a new printhead. See The front-panel display recommends reseating or replacing a printhead on page 150 .

Numerical error codes

Error code	Recommendation
01.0, 01.1, 01.2	Restart the printer.
06:03	Restart the printer.
08:04	Restart the printer. If the problem persists, update the printer's firmware. See Update the firmware on page 113 .
08:08	Retry the operation that you were attempting. If it fails again, restart the printer. If the problem persists, update the printer's firmware. See Update the firmware on page 113 .
21, 21.1, 21:03, 21.1:03, 21:13, 21.2:13, 22.0, 22.1, 22.2, 22.3, 22.x:03, 24	Restart the printer.
26:01, 26.x:01	Bad contact detected in an ink cartridge (if present, x refers to the cartridge in slot x). Remove and reinsert the cartridge. If necessary, insert a new cartridge.
26:14	Update your printer's firmware. See Update the firmware on page 113 .
27:01, 27.x:01	Too many printhead nozzles are not working (if present, x refers to the printhead in slot x). Remove and reinsert the printhead, or try cleaning the electrical connections. If necessary, insert a new printhead. See The front-panel display recommends reseating or replacing a printhead on page 150 .
27:03	Printhead error. Restart the printer.
27:14	Update your printer's firmware. See Update the firmware on page 113 .
31:03, 41:03, 42:03, 45.1:03, 45.2:03, 47:03, 56:03	Restart the printer.
61:01	The file format is wrong and the printer cannot process the job. If the job is password-protected, try sending it without password protection. Otherwise, update your printer's firmware and try again. See Update the firmware on page 113 .
61:04.1, 61:04.2	Update your printer's firmware. See Update the firmware on page 113 .
61:08.1	Resend the job without password protection.
66:08	The job cannot be printed on the paper type that is loaded.
68:03	Restart the printer.
71.04	Out of memory.

Numerical error codes (continued)

Error code	Recommendation
71:03	Restart the printer.
74:04, 74.1:04	The firmware update has failed. Press OK and try again. See Update the firmware on page 113 .
74.1	Try the firmware update again. Do not try to use your computer while the update is in progress.
74.8:04	The firmware update has failed. Your firmware file may be incorrect; try to download it again. See Update the firmware on page 113 .
76:03	Restart the printer.
77:04, 78.1:04	Update your printer's firmware. See Update the firmware on page 113 .
78:08	Borderless printing not possible; setting ignored..
79:03	Restart the printer.
79:04, 79.1:04	Update your printer's firmware. See Update the firmware on page 113 .
81:01	Follow the instructions on the front panel. You may be asked to run a test procedure and write down a numeric code before contacting HP Support. See Contact HP Support on page 166 .
81:03, 84:03	Restart the printer.
86:01	Follow the instructions on the front panel. You may be asked to run a test procedure and write down a numeric code before contacting HP Support. See Contact HP Support on page 166 .
94, 94.1, 94:08	Restart color calibration. See Color calibration on page 74 .
94:02	Color calibration failed. Check that the paper type that is loaded corresponds to the paper type that you have selected.

The system error log

The printer saves a log of system errors that you can access in the following ways.

Using a USB flash drive

1. Create an empty file named **pdipu_enable.log** in a USB flash drive.
2. Insert the USB flash drive into the Hi-Speed USB host port at the front of the printer. The log will be automatically copied into the drive.

Using the Embedded Web Server

1. In your Web browser, go to <http://printer IP address/hp/device/webAccess/log.html>.
2. The Embedded Web Server will send you a file called **log.tar.gz** containing the system error log.

21 HP Customer Care

- [Introduction](#)
- [HP Professional Services](#)
- [HP Proactive Support](#)
- [Customer Self Repair](#)
- [Contact HP Support](#)

Introduction

HP Customer Care offers award-winning support to ensure you get the most from your HP DesignJet, providing comprehensive, proven support expertise and new technologies to give you unique end-to-end support. Services include setup and installation, troubleshooting tools, warranty upgrades, repair and exchange services, phone and Web support, software updates and self-maintenance services. To find out more about HP Customer Care, see [Contact HP Support on page 166](#).

To register your warranty, visit <http://register.hp.com/>.

HP Professional Services

HP Support Center

Enjoy a world of dedicated services and resources to ensure you always get the best performance from your HP DesignJet printers and solutions.

Join the HP community at the HP Support Center, your large-format printing community, for 24×7 access to:

- Multimedia tutorials
- Step-by-step how-to guides
- Downloads: the latest printer firmware, drivers, software, paper presets, etc.
- Technical support: online troubleshooting, customer care contacts and more
- Workflows and detailed advice for completing various printing tasks from particular software applications
- Forums for direct contact with the experts, both HP and your colleagues
- Warranty tracking online, for your peace of mind
- Latest product information: printers, supplies, accessories, software, etc.
- Supplies Center for all you need to know about ink and paper

The HP Support Center can be found at <http://www.hp.com/go/Z2600/support> or <http://www.hp.com/go/Z5600/support>.

By customizing your registration for the products you have purchased and your type of business, and by setting your communication preferences, you decide the information you need.

HP Start-Up Kit

The HP Start-Up Kit is the DVD that comes with your printer; it contains the printer's software and documentation.

HP Care Packs and Warranty Extensions

HP Care Packs and Warranty Extensions allow you to extend your printer's warranty beyond the standard period.

They include remote support. On-site service is also provided if necessary, with two alternative response-time options.

- Next business day
- Same business day, within four hours (may not be available in all countries)

There is an HP Installation service that unpacks, sets up, and connects the printer for you.

For more information on HP Care Packs, see <http://cpc.ext.hp.com/portal/site/cpc>.

HP Proactive Support

HP Proactive Support helps reduce costly printer downtime by preemptively identifying, diagnosing and resolving printer issues before they become problems for you. HP's Proactive Support tool is designed to help businesses of all sizes reduce support costs and maximize productivity—all with the click of a mouse.

A component of the HP Imaging and Printing suite of services, Proactive Support helps you gain control of your printing environment—with a clear focus on maximizing the value of your investment, increasing printer uptime and reducing printer management costs.

HP recommends that you enable Proactive Support right away to save you time and prevent problems before they occur, reducing costly downtime. Proactive Support runs diagnostics and checks for software and firmware updates.

You can enable Proactive Support in the HP DesignJet Utility for Windows or the HP Printer Monitor for Mac OS X, where you can specify the frequency of connections between your computer and HP's Web server, and the frequency of diagnostic checks. You can also choose to run the diagnostic checks at any time. To change these settings:

- In the HP DesignJet Utility for Windows, select the **Tools** menu, then **HP Proactive Support**.
- In the HP Printer Monitor for Mac OS X, select **Preferences > Monitoring > HP Proactive Support**.

If Proactive Support finds any potential problem, it notifies you with an alert, which will explain the problem and recommend a solution. In some cases, the solution may be applied automatically; in other cases, you may be asked to perform some procedure to solve the problem.

Customer Self Repair

HP's Customer Self Repair program offers our customers the fastest service under either warranty or contract. It enables HP to ship replacement parts directly to you (the end user) so that you can replace them. Using this program, you can replace parts at your own convenience.

Convenient, easy to use



- An HP Support Specialist will diagnose and assess whether a replacement part is required to address a defective hardware component.
- Replacement parts are express-shipped; most in-stock parts are shipped the very same day you contact HP.
- Available for most HP products currently under warranty or contract.
- Available in most countries.

For more information about Customer Self Repair, see <http://www.hp.com/go/selfrepair>.

Contact HP Support

HP Support is available to you by telephone. What to do before you call:

- Review the troubleshooting suggestions in this document.
- Review the relevant driver documentation.

- If you have installed third-party software drivers and RIPs, see their documentation.
- If you call your support representative, please have the following information available to help us answer your questions more quickly:
 - The product you are using (the product number and the serial number, found on the label at the back of the product)
 - If there is an error code on the front panel, note it down; see [Front-panel error messages on page 161](#)
 - The product's Service ID: at the front panel, press , then , then .
 - The computer you are using
 - Any special equipment or software you are using (for example, spoolers, networks, switch-boxes, modems or special software drivers)
 - The cable you are using (by part number) and where you purchased it
 - The type of interface used on your product (USB or network)
 - The software name and version you are currently using
 - If possible, print out the following reports; you may be asked to fax them to the support center helping you: Configuration, Usage Report and "all pages above" from Service Information (see [The printer's internal prints on page 12](#))

Telephone number

Your HP Support telephone number is available on the Web: see http://welcome.hp.com/country/us/en/wwcontact_us.html.

22 Printer specifications

- [Functional specifications](#)
- [Physical specifications](#)
- [Memory specifications](#)
- [Power specifications](#)
- [Ecological specifications](#)
- [Environmental specifications](#)
- [Acoustic specifications](#)

Functional specifications

HP ink supplies

Printheads	Two inks in each printhead: matte black and cyan, magenta and yellow, photo black and light gray
Ink cartridges	Cartridges containing 130 ml of ink: matte black, photo black, light gray, cyan, magenta, yellow Cartridges containing 300 ml of ink: matte black, photo black, light gray, cyan, magenta, yellow

Paper sizes

	Minimum	Maximum
Roll width	279 mm (11 in)	1118 mm (44 in) for Z5600 610 mm (24 in) for Z2600
Roll length		91 m (300 feet)
Roll diameter		135 mm (5.3 in)
Roll weight		11.9 kg (26.3 lb)
Sheet width	210 mm (8.26 in)	1118 mm (44 in)
Sheet length	279 mm (11 in)	1676 mm (66 in)
Paper thickness		0.8 mm (31.5 mil)
Paper weight	60 g/m ²	328 g/m ²

Printing resolutions

Print quality	Maximum detail	Extra passes	Rendering resolution (ppi)	Printing resolution 1 (dpi)	Printing resolution 2 (dpi)
Best	On	On	600 × 600	2400 × 1200 *	1200 × 1200
	On/Off	On	600 × 600	1200 × 1200	1200 × 1200
	On/Off	Off	600 × 600	600 × 1200	1200 × 1200
Normal	On		600 × 600	600 × 1200	1200 × 1200
	Off		300 × 300	600 × 1200	1200 × 1200
Fast	On		600 × 600	600 × 1200	1200 × 1200
	Off		300 × 300	600 × 1200	1200 × 1200
Economode	On		600 × 600	600 × 1200	1200 × 1200
	Off		300 × 300	600 × 1200	1200 × 1200

The printing resolution depends on the paper type, as follows.

- **Printing resolution 1** applies to plain, coated, heavyweight coated, super heavyweight coated, satin and glossy paper.

* Satin and glossy paper only.

- **Printing resolution 2** applies to canvas, adhesive vinyl, scrim banner, backlit, proofing matte, proofing gloss and digital fine arts paper.

Margins

Top, right and left margins	5 mm (0.2 in)
Bottom margin (trailing edge)	5 mm (0.2 in) (roll) 17 mm (0.67 in) (sheet)

Mechanical accuracy

±0.1% of the specified vector length or ±0.2 mm (whichever is greater) at 23°C (73°F), 50-60% relative humidity, on E/A0 printing material in Best or Normal mode with HP Matte Film roll feed.

Graphic languages supported

HP DesignJet	Languages
Z2600, Z5600	HP-PCL3GUI, HP-GL/2 and HP RTL, CALS G4, TIFF, JPEG, Adobe PDF 1.7, Adobe PostScript 3

Physical specifications

Printer physical specifications

	HP DesignJet Z2600 24-in PostScript printer without stand	HP DesignJet Z2600 24-in PostScript printer with stand	HP DesignJet Z5600 44-in PostScript printer with stand
Weight	53.5 kg (118 lb)	60 kg (132 lb)	86 kg (189 lb)
Width	1262 mm (49.7 in)	1262 mm (49.7 in)	1770 mm (69.7 in)
Depth	702 mm (27.6 in)	702 mm (27.6 in)	721 mm (28.4 in)
Height	386 mm (15.2 in)	1050 mm (41.3 in)	1050 mm (41.3 in)

The depth is measured without the upper spindle; wall spacers up; ink cover opened; roll covers and basket closed.

Memory specifications

Memory specifications

HP DesignJet	Virtual memory *	Hard disk
Z5600	64 GB	320 GB
Z2600	8 GB	160 GB

Power specifications

Printer power specifications

Input voltage	100–240 V ac \pm 10%, auto-ranging
Frequency	50–60 Hz
Maximum current	2 A
Maximum power	120 W

Ecological specifications

This product complies with the WEEE Directive 2012/19/EU and RoHS Directive 2011/65/EU. To determine the ENERGY STAR and EPEAT registration status of your product model, see <http://www.hp.com/go/ecolabels>.

Environmental specifications

Printer environmental specifications

Operating temperature	5 to 40°C (41 to 104°F)
Recommended operating temperature	15 to 35°C (59 to 95°F), depending on paper type
Storage temperature	–25 to 55°C (–13 to 131°F)
Recommended operating humidity	20 to 80% RH, depending on paper type
Storage humidity	0 to 95% RH

Acoustic specifications

Printer acoustic specifications (declared according to ISO 9296).

Printer acoustic specifications

Idle sound power level	4.1 B (A)
Operating sound power level	6.7 B (A)
Idle sound pressure at bystander position	23 dB (A)
Operating sound pressure at bystander position	45 dB (A)

Glossary

AppleTalk

A suite of protocols that Apple Computer developed in 1984 for computer networking. Apple now recommends TCP/IP and Bonjour networking instead. HP DesignJet products no longer support AppleTalk.

Bonjour

Apple Computer's trade name for its implementation of the IETF Zeroconf specification framework, a computer network technology used in Apple's Mac OS X from version 10.2 onwards. It is used to discover services available on a local area network. It was originally known as Rendezvous.

Color accuracy

The ability to print colors that match the original image as closely as possible, bearing in mind that all devices have a limited color gamut and may not be physically capable of matching certain colors precisely.

Color consistency

The ability to print the same colors from a particular print job from print to print and from printer to printer.

Color model

A system of representing colors by numbers, such as RGB or CMYK.

Color space

A color model in which each color is represented by a specific set of numbers. Many different color spaces can use the same color model: for instance, monitors generally use the RGB color model, but they have different color spaces, because a particular set of RGB numbers results in different colors on different monitors.

Cutter

A printer component that slides back and forth across the platen to cut the paper.

ESD

ElectroStatic Discharge. Static electricity is common in daily life. It is the spark when touching the car door, or the cling of clothing. Although controlled static electricity has some useful applications, uncontrolled electrostatic discharges are one of the main hazards to electronic products. Therefore, to prevent damage some precautions are needed when setting up the printer, or handling ESD sensitive devices. This type of damage may reduce the life expectancy of the device. One way to minimize uncontrolled ESDs, and therefore reduce this type of damage is by touching any exposed grounded part of the printer (mainly metal parts) before handling ESD sensitive devices (such as the printheads or ink cartridges). Additionally, to reduce the generation of electrostatic charge in your body try to avoid working in a carpeted area, and keep your body movements to a minimum when handling ESD sensitive devices. Also, avoid working in low humidity environments.

Ethernet

A popular computer networking technology for local area networks.

Firmware

Software that controls your printer's functionality and is stored semi-permanently in the printer (it can be updated).

Gamut

The range of colors and density values reproducible on an output device, such as a printer or monitor.

Gigabit Ethernet

An Ethernet network capable of transferring data at up to 1,000,000,000 bits/second. Gigabit Ethernet interfaces are capable of negotiating slower speeds when required for compatibility with older Ethernet devices.

HP RTL

HP Raster Transfer Language: a language defined by HP to describe raster (bitmap) graphics.

HP-GL/2

HP Graphics Language 2: a language defined by HP to describe vector graphics.

I/O

Input/Output: this term describes the passing of data between one device and another.

ICC

The International Color Consortium, a group of companies that have agreed on a common standard for color profiles.

Ink cartridge

A removable printer component that stores ink of a particular color and provides it to the printhead.

IP address

May mean an IPv4 address (most likely) or an IPv6 address.

IPSec

A sophisticated mechanism for providing network security by authenticating and encrypting IP packets sent between nodes on a network. Each network node (computer or device) has an IPSec configuration. Applications are usually unaware whether IPSec is being used or not.

IPv4 address

A unique identifier that identifies a particular node on an IPv4 network. An IPv4 address consists of four integers separated by full stops. Most networks in the world use IPv4 addresses.

IPv6 address

A unique identifier that identifies a particular node on an IPv6 network. An IPv6 address consists of up to 8 groups of hexadecimal digits separated by colons. Each group contains up to 4 hexadecimal digits. Only a few new networks in the world use IPv6 addresses.

Jetdirect

HP's brand name for its series of print servers that allow a printer to be connected directly to a local area network.

LED

Light-Emitting Diode: a semiconductor device that emits light when electrically stimulated.

MAC address

Media Access Control address: a unique identifier used to identify a particular device on a network. It is a lower-level identifier than the IP address. Thus, a device may have both a MAC address and an IP address.

Network

A network is a set of connections that pass data between computers and devices. Every device is able to communicate with every other device in the same network. This allows data to be moved between computers and devices, and allows devices such as printers to be shared between many computers.

Nozzle

One of many tiny holes in a printhead through which ink is deposited onto the paper.

Paper

A thin, flat material made to be written or printed on; most commonly made from fibers of some kind which are pulped, dried and pressed.

Platen

The flat surface within the printer over which the paper passes while it is being printed on.

Printer driver

Software that converts a print job in a generalized format into data suitable for a particular printer.

Printhead

A removable printer component that takes ink of one or more colors from the corresponding ink cartridge(s) and deposits it on the paper, through a cluster of nozzles. In your printer, each printhead prints two different colors.

Spindle

A rod that supports a roll of paper while it is being used for printing.

TCP/IP

Transmission Control Protocol/Internet Protocol: the communications protocols on which the Internet is based.

USB

Universal Serial Bus: a standard serial bus designed to connect devices to computers.

USB host port

A rectangular USB socket such as those on found on computers. A printer can control USB devices that are connected to such a port. Your printer has two USB host ports, which it uses to control accessories and USB flash drives.

Index

A

- access control 24
- accessories
 - order 120
- account ID
 - requiring 26
- accounting 98
- accounting data by email 99
- acoustic specifications 171
- Acrobat Pro, print 85
- Acrobat Reader, print 83
- Acrobat, print 83
- alerts
 - errors 160
 - turn on and off 24
 - warnings 160
- AutoCAD, print presentation 92
- AutoCAD, print project 88

B

- banding problems 132
- basket
 - output problems 131
- black and white 77
- black point compensation 80
- blurred lines 145
- brightness in front panel 29
- buzzer on/off 29

C

- calibration
 - color 74
- cannot load paper 123
- clean the platen 139
- clean the printer 112
- clipped at bottom 142
- clipped image 142
- color
 - adjustment options 76
 - advantages 74
 - calibration 74
 - CMYK 74
 - emulation 79

- inaccurate 141
 - profile 74
 - RGB 74
- color management
 - from drivers 76
 - from EWS 79
 - from front panel 81
 - from printer driver 78
 - options 76
 - process 74
- communication ports 8
- components of printer 6
- computer communication
 - printer/computer communications issues 158
- configure 30
- connect the printer
 - choose a method 14
 - general 14
 - Mac OS X network 16
 - Windows network 15
- create paper preset 44
- crop lines 60
- Customer Care 165
- Customer Self Repair 166
- cutter
 - on/off 46

D

- delete paper preset 43
- disk erase, secure 114
- draft printing 58
- driver preferences 26
- drying time
 - change 46

E

- ecological specifications 171
- economize
 - on ink 62
 - on paper 61
- email notifications 24
- email printing 65

Embedded Web Server

- access 28
- cannot access 158
- job preview 69
- job queue 69
- language 29
- usage per job 98
- usage statistics 98

environmental specifications 171

Printer security 31

- erase hard disk securely 114
- error messages
 - front panel 161
 - log 163

F

- features of printer 5
- file system check 159
- firmware update 113
 - manual setup 21
 - setup 20
- front panel 9
 - brightness 29
 - job preview 66
 - job queue 66
 - language 28
 - units 29
- front view 6
- front-panel option
 - adjust paper advance 132
 - align printheads 154
 - allow EWS 158
 - black point compensation 81
 - buzzer 29
 - calibrate color 75
 - calibrate paper advance 132
 - clean printheads 151
 - CMYK source profile 81
 - color/grayscale 81
 - connectivity wizard 20, 159
 - display brightness 29
 - enable crop lines 60
 - enable cutter 47

- enable economode 59
- enable maximum detail 59
- enable merge 58
- form feed and cut 47
- Internet connectivity 20
- modify configuration 30
- move paper 46
- PANTONE emulation 81
- paper mismatch action 22
- print connectivity config. 159
- print diagnostic image 146
- print quality 54
- Printer utility software 158
- printhead information 105
- rendering intent 81
- replace ink cartridges 103
- replace printheads 106
- reset paper advance 133
- resize 57
- RGB source profile 81
- roll protection 63
- roll switching options 22
- select drying time 46
- select graphics language 31
- select I/O timeout 142
- select language 28
- select paper size 55
- select paper type 125
- select wait time 62
- sleep mode wait time 29
- unit selection 29
- unload paper 38
- functional specifications 169

G

- graininess 137
- graphic languages 170
- gray shades 77

H

- hard disk specification 170
- HP Care Packs 165
- HP Connected
 - disable 25
- HP Customer Care 165
- HP DesignJet Click Printing Software
 - setup 18
- HP DesignJet Utility
 - access 28
 - cannot access 158
 - language 29
- HP Proactive Support 166
- HP Start-Up Kit 165
- HP Start-Up Kit DVD 3

- HP Support 166
- HP Support Center 165
- HP-GL/2 31

I

- image diagnostics print 146
- image problems
 - clipped at bottom 142
 - clipped image 142
 - missing objects 143
- import paper preset 43
- ink
 - economical use of 62
 - usage 98
- ink cartridge
 - about 102
 - cannot insert 150
 - insert 104
 - maintenance 112
 - order 117
 - remove 102
 - specification 169
 - status 102
 - status messages 150
- internal prints 12
- Internet connection
 - manual setup 20
 - setup 20
 - troubleshooting 159
- IP address 28
- IPSec 15
- IPv6 15

J

- Jetdirect print server 121
- job preview
 - Embedded Web Server 69
 - front panel 66
- job queue
 - Embedded Web Server 69
 - front panel 66

L

- language 28
- line length accuracy 145
- line thickness 143
- load paper
 - cannot load 123
 - general advice 33
 - paper not in driver 124
 - roll cannot load 123
 - roll into printer 35
 - roll onto spindle 33

- sheet 39
- sheet cannot load 124
- loading paper problems 123

M

- maintenance kits 114
- margins 56
 - none 60
 - specification 170
- mechanical accuracy 170
- memory specifications 170
- Microsoft Office, print 95
- misaligned colors 144
- move the printer 112
- multiroll printer 48

N

- nesting 61
 - turn on and off 22
- Network settings 30

O

- on hold for paper 126
 - enable/disable 126
- order
 - accessories 120
 - ink cartridges 117
 - paper 117
 - printheads 117
- overlapping lines 58
- overnight printing 63

P

- page size 54
- PANTONE emulation 78
- PANTONE swatch book 80
- paper
 - advance 47
 - calibrate the paper advance 132
 - cannot load 123
 - cut after printing 131
 - delete preset 43
 - displaying information 45
 - download presets 43
 - economical use of 61
 - feed and cut 47
 - incorrect out of paper 131
 - jam due to cut strip 130
 - jammed 127
 - loading error messages 124
 - maintenance 46
 - movement 46
 - not cut well 131
 - not flat 137

- output problems in basket 131
- paper not in driver 124
- preset creation 44
- presets 43
- print on loaded paper 57, 125
- printed on wrong paper 125
- retained by printer 131
- roll loose on spindle 131
- select type 57
- sensitive 42
- size 54
- sizes (max and min) 169
- usage 98
- view information 42
- paper mismatch action 22
- paper not in driver 124
- paper suitability 22
- paper types 117
- Photoshop, print presentation 94
- physical specifications 170
- platen cleaning 139
- ports 8
- power
 - on/off 11
- power specifications 171
- preferences, Windows driver 26
- preview a print 58
- print by email 65
- print from
 - Embedded Web Server 52
 - HP DesignJet Utility 52
 - printer driver 53
 - USB flash drive 51
- print job
 - nesting 61
- print preview 58
- print quality
 - select 54
- print-quality problems
 - banding 136
 - black ink comes off 139
 - blurred lines 145
 - bottom of print 140
 - bronzing 140
 - discontinuous lines 144
 - edges darker than expected 140
 - edges stepped or not sharp 139
 - general 135
 - graininess 137
 - horizontal lines 136
 - inaccurate line lengths 145
 - ink marks 138
 - line thickness 143
 - misaligned colors 144

- paper not flat 137
- scratching 138
- scuffing 138
- stepped lines 144
- thin vertical lines 137
- vertical lines of different colors 140
- white spots 140
- wizard 135
- printer does not print 157
- printer software 10
 - HP DesignJet Click 18
 - Mac OS X uninstall 18
 - Windows uninstall 16
- printer status 112
- printer will not start 157
- printer's main components 6
- printer's main features 5
- printhead
 - about 105
 - align 153
 - cannot insert 150
 - clean; purge 151
 - insert 108
 - order 117
 - remove 105
 - replace, reseal 150
 - specification 169
 - status 105
 - status messages 155
- printhead cleaner
 - specification 169
- printhead drop detector
 - clean 151
- printing 50
- printing resolutions 169
- Proactive Support 166
- protect a roll 63

Q
quality, high 59

R
rear view 7
remote printing

- set preferences 21

rendering intent 80
rescale a print 57
roll paper

- load 35
- spindle load 33
- unload 38

roll protection 63
roll switching options 22

S
safety precautions 2
scale a print 57
scratched prints 138
scuffed prints 138
secure disk erase 114
security 24
sensitive-paper mode 42
sheet paper

- load 39
- unload 40

sleep mode wait time 29
slow printing 157
software 10
software update 114
specifications

- acoustic 171
- ecological 171
- environmental 171
- functional 169
- graphic languages 170
- hard disk 170
- ink supplies 169
- margins 170
- mechanical accuracy 170
- memory 170
- paper size 169
- physical 170
- power 171
- printing resolutions 169

spindle 121
roll load 33
statistics

- ink cartridge 102
- usage 98
- usage per job 98

stepped lines 144
store the printer 112
support services

- HP Care Packs 165
- HP Customer Care 165
- HP Proactive Support 166
- HP Start-Up Kit 165
- HP Support 166
- HP Support Center 165
- warranty extensions 165

T
telephone number 167
two rolls 48

U
unattended printing 63

- unload paper
 - roll 38
 - sheet 40
- usage information
 - turn on and off 23
- using this document 3

W

- wall spacers 8
- warranty extensions 165
- Web connection
 - setup 20
- Web Services
 - introduction 11
 - troubleshooting 159