



# Online User's Guide

**MFC-J3540DW**

**MFC-J3940DW**

**MFC-J6540DW**

**MFC-J6555DW**

**MFC-J6740DW**

**MFC-J6940DW**

**MFC-J6955DW**

**MFC-J6957DW**

## Table of Contents

<b>Before You Use Your Machine</b> .....	<b>1</b>
Definitions of Notes .....	2
Trademarks .....	3
Open Source Licensing Remarks .....	4
Copyright and License .....	5
Important Notes.....	6
<b>Introduction to Your Machine</b> .....	<b>7</b>
Before Using Your Machine .....	8
Control Panel Overview .....	9
Touchscreen LCD Overview.....	12
Settings Screen Overview .....	15
Set the Ready Screen .....	17
Set Default Function Screens.....	18
Enter Text on Your Brother Machine .....	19
Access Brother Utilities (Windows) .....	20
Uninstall the Brother Software and Drivers (Windows) .....	21
Access Brother iPrint&Scan (Windows/Mac) .....	22
USB / Ethernet Port Locations on Your Brother Machine .....	23
<b>Paper Handling</b> .....	<b>24</b>
Load Paper.....	25
Loading Paper Overview .....	26
Load Paper in Paper Tray #1 / Paper Tray #2 / Paper Tray #3 .....	29
Load Paper in the Multi-purpose Tray (MP Tray) .....	44
Load Paper in the Manual Feed Slot.....	52
Unprintable Area .....	55
Paper Settings.....	56
Acceptable Print Media .....	62
Load Documents .....	69
Load Documents in the Automatic Document Feeder (ADF) .....	70
Load Documents on the Scanner Glass .....	72
Unscannable Area.....	73
<b>Print</b> .....	<b>74</b>
Print from Your Computer (Windows).....	75
Print a Photo (Windows).....	76
Print a Document (Windows).....	77
Cancel a Print Job (Windows).....	78
Print More Than One Page on a Single Sheet of Paper (N in 1) (Windows).....	79
Print as a Poster (Windows).....	80
Print on Both Sides of the Paper Automatically (Automatic 2-sided Printing) (Windows) .....	81
Print as a Booklet Automatically (Windows).....	84
Secure Print (Windows).....	86
Print a Colour Document in Greyscale (Windows) .....	87
Print a Long Paper (Windows) .....	88
Prevent Smudged Printouts and Paper Jams (Windows) .....	89
Use a Preset Print Profile (Windows) .....	90

Change the Default Print Settings (Windows)	93
Print Settings (Windows)	94
Print from Your Computer (Mac)	98
Print Using Brother iPrint&Scan (Windows/Mac)	99
Print Photos or Documents Using Brother iPrint&Scan (Windows/Mac)	100
Print on Both Sides of the Paper Automatically Using Brother iPrint&Scan (Automatic 2-sided Printing) (Windows/Mac)	102
Print More Than One Page on a Single Sheet of Paper Using Brother iPrint&Scan (N in 1) (Windows/Mac)	104
Print a Colour Document in Greyscale Using Brother iPrint&Scan (Windows/Mac)	105
Print Data Directly from a USB Flash Drive	106
Compatible USB Flash Drives	107
Print Photos Directly from a USB Flash Drive	108
Print a PDF File Directly from a USB Flash Drive	118
Print an Email Attachment	120
<b>Scan</b>	<b>121</b>
Scan Using the Scan Button on Your Machine	122
Scan Multi-page Letter or A4 Size Documents	123
Scan Photos and Graphics	124
Save Scanned Data to a Folder as a PDF File	126
Save Scanned Data to a USB Flash Drive	128
Scan Multiple Business Cards and Photos (Auto Crop)	131
Scan to an Editable Text File Using OCR	132
Save Scanned Data as an Email Attachment	134
Send Scanned Data to an Email Recipient	136
Scan to FTP	138
Scan to SSH FTP (SFTP)	142
Scan to Network (Windows)	149
Scan to SharePoint	153
Web Services for Scanning on Your Network (Windows 7, Windows 8.1, and Windows 10)	157
Change Scan Settings Using Brother iPrint&Scan	161
Scan Using Brother iPrint&Scan (Windows/Mac)	162
Scan from Your Computer (Windows)	163
Scan Using Nuance™ PaperPort™ 14SE or Other Windows Applications	164
Scan Using Windows Fax and Scan	169
Scan from Your Computer (Mac)	173
Configure Scan Settings Using Web Based Management	174
Set the Scan File Name Using Web Based Management	175
Set the Scan Job Email Report Using Web Based Management	176
<b>Copy</b>	<b>177</b>
Copy a Document	178
Enlarge or Reduce Copied Images	180
Sort Copies	182
Make Page Layout Copies (N in 1 or Poster)	183
Copy on Both Sides of the Paper (2-sided Copy)	186
Copy an ID Card	189
Use the A3 Copy Shortcuts	191

Copy Settings.....	193
<b>Fax .....</b>	<b>196</b>
Send a Fax.....	197
Send a Fax from Your Brother Machine .....	198
Send a 2-sided Fax from the ADF .....	200
Send a Fax Manually.....	201
Send a Fax at the End of a Conversation .....	202
Send the Same Fax to More than One Recipient (Broadcasting) .....	203
Send a Fax in Real Time .....	206
Send a Fax at a Specified Time (Delayed Fax).....	207
Change the Fax Auto Redial Setting .....	208
Cancel a Fax in Progress .....	209
Check and Cancel a Pending Fax.....	210
Fax Options .....	211
Receive a Fax .....	212
Receive Mode Settings .....	213
Set Fax Detect.....	218
Fax Preview.....	219
Shrink Page Size of an Oversized Incoming Fax .....	223
Set the Fax Receive Stamp.....	224
Receive a Fax at the End of a Telephone Conversation .....	225
Memory Receive Options .....	226
Remote Fax Retrieval.....	233
Voice Operations and Fax Numbers .....	239
Voice Operations .....	240
Store Fax Numbers .....	243
Set up Broadcasting Groups .....	248
Telephone Services and External Devices.....	252
Distinctive Ring.....	253
Caller ID .....	257
Set the Telephone Line Type.....	259
FaxAbility .....	261
Voice Over Internet Protocol (VoIP/Telephone Line Interference).....	263
External TAD (Telephone Answering Device).....	264
External and Extension Telephones .....	268
Fax Reports .....	274
Set the Transmission Verification Report's Style .....	275
Set the Fax Journal's Interval Period.....	276
PC-FAX .....	277
PC-FAX for Windows .....	278
PC-FAX for Mac .....	297
<b>Network .....</b>	<b>298</b>
Supported Basic Network Features .....	299
Configure Network Settings .....	300
Configure Network Settings Using the Control Panel.....	301
Wireless Network Settings .....	302
Use the Wireless Network .....	303

Use Wi-Fi Direct® .....	316
Enable/Disable Wireless LAN .....	320
Print the WLAN Report.....	321
Network Features.....	325
Print the Network Configuration Report.....	326
Fax Using the Internet (I-Fax) .....	327
Configure and Operate LDAP Search .....	347
Synchronize Time with the SNTP Server Using Web Based Management .....	351
Reset the Network Settings to Factory Default .....	354
<b>Security .....</b>	<b>355</b>
Before Using Network Security Features .....	356
Configure Certificates for Device Security .....	357
Supported Security Certificate Features .....	358
Step by Step Guide for Creating and Installing a Certificate .....	359
Create a Self-signed Certificate .....	360
Create CSR and Install a Certificate from a Certificate Authority (CA) .....	361
Import and Export the Certificate and Private Key .....	365
Import and Export a CA Certificate.....	368
Manage Multiple Certificates .....	371
Use SSL/TLS .....	372
Introduction to SSL/TLS .....	373
Manage Your Network Machine Securely Using SSL/TLS.....	376
Print Documents Securely Using SSL/TLS .....	381
Use SNMPv3.....	383
Manage Your Network Machine Securely Using SNMPv3 .....	384
Use IPsec.....	386
Introduction to IPsec.....	387
Configure IPsec Using Web Based Management .....	388
Configure an IPsec Address Template Using Web Based Management .....	390
Configure an IPsec Template Using Web Based Management .....	392
Use IEEE 802.1x Authentication for a Wired or a Wireless Network .....	400
What Is IEEE 802.1x Authentication? .....	401
Configure IEEE 802.1x Authentication for a Wired or a Wireless Network Using Web Based Management (Web Browser).....	402
IEEE 802.1x Authentication Methods.....	404
Use Active Directory Authentication.....	405
Introduction to Active Directory Authentication.....	406
Configure Active Directory Authentication Using Web Based Management .....	407
Log On to Change the Machine Settings Using the Machine's Control Panel (Active Directory Authentication) .....	409
Use LDAP Authentication.....	410
Introduction to LDAP Authentication .....	411
Configure LDAP Authentication Using Web Based Management.....	412
Log On to Change the Machine Settings Using the Machine's Control Panel (LDAP Authentication) .....	413
Use Secure Function Lock 3.0.....	414
Before Using Secure Function Lock 3.0.....	415
Configure Secure Function Lock 3.0 Using Web Based Management .....	416

Scan Using Secure Function Lock 3.0 .....	417
Configure Public Mode for Secure Function Lock 3.0 .....	418
Additional Secure Function Lock 3.0 Features.....	419
Register a new IC Card Using the Machine's Control Panel .....	420
Register an External IC Card Reader.....	421
Send or Receive an Email Securely.....	422
Configure Email Sending or Receiving Using Web Based Management.....	423
Send an Email with User Authentication .....	424
Send or Receive an Email Securely Using SSL/TLS .....	425
<b>Administrator.....</b>	<b>426</b>
Network Features.....	427
Security Features.....	428
Network Security .....	429
User Authentication .....	431
Brother Management Tools .....	432
<b>Mobile/Web Connect.....</b>	<b>433</b>
Brother Web Connect.....	434
Brother Web Connect Overview .....	435
Online Services Used with Brother Web Connect.....	438
Set Up Brother Web Connect.....	440
Scan and Upload Documents Using Brother Web Connect.....	447
Upload a Document from an External Memory Device Using Brother Web Connect .....	448
Download and Print Documents Using Brother Web Connect.....	449
Download and Save a Document to an External Memory Device Using Brother Web Connect.....	452
FaxForward to Cloud or E-mail .....	453
AirPrint .....	456
AirPrint Overview.....	457
Before Using AirPrint (macOS) .....	458
Print Using AirPrint.....	459
Scan Using AirPrint (macOS).....	462
Send a Fax Using AirPrint (macOS).....	463
Mopria® Print Service.....	464
Brother Mobile Connect .....	465
Print with Near-Field Communication (NFC).....	466
<b>Troubleshooting .....</b>	<b>467</b>
Error and Maintenance Messages .....	468
Transfer Your Faxes or Fax Journal Report .....	476
Error Messages When Using the Brother Web Connect Feature.....	480
Document Jams .....	482
Document is Jammed in the Top of the ADF Unit .....	483
Document is Jammed in the Bottom of the ADF Unit.....	484
Document is Jammed inside the ADF Unit.....	485
Remove Paper Scraps Jammed in the ADF .....	486
Printer Jam or Paper Jam .....	487
Paper is Jammed in the Front of the Machine.....	488
Paper is Jammed in the Back of the Machine .....	493
Remove Paper Scraps .....	498

If You Are Having Difficulty with Your Machine .....	499
Paper Handling and Printing Problems .....	500
Telephone and Fax Problems.....	506
Other Problems .....	513
Network Problems .....	515
AirPrint Problems .....	523
Check the Machine Information .....	524
Reset Your Machine .....	525
Reset Functions Overview .....	526
<b>Routine Maintenance .....</b>	<b>527</b>
Replace the Ink Cartridges.....	528
Clean Your Brother Machine .....	531
Clean the Print Head from Your Brother Machine .....	532
Clean the Print Head Using Web Based Management .....	533
Clean the Print Head from Your Computer (Windows).....	534
Automatically Detect and Improve the Condition of Print Head Nozzles.....	535
Clean the Scanner.....	536
Clean the ADF Document Sensor .....	538
Clean the Machine's LCD.....	539
Clean the Outside of the Machine .....	540
Clean the Machine's Printer Platen .....	542
Clean the Paper Feed Rollers .....	543
Clean the Base Pad .....	545
Clean the Paper Pick-up Rollers for Paper Tray #1 .....	547
Clean the Paper Pick-up Rollers for Paper Tray #2 and Paper Tray #3.....	549
Check Your Brother Machine .....	550
Check the Print Quality.....	551
Check the Print Alignment from Your Brother Machine .....	553
Check the Ink Volume (Page Gauge).....	554
Monitor Machine Status from Your Computer (Windows) .....	556
Monitor Machine Status Using Brother iPrint&Scan (Windows/Mac).....	561
Correct the Paper Feed to Clear Vertical Lines.....	563
Change the Print Options to Improve Your Print Results .....	564
Pack and Ship Your Machine .....	565
<b>Machine Settings.....</b>	<b>568</b>
Change Machine Settings from the Control Panel.....	569
In the Event of Power Failure (Memory Storage) .....	570
General Settings.....	571
Save Your Favourite Settings as a Shortcut.....	588
Print Reports .....	595
Settings and Features Tables.....	598
Change Machine Settings Using Web Based Management .....	621
What is Web Based Management?.....	622
Access Web Based Management .....	623
Set or Change a Login Password for Web Based Management.....	626
Set Up Your Machine's Address Book Using Web Based Management.....	627
<b>Appendix.....</b>	<b>628</b>

---

▲ Home > Table of Contents





Specifications .....	629
Supply Specifications .....	639
Brother Help and Customer Support.....	641

## Before You Use Your Machine

- [Definitions of Notes](#)
- [Trademarks](#)
- [Open Source Licensing Remarks](#)
- [Copyright and License](#)
- [Important Notes](#)

## Definitions of Notes

We use the following symbols and conventions throughout this User's Guide:

 <b>WARNING</b>	WARNING indicates a potentially hazardous situation which, if not avoided, could result in death or serious injuries.
 <b>CAUTION</b>	CAUTION indicates a potentially hazardous situation which, if not avoided, may result in minor or moderate injuries.
<b>IMPORTANT</b>	IMPORTANT indicates a potentially hazardous situation which, if not avoided, may result in damage to property or loss of product functionality.
<b>NOTE</b>	NOTE specifies the operating environment, conditions for installation, or special conditions of use.
	Tips icons indicate helpful hints and supplementary information.
	Electrical Hazard icons alert you to possible electrical shock.
<b>Bold</b>	Bold style identifies buttons on the machine's control panel or computer screen.
<i>Italics</i>	Italicised style emphasises an important point or refers you to a related topic.
Courier New	Courier New font identifies messages shown on the machine's LCD.



### Related Information

- [Before You Use Your Machine](#)

## Trademarks

Apple, App Store, AirPrint, Mac, macOS, iPadOS, iPad, iPhone, iPod touch and Safari are trademarks of Apple Inc., registered in the U.S. and other countries.

Nuance and PaperPort are trademarks or registered trademarks of Nuance Communications, Inc. or its affiliates in the United States and/or other countries.

Wi-Fi<sup>®</sup>, Wi-Fi Alliance<sup>®</sup> and Wi-Fi Direct<sup>®</sup> are registered trademarks of Wi-Fi Alliance<sup>®</sup>.

WPA<sup>™</sup>, WPA2<sup>™</sup>, WPA3<sup>™</sup>, and Wi-Fi Protected Setup<sup>™</sup> are trademarks of Wi-Fi Alliance<sup>®</sup>.

Android, Google Chrome, Google Drive and Google Play are trademarks of Google LLC.

EVERNOTE is a trademark of Evernote Corporation and used under a license.

The Bluetooth<sup>®</sup> word mark is a registered trademark owned by Bluetooth SIG, Inc. and any use of such marks by Brother Industries, Ltd. is under license. Other trademarks and trade names are those of their respective owners.

Mopria<sup>®</sup> and the Mopria<sup>®</sup> Logo are registered and/or unregistered trademarks and service marks of Mopria Alliance, Inc. in the United States and other countries. Unauthorized use is strictly prohibited.

Adobe<sup>®</sup> is a registered trademark of Adobe Systems Incorporated in the United States and/or other countries.

Each company whose software title is mentioned in this manual has a Software Licence Agreement specific to its proprietary programs.

### Software Trademarks

FlashFX<sup>®</sup> is a registered trademark of Datalight, Inc.

FlashFX<sup>®</sup> Pro<sup>™</sup> is a trademark of Datalight, Inc.

FlashFX<sup>®</sup> Tera<sup>™</sup> is a trademark of Datalight, Inc.

Reliance<sup>™</sup> is a trademark of Datalight, Inc.

Reliance Nitro<sup>™</sup> is a trademark of Datalight, Inc.

Datalight<sup>®</sup> is a registered trademark of Datalight, Inc.

**Any trade names and product names of companies appearing on Brother products, related documents and any other materials are all trademarks or registered trademarks of those respective companies.**



### Related Information

- [Before You Use Your Machine](#)

## Open Source Licensing Remarks

This product includes open-source software.

To view Open Source Licensing Remarks and Copyright Information, go to your model's **Manuals** page at [support.brother.com](http://support.brother.com).



### Related Information

- [Before You Use Your Machine](#)
-

## Copyright and License

©2021 Brother Industries, Ltd. All rights reserved.

This product includes software developed by the following vendors:

This product includes the "KASAGO TCP/IP" software developed by ZUKEN ELMIC, Inc.

Copyright 1989-2020 Datalight, Inc., All Rights Reserved.

FlashFX® Copyright 1998-2020 Datalight, Inc.



### Related Information

- [Before You Use Your Machine](#)
-

## Important Notes

- Check [support.brother.com](http://support.brother.com) for Brother driver and software updates.
- To keep your machine performance up to date, check [support.brother.com](http://support.brother.com) for the latest firmware upgrade. Otherwise, some of your machine's functions may not be available.
- Do not use this product outside the country of purchase as it may violate the wireless telecommunication and power regulations of that country.
- When replacing or disposing of your machine, Brother strongly recommends resetting it to its factory settings to remove all personal information.
- Windows 10 in this document represents Windows 10 Home, Windows 10 Pro, Windows 10 Education and Windows 10 Enterprise.
- Windows Server 2008 in this document represents Windows Server 2008 and Windows Server 2008 R2.
- In this User's Guide, the LCD messages of the MFC-J6940DW are used unless otherwise specified.
- In this User's Guide, the illustrations of the MFC-J6940DW are used unless otherwise specified.
- The screens or images in this User's Guide are for illustration purposes only and may differ from those of the actual products.
- Unless otherwise specified, the screens in this manual are from Windows 10. Screens on your computer may vary depending on your operating system.
- The contents of this guide and the specifications of this product are subject to change without notice.
- In this document XXX-XXXX represents your machine's model name.



### Related Information

- [Before You Use Your Machine](#)

#### Related Topics:

- [Reset Your Machine](#)

## Introduction to Your Machine

- [Before Using Your Machine](#)
- [Control Panel Overview](#)
- [Touchscreen LCD Overview](#)
- [Enter Text on Your Brother Machine](#)
- [Access Brother Utilities \(Windows\)](#)
- [Access Brother iPrint&Scan \(Windows/Mac\)](#)
- [USB / Ethernet Port Locations on Your Brother Machine](#)

## Before Using Your Machine

Before attempting any printing operation, confirm the following:

- Make sure you have installed the correct software and drivers for your machine.
- For USB or network cable users: Make sure the interface cable is physically secure.

### Selecting the correct type of paper

For high quality printing, it is important to select the correct type of paper. Be sure to read the information about acceptable paper before buying paper, and to determine the printable area depending on the settings in the printer driver or in the application you use to print.

### Simultaneous printing, scanning and faxing

Your machine can print from your computer while sending or receiving a fax into memory or while scanning a document into the computer. Fax sending will not be stopped during printing from your computer. However, when the machine is copying or receiving a fax on paper, it pauses the printing operation, and then continues printing when copying or fax receiving has finished.

### Firewall (Windows)

If your computer is protected by a firewall and you are unable to network print, network scan, or PC-FAX, you may need to configure the firewall settings. If you are using the Windows Firewall and you installed the drivers using the steps in the installer, the necessary firewall settings have been already set. If you are using any other personal firewall software, see the User's Guide for your software or contact the software manufacturer.



### Related Information

- [Introduction to Your Machine](#)

## Control Panel Overview

>> MFC-J3540DW/MFC-J6540DW/MFC-J6740DW

>> MFC-J3940DW/MFC-J6555DW/MFC-J6940DW/MFC-J6955DW/MFC-J6957DW

### MFC-J3540DW/MFC-J6540DW/MFC-J6740DW

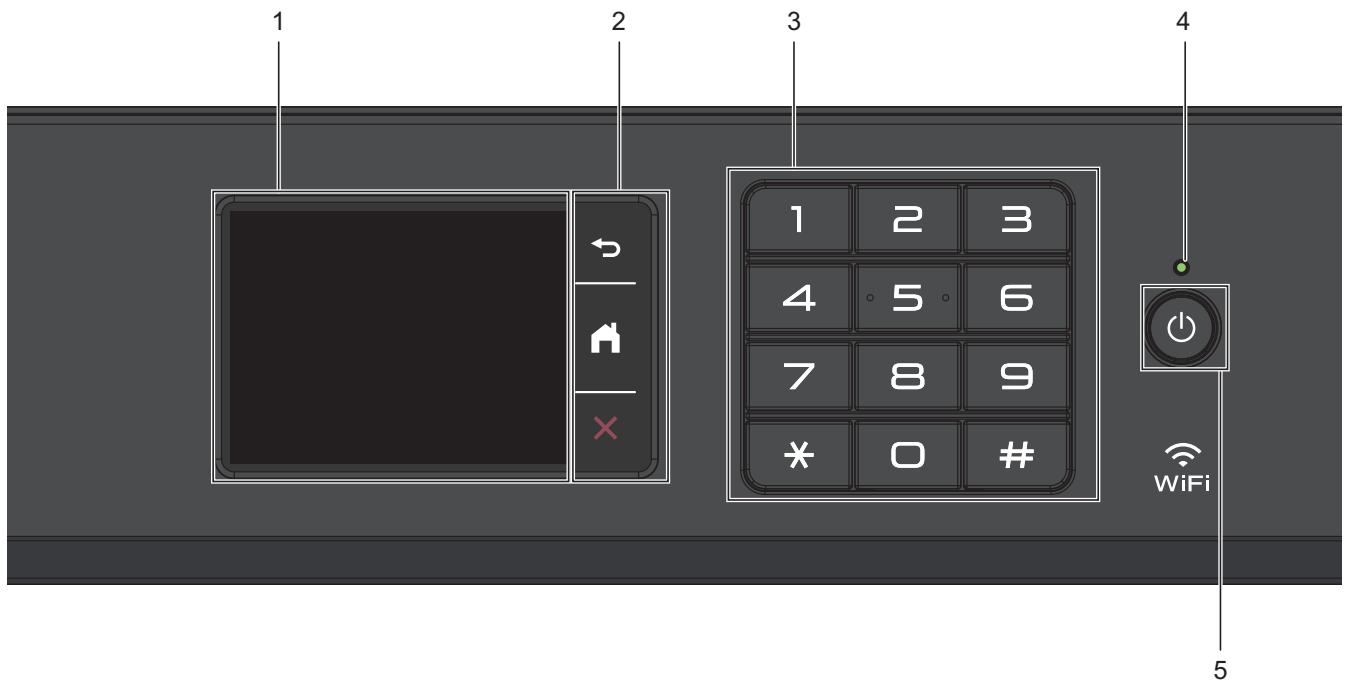

#### 1. Touchscreen Liquid Crystal Display (LCD)

Access menus and options by pressing them on the touchscreen.

#### 2. Menu Buttons



(Back)

Press to go back to the previous menu.



(Home)

Press to return to the Home screen.



(Cancel)

Press to cancel an operation.

#### 3. Dial Pad

Press the numbers to dial telephone or fax numbers and to enter the number of copies.

#### 4. LED Power Indicator

The LED lights up depending on the machine's power status.

When the machine is in Sleep Mode, the LED blinks.

#### 5. Power On/Off

Press  to turn the machine on.

Press and hold  to turn the machine off. The touchscreen displays [Shutting Down] and stays on for a few seconds before turning itself off. A connected external telephone or Telephone Answering Device (TAD) will always remain available.

If you turn the machine off using , it will still clean the print head periodically to maintain print quality. To prolong print head life, provide better ink efficiency, and maintain print quality, keep your machine connected to a power source at all times.

## MFC-J3940DW/MFC-J6555DW/MFC-J6940DW/MFC-J6955DW/MFC-J6957DW

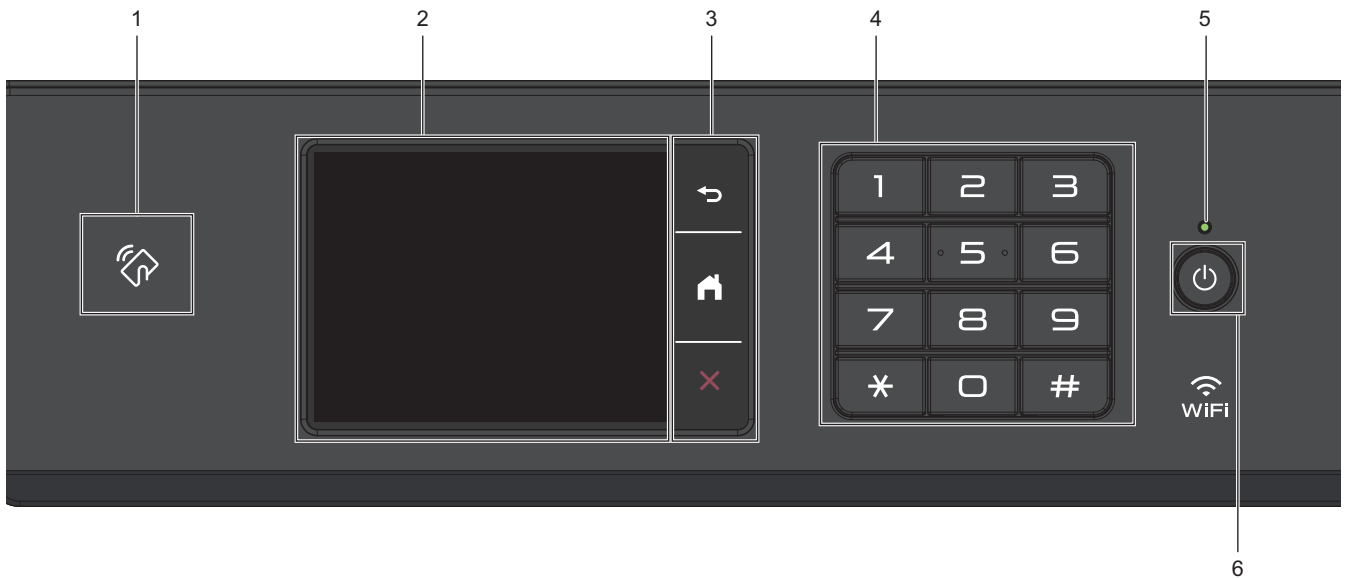

### 1. NFC (Near Field Communication) symbol

(MFC-J6955DW/MFC-J6957DW)

You can use card authentication by touching the IC card to the NFC symbol on the control panel.

(MFC-J3940DW/MFC-J6940DW)

If your Android™ device supports the NFC feature, you can print from your device by touching it to the NFC symbol.

### 2. Touchscreen Liquid Crystal Display (LCD)

Access menus and options by pressing them on the touchscreen.

### 3. Menu Buttons



Press to go back to the previous menu.



Press to return to the Home screen.



Press to cancel an operation.

### 4. Dial Pad

Press the numbers to dial telephone or fax numbers and to enter the number of copies.

### 5. LED Power Indicator

The LED lights up depending on the machine's power status.

When the machine is in Sleep Mode, the LED blinks.

---

## 6. Power On/Off

Press  to turn the machine on.

Press and hold  to turn the machine off. The touchscreen displays [Shutting Down] and stays on for a few seconds before turning itself off. A connected external telephone or Telephone Answering Device (TAD) will always remain available.

If you turn the machine off using , it will still clean the print head periodically to maintain print quality. To prolong print head life, provide better ink efficiency, and maintain print quality, keep your machine connected to a power source at all times.



### Related Information

- [Introduction to Your Machine](#)

#### Related Topics:

- [Print with Near-Field Communication \(NFC\)](#)
-

# Touchscreen LCD Overview

Using your finger, press ◀▶ or ▲▼ on the LCD to display and access the machine options.

 (MFC-J3940DW/MFC-J6555DW/MFC-J6940DW/MFC-J6955DW/MFC-J6957DW) You can also access all machine options by swiping left, right, up, or down on the LCD to scroll through them.

You can switch Home screens by pressing ◀ or ▶.  
 From the Home screens, you can access the various settings.

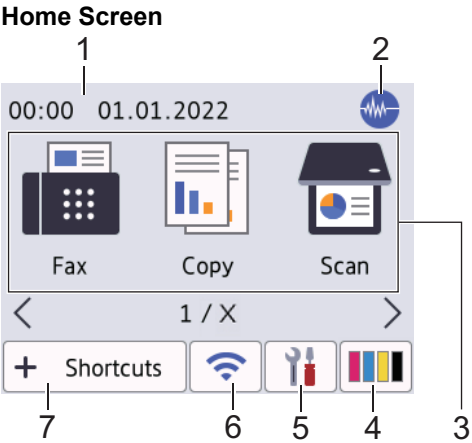

This screen shows the machine's status when the machine is idle. When displayed, it indicates that your machine is ready for the next command.

**1. Date & Time**

Displays the date and time set on the machine.

**2. Quiet Mode**

This icon appears when the [Quiet Mode] setting is set to [On].  
 The Quiet Mode setting can reduce printing noise. When Quiet Mode is turned on, the print speed becomes slower.

**3. Modes:**

Press to switch to each mode.  
 [Fax] / [Copy] / [Scan] / [Secure Print] (MFC-J6955DW/MFC-J6957DW) / [Web] / [Apps] / [USB] / [A3 Copy Shortcuts] / [Download Software] / [Print Head Cleaning]

**4. Ink**

Displays the approximate available ink volume. Press to access the [Ink] menu.  
 When an ink cartridge is near the end of its life or having a problem, an error icon is displayed on the ink colour indicator.



**5. Settings**

Press to access the [Settings] menu.

**6. Wireless Status**

Each icon in the following table shows the wireless network status:

	<ul style="list-style-type: none"> <li>Your machine is not connected to the wireless access point/router. Press this button to configure wireless settings. For more detailed information, see the <i>Quick Setup Guide</i>.</li> <li>The wireless setting is disabled.</li> </ul>
---	--

	The wireless network is connected. A three-level indicator in each of the Home screens displays the current wireless signal strength.
	The wireless access point/router cannot be detected.

 You can configure wireless settings by pressing the Wireless Status button.

## 7. + [Shortcuts]

Create Shortcuts for frequently-used operations, such as sending a fax, copying, scanning, Web Connect and Apps services.

 Three Shortcuts tabs are available with six Shortcuts on each tab.

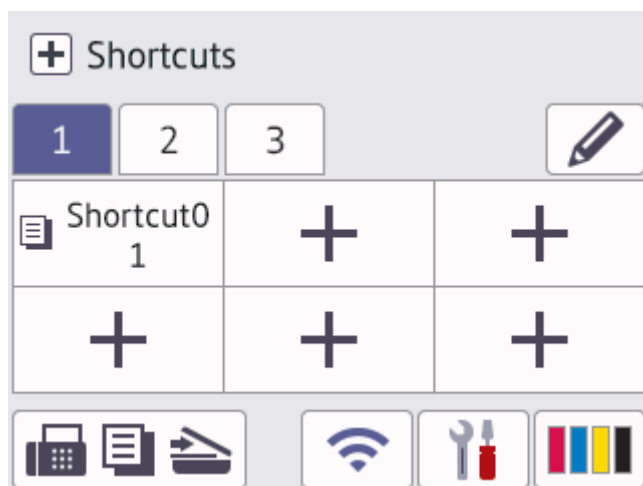

• Press , displayed at the bottom of the screen to access the Home Screens.

## 8. Information icon

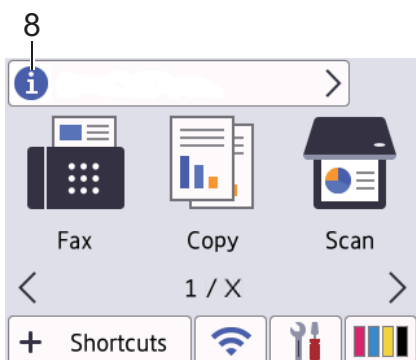





New information from Brother appears in the information bar when the notification settings such as [Message from Brother] and [Firmware Auto Check] are set to [On].

(An internet connection is needed, and data rates may apply.)

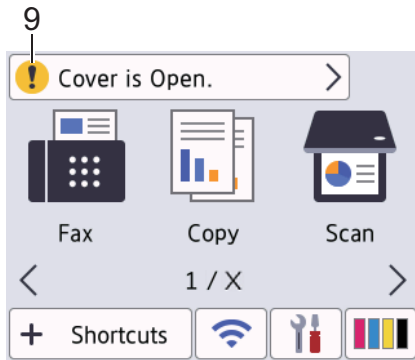
Press  to view the details.

## 9. Warning icon



The warning icon  appears when there is an error or maintenance message; press  to view the details, and then press  to return to the Home screen.

## IMPORTANT

DO NOT press the LCD with a sharp object such as a pen or stylus. It may damage the machine.

## NOTE

DO NOT touch the LCD immediately after plugging in the power cord or turning on the machine. Doing this may cause an error.



This product adopts the font of ARPHIC TECHNOLOGY CO., LTD.



## Related Information

- [Introduction to Your Machine](#)
  - [Settings Screen Overview](#)
  - [Set the Ready Screen](#)
  - [Set Default Function Screens](#)

### Related Topics:

- [Reduce Printing Noise](#)
- [Check the Ink Volume \(Page Gauge\)](#)
- [Use the A3 Copy Shortcuts](#)
- [Error and Maintenance Messages](#)

## Settings Screen Overview

The touchscreen shows the machine's status when you press  [Settings].

Use the Settings menu to access all of your Brother machine's settings.

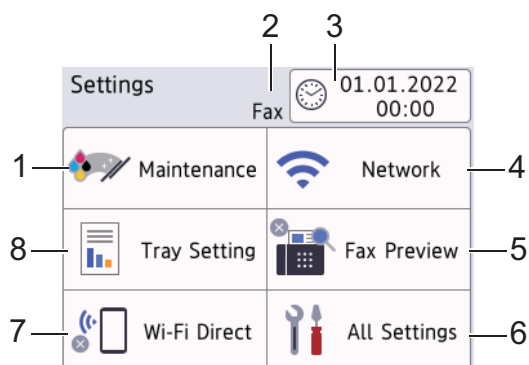

### 1. [Maintenance]

Press to access the following menus:

- [Improve Print Quality]
- [Print Head Cleaning]
- [Remove Paper Scraps]
- [Clean Paper Pick-up Roller] (Available only for some countries.)
- [Ink Volume]
- [Ink Cartridge Model]
- [Print Options]
- [Ink Cartridge Check]
- [Print Quality Auto Check]

### 2. Receive Mode

Displays the current Receive Mode.

### 3. [Date & Time]

Displays the date and time.

Press to access the [Date & Time] menu.

### 4. [Network]

Press to set up a network connection.

If you are using a wireless connection, a three-level indicator  on the screen displays the current wireless signal strength.

### 5. [Fax Preview]

Displays the Fax Preview setting.

Press to access the [Fax Preview] menu.

### 6. [All Settings]

Press to access a menu of all of your machine's settings.

### 7. [Wi-Fi Direct]

Press to set up a Wi-Fi Direct network connection.

### 8. [Tray Setting]

Press to access the [Tray Setting] menu.

Use these options to change the paper size and type.



## Related Information

- [Touchscreen LCD Overview](#)



### **Related Topics:**

- [Check the Ink Volume \(Page Gauge\)](#)
  - [Distinctive Ring](#)
-

## Set the Ready Screen

You can change the Ready screen to display a specific Home screen or Shortcut screen.

When the machine is idle or you press , the machine will go back to the screen that you have set.

1. Press  [Settings] > [All Settings] > [General Setup] > [Screen Settings] > [Home Screen].
2. Press ▲ or ▼ to display the screen options, and then select the option you want.
3. Press .

The machine will go to your new Home screen.





### Related Information

- [Touchscreen LCD Overview](#)

## Set Default Function Screens

You can set the Scan default screen using the Screen Settings.

1. Press  [Settings] > [All Settings] > [General Setup] > [Screen Settings] > [Scan Screen].
2. Press ▲ or ▼ to display the scan options, and then select the option you want to set as the default screen.
3. Press .



### Related Information



- [Touchscreen LCD Overview](#)
-

## Enter Text on Your Brother Machine

- The characters that are available may differ depending on your country.
- The keyboard layout may differ depending on the function you are setting.

When you need to enter text on your Brother machine, a keyboard will appear on the touchscreen.





- Press  to cycle between letters, numbers and special characters.
- Press  to cycle between lowercase and uppercase letters.
- To move the cursor to the left or right, press ◀ or ▶.

### Inserting spaces

- To enter a space, press [Space]. Or, you can press ▶ to move the cursor.

### Making corrections

- If you entered an incorrect character and want to change it, press ◀ or ▶ to highlight the incorrect character. Press , and then enter the correct character.
- To insert a character, press ◀ or ▶ to move the cursor to the correct place, and then enter the character.
- Press  for each character you want to erase, or press and hold  to erase all the characters.

## ✓ Related Information

- [Introduction to Your Machine](#)

### Related Topics:

- [Send the Same Fax to More than One Recipient \(Broadcasting\)](#)
- [Save Outgoing Call Numbers to the Address Book](#)
- [Save Caller ID History Numbers to the Address Book](#)
- [Change a Broadcasting Group Name](#)
- [Set Your Station ID](#)
- [Change or Delete Shortcuts](#)

## Access Brother Utilities (Windows)

**Brother Utilities** is an application launcher that offers convenient access to all Brother applications installed on your computer.

1. Do one of the following:

- Windows 10

Click  > **Brother** > **Brother Utilities**.

- Windows 8.1

Move your mouse to the lower left corner of the **Start** screen and click  (if using a touch-based device, swipe up from the bottom of the **Start** screen to bring up the **Apps** screen).

When the **Apps** screen appears, tap or click  (**Brother Utilities**).

- Windows 7

Click  (**Start**) > **All Programs** > **Brother** > **Brother Utilities**.

2. Select your machine.

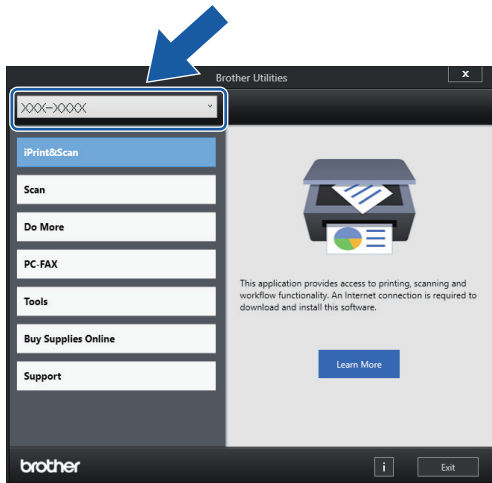

3. Select the operation you want to use.

### Related Information

- [Introduction to Your Machine](#)
  - [Uninstall the Brother Software and Drivers \(Windows\)](#)

## Uninstall the Brother Software and Drivers (Windows)

1. Do one of the following:

- Windows 10

Click  > **Brother** > **Brother Utilities**.

- Windows 8.1

Move your mouse to the lower left corner of the **Start** screen and click  (if using a touch-based device, swipe up from the bottom of the **Start** screen to bring up the **Apps** screen).

When the **Apps** screen appears, tap or click  (**Brother Utilities**).

- Windows 7

Click  (**Start**) > **All Programs** > **Brother** > **Brother Utilities**.

2. Click the drop-down list, and then select your model name (if not already selected). Click **Tools** in the left navigation bar, and then click **Uninstall**.

Follow the instructions in the dialog box to uninstall the software and drivers.

### Related Information

- [Access Brother Utilities \(Windows\)](#)

## Access Brother iPrint&Scan (Windows/Mac)

Use Brother iPrint&Scan for Windows and Mac to print and scan from your computer.

The following screen shows an example of Brother iPrint&Scan for Windows. The actual screen may differ depending on the version of the application.

- For Windows  
Go to your model's **Downloads** page at [support.brother.com](http://support.brother.com) to download the latest application.
- For Mac  
Download and install Brother iPrint&Scan from the App Store.

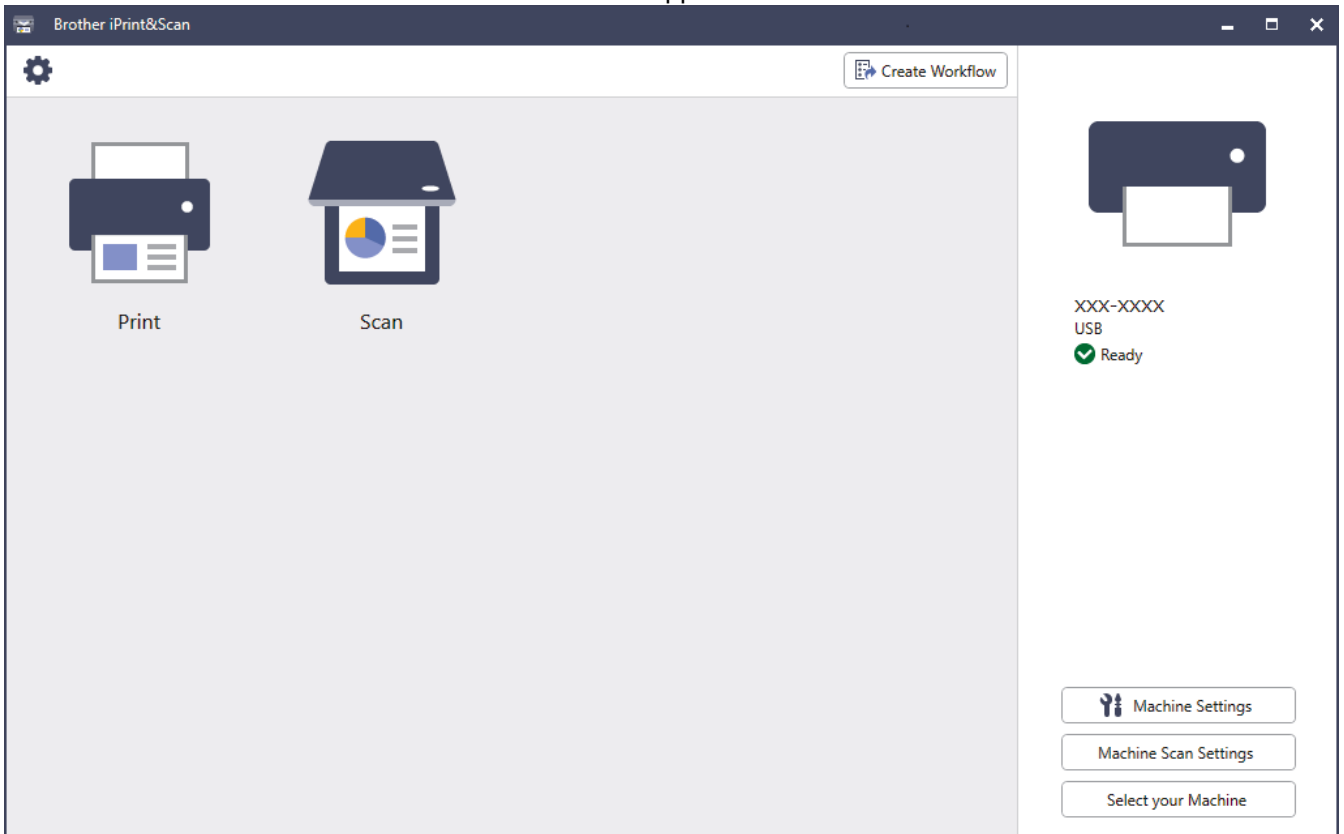

If prompted, install the driver and software necessary to use your machine. Download the installer from your model's **Downloads** page at [support.brother.com](http://support.brother.com).



### Related Information

- [Introduction to Your Machine](#)

## USB / Ethernet Port Locations on Your Brother Machine

The USB and Ethernet ports are located inside the machine.

To install the driver and software necessary to use your machine, go to your model's **Downloads** page at [support.brother.com](http://support.brother.com).

1. Using both hands, use the finger holds on each side of the machine to lift the scanner cover (1) into the open position.

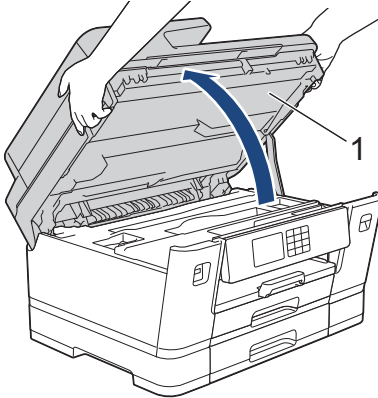

2. Locate the correct port (based on the cable you are using) inside the machine as shown.

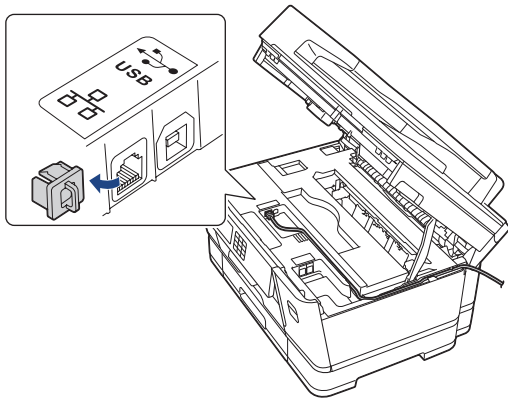

 Carefully guide the cable through the cable channel and out the back of the machine.

3. Gently close the scanner cover using the finger holds on each side.

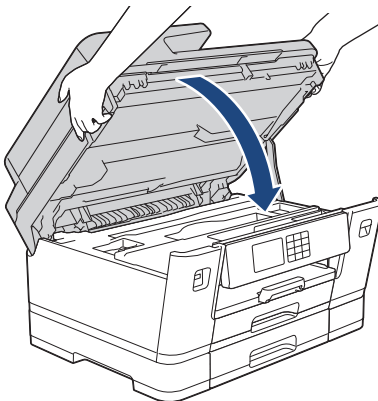

### Related Information

- [Introduction to Your Machine](#)

## Paper Handling

- [Load Paper](#)
- [Load Documents](#)

## Load Paper

- [Loading Paper Overview](#)
- [Load Paper in Paper Tray #1 / Paper Tray #2 / Paper Tray #3](#)
- [Load Paper in the Multi-purpose Tray \(MP Tray\)](#)
- [Load Paper in the Manual Feed Slot](#)
- [Unprintable Area](#)
- [Paper Settings](#)
- [Acceptable Print Media](#)
- [Error and Maintenance Messages](#)
- [Paper Handling and Printing Problems](#)

## Loading Paper Overview

1. Load the paper in the paper tray as follows.

 Fan the stack of paper well.

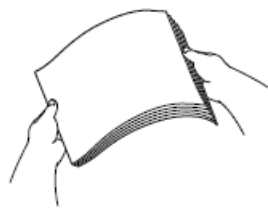

The paper size determines the orientation when loading paper.

### Paper Tray

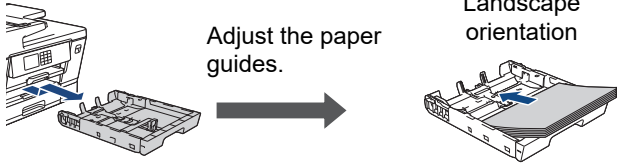
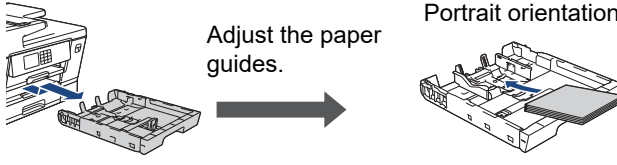
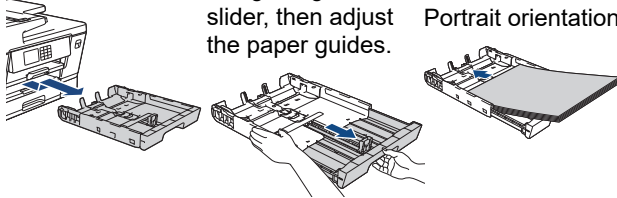
Tray #1	Tray #2 <sup>1</sup> Tray #3 <sup>2</sup>	How to Load Paper
A4 Letter Executive B5 (JIS) ♦	A4 Letter (Plain paper and Recycled paper only)	 <p>Adjust the paper guides.</p> <p style="text-align: right;">Landscape orientation</p>
A5 A6 Photo Photo L Photo 2L B6 (JIS) ♦ Index card Envelopes	-	 <p>Adjust the paper guides.</p> <p style="text-align: right;">Portrait orientation</p>
A3 Ledger B4 (JIS) ♦ Legal Folio Mexico Legal India Legal	A3 Ledger B4 (JIS) ♦ Legal Folio Mexico Legal India Legal (Plain paper and Recycled paper only)	 <p>Extend the tray using the green slider, then adjust the paper guides.</p> <p style="text-align: right;">Portrait orientation</p>

<sup>1</sup> Tray #2 is available only for MFC-J3940DW/MFC-J6740DW/MFC-J6940DW/MFC-J6955DW/MFC-J6957DW.

<sup>2</sup> Tray #3 is available only for MFC-J6957DW.

♦ Supported only in some countries.

## MP Tray

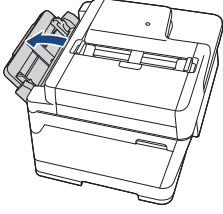
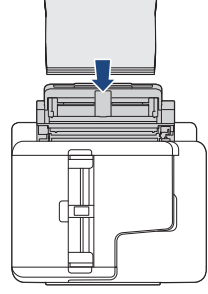
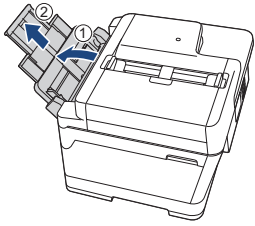
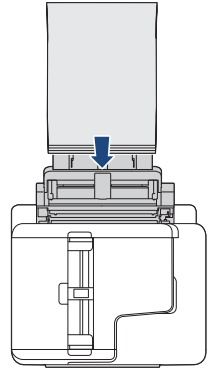
MP Tray <sup>1</sup>	How to Load Paper	
A4 Letter Executive B5 (JIS) ♦		Landscape orientation Adjust the MP tray paper guides. 
A3 Ledger B4 (JIS) ♦ Legal Folio Mexico Legal India Legal A5 A6 Photo Photo L Photo 2L B6 (JIS) ♦ Index card Envelopes Long Paper <sup>2 3</sup>		Portrait orientation Adjust the MP tray paper guides. 

1 MP tray is available only for MFC-J3940DW/MFC-J6555DW/MFC-J6940DW/MFC-J6955DW/MFC-J6957DW.

2 Width: 88.9 - 297 mm / Height: 431.9 - 1200 mm.

3 Load only one sheet of Long paper into the MP tray at a time. To avoid damaging the paper, DO NOT pull up the paper support (2) when loading Long paper.

♦ Supported only in some countries.

## Manual Feed Slot

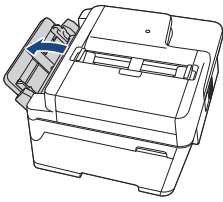
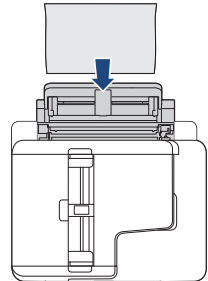
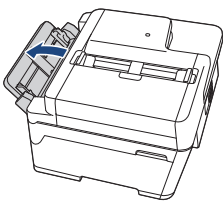
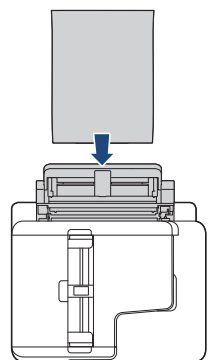
Manual Feed Slot <sup>1 2</sup>	How to Load Paper	
A4 Letter Executive B5 (JIS) ♦		Landscape orientation 
A3 Ledger B4 (JIS) ♦ Legal Folio Mexico Legal India Legal A5 A6 Photo Photo L Photo 2L B6 (JIS) ♦ Index card Envelopes		Portrait orientation 

1 Manual Feed Slot is available only for MFC-J3540DW/MFC-J6540DW/MFC-J6740DW.

2 You can load only one sheet of paper into the manual feed slot at a time.

♦ Supported only in some countries.

2. Unfold the paper support flap.

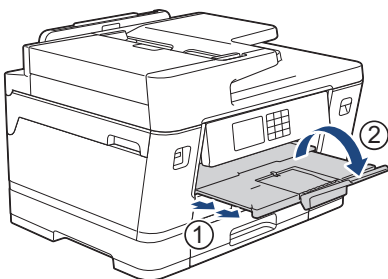

3. Change the paper size setting in the machine's menu, if needed.

### ✓ Related Information

- [Load Paper](#)

## Load Paper in Paper Tray #1 / Paper Tray #2 / Paper Tray #3

- Load A4, Letter, or Executive Size Paper in Paper Tray #1 / Paper Tray #2 / Paper Tray #3
- Load A3, Ledger, or Legal Size Paper in Paper Tray #1 / Paper Tray #2 / Paper Tray #3
- Load Photo Paper in Paper Tray #1
- Load Envelopes in Paper Tray #1

## Load A4, Letter, or Executive Size Paper in Paper Tray #1 / Paper Tray #2 / Paper Tray #3

- If the [Check Paper] setting is set to [On] and you pull the paper tray out of the machine, a message appears on the LCD, allowing you to change the paper size and paper type.
- When you load a different paper size in the tray, you must change the Paper Size setting in the machine or the paper size setting on your computer.  
Doing this enables the machine to automatically feed paper from the appropriate tray if Auto Tray Select has been set in the printer driver (Windows) or on the machine. (MFC-J3940DW/MFC-J6555DW/MFC-J6740DW/MFC-J6940DW/MFC-J6955DW/MFC-J6957DW)
- You can use only plain paper in Tray #2. (MFC-J3940DW/MFC-J6740DW/MFC-J6940DW/MFC-J6955DW)
- You can use only plain paper in Tray #2 and Tray #3. (MFC-J6957DW)

These instructions describe how to load paper in Tray #1.

- (MFC-J3940DW/MFC-J6740DW/MFC-J6940DW/MFC-J6955DW) The steps for Tray #2 are very similar.
  - (MFC-J6957DW) The steps for Tray #2 and Tray #3 are very similar.
1. If the paper support flap (1) is open, close it, and then close the paper support (2).

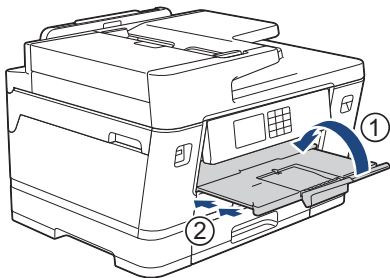

2. Pull the paper tray completely out of the machine as shown by the arrow.

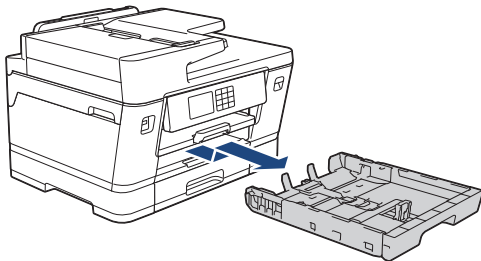

(MFC-J3940DW/MFC-J6740DW/MFC-J6940DW/MFC-J6955DW/MFC-J6957DW)

When you load paper in Tray #2 or Tray #3 (MFC-J6957DW), remove the tray top cover (1).

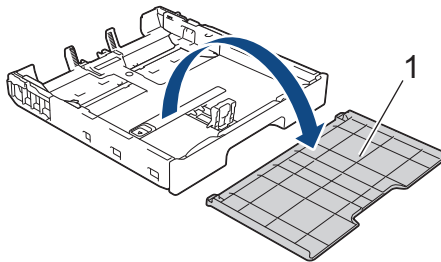

3. Gently press and slide the paper width guides (1) and then the paper length guide (2) to fit the paper size. Make sure the triangular mark (3) on the paper width guide (1) and paper length guide (2) line up with the marks for the paper you are using.

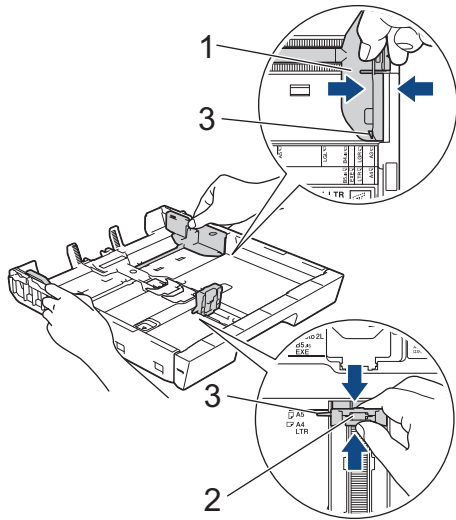

---

 If you load Executive or B5 (JIS) size paper in Tray #1, lift the stopper (4).

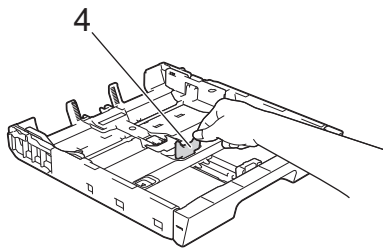

---

4. Fan the stack of paper well to avoid paper jams and misfeeds.

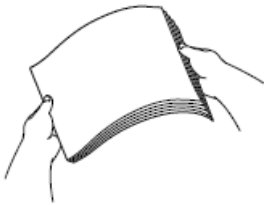

---

 Always make sure the paper is not curled or wrinkled.

---

- 
5. Gently load paper in the paper tray with the printing surface **face down**.

**Landscape orientation**

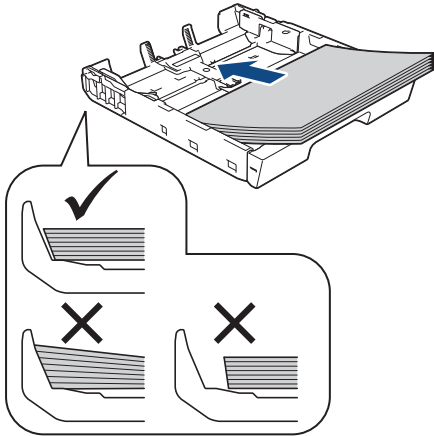

## IMPORTANT

Be careful not to push the paper in too far; it may lift at the back of the tray and cause paper feed problems.



To add paper before the tray is empty, remove the paper from the tray and combine it with the paper you are adding. Always fan the stack of paper well to prevent the machine from feeding multiple pages.

6. Make sure the paper length guide (1) touches the edges of the paper.

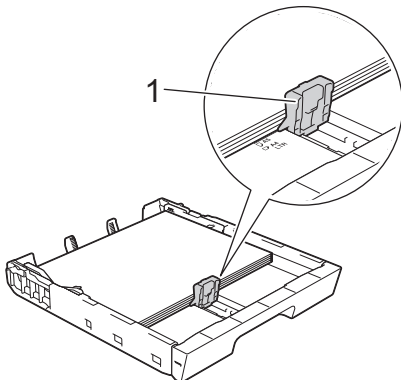

7. Gently adjust the paper width guides (1) to fit the paper.  
Make sure the paper guides touch the edges of the paper.

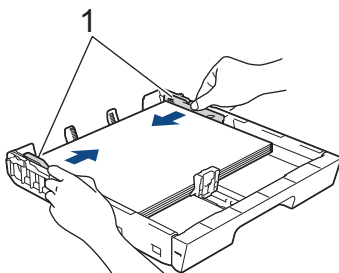

8. Make sure the paper is flat in the tray and below the maximum paper mark (1).  
Overfilling the paper tray may cause paper jams.

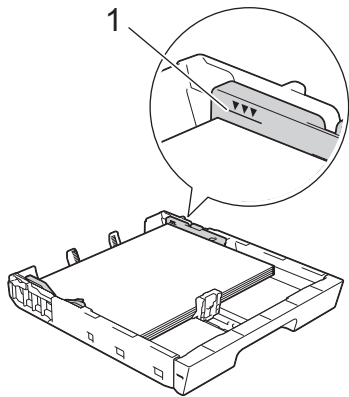

(MFC-J3940DW/MFC-J6740DW/MFC-J6940DW/MFC-J6955DW/MFC-J6957DW)  
When you load paper in Tray #2 or Tray #3 (MFC-J6957DW), replace the tray top cover.

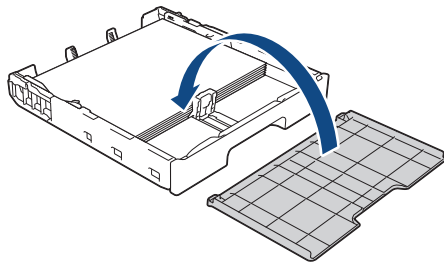

9. Slowly push the paper tray completely into the machine.

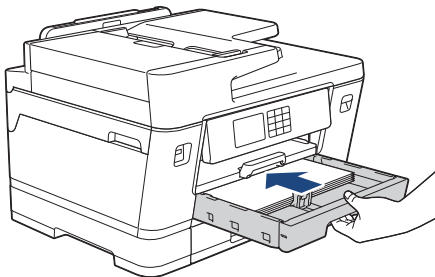

## IMPORTANT

DO NOT push the paper tray into the machine forcefully or quickly. Doing this may cause paper jams or paper feed problems.

10. Pull out the paper support until it locks into place.

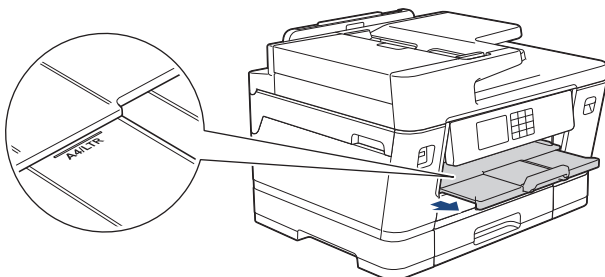

11. Change the paper size setting in the machine's menu, if needed.

## ✓ Related Information

- [Load Paper in Paper Tray #1 / Paper Tray #2 / Paper Tray #3](#)

### Related Topics:

- [Change the Check Paper Setting](#)
- [Change the Paper Size and Paper Type](#)

- 
- Choose the Right Print Media
-

## Load A3, Ledger, or Legal Size Paper in Paper Tray #1 / Paper Tray #2 / Paper Tray #3

- If the [Check Paper] setting is set to [On] and you pull the paper tray out of the machine, a message appears on the LCD, allowing you to change the paper size and paper type.
- When you load a different paper size in the tray, you must change the Paper Size setting in the machine or the paper size setting on your computer.  
Doing this enables the machine to automatically feed paper from the appropriate tray if Auto Tray Select has been set in the printer driver (Windows) or on the machine. (MFC-J3940DW/MFC-J6555DW/MFC-J6740DW/MFC-J6940DW/MFC-J6955DW/MFC-J6957DW)
- You can use only plain paper in Tray #2. (MFC-J3940DW/MFC-J6740DW/MFC-J6940DW/MFC-J6955DW)
- You can use only plain paper in Tray #2 and Tray #3. (MFC-J6957DW)

These instructions describe how to load paper in Tray #1.

- (MFC-J3940DW/MFC-J6740DW/MFC-J6940DW/MFC-J6955DW) The steps for Tray #2 are very similar.
  - (MFC-J6957DW) The steps for Tray #2 and Tray #3 are very similar.
1. If the paper support flap (1) is open, close it, and then close the paper support (2).

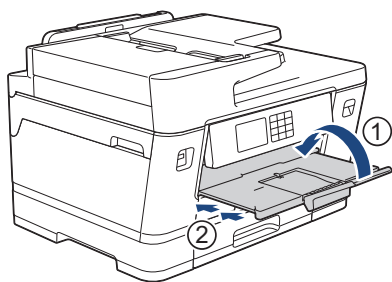

2. Pull the paper tray completely out of the machine as shown by the arrow.

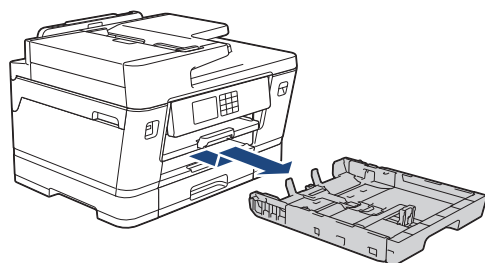

(MFC-J3940DW/MFC-J6740DW/MFC-J6940DW/MFC-J6955DW/MFC-J6957DW)

When you load paper in Tray #2 or Tray #3 (MFC-J6957DW), remove the tray top cover (1).

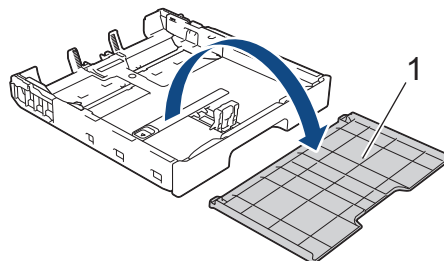

3. Rest the tray on a flat surface.

Push the green slider to the left and then extend the tray until it locks into place.

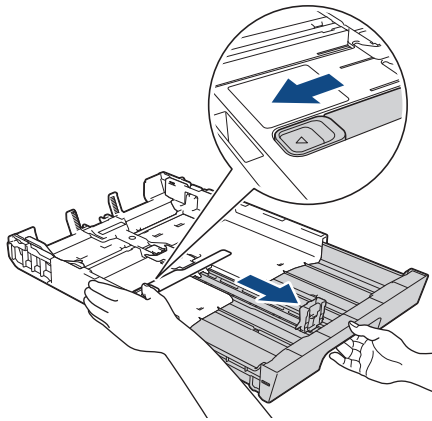

4. Gently press and slide the paper width guides (1) and then the paper length guide (2) to fit the paper size. Make sure the triangular mark (3) on the paper width guide (1) and paper length guide (2) line up with the marks for the paper you are using.

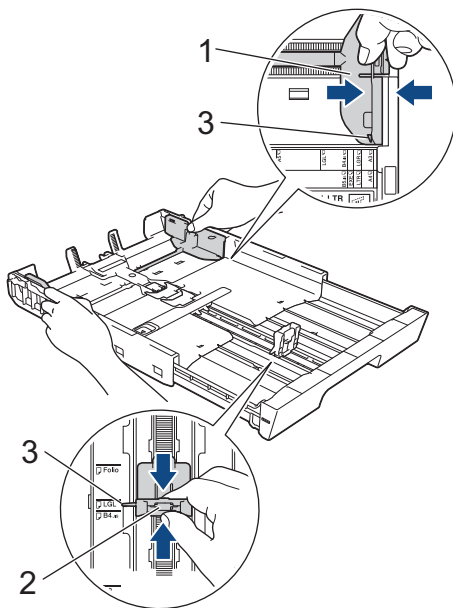

5. Fan the stack of paper well to avoid paper jams and misfeeds.

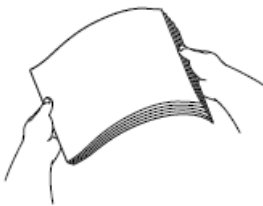

Always make sure the paper is not curled or wrinkled.

- 
6. Gently load paper in the paper tray with the printing surface **face down**.

**Portrait orientation**

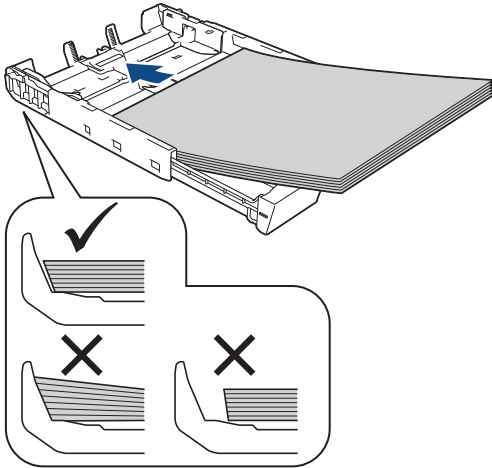

**IMPORTANT**

Be careful not to push the paper in too far; it may lift at the back of the tray and cause paper feed problems.



To add paper before the tray is empty, remove the paper from the tray and combine it with the paper you are adding. Always fan the stack of paper well to prevent the machine from feeding multiple pages.

7. Make sure the paper length guide (1) touches the edges of the paper.

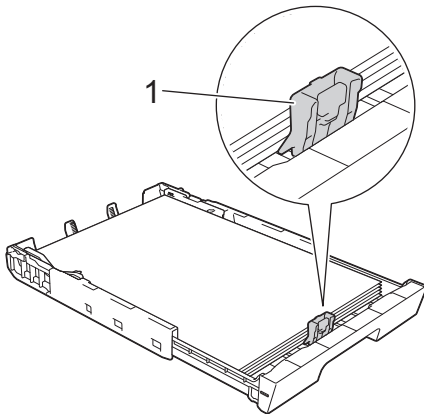

8. Gently adjust the paper width guides (1) to fit the paper.  
Make sure the paper guides touch the edges of the paper.

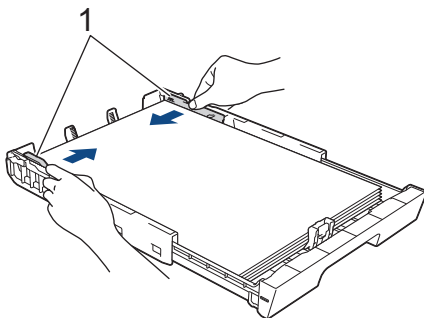

9. Make sure the paper is flat in the tray and below the maximum paper mark (1).  
Overfilling the paper tray may cause paper jams.

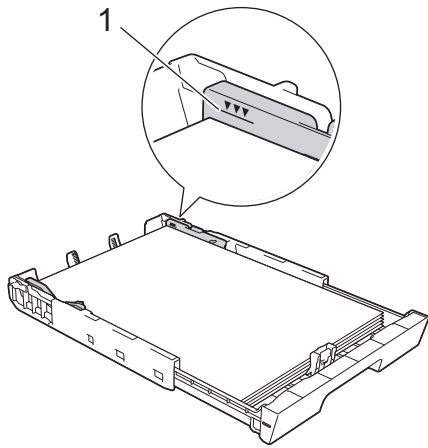

(MFC-J3940DW/MFC-J6740DW/MFC-J6940DW/MFC-J6955DW/MFC-J6957DW)

When you load paper in Tray #2 or Tray #3 (MFC-J6957DW), replace the tray top cover.

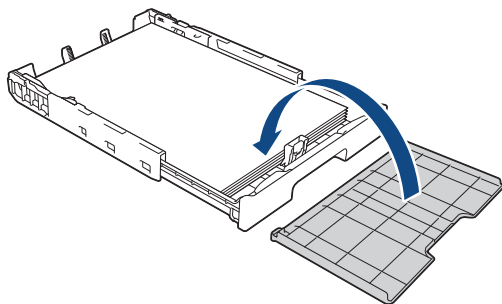

10. Slowly push the paper tray completely into the machine.

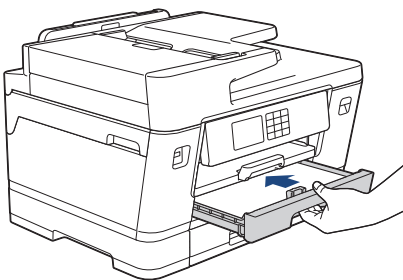

## IMPORTANT

DO NOT push the paper tray into the machine forcefully or quickly. Doing this may cause paper jams or paper feed problems.

11. Pull out the paper support (1) until it locks into place, and then unfold the paper support flap (2).

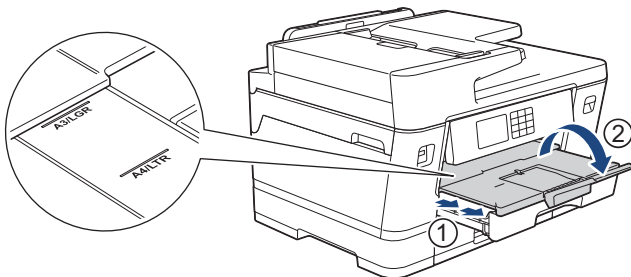

12. Change the paper size setting in the machine's menu, if needed.

## CAUTION

Position the machine so the tray will not protrude past the edge of the table or desk where someone may bump into it. The machine could fall and cause injury.

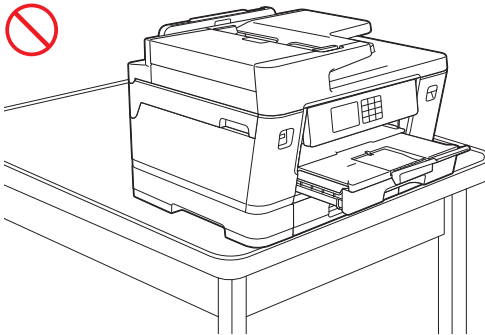
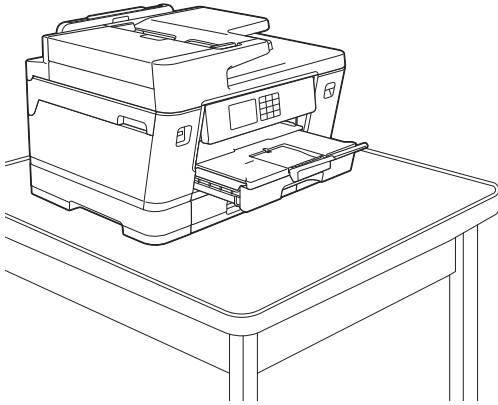

Before you collapse the paper tray, take the paper out of the tray.

Rest the tray on a flat surface.

Push the green slider to the left and then push in the front of the tray to collapse it until it locks into place. Put the paper in the tray.

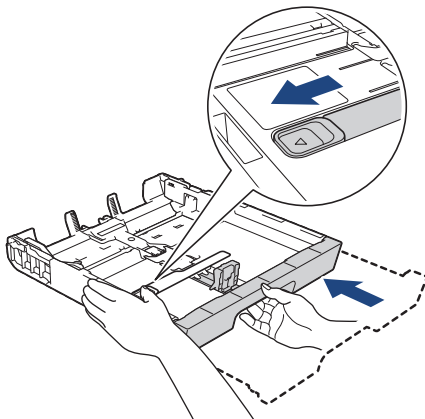

### Related Information

- [Load Paper in Paper Tray #1 / Paper Tray #2 / Paper Tray #3](#)

## Load Photo Paper in Paper Tray #1

- If the [Check Paper] setting is set to [On] and you pull the paper tray out of the machine, a message appears on the LCD, allowing you to change the paper size and paper type.
- When you load a different paper size in the tray, you must change the Paper Size setting in the machine or the paper size setting on your computer.

Doing this enables the machine to automatically feed paper from the appropriate tray if Auto Tray Select has been set in the printer driver (Windows) or on the machine. (MFC-J3940DW/MFC-J6555DW/MFC-J6740DW/MFC-J6940DW/MFC-J6955DW/MFC-J6957DW)

1. If the paper support flap (1) is open, close it, and then close the paper support (2).

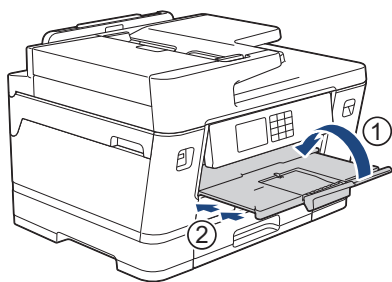

2. Pull the paper tray completely out of the machine as shown by the arrow.

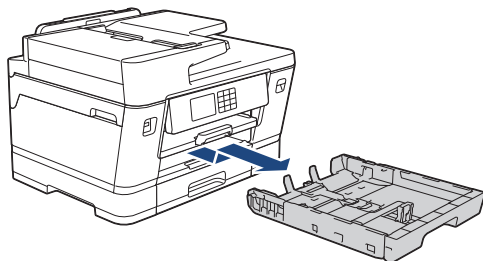

3. Do one of the following:

- If you load Photo L (9 x 13 cm) in the paper tray, lift the Photo L stopper (1).
- If you load Photo (10 x 15 cm) in the paper tray, lift the Photo stopper (2).
- If you load Photo 2L (13 x 18 cm) in the paper tray, lift the Photo 2L stopper (3).

Gently press and slide the paper width guides (4) to fit the paper size.

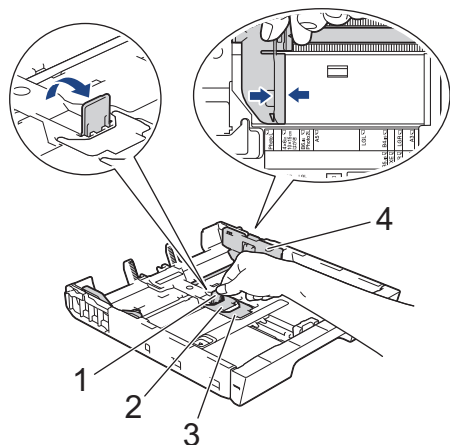

4. Load up to 20 sheets of photo paper in the paper tray with the printing surface **face down**. Loading more than 20 sheets of photo paper may cause paper jams.

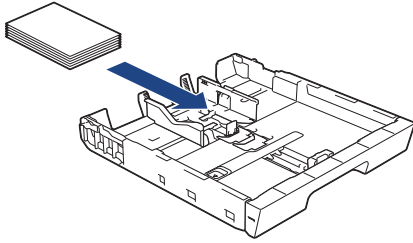

5. Gently adjust the paper width guides (1) to fit the paper.  
Make sure the paper guides touch the edges of the paper and the paper is flat in the tray.

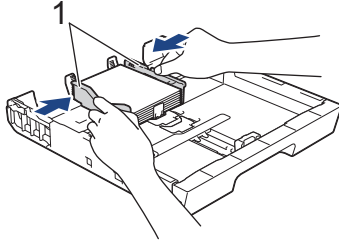

6. Slowly push the paper tray completely into the machine.

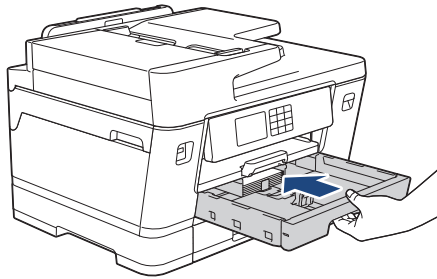

## IMPORTANT

DO NOT push the paper tray into the machine forcefully or quickly. Doing this may cause paper jams or paper feed problems.

7. Pull out the paper support until it locks into place.

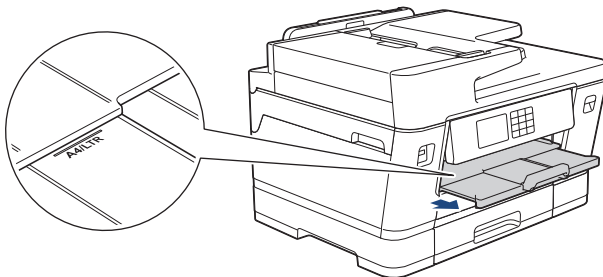

8. Change the paper size setting in the machine's menu, if needed.

## ✓ Related Information

- [Load Paper in Paper Tray #1 / Paper Tray #2 / Paper Tray #3](#)

### Related Topics:

- [Change the Check Paper Setting](#)
- [Change the Paper Size and Paper Type](#)
- [Choose the Right Print Media](#)

## Load Envelopes in Paper Tray #1

- If the [Check Paper] setting is set to [On] and you pull the paper tray out of the machine, a message appears on the LCD, allowing you to change the paper size and paper type.
- You can load envelopes in a variety of sizes. See *Related Information: Paper Type and Paper Size for Each Operation*.
- When you load a different paper size in the tray, you must change the Paper Size setting in the machine or the paper size setting on your computer.

Doing this enables the machine to automatically feed paper from the appropriate tray if Auto Tray Select has been set in the printer driver (Windows) or on the machine. (MFC-J3940DW/MFC-J6555DW/MFC-J6740DW/MFC-J6940DW/MFC-J6955DW/MFC-J6957DW)

- Before loading envelopes in the tray, press the corners and sides of the envelopes to make them as flat as possible.

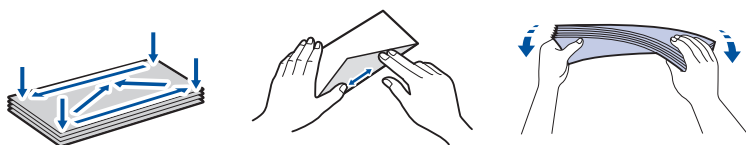

1. If the paper support flap (1) is open, close it, and then close the paper support (2).

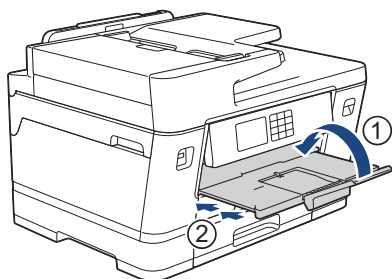

2. Pull the paper tray completely out of the machine as shown by the arrow.

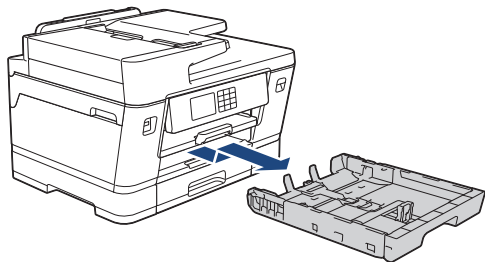

3. Load up to 10 envelopes in the paper tray with the printing surface **face down**. Loading more than 10 envelopes may cause paper jams.

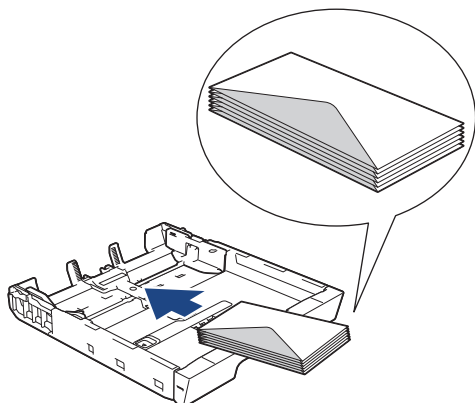

4. Gently press and slide the paper width guides (1) and paper length guide (2) to fit the size of the envelopes. Make sure the envelopes are flat in the tray.

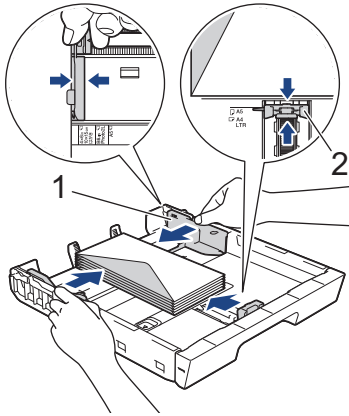

## IMPORTANT

If envelopes are multi-feeding, load one envelope in the paper tray at a time.

5. Slowly push the paper tray completely into the machine.

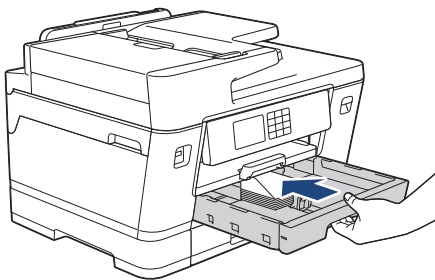

## IMPORTANT

DO NOT push the paper tray into the machine forcefully or quickly. Doing this may cause paper jams or paper feed problems.

6. Pull out the paper support (1) until it locks into place, and then unfold the paper support flap (2).

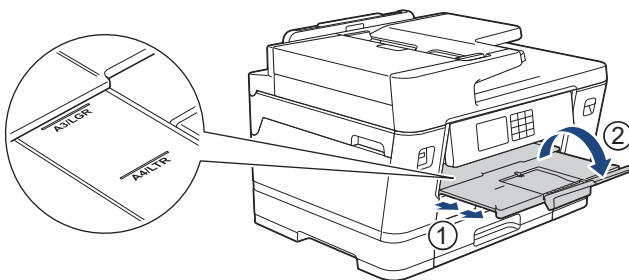

7. Change the paper size setting in the machine's menu, if needed.



## Related Information

- [Load Paper in Paper Tray #1 / Paper Tray #2 / Paper Tray #3](#)

### Related Topics:

- [Paper Type and Paper Size for Each Operation](#)
- [Change the Check Paper Setting](#)
- [Change the Paper Size and Paper Type](#)
- [Choose the Right Print Media](#)

## Load Paper in the Multi-purpose Tray (MP Tray)

**Related Models:** MFC-J3940DW/MFC-J6555DW/MFC-J6940DW/MFC-J6955DW/MFC-J6957DW

- [Load Cut-Sheet Paper, Photo Paper, or Envelopes in the Multi-purpose Tray \(MP Tray\)](#)
- [Load Long Paper in the Multi-purpose Tray \(MP Tray\)](#)

## Load Cut-Sheet Paper, Photo Paper, or Envelopes in the Multi-purpose Tray (MP Tray)

**Related Models:** MFC-J3940DW/MFC-J6555DW/MFC-J6940DW/MFC-J6955DW/MFC-J6957DW

Use the MP tray for special print media, such as photo paper or envelopes.

- If the [Check Paper] setting is set to [On] and you set the paper in the MP tray, a message appears on the LCD, allowing you to change the paper size and paper type.
- When you load a different paper size in the tray, you must change the Paper Size setting in the machine or the paper size setting on your computer.

Doing this enables the machine to automatically feed paper from the appropriate tray if Auto Tray Select has been set in the printer driver (Windows) or on the machine.

### NOTE

- To prevent dust from entering the machine, be sure to close the MP tray if you are not using it.

1. Open the MP tray.

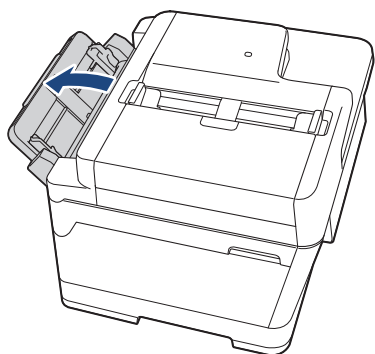

When you want to load paper larger than A4 or Letter size paper, pull up the paper support using both hands until it locks into place.

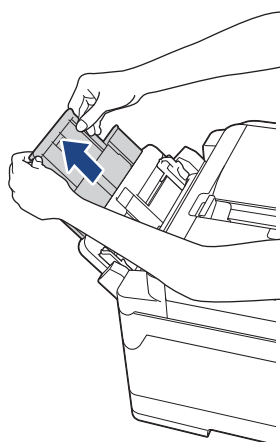

2. Gently press and slide the MP tray paper guides to match the width of the paper you are using.

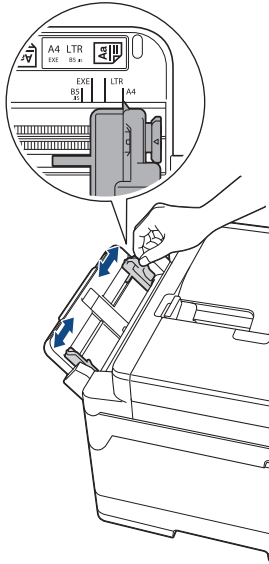

3. Fan the stack of paper well to avoid paper jams and misfeeds.

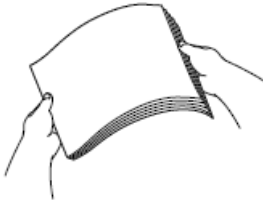

Always make sure the paper is not curled or wrinkled.

4. Gently load the paper in the MP tray with the printing surface **face up**.

- Using A4, Letter, Executive, or B5 (JIS) <sup>1</sup>

#### Landscape orientation

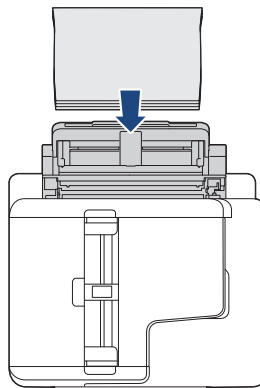
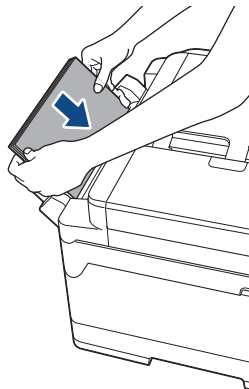

- Using A3, Ledger, B4 (JIS) <sup>1</sup>, Legal, Folio, Mexico Legal, India Legal, A5, A6, envelopes, Photo, Photo L, Photo 2L, B6 (JIS) <sup>1</sup>, or Index Card

#### Portrait orientation

<sup>1</sup> Supported only in some countries.

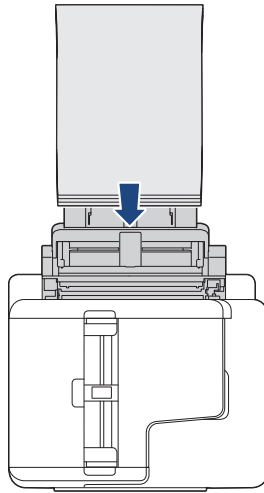
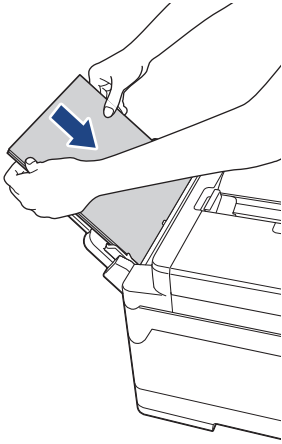

When using envelopes, load the envelopes with the printing surface **face up** and the flap on the left as shown in the illustration.

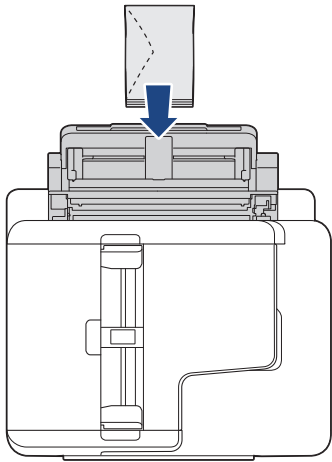

If you are having difficulty loading paper in the MP tray, push the release lever (1) towards the back of the machine, and then load the paper.

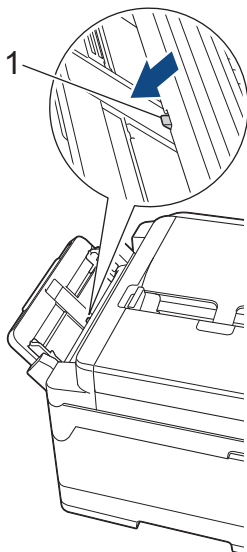

5. Using both hands, gently adjust the MP tray paper guides to fit the paper.

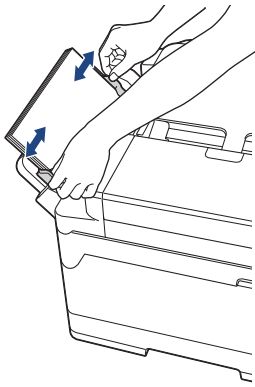

- DO NOT press the paper guides too tightly against the paper. Doing this may cause the paper to fold and jam.
- Place the paper in the centre of the MP tray between the paper guides. If the paper is not centred, pull it out and insert it again at the centre position.

6. Do one of the following:

- When using A4 or Letter, or smaller size paper, pull out the paper support until it locks into place.

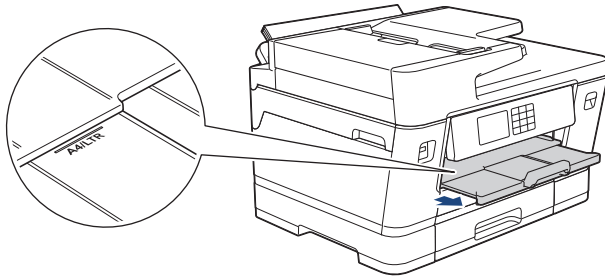

- When using paper larger than A4, Letter, or envelopes, pull out the paper support (1) until it locks into place, and then unfold the paper support flap (2).

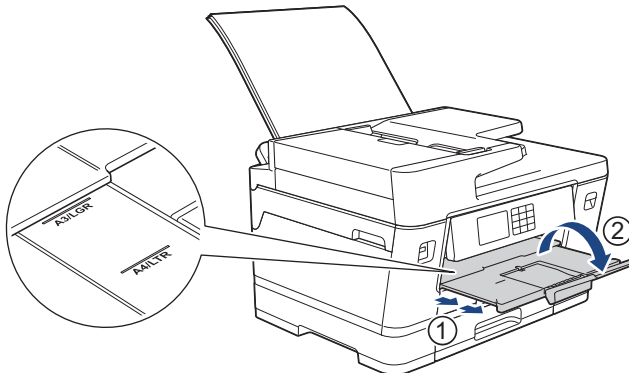

7. Change the paper size setting in the machine's menu, if needed.



Make sure printing has finished before you close the MP tray.



## Related Information

- [Load Paper in the Multi-purpose Tray \(MP Tray\)](#)

### Related Topics:

- [Choose the Right Print Media](#)
- [Error and Maintenance Messages](#)

## Load Long Paper in the Multi-purpose Tray (MP Tray)

**Related Models:** MFC-J3940DW/MFC-J6555DW/MFC-J6940DW/MFC-J6955DW/MFC-J6957DW

Load **one sheet** of Long paper at a time using the MP tray.

- Use the MP tray to print a Long paper (Width: 88.9 - 297 mm / Height: 431.9 - 1200 mm).
- Use Long paper only when printing from your computer or when printing using AirPrint. Do not use Long paper when copying or faxing.
- If the [Check Paper] setting is set to [On] and you set the paper in the MP tray, a message appears on the LCD, allowing you to change the paper size and paper type.
- When you load a different paper size in the tray, you must change the Paper Size setting in the machine or the paper size setting on your computer.

Doing this enables the machine to automatically feed paper from the appropriate tray if Auto Tray Select has been set in the printer driver (Windows) or on the machine.

### NOTE

- To prevent dust from entering the machine, be sure to close the MP tray if you are not using it.

1. Open the MP tray.

### IMPORTANT

To avoid damaging the paper, DO NOT pull up the paper support when loading Long paper.

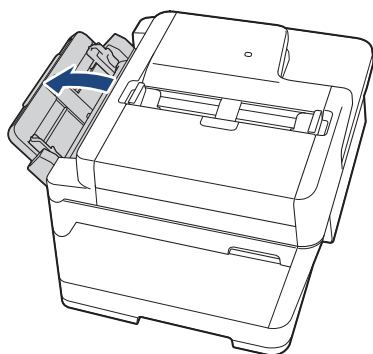

---

2. Gently press and slide the MP tray paper guides to match the width of the paper you are using.

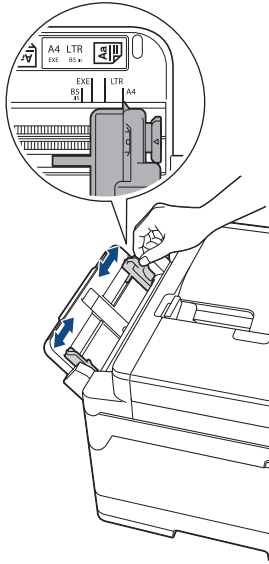

3. Load only **one sheet of paper** in the MP tray with the printing surface **face up**. Using both hands, push one sheet of paper into the MP tray until the front edge touches the paper feed rollers.

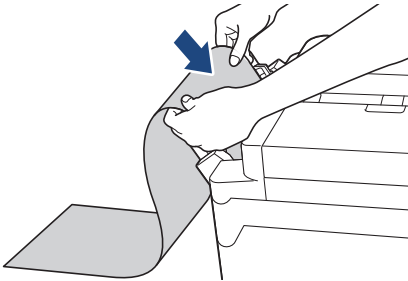

If you are having difficulty loading paper in the MP tray, push the release lever (1) towards the back of the machine, and then load the paper.

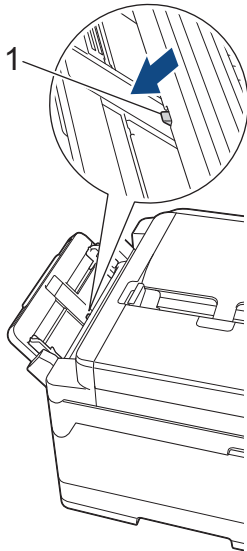

- 
- Using both hands, gently adjust the MP tray paper guides to fit the paper.

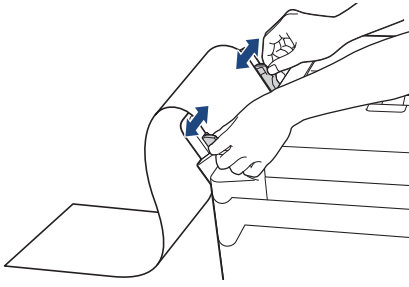

## IMPORTANT

DO NOT load more than one sheet of Long paper in the MP tray at any time. Doing this may cause a paper jam. When printing multiple pages, do not feed the next sheet of paper until the touchscreen displays a message instructing you to feed the next sheet.

- Pull out the paper support (1) until it locks into place, and then unfold the paper support flap (2).

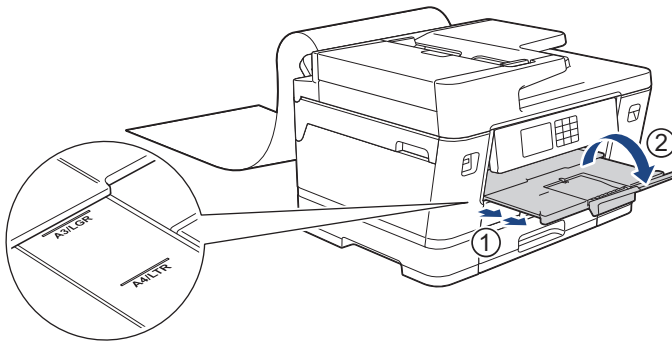

When you feed Long paper into the MP tray, the machine holds the printed page after printing so it does not fall. When printing is complete, remove the printed page and press [OK].

- Change the paper size setting to [User Defined Size] and enter the actual size using the machine's touchscreen.



Make sure printing has finished before you close the MP tray.



## Related Information

- [Load Paper in the Multi-purpose Tray \(MP Tray\)](#)

### Related Topics:

- [Choose the Right Print Media](#)
  - [Error and Maintenance Messages](#)
  - [Print a Long Paper \(Windows\)](#)
-

## Load Paper in the Manual Feed Slot

**Related Models:** MFC-J3540DW/MFC-J6540DW/MFC-J6740DW

Load special print media in this slot, one sheet at a time.



The machine automatically turns on Manual Feed mode when you put paper in the manual feed slot.

1. Open the manual feed slot cover.

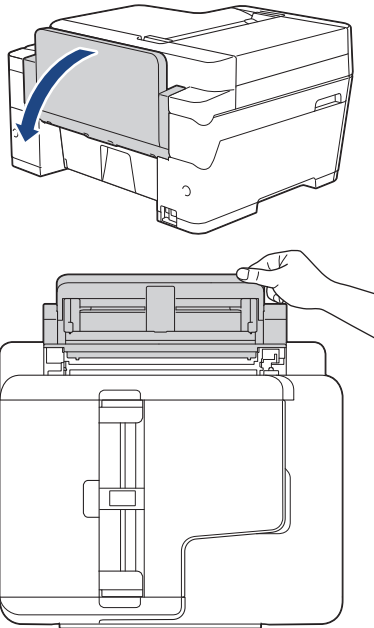

2. Slide the manual feed slot paper guides to fit the width of the paper you are using.

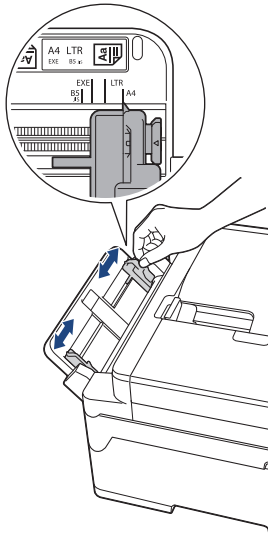

3. Load only one sheet of paper in the manual feed slot with the printing surface **face up**.

Using both hands, push one sheet of paper into the manual feed slot until the front edge touches the paper feed rollers. Let go of the paper when you feel the machine pull it. The LCD displays [Manual Feed Slot ready].

Read the instruction displayed on the LCD, and then press [OK].

- 
- Using A4, Letter, Executive, or B5 (JIS) <sup>1</sup>

#### Landscape orientation

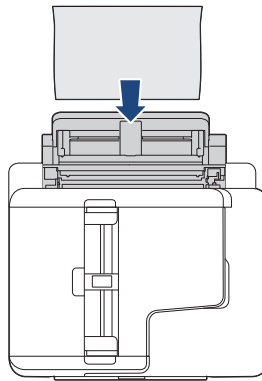
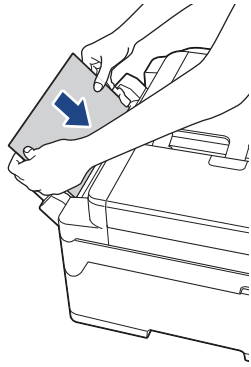

- Using A3, Ledger, B4 (JIS) <sup>1</sup>, Legal, Folio, Mexico Legal, India Legal, A5, A6, envelopes, Photo, Photo L, Photo 2L, B6 (JIS) <sup>1</sup>, or Index Card

#### Portrait orientation

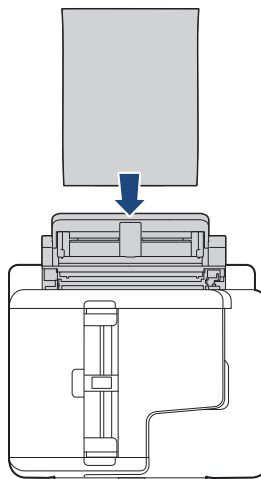
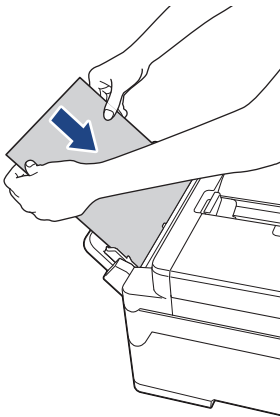

- When using envelopes, load the envelopes with the printing surface **face up** and the flap on the left as shown in the illustration.

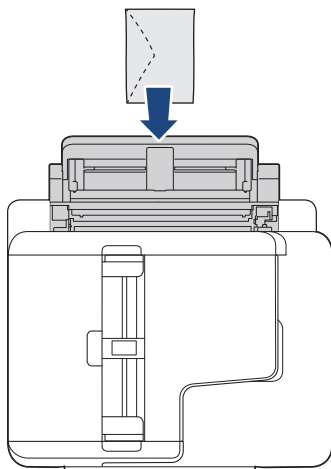

- When loading an envelope, or a sheet of thick paper, push the envelope into the manual feed slot until you feel the paper feed rollers grab it.
- 

<sup>1</sup> Supported only in some countries.

## IMPORTANT

- DO NOT load more than one sheet of paper in the manual feed slot at any time. Doing this may cause a paper jam. When printing multiple pages, do not feed the next sheet of paper until the touchscreen displays a message instructing you to feed the next sheet.
- DO NOT load paper in the manual feed slot when you are printing from the paper tray. Doing this may cause a paper jam.

### 4. Do one of the following:

- When using A4 or Letter size, or smaller size paper  
Pull out the paper support until it locks into place.

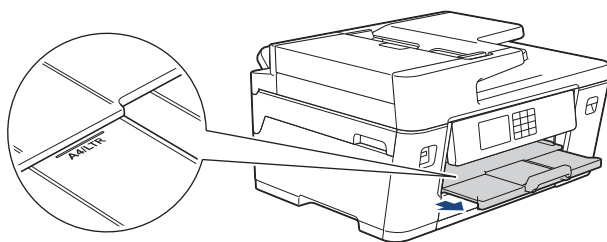

- When using paper larger than A4 or Letter size, or envelopes  
Pull out the paper support (1) until it locks into place, and then unfold the paper support flap (2).

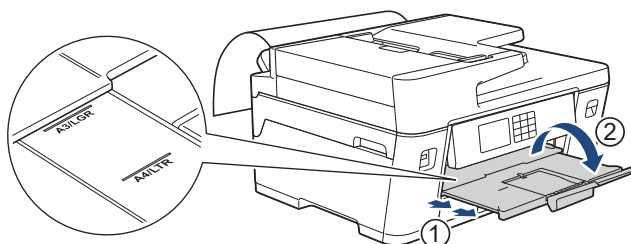

- If the document does not fit on one sheet, the LCD will prompt you to load another sheet of paper. Place another sheet of paper in the manual feed slot, and then press [OK].
- When you feed paper larger than A4 or Letter size into the manual feed slot, the machine holds the printed page after printing so it does not fall. When printing is complete, remove the printed page and press [OK].
- Make sure printing has finished before you close the manual feed slot cover.
- The machine will eject paper loaded in the manual feed slot while a test page, fax, or report is being printed.
- The machine will eject paper loaded in the manual feed slot during the machine's cleaning process. Wait until the machine finishes its cleaning, and then load paper in the manual feed slot.



## Related Information

- [Load Paper](#)

### Related Topics:

- [Error and Maintenance Messages](#)
- [Choose the Right Print Media](#)

## Unprintable Area

The unprintable area depends on the settings in the application you are using. The figures below show the unprintable areas on cut-sheet paper and envelopes. The machine can print in the shaded areas of cut-sheet paper only when the Borderless print feature is available and turned on.

### Cut-Sheet Paper

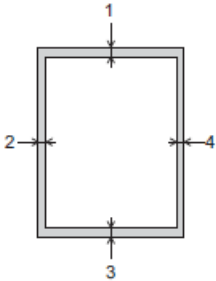

### Envelopes

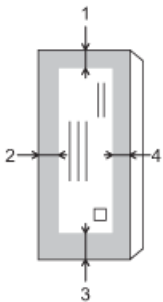

	Top (1)	Left (2)	Bottom (3)	Right (4)
Cut-Sheet	3 mm	3 mm	3 mm <sup>1</sup>	3 mm
Envelopes	12 mm	3 mm	12 mm	3 mm



The Borderless print feature is not available for envelopes and 2-sided printing.

### ✓ Related Information

- [Load Paper](#)

#### Related Topics:

- [Paper Handling and Printing Problems](#)



<sup>1</sup> (MFC-J3940DW/MFC-J6555DW/MFC-J6940DW/MFC-J6955DW/MFC-J6957DW) 5 mm when using the Long paper.

## Paper Settings

- [Change the Paper Size and Paper Type](#)
- [Change the Check Paper Setting](#)
- [Set a Default Tray Based on Your Task](#)
- [Change Paper Tray Priority](#)
- [Change the Paper Low Notice Setting](#)
- [Shrink Page Size of an Oversized Incoming Fax](#)

## Change the Paper Size and Paper Type

Set the Paper Size and Paper Type settings for the paper tray.

- To get the best print quality, set the machine for the type of paper you are using.
  - When you change the size of the paper you load in the tray, you must change the Paper Size setting on the LCD at the same time.
1. (MFC-J3940DW/MFC-J6555DW/MFC-J6740DW/MFC-J6940DW/MFC-J6955DW/MFC-J6957DW) Press  [Settings] > [All Settings] > [General Setup] > [Tray Setting]. Press the tray option you want.
  2. (MFC-J3540DW/MFC-J6540DW) Press  [Settings] > [All Settings] > [General Setup].
  3. Press [Paper Type].
  4. Press ▲ or ▼ to display the paper type options, and then press the option you want.



- 
- (MFC-J3940DW/MFC-J6740DW/MFC-J6940DW/MFC-J6955DW) Use plain paper only in Tray #2.
  - (MFC-J6957DW) Use plain paper only in Tray #2 and Tray #3.
- 

5. Press [Paper Size].
6. Press ▲ or ▼ to display the paper size options, and then press the option you want.
7. Press .



---

The machine ejects paper with the printed surface face up onto the paper tray at the front of the machine. When you use glossy paper, remove each sheet at once to prevent smudging or paper jams.

---



### Related Information

- [Paper Settings](#)



#### Related Topics:

- [Load Photo Paper in Paper Tray #1](#)
  - [Load Envelopes in Paper Tray #1](#)
  - [Acceptable Print Media](#)
  - [Error and Maintenance Messages](#)
  - [Paper Handling and Printing Problems](#)
  - [Load A4, Letter, or Executive Size Paper in Paper Tray #1 / Paper Tray #2 / Paper Tray #3](#)
-

## Change the Check Paper Setting

If this setting is set to [On] and the paper tray is removed or you load paper in the MP tray, the LCD displays a message allowing you to change the Paper Size and Paper Type settings.

The default setting is [On].

1. Press  [Settings] > [All Settings] > [General Setup].
2. (MFC-J3940DW/MFC-J6555DW/MFC-J6740DW/MFC-J6940DW/MFC-J6955DW/MFC-J6957DW) Press [Tray Setting].
3. Press ▲ or ▼ to display the [Check Paper] option, and then press it.
4. Press [On] or [Off].
5. Press .

### ✓ Related Information

- [Paper Settings](#)

#### Related Topics:

- [Load Photo Paper in Paper Tray #1](#)
- [Load Envelopes in Paper Tray #1](#)
- [Error and Maintenance Messages](#)
- [Load A4, Letter, or Executive Size Paper in Paper Tray #1 / Paper Tray #2 / Paper Tray #3](#)

## Set a Default Tray Based on Your Task

**Related Models:** MFC-J3940DW/MFC-J6555DW/MFC-J6740DW/MFC-J6940DW/MFC-J6955DW/MFC-J6957DW

Change the default tray the machine uses for each mode.

The machine feeds paper from the most appropriate tray using the tray priority order you have set.



Some trays are not available depending on your model.

1. Press  [Settings] > [All Settings] > [General Setup] > [Tray Setting].
  - For printing in Copy mode, press [Tray Setting: Copy] > [Tray Select].
  - For printing received faxes, press [Tray Setting: Fax] > [Tray Select].
  - For printing photos, press [Tray Setting: JPEG Print (Media)] > [Tray Select].  
(MFC-J3940DW/MFC-J6555DW/MFC-J6940DW/MFC-J6955DW/MFC-J6957DW)
2. Press the tray option you want.



[Auto Tray Select] sets your machine to feed paper from the most appropriate tray for the paper type and size you have set.

3. Press .



### Related Information



- [Paper Settings](#)

## Change Paper Tray Priority

**Related Models:** MFC-J3940DW/MFC-J6555DW/MFC-J6940DW/MFC-J6955DW/MFC-J6957DW

Change the default tray priority the machine uses for each mode.

When [Auto Tray Select] is selected in the tray select settings, the machine feeds paper from the most appropriate tray for the paper type and size according to the tray priority setting.

1. Press  [Settings] > [All Settings] > [General Setup] > [Tray Setting].
2. Press the [Tray Setting: Copy], [Tray Setting: Fax], [Tray Setting: Print], or [Tray Setting: JPEG Print (Media)] option.
3. Press [Tray Priority].
4. Press the option you want.
5. Press .



### Related Information

- [Paper Settings](#)

## Change the Paper Low Notice Setting



**Related Models:** MFC-J6955DW/MFC-J6957DW

If the Paper Low Notice setting is set to [On], the machine displays a message telling you that the paper tray is nearly empty.

The default setting is [On].

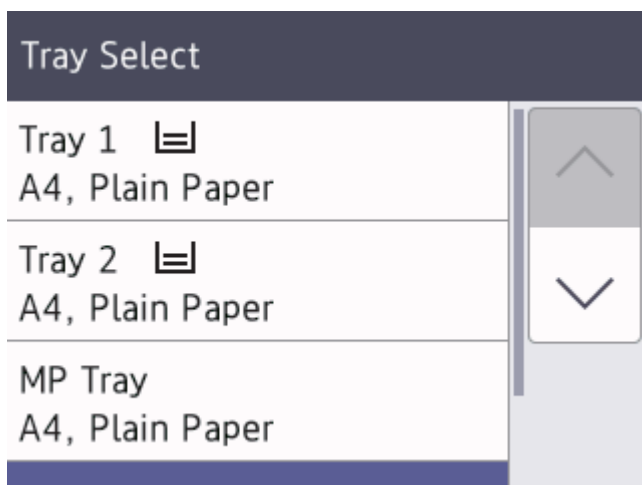
In addition, you can see the icon that displays the remaining amount of paper in the Tray Select option of the Copy mode.



1. Press  [Settings] > [All Settings] > [General Setup] > [Tray Setting] > [Paper Low Notice].
2. Press [On] or [Off].
3. Press .

### Related Information

- [Paper Settings](#)

## Acceptable Print Media

The print quality can be affected by the type of paper you use in the machine.

To get the best print quality for the settings you have selected, always set the Paper Type to match the type of paper you load.

You can use plain paper, inkjet paper (coated paper), glossy paper, recycled paper, and envelopes.

We recommend testing various paper types before buying large quantities.

For best results, use Brother paper.

- When you print on inkjet paper (coated paper) and glossy paper, be sure to select the correct print media in the printer driver or in the application you use to print, or the Paper Type setting on the machine.
- When you print on photo paper, load one extra sheet of the same photo paper in the paper tray.
- When using photo paper, remove each sheet at once to prevent smudging or paper jams.
- Avoid touching the printed surface of the paper immediately after printing; the surface may not be completely dry and may stain your fingers.



### Related Information

- [Load Paper](#)
  - [Recommended Print Media](#)
  - [Handle and Use Print Media](#)
  - [Choose the Right Print Media](#)

### Related Topics:

- [Paper Handling and Printing Problems](#)
  - [Change the Paper Size and Paper Type](#)
-

## Recommended Print Media

For the best print quality, we recommend using the Brother paper listed in the table.

Brother paper may not be available in all countries.

If Brother paper is not available in your country, we recommend testing various paper types before purchasing large quantities.

### Brother paper

Paper Type	Item
A3 Plain	BP60PA3
A3 Glossy Photo	BP71GA3
A3 Inkjet (Matte)	BP60MA3
A4 Plain	BP60PA
A4 Glossy Photo	BP71GA4
A4 Inkjet (Matte)	BP60MA
10 x 15 cm Glossy Photo	BP71GP



### Related Information

- [Acceptable Print Media](#)

## Handle and Use Print Media

- Store paper in its original packaging and keep it sealed. Keep the paper flat and away from moisture, direct sunlight and heat.
- Avoid touching the shiny (coated) side of photo paper.
- Some envelope sizes require that you set margins in the application. Make sure you do a test print first before printing many envelopes.

### IMPORTANT

DO NOT use the following types of paper:

- Damaged, curled, wrinkled, or irregularly shaped

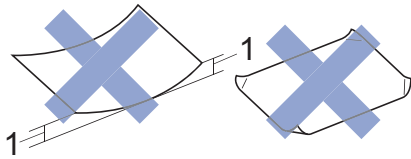

1. **2 mm or greater curl may cause jams to occur.**

- Extremely shiny or highly textured
- Paper that cannot be arranged uniformly when stacked
- Paper made with a short grain

DO NOT use envelopes that:

- Are loosely constructed
- Have windows
- Are embossed (have raised writing on them)
- Have clasps or staples
- Are pre-printed on the inside
- Are self-adhesive
- Have double flaps

#### Self-adhesive Double flaps

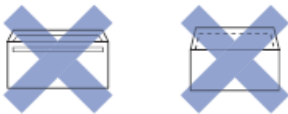

You may experience paper feed problems caused by the thickness, size and flap shape of the envelopes you are using.

### ✓ Related Information

- [Acceptable Print Media](#)

#### Related Topics:

- [Load Paper in Paper Tray #1 / Paper Tray #2 / Paper Tray #3](#)

## Choose the Right Print Media

- Paper Type and Paper Size for Each Operation
- Paper Orientation and Capacity of the Paper Trays
- Load A4, Letter, or Executive Size Paper in Paper Tray #1 / Paper Tray #2 / Paper Tray #3
- Load A3, Ledger, or Legal Size Paper in Paper Tray #1 / Paper Tray #2 / Paper Tray #3
- Load Photo Paper in Paper Tray #1
- Load Envelopes in Paper Tray #1
- Load Cut-Sheet Paper, Photo Paper, or Envelopes in the Multi-purpose Tray (MP Tray)
- Load Long Paper in the Multi-purpose Tray (MP Tray)
- Load Paper in the Manual Feed Slot

## Paper Type and Paper Size for Each Operation

Paper Type	Paper Size		Usage				
			Fax	Copy	Direct Print		Printer
					JPEG Print	PDF Print <sup>2</sup>	
Cut-Sheet	A3	297 x 420 mm	Yes	Yes	Yes	Yes	Yes
	A4	210 x 297 mm	Yes	Yes	Yes	Yes	Yes
	Ledger	279.4 x 431.8 mm	Yes	Yes	Yes	Yes	Yes
	Letter	215.9 x 279.4 mm	Yes	Yes	Yes	Yes	Yes
	Legal	215.9 x 355.6 mm	Yes	Yes	-	Yes	Yes
	Mexico Legal	215.9 x 339.85 mm	Yes	Yes	-	Yes	Yes
	India Legal	215 x 345 mm	Yes	Yes	-	Yes	Yes
	Folio	215.9 x 330.2 mm	Yes	Yes	-	Yes	Yes
	Executive	184.1 x 266.7 mm	-	-	-	-	Yes
	B4 (JIS) <sup>1</sup>	257 x 364 mm	Yes	-	-	Yes	Yes
	B5 (JIS) <sup>1</sup>	182 x 257 mm	-	-	-	Yes	Yes
	B6 (JIS) <sup>1</sup>	128 x 182 mm	-	-	-	-	Yes
	A5	148 x 210 mm	-	Yes	-	Yes	Yes
	A6	105 x 148 mm	-	Yes	-	Yes	Yes
	Long Paper	Width: 88.9 - 297 mm Height: 431.9 - 1200 mm	-	-	-	-	Yes
Cards	Photo	10 x 15 cm	-	Yes	Yes	-	Yes
	Photo L	9 x 13 cm	-	-	-	-	Yes
	Photo 2L	13 x 18 cm	-	-	Yes	-	Yes
	Index Card	13 x 20 cm	-	-	-	-	Yes
Envelopes	C5 Envelope	162 x 229 mm	-	-	-	-	Yes
	DL Envelope	110 x 220 mm	-	-	-	-	Yes
	Com-10	104.7 x 241.3 mm	-	-	-	-	Yes
	Monarch	98.4 x 190.5 mm	-	-	-	-	Yes

<sup>1</sup> Supported only in some countries.

<sup>2</sup> PDF Print is available only for MFC-J6955DW/MFC-J6957DW.



### Related Information

- [Choose the Right Print Media](#)

#### Related Topics:

- [Load Envelopes in Paper Tray #1](#)

## Paper Orientation and Capacity of the Paper Trays

	Paper Size <sup>1</sup>	Paper Types	No. of sheets	Weight	Thickness
Paper Tray #1	<Landscape> A4, Letter, Executive, B5 (JIS) <Portrait> A3, Ledger, B4 (JIS), Legal, Mexico Legal, India Legal, Folio, A5, B6 (JIS), A6, Envelopes (C5, Com-10, DL, Monarch), Photo (10 x 15 cm), Photo L (9 x 13 cm), Photo 2L (13 x 18 cm), Index card (13 x 20 cm)	Plain Paper, Recycled Paper	250 <sup>2</sup>	64 to 120 gsm	0.08 to 0.15 mm
		Inkjet Paper	20	64 to 200 gsm	0.08 to 0.25 mm
		Glossy Paper <sup>3</sup>	20	Up to 220 gsm	Up to 0.25 mm
		Photo Card <sup>3</sup>	20	Up to 200 gsm	Up to 0.25 mm
		Index Card	30	Up to 120 gsm	Up to 0.15 mm
		Envelopes	10	80 to 95 gsm	Up to 0.52 mm
Paper Tray #2 (MFC-J3940DW/ MFC-J6740DW/ MFC-J6940DW/ MFC-J6955DW/ MFC-J6957DW)	<Landscape> A4, Letter <Portrait> A3, Ledger, B4 (JIS), Legal, Mexico Legal, India Legal, Folio	Plain Paper, Recycled Paper	250 <sup>2</sup>	64 to 120 gsm	0.08 to 0.15 mm
Paper Tray #3 (MFC-J6957DW)	<Landscape> A4, Letter <Portrait> A3, Ledger, B4 (JIS), Legal, Mexico Legal, India Legal, Folio	Plain Paper, Recycled Paper	250 <sup>2</sup>	64 to 120 gsm	0.08 to 0.15 mm
Multi-purpose tray (MP tray) <sup>4</sup> (MFC-J3940DW/ MFC-J6555DW/ MFC-J6940DW/ MFC-J6955DW/ MFC-J6957DW)	<Landscape> A4, Letter, Executive, B5 (JIS) <Portrait> A3, Ledger, B4 (JIS), Legal, Mexico Legal, India Legal, Folio, A5, B6 (JIS), A6, Envelopes (C5, Com-10, DL, Monarch), Photo (10 x 15 cm), Photo L (9 x 13 cm), Photo 2L (13 x 18 cm), Index card (13 x 20 cm)	Plain Paper, Recycled Paper	100 <sup>2</sup>	64 to 120 gsm	0.08 to 0.15 mm
		Inkjet Paper	20 (Up to A4/Letter) 5 (Over A4/Letter)	64 to 200 gsm	0.08 to 0.25 mm
		Glossy Paper, Photo Card <sup>3</sup>	20 (Up to A4/Letter) 5 (Over A4/Letter)	Up to 220 gsm	Up to 0.3 mm
		Index Card	50	Up to 120 gsm	Up to 0.15 mm
		Envelopes	20 (Up to A4/Letter) 5 (Over A4/Letter)	80 to 95 gsm	Up to 0.52 mm
		Long Paper (Width: 88.9 - 297 mm / Height: 431.9 - 1200 mm)	Plain Paper, Recycled Paper, Inkjet Paper, Glossy Paper	1	64 to 220 gsm
Manual Feed Slot (MFC-J3540DW/ MFC-J6540DW/ MFC-J6740DW)	<Landscape> A4, Letter, Executive, B5 (JIS)	Plain Paper, Recycled Paper	1	64 to 120 gsm	0.08 to 0.15 mm

	Paper Size <sup>1</sup>	Paper Types	No. of sheets	Weight	Thickness
	<Portrait> A3, Ledger, B4 (JIS), Legal, Mexico Legal, India Legal, Folio, A5, B6 (JIS), A6, Envelopes (C5, Com-10, DL, Monarch), Photo (10 x 15 cm), Photo L (9 x 13 cm), Photo 2L (13 x 18 cm), Index card (13 x 20 cm)	Inkjet Paper	1	64 to 200 gsm	0.08 to 0.25 mm
		Glossy Paper <sup>3</sup>	1	Up to 220 gsm	Up to 0.25 mm
		Photo Card <sup>3</sup>	1	Up to 200 gsm	Up to 0.25 mm
		Index Card	1	Up to 120 gsm	Up to 0.15 mm
		Envelopes	1	80 to 95 gsm	Up to 0.52 mm

<sup>1</sup> B6 (JIS), B5 (JIS) and B4 (JIS) size paper are supported only in some countries.

<sup>2</sup> When using plain paper 80 gsm

<sup>3</sup> BP71 260 gsm paper is specially designed for Brother inkjet machines.

<sup>4</sup> We recommend using the MP tray for glossy paper.



## Related Information

- [Choose the Right Print Media](#)

## Load Documents

- [Load Documents in the Automatic Document Feeder \(ADF\)](#)
- [Load Documents on the Scanner Glass](#)
- [Unscannable Area](#)

## Load Documents in the Automatic Document Feeder (ADF)

The ADF can hold multiple pages and feeds each sheet individually.

Use paper that is within the sizes and weights shown in the table. Always fan the pages before placing them in the ADF.

### Document Sizes and Weights

Length: <sup>1</sup>	148 to 431.8 mm
Width:	105 to 297 mm
Paper Weight:	64 to 120 gsm

<sup>1</sup> Up to 900 mm when using the long paper function.

### IMPORTANT

- DO NOT pull on the document while it is feeding.
- DO NOT use paper that is curled, wrinkled, folded, ripped, stapled, paper clipped, pasted or taped.
- DO NOT use cardboard, newspaper or fabric.
- Make sure documents with correction fluid or written in ink are completely dry.



(MFC-J3940DW/MFC-J6940DW/MFC-J6955DW/MFC-J6957DW)

Your 2-sided documents can be faxed, copied, or scanned up to A3 size using the ADF.

1. Fan the pages well.
2. Adjust the paper guides (1) to fit the document size.

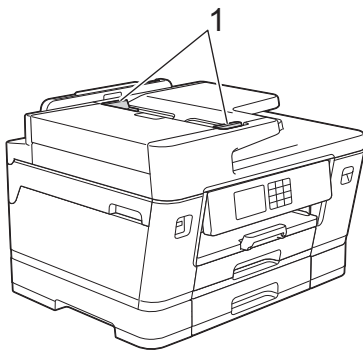

3. Place your document **face up** in the ADF, as shown in the illustration, until you feel the document touch the feed stoppers and the machine beeps.

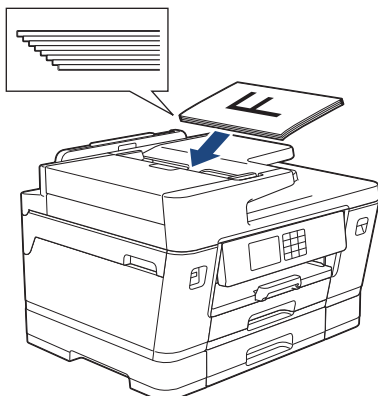



If you loaded a small size document and cannot remove it, lift the ADF document support (1), and then remove the document.

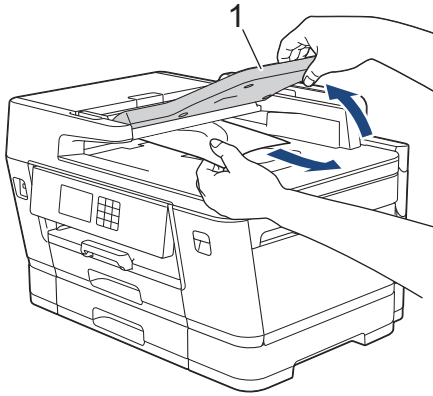

## IMPORTANT

DO NOT leave any documents on the scanner glass. If you do this, the ADF may jam.



### Related Information

- [Load Documents](#)

#### Related Topics:

- [Error and Maintenance Messages](#)
- [Telephone and Fax Problems](#)
- [Other Problems](#)
- [Copy a Document](#)

## Load Documents on the Scanner Glass

Use the scanner glass to fax, copy, or scan one page at a time.

### Document Sizes Supported

Length:	Up to 431.8 mm
Width:	Up to 297 mm
Weight:	Up to 2 kg



To use the scanner glass, the ADF must be empty.

1. Lift the document cover.
2. Place the document **face down** in the upper left corner of the scanner glass as shown in the illustration.

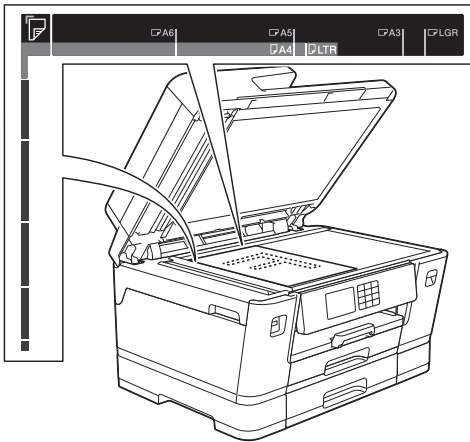

3. Close the document cover.

### IMPORTANT

If you are scanning a book or thick document, DO NOT forcefully close or press on the document cover.



### Related Information

- [Load Documents](#)

#### Related Topics:

- [Telephone and Fax Problems](#)
- [Other Problems](#)
- [Copy a Document](#)

## Unscannable Area

The unscannable area of a page depends on the settings in the application you are using. The figures below show the typical unscannable measurements.

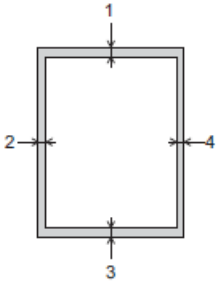

Usage	Document Size	Top (1) Bottom (3)	Left (2) Right (4)
Fax	A3	3 mm	4.5 mm
	A4		3 mm
	Ledger		3.7 mm
	Letter		4 mm
	Legal		
Copy	All paper sizes		3 mm
Scan		1 mm	1 mm

### ✓ Related Information

- [Load Documents](#)

## Print

- [Print from Your Computer \(Windows\)](#)
- [Print from Your Computer \(Mac\)](#)
- [Print Using Brother iPrint&Scan \(Windows/Mac\)](#)
- [Print Data Directly from a USB Flash Drive](#)
- [Print an Email Attachment](#)

## Print from Your Computer (Windows)

- [Print a Photo \(Windows\)](#)
- [Print a Document \(Windows\)](#)
- [Cancel a Print Job \(Windows\)](#)
- [Print More Than One Page on a Single Sheet of Paper \(N in 1\) \(Windows\)](#)
- [Print as a Poster \(Windows\)](#)
- [Print on Both Sides of the Paper Automatically \(Automatic 2-sided Printing\) \(Windows\)](#)
- [Print as a Booklet Automatically \(Windows\)](#)
- [Secure Print \(Windows\)](#)
- [Print a Colour Document in Greyscale \(Windows\)](#)
- [Print a Long Paper \(Windows\)](#)
- [Prevent Smudged Printouts and Paper Jams \(Windows\)](#)
- [Use a Preset Print Profile \(Windows\)](#)
- [Change the Default Print Settings \(Windows\)](#)
- [Print Settings \(Windows\)](#)

## Print a Photo (Windows)



1. Select the print command in your application.
2. Select **Brother XXX-XXXX Printer** (where XXX-XXXX is the name of your model), and then click the printing properties or preferences button.  
The printer driver window appears.
3. Make sure you have loaded the correct media in the paper tray.

### IMPORTANT

- For best results, use Brother paper.
- When you print on photo paper, load one extra sheet of the same photo paper in the paper tray.

4. Click the **Basic** tab.
5. Click the **Media Type** drop-down list, and then select the type of paper you are using.

### IMPORTANT

To get the best print quality for the settings you have selected, always set the **Media Type** option to match the type of paper you load.

6. Click the **Paper Size** drop-down list, and then select your paper size.
7. Select the **Borderless** check box, if needed.
8. For **Colour / Greyscale**, select **Colour**.
9. In the **Orientation** field, select the **Portrait** or **Landscape** option to set the orientation of your printout.



If your application contains a similar setting, we recommend that you set the orientation using the application.

10. Type the number of copies (1-999) you want in the **Copies** field.
11. Change other printer settings, if needed.
12. Click **OK**.
13. Complete your print operation.



### Related Information

- [Print from Your Computer \(Windows\)](#)

#### Related Topics:

- [Print Settings \(Windows\)](#)

## Print a Document (Windows)

1. Select the print command in your application.
2. Select **Brother XXX-XXXX Printer** (where XXX-XXXX is the name of your model), and then click the printing properties or preferences button.  
The printer driver window appears.
3. Make sure you have loaded the correct size paper in the paper tray.
4. Click the **Basic** tab.
5. Click the **Media Type** drop-down list, and then select the type of paper you are using.

### IMPORTANT

To get the best print quality for the settings you have selected, always set the **Media Type** option to match the type of paper you load.

6. Click the **Paper Size** drop-down list, and then select your paper size.
7. For **Colour / Greyscale**, select the **Colour** or **Greyscale** option.
8. In the **Orientation** field, select the **Portrait** or **Landscape** option to set the orientation of your printout.



If your application contains a similar setting, we recommend that you set the orientation using the application.

9. Type the number of copies (1-999) you want in the **Copies** field.
10. To print multiple pages on a single sheet of paper or print one page of your document on multiple sheets, click the **Multiple Page** drop-down list, and then select your options.
11. Change other printer settings, if needed.
12. Click **OK**.
13. Complete your print operation.



### Related Information

- [Print from Your Computer \(Windows\)](#)

#### Related Topics:

- [Check the Ink Volume \(Page Gauge\)](#)
- [Print Settings \(Windows\)](#)

## Cancel a Print Job (Windows)

If a print job was sent to the print queue and did not print, or was sent to the print queue in error, you may have to delete it to allow subsequent jobs to print.

1. Double-click the printer icon  in the task tray.
2. Select the print job you want to cancel.
3. Click the **Document** menu.
4. Select **Cancel**.
5. Click **Yes**.



### Related Information

- [Print from Your Computer \(Windows\)](#)

#### Related Topics:

- [Monitor Machine Status from Your Computer \(Windows\)](#)
-

## Print More Than One Page on a Single Sheet of Paper (N in 1) (Windows)



1. Select the print command in your application.
2. Select **Brother XXX-XXXX Printer** (where XXX-XXXX is the name of your model), and then click the printing properties or preferences button.  
The printer driver window appears.
3. Click the **Basic** tab.
4. In the **Orientation** field, select the **Portrait** or **Landscape** option to set the orientation of your printout.



If your application contains a similar setting, we recommend that you set the orientation using the application.

5. Click the **Multiple Page** drop-down list, and then select the **2 in 1**, **4 in 1**, **9 in 1**, or **16 in 1** option.
6. Click the **Page Order** drop-down list, and then select your page order.
7. Click the **Border Line** drop-down list, and then select your border line type.
8. Change other printer settings, if needed.
9. Click **OK**, and then complete your print operation.



### Related Information

- [Print from Your Computer \(Windows\)](#)

#### Related Topics:

- [Print Settings \(Windows\)](#)

## Print as a Poster (Windows)

Enlarge your print size and print the document in poster mode.

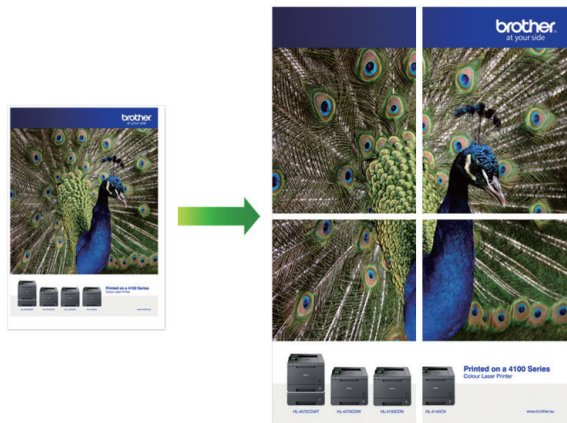

1. Select the print command in your application.
2. Select **Brother XXX-XXXX Printer** (where XXX-XXXX is the name of your model), and then click the printing properties or preferences button.  
The printer driver window appears.
3. Click the **Basic** tab.
4. Click the **Multiple Page** drop-down list, and then select the **1 in 2x2 Pages** or **1 in 3x3 Pages** option.
5. Change other printer settings, if needed.
6. Click **OK**.
7. Complete your print operation.



### Related Information

- [Print from Your Computer \(Windows\)](#)

#### Related Topics:

- [Print Settings \(Windows\)](#)

## Print on Both Sides of the Paper Automatically (Automatic 2-sided Printing) (Windows)



- Make sure the jam clear cover is closed.
- If paper is curled, straighten it and put it back in the paper tray.
- Use regular paper. DO NOT use bond paper.
- If the paper is thin, it may wrinkle.

1. Select the print command in your application.
2. Select **Brother XXX-XXXX Printer** (where XXX-XXXX is the name of your model), and then click the printing properties or preferences button.  
The printer driver window appears.
3. Click the **Basic** tab.
4. In the **Orientation** field, select the **Portrait** or **Landscape** option to set the orientation of your printout.



If your application contains a similar setting, we recommend that you set the orientation using the application.

5. Click the **2-sided / Booklet** drop-down list, and then select **2-sided**.
6. Click the **2-sided Settings** button.
7. Select one of the options from the **2-sided Type** menu.

When 2-sided is selected, four types of 2-sided binding are available for each orientation:

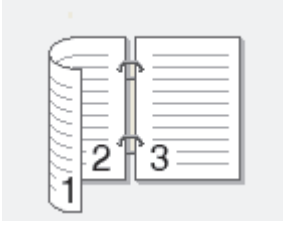
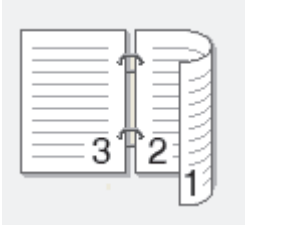
Option for Portrait	Description
Long Edge (Left)	
Long Edge (Right)	

Option for Portrait	Description
---------------------	-------------

Short Edge (Top)

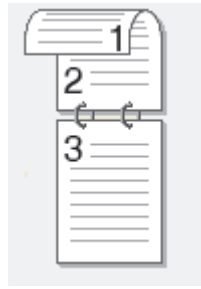

Short Edge (Bottom)

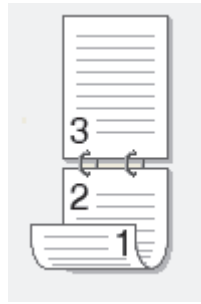

Option for Landscape	Description
----------------------	-------------

Long Edge (Top)

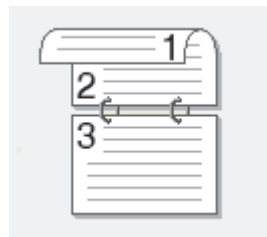

Long Edge (Bottom)

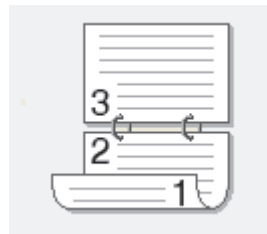

Short Edge (Right)

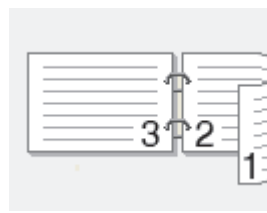

Short Edge (Left)

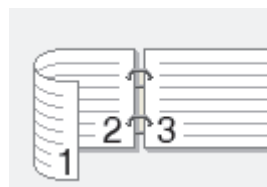

8. Select the **Binding Offset** check box to specify the offset for binding in inches or millimetres.
9. Click **OK** to return to the printer driver window.
10. Change other printer settings, if needed.



The Borderless feature is not available when using this option.

11. Click **OK** again, and then complete your print operation.



## Related Information

- [Print from Your Computer \(Windows\)](#)

### **Related Topics:**

- [Print Settings \(Windows\)](#)
  - [Print as a Booklet Automatically \(Windows\)](#)
-

## Print as a Booklet Automatically (Windows)

Use this option to print a document in booklet format using 2-sided printing. The document's pages will be arranged according to the correct page number and will allow you to fold at the centre of the print output without having to change the order of the printed pages.



- Make sure the jam clear cover is closed.
- If paper is curled, straighten it and put it back in the paper tray.
- Use regular paper. DO NOT use bond paper.
- If the paper is thin, it may wrinkle.

1. Select the print command in your application.
2. Select **Brother XXX-XXXX Printer** (where XXX-XXXX is the name of your model), and then click the printing properties or preferences button.  
The printer driver window appears.
3. Click the **Basic** tab.
4. In the **Orientation** field, select the **Portrait** or **Landscape** option to set the orientation of your printout.



If your application contains a similar setting, we recommend that you set the orientation using the application.

5. Click the **2-sided / Booklet** drop-down list, and then select the **Booklet** option.
6. Click the **2-sided Settings** button.
7. Select one of the options from the **2-sided Type** menu.

There are two types of 2-sided binding directions available for each orientation:

Option for Portrait	Description
<b>Left Binding</b>	
<b>Right Binding</b>	

Option for Landscape	Description
----------------------	-------------

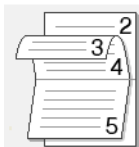

**Top Binding**

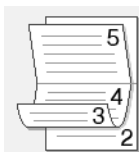

**Bottom Binding**



8. Select one of the options from the **Booklet Printing Method** menu.

Option	Description
<b>All Pages at Once</b>	Every page will be printed in booklet format (four pages to every piece of paper, two pages per side). Fold your printout in the middle to create the booklet. 
<b>Divide into Sets</b>	This option prints the whole booklet in smaller individual booklet sets, allowing you to fold at the centre of the smaller individual booklet sets without having to change the order of the printed pages. You can specify the number of sheets in each smaller booklet set (from 1-15). This option can be helpful when folding a printed booklet that has a large number of pages. 

9. Select the **Binding Offset** check box to specify the offset for binding in inches or millimetres.

10. Click **OK** to return to the printer driver window.

11. Change other printer settings, if needed.



The Borderless feature is not available when using this option.

12. Click **OK**.

13. Complete your print operation.



### Related Information

- [Print from Your Computer \(Windows\)](#)

#### Related Topics:

- [Print Settings \(Windows\)](#)
- [Print on Both Sides of the Paper Automatically \(Automatic 2-sided Printing\) \(Windows\)](#)

## Secure Print (Windows)

**Related Models:** MFC-J6955DW/MFC-J6957DW

Use Secure Print to ensure that confidential or sensitive documents do not print until you enter a password on the machine's control panel.

The secure data is deleted from the machine when you turn off the machine.

1. Select the print command in your application.
2. Select **Brother XXX-XXXX Printer** (where XXX-XXXX is the name of your model), and then click the printing properties or preferences button.  
The printer driver window appears.
3. Click the **Advanced** tab.
4. Click the **Settings** button in the **Secure Print** field.
5. Select the **Secure Print** check box.
6. Type your four-digit password in the **Password** field.
7. Type the **User Name** and **Job Name** in the text field, if needed.
8. Click **OK**, to close the **Secure Print Settings** window.
9. Click **OK**.
10. Complete your print operation.
11. On the machine's control panel, press ◀ or ▶ to display the [Secure Print] option, and then press [Secure Print].
12. Press ▲ or ▼ to display user names, and then press your user name.
13. Enter your four-digit password, and then press [OK].
14. Press ▲ or ▼ to display the print job, and then press it.
15. Enter the number of copies you want.
16. Press [Start].  
The machine prints the data.

After you have printed the secured data, it will be cleared from the machine's memory.



### Related Information

- [Print from Your Computer \(Windows\)](#)

## Print a Colour Document in Greyscale (Windows)

Greyscale mode makes the print processing speed faster than colour mode. If your document contains colour, selecting Greyscale mode prints your document in 256 levels of greyscale.

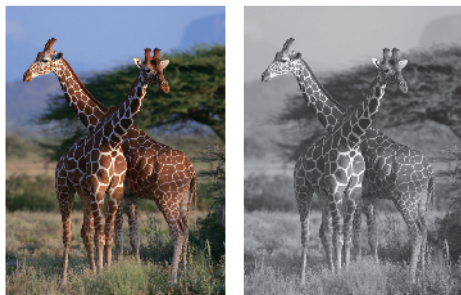

1. Select the print command in your application.
2. Select **Brother XXX-XXXX Printer** (where XXX-XXXX is the name of your model), and then click the printing properties or preferences button.  
The printer driver window appears.
3. Click the **Basic** tab.
4. For **Colour / Greyscale**, select **Greyscale**.
5. Change other printer settings, if needed.
6. Click **OK**.
7. Complete your print operation.



### Related Information

- [Print from Your Computer \(Windows\)](#)

## Print a Long Paper (Windows)

**Related Models:** MFC-J3940DW/MFC-J6555DW/MFC-J6940DW/MFC-J6955DW/MFC-J6957DW

1. Select the print command in your application.
2. Select **Brother XXX-XXXX Printer** (where XXX-XXXX is the name of your model), and then click the printing properties or preferences button.  
The printer driver window appears.
3. Make sure you have loaded only **one sheet** of Long paper (Width: 88.9 - 297 mm / Height: 431.9 - 1200 mm) in the MP tray.
4. Click the **Basic** tab.
5. Click the **Media Type** drop-down list, and then select the type of paper you are using.

### IMPORTANT

To get the best print quality for the settings you have selected, always set the **Media Type** option to match the type of paper you load.

6. Click the **Paper Size** drop-down list, select **User Defined....** Enter the width, height, and other information in the **User Defined Size** window, and then click **OK**.
7. For **Colour / Greyscale**, select the **Colour** or **Greyscale** option.
8. In the **Orientation** field, select the **Portrait** option.



If your application contains a similar setting, we recommend that you set the orientation using the application.

9. Type the number of copies (1-999) you want in the **Copies** field.
10. Change other printer settings, if needed.
11. Click **OK**.
12. Complete your print operation.



### Related Information

- [Print from Your Computer \(Windows\)](#)

#### Related Topics:

- [Load Long Paper in the Multi-purpose Tray \(MP Tray\)](#)

## Prevent Smudged Printouts and Paper Jams (Windows)

Some types of print media may need more drying time. Change the **Reduce Smudge** option if you have problems with smudged printouts or paper jams.

1. Select the print command in your application.
2. Select **Brother XXX-XXXX Printer** (where XXX-XXXX is the name of your model), and then click the printing properties or preferences button.

The printer driver window appears.

3. Click the **Advanced** tab.
4. Click the **Other Print Options** button.
5. Select the **Reduce Smudge** option on the left side of the screen.
6. Select one of the following options:

Media Type	Option	Description
Plain Paper	2-sided Printing or Simplex Printing	Off / On Select <b>Off</b> to print at normal speed, using a standard amount of ink. Select <b>On</b> to print at a slower speed, using less ink. Printouts may be lighter than they appear in Print Preview.
Glossy Paper	Off / On	Select <b>Off</b> to print at normal speed, using a standard amount of ink. Select <b>On</b> to print at a slower speed, using less ink. Printouts may be lighter than they appear in Print Preview.

7. Click **OK** to return to the printer driver window.
8. Click **OK**.
9. Complete your print operation.



### Related Information

- [Print from Your Computer \(Windows\)](#)

#### Related Topics:

- [Paper Handling and Printing Problems](#)
- [Change the Print Options to Improve Your Print Results](#)

## Use a Preset Print Profile (Windows)

**Print Profiles** are presets designed to give you quick access to frequently-used printing configurations.

1. Select the print command in your application.
2. Select **Brother XXX-XXXX Printer** (where XXX-XXXX is the name of your model), and then click the printing properties or preferences button.  
The printer driver window appears.
3. Click the **Print Profiles** tab.

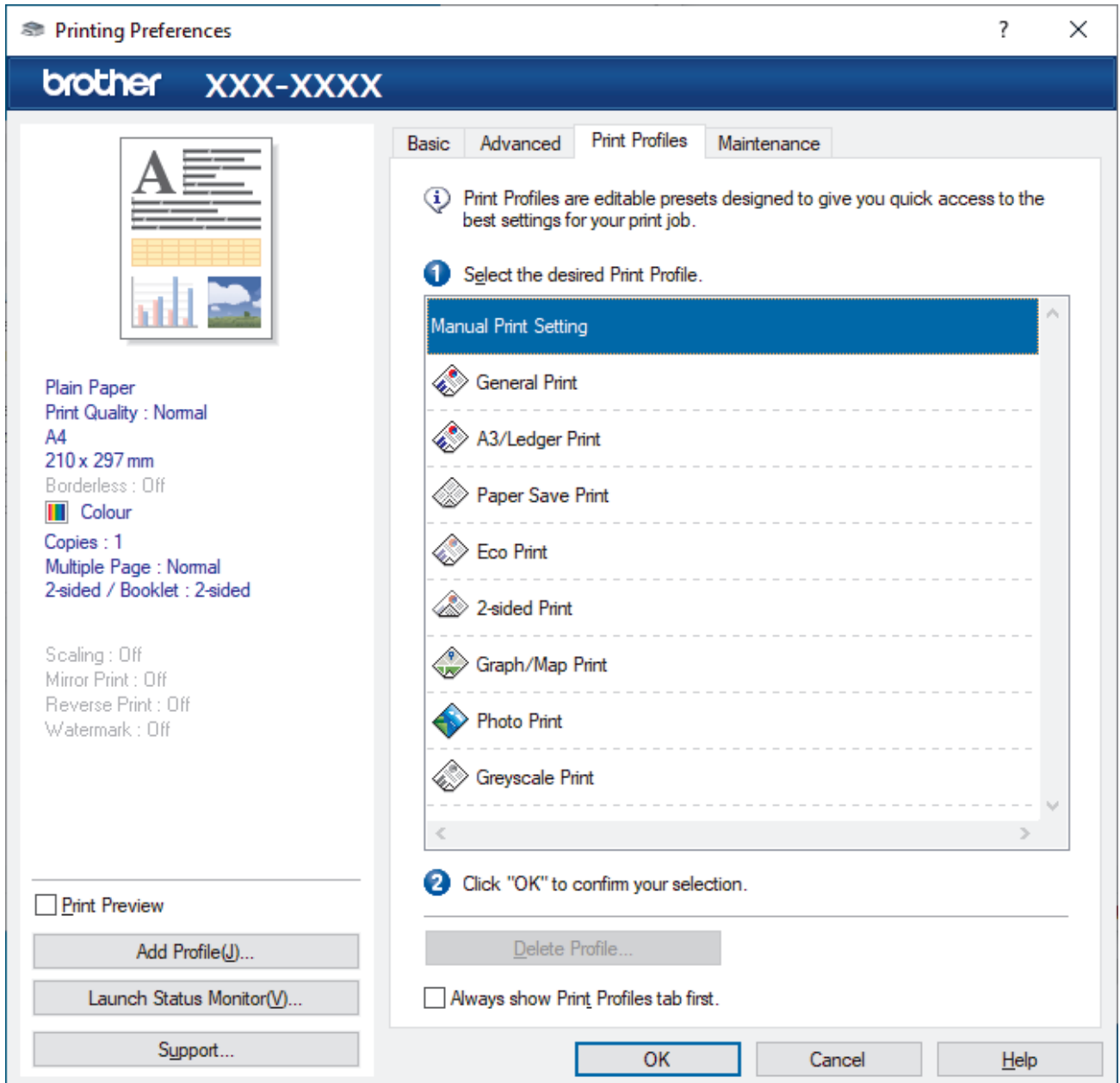

4. Select your profile from the print profile list.  
The profile settings are shown on the left side of the printer driver window.
5. Do one of the following:
  - If the settings are correct for your print job, click **OK**.
  - To change the settings, go back to the **Basic** or **Advanced** tab, change settings, and then click **OK**.



To display the **Print Profiles** tab at the front of the window the next time you print, select the **Always show Print Profiles tab first**. check box.



## Related Information

- [Print from Your Computer \(Windows\)](#)
  - [Create or Delete Your Print Profile \(Windows\)](#)

### Related Topics:

- [Print Settings \(Windows\)](#)
-

## Create or Delete Your Print Profile (Windows)

Add up to 20 new print profiles with customised settings.

1. Select the print command in your application.
2. Select **Brother XXX-XXXX Printer** (where XXX-XXXX is the name of your model), and then click the printing properties or preferences button.

The printer driver window appears.

3. Do one of the following:

### To create a new print profile:

- a. Click the **Basic** tab and the **Advanced** tab, and configure the print settings you want for the new Print Profile.
  - b. Click the **Print Profiles** tab.
  - c. Click **Add Profile**.
- The **Add Profile** dialog box appears.
- d. Type the new profile name in the **Name** field.
  - e. Click the icon you want to use to represent this profile from the icon list.
  - f. Click **OK**.

The new Print Profile name is added to the list in the **Print Profiles** tab.

### To delete a print profile that you created:

- a. Click the **Print Profiles** tab.
  - b. Click **Delete Profile**.
- The **Delete Profile** dialog box appears.
- c. Select the profile you want to delete.
  - d. Click **Delete**.
  - e. Click **Yes**.
  - f. Click **Close**.





### Related Information

- [Use a Preset Print Profile \(Windows\)](#)

## Change the Default Print Settings (Windows)

When you change an application's print settings, the changes only apply to documents printed with that application. To change print settings for all Windows applications, you must configure the printer driver properties.

1. Do one of the following:
  - For Windows Server 2008  
Click  (**Start**) > **Control Panel** > **Hardware and Sound** > **Printers**.
  - For Windows 7 and Windows Server 2008 R2  
Click  (**Start**) > **Devices and Printers**.
  - For Windows 8.1  
Move your mouse to the lower right corner of your desktop. When the menu bar appears, click **Settings**, and then click **Control Panel**. In the **Hardware and Sound** group, click **View devices and printers**.
  - For Windows 10, Windows Server 2016 and Windows Server 2019  
Click  > **Windows System** > **Control Panel**. In the **Hardware and Sound** group, click **View devices and printers**.
  - For Windows Server 2012  
Move your mouse to the lower right corner of your desktop. When the menu bar appears, click **Settings**, and then click **Control Panel**. In the **Hardware** group, click **View devices and printers**.
  - For Windows Server 2012 R2  
Click **Control Panel** on the **Start** screen. In the **Hardware** group, click **View devices and printers**.
2. Right-click the **Brother XXX-XXXX Printer** icon (where XXX-XXXX is the name of your model), and then select **Printer properties**. If printer driver options appear, select your printer driver.  
The printer properties dialog box appears.
3. Click the **General** tab, and then click the **Printing Preferences...** or **Preferences...** button.  
The printer driver dialog box appears.
4. Select the print settings you want to use as defaults for all of your Windows programs.
5. Click **OK**.
6. Close the printer properties dialog box.



### Related Information

- [Print from Your Computer \(Windows\)](#)

#### Related Topics:

- [Print Settings \(Windows\)](#)

## Print Settings (Windows)

- >> Basic Tab
- >> Advanced Tab

### Basic Tab

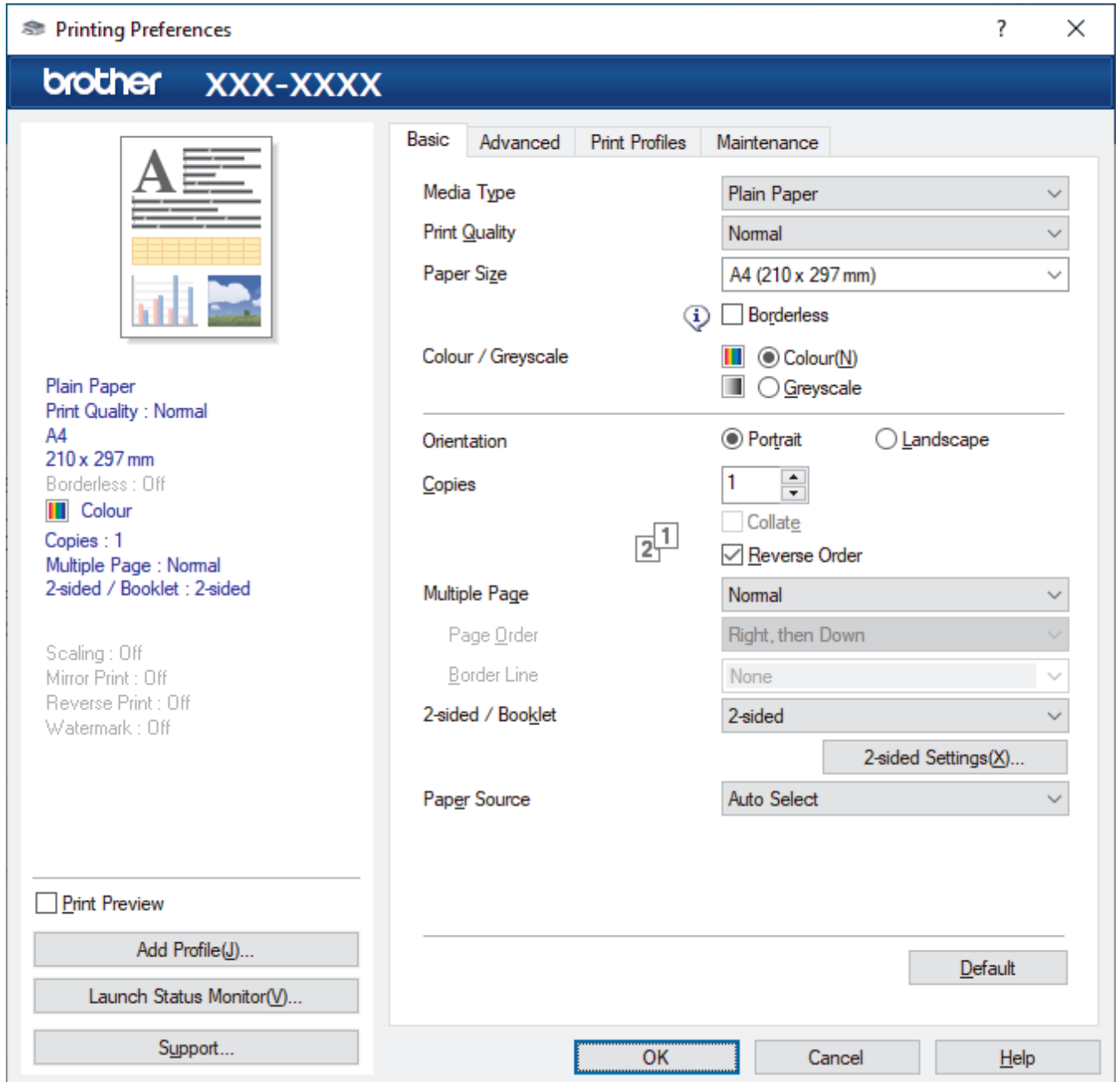

#### 1. Media Type

Select the media type you want to use. To achieve the best print results, the machine automatically adjusts its print settings according to the selected media type.

#### 2. Print Quality

Select the print quality you want. Because print quality and speed are related, the higher the quality, the longer it will take to print the document.

#### 3. Paper Size

Select the paper size you want to use. You can either choose from standard paper sizes or create a custom paper size.

---

### **Borderless**

Select this option to print photos without borders. Because the image data is created slightly larger than the paper size you are using, this will cause some cropping of the photo edges.

You may not be able to select the Borderless option for some combinations of media type and quality, or from some applications.

### **4. Colour / Greyscale**

Select colour or greyscale printing. The print speed is faster in greyscale mode than it is in colour mode. If your document contains colour and you select greyscale mode, your document will be printed using 256 levels of greyscale.

### **5. Orientation**

Select the orientation (portrait or landscape) of your printout.

If your application contains a similar setting, we recommend that you set the orientation using the application.

### **6. Copies**

Type the number of copies (1-999) that you want to print in this field.

#### **Collate**

Select this option to print sets of multi-page documents in the original page order. When this option is selected, one complete copy of your document will print, and then reprint according to the number of copies you choose. If this option is not selected, then each page will print according to the number of copies chosen before the next page of the document is printed.

#### **Reverse Order**

Select this option to print your document in reverse order. The last page of your document will be printed first.

### **7. Multiple Page**

Select this option to print multiple pages on a single sheet of paper, or print one page of your document on multiple sheets.

#### **Page Order**

Select the page order when printing multiple pages on a single sheet of paper.

#### **Border Line**

Select the type of border to use when printing multiple pages on a single sheet of paper.

### **8. 2-sided / Booklet**

Select this option to print on both sides of the paper, or print a document in booklet format using 2-sided printing.

#### **2-sided Settings button**

Click this button to select the type of 2-sided binding. Four types of 2-sided bindings are available for each orientation.

### **9. (MFC-J3940DW/MFC-J6555DW/MFC-J6740DW/MFC-J6940DW/MFC-J6955DW/MFC-J6957DW) Paper Source**

Select the paper source setting according to your print conditions or purpose.

## Advanced Tab

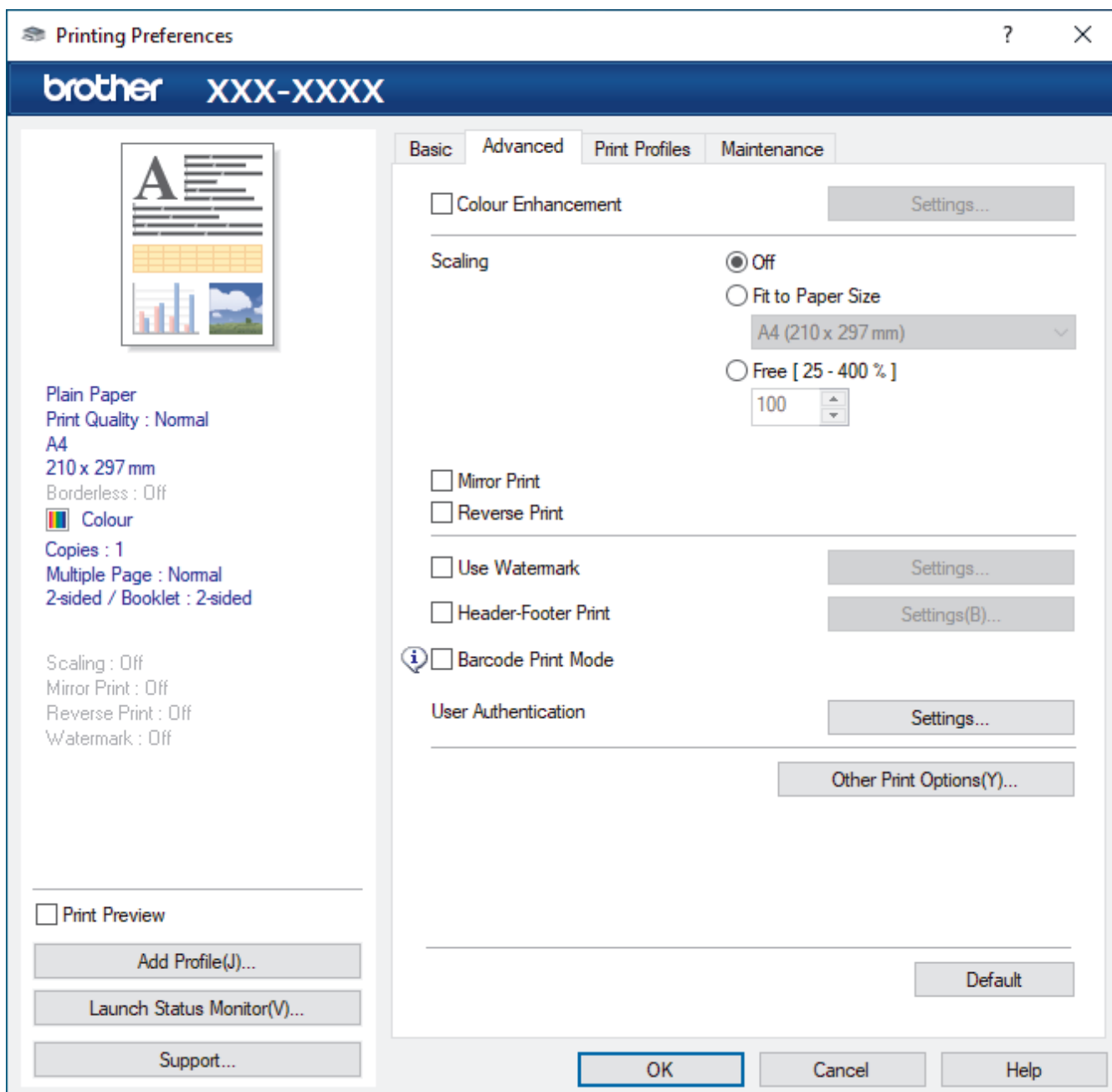

### 1. Colour Enhancement

Select this option to use the Colour Enhancement feature. This feature analyses your image to improve its sharpness, white balance and colour density. This process may take several minutes depending on the image size and your computer's specifications.

### 2. Scaling

Select these options to enlarge or reduce the size of the pages in your document.

#### Fit to Paper Size

Select this option to enlarge or reduce the document pages to fit a specified paper size. When you select this option, select the paper size you want from the drop-down list.

#### Free [ 25 - 400 % ]

Select this option to enlarge or reduce the document pages manually. When you select this option, type a value into the field.

### 3. Mirror Print

Select this option to reverse the printed image on the page horizontally from left to right.

---

#### 4. Reverse Print

Select this option to rotate the printed image 180 degrees.

#### 5. Use Watermark

Select this option to print a logo or text on your document as a watermark. Select one of the preset watermarks, add a new watermark, or use an image file you have created.

#### 6. Header-Footer Print

Select this option to print the date, time and PC login user name on the document.

#### 7. Barcode Print Mode

Select this option to print barcodes at the most suitable quality and resolution.

#### 8. (MFC-J6955DW/MFC-J6957DW) Secure Print

This feature ensures that confidential or sensitive documents do not print until you enter a password on the machine's control panel.

#### 9. User Authentication

This feature allows you to confirm the restrictions for each user.

#### 10. Other Print Options button

##### Advanced Colour Settings

Select the method that the machine uses to arrange dots to express halftones.

The printout colour can be adjusted to achieve the closest match to what appears on your computer screen.

##### Reduce Smudge

Some types of print media may need more drying time. Change this option if you have problems with smudged printouts or paper jams.

##### Retrieve Printer's Colour Data

Select this option to optimise the print quality using the machine's factory settings, which are set specifically for your Brother machine. Use this option when you have replaced the machine or changed the machine's network address.

##### Print Archive

Select this option to save the print data as a PDF file to your computer.

##### Reduce Uneven Lines

Select this option to adjust the print alignment if your printed text becomes blurred or images become faded.



#### Related Information

- [Print from Your Computer \(Windows\)](#)

##### Related Topics:

- [Error and Maintenance Messages](#)
  - [Paper Handling and Printing Problems](#)
  - [Print a Photo \(Windows\)](#)
  - [Print a Document \(Windows\)](#)
  - [Print More Than One Page on a Single Sheet of Paper \(N in 1\) \(Windows\)](#)
  - [Print as a Poster \(Windows\)](#)
  - [Print on Both Sides of the Paper Automatically \(Automatic 2-sided Printing\) \(Windows\)](#)
  - [Print as a Booklet Automatically \(Windows\)](#)
  - [Use a Preset Print Profile \(Windows\)](#)
  - [Change the Default Print Settings \(Windows\)](#)
  - [Change the Print Options to Improve Your Print Results](#)
-

## **Print from Your Computer (Mac)**

- [Print Using AirPrint \(macOS\)](#)

## **Print Using Brother iPrint&Scan (Windows/Mac)**

- [Print Photos or Documents Using Brother iPrint&Scan \(Windows/Mac\)](#)
- [Print on Both Sides of the Paper Automatically Using Brother iPrint&Scan \(Automatic 2-sided Printing\) \(Windows/Mac\)](#)
- [Print More Than One Page on a Single Sheet of Paper Using Brother iPrint&Scan \(N in 1\) \(Windows/Mac\)](#)
- [Print a Colour Document in Greyscale Using Brother iPrint&Scan \(Windows/Mac\)](#)

## Print Photos or Documents Using Brother iPrint&Scan (Windows/Mac)



1. Make sure you have loaded the correct media in the paper tray.

### IMPORTANT

For photo printing:

- For best results, use Brother paper.
- When you print on photo paper, load one extra sheet of the same photo paper in the paper tray.

2. Start Brother iPrint&Scan.

- Windows

Launch  (Brother iPrint&Scan).

- Mac

In the **Finder** menu bar, click **Go > Applications**, and then double-click the iPrint&Scan icon.

The Brother iPrint&Scan screen appears.

3. If your Brother machine is not selected, click the **Select your Machine** button, and then select your model name from the list. Click **OK**.
4. Click **Print**.
5. Do one of the following:
  - Windows  
Click **Photo** or **Document**.
  - Mac  
Click **Photo** or **PDF**.
6. Select the file you want to print, and then do one of the following:
  - Windows  
Click **Next**.
  - Mac  
Click **Open**, and then click **Next** if prompted.

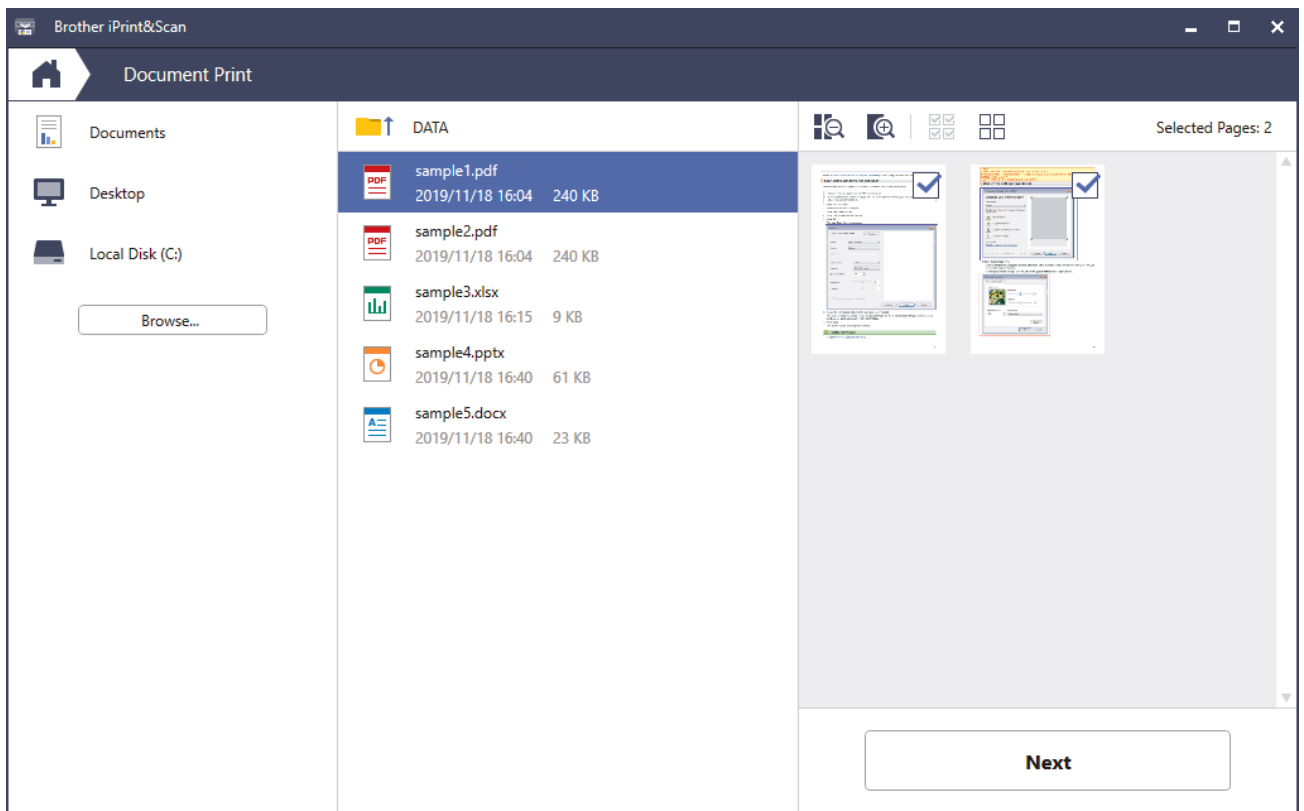

- The actual screen may differ depending on the version of the application.
- Use the latest application. See *Related Information*.
- When printing documents with many pages, you can also select the pages you want to print.

7. Change other printer settings, if needed.

8. Click **Print**.

## IMPORTANT

For photo printing:

To get the best print quality for the settings you have selected, always set the **Media Type** option to match the type of paper you load.



## Related Information

- [Print Using Brother iPrint&Scan \(Windows/Mac\)](#)

## Print on Both Sides of the Paper Automatically Using Brother iPrint&Scan (Automatic 2-sided Printing) (Windows/Mac)



- Make sure the jam clear cover is closed.
- If paper is curled, straighten it and put it back in the paper tray.
- Use regular paper. DO NOT use bond paper.
- If the paper is thin, it may wrinkle.

1. Start Brother iPrint&Scan.

- Windows

Launch  (Brother iPrint&Scan).

- Mac

In the **Finder** menu bar, click **Go > Applications**, and then double-click the iPrint&Scan icon.

The Brother iPrint&Scan screen appears.

2. If your Brother machine is not selected, click the **Select your Machine** button, and then select your model name from the list. Click **OK**.

3. Click **Print**.

4. Do one of the following:

- Windows  
Click **Document**.
- Mac  
Click **PDF**.

5. Select the file you want to print, and then do one of the following:

- Windows  
Click **Next**.
- Mac  
Click **Open**, and then click **Next** if prompted.



When printing documents with many pages, you can also select the pages you want to print.

6. Select one of the options from the **2-sided** drop-down list.

Two types of 2-sided binding are available:

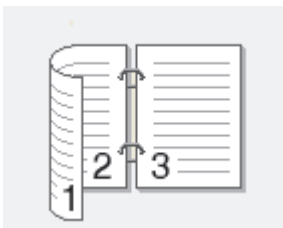
Option	Description
On (Flip on long edge)	

---

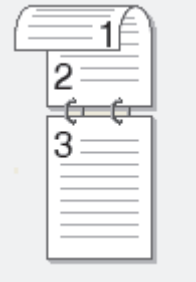
Option	Description
On (Flip on short edge)	

---

7. Change other printer settings, if needed.
8. Click **Print**.

### **Related Information**

- [Print Using Brother iPrint&Scan \(Windows/Mac\)](#)
-

## Print More Than One Page on a Single Sheet of Paper Using Brother iPrint&Scan (N in 1) (Windows/Mac)



1. Launch  (**Brother iPrint&Scan**).

The Brother iPrint&Scan screen appears.

2. If your Brother machine is not selected, click the **Select your Machine** button, and then select your model name from the list. Click **OK**.
3. Click **Print**.
4. Do one of the following:
  - Windows  
Click **Document**.
  - Mac  
Click **PDF**.
5. Select the file you want to print, and then do one of the following:
  - Windows  
Click **Next**.
  - Mac  
Click **Open**, and then click **Next** if prompted.



---

When printing documents with many pages, you can also select the pages you want to print.

---

6. Click the **Layout** drop-down list, and then select the number of pages to print on each sheet.
7. Change other printer settings, if needed.
8. Click **Print**.





### Related Information

- [Print Using Brother iPrint&Scan \(Windows/Mac\)](#)

## Print a Colour Document in Greyscale Using Brother iPrint&Scan (Windows/Mac)

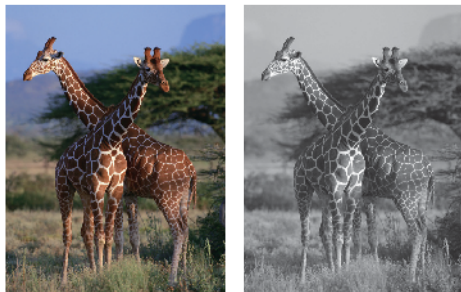
Greyscale mode makes the print processing speed faster than colour mode. If your document contains colour, selecting Greyscale mode prints your document in 256 levels of greyscale.



1. Start Brother iPrint&Scan.
  - Windows  
Launch  (Brother iPrint&Scan).
  - Mac  
In the **Finder** menu bar, click **Go > Applications**, and then double-click the iPrint&Scan icon.  
The Brother iPrint&Scan screen appears.
2. If your Brother machine is not selected, click the **Select your Machine** button, and then select your model name from the list. Click **OK**.
3. Click **Print**.
4. Do one of the following:
  - Windows  
Click **Photo** or **Document**.
  - Mac  
Click **Photo** or **PDF**.
5. Select the file you want to print, and then do one of the following:
  - Windows  
Click **Next**.
  - Mac  
Click **Open**, and then click **Next** if prompted.



When printing documents with many pages, you can also select the pages you want to print.

6. Click the **Colour / Mono** drop-down list, and then select the **Mono** option.
7. Change other printer settings, if needed.
8. Click **Print**.



### Related Information

- [Print Using Brother iPrint&Scan \(Windows/Mac\)](#)

## **Print Data Directly from a USB Flash Drive**

- [Compatible USB Flash Drives](#)
- [Print Photos Directly from a USB Flash Drive](#)
- [Print a PDF File Directly from a USB Flash Drive](#)

## Compatible USB Flash Drives

Your Brother machine has a media drive (slot) for use with common data storage.

### IMPORTANT

The USB direct interface supports only USB flash drives and USB devices that use the USB mass storage standard. Other USB devices are not supported.

Compatible Media	
USB Flash Drive	

Compatible USB Flash Drives	
USB Class	USB Mass Storage Class
USB Mass Storage Sub Class	SCSI or SFF-8070i
Transfer protocol	Bulk transfer Only
Format <sup>1</sup>	FAT12/FAT16/FAT32/exFAT
Sector size	Max. 4096 Byte
Encryption	Encrypted devices are not supported.

<sup>1</sup> NTFS format is not supported.



### Related Information

- [Print Data Directly from a USB Flash Drive](#)
- [Save Scanned Data to a USB Flash Drive](#)

## Print Photos Directly from a USB Flash Drive

Even if your machine is not connected to your computer, you can print photos directly from a USB Flash memory drive.

- [Important Information about Photo Printing](#)
- [Print Photos from a USB Flash Drive on the Brother Machine](#)

## Important Information about Photo Printing

Your machine is designed to be compatible with modern digital camera image files and USB flash drives. Read the points below to avoid photo printing problems:

- The image file extension must be .JPG (other image file extensions like .JPEG, .TIF, .GIF and so on will not be recognised).
- Direct photo printing must be performed separately from photo printing operations using the computer. (Simultaneous operation is not available.)
- The machine can read up to 999 files <sup>1</sup> on a USB flash drive.

Be aware of the following:

- When printing an index sheet or image, the machine will print all the valid images, even if one or more images have been corrupted. Corrupted images will not be printed.
- Your machine supports USB flash drives that have been formatted by Windows.



### Related Information

- [Print Photos Directly from a USB Flash Drive](#)

<sup>1</sup> The folder inside USB flash drives is also counted.

## **Print Photos from a USB Flash Drive on the Brother Machine**

- [Preview and Print Photos from a USB Flash Drive](#)
- [Print a Photo Index Sheet \(Thumbnails\) from a USB Flash Drive](#)
- [Print Photos by Image Number](#)
- [Print Photos with Auto Cropping](#)
- [Print Borderless Photos from a USB Flash Drive](#)
- [Print the Date from Your Photo's Data](#)
- [Print Settings for Photos](#)

## Preview and Print Photos from a USB Flash Drive

You can preview your photos on the LCD before printing them, or print images stored on a USB flash drive.

- If your photos are large files, there may be a delay before each photo is displayed.

1. Insert a USB flash drive in the USB slot.

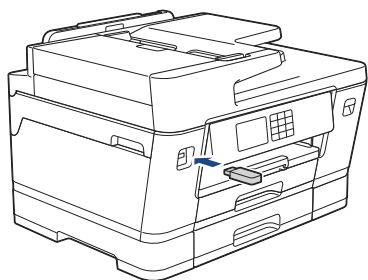

2. Press [JPEG Print] > [Select Files].
3. Press ◀ or ▶ to display the photo you want to print, and then press it.



To print all photos, press [Print All], and then press [Yes] to confirm.

4. Enter the number of copies in one of the following ways:
  - Press [-] or [+] on the touchscreen.
  - Press **x01** to display the keyboard on the touchscreen, and then enter the number of copies using the touchscreen keyboard. Press [OK].
  - Enter the number of copies using the dial pad.
5. Press [OK].
6. Repeat the last three steps until you have selected all the photos you want to print.
7. Press [OK].
8. Read and confirm the displayed list of options.
9. To change the print settings, press  [Print Settings].  
When finished, press [OK].
10. Press [Start].



### Related Information

- [Print Photos from a USB Flash Drive on the Brother Machine](#)

#### Related Topics:

- [Print Settings for Photos](#)

## Print a Photo Index Sheet (Thumbnails) from a USB Flash Drive

Print a photo Index Sheet to see small preview versions of all pictures on your USB flash drive.



- The machine assigns numbers for images (such as No.1, No.2, No.3, and so on).  
The machine does not recognise any other numbers or file names that your digital camera or computer has used to identify the pictures.
- Only file names that are 20 characters or less will be printed correctly on the index sheet.
- File names cannot be printed correctly if they contain non-alphanumeric characters, but non-alphanumeric characters do not affect photo print settings.

1. Insert a USB flash drive in the USB slot.
2. Press [JPEG Print] > [Index Print] > [Print Index Sheet].
3. If you want to change the print settings, press  [Print Settings].

When finished, press [OK].

Option	Description
Paper Type	Select the paper type.
Paper Size	Select the paper size.

4. Press [Start].



### Related Information

- [Print Photos from a USB Flash Drive on the Brother Machine](#)

#### Related Topics:

- [Print Photos by Image Number](#)

## Print Photos by Image Number

Before you can print an individual image, you must print the photo Index Sheet (thumbnails) to know the image number.

1. Insert a USB flash drive in the USB slot.
2. Press [JPEG Print] > [Index Print] > [Print Photos].
3. Enter the image numbers you want to print using the photo Index Sheet. After you have selected the image numbers, press [OK].



- Enter multiple numbers at one time using a comma or a hyphen. For example, enter **1, 3, 6** to print images No.1, No.3 and No.6. Print a range of images using a hyphen. For example, enter **1-5** to print images No.1 to No.5.
- Enter up to 12 characters (including commas and hyphens) for the image numbers you want to print.

4. Enter the number of copies in one of the following ways:
  - Press [-] or [+] on the touchscreen.
  - Press **x01** to display the keyboard on the touchscreen, and then enter the number of copies using the touchscreen keyboard. Press [OK].
  - Enter the number of copies using the dial pad.
5. To change the print settings, press  [Print Settings].

When finished, press [OK].

6. Press [Start].



### Related Information

- [Print Photos from a USB Flash Drive on the Brother Machine](#)

#### Related Topics:

- [Print a Photo Index Sheet \(Thumbnails\) from a USB Flash Drive](#)
- [Print Settings for Photos](#)

## Print Photos with Auto Cropping

If your photo is too long or too wide to fit within the layout space, part of the image will be cropped.

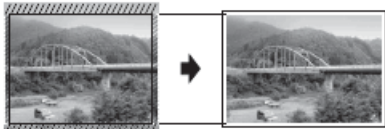

- The factory setting is On. To print the entire image, change this setting to Off.
- If you set the [Cropping] setting to Off, set the [Borderless] setting to Off, also.

### Cropping: On



### Cropping: Off



1. Insert a USB flash drive in the USB slot.
2. Press [JPEG Print] > [Select Files].
3. Press ◀ or ▶ to display each photo. When the photo you want appears, press it, and then press [OK].
4. Press [OK].
5. Press  [Print Settings] > [Cropping].
6. Press [On] (or [Off]).
7. When finished, press  or [OK].
8. Press [Start].

### Related Information



- [Print Photos from a USB Flash Drive on the Brother Machine](#)

#### Related Topics:

- [Other Problems](#)

## Print Borderless Photos from a USB Flash Drive

This feature expands the printable area to the edges of the paper. Printing time will be slower.

1. Insert a USB flash drive in the USB slot.
2. Press [JPEG Print] > [Select Files].
3. Press ◀ or ▶ to display each photo. When the photo you want appears, press it, and then press [OK].
4. Press [OK].
5. Press  [Print Settings] > [Borderless].
6. Press [On] (or [Off]).
7. When finished, press  or [OK].
8. Press [Start].



### Related Information



- [Print Photos from a USB Flash Drive on the Brother Machine](#)

#### Related Topics:

- [Other Problems](#)

## Print the Date from Your Photo's Data

Print the date if it is already in your photo's information. The date will be printed in the lower-right corner. To use this setting, the photo data must include the date.

1. Insert a USB flash drive in the USB slot.
2. Press [JPEG Print] > [Select Files].
3. Press ◀ or ▶ to display each photo. When the photo you want appears, press it, and then press [OK].
4. Press [OK].
5. Press  [Print Settings] > [Date Print].
6. Press [On] (or [Off]).
7. When finished, press  or [OK].
8. Press [Start].



### Related Information

- [Print Photos from a USB Flash Drive on the Brother Machine](#)

## Print Settings for Photos

Press  [Print Settings] to display the settings shown in the table.

Option	Description
Print Quality	Select the print resolution for your type of document. When you select the Inkjet Paper option in the Paper Type setting, you can select only Fine.
(MFC-J3940DW/MFC-J6555DW/ MFC-J6940DW/MFC-J6955DW/ MFC-J6957DW) Tray Select	Select the tray.
Paper Type	Select the paper type.
Paper Size	Select the paper size.
Print Layout	Select the print layout.
Brightness	Adjust the brightness.
Contrast	Adjust the contrast. Increasing the contrast will make an image look sharper and more vivid.
Cropping	Crop the image around the margin to fit the paper size or print size. Turn this feature off when you want to print whole images or prevent unwanted cropping.
Borderless	Expand the printable area to fit the edges of the paper.
Date Print	Print the date on your photo.
Set New Default	Save the print settings you use most often by setting them as the defaults.
Factory Reset	Restore any changed print settings back to the factory settings.

### Related Information

- [Print Photos from a USB Flash Drive on the Brother Machine](#)

#### Related Topics:

- [Preview and Print Photos from a USB Flash Drive](#)
- [Print Photos by Image Number](#)

## Print a PDF File Directly from a USB Flash Drive

**Related Models:** MFC-J6955DW/MFC-J6957DW

You can print a PDF file directly from a USB flash drive.



PDF files that are 2 GB or more cannot be printed.

### IMPORTANT

To prevent damage to your machine, DO NOT connect any device other than a USB flash drive to the USB direct interface.

1. Insert a USB flash drive in the USB slot.

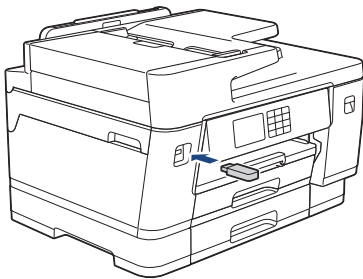

2. Press [PDF Print].



If your machine has been set to Secure Function Lock On, you may not be able to access Direct Print.

3. Press ▲ or ▼ to display the PDF file you want to print, and then press it.
4. Enter the number of copies in one of the following ways:
  - Press [-] or [+] on the touchscreen.
  - Press ×001 to display the keyboard on the touchscreen, and then enter the number of copies using the touchscreen keyboard. Press [OK].
  - Enter the number of copies using the dial pad.
5. Read and confirm the displayed list of options.
6. To change the print settings, press  [Print Settings].

When finished, press [OK].

Option	Description
Print Quality	Select the print resolution for your type of document.
Tray Select	Select the tray.
Paper Size	Select the paper size.
Multiple Page	Set this option to print multiple pages on a single sheet of paper or print one page of your document on multiple sheets.
2-sided	Select the type of 2-sided binding.
Collate	Set this option to On to print sets of multi-page documents in the original page order.

---

Option	Description
PDF Option	Select this option to print a PDF file with the markups or stamps.
Set New Default	Save the print settings you use most often by setting them as the defaults.
Factory Reset	Restore any changed print settings back to the factory settings.

---

7. Press [Mono Start] or [Colour Start].

## IMPORTANT

DO NOT remove the USB flash drive from the USB direct interface until the machine has finished printing.

---



## Related Information

- [Print Data Directly from a USB Flash Drive](#)
-

## Print an Email Attachment

You can print files by emailing them to your Brother machine.

- You can attach up to 10 documents, 20 MB in total, to an email.
- This feature supports the following formats:
  - Document files: PDF, TXT, Microsoft Word files, Microsoft Excel files, and Microsoft PowerPoint files
  - Image files: JPEG, BMP, GIF, PNG, and TIFF
- The machine prints both the email content and attachments by default. To print only email attachments, change the settings as necessary.

1. Press ◀ or ▶ to display [Apps].

Press [Apps].



- If information regarding the Internet connection appears on the machine's LCD, read it, and then press [OK].
- Occasionally, updates or announcements about Brother Web Connect's features will appear on the LCD. Read the information, and then press [OK].

2. Press ▲ or ▼ to display the [Online Functions] option, and then press it.



- If this function is locked, contact your Network Administrator for access.
- If information regarding [Online Functions] appears, read it, and then press [OK].

3. Press [Enable].

Follow the on-screen instructions. Online Functions are enabled.

4. Press ▲ or ▼ to display the [Email Print] option, and then press it.



If information regarding [Email Print] appears, read it, and then press [OK].

5. Press [Enable].

Follow the on-screen instructions. The machine prints the Instruction Sheet.

6. Send your email to the email address included on the sheet. The machine prints the email attachments.



To change settings, including email address and printer settings, access Web Based Management, click **Online Functions > Online Functions Settings** in the left navigation menu, and then click the **Online Functions Settings Page** button.



### Related Information

- [Print](#)

#### Related Topics:

- [Access Web Based Management](#)

## Scan

- [Scan Using the Scan Button on Your Machine](#)
- [Scan Using Brother iPrint&Scan \(Windows/Mac\)](#)
- [Scan from Your Computer \(Windows\)](#)
- [Scan from Your Computer \(Mac\)](#)
- [Configure Scan Settings Using Web Based Management](#)

## Scan Using the Scan Button on Your Machine

- [Scan Multi-page Letter or A4 Size Documents](#)
- [Scan Photos and Graphics](#)
- [Save Scanned Data to a Folder as a PDF File](#)
- [Save Scanned Data to a USB Flash Drive](#)
- [Scan Multiple Business Cards and Photos \(Auto Crop\)](#)
- [Scan to an Editable Text File Using OCR](#)
- [Save Scanned Data as an Email Attachment](#)
- [Send Scanned Data to an Email Recipient](#)
- [Scan to FTP](#)
- [Scan to SSH FTP \(SFTP\)](#)
- [Scan to Network \(Windows\)](#)
- [Scan to SharePoint](#)
- [Web Services for Scanning on Your Network \(Windows 7, Windows 8.1, and Windows 10\)](#)
- [Change Scan Settings Using Brother iPrint&Scan](#)

## Scan Multi-page Letter or A4 Size Documents

When scanning a multi-page A4 or letter size document, position the short edge on top for portrait documents and position the long edge on top for landscape documents.

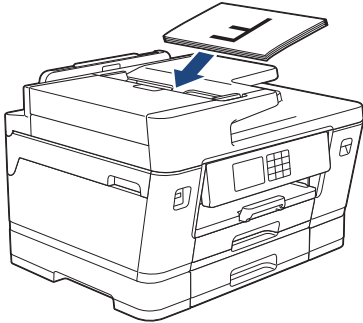
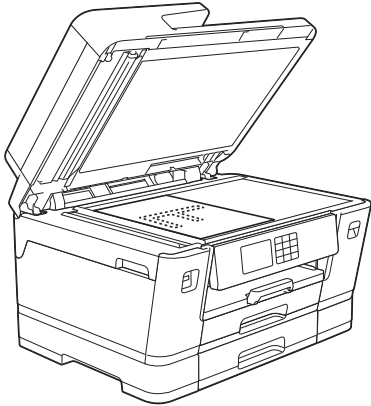
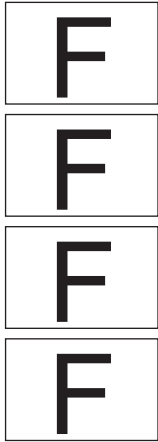
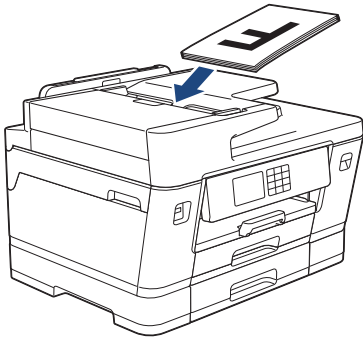
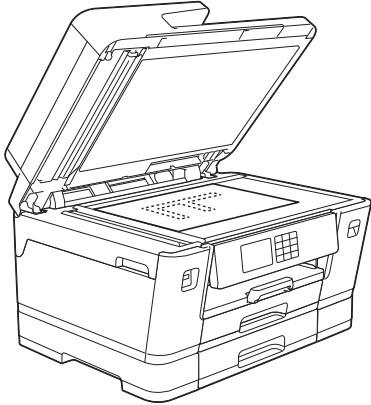
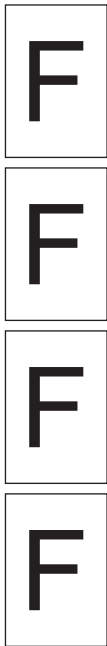
Orientation of the document	Scan result
<p>Long edge first</p> <p>ADF</p>  <p>Scanner glass</p> 	
<p>Short edge first</p> <p>ADF</p>  <p>Scanner glass</p> 	

### ✓ Related Information

- [Scan Using the Scan Button on Your Machine](#)

## Scan Photos and Graphics

Send scanned photos or graphics directly to your computer.

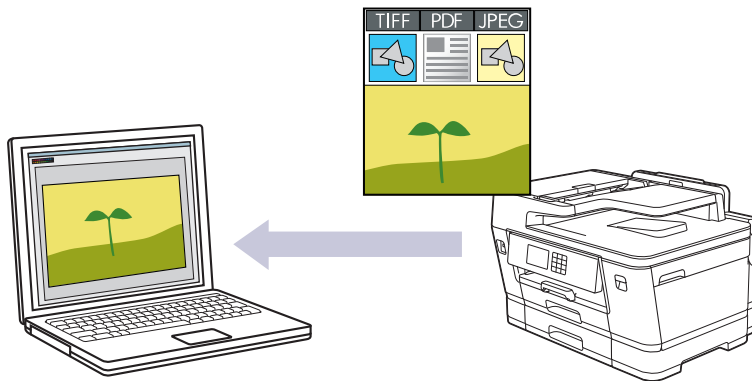



Use the Scan button on the machine to make temporary changes to the scan settings. To make permanent changes, use Brother iPrint&Scan.

1. Load your document.
2. Press [Scan] > [to PC] > [to Image].
3. If the machine is connected over the network, press ▲ or ▼ to display the computer where you want to send data, and then select the computer name.

 If the LCD message prompts you to enter a PIN, use the LCD to enter the four-digit PIN for the computer, and then press [OK].

4. To change the settings, press  [Options].

 To use  [Options], you must connect a computer with Brother iPrint&Scan installed to the machine.

5. Press [Scan Settings] > [Set at Device].
6. Select the scan settings you want to change, and then press [OK].

Option	Description
2-sided Scan (MFC-J3940DW/MFC-J6940DW/ MFC-J6955DW/MFC-J6957DW)	Select the 2-sided scan mode.
Colour Setting	Select the colour format for your document.
Resolution	Select the scan resolution for your document.
File Type	Select the file format for your document.
Document Size	Select your document size.
Brightness	Select the brightness level.
Contrast	Select the contrast level.
Auto Deskew	Correct any skewed documents when they are scanned.
Skip Blank Page	When On is selected, blank pages are skipped.
Remove Background Colour	Change the amount of background colour that is removed.



- To save the settings as a shortcut, press [Save as Shortcut]. You will be asked if you want to make this a One Touch Shortcut. Follow the LCD instructions.
- 

7. Press [Start].

The machine starts scanning. If using the machine's scanner glass, follow the LCD instructions to complete the scanning job.



### Related Information

- [Scan Using the Scan Button on Your Machine](#)
-

## Save Scanned Data to a Folder as a PDF File

Scan documents and save them to a folder on your computer as PDF files.

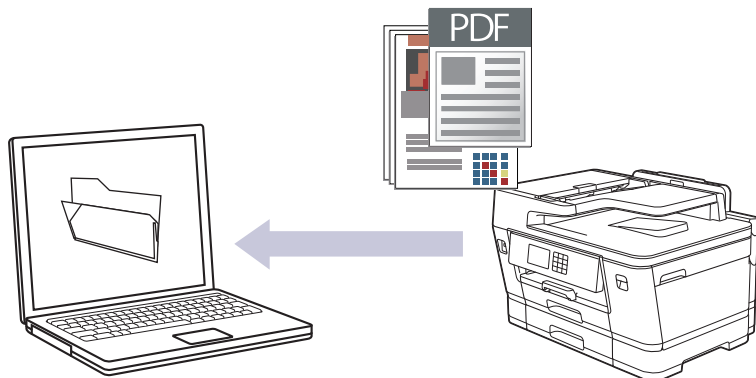

Use the Scan button on the machine to make temporary changes to the scan settings. To make permanent changes, use Brother iPrint&Scan.

1. Load your document.
2. Press [Scan] > [to PC] > [to File].
3. If the machine is connected over the network, press ▲ or ▼ to display the computer where you want to send data, and then select the computer name.



If the LCD message prompts you to enter a PIN, use the LCD to enter the four-digit PIN for the computer, and then press [OK].

4. To change the settings, press  [Options].



To use  [Options], you must connect a computer with Brother iPrint&Scan installed to the machine.

5. Press [Scan Settings] > [Set at Device].
6. Select the scan settings you want to change, and then press [OK].

Option	Description
2-sided Scan (MFC-J3940DW/MFC-J6940DW/ MFC-J6955DW/MFC-J6957DW)	Select the 2-sided scan mode.
Colour Setting	Select the colour format for your document.
Resolution	Select the scan resolution for your document.
File Type	Select the file format for your document.
Document Size	Select your document size.
Brightness	Select the brightness level.
Contrast	Select the contrast level.
Auto Deskew	Correct any skewed documents when they are scanned.
Skip Blank Page	When On is selected, blank pages are skipped.

---

**Option****Description**

Remove Background Colour

Change the amount of background colour that is removed.



- To save the settings as a shortcut, press [Save as Shortcut]. You will be asked if you want to make this a One Touch Shortcut. Follow the LCD instructions.

---

**7. Press [Start].**

The machine starts scanning. If using the machine's scanner glass, follow the LCD instructions to complete the scanning job.

**Related Information**

- [Scan Using the Scan Button on Your Machine](#)
-

## Save Scanned Data to a USB Flash Drive

Scan documents and save them directly to a USB flash drive without using a computer.

1. Load your document.
2. Insert a USB flash drive in the USB slot.

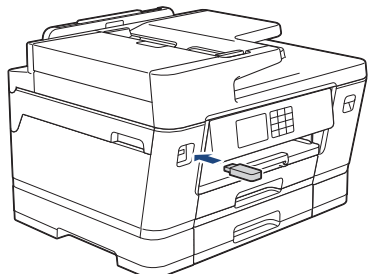

3. Press ▲ or ▼ to display the [Scan to Media] option, and then press it.
4. To change the settings, press  [Options], and then go to the next step.



- To set your own default settings: after making changes to settings, press the [Set New Default] option, and then press [Yes].
- To restore the factory settings: press the [Factory Reset] option, and then press [Yes].

5. Select the scan settings you want to change, and then press [OK].

Option	Description
2-sided Scan (MFC-J3940DW/ MFC-J6940DW/MFC-J6955DW/ MFC-J6957DW)	Select the 2-sided scan mode.
Colour Setting	Select the colour format for your document.
Resolution	Select the scan resolution for your document.
File Type	Select the file format for your document.
Document Size	Select your document size.
Brightness	Select the brightness level.
Contrast	Select the contrast level.
File Name	Rename the file.
File Name Style	Select the order in which the date, counter number, and other items appear in the file names.
Auto Crop	Scan multiple documents placed on the scanner glass to a USB flash drive. The machine will scan each document and create separate files or a single multi-page file.
Auto Deskew	Correct any skewed documents when they are scanned.
Skip Blank Page	When On is selected, blank pages are skipped.
Skip Blank Page Sensitivity	Select the sensitivity level for detecting blank pages in the scanned data. The higher the sensitivity, the easier it is for the machine to detect blank pages.

---

Option	Description
Remove Background Colour	Change the amount of background colour that is removed.
Margin Settings	Adjust your document's margins.

---



- To save the settings as a shortcut, press [Save as Shortcut]. You will be asked if you want to make this a One Touch Shortcut. Follow the LCD instructions.
- 

6. Press [Start].
7. If you are using the scanner glass, set the next page and then press [Continue]. If there are no more pages to scan, press [Finish]. After you finish scanning, make sure you choose [Finish] before removing the USB flash drive from the machine.

## IMPORTANT

The LCD displays a message while reading the data. DO NOT unplug the power cord or remove the USB flash drive from the machine while it is reading the data. You could lose your data or damage the USB flash drive.

---



## Related Information

- [Scan Using the Scan Button on Your Machine](#)
    - [Compatible USB Flash Drives](#)
-

## Compatible USB Flash Drives

Your Brother machine has a media drive (slot) for use with common data storage.

### IMPORTANT

The USB direct interface supports only USB flash drives and USB devices that use the USB mass storage standard. Other USB devices are not supported.

Compatible Media	
USB Flash Drive	

Compatible USB Flash Drives	
USB Class	USB Mass Storage Class
USB Mass Storage Sub Class	SCSI or SFF-8070i
Transfer protocol	Bulk transfer Only
Format <sup>1</sup>	FAT12/FAT16/FAT32/exFAT
Sector size	Max. 4096 Byte
Encryption	Encrypted devices are not supported.

<sup>1</sup> NTFS format is not supported.



### Related Information

- [Print Data Directly from a USB Flash Drive](#)
- [Save Scanned Data to a USB Flash Drive](#)

## Scan Multiple Business Cards and Photos (Auto Crop)

You can scan multiple documents placed on the scanner glass. The machine will scan each document and use the Auto Crop feature to create separate files or a single multi-page file.

### Guidelines for Auto Crop

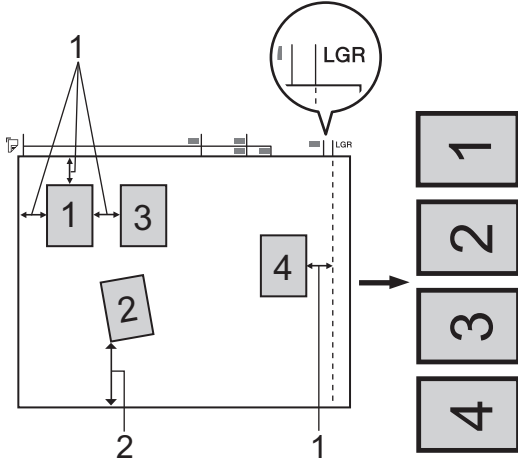

1. 10 mm or greater
2. 20 mm or greater (bottom)
  - This setting is available only for documents that are rectangular or square.
  - If your document is too long or wide, this feature will not work as described here.
  - You must place the documents away from the edges of the scanner glass as shown in the illustration.
  - You must place the documents at least 10 mm away from each other.
  - Auto Crop adjusts the skew of the document on the scanner glass; however, if your document is skewed more than 45 degrees at less than 300 x 300 dpi or 10 degrees at 600 x 600 dpi, this feature will not work.
  - The ADF must be empty to use Auto Crop.
  - The Auto Crop feature is available for a maximum of 32 documents, depending on the size of the documents.



To scan documents using the Auto Crop feature, you must place the documents on the scanner glass.

1. Load documents on the scanner glass.
2. Insert a USB flash drive into your machine.
3. Press [Scan to Media] >  [Options] > [Auto Crop].
4. Press [On].
5. Press [OK].
6. Press [Start].

The machine starts scanning. Follow the LCD instructions to complete the scanning job.



### Related Information

- [Scan Using the Scan Button on Your Machine](#)

## Scan to an Editable Text File Using OCR

Your machine can convert characters in a scanned document to text using optical character recognition (OCR) technology. You can edit this text using your preferred text-editing application.

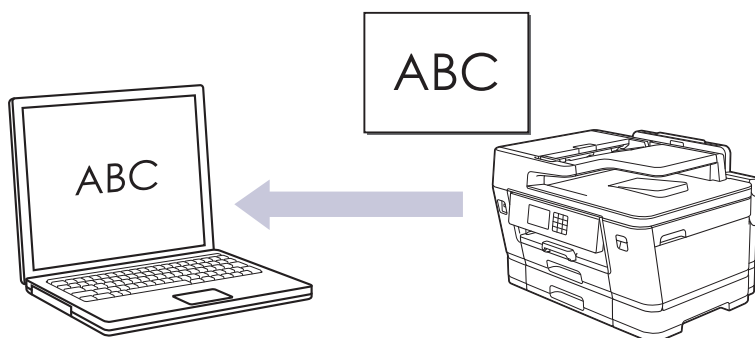

- The Scan to OCR feature is available for certain languages.
- Use the Scan button on the machine to make temporary changes to the scan settings. To make permanent changes, use Brother iPrint&Scan.

1. Load your document.
2. Press [Scan] > [to PC] > [to OCR].
3. If the machine is connected over the network, press ▲ or ▼ to display the computer where you want to send data, and then select the computer name.



If the LCD message prompts you to enter a PIN, use the LCD to enter the four-digit PIN for the computer, and then press [OK].

4. To change the settings, press  [Options].



To use  [Options], you must connect a computer with Brother iPrint&Scan installed to the machine.

5. Press [Scan Settings] > [Set at Device].
6. Select the scan settings you want to change, and then press [OK].

Option	Description
2-sided Scan (MFC-J3940DW/MFC-J6940DW/ MFC-J6955DW/MFC-J6957DW)	Select the 2-sided scan mode.
Colour Setting	Select the colour format for your document.
Resolution	Select the scan resolution for your document.
File Type	Select the file format for your document.
Document Size	Select your document size.
Brightness	Select the brightness level.
Contrast	Select the contrast level.
Auto Deskew	Correct any skewed documents when they are scanned.
Skip Blank Page	When On is selected, blank pages are skipped.

---

**Option****Description**

Remove Background Colour

Change the amount of background colour that is removed.



- To save the settings as a shortcut, press [Save as Shortcut]. You will be asked if you want to make this a One Touch Shortcut. Follow the LCD instructions.

---

**7. Press [Start].**

The machine starts scanning. If using the machine's scanner glass, follow the LCD instructions to complete the scanning job.

**Related Information**

- [Scan Using the Scan Button on Your Machine](#)
-

## Save Scanned Data as an Email Attachment

Send the scanned data from your machine to your email application as an attachment.

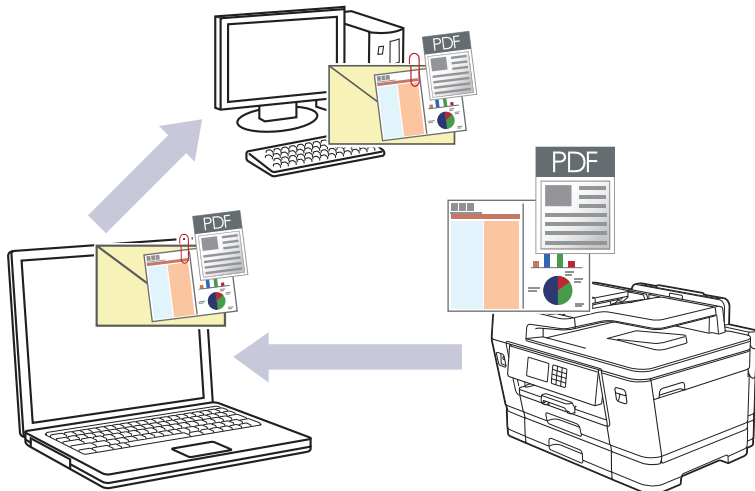



- Use the Scan button on the machine to make temporary changes to the scan settings. To make permanent changes, use Brother iPrint&Scan.
- To scan to email using the machine's Scan Button, make sure you select one of these applications in Brother iPrint&Scan:
  - Windows: Microsoft Outlook
  - Mac: Apple MailFor other applications and Webmail services, use the Scan to Image or Scan to File feature to scan a document, and then attach the scanned file to an email message.

1. Load your document.
2. Press [Scan] > [to PC] > [to E-mail].
3. If the machine is connected over the network, press ▲ or ▼ to display the computer where you want to send data, and then select the computer name.

 If the LCD message prompts you to enter a PIN, use the LCD to enter the four-digit PIN for the computer, and then press [OK].

4. To change the settings, press  [Options].

 To use  [Options], you must connect a computer with Brother iPrint&Scan installed to the machine.

5. Press [Scan Settings] > [Set at Device].
6. Select the scan settings you want to change, and then press [OK].

Option	Description
2-sided Scan (MFC-J3940DW/MFC-J6940DW/ MFC-J6955DW/MFC-J6957DW)	Select the 2-sided scan mode.
Colour Setting	Select the colour format for your document.
Resolution	Select the scan resolution for your document.

---

Option	Description
File Type	Select the file format for your document.
Document Size	Select your document size.
Brightness	Select the brightness level.
Contrast	Select the contrast level.
Auto Deskew	Correct any skewed documents when they are scanned.
Skip Blank Page	When On is selected, blank pages are skipped.
Remove Background Colour	Change the amount of background colour that is removed.



- To save the settings as a shortcut, press [Save as Shortcut]. You will be asked if you want to make this a One Touch Shortcut. Follow the LCD instructions.

7. Press [Start].

The machine scans the document and saves it as a file attachment. It then launches your email application and opens a new, blank email message with the scanned file attached.



### Related Information

- [Scan Using the Scan Button on Your Machine](#)
-

## Send Scanned Data to an Email Recipient

Send scanned data directly from your Brother machine to an email recipient without using a computer.

- To send scanned data to an email recipient, you must configure your machine to communicate with your network and email server, which is used to send and receive emails.
- You can configure these items from the machine's control panel or Web Based Management.
- To use the Scan to Email Server function, your machine needs to be connected to a network and have access to an SMTP server. You will need the following SMTP email settings before you can proceed:
  - Server address
  - Port number
  - User name
  - Encryption type (SSL or TLS)
  - Email server certificate (if used)

If you do not have these settings, contact your email service provider or network administrator.

1. Load your document.
2. Press [Scan] > [to E-mail Server].



(MFC-J6555DW/MFC-J6955DW/MFC-J6957DW)

- If you have registered your email address with your user ID, the [to My E-mail] button appears when you log on to the machine using Secure Function Lock, Active Directory Authentication or LDAP Authentication.
- To send scanned data to your email address, press [to My E-mail]. When your email address appears on the LCD, press [Next].
- To enable this feature in Web Based Management, click **Scan > Scan to E-mail Server** in the left navigation menu. In the **Send to My E-mail** field, select **On**.

3. Do one of the following to enter the destination email address:
  - To enter the email address manually, press [Manual], and then enter the email address using the character buttons on the LCD. When finished, press [OK].
  - If the email address is stored in the machine's address book, press [Address Book], and then select the email address.  
Press [OK].

4. Confirm the email address, and then press [Next].

5. To change the settings, press  [Options], and then go to the next step.



- To set your own default settings: after making changes to settings, press the [Set New Default] option, and then press [Yes].
- To restore the factory settings: press the [Factory Reset] option, and then press [Yes].

6. Select the scan settings you want to change, and then press [OK].

Option	Description
2-sided Scan (MFC-J3940DW/MFC-J6940DW/ MFC-J6955DW/MFC-J6957DW)	Select the 2-sided scan mode.
Colour Setting	Select the colour format for your document.

Option	Description
Resolution	Select the scan resolution for your document.
File Type	Select the file format for your document.
Document Size	Select your document size.
Brightness	Select the brightness level.
Contrast	Select the contrast level.
Margin Settings	Adjust your document's margins.
Preview (MFC-J6955DW/MFC-J6957DW)	Preview a scan result on the LCD, before the scanned data is saved.



- To save the settings as a shortcut, press [Save as Shortcut]. You will be asked if you want to make this a One Touch Shortcut. Follow the LCD instructions.
- (MFC-J6955DW/MFC-J6957DW) To preview the scanned results before the scanned data is saved, press  and then press [Preview]. The machine scans the document and displays the scanned results on the LCD. If the scanned results are fine, press [Start] to save it and to finish processing.

7. Press [Start].

The machine starts scanning. If using the machine's scanner glass, follow the LCD instructions to complete the scanning job.



### Related Information

- [Scan Using the Scan Button on Your Machine](#)

## Scan to FTP

Scan documents directly to an FTP server when you need to share the scanned information. For added convenience, configure different profiles to save your favourite Scan to FTP destinations.

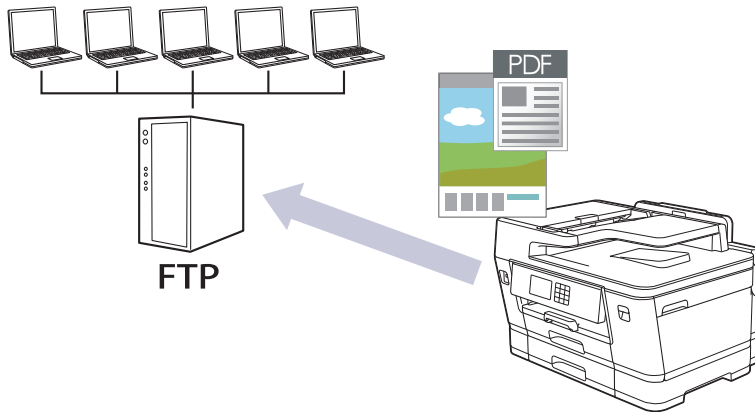

- [Set up a Scan to FTP Profile](#)
- [Upload Scanned Data to an FTP Server](#)

## Set up a Scan to FTP Profile

Set up a Scan to FTP Profile to scan and upload the scanned data directly to an FTP location.

We recommend Microsoft Internet Explorer 11/Microsoft Edge for Windows, Safari 13 for Mac, Google Chrome™ for Android (4.x or later), and Google Chrome™/Safari for iOS (10.x or later). Make sure that JavaScript and Cookies are always enabled in whichever browser you use.

1. Start your web browser.
2. Type "https://machine's IP address" in your browser's address bar (where "machine's IP address" is the machine's IP address).

For example:

https://192.168.1.2

3. If required, type the password in the **Login** field, and then click **Login**.



The default password to manage this machine's settings is located on the back of the machine and marked "Pwd".

4. (MFC-J3540DW/MFC-J3940DW/MFC-J6540DW/MFC-J6740DW/MFC-J6940DW) Go to the navigation menu, and then click **Scan > Scan to FTP/Network**.



Start from ≡, if the navigation menu is not shown on the left side of the screen.

5. (MFC-J6555DW/MFC-J6955DW/MFC-J6957DW) Go to the navigation menu, and then click **Scan > Scan to FTP/SFTP/Network/SharePoint**.



Start from ≡, if the navigation menu is not shown on the left side of the screen.

6. Select the **FTP** option, and then click **Submit**.
7. (MFC-J3540DW/MFC-J3940DW/MFC-J6540DW/MFC-J6740DW/MFC-J6940DW) Click the **Scan to FTP/Network Profile** menu.
8. (MFC-J6555DW/MFC-J6955DW/MFC-J6957DW) Click the **Scan to FTP/SFTP/Network/SharePoint Profile** menu.
9. Select the profile you want to set up or change.



Using the following characters: ?, /, \, ", :, <, >, | or \* may cause a sending error.

Option	Description
<b>Profile Name</b>	Type a name for this server profile (up to 15 alphanumeric characters). The machine will display this name on the LCD.
<b>Host Address</b>	Type the Host Address (for example: ftp.example.com; up to 64 characters) or the IP address (for example: 192.23.56.189).
<b>Port Number</b>	Change the <b>Port Number</b> setting used to access the FTP server. The default for this setting is port 21. In most cases this setting does not need to be changed.
<b>Username</b>	Type a user name (up to 32 characters) that has permission to write data to the FTP server.
<b>Password</b>	Type the password (up to 32 characters) associated with the user name you entered in the <b>Username</b> field. Type the password again in the <b>Retype password</b> field.
<b>SSL/TLS</b>	Set the <b>SSL/TLS</b> option to scan securely using SSL/TLS communication. Change the <b>CA Certificate</b> setting, if needed.

Option	Description
<b>Store Directory</b>	Type the path (up to 60 characters) to the folder on the FTP server where you want to send your scanned data. Do not type a slash mark at the beginning of the path (for example: brother/abc).
<b>File Name</b>	Select a file name from the preset names provided, or from user-defined names. You can set the user-defined names and file name style in the <b>Scan File Name</b> menu in the navigation menu.
<b>Quality</b>	Select a quality setting. If you choose the <b>User Select</b> option, the machine will prompt users to select a setting each time they use the scan profile.
<b>File Type</b>	Select the file type you want to use for the scanned document. If you choose the <b>User Select</b> option, the machine will prompt users to select a setting each time they use the scan profile.
<b>Document Size</b>	Select your document size from the list. This is necessary to make sure the scanned file is the correct size.
<b>Auto Deskew</b>	Select <b>On</b> to set the machine to correct document skewing automatically as the pages are scanned.
<b>Skip Blank Page</b>	Select the <b>On</b> option to remove blank pages of the document from the scanning results.
<b>Skip Blank Page Sensitivity</b>	Select the sensitivity level for detecting blank pages in the scanned data. The higher the sensitivity, the easier it is for the machine to detect blank pages.
<b>2-sided Scan</b> (MFC-J3940DW/ MFC-J6940DW/MFC-J6955DW/ MFC-J6957DW)	Select <b>Long Edge</b> or <b>Short Edge</b> to scan both sides of the document, depending on the layout of your original.
<b>Remove Background Colour</b>	Change the amount of background colour that is removed.
<b>Margin Settings</b>	Adjust your document's margins.
<b>Brightness</b>	Select the brightness level.
<b>Contrast</b>	Select the contrast level.
<b>Passive Mode</b>	Set the <b>Passive Mode</b> option to off or on depending on your FTP server and network firewall configuration. The default setting is on. In most cases this setting does not need to be changed.

10. Click **Submit**.



## Related Information

- [Scan to FTP](#)

### Related Topics:

- [Access Web Based Management](#)

## Upload Scanned Data to an FTP Server

>> MFC-J3540DW/MFC-J3940DW/MFC-J6540DW/MFC-J6740DW/MFC-J6940DW  
>> MFC-J6555DW/MFC-J6955DW/MFC-J6957DW

### MFC-J3540DW/MFC-J3940DW/MFC-J6540DW/MFC-J6740DW/MFC-J6940DW

1. Load your document.
2. Press [Scan] > [to FTP].
3. The server profiles you have set up using Web Based Management are listed. Select the profile you want. If the profile is not complete (for example, if the logon account name and password are missing, or if the quality or file type is not specified), you will be prompted to enter any missing information.
4. Press [Start].  
The machine starts scanning. If you are using the scanner glass, follow the Touchscreen instructions to complete the scanning job.

### MFC-J6555DW/MFC-J6955DW/MFC-J6957DW

1. Load your document.
2. Press [Scan] > [to FTP/SFTP].
3. The server profiles you have set up using Web Based Management are listed. Select the profile you want. If the profile is not complete (for example, if the logon account name and password are missing, or if the quality or file type is not specified), you will be prompted to enter any missing information.



(MFC-J6955DW/MFC-J6957DW) To preview the scanned results before the scanned data is saved, press  and then press [Preview]. The machine scans the document and displays the scanned results on the LCD. If the scanned results are fine, press [Start] to save it and to finish processing.

4. Press [Start].  
The machine starts scanning. If you are using the scanner glass, follow the Touchscreen instructions to complete the scanning job.

### ✓ Related Information

- [Scan to FTP](#)

## Scan to SSH FTP (SFTP)

**Related Models:** MFC-J6555DW/MFC-J6955DW/MFC-J6957DW

Scan documents directly to an SFTP server, a secure version of an FTP server. For added convenience, configure different profiles to save your favourite Scan to SFTP destinations.

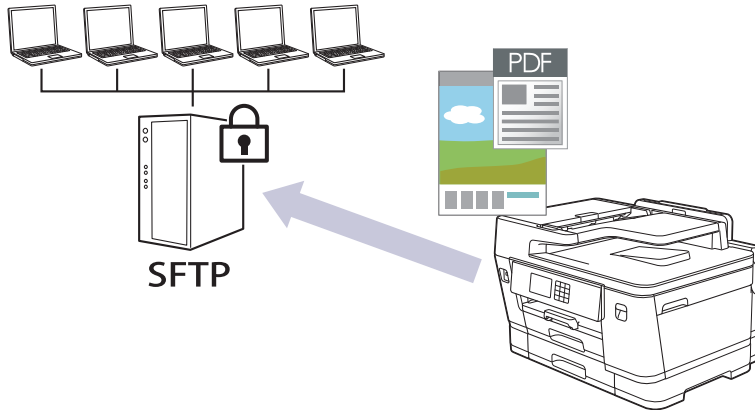

- [Set up a Scan to SFTP Profile](#)
- [Create a Client Key Pair Using Web Based Management](#)
- [Export a Client Key Pair Using Web Based Management](#)
- [Import a Server Public Key Using Web Based Management](#)
- [Upload Scanned Data to an SFTP Server](#)

## Set up a Scan to SFTP Profile

**Related Models:** MFC-J6555DW/MFC-J6955DW/MFC-J6957DW

Set up a Scan to SFTP Profile to scan and upload scanned data directly to an SFTP location.

We recommend Microsoft Internet Explorer 11/Microsoft Edge for Windows, Safari 13 for Mac, Google Chrome™ for Android (4.x or later), and Google Chrome™/Safari for iOS (10.x or later). Make sure that JavaScript and Cookies are always enabled in whichever browser you use.

1. Start your web browser.
2. Type "https://machine's IP address" in your browser's address bar (where "machine's IP address" is the machine's IP address).

For example:

https://192.168.1.2

3. If required, type the password in the **Login** field, and then click **Login**.



The default password to manage this machine's settings is located on the back of the machine and marked "Pwd".

4. Go to the navigation menu, and then click **Scan > Scan to FTP/SFTP/Network/SharePoint**.



Start from ☰, if the navigation menu is not shown on the left side of the screen.

5. Select the **SFTP** option, and then click **Submit**.
6. Click the **Scan to FTP/SFTP/Network/SharePoint Profile** menu.
7. Select the profile you want to set up or change.



Using the following characters: ?, /, \, ", :, <, >, | or \* may cause a sending error.

Option	Description
<b>Profile Name</b>	Type a name for this server profile (up to 15 alphanumeric characters). The machine will display this name on the LCD.
<b>Host Address</b>	Type the Host Address (for example: ftp.example.com; up to 64 characters) or the IP address (for example: 192.23.56.189).
<b>Username</b>	Type a user name (up to 32 characters) that has permission to write data to the SFTP server.
<b>Auth. Method</b>	Select <b>Password</b> or <b>Public Key</b> . Do one of the following: <ul style="list-style-type: none"><li>• When you select <b>Password</b>, type the password (up to 32 characters) associated with the user name you typed in the <b>Username</b> field. Type the password again in the <b>Retype password</b> field.</li><li>• When you select <b>Public Key</b>, select the authentication type from the <b>Client Key Pair</b> drop-down list.</li></ul>
<b>Server Public Key</b>	Select the authentication type.
<b>Store Directory</b>	Type the path (up to 60 characters) to the folder on the SFTP server where you want to send your scanned data. Do not type a slash mark at the beginning of the path (for example: brother/abc).

Option	Description
<b>File Name</b>	Select a file name from the preset names provided, or from user-defined names. You can set the user-defined names and file name style in the <b>Scan File Name</b> menu in the navigation menu.
<b>Quality</b>	Select a quality setting. If you choose the <b>User Select</b> option, the machine will prompt users to select a setting each time they use the scan profile.
<b>File Type</b>	Select the file type you want to use for the scanned document. If you choose the <b>User Select</b> option, the machine will prompt users to select a setting each time they use the scan profile.
<b>Document Size</b>	Select your document size from the list. This is necessary to make sure the scanned file is the correct size.
<b>Auto Deskew</b>	Select <b>On</b> to set the machine to correct document skewing automatically as the pages are scanned.
<b>Skip Blank Page</b>	Select the <b>On</b> option to remove blank pages of the document from the scanning results.
<b>Skip Blank Page Sensitivity</b>	Select the sensitivity level for detecting blank pages in the scanned data. The higher the sensitivity, the easier it is for the machine to detect blank pages.
<b>2-sided Scan</b> (MFC-J6955DW/ MFC-J6957DW)	Select <b>Long Edge</b> or <b>Short Edge</b> to scan both sides of the document, depending on the layout of your original.
<b>Remove Background Colour</b>	Change the amount of background colour that is removed.
<b>Margin Settings</b>	Adjust your document's margins.
<b>Brightness</b>	Select the brightness level.
<b>Contrast</b>	Select the contrast level.
<b>Port Number</b>	Change the <b>Port Number</b> setting used to access the SFTP server. The default for this setting is port 22. In most cases this setting does not need to be changed.

8. Click **Submit**.

### Related Information

- [Scan to SSH FTP \(SFTP\)](#)

#### Related Topics:

- [Access Web Based Management](#)

## Create a Client Key Pair Using Web Based Management

**Related Models:** MFC-J6555DW/MFC-J6955DW/MFC-J6957DW

1. Start your web browser.
2. Type "https://machine's IP address" in your browser's address bar (where "machine's IP address" is the machine's IP address).

For example:

https://192.168.1.2



- If you are using a Domain Name System or enable a NetBIOS name, you can type another name, such as "SharedPrinter" instead of the IP address.

- For example:

https://SharedPrinter

If you enable a NetBIOS name, you can also use the node name.

- For example:

https://brnxxxxxxxxxxxx

The NetBIOS name can be found in the Network Configuration Report.

3. If required, type the password in the **Login** field, and then click **Login**.



The default password to manage this machine's settings is located on the back of the machine and marked "Pwd".

4. Go to the navigation menu, and then click **Network > Security > Client Key Pair**.



Start from , if the navigation menu is not shown on the left side of the screen.

5. Click **Create New Client Key Pair**.
6. In the **Client Key Pair Name** field, type the name (up to 20 characters) you want.
7. Click the **Public Key Algorithm** drop-down list, and then select the algorithm you want.
8. Click **Submit**.

The client key pair is created and saved in your machine's memory. The client key pair name and public key algorithm will be displayed in the **Client Key Pair List**.



### Related Information

- [Scan to SSH FTP \(SFTP\)](#)

#### Related Topics:

- [Access Web Based Management](#)

## Export a Client Key Pair Using Web Based Management

**Related Models:** MFC-J6555DW/MFC-J6955DW/MFC-J6957DW

1. Start your web browser.
2. Type "https://machine's IP address" in your browser's address bar (where "machine's IP address" is the machine's IP address).

For example:

https://192.168.1.2



- If you are using a Domain Name System or enable a NetBIOS name, you can type another name, such as "SharedPrinter" instead of the IP address.

- For example:

https://SharedPrinter

If you enable a NetBIOS name, you can also use the node name.

- For example:

https://brnxxxxxxxxxxxx

The NetBIOS name can be found in the Network Configuration Report.

3. If required, type the password in the **Login** field, and then click **Login**.



The default password to manage this machine's settings is located on the back of the machine and marked "Pwd".

4. Go to the navigation menu, and then click **Network > Security > Client Key Pair**.



Start from ☰, if the navigation menu is not shown on the left side of the screen.

5. Click **Export Public Key** shown with **Client Key Pair List**.
6. Click **Submit**.
7. Specify the location where you want to save the file.

The client key pair is exported to your computer.



### Related Information

- [Scan to SSH FTP \(SFTP\)](#)

#### Related Topics:

- [Access Web Based Management](#)

## Import a Server Public Key Using Web Based Management

**Related Models:** MFC-J6555DW/MFC-J6955DW/MFC-J6957DW

1. Start your web browser.
2. Type "https://machine's IP address" in your browser's address bar (where "machine's IP address" is the machine's IP address).

For example:

https://192.168.1.2



- If you are using a Domain Name System or enable a NetBIOS name, you can type another name, such as "SharedPrinter" instead of the IP address.

- For example:

https://SharedPrinter

If you enable a NetBIOS name, you can also use the node name.

- For example:

https://brnxxxxxxxxxxxx

The NetBIOS name can be found in the Network Configuration Report.

3. If required, type the password in the **Login** field, and then click **Login**.



The default password to manage this machine's settings is located on the back of the machine and marked "Pwd".

4. Go to the navigation menu, and then click **Network > Security > Server Public Key**.



Start from , if the navigation menu is not shown on the left side of the screen.

5. Click **Import Server Public Key**.
6. Specify the file that you want to import.
7. Click **Submit**.

The server public key is imported to your machine.



### Related Information

- [Scan to SSH FTP \(SFTP\)](#)

#### Related Topics:

- [Access Web Based Management](#)

## Upload Scanned Data to an SFTP Server

**Related Models:** MFC-J6555DW/MFC-J6955DW/MFC-J6957DW

1. Load your document.
2. Press [Scan] > [to FTP/SFTP].
3. The server profiles you have set up using Web Based Management are listed. Select the profile you want. If the profile is not complete (for example, if the logon account name and password are missing, or if the quality or file type is not specified), you will be prompted to enter any missing information.



---

(MFC-J6955DW/MFC-J6957DW) To preview the scanned results before the scanned data is saved, press  and then press [Preview]. The machine scans the document and displays the scanned results on the LCD. If the scanned results are fine, press [Start] to save it and to finish processing.

---

4. Press [Start].

The machine starts scanning. If you are using the scanner glass, follow the Touchscreen instructions to complete the scanning job.



### Related Information

- [Scan to SSH FTP \(SFTP\)](#)

## Scan to Network (Windows)

Scan documents directly to a CIFS server on your local network. For added convenience, you can configure different profiles to save your favourite Scan to Network destinations.

- [Set up a Scan to Network Profile](#)
- [Upload Scanned Data to a CIFS Server](#)

## Set up a Scan to Network Profile

Set up a Scan to Network Profile to scan and upload scanned data directly to a folder on a CIFS server.

We recommend Microsoft Internet Explorer 11/Microsoft Edge for Windows, Safari 13 for Mac, Google Chrome™ for Android (4.x or later), and Google Chrome™/Safari for iOS (10.x or later). Make sure that JavaScript and Cookies are always enabled in whichever browser you use.

1. Start your web browser.
2. Type "https://machine's IP address" in your browser's address bar (where "machine's IP address" is the machine's IP address).

For example:

https://192.168.1.2

3. If required, type the password in the **Login** field, and then click **Login**.



The default password to manage this machine's settings is located on the back of the machine and marked "Pwd".

4. (MFC-J3540DW/MFC-J3940DW/MFC-J6540DW/MFC-J6740DW/MFC-J6940DW) Go to the navigation menu, and then click **Scan > Scan to FTP/Network**.



Start from ☰, if the navigation menu is not shown on the left side of the screen.

5. (MFC-J6555DW/MFC-J6955DW/MFC-J6957DW) Go to the navigation menu, and then click **Scan > Scan to FTP/SFTP/Network/SharePoint**.



Start from ☰, if the navigation menu is not shown on the left side of the screen.

6. Select the **Network** option, and then click **Submit**.



(MFC-J6555DW/MFC-J6955DW/MFC-J6957DW)

If you want to send the data to your designated folder on the CIFS server, select **On** for the **Send to My Folder** option.

7. (MFC-J3540DW/MFC-J3940DW/MFC-J6540DW/MFC-J6740DW/MFC-J6940DW) Click the **Scan to FTP/Network Profile** menu.
8. (MFC-J6555DW/MFC-J6955DW/MFC-J6957DW) Click the **Scan to FTP/SFTP/Network/SharePoint Profile** menu.
9. Select the profile you want to set up or change.



Using the following characters: ?, /, \, ", :, <, >, | or \* may cause a sending error.

Option	Description
<b>Profile Name</b>	Type a name for this server profile (up to 15 alphanumeric characters). The machine will display this name on the LCD.
<b>Network Folder Path</b>	Type the path to the folder on the CIFS server where you want to send your scanned data.
<b>File Name</b>	Select a file name from the preset names provided, or from user-defined names. You can set the user-defined names and file name style in the <b>Scan File Name</b> menu in the navigation menu.
<b>Quality</b>	Select a quality setting. If you choose the <b>User Select</b> option, the machine will prompt users to select a setting each time they use the scan profile.

Option	Description
<b>File Type</b>	Select the file type you want to use for the scanned document. If you choose the <b>User Select</b> option, the machine will prompt users to select a setting each time they use the scan profile.
<b>Document Size</b>	Select your document size from the list. This is necessary to make sure the scanned file is the correct size.
<b>Auto Deskew</b>	Select <b>On</b> to set the machine to correct document skewing automatically as the pages are scanned.
<b>Skip Blank Page</b>	Select the <b>On</b> option to remove blank pages of the document from the scanning results.
<b>Skip Blank Page Sensitivity</b>	Select the sensitivity level for detecting blank pages in the scanned data. The higher the sensitivity, the easier it is for the machine to detect blank pages.
<b>2-sided Scan</b> (MFC-J3940DW/ MFC-J6940DW/MFC-J6955DW/ MFC-J6957DW)	Select <b>Long Edge</b> or <b>Short Edge</b> to scan both sides of the document, depending on the layout of your original.
<b>Remove Background Colour</b>	Change the amount of background colour that is removed.
<b>Margin Settings</b>	Adjust your document's margins.
<b>Brightness</b>	Select the brightness level.
<b>Contrast</b>	Select the contrast level.
<b>Use PIN for Authentication</b>	To PIN-protect this profile, select <b>On</b> , and then type a four-digit PIN in the <b>PIN Code</b> field.
<b>Auth. Method</b>	Select the authentication method.
<b>Username</b>	Type a user name (up to 96 characters) that has permission to write data to the folder specified in the <b>Network Folder Path</b> field. If the user name is part of a domain, type the user name in one of the following styles: <b>user@domain</b> <b>domain\user</b>
<b>Password</b>	Type the password (up to 32 characters) associated with the user name you entered in the <b>Username</b> field. Type the password again in the <b>Retype password</b> field.
<b>Kerberos Server Address</b>	Type the Kerberos Server Address (for example: kerberos.example.com; up to 64 characters).

10. Click **Submit**.

11. You must configure the SNTP (network time server) or you must set the date, time and time zone correctly on the control panel. The time must match the time used by the Kerberos Server and CIFS Server.



## Related Information

- [Scan to Network \(Windows\)](#)

### Related Topics:

- [Configure Date and Time Using Web Based Management](#)
- [Access Web Based Management](#)

## Upload Scanned Data to a CIFS Server

1. Load your document.
2. Press [Scan] > [to Network].



(MFC-J6555DW/MFC-J6955DW/MFC-J6957DW)

- If you registered your user ID, the [to My Folder] option appears when you log on to the machine using Active Directory Authentication or LDAP Authentication.
- To send scanned data to your designated folder on the CIFS server, press [to My Folder].
- To enable this feature in Web Based Management, go to the navigation menu, and then click **Scan > Scan to FTP/SFTP/Network/SharePoint**. In the **Send to My Folder** field, select **On**.

3. The server profiles you have set up using Web Based Management are listed. Select the profile you want. If the profile is not complete (for example, if the logon account name and password are missing, or if the quality or file type is not specified), you will be prompted to enter any missing information.



(MFC-J6955DW/MFC-J6957DW) To preview the scanned results before the scanned data is saved, press  and then press [Preview]. The machine scans the document and displays the scanned results on the LCD. If the scanned results are fine, press [Start] to save it and to finish processing.

4. Press [Start].

The machine starts scanning. If you are using the scanner glass, follow the Touchscreen instructions to complete the scanning job.



### Related Information

- [Scan to Network \(Windows\)](#)

## Scan to SharePoint

**Related Models:** MFC-J6555DW/MFC-J6955DW/MFC-J6957DW

Scan documents directly to a SharePoint server when you need to share the scanned information. For added convenience, configure different profiles to save your favourite Scan to SharePoint destinations.

- [Set up a Scan to SharePoint Profile](#)
- [Upload Scanned Data to a SharePoint Server](#)

## Set up a Scan to SharePoint Profile

**Related Models:** MFC-J6555DW/MFC-J6955DW/MFC-J6957DW

Set up a Scan to SharePoint Profile to scan and upload the scanned data directly to a SharePoint location.

We recommend Microsoft Internet Explorer 11/Microsoft Edge for Windows, Safari 13 for Mac, Google Chrome™ for Android (4.x or later), and Google Chrome™/Safari for iOS (10.x or later). Make sure that JavaScript and Cookies are always enabled in whichever browser you use.

1. Start your web browser.
2. Type "https://machine's IP address" in your browser's address bar (where "machine's IP address" is the machine's IP address).

For example:

https://192.168.1.2

3. If required, type the password in the **Login** field, and then click **Login**.



The default password to manage this machine's settings is located on the back of the machine and marked "Pwd".

4. Go to the navigation menu, and then click **Scan > Scan to FTP/SFTP/Network/SharePoint**.



Start from ☰, if the navigation menu is not shown on the left side of the screen.

5. Select the **SharePoint** option, and then click **Submit**.
6. Click the **Scan to FTP/SFTP/Network/SharePoint Profile** menu.
7. Select the profile you want to set up or change.



Using the following characters: ?, /, \, ", :, <, >, | or \* may cause a sending error.

Option	Description
<b>Profile Name</b>	Type a name for this server profile (up to 15 alphanumeric characters). The machine will display this name on the LCD.
<b>SharePoint Site Address</b>	Copy and paste the full destination address shown in the address bar of your browser (for example: http://SharePointSiteAddress/Shared%20Documents/Forms/AllItems.aspx) or the IP address (for example: http://192.168.0.1/Shared%20Documents/Forms/AllItems.aspx).
<b>File Name</b>	Select a file name from the preset names provided, or from user-defined names. You can set the user-defined names and file name style in the <b>Scan File Name</b> menu in the navigation menu.
<b>Quality</b>	Select a quality setting. If you choose the <b>User Select</b> option, the machine will prompt users to select a setting each time they use the scan profile.
<b>File Type</b>	Select the file type you want to use for the scanned document. If you choose the <b>User Select</b> option, the machine will prompt users to select a setting each time they use the scan profile.
<b>Document Size</b>	Select your document size from the list. This is necessary to make sure the scanned file is the correct size.
<b>Auto Deskew</b>	Select <b>On</b> to set the machine to correct document skewing automatically as the pages are scanned.
<b>Skip Blank Page</b>	Select the <b>On</b> option to remove blank pages of the document from the scanning results.

Option	Description
<b>Skip Blank Page Sensitivity</b>	Select the sensitivity level for detecting blank pages in the scanned data. The higher the sensitivity, the easier it is for the machine to detect blank pages.
<b>2-sided Scan</b> (MFC-J6955DW/ MFC-J6957DW)	Select <b>Long Edge</b> or <b>Short Edge</b> to scan both sides of the document, depending on the layout of your original.
<b>Remove Background Colour</b>	Change the amount of background colour that is removed.
<b>Margin Settings</b>	Adjust your document's margins.
<b>Brightness</b>	Select the brightness level.
<b>Contrast</b>	Select the contrast level.
<b>Use PIN for Authentication</b>	To PIN-protect this profile, select <b>On</b> , and then type a four-digit PIN in the <b>PIN Code</b> field.
<b>Auth. Method</b>	Select the authentication method. If you select <b>Auto</b> , the authentication method will be automatically detected.
<b>Username</b>	Type a user name (up to 96 characters) that has permission to write data to the folder specified in the <b>SharePoint Site Address</b> field. If the user name is part of a domain, type the user name in one of the following styles: <b>user@domain</b> <b>domain\user</b>
<b>Password</b>	Type the password (up to 32 characters) associated with the user name you entered in the <b>Username</b> field. Type the password again in the <b>Retype password</b> field.
<b>Kerberos Server Address</b>	Type the Kerberos Server Address (for example: kerberos.example.com; up to 64 characters).

8. Click **Submit**.



## Related Information

- [Scan to SharePoint](#)

### Related Topics:

- [Access Web Based Management](#)

## Upload Scanned Data to a SharePoint Server

**Related Models:** MFC-J6555DW/MFC-J6955DW/MFC-J6957DW

1. Load your document.
2. Press [Scan] > [to SharePoint].
3. The server profiles you have set up using Web Based Management are listed. Select the profile you want. If the profile is not complete (for example, if the logon account name and password are missing, or if the quality or file type is not specified), you will be prompted to enter any missing information.



(MFC-J6955DW/MFC-J6957DW) To preview the scanned results before the scanned data is saved, press  and then press [Preview]. The machine scans the document and displays the scanned results on the LCD. If the scanned results are fine, press [Start] to save it and to finish processing.

4. Press [Start].

The machine starts scanning. If you are using the scanner glass, follow the Touchscreen instructions to complete the scanning job.



### Related Information

- [Scan to SharePoint](#)

## Web Services for Scanning on Your Network (Windows 7, Windows 8.1, and Windows 10)

The Web Services protocol enables Windows 7, Windows 8.1 and Windows 10 users to scan using a Brother machine on the network. You must install the driver via Web Services.

- [Use Web Services to Install Drivers Used for Scanning \(Windows 7, Windows 8.1, and Windows 10\)](#)
- [Scan Using Web Services from Your Machine \(Windows 7, Windows 8.1, and Windows 10\)](#)
- [Configure Scan Settings for Web Services](#)

## Use Web Services to Install Drivers Used for Scanning (Windows 7, Windows 8.1, and Windows 10)

- Make sure you have installed the correct software and drivers for your machine.
- Verify that the host computer and the Brother machine are on the same subnet, or that the router is correctly configured to pass data between the two devices.
- You must configure the IP address on your Brother machine before you configure this setting.

1. Do one of the following:

- Windows 10

Click  > **Windows System** > **Control Panel**. In the **Hardware and Sound** group, click **Add a device**.

- Windows 8.1

Move your mouse to the lower right corner of your desktop. When the menu bar appears, click **Settings** > **Change PC settings** > **PC and devices** > **Devices** > **Add a device**.

The machine's Web Services Name appears.

- Windows 7

Click  (**Start**) > **Control Panel** > **Network and Internet** > **View network computers and devices**.

The machine's Web Services Name appears with the printer icon.

Right-click the machine you want to install.



- The Web Services Name for the Brother machine is your model name and the MAC Address (Ethernet Address) of your machine (for example, Brother XXX-XXXX (where XXX-XXXX is the name of your model) [XXXXXXXXXXXX] (MAC Address / Ethernet Address)).

- Windows 8.1/Windows 10

Move your mouse over the machine name to display the machine's information.

2. Do one of the following:

- Windows 8.1/Windows 10

Select the machine you want to install, and then follow the on-screen instructions.

- Windows 7

Click **Install** in the displayed menu.



To uninstall drivers, click **Uninstall** or  (**Remove device**).



### Related Information

- [Web Services for Scanning on Your Network \(Windows 7, Windows 8.1, and Windows 10\)](#)

## Scan Using Web Services from Your Machine (Windows 7, Windows 8.1, and Windows 10)

If you have installed the driver for scanning via Web Services, you can access the Web Services scanning menu on your Brother machine's LCD.

- Certain characters in the messages displayed on the LCD may be replaced with spaces if the language settings of your OS and your Brother machine are different.
- If the LCD displays an insufficient memory error message, choose a smaller size in the **Paper size** setting or a lower resolution in the **Resolution (DPI)** setting.

1. Load your document.
2. Press [Scan] > [WS Scan].
3. Press ▲ or ▼ to select the type of scan you want, and then press it.
4. Press ▲ or ▼ to display the computer where you want to send data, and then select the computer name.
5. Press [Start].

The machine starts scanning.



### Related Information

- [Web Services for Scanning on Your Network \(Windows 7, Windows 8.1, and Windows 10\)](#)

## Configure Scan Settings for Web Services

1. Do one of the following:

- Windows 10

Click  > **Windows System** > **Control Panel**. In the **Hardware and Sound** group, click **View devices and printers**.

- Windows 8.1

Move your mouse to the lower right corner of your desktop. When the menu bar appears, click **Settings**, and then click **Control Panel**. In the **Hardware and Sound** group, click **View devices and printers**.

- Windows 7

Click  (**Start**) > **Devices and Printers**.

2. Right-click the machine icon, and then select **Scan profiles....** The **Scan Profiles** dialog box appears.

3. Select the scan profile you want to use.

4. Make sure the scanner selected in the **Scanner** list is a machine that supports Web Services for scanning, and then click the **Set as Default** button.

5. Click **Edit...**

The **Edit Default Profile** dialog box appears.

6. Select the **Source**, **Paper size**, **Colour format**, **File type**, **Resolution (DPI)**, **Brightness** and **Contrast** settings.

7. Click the **Save Profile** button.

These settings will be applied when you scan using the Web Services protocol.

If you are requested to select a scanning application, select Windows Fax and Scan from the list.



### Related Information

- [Web Services for Scanning on Your Network \(Windows 7, Windows 8.1, and Windows 10\)](#)

## Change Scan Settings Using Brother iPrint&Scan

Brother iPrint&Scan allows you to change the machine's Scan Button settings.

1. Start Brother iPrint&Scan.

- Windows

Launch  (Brother iPrint&Scan).

- Mac

In the **Finder** menu bar, click **Go > Applications**, and then double-click the iPrint&Scan icon.

The Brother iPrint&Scan screen appears.

2. If your Brother machine is not selected, click the **Select your Machine** button, and then select your model name from the list. Click **OK**.
3. Click the **Machine Scan Settings** button, and then follow the on-screen instructions to change the scan settings, such as document size, colour, and resolution.



### Related Information

- [Scan Using the Scan Button on Your Machine](#)

#### Related Topics:

- [Scan Using Brother iPrint&Scan \(Windows/Mac\)](#)

## Scan Using Brother iPrint&Scan (Windows/Mac)

1. Start Brother iPrint&Scan.

- Windows

Launch  (**Brother iPrint&Scan**).

- Mac

In the **Finder** menu bar, click **Go > Applications**, and then double-click the iPrint&Scan icon.

The Brother iPrint&Scan screen appears.

2. If your Brother machine is not selected, click the **Select your Machine** button, and then select your model name from the list. Click **OK**.
3. Click the **Scan** icon, and then follow the on-screen instructions to scan your documents.



### Related Information

- [Scan](#)
-

## Scan from Your Computer (Windows)

There are several ways you can use your computer to scan photos and documents on your machine. Use the software applications we provide or use your favourite scanning application.

- [Scan Using Nuance™ PaperPort™ 14SE or Other Windows Applications](#)
- [Scan Using Windows Fax and Scan](#)



## Scan Using Nuance™ PaperPort™ 14SE or Other Windows Applications

You can use the Nuance™ PaperPort™ 14SE application for scanning.

- To download the Nuance™ PaperPort™ 14SE application, click  (**Brother Utilities**), select **Do More** in the left navigation bar, and then click **PaperPort**.
- Nuance™ PaperPort™ 14SE supports Windows 7, Windows 8.1, Windows 10 Home, Windows 10 Pro, Windows 10 Education and Windows 10 Enterprise.
- For detailed instructions on using each application, click the application's **Help** menu, and then click **Getting Started Guide** in the **Help** ribbon.



The instructions for scanning in these steps are for PaperPort™ 14SE. For other Windows applications, the steps will be similar. PaperPort™ 14SE supports both TWAIN and WIA drivers; the TWAIN driver (recommended) is used in these steps.

- Depending on the model of your machine, Nuance™ PaperPort™ 14SE may not be included. If it is not included, you can use other software applications that support scanning.
1. Load your document.
  2. Start PaperPort™ 14SE.  
Do one of the following:
    - Windows 10  
Click  > **Nuance PaperPort 14 > PaperPort**.
    - Windows 8.1  
Click  (**PaperPort**).
    - Windows 7  
Using your computer, click  (**Start**) > **All Programs > Nuance PaperPort 14 > PaperPort**.
  3. Click the **Desktop** menu, and then click **Scan Settings** in the **Desktop** ribbon.  
The **Scan or Get Photo** panel appears on the left side of the screen.
  4. Click **Select**.
  5. From the available Scanners list, select **TWAIN: TW-Brother XXX-XXXX** or **TWAIN: TW-Brother XXX-XXXX LAN** (where XXX-XXXX is the name of your model).
  6. Select the **Display scanner dialog box** check box in the **Scan or Get Photo** panel.
  7. Click **Scan**.  
The Scanner Setup dialog box appears.

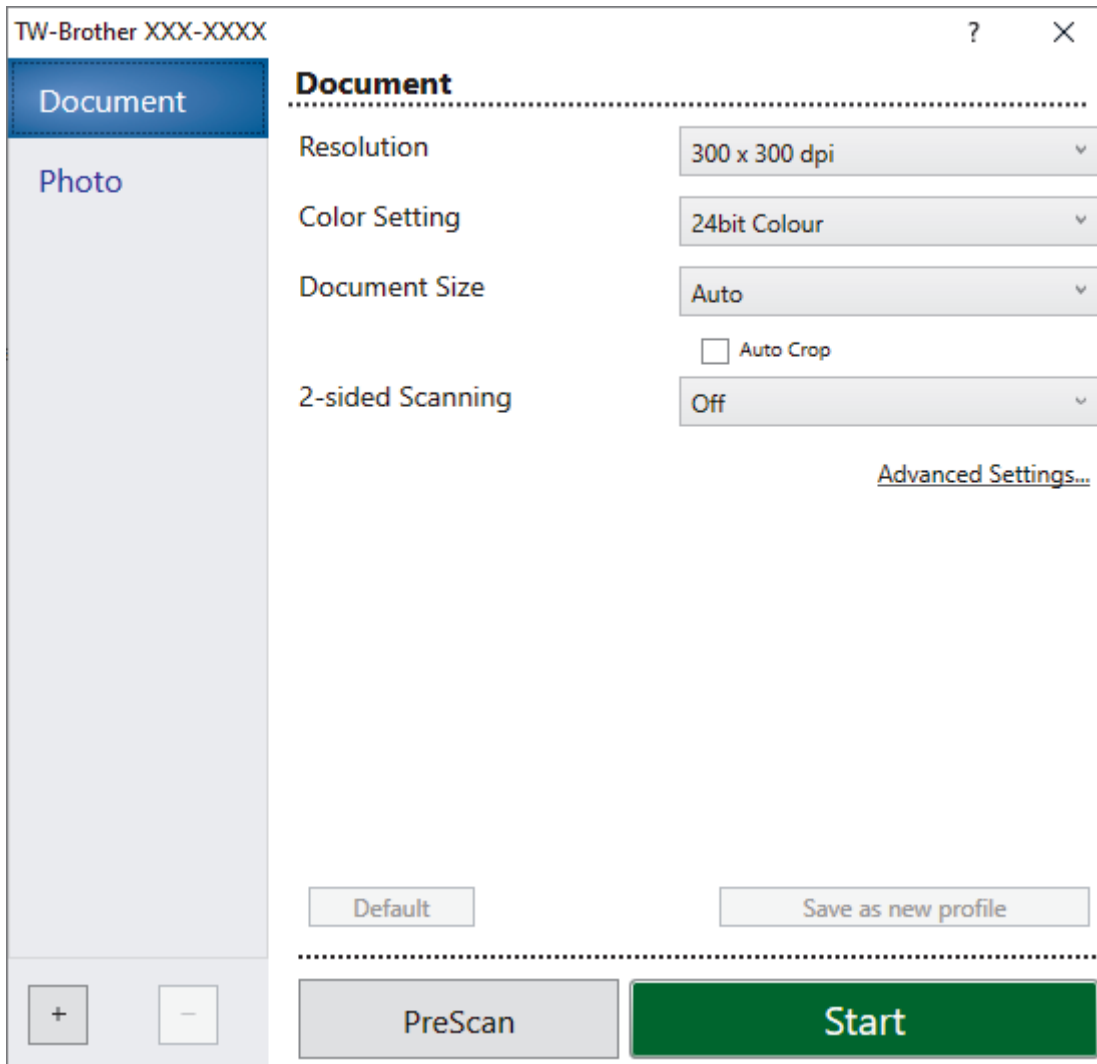

8. Adjust the settings in the Scanner Setup dialog box, if needed.
9. Click the **Document Size** drop-down list, and then select your document size.



To scan both sides of the document (MFC-J3940DW/MFC-J6940DW/MFC-J6955DW/MFC-J6957DW): Automatic 2-sided scan is available only when using the ADF.  
You cannot use PreScan to preview an image.

10. Click **PreScan** to preview your image and crop unwanted portions before scanning.
11. Click **Start**.  
The machine starts scanning.



### Related Information

- [Scan from Your Computer \(Windows\)](#)
  - [TWAIN Driver Settings \(Windows\)](#)

## TWAIN Driver Settings (Windows)

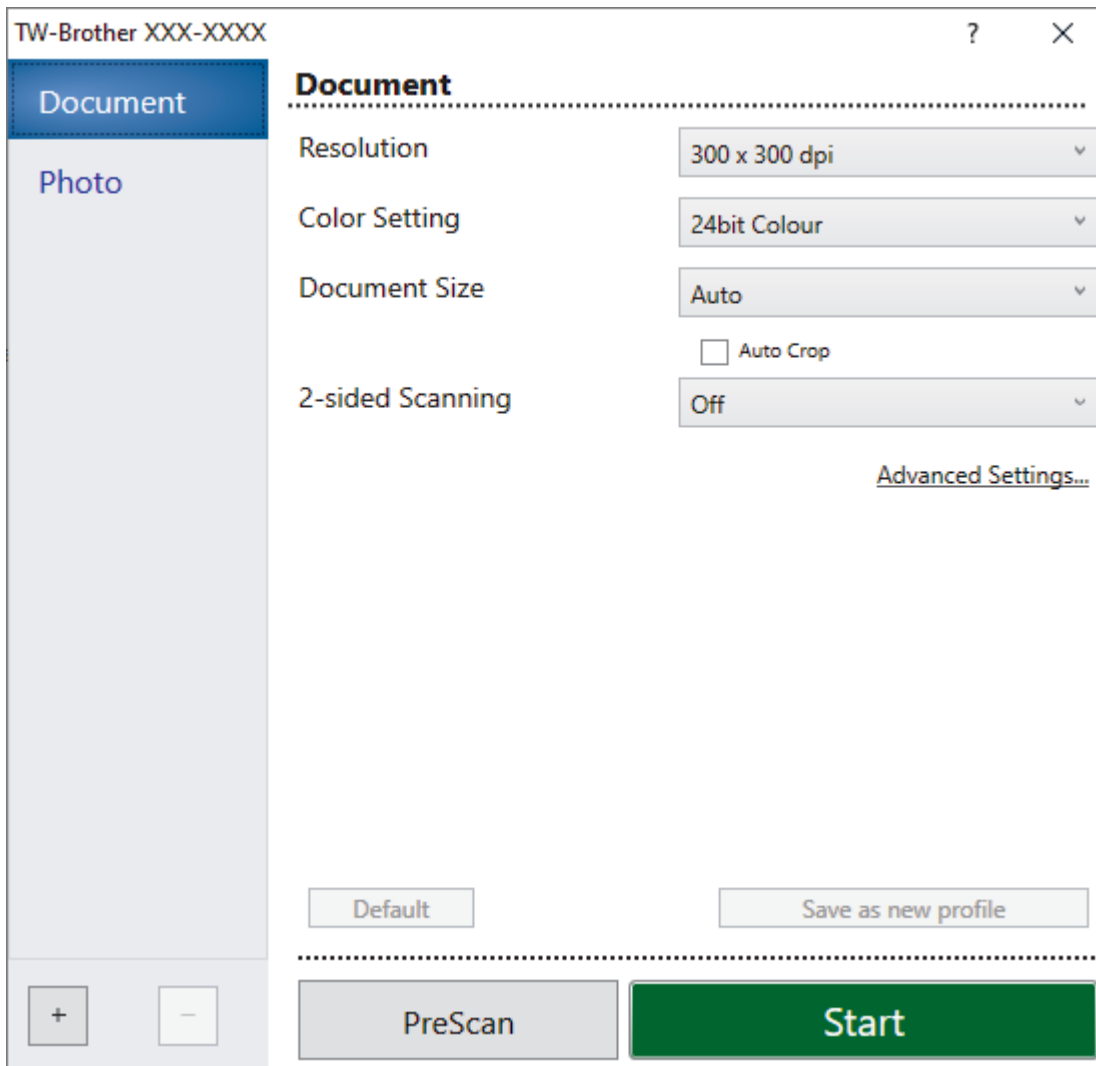

 Note that the item names and assignable values will vary depending on the machine.

### 1. Scan

Select the **Photo** or **Document** option depending on the type of document you want to scan.

Scan (Image Type)		Resolution	Colour Setting
<b>Photo</b>	Use for scanning photo images.	300 x 300 dpi	<b>24bit Colour</b>
<b>Document</b>	Use for scanning text documents.	300 x 300 dpi	<b>24bit Colour</b>

### 2. Resolution

Select a scanning resolution from the **Resolution** drop-down list. Higher resolutions take more memory and transfer time, but produce a finer scanned image.

### 3. Color Setting

Select from a range of scan colour depths.

- **Black & White**

Use for text or line art images.

---

- **Grey (Error Diffusion)**

Use for photographic images or graphics. (Error Diffusion is a method for creating simulated grey images without using true grey dots. Black dots are put in a specific pattern to give a grey appearance.)

- **True Grey**

Use for photographic images or graphics. This mode is more accurate because it uses up to 256 shades of grey.

- **24bit Colour**

Use to create an image with the most accurate colour reproduction. This mode uses up to 16.8 million colours to scan the image, but it requires the most memory and has the longest transfer time.

#### 4. Document Size

Select the exact size of your document from a selection of preset scan sizes.

If you select **Custom**, the **Custom Document Size** dialog box appears and you can specify the document size.

#### 5. Auto Crop

Scan multiple documents placed on the scanner glass. The machine will scan each document and create separate files or a single multi-page file.

#### 6. (MFC-J3940DW/MFC-J6940DW/MFC-J6955DW/MFC-J6957DW) 2-sided Scanning

Scan both sides of the document. When using the Automatic 2-sided Scan feature, you must select the **Long-edge binding** or **Short-edge binding** option from the **2-sided Scanning** drop-down list, so when you turn the pages, they are facing the way you want.

#### 7. Advanced Settings

Configure advanced settings by clicking the **Advanced Settings** link in the Scanner Setup dialog box.

- **Document Correction**

- **Auto Deskew**

Set the machine to correct document skewing automatically as the pages are scanned from the scanner glass.

- **Margin Settings**

Adjust your document's margins.

- **Rotate Image**

Rotate the scanned image.

- **Edge Fill**

Fill in the edges on four sides of the scanned image using the selected colour and range.

- **Skip Blank Page**

Remove the document's blank pages from the scanning results.

- **Image Quality**

- **Diffusion Adjustment -Grey**

Adjust the diffusion when selecting the **Grey (Error Diffusion)** option from the **Color Setting** drop-down list.

- **Colour Tone Adjustment**

Adjust the colour tone.

- **Background Processing**

- **Remove Bleed-through / Pattern**

Prevent bleed-through.

- **Remove Background Colour**

Remove the base colour of documents to make the scanned data more legible.

- **Colour Drop**

Select a colour to remove from the scanned image.

- **Edge Emphasis**

---

Sharpen the characters in the original.

- **Reduce Noise**

Improve and enhance the quality of your scanned images with this selection. The **Reduce Noise** option is available when selecting the **24bit Colour** option and the **300 x 300 dpi**, **400 x 400 dpi**, or **600 x 600 dpi** scan resolution.

- **B&W Image Quality**

- **B&W Threshold Adjustment**

Adjust the threshold to generate a monochrome image.

- **Character Correction**

Correct the broken or incomplete characters of the original to make them easier to read.

- **B&W Inversion**

Invert black and white in the monochrome image.

- **Feed Control**

- **Layout**

Select the layout.

- **Continuous Scan**

Select this option to scan multiple pages. After a page is scanned, select whether to continue scanning or finish.



## Related Information

- [Scan Using Nuance™ PaperPort™ 14SE or Other Windows Applications](#)
-

## Scan Using Windows Fax and Scan

Windows Fax and Scan application is another option that you can use for scanning.

- Windows Fax and Scan uses the WIA scanner driver.
- If you want to crop a portion of a page after pre-scanning the document, you must scan using the scanner glass (also called the flatbed).

1. Load your document.
2. Launch Windows Fax and Scan.
3. Click **File > New > Scan**.
4. Select the scanner you want to use.
5. Click **OK**.

The **New Scan** dialog box appears.

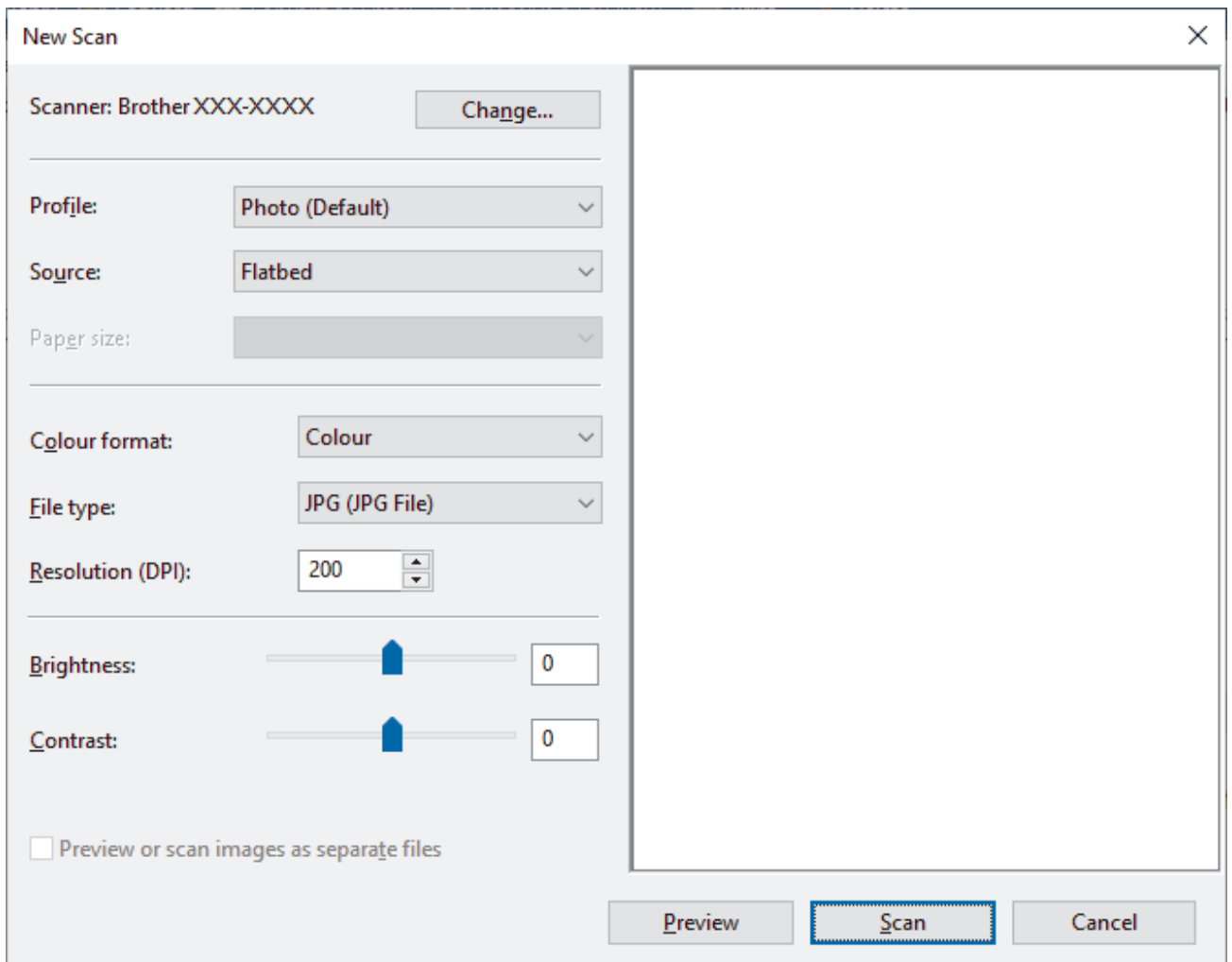

6. Adjust the settings in the dialog box, if needed.

The scanner resolution can be set to a maximum of 1200 dpi. If you want to scan at higher resolutions, use the **Scanner Utility** software from **Brother Utilities**.

If your machine supports 2-sided Scan and you want to scan both sides of your document, select **Feeder (Scan both sides)** as **Source**.

7. Click **Scan**.

The machine starts scanning the document.



## Related Information

- [Scan from Your Computer \(Windows\)](#)
  - [WIA Driver Settings \(Windows\)](#)
-

## WIA Driver Settings (Windows)

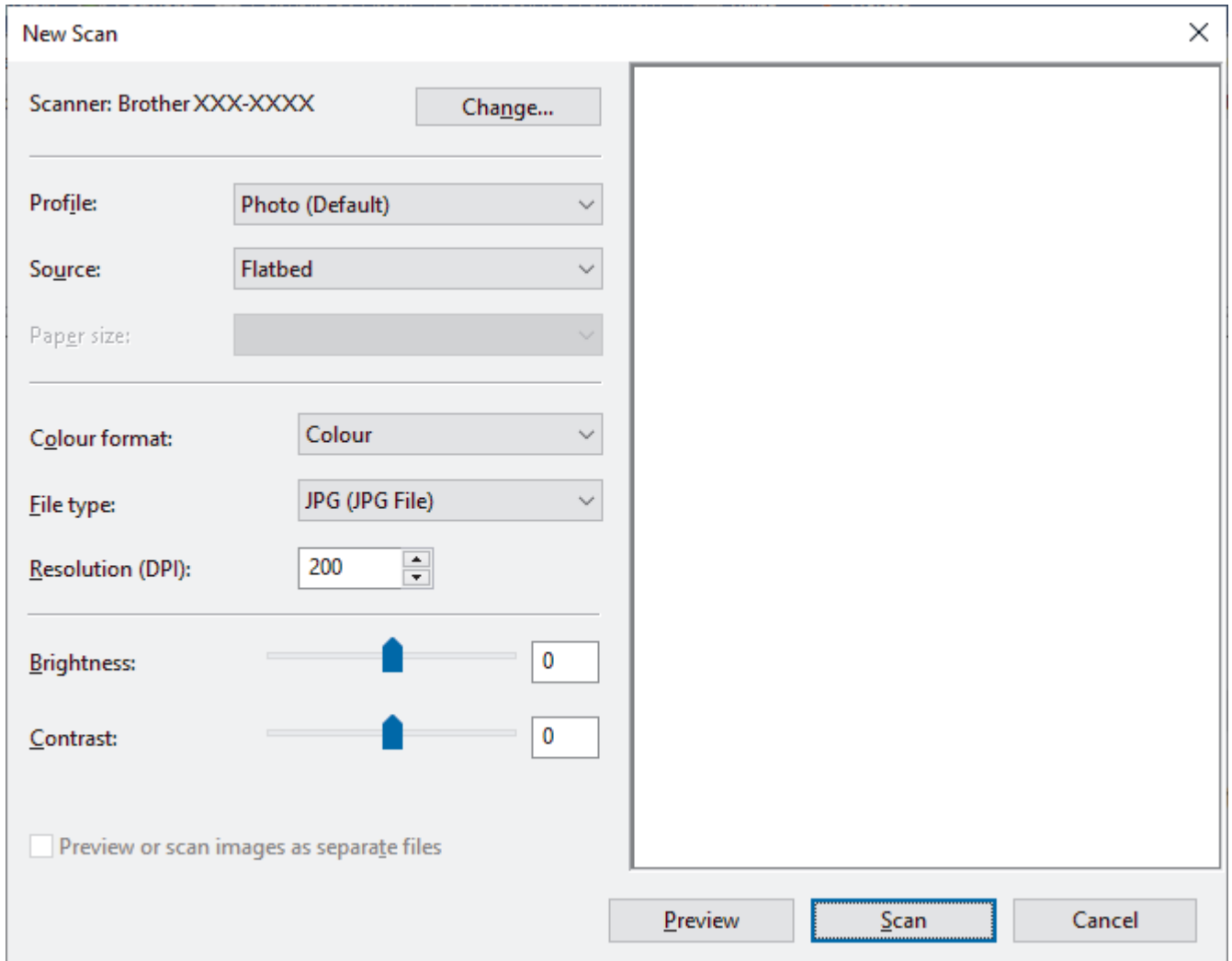

### Profile

Select the scan profile you want to use from the **Profile** drop-down list.

### Source

Select the **Flatbed**, **Feeder (Scan one side)**, or **Feeder (Scan both sides)** option from the drop-down list.

### Paper size

The **Paper size** option is available if you select the **Feeder (Scan one side)** or **Feeder (Scan both sides)** option from the **Source** drop-down list.

### Colour format

Select a scan colour format from the **Colour format** drop-down list.

### File type

Select a file format from the **File type** drop-down list.

### Resolution (DPI)

Set a scanning resolution in the **Resolution (DPI)** field. Higher resolutions take more memory and transfer time, but produce a finer scanned image.

### Brightness

Set the **Brightness** level by dragging the slider to the right or left to lighten or darken the image. If the scanned image is too light, set a lower brightness level and scan the document again. If the image is too dark,

---

set a higher brightness level and scan the document again. You can also type a value in the field to set the brightness level.

### **Contrast**

Increase or decrease the **Contrast** level by moving the slider to the right or left. An increase emphasises dark and light areas of the image, while a decrease reveals more details in grey areas. You can also type a value in the field to set the contrast level.



### **Related Information**

- [Scan Using Windows Fax and Scan](#)
-

---

Home > [Scan](#) > Scan from Your Computer (Mac)

## Scan from Your Computer (Mac)

- [Scan Using AirPrint \(macOS\)](#)

## **Configure Scan Settings Using Web Based Management**

- [Set the Scan File Name Using Web Based Management](#)
- [Set the Scan Job Email Report Using Web Based Management](#)

## Set the Scan File Name Using Web Based Management

Set up a file name for scanned data using Web Based Management.

1. Start your web browser.
2. Type "https://machine's IP address" in your browser's address bar (where "machine's IP address" is the machine's IP address).

For example:

https://192.168.1.2

3. If required, type the password in the **Login** field, and then click **Login**.



The default password to manage this machine's settings is located on the back of the machine and marked "Pwd".

4. Go to the navigation menu, and then click **Scan > Scan File Name**.



Start from , if the navigation menu is not shown on the left side of the screen.

5. Select the **File Name Style** from the drop-down list.
6. If you selected the option to include the date in **File Name Style** field, select the **Date** format from the drop-down list.
7. In the **Time** field, select **On** to include the time information in the file name.
8. In the **Counter** field, select **Continuous** or **Reset after each job**.



When you select **Reset after each job**, duplication of file names may occur.

9. If you want to create a user-defined file name prefix, type a file name in the user-defined fields of each scan function.



Do not use the following characters to avoid sending errors: ? / \ \*

10. Click **Submit**.



### Related Information

- [Configure Scan Settings Using Web Based Management](#)

## Set the Scan Job Email Report Using Web Based Management

When you scan a document, the machine will send a scan job email report automatically to the registered email address.

1. Start your web browser.
2. Type "https://machine's IP address" in your browser's address bar (where "machine's IP address" is the machine's IP address).

For example:

https://192.168.1.2

3. If required, type the password in the **Login** field, and then click **Login**.



The default password to manage this machine's settings is located on the back of the machine and marked "Pwd".

4. Go to the navigation menu, and then click **Scan > Scan Job e-mail report**.



Start from ☰, if the navigation menu is not shown on the left side of the screen.

5. In the **Administrator Address** field, type the email address.
6. For the scan functions you want, select **On** to send a scan job email report.
7. Click **Submit**.



### Related Information

- [Configure Scan Settings Using Web Based Management](#)

#### Related Topics:

- [Access Web Based Management](#)

## Copy

- [Copy a Document](#)
- [Enlarge or Reduce Copied Images](#)
- [Sort Copies](#)
- [Make Page Layout Copies \(N in 1 or Poster\)](#)
- [Copy on Both Sides of the Paper \(2-sided Copy\)](#)
- [Copy an ID Card](#)
- [Use the A3 Copy Shortcuts](#)
- [Copy Settings](#)

## Copy a Document

1. Make sure you have loaded the correct size paper in the paper tray.
2. Load your document.
3. Press  [Copy].



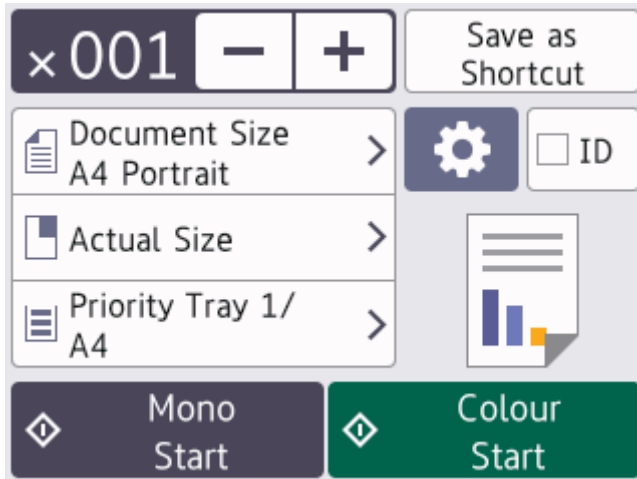





The touchscreen displays:



4. Change the copy settings, if needed.



When you load paper other than A4 size plain paper, you must change the [Paper Size] and [Paper Type] settings by pressing  [Options].

Option	Description
 (No. of Copies)	Enter the number of copies in one of the following ways: <ul style="list-style-type: none"> <li>• Press - or + on the touchscreen.</li> <li>• Press  to display the keyboard on the touchscreen, and then enter the number of copies using the touchscreen keyboard. Press OK.</li> <li>• Enter the number of copies using the dial pad.</li> </ul>
 (Options)	Press  [Options] to change the copy settings for the next copy only. When you have finished changing settings, press OK.
ID	To make an ID card copy with the [2in1 ID Vertical] layout, select the [ID] checkbox.
Current setting indications	Press the area indicated on the screen to change copy settings for the next copy only. <ul style="list-style-type: none"> <li>•  Document Size</li> <li>•  Enlarge/Reduce</li> <li>•  Tray Select (MFC-J3940DW/MFC-J6555DW/MFC-J6740DW/MFC-J6940DW/MFC-J6955DW/MFC-J6957DW)</li> <li>•  Paper Size (MFC-J3540DW/MFC-J6540DW)</li> </ul>
 (Preview)	Preview the copied result on the LCD, before the machine starts printing.

---

Option	Description
--------	-------------

(MFC-J6955DW/  
MFC-J6957DW)



- After you have finished selecting new options, you can save them by pressing [Save as Shortcut].
- (MFC-J6955DW/MFC-J6957DW) To preview the copied result before the machine starts printing, press  and then press [Mono Preview] or [Colour Preview]. The machine scans the document and displays **only the first page (one side)** of the copied result on the LCD. If the copied result is fine, press [Start] to print it and to finish processing.

5. Press [Mono Start] or [Colour Start].



To interrupt copying, press .



### Related Information

- [Copy](#)



#### Related Topics:

- [Load Documents in the Automatic Document Feeder \(ADF\)](#)
  - [Load Documents on the Scanner Glass](#)
  - [Copy Settings](#)
-

## Enlarge or Reduce Copied Images

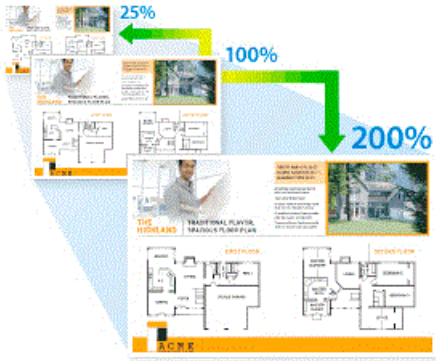
Select an enlargement or reduction ratio to resize your copied data.



1. Load your document.
2. Press  [Copy].
3. Enter the number of copies in one of the following ways:
  - Press [-] or [+] on the touchscreen.
  - Press **x001** to display the keyboard on the touchscreen, and then enter the number of copies using the touchscreen keyboard. Press [OK].
  - Enter the number of copies using the dial pad.
4. Press  [Options] > [Enlarge/Reduce].
5. Press ▲ or ▼ to display the available options, and then press the option you want to change.
6. Do one of the following:
  - If you selected the [Enlarge] or [Reduce] option, press the enlargement or reduction ratio you want to use.
  - If you selected the [Custom(25-400%)] option, press  (backspace) to erase the displayed percentage, or press ◀ to move the cursor, and then enter an enlargement or reduction ratio from [25%] to [400%]. Press [OK].
  - If you selected [100%] or the [Fit to Page] option, go to the next step.
7. Read and confirm the displayed list of options you have selected, and then press [OK].



---

(MFC-J6955DW/MFC-J6957DW) To preview the copied result before the machine starts printing, press  and then press [Mono Preview] or [Colour Preview]. The machine scans the document and displays **only the first page (one side)** of the copied result on the LCD. If the copied result is fine, press [Start] to print it and to finish processing.

---

8. When you have finished changing settings, press [Mono Start] or [Colour Start].



---

If you selected the [Fit to Page] option, your machine adjusts the copy size to fit the paper size set in the machine.

- The [Fit to Page] option does not work correctly when the document on the scanner glass is skewed. Using the document guidelines on the left and top, place the document face down in the upper-left corner of the scanner glass.
  - The [Fit to Page] option is not available for Legal size documents.
-





## Related Information

- [Copy](#)
-

## Sort Copies

Sort multiple copies. Pages will be stacked in the order they are fed, that is: 1, 2, 3, and so on.

1. Load your document.
2. Press  [Copy].
3. Enter the number of copies in one of the following ways:
  - Press [-] or [+] on the touchscreen.
  - Press **x001** to display the keyboard on the touchscreen, and then enter the number of copies using the touchscreen keyboard. Press [OK].
  - Enter the number of copies using the dial pad.
4. Press  [Options] > [Stack/Sort] > [Sort].
5. Read and confirm the displayed list of settings you have selected, and then press [OK].



---

(MFC-J6955DW/MFC-J6957DW) To preview the copied result before the machine starts printing, press  and then press [Mono Preview] or [Colour Preview]. The machine scans the document and displays **only the first page (one side)** of the copied result on the LCD. If the copied result is fine, press [Start] to print it and to finish processing.

---

6. When you have finished changing settings, press [Mono Start] or [Colour Start]. If you placed the document in the ADF, the machine scans the document and starts printing.
7. If you are using the scanner glass, repeat the following steps for each page of the document:
  - Place the next page on the scanner glass, and then press [Continue] to scan the page.
  - After scanning all the pages, press [Finish].



### Related Information

- [Copy](#)

## Make Page Layout Copies (N in 1 or Poster)

The N in 1 copy feature saves paper by copying two or four pages of your document onto one page of the copy. The poster feature divides your document into sections, then enlarges the sections so you can assemble them into a poster. To print a poster, use the scanner glass.





- Make sure the paper size is set to A4, A3, Letter, or Ledger.
- You can make only one Poster copy at a time.









---

The 1 to 2 feature copies one A3 or Ledger size paper onto two A4 or Letter size papers. You can make only one 1 to 2 copy at a time.

---

1. Load your document.
2. Press  [Copy].
3. Enter the number of copies in one of the following ways:
  - Press [-] or [+] on the touchscreen.
  - Press **x001** to display the keyboard on the touchscreen, and then enter the number of copies using the touchscreen keyboard. Press [OK].
  - Enter the number of copies using the dial pad.
4. Press  [Options] > [Page Layout].
5. Press ▲ or ▼ to display the options, and then press the option you want.

Option	Description
Off (1in1)	-

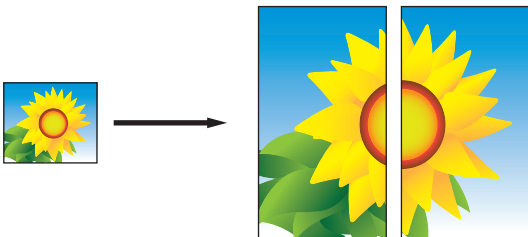
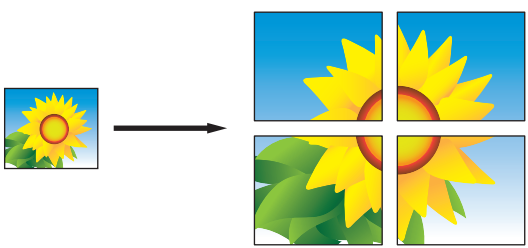
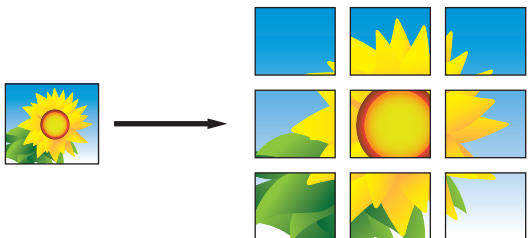
Option	Description
2in1 (Portrait)	
2in1 (Landscape)	
2in1 ID Vertical (Using the scanner glass)	
2in1 ID Horizontal (Using the scanner glass)	
4in1 (Portrait)	
4in1 (Landscape)	
1to2 (Using the scanner glass)	
Poster (2x1) (Using the scanner glass)	
Poster (2x2) (Using the scanner glass)	
Poster (3x3) (Using the scanner glass)	

6. Read and confirm the displayed list of settings you have selected, and then press [OK].



---

(MFC-J6955DW/MFC-J6957DW) To preview the copied result before the machine starts printing, press  and then press [Mono Preview] or [Colour Preview]. The machine scans the document and displays **only the first page (one side)** of the copied result on the LCD. If the copied result is fine, press [Start] to print it and to finish processing.

---

7. When you have finished changing settings, press [Mono Start] or [Colour Start]. If you placed the document in the ADF or are making a poster or 1 to 2 copy, the machine scans the pages and starts printing.
8. If you are using the scanner glass, repeat the following steps for each page of the document:
  - Place the next page on the scanner glass, and then press [Continue] to scan the page.
  - After scanning all the pages, press [Finish].



## Related Information

- [Copy](#)
-

## Copy on Both Sides of the Paper (2-sided Copy)

Reduce the amount of paper you use by copying onto both sides of the paper.

- You must choose a 2-sided copy layout from the following options before you can start 2-sided copying.
- The layout of your original document determines which 2-sided copy layout you should choose.
- (MFC-J3940DW/MFC-J6940DW/MFC-J6955DW/MFC-J6957DW)  
You can copy 2-sided documents automatically up to A3 size using the ADF.
- (MFC-J3540DW/MFC-J6540DW/MFC-J6555DW/MFC-J6740DW)  
When you manually make 2-sided copies from a 2-sided document, use the scanner glass.
- You can use only A4, Letter, A5, A3, Ledger, Legal, Folio, Mexico Legal, or India Legal size plain paper.

### Portrait

#### 1-sided to 2-sided (Long Edge Flip)

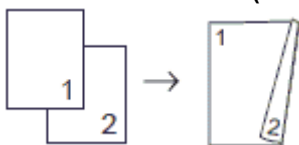

#### 1-sided to 2-sided (Short Edge Flip)

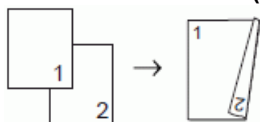

#### 2-sided to 2-sided

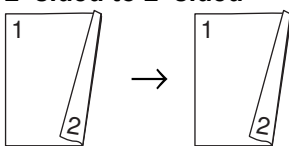

#### 2-sided to 1-sided (Long Edge Flip)

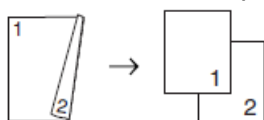

#### 2-sided to 1-sided (Short Edge Flip)

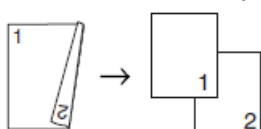

### Landscape

#### 1-sided to 2-sided (Long Edge Flip)

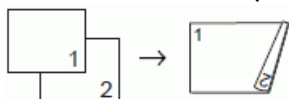

#### 1-sided to 2-sided (Short Edge Flip)

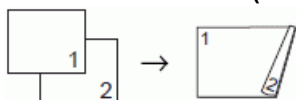

#### 2-sided to 2-sided

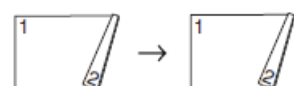

#### 2-sided to 1-sided (Long Edge Flip)

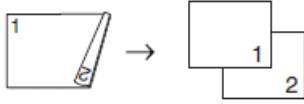

### 2-sided to 1-sided (Short Edge Flip)

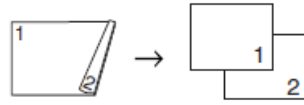

1. Load your document.
2. Press  [Copy].
3. Enter the number of copies in one of the following ways:
  - Press [-] or [+] on the touchscreen.
  - Press **x001** to display the keyboard on the touchscreen, and then enter the number of copies using the touchscreen keyboard. Press [OK].
  - Enter the number of copies using the dial pad.
4. To sort multiple copies, press  [Options] > [Stack/Sort] > [Sort].
5. Press ▲ or ▼ to display the [2-sided Copy] option, and then press it.
6. Do one of the following:
  - To make 2-sided copies from a 1-sided document, follow these steps:
    - a. To change the layout options, press [Layout], and then press [Long Edge Flip] or [Short Edge Flip].
    - b. Press [1-sided⇒2-sided].
  - (MFC-J3940DW/MFC-J6940DW/MFC-J6955DW/MFC-J6957DW)  
To make 2-sided copies of a 2-sided document automatically, press [2-sided⇒2-sided].



Load your document in the ADF to use the automatic 2-sided copy feature.

- (MFC-J3540DW/MFC-J6540DW/MFC-J6555DW/MFC-J6740DW)  
To make 2-sided copies of a 2-sided document manually, press [2-sided⇒2-sided].



Use the scanner glass to make 2-sided copies of a 2-sided document manually.

- (MFC-J3940DW/MFC-J6940DW/MFC-J6955DW/MFC-J6957DW)  
To make 1-sided copies from a 2-sided document, follow these steps:
  - a. To change the layout options, press [Layout], and then press [Long Edge Flip] or [Short Edge Flip].
  - b. Press ▲ or ▼ to display the [2-sided⇒1-sided] option, and then press it.



Load your document in the ADF to use the automatic 2-sided copy feature.

7. Review your settings on the touchscreen, and then press [OK].



(MFC-J6955DW/MFC-J6957DW) To preview the copied result before the machine starts printing, press  and then press [Mono Preview] or [Colour Preview]. The machine scans the document and displays **only the first page (one side)** of the copied result on the LCD. If the copied result is fine, press [Start] to print it and to finish processing.

8. Press [Mono Start] or [Colour Start]. If you placed the document in the ADF, the machine scans the pages and starts printing.
9. If you are using the scanner glass, repeat the following steps for each page of the document:
  - Place the next page on the scanner glass, and then press [Continue] to scan the page.

- 
- After scanning all the pages, press [Finish].

DO NOT touch the printed page until it is ejected the second time. The machine will print the first side and eject the paper, and then pull the paper in to print the second side.



If you experience smudged printouts or paper jams, press  [Ink] > [Print Options] > [Reduce Smudging], and then change settings.

---



## Related Information

- [Copy](#)

### Related Topics:

- [Change the Print Options to Improve Your Print Results](#)
-

## Copy an ID Card

Use the [2in1 (ID)] feature to copy both sides of an identification card onto one page, keeping the original card size.



- Make sure the paper size is set to A4 or Letter.
- You may copy an identification card to the extent permitted under applicable laws. For more detailed information, see the *Product Safety Guide*.

1. Place your identification card face down near the upper-left corner of the scanner glass.

**2 in 1 ID (Vertical)**

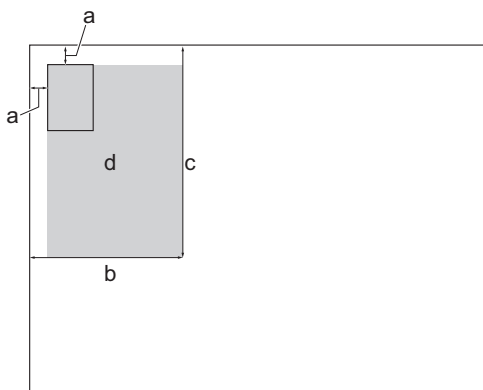

**2 in 1 ID (Horizontal)**

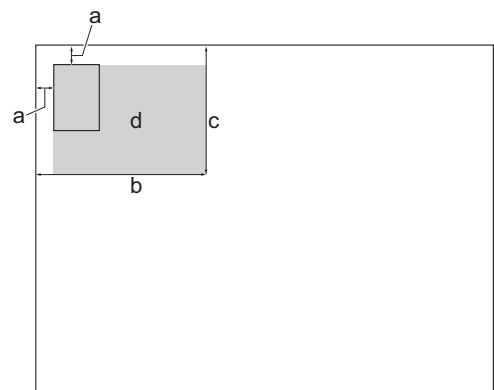

- a. 3 mm or greater (top, left)
- b. 145 mm
- c. 2 in 1 ID (Vertical): 207 mm  
2 in 1 ID (Horizontal): 102 mm
- d. Scannable area

2. Press  [Copy].

3. Enter the number of copies in one of the following ways:

- Press [-] or [+] on the touchscreen.
- Press **x001** to display the keyboard on the touchscreen, and then enter the number of copies using the touchscreen keyboard. Press [OK].
- Enter the number of copies using the dial pad.

4. Press  [Options] > [Page Layout] > [2in1 ID Vertical] or [2in1 ID Horizontal].



You can also press [ID] for the [2in1 ID Vertical] setting.

5. Read and confirm the displayed list of settings you have selected. When you have finished changing settings, press [OK].



---

(MFC-J6955DW/MFC-J6957DW) To preview the copied result before the machine starts printing, press  and then press [Mono Preview] or [Colour Preview]. The machine scans the document and displays **only the first page (one side)** of the copied result on the LCD. If the copied result is fine, press [Start] to print it and to finish processing.

---

6. Press [Mono Start] or [Colour Start].

The machine starts scanning one side of the identification card.

7. After the machine has scanned the first side, turn over the identification card and press [Continue] to scan the other side.









### Related Information

- [Copy](#)
-

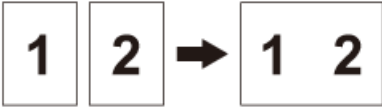
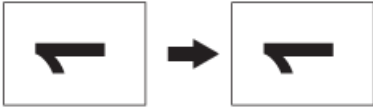
## Use the A3 Copy Shortcuts

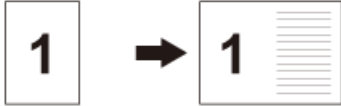
You can copy your document in A3 or Ledger size paper with a format such as Note style. Also you can make 2 in 1, enlarged and reduced copies.

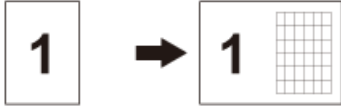
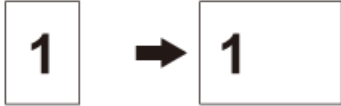
1. Load your document.
2. Press ◀ or ▶ to display the [A3 Copy Shortcuts] option, and then press it.
3. If information appears on the touchscreen, read it, and then press [OK] to confirm.
4. Press ◀ or ▶ to display options, and then press the option you want.

Option	Description
A3 2in1	
A3	
A4⇒A3	
A3⇒A4	
A4 + Note (L)	
A4 + Note (P)	
A4 + Grid	
A4 + Blank	
A4 Centre	

5. Enter the number of copies in one of the following ways:
  - Press [-] or [+] on the touchscreen.
  - Press **x001** to display the keyboard on the touchscreen, and then enter the number of copies using the touchscreen keyboard. Press [OK].
  - Enter the number of copies using the dial pad.

- 
6. To change the settings, press  [Options].
  7. When you have finished changing settings, press [OK].
  8. Press [Mono Start] or [Colour Start].
  9. If you are using the scanner glass when choosing the [A3 2in1] option, repeat the following steps for each page of the document:
    - Place the next page on the scanner glass, and then press [Continue] to scan the page.
    - After scanning all the pages, press [Finish].



## Related Information

- [Copy](#)



### Related Topics:

- [Touchscreen LCD Overview](#)
-

# Copy Settings

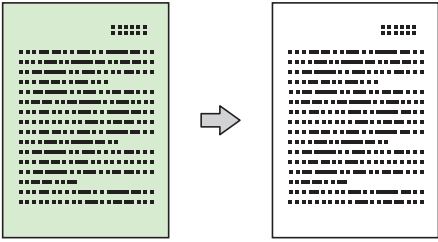
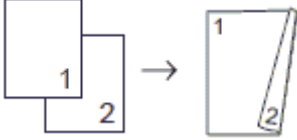
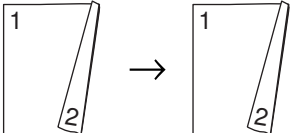
To change copy settings, press  [Options].

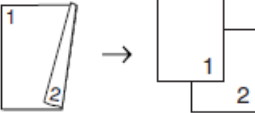
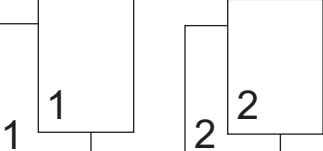
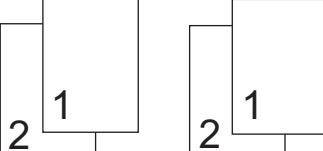
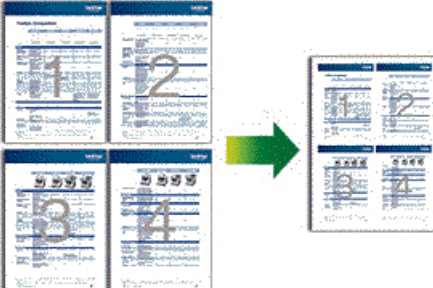
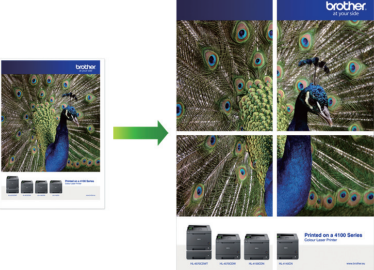
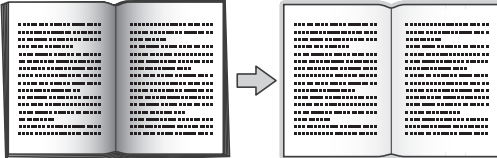
Option	Description	
<b>Quality</b>	Select the Copy resolution for your type of document.	
<b>Document Size</b>	Select your document size.	
<b>Tray Select</b> (MFC-J3940DW/ MFC-J6555DW/ MFC-J6740DW/ MFC-J6940DW/ MFC-J6955DW/ MFC-J6957DW)	Select the tray with the best paper type and size for your document.	
<b>Paper Type</b>	Select a paper type. If copying on special paper, set the machine for the type of paper you are using to get the best print quality.	
<b>Paper Size</b>	Select a paper size. If copying on paper other than A4 size, you must change the Paper Size setting.	
<b>Enlarge/Reduce</b>	100%	-
	Fit to Page	Adjusts the copy size to fit on the paper size you have set.
	Enlarge	Select an enlargement ratio for the next copy.
	Reduce	Select a reduction ratio for the next copy.
	Custom (25-400%)	Enter an enlargement or reduction ratio.
<b>Density</b>	Increase the density to make the text darker. Decrease the density to make the text lighter.	
<b>Remove Background Colour</b>	Removes the document's background colour in copies. The white becomes more apparent. This saves some ink and may make certain copies easier to read.  	
<b>2-sided Copy</b>	Select to copy on both sides of the paper. <b>1-sided→2-sided</b>  <b>2-sided→2-sided</b> 	

Option	Description
	<p><b>2-sided→1-sided</b> (MFC-J3940DW/MFC-J6940DW/MFC-J6955DW/MFC-J6957DW)</p> 
<p><b>Stack/Sort</b></p>	<p>Select to stack or sort multiple copies.</p> <div style="display: flex; justify-content: space-around;"> <div data-bbox="472 439 922 631"> <p><b>Stack</b></p>  </div> <div data-bbox="928 439 1474 631"> <p><b>Sort</b></p>  </div> </div>
<p><b>Page Layout</b></p>	<p>Make N in 1, 2 in 1 ID, 1 to 2, or Poster copies.</p> <div style="display: flex; justify-content: space-around;"> <div data-bbox="472 696 922 1043"> <p><b>4 in 1</b></p>  </div> <div data-bbox="928 696 1474 1043"> <p><b>Poster</b></p>  </div> </div>
<p><b>Auto Deskew</b></p>	<p>Set the machine to automatically correct skewed copies.</p>
<p><b>Advanced Settings</b></p>	<p><b>Book Copy</b> Corrects dark borders and skew when copying from the scanner glass.</p>  <p><b>Watermark Copy</b> Places text in your document as a watermark.</p> 
<p><b>Preview</b> (MFC-J6955DW/ MFC-J6957DW)</p>	<p>Preview the copied result on the LCD, before the machine starts printing.</p>
<p><b>Set New Default</b></p>	<p>Saves the copy settings that you use most often by setting them as the default settings.</p>
<p><b>Factory Reset</b></p>	<p>Restores any changed copy settings to the factory settings.</p>



You can save the current settings by pressing [Save as Shortcut].



## Related Information

- [Copy](#)

### **Related Topics:**

- [Copy a Document](#)
-

## Fax

- [Send a Fax](#)
- [Receive a Fax](#)
- [Voice Operations and Fax Numbers](#)
- [Telephone Services and External Devices](#)
- [Fax Reports](#)
- [PC-FAX](#)

## Send a Fax

- [Send a Fax from Your Brother Machine](#)
- [Send a 2-sided Fax from the ADF](#)
- [Send a Fax Manually](#)
- [Send a Fax at the End of a Conversation](#)
- [Send the Same Fax to More than One Recipient \(Broadcasting\)](#)
- [Send a Fax in Real Time](#)
- [Send a Fax at a Specified Time \(Delayed Fax\)](#)
- [Change the Fax Auto Redial Setting](#)
- [Cancel a Fax in Progress](#)
- [Check and Cancel a Pending Fax](#)
- [Fax Options](#)

## Send a Fax from Your Brother Machine

1. Load your document in the ADF or place it on the scanner glass.
2. Press  [Fax].



If [Fax Preview] is set to [On], press  [Fax] > [Sending Faxes].

The touchscreen displays:

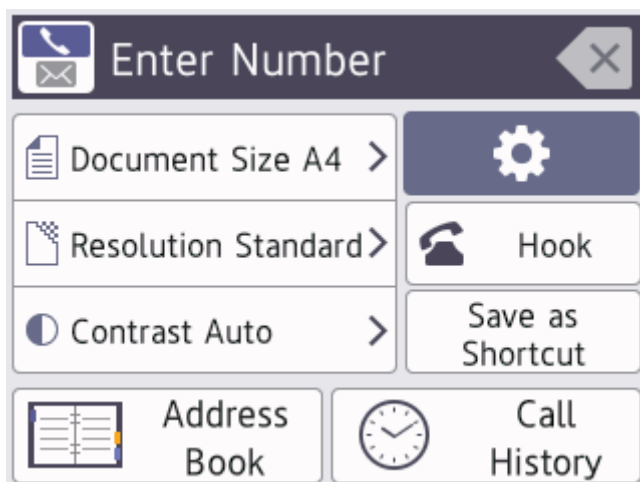



3. Enter the fax number in one of the following ways:
  - Dial Pad (Enter the fax number manually.)  
Press all digits of the number using the dial pad.
  - Call History (Select a number from the Call History.)  
Press [Call History].  
Press [Redial], [Outgoing Call] or [Caller ID History].  
If you select [Outgoing Call] or [Caller ID History], select the number you want, and then press [Apply].  
(Caller ID feature is not available for Taiwan and some countries)
  - [Address Book] (Select a number from the Address Book.)  
Press [Address Book].  
Do one of the following:
    - Select the number you want, and then press [Apply].
    - Press , and then enter the first letter of the name and press [OK]. Press the name you want to dial. If the name has two numbers, press the number you want. Press [Apply].





(available only for some countries)

If the LDAP search is available, the result will be shown on the touchscreen with .

4. Change the fax settings, if needed.

Option	Description
 Options	Press  Options to change the fax settings for the next fax only. When finished, press OK.
Current setting indications	Press the following icons to change these settings for the next fax only:

---

Option	Description
	<ul style="list-style-type: none"><li>•  Document Size</li><li>•  Fax Resolution</li><li>•  Contrast</li></ul>

---

5. Press [Fax Start].

- If you are using the ADF, the machine starts scanning and sending the document.
- If you are using the scanner glass and selected [Mono] in [Colour Setting], the machine starts scanning the first page.

Go to the next step.

- If you are using the scanner glass and selected [Colour] in [Colour Setting], the touchscreen asks if you want to send a colour fax.

Press [Yes (Colour fax)] to confirm. The machine starts dialling and sending the document.

6. When the touchscreen displays [Next page?], do one of the following:

- Press [No] when finished scanning pages. The machine starts sending the document.
- Press [Yes] to scan another page. Place the next page on the scanner glass, and then press [OK]. The machine starts scanning the page.

Repeat this step for each additional page.

### Related Information

- [Send a Fax](#)

#### Related Topics:

- [Fax Options](#)
-

## Send a 2-sided Fax from the ADF

**Related Models:** MFC-J3940DW/MFC-J6940DW/MFC-J6955DW/MFC-J6957DW

You must select a 2-sided scanning format before sending a 2-sided fax. Select either Long Edge or Short Edge, depending on the layout of your document.

1. Load your document in the ADF.

2. Press  [Fax].



If [Fax Preview] is set to [On], press  [Fax] > [Sending Faxes].

3. Press  [Options] > [2-sided Fax].

4. Do one of the following:

- If your document is flipped on the Long edge, press the [2-sided Scan: Long Edge] option.
- If your document is flipped on the Short edge, press the [2-sided Scan: Short Edge] option.

5. Press [OK].

6. Enter the fax number.

7. Press [Fax Start].



### Related Information

- [Send a Fax](#)

## Send a Fax Manually

Manual fax transmission lets you hear the dialling, ringing and fax-receiving tones while sending a fax.

**(Not available in South Africa)**

1. Load your document.
2. Press  [Fax].



If [Fax Preview] is set to [On], press  [Fax] > [Sending Faxes].

3. Press [Hook] and listen for a dial tone.
4. Enter the fax number.
5. When you hear fax tones, press [Fax Start].
  - If using the scanner glass, press [Send].

(For South Africa only)

To send a fax manually, do the following:

Load your document. To listen for a dial tone, pick up the handset of the external telephone. Dial the fax number using the external telephone. When you hear fax tones, press  and then press [Fax Start]. If you are using the scanner glass, press [Send]. Replace the handset of the external phone.



### Related Information

- [Send a Fax](#)

## Send a Fax at the End of a Conversation

At the end of a conversation, you can send a fax to the other party before you both hang up.

1. Ask the other party to wait for fax tones (beeps) and to press the Start key before hanging up.
2. Load your document.
3. Press  to display the [Fax Start] button.
4. Press [Fax Start].
  - If using the scanner glass, press [Send].
5. Replace the handset of the external telephone.



### Related Information

- [Send a Fax](#)
-

## Send the Same Fax to More than One Recipient (Broadcasting)

Use the Broadcasting feature to send the same fax to multiple fax numbers at the same time.

- This feature is available only for monochrome faxes.
- Address Book numbers must be stored in the machine's memory before they can be used in a broadcast.
- Group numbers must also be stored in the machine's memory before they can be used in a broadcast. Group numbers include many stored Address Book numbers for easier dialling.

You can include Groups, Address Book numbers, and up to 50 manually-dialled numbers in the same broadcast.

If you did not use any of the Address Book numbers for Groups, you can broadcast faxes to as many as 250 different numbers.

1. Load your document.

2. Press  [Fax].



If [Fax Preview] is set to [On], press  [Fax] > [Sending Faxes].

3. Press  [Options] > [Broadcasting].

4. Press [Add Number].

You can add numbers to the broadcast in the following ways:

- Press [Add Number] and enter a fax number using the dial pad. Press [OK].



To broadcast using an email address, press , enter the email address, and press [OK].

- Press [Add from Address book]. Press ▲ or ▼ to display the numbers you want to add to the broadcast. Select the check boxes of the numbers you want to add.

When finished, press [OK].

- Press [Search in Address book]. Press the first letter of the name and press [OK]. Press the name, and then press the number you want to add.

Repeat this step to enter additional fax numbers.

5. When finished, press [OK].

6. Press [Fax Start].

7. Do one of the following:

- If you are using the ADF, the machine starts scanning and sending the document.
- If you are using the scanner glass, the machine starts scanning the first page.

When the touchscreen displays [Next page?], do one of the following:

- Press [No] when finished scanning pages. The machine starts sending the document.
- Press [Yes] to scan another page. Place the next page on the scanner glass, and then press [OK]. The machine starts scanning the page.

Repeat this step for each additional page.



### Related Information

- [Send a Fax](#)
  - [Cancel a Broadcast in Progress](#)



---

**Related Topics:**

- [Set up Broadcasting Groups](#)
  - [Enter Text on Your Brother Machine](#)
-

## Cancel a Broadcast in Progress

While broadcasting multiple faxes, you can cancel just the fax currently being transmitted or cancel the whole broadcast job.

1. Press  to return to the Home screen.
2. Press .
3. Do one of the following:
  - To cancel the entire broadcast, press [Entire Broadcast]. Press [Yes] to confirm or press [No] to exit without cancelling.
  - To cancel the current number being dialled, press the name or number on the touchscreen. Press [Yes] to confirm or press [No] to exit without cancelling.
  - To exit without cancelling, press .

### Related Information

- [Send the Same Fax to More than One Recipient \(Broadcasting\)](#)

## Send a Fax in Real Time

When sending a fax, the machine scans the document into the memory before sending it. As soon as the telephone line is free, the machine starts dialling and sending. If you want to send an important document immediately without waiting for the machine to retrieve the scan from its memory, turn on [Real Time TX].

- If you are sending a colour fax or if the machine's memory is full and you are sending a monochrome fax from the ADF, the machine sends the document in real time (even if [Real Time TX] is set to [Off]).
- In Real Time Transmission, the automatic redial feature does not work when using the scanner glass.

1. Load your document.

2. Press  [Fax].



If [Fax Preview] is set to [On], press  [Fax] > [Sending Faxes].

3. Press  [Options] > [Real Time TX].

4. Press [On].

5. Press [OK].

6. Enter the fax number.

7. Press [Fax Start].



### Related Information

- [Send a Fax](#)

## Send a Fax at a Specified Time (Delayed Fax)

You can store up to 50 faxes in the machine's memory to be sent within the next twenty-four hour period.

This feature is available only for monochrome faxes.

1. Load your document.

2. Press  [Fax].



If [Fax Preview] is set to [On], press  [Fax] > [Sending Faxes].

3. Press  [Options] > [Delayed Fax].

4. Press [Delayed Fax].

5. Press [On].

6. Press [Set Time].

7. Enter the time you want the fax to be sent using the touchscreen. Press [OK].



The number of pages you can scan into the memory depends on the amount and type of data.

8. Press [OK].

9. Enter the fax number.

10. Press [Fax Start].

- If you are using the scanner glass, go to the next step.

11. When the touchscreen displays [Next page?], do one of the following:

- Press [No] when finished scanning pages.
- Press [Yes] to scan another page. Place the next page on the scanner glass, and then press [OK]. The machine starts scanning the page.

Repeat this step for each additional page.





### Related Information

- [Send a Fax](#)

## Change the Fax Auto Redial Setting

If the line is busy when you are sending a fax automatically, and the Fax Auto Redial is set to [On], the machine redials up to three times at five-minute intervals.

The default setting for Fax Auto Redial is [On].



1. Press  [Settings] > [All Settings] > [Initial Setup] > [Fax Auto Redial].
2. Press [On] or [Off].
3. Press .

---

### Related Information

- [Send a Fax](#)
-

## Cancel a Fax in Progress

1. Press  to return to the Home screen.
2. Press  to cancel a fax that is already in progress.
3. When you press  while the machine is dialling or sending, the touchscreen displays [Cancel Job?]. Press [Yes].



### Related Information



- [Send a Fax](#)

#### Related Topics:

- [Telephone and Fax Problems](#)

## Check and Cancel a Pending Fax

Follow these steps to view or to cancel faxes stored in the machine's memory and waiting to be sent. If there are no fax jobs in memory, the LCD displays [No Jobs Waiting]. You can cancel a fax job before it is sent.

1. Press  [Settings] > [All Settings] > [Fax] > [Remaining Jobs].
2. Do the following for each fax job you want to check or cancel:
  - a. Press ▲ or ▼ to scroll through the waiting jobs. If needed, press the job you want to cancel.
  - b. Press [OK].
  - c. Press [Yes] to confirm or press [No] to exit without cancelling.
3. When finished, press .

### Related Information

- [Send a Fax](#)

#### **Related Topics:**

- [Telephone and Fax Problems](#)

## Fax Options

To change fax-sending settings, press  [Options].

Option	Description
Fax Resolution	Set the resolution for outgoing faxes. The fax quality often can be improved by changing the Fax Resolution.
Contrast	Adjust the contrast. If your document is very light or very dark, changing the contrast may improve the fax quality.
2-sided Fax (MFC-J3940DW/MFC-J6940DW/ MFC-J6955DW/MFC-J6957DW)	Set the 2-sided scanning format.
Document Size	Set the document size for outgoing faxes.
Scan Long Paper	Scan a long document using the ADF.
Broadcasting (monochrome only)	Send the same fax message to more than one fax number at the same time.
Preview (monochrome only)	Preview a fax message before you send it.
Colour Setting	Set whether faxes are sent in monochrome or colour. <ul style="list-style-type: none"> <li>Colour faxes cannot be stored in the machine's memory and the machine sends them immediately.</li> <li>Use the ADF to send colour faxes with multiple pages.</li> <li>You cannot send a colour fax when <i>Preview</i> is set to <i>On</i>.</li> </ul>
Delayed Fax (monochrome only)	Set the time of day the delayed faxes will be sent.
Batch TX (monochrome only)	Economise by sending all delayed faxes scheduled for the same time and fax number as one fax to save transmission time.
Real Time TX	Send a fax immediately without waiting for the machine to retrieve the scan from its memory.
Overseas Mode	Set to <i>On</i> if you have difficulty sending faxes overseas.
Call History	Select a number from the Call History.
Address Book	Select a number from the Address Book.
Set New Default	Save your settings as the default.
Factory Reset	Restore all settings back to the factory settings.



You can save the current settings by pressing [Save as Shortcut].

You will be asked if you want to make this a One Touch Shortcut. Follow the LCD instructions.



### Related Information

- [Send a Fax](#)

#### Related Topics:

- [Send a Fax from Your Brother Machine](#)

## Receive a Fax

- [Receive Mode Settings](#)
- [Set Fax Detect](#)
- [Fax Preview](#)
- [Shrink Page Size of an Oversized Incoming Fax](#)
- [Set the Fax Receive Stamp](#)
- [Receive a Fax at the End of a Telephone Conversation](#)
- [Memory Receive Options](#)
- [Remote Fax Retrieval](#)

## Receive Mode Settings

- [Receive Modes Overview](#)
- [Choose the Correct Receive Mode](#)
- [Set the Number of Rings Before the Machine Answers \(Ring Delay\)](#)
- [Set the F/T Ring Time \(Pseudo/Double-ring\)](#)

## Receive Modes Overview

Some receive modes answer automatically ([Fax Only] and [Fax/Tel]). You may want to change the Ring Delay before using these modes.

### Fax Only

[Fax Only] mode automatically answers every call as a fax.

### Fax/Tel

[Fax/Tel] mode helps you manage incoming calls, by recognising whether they are fax or voice calls and handling them in one of the following ways:

- Faxes are received automatically.
- Voice calls start the F/T ring to tell you to pick up the line. The F/T ring is a pseudo/double-ring made by your machine.

### Manual

To receive a fax in [Manual] mode, lift the handset of the external telephone or press the Hook <sup>1</sup> button. When you hear fax tones (short repeating beeps), press the Start button, and then select [Receive] to receive a fax. You can also use the Fax Detect feature to receive faxes by lifting a handset on the same line as the machine.

### External TAD

[External TAD] mode lets an external answering device manage your incoming calls.

Incoming calls are handled in the following ways:

- Faxes are received automatically.
- Voice callers can record a message on the external TAD.



### Related Information

- [Receive Mode Settings](#)

#### Related Topics:

- [Set the Number of Rings Before the Machine Answers \(Ring Delay\)](#)
- [Set the F/T Ring Time \(Pseudo/Double-ring\)](#)
- [Set Fax Detect](#)
- [Connect an External TAD](#)

<sup>1</sup> Not available in South Africa

## Choose the Correct Receive Mode

You must choose a Receive Mode depending on the external devices and telephone services you have on your line.

By default, your machine automatically will receive any faxes that are sent to it. The diagram below will help you select the correct mode.

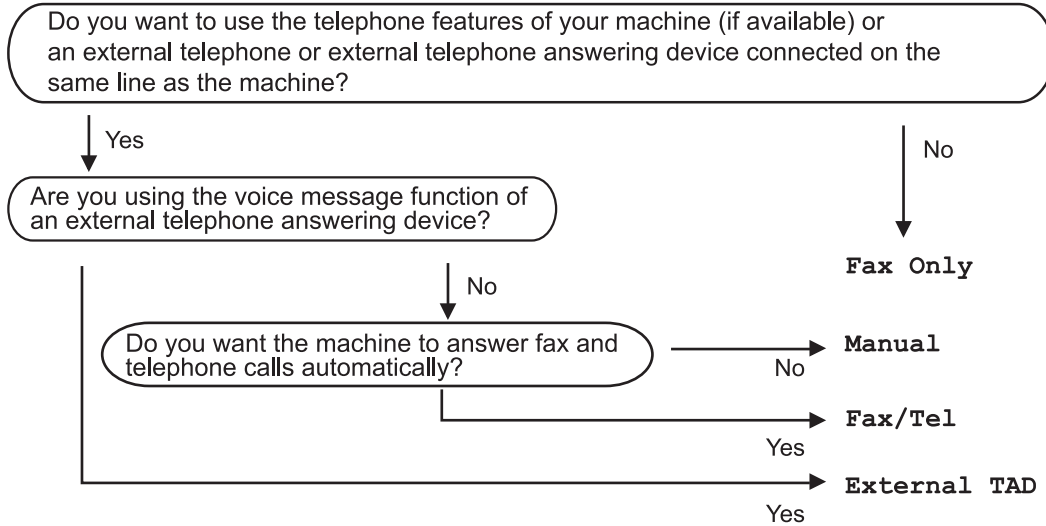

1. Press  [Settings] > [All Settings] > [Fax] > [Setup Receive] > [Receive Mode].



(For some countries)

If you cannot change the [Receive Mode] option, make sure the Distinctive Ring feature is set to [Off].

(For New Zealand)

If you cannot change the [Receive Mode] option, make sure the FaxAbility feature is set to [Off].

2. Press ▲ or ▼ to display the [Fax Only], [Fax/Tel], [External TAD], or [Manual] option, and then press the option you want.
3. Press .



### Related Information

- [Receive Mode Settings](#)

#### Related Topics:

- [Distinctive Ring](#)
- [Connect an External TAD](#)
- [Telephone and Fax Problems](#)
- [Remote Retrieval Commands](#)

## Set the Number of Rings Before the Machine Answers (Ring Delay)

When somebody calls your machine, you will hear the normal telephone ring sound. The number of rings is set in the Ring Delay option.

- The Ring Delay setting sets the number of times the machine rings before it answers in [Fax Only] and [Fax/Tel] modes.
- If you have external or extension telephones on the same line as the machine, select the maximum number of rings.

1. Press  [Settings] > [All Settings] > [Fax] > [Setup Receive] > [Ring Delay].

2. Press the number of times you want the line to ring before the machine answers.



If you select [0], the machine answers immediately and the line will not ring at all. (available only for some countries)

3. Press .



### Related Information

- [Receive Mode Settings](#)



#### Related Topics:

- [Receive Modes Overview](#)
- [Operation from External and Extension Telephones](#)
- [Set Fax Detect](#)
- [Telephone and Fax Problems](#)

## Set the F/T Ring Time (Pseudo/Double-ring)

When you set the Receive Mode to [Fax/Tel], if the call is a fax, your machine will receive it automatically. However, if it is a voice call, the machine will sound the F/T ring (pseudo/double-ring) for the time you set in the F/T Ring Time option. When you hear the F/T ring, it means that a voice caller is on the line.

Because the F/T ring is a setting only on your Brother machine, extension and external telephones will not ring; however, you can still answer the machine's call on any telephone.

1. Press  [Settings] > [All Settings] > [Fax] > [Setup Receive] > [F/T Ring Time].
2. Press how long the machine will double-ring to alert you to a voice call.
3. Press .



Even if the caller hangs up during the pseudo/double-ringing, the machine will continue to ring for the set time.



### Related Information

- [Receive Mode Settings](#)

#### Related Topics:

- [Receive Modes Overview](#)
- [Operation from External and Extension Telephones](#)



## Set Fax Detect

**If Fax Detect is On:** The machine receives a fax call automatically, even if you answer the call. When the message that your machine is receiving a fax appears on the LCD or when you hear “chirps” through the handset you are using, just replace the handset. Your machine will do the rest.

**If Fax Detect is Off:** If you are at the machine and answer a fax call by lifting the handset, press the Start button, and then select [Receive] to receive the fax. If you answered at an extension or external telephone, press \*51 (\*91 for New Zealand).



- If Fax Detect is set to [On], but your machine does not connect a fax call when you lift an extension or external telephone handset, press the remote activation code \*51 (\*91 for New Zealand).
- If you send faxes from a computer on the same telephone line and the machine intercepts them, set Fax Detect to [Off].

1. Press  [Settings] > [All Settings] > [Fax] > [Setup Receive] > [Fax Detect].
2. Press [On] (or [Off]).
3. Press .



### Related Information

- [Receive a Fax](#)

#### Related Topics:

- [Receive Modes Overview](#)
- [Set the Number of Rings Before the Machine Answers \(Ring Delay\)](#)
- [Operation from External and Extension Telephones](#)
- [Use the Remote Codes](#)
- [Telephone and Fax Problems](#)

## Fax Preview

Use the Fax Preview feature to view received faxes on the LCD.

- [Set Fax Preview to On](#)
- [Preview New Faxes](#)

## Set Fax Preview to On

- This feature is available only for monochrome faxes.
- When Fax Preview is turned on, a backup copy of received faxes will not be printed for Fax Forwarding, PC-Fax Receiving and Forward to Cloud operations, even if you set Backup Print to On.
- Although printed faxes show the received date and time when Fax Receive Stamp is turned on, the Fax Preview screen will not display the received date and time.

1. Press  [Settings].

2. Press  [Fax Preview].

3. Press [On] (or [Off]).

The touchscreen displays a message saying future received faxes will not be printed.

4. Press [Yes].

5. Press .



If faxes are stored in the memory when you change Fax Preview to Off, do one of the following:

- If you do not want to print the stored faxes, press [Continue].  
Press [Yes] to confirm.  
Your faxes will be deleted.
- To print all the stored faxes, press [Print All Faxes Before Delete].
- If you do not want to turn off Fax Preview, press [Cancel].





### Related Information

- [Fax Preview](#)

## Preview New Faxes

When a fax is received, a message appears on the LCD.

- This feature is available only for monochrome faxes.
- To see a fax you already previewed, press  [Fax] and  [Received Faxes].

1. Press  to view new faxes.

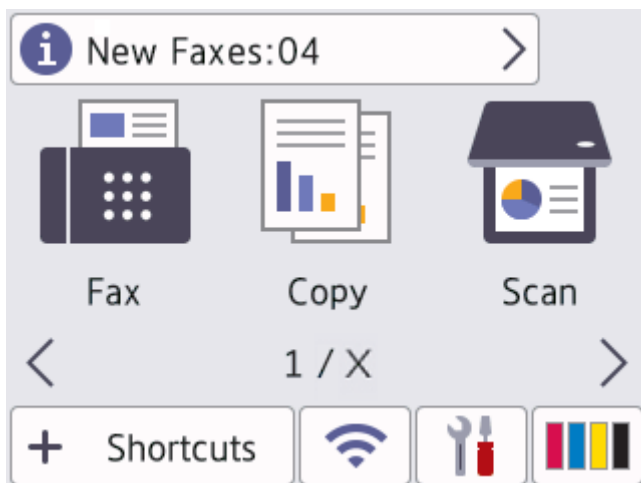

2. The fax list includes old and new faxes. A green mark appears next to new faxes. Press the fax you want.

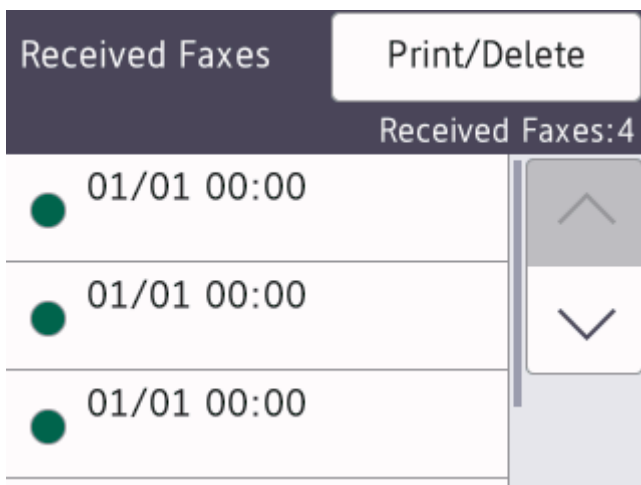











 If you want to print or delete all the faxes in the list, press [Print/Delete].

Do one of the following:

- Press [Print All (New Faxes)] to print all faxes you have not yet viewed.
- Press [Print All (Old Faxes)] to print all faxes you have viewed.
- Press [Delete All (New Faxes)] to delete all faxes you have not yet viewed.
- Press [Delete All (Old Faxes)] to delete all faxes you have viewed.

3. Perform the following operations by pressing the buttons shown in the table:

Button	Result
	Enlarge the fax.

Button	Result
	Reduce the fax.
 or 	Scroll vertically.
 or 	Scroll horizontally.
	Rotate the fax clockwise.
	Delete the fax. Press <b>Yes</b> to confirm.
	Go back to the previous page.
	Go to the next page.
	Go back to the fax list.
Start	<p>Print the fax.</p> <p>If the fax is a single page, it starts printing. A touchscreen message asks if you want to delete the fax from the machine's memory. To delete the fax, press <b>Yes</b>. To keep the fax in the machine's memory, press <b>No</b>.</p> <p>If the fax has multiple pages, do one of the following:</p> <ul style="list-style-type: none"> <li>• Press <b>Print All Pages</b> to print the whole message. A touchscreen message asks if you want to delete the fax from the machine's memory. To delete the fax, press <b>Yes</b>. To keep the fax in the machine's memory, press <b>No</b>.</li> <li>• Press <b>Print Displayed Only</b> to print only the displayed page.</li> <li>• Press <b>Print From Displayed</b> to print from the displayed page to the last page.</li> </ul>

- If your fax is large there may be a delay before it is displayed.
- The touchscreen displays the current page number and total pages of the fax message.

4. Press .





## Related Information

- [Fax Preview](#)

## Shrink Page Size of an Oversized Incoming Fax

When the [Auto Reduction] feature is [On], your Brother machine reduces any oversized incoming fax page to fit on your paper. The machine calculates the reduction ratio using the page size of the fax, and your Paper Size setting.

1. Press  [Settings] > [All Settings] > [Fax] > [Setup Receive] > [Auto Reduction].
2. Press [On] (or [Off]).
3. Press .

### Related Information

- [Receive a Fax](#)



#### Related Topics:

- [Paper Settings](#)
- [Paper Handling and Printing Problems](#)

## Set the Fax Receive Stamp

Set the machine to print the date and time of receipt at the top of each incoming fax page. Make sure you have set the current date and time on the machine.

This feature is available only for monochrome faxes.

1. Press  [Settings] > [All Settings] > [Fax] > [Setup Receive] > [Fax Rx Stamp].
2. Press [On] (or [Off]).
3. Press .

### Related Information

- [Receive a Fax](#)

## Receive a Fax at the End of a Telephone Conversation

If you are speaking on the telephone connected to your machine and the other party is also speaking on a telephone connected to his fax machine, at the end of the conversation, the other party can send you a fax before you both hang up.

- Your machine's ADF must be empty.

  1. Ask the other party to load the fax and to press the Start or Send key.
  2. Press  to display the [Fax Start] button.
  3. When you hear CNG tones (slow, repeated beeps), press [Fax Start].
  4. Press [Receive] to receive the fax.
  5. Replace the external handset.

### Related Information

- [Receive a Fax](#)

## Memory Receive Options

Use Memory Receive options to direct incoming faxes while you are away from the machine. You can use only one Memory Receive option at a time.

Memory Receive can be set to:

- Fax Forwarding
- Fax Storage
- PC-Fax Receive
- Forward to Cloud

The machine forwards your received faxes to the online services.

- Off

This feature is available only for monochrome faxes.

- [Forward Incoming Faxes to Another Machine](#)
- [Store Incoming Faxes in the Machine's Memory](#)
- [Use PC-Fax Receive to Transfer Received Faxes to Your Computer \(Windows only\)](#)
- [Change Memory Receive Options](#)
- [Turn Off Memory Receive](#)
- [Print a Fax Stored in the Machine's Memory](#)
- [Turn On FaxForward to Cloud or E-mail](#)

## Forward Incoming Faxes to Another Machine

Use the Fax Forwarding feature to automatically forward your incoming faxes to another machine.

This feature is available only for monochrome faxes.

1. Press  [Settings] > [All Settings] > [Fax] > [Setup Receive] > [Memory Receive].
2. Press ▲ or ▼ to display the [Fax Forward] option, and then press it.
3. Enter the forwarding fax number (up to 20 digits) using the dial pad.  
Press [OK].



To forward a fax to an email address, press , enter the email address, and then press [OK].

4. Press [Backup Print: On] or [Backup Print: Off].



- If you select [Backup Print: On], the machine prints received faxes at your machine so you will have a copy.
- When Fax Preview is turned on, a backup copy of received faxes will not be printed.
- If you receive a colour fax, your machine only prints the colour fax and does not forward it to the Fax Forwarding number you programmed.

5. Press .





### Related Information

- [Memory Receive Options](#)

## Store Incoming Faxes in the Machine's Memory

Use the Fax Storage feature to store incoming faxes in the machine's memory. Retrieve your stored fax messages from your fax machine when you are at another location using the Remote Retrieval commands. Your machine prints a backup copy of each stored fax.

- This feature is available only for monochrome faxes.

1. Press  [Settings] > [All Settings] > [Fax] > [Setup Receive] > [Memory Receive].
2. Press ▲ or ▼ to display the [Fax Storage] option, and then press it.
3. Press .

### Related Information

- [Memory Receive Options](#)

#### Related Topics:

- [Forward Faxes Remotely](#)
- [Print a Fax Stored in the Machine's Memory](#)
- [Remote Retrieval Commands](#)

## Use PC-Fax Receive to Transfer Received Faxes to Your Computer (Windows only)

Turn on the PC-Fax Receive feature to automatically store incoming faxes to your machine's memory, and then send them to your computer. Use your computer to view and store these faxes.

- This feature is available only for monochrome faxes. When you receive a colour fax, your machine prints the colour fax but does not send the fax to your computer.
- Before you can set up PC-Fax Receive, you must install the Brother software and drivers on your computer. Make sure your computer is connected and turned on. You must have the PC-FAX Receiving software running on your computer.

Even if your computer is turned off, your machine will receive and store faxes in its memory. When you start your computer and the PC-FAX Receiving software runs, your machine transfers faxes to your computer automatically.

1. Press  [Settings] > [All Settings] > [Fax] > [Setup Receive] > [PC Fax Receive].
2. Press [On].  
The touchscreen displays the message [Run the PC-Fax Receive program on your computer.].
3. Press [OK].
4. Press [<USB>] or press the name of the destination computer you want to receive faxes if you are on a network. Press [OK].
5. Press [Backup Print: On] or [Backup Print: Off].



When Fax Preview is turned on, a backup copy of received faxes will not be printed.

6. Press .

To change the destination computer, repeat these steps.

### Related Information

- [Memory Receive Options](#)

#### Related Topics:

- [Transfer Your Faxes or Fax Journal Report](#)
- [Transfer Faxes to Your Computer](#)
- [Receive Faxes Using PC-FAX Receive \(Windows\)](#)

## Change Memory Receive Options

If there are faxes in your machine's memory when you change any Memory Receive option, the LCD displays one of the following questions:

- **If received faxes have already been printed, the touchscreen displays [Erase all documents?]**
  - If you press [Yes], faxes in the memory will be erased before the setting changes.
  - If you press [No], faxes in the memory will not be erased and the setting will be unchanged.
- **If unprinted faxes are in the machine's memory, the touchscreen displays [Print all faxes?]**
  - If you press [Yes], faxes in the memory will be printed before the setting changes.
  - If you press [No], faxes in the memory will not be printed and the setting will be unchanged.
- If received faxes are left in the machine's memory when you change to [PC Fax Receive] from another option ([Fax Forward], [Forward to Cloud], or [Fax Storage]), press [<USB>] or the name of the computer if you are on a network, and then press [OK]. You will be asked if you want to turn on Backup Print.

The touchscreen displays:

[Send Fax to PC?]

- If you press [Yes], faxes in the memory will be sent to your computer before the setting changes.
- If you press [No], faxes in the memory will not be erased and the setting will be unchanged.



### Related Information

- [Memory Receive Options](#)

#### Related Topics:

- [Turn Off Memory Receive](#)

## Turn Off Memory Receive

Turn off Memory Receive if you do not want the machine to save or transfer incoming faxes.

1. Press  [Settings] > [All Settings] > [Fax] > [Setup Receive] > [Memory Receive].
2. Press [Off].



The touchscreen displays [Print all faxes?] or [Erase all documents?] if received faxes are in your machine's memory.

3. Press .



### Related Information

- [Memory Receive Options](#)

#### Related Topics:

- [Change Memory Receive Options](#)
- [Error and Maintenance Messages](#)
- [Telephone and Fax Problems](#)

## Print a Fax Stored in the Machine's Memory

- This feature is available only for monochrome faxes.
- After you print the fax, it is erased from the machine's memory.

If you select [Fax Storage], you can print all faxes from the memory.

1. Press  [Settings] > [All Settings] > [Fax] > [Print Document].



You can also print the faxes from the memory by pressing [Stored Faxes] on the touchscreen.

2. Press [Yes].



### Related Information

- [Memory Receive Options](#)

#### Related Topics:

- [Store Incoming Faxes in the Machine's Memory](#)
- [Error and Maintenance Messages](#)
- [Telephone and Fax Problems](#)

## Remote Fax Retrieval

Use Remote Retrieval to call your machine from any touch-tone telephone or fax machine, and use a remote access code and remote commands to retrieve fax messages.

- [Set a Remote Access Code](#)
- [Use Your Remote Access Code](#)
- [Remote Retrieval Commands](#)
- [Forward Faxes Remotely](#)
- [Change the Fax Forwarding Number](#)

## Set a Remote Access Code

Set a Remote Access Code to access and control your machine even when you are away from it.

1. Press  [Settings] > [All Settings] > [Fax] > [Remote Access].
2. Enter a three-digit code using the numbers [0] through [9], [\*], or [#] using the dial pad (The preset '\*\*' cannot be changed).

Press [OK].



- DO NOT use the same code used for your Remote Activation Code (\*51) (\*91 for New Zealand) or Remote Deactivation Code (#51) (#91 for New Zealand).
- To delete your code, press and hold  to restore the inactive setting (- - - \*), and then press [OK].

3. Press .



### Related Information

- [Remote Fax Retrieval](#)

#### Related Topics:

- [Use Your Remote Access Code](#)
- [Operation from External and Extension Telephones](#)
- [Use the Remote Codes](#)

## Use Your Remote Access Code

1. When away from your Brother machine, dial your fax number from a touch-tone telephone or fax machine.
2. When your machine answers, immediately enter your three-digit Remote Access Code, followed by \*.
3. Your Brother machine signals if it has received faxes:
  - One long beep - the machine received at least one fax
  - No beeps - the machine has not received a fax
4. When the machine gives two short beeps, enter a command.
  - The machine will hang up if you wait longer than 30 seconds to enter a command.
  - The machine will beep three times if you enter an invalid command.
5. When finished, press 9, and then press 0 to deactivate your machine.
6. Hang up.



This feature may not be available in some countries or supported by your local telephone company.



### Related Information

- [Remote Fax Retrieval](#)

#### Related Topics:

- [Set a Remote Access Code](#)

## Remote Retrieval Commands

Use the Remote Commands in this table to access fax commands and options when you are away from your machine. When you call the machine and enter your remote access code (three digits followed by \*), the system will sound two short beeps and you must enter a Remote Command (column 1), followed by one of the options (column 2) for that command.

Remote commands	Options	Operation details
95	<b>Change the Fax Forwarding, or Fax Storage settings</b>	
	1 OFF	You can select <i>Off</i> after you retrieve or erase all your messages.
	2 Fax Forwarding	One long beep means the change is accepted. If you hear three short beeps, you cannot make a change because something has not been set up (for example, a Fax Forwarding number has not been registered). You can register your Fax Forwarding number by entering 4. After you register the number, Fax Forwarding will work.
	4 Fax Forwarding number	
	6 Fax Storage	
96	<b>Retrieve a fax</b>	
	2 Retrieve all faxes	Enter the fax number of a remote fax machine to receive stored fax messages.
	3 Erase faxes from memory	If you hear one long beep, fax messages have been erased from memory.
97	<b>Check the receiving status</b>	
	1 Fax	Check whether your machine has received any faxes. If yes, you will hear one long beep. If not, you will hear three short beeps.
98	<b>Change the Receive Mode</b>	
	1 External TAD	One long beep means the change has been accepted.
	2 Fax/Tel	
	3 Fax Only	
90	<b>Exit</b>	Press <b>9 0</b> to stop remote retrieval. Wait for the long beep, then hang up.



### Related Information

- [Remote Fax Retrieval](#)

#### Related Topics:

- [Change the Fax Forwarding Number](#)
- [Store Incoming Faxes in the Machine's Memory](#)
- [Forward Faxes Remotely](#)

## Forward Faxes Remotely

Call your machine from any touch-tone telephone or fax machine to forward incoming faxes to another machine.

- You must turn on Fax Storage, or Fax Preview before you use this feature.

- Dial your fax number.
- When your machine answers, enter your Remote Access Code (three digits followed by \*). If you hear one long beep, you have messages.
- When you hear two short beeps, press 9 6 2.
- Wait for the long beep, and then use the dial pad to enter the fax number (up to 20 digits) of the remote fax machine where you want your fax messages sent, followed by # #.



You cannot use \* and # as dial numbers but you can press # to insert a pause in the fax number.

- Hang up after you hear one long beep. Your Brother machine will forward any incoming faxes to the fax number you entered. The other fax machine will then print your fax messages.



### Related Information

- [Remote Fax Retrieval](#)

#### Related Topics:

- [Store Incoming Faxes in the Machine's Memory](#)
- [Remote Retrieval Commands](#)

## Change the Fax Forwarding Number

1. Dial your fax number.
2. When your machine answers, enter your Remote Access Code (three digits followed by \*). If you hear one long beep, you have messages.
3. When you hear two short beeps, press 9 5 4.
4. Wait for the long beep, enter the new number (up to 20 digits) of the remote fax machine you want your fax messages forwarded to using the dial pad, then enter # #.



You cannot use \* and # as dial numbers but you can press # to insert a pause in the fax number.

5. Press 9 0 to stop Remote Access when finished.
6. Hang up after you hear one long beep.



### Related Information

- [Remote Fax Retrieval](#)

#### Related Topics:

- [Remote Retrieval Commands](#)

## Voice Operations and Fax Numbers

- [Voice Operations](#)
- [Store Fax Numbers](#)
- [Set up Broadcasting Groups](#)

## Voice Operations

- [Send Tone Signals](#)
- [Pick up a Voice Call in Fax/Tel Receive Mode](#)

## Send Tone Signals

If you have a Pulse dialling service, but must send Tone signals (for example, for telephone banking), follow these steps. If you have a Touch Tone service, you will not need this feature to send tone signals.

This feature is not available in the New Zealand.

1. Press  [Fax].



If [Fax Preview] is set to [On], press  [Fax] > [Sending Faxes].

2. Press [Hook].
3. Press # using the dial pad. Any digits dialled after this will send tone signals.

When you are finished with the call, the machine will return to the Pulse dialling service.



### Related Information

- [Voice Operations](#)

## Pick up a Voice Call in Fax/Tel Receive Mode

When the machine is in Fax/Tel mode, it will use the F/T Ring (pseudo/double-ringing) to alert you to pick up a voice call.

If you are at the machine, lift the external telephone's handset, and then press `[Pickup]` button to answer.

If you are at an extension telephone, lift the handset during the F/T Ring and then press `#51` (`#91` for New Zealand) between the pseudo/double rings. If no one is on the line, or if someone wants to send you a fax, send the call back to the machine by pressing `*51` (`*91` for New Zealand).



### Related Information

- [Voice Operations](#)
-

## Store Fax Numbers

- [Store Address Book Numbers](#)
- [Save Outgoing Call Numbers to the Address Book](#)
- [Save Caller ID History Numbers to the Address Book](#)
- [Change or Delete Address Book Names or Numbers](#)

## Store Address Book Numbers

1. Press  [Fax] > [Address Book].
2. Do the following steps:
  - a. Press [Edit] > [Add New Address] > [Name].
  - b. Enter the name (up to 16 characters) using the touchscreen. Press [OK].
  - c. Press [Address 1].
  - d. Enter the first fax or telephone number (up to 20 digits) using the touchscreen. Press [OK].



- Press [Pause] to insert a pause between numbers. You can press [Pause] as many times as needed to increase the length of the pause.
- Be sure to include the area code when entering a fax or telephone number. Depending on the country, the Caller ID names and history may not be displayed correctly if the area code is not registered with the fax or telephone number.
- To store an email address to use with Internet Fax or Scan to E-mail server, press  and enter the email address, and then press [OK].

- e. To store the second fax or telephone number, press [Address 2]. Enter the second fax or telephone number (up to 20 digits) using the touchscreen. Press [OK].
- f. Press [OK] to confirm.

To store another Address Book number, repeat these steps.

3. Press .



### Related Information

- [Store Fax Numbers](#)

#### Related Topics:

- [Set up Broadcasting Groups](#)

## Save Outgoing Call Numbers to the Address Book

You can copy numbers from your Outgoing Call history and save them in your Address Book.

1. Press  [Fax] > [Call History] > [Outgoing Call].
2. Press ▲ or ▼ to display the number you want to store, and then press it.
3. Press [Edit] > [Add to Address Book] > [Name].



---

To delete the number from the Outgoing Call history list, press [Edit] > [Delete]. Press [Yes] to confirm.

---

4. Enter the name (up to 16 characters) using the touchscreen. Press [OK].
5. To store the second fax or telephone number, press [Address 2]. Enter the second fax or telephone number (up to 20 digits) using the touchscreen. Press [OK].
6. Press [OK] to confirm the fax or telephone number you want to store.
7. Press .



### Related Information

- [Store Fax Numbers](#)

#### Related Topics:

- [Enter Text on Your Brother Machine](#)
-

## Save Caller ID History Numbers to the Address Book

If you have a Caller ID subscriber service with your telephone company, you can copy numbers from your Caller ID History and save them in your Address Book.

This feature is not available for Taiwan and some countries.

1. Press  [Fax] > [Call History] > [Caller ID History].
2. Press ▲ or ▼ to display the name or number you want to store, and then press it.
3. Press [Edit] > [Add to Address Book] > [Name].



To delete the number from the Caller ID History list, press [Edit] > [Delete]. Press [Yes] to confirm.

4. Enter the name (up to 16 characters) using the touchscreen. Press [OK].
5. To store the second fax or telephone number, press [Address 2]. Enter the second fax or telephone number (up to 20 digits) using the touchscreen. Press [OK].
6. Press [OK] to confirm the fax or telephone number you want to store.
7. Press .



### Related Information

- [Store Fax Numbers](#)

#### Related Topics:

- [Caller ID](#)
- [Enter Text on Your Brother Machine](#)

## Change or Delete Address Book Names or Numbers

1. Press  [Fax] > [Address Book] > [Edit].
2. Do one of the following:
  - Press [Change] to edit the names or fax or telephone numbers.  
Press ▲ or ▼ to display the number you want to change, and then press it.
    - To change the name, press [Name]. Enter the new name (up to 16 characters) using the touchscreen. Press [OK].
    - To change the first fax or telephone number, press [Address 1]. Enter the new fax or telephone number (up to 20 digits) using the touchscreen. Press [OK].
    - To change the second fax or telephone number, press [Address 2]. Enter the new fax or telephone number (up to 20 digits) using the touchscreen. Press [OK].Press [OK] to finish.



To change a character, press ◀ or ▶ to position the cursor to highlight the character you want to change, and then press . Enter the new character.

- To delete numbers, press ▲ or ▼ to display [Delete], and then press it.
    - Select the fax or telephone numbers you want to delete by pressing them to display check marks, and then press [OK].
3. Press .



### Related Information

- [Store Fax Numbers](#)

## Set up Broadcasting Groups

Creating and sending to a Group, which can be stored in the Address Book, allows you to send the same fax message to many fax numbers, or Broadcast.

First, you must store each fax number in the Address Book. Then, you can include them as numbers in the Group. Each Group uses up an Address Book number. You can store up to six Groups or you can assign up to 198 numbers to a large Group.

1. Press  [Fax] > [Address Book].
2. Do the following steps:
  - a. Press [Edit] > [Setup Groups] > [Name].
  - b. Enter the Group name (up to 16 characters) using the touchscreen. Press [OK].
  - c. Press [Add/Delete].
  - d. Add Address Book numbers to the Group by pressing them to display a checkmark. Press [OK].
  - e. Read and confirm the displayed list of names and numbers you have selected, and then press [OK] to save your Group.

To store another Group for broadcasting, repeat these steps.

3. Press .



### Related Information

- [Voice Operations and Fax Numbers](#)
  - [Change a Broadcasting Group Name](#)
  - [Delete a Broadcasting Group](#)
  - [Add or Delete a Broadcasting Group Member](#)

#### Related Topics:

- [Send the Same Fax to More than One Recipient \(Broadcasting\)](#)
- [Store Address Book Numbers](#)

## Change a Broadcasting Group Name

1. Press  [Fax] > [Address Book] > [Edit] > [Change].
2. Press ▲ or ▼ to display the Group you want to change, and then press it.
3. Press [Name].
4. Enter the new Group name (up to 16 characters) using the touchscreen. Press [OK].



To change a character, press ◀ or ▶ to position the cursor to highlight the incorrect character, and then press .

Enter the new character.

5. Press [OK].
6. Press .





### Related Information

- [Set up Broadcasting Groups](#)

#### Related Topics:

- [Enter Text on Your Brother Machine](#)

## Delete a Broadcasting Group



1. Press  [Fax] > [Address Book] > [Edit] > [Delete].
2. Press ▲ or ▼ to display the Group you want to delete, and then press it.
3. Press [OK].
4. Press .



### Related Information

- [Set up Broadcasting Groups](#)

## Add or Delete a Broadcasting Group Member

1. Press  [Fax] > [Address Book] > [Edit] > [Change].
2. Press ▲ or ▼ to display the Group you want to change, and then press it.
3. Press ▲ or ▼ to display [Add/Delete], and then press it.
4. Press ▲ or ▼ to display the number you want to add or delete.
5. Do the following for each number you want to change:
  - To add a number to the Group, press the check box of the number to add a check mark.
  - To delete a number from the Group, press the check box of the number to remove the check mark.
6. Press [OK].
7. Press [OK].
8. Press .



### Related Information

- [Set up Broadcasting Groups](#)

## Telephone Services and External Devices

- [Distinctive Ring](#)
- [Caller ID](#)
- [Set the Telephone Line Type](#)
- [FaxAbility](#)
- [Voice Over Internet Protocol \(VoIP/Telephone Line Interference\)](#)
- [External TAD \(Telephone Answering Device\)](#)
- [External and Extension Telephones](#)

## Distinctive Ring



This feature is available only for some countries.

### For Australia

Distinctive Ring is a function of your Brother machine that allows a person with one line to receive fax and voice calls through two different phone numbers on that one line. Brother uses the term “Distinctive Ring”, but telephone companies market the service under a variety of names. This service establishes a second telephone number on the same line as your existing telephone number, and each number has its own ring pattern. Typically, the original number rings with the standard ring pattern and is used for receiving voice calls, and the second number rings with a different ring pattern and is used for receiving faxes. Only one call can be answered (or made) at any one time and while this call is in progress, incoming calls to either number will be presented with a busy tone.



- Contact your Telephone Service Provider to determine Distinctive Ring availability and any other related details.
- After you have set the Distinctive Ring feature to On, the receive mode is set to [Manual] automatically. Your Distinctive Ring Number does not allow Voice calls - only Faxes. You can not change the receive mode from [Manual] mode while the Distinctive Ring is set to on.

### How does your telephone company’s ‘Distinctive Ring’ service work?

Using “Distinctive Ring” service of your telephone company is the most efficient way to receive both fax and telephone calls on the same line. When the voice call comes in, all phones (extension and external) and the fax machine will ring to alert you to pick it up. If a fax call comes in, the fax machine will answer automatically without ringing, whereas the extension and external phones will ring twice with a Distinctive Ring pattern. It is also a more efficient way of operating a Fax machine with an extension phone as you do not have to use the remote activation codes. It gives you two independent numbers without the higher cost of a second line.

### Flowchart Sequence of Incoming call

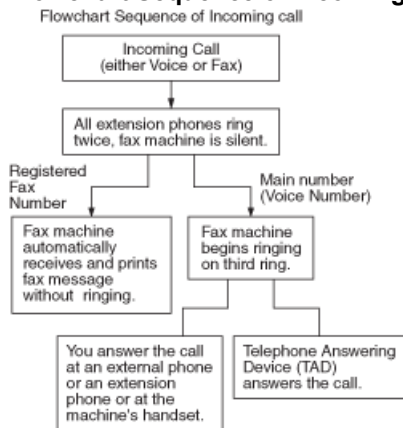

### What does Brother’s ‘Distinctive Ring’ do?

The Brother machine has a Distinctive Ring feature that allows you to use your machine to take full advantage of the telephone company’s Distinctive Ring service. The new telephone number on your line can just receive faxes.

### For Singapore and Hong Kong

This machine feature lets you use the Distinctive Ring subscriber service offered by some telephone companies, which allows you to have several telephone numbers on one phone line. Each phone number has its own Distinctive Ring pattern, so you will know which phone number is ringing. This is one way you can have a separate phone number for your machine.

Your machine has a Distinctive Ring function, allowing you to dedicate one phone number just for receiving faxes. You will need to set Distinctive Ring to On.



- You can switch it off temporarily, then turn it back on. When you get a new fax number, make sure you reset this function.
  - The machine will answer only calls to the Distinctive Ring number.
- 



### Related Information

- [Telephone Services and External Devices](#)
  - [Turn on Distinctive Ring](#)
  - [Turn off Distinctive Ring](#)

#### Related Topics:

- [Settings Screen Overview](#)
  - [Choose the Correct Receive Mode](#)
-

## Turn on Distinctive Ring



This feature is available only for some countries.

### For Australia



After you set the Distinctive Ring feature to [On], the receive mode is automatically set to [Manual]. Your Distinctive Ring Number does not allow Voice calls - only Faxes. You cannot change the receive mode to another mode while the Distinctive Ring is set to on.

### For Singapore and Hong Kong

After you set the Distinctive Ring feature to [On], the receive mode is automatically set to [Manual]. Unless you have a TAD or Voice Mail set up on the Distinctive Ring number, Manual mode means you must answer all the calls yourself. You cannot change the receive mode to another mode while the Distinctive Ring is set to on.



When Distinctive Ring is on, the touchscreen will show [D/R] as the Receive Mode.

1. Press  [Settings] > [All Settings] > [Fax] > [Miscellaneous] > [Distinctive].
2. Press [On].
3. Press .

Distinctive Ring is now set to [On].





### Related Information

- [Distinctive Ring](#)

## Turn off Distinctive Ring



This feature is available only for some countries.

1. Press  [Settings] > [All Settings] > [Fax] > [Miscellaneous] > [Distinctive].
2. Press [Off].
3. Press .

When you turn off Distinctive Ring, the machine will stay in [Manual] mode. You must set the Receive Mode again.



### Related Information

- [Distinctive Ring](#)

#### Related Topics:

- [Error and Maintenance Messages](#)

## Caller ID

This feature is not available for Taiwan and some countries.

### For Australia and New Zealand

Caller ID is a telephone service that allows the subscriber to see a display of the caller's phone number or name as the telephone rings. It is a fast way to screen your calls. You can respond quickly to calls you missed, because Caller IDs are received and stored in your machine memory.



---

To get the Caller ID Service: apply for the Caller ID service at your local telephone company, if available.

---

### Advantages of Caller ID

#### For Business

All businesses profit from a quicker response to customer calls. Businesses that provide mail order services, money-lending services or provide confidential information, can protect themselves from false orders or acceptance of false identification.

#### At Home

Residential customers can protect themselves from unwanted calls.

### How Does the Caller ID Work?

The Caller ID appears on the display when your telephone rings.

As your telephone rings, the display shows you the caller's phone number or name if the name has been stored in the Address Book. Once you answer the call, the caller's ID disappears.



- 
- If [ID Unknown] appears on the display, it means that the call came from outside your caller ID service area or a public phone. (Depends on network function.)
  - If [ID Withheld] appears on the display, it means the caller intentionally blocked the transmission of his/her ID. (Depends on network function.)
- 

### The Caller ID is Stored in Your Machine Memory

The machine can store a maximum of the last 30 incoming caller IDs in the memory, along with the time and date of reception. The 31st call will cause the oldest ID to be erased.

The Caller ID information stored in the memory can be used for the following:

- **Printing the Caller ID List.**

You can review calls you received by checking the Caller IDs in memory. This report will list the Date, Time, Phone Number (Caller ID) name, and type of Call (Comment) if available.

### For Singapore and Hong Kong

The Caller ID feature of this machine lets you use the Caller ID subscriber service offered by many local phone companies. Call your telephone company for details. This service provides you, by means of the screen display, the telephone number (or name) of your caller as the line rings.

After a few rings, the screen displays the telephone number of your caller (or name, if available). Once you answer the call, the Caller ID information disappears from the screen, but the call information remains stored in the Caller ID memory.

- The [ID Unknown] message means the call originated outside your Caller ID service area.
- The [ID Withheld] message means the caller has intentionally blocked transmission of Caller ID information.



- 
- You can print a list of Caller ID information received by your machine.
  - Caller ID service varies with different carriers. Call your local phone company to determine the kind of service available in your area.
-



---

## Related Information

---

- [Telephone Services and External Devices](#)

### **Related Topics:**

- [Save Caller ID History Numbers to the Address Book](#)
  - [Print a Report](#)
  - [Error and Maintenance Messages](#)
-

## Set the Telephone Line Type

This feature is available only in South Africa.

If you are connecting the machine to a line that features PBX or ISDN to send and receive faxes, you must select a Telephone Line Type that matches your line's features.

1. Press  [Settings] > [All Settings] > [Initial Setup] > [Phone Line Set].
2. Press [Normal], [PBX], or [ISDN].
3. If you selected [PBX], do the following steps:
  - a. Press [On] or [Always].



- If you select [On], the machine dials a prefix number before the fax number only when [R] is pressed.
- If you select [Always], the machine always dials a prefix number before the fax number.

- b. Press [Dial Prefix].
- c. Enter the prefix number using the touchscreen, and then press [OK].



Use the numbers 0 to 9, #, \* and !. You cannot use ! with any other numbers or characters.

4. Press .



### Related Information

- [Telephone Services and External Devices](#)
  - [PBX and TRANSFER](#)

#### Related Topics:

- [Telephone and Fax Problems](#)

## PBX and TRANSFER

This feature is available only in South Africa.

The machine's [Phone Line Set] default setting is [Normal], which lets the machine connect to a standard Public Switched Telephone Network (PSTN) line. However, many offices use a central telephone system or Private Branch Exchange (PBX). Your machine can be connected to most types of PBX. The machine's recall feature supports timed break recall only (TBR). TBR will work with most PBX systems allowing you to gain access to an outside line, or transfer calls to another extension. Press [R] to use this feature.



Program a press of the [R] button as part of a number stored in the Address Book. When programming the Address Book number, press [R] first (the LCD displays '!'), then enter the telephone number. This avoids having to press [R] each time before you dial from the Address Book. However, your Telephone Line Type must be set to PBX on the machine for you to use this feature.



### Related Information

- [Set the Telephone Line Type](#)

## FaxAbility

This feature is available only in New Zealand.

FaxAbility is a service offered by Telecom that allows you to have an additional number on one phone line, with its own distinctive ring pattern. This way, when you get an incoming call, you can identify the number being called by its ring.

### How Will the Fax Machine Treat All Other Numbers?

FaxAbility mode ensures that the machine will answer calls to the FaxAbility (secondary) number. When a call comes in to your main number, all the phones will ring. You can set an external answering device (TAD) to answer calls on the other number(s). (See the chart below.)

### What is the Advantage of Using the FaxAbility Function?

Using FaxAbility is the most efficient way to receive both fax and telephone calls on the same line. It is much easier for your callers who dial manually. The fax machine will answer with receiving tones so they will not have to press an activation code. And the people who call to talk on your main number will not have to talk to your fax machine. Basically, it gives you two independent numbers without the higher cost of a second line.

### How Does FaxAbility Work?

For example, Your telephone number will have the standard ring pattern of long, long tone, while the new number will have a ring pattern of long, silence, long. When FaxAbility is On, you will not hear the first ring of all incoming calls on the fax machine. Extension phones will ring as usual. If the fax machine recognises the ring pattern, all ringing will stop and the fax machine will answer and automatically receive the fax message. Otherwise, you will hear the extension phones and the fax machine continue to ring. The fax machine always listens to the ring pattern before it answers, so do not pick up the phone during that time. You will quickly learn to recognise the ring pattern for faxes, so you will not be tempted to answer that number. Either you or a telephone answering device can answer the main number(s).

#### Flowchart Sequence of Incoming call

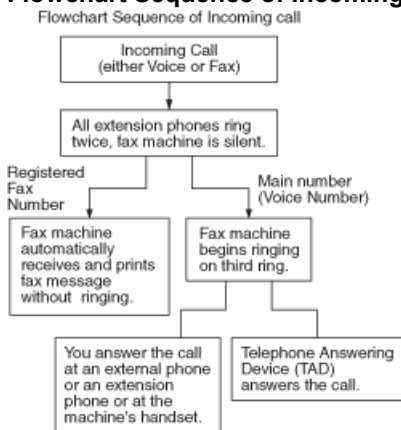

After you have set the FaxAbility feature to on, the receive mode is set to [Manual] automatically. Unless you have a TAD or Voice Mail set up on the FaxAbility number, Manual mode means you must answer all the call yourself. You can not change the receive mode to the other mode while the FaxAbility is set to on. When FaxAbility is on, the LCD will show [D/R] as the Receive Mode.



### Related Information



- [Telephone Services and External Devices](#)
  - [Turn FaxAbility Off or On](#)

## Turn FaxAbility Off or On

This feature is available only in New Zealand.

The FaxAbility function is designed to accommodate the FaxAbility service provided by Telecom.

Call Waiting beeps caused by incoming calls on your main number can affect fax transmissions. If you have FaxAbility Service but don't have Call Waiting, you need do nothing at this stage. If you do have Call Waiting as well as FaxAbility, set the Call Waiting menu option to On.

1. Press  [Settings] > [All Settings] > [Fax] > [Miscellaneous] > [FaxAbility].
2. Press [On] (or [Off]) to set FaxAbility.  
If you have FaxAbility service, press [On].
3. Press [Call Waiting].
4. Press [On] to set Call Waiting.  
If you have Call Waiting service, press [On] to avoid the trouble caused by Call Waiting.
5. Press .

### Related Information

- [FaxAbility](#)

#### Related Topics:

- [Error and Maintenance Messages](#)

## Voice Over Internet Protocol (VoIP/Telephone Line Interference)

VoIP is a type of phone system that uses an Internet connection instead of a traditional telephone line. Telephone providers frequently bundle VoIP together with Internet and cable services.

Your machine may not work with some VoIP systems. If you want to use your machine to send and receive faxes on a VoIP system, make sure one end of your telephone cord is connected to the socket labelled LINE on your machine. The other end of the telephone cord may be connected to a modem, phone adapter, splitter, or other such device.

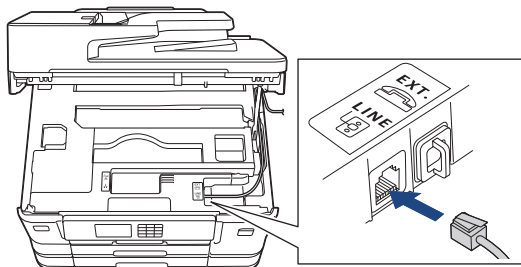

 If you have questions about how to connect your machine to the VoIP system, please contact your VoIP provider.

After you have connected your machine to the VoIP system, check for a dial tone. Lift the external telephone's handset and listen for a dial tone. If there is no dial tone, please contact your VoIP provider.

If you are having problems sending or receiving faxes over a VoIP system, we recommend changing the machine's modem speed to the [Basic (for VoIP)] setting.

- 
- VoIP (Voice over IP) is a type of phone system that uses an Internet connection, rather than a traditional phone line.
  - Brother does not recommend the use of a VoIP line. VoIP limitations in general can cause some functions of the fax machine not to work correctly.

### Related Information

- [Telephone Services and External Devices](#)

#### Related Topics:

- [Telephone Line Interference/VoIP](#)

## External TAD (Telephone Answering Device)

You can connect an external Telephone Answering Device (TAD) to the same line as your machine. When the TAD answers a call, your machine will “listen” for the CNG (fax calling) tones sent by a sending fax machine. If it hears them it will take over the call and receive the fax. If it does not hear them, it will let your TAD take a voice message and the LCD will show [Telephone].

The external TAD must answer within two rings (we recommend setting it to two rings). This is because your machine cannot hear the CNG tones until the external TAD has picked up the call. The sending machine will send CNG tones for only eight to ten seconds longer. We do not recommend using the toll saver feature on your external TAD if it needs more than four rings to activate it.

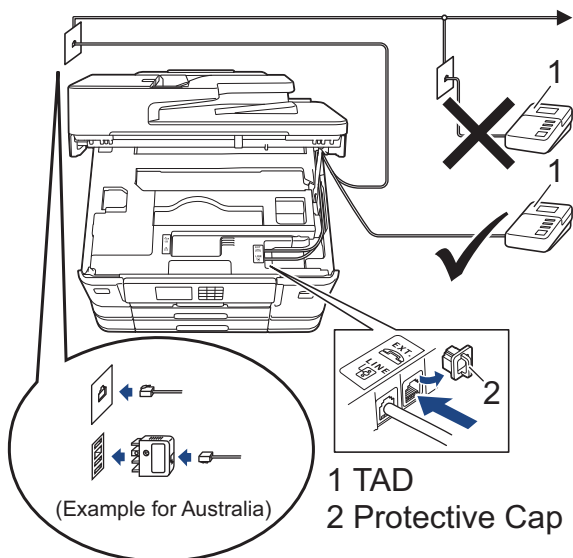

### IMPORTANT

DO NOT connect a TAD elsewhere on the same telephone line.



If you have problems receiving faxes, reduce the Ring Delay setting on your external TAD.



### Related Information

- [Telephone Services and External Devices](#)
  - [Connect an External TAD](#)
  - [Record an Outgoing Message \(OGM\) on the External TAD](#)
  - [Multi-line Connections \(PABX\)](#)

### Related Topics:

- [Telephone and Fax Problems](#)

## Connect an External TAD

1. Set your external TAD to the minimum number of rings allowed. For more information, contact your telephone provider. (The machine's Ring Delay setting does not apply.)
2. Record the outgoing message on your external TAD.
3. Set the TAD to answer calls.
4. Set the Receive Mode on your machine to [External TAD].



### Related Information

- [External TAD \(Telephone Answering Device\)](#)

#### Related Topics:

- [Receive Modes Overview](#)
  - [Choose the Correct Receive Mode](#)
  - [Telephone and Fax Problems](#)
-

## Record an Outgoing Message (OGM) on the External TAD

1. Record five seconds of silence at the beginning of your message. This allows your machine time to listen for fax tones.



We recommend beginning your OGM with an initial five second silence because the machine cannot hear fax tones over a loud voice. You may try leaving out this pause, but if your machine has trouble receiving faxes, then you should re-record the OGM to include it.

2. Limit your speaking to 20 seconds.
3. End your 20-second message by giving your Remote Activation Code for people sending manual faxes. For example: "After the beep, leave a message or press \*51 (\*91 for New Zealand) and Start to send a fax."



### Related Information

- [External TAD \(Telephone Answering Device\)](#)

## Multi-line Connections (PABX)

Most offices use a central telephone system.

We recommend that all our machines be connected to a discreet (dedicated) line. Although a particular PABX may appear to work with a particular model of fax machine, we cannot guarantee that the unit will operate correctly.

While it is often relatively simple to connect a fax machine to a PABX, (Private Automatic Branch Exchange), we suggest that you contact the company that installed your telephone system and ask them to connect the fax machine for you.

We do not recommend the use of a PABX line. PABX limitations in general can cause some functions of the fax machine not to work correctly.



### Related Information

- [External TAD \(Telephone Answering Device\)](#)
-

## External and Extension Telephones

- [Connect an External or Extension Telephone](#)
- [Operation from External and Extension Telephones](#)
- [Use a Cordless External Telephone](#)
- [Use the Remote Codes](#)

## Connect an External or Extension Telephone

You can connect a separate telephone to your machine as shown in the diagram below.

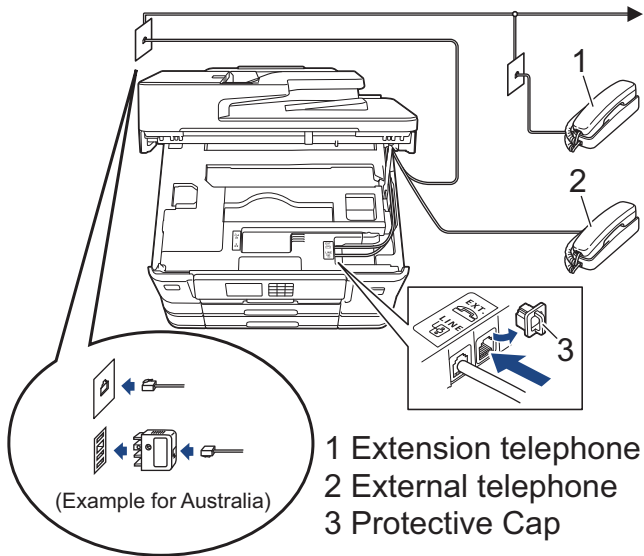

### ✓ Related Information

- [External and Extension Telephones](#)

## Operation from External and Extension Telephones

If you answer a fax call at an extension or an external telephone, you can make your machine take the call by using the Remote Activation Code. When you press the Remote Activation Code **\*51** (**\*91** for New Zealand), the machine starts to receive the fax.

If the machine answers a voice call and pseudo/double-rings for you to take over, you can take the call at an extension telephone by pressing the Remote Deactivation Code **#51** (**#91** for New Zealand).

### If you answer a call and no one is on the line:

You should assume that you're receiving a manual fax.

Press **\*51** (**\*91** for New Zealand) and wait for the chirp or until the LCD shows [Receiving], and then hang up.



You can also use the Fax Detect feature to make your machine automatically take the call.



### Related Information

- [External and Extension Telephones](#)

#### Related Topics:

- [Set the Number of Rings Before the Machine Answers \(Ring Delay\)](#)
- [Set Fax Detect](#)
- [Set a Remote Access Code](#)
- [Set the F/T Ring Time \(Pseudo/Double-ring\)](#)

## Use a Cordless External Telephone

Once the base unit of the cordless telephone has been connected to the same telephone line as the machine, you can answer calls on the cordless handset during the Ring Delay.



### Related Information

- [External and Extension Telephones](#)
-

## Use the Remote Codes

### Remote Activation Code

If you answer a fax call on an extension or external telephone, you can tell your machine to receive it by pressing the Remote Activation Code \*51 (\*91 for New Zealand). Wait for the chirping sounds then replace the handset.

If you answer a fax call at the external telephone, you can make the machine receive the fax by pressing the Start button and then selecting the option to receive.

### Remote Deactivation Code

If you receive a voice call and the machine is in F/T mode, it will start to sound the F/T ring (pseudo/double-ring) after the initial Ring Delay. If you pick up the call on an extension telephone you can turn the F/T ring off by pressing #51 (#91 for New Zealand) (make sure you press this between the rings).

If the machine answers a voice call and pseudo/double-rings for you to take over, you can take the call at the external telephone by pressing [Pickup].



### Related Information



- [External and Extension Telephones](#)
  - [Change the Remote Codes](#)

#### Related Topics:

- [Set a Remote Access Code](#)
- [Set Fax Detect](#)

## Change the Remote Codes

The preset Remote Activation Code is **\*51** (**\*91** for New Zealand). The preset Remote Deactivation Code is **#51** (**#91** for New Zealand). If you are always disconnected when accessing your External TAD remotely, try changing the three-digit remote codes using the numbers 0-9, \*, #.

1. Press  [Settings] > [All Settings] > [Fax] > [Setup Receive] > [Remote Codes].
2. Do one of the following:
  - To change the Remote Activation Code, press [Act . Code]. Enter the new code, and then press [OK].
  - To change the Remote Deactivation Code, press [Deact . Code]. Enter the new code, and then press [OK].
  - If you do not want to change the Codes, go to the next step.
  - To turn the Remote Codes [Off] (or [On]), press [Remote Codes]. Press [Off] (or [On]).
3. Press .



### Related Information

- [Use the Remote Codes](#)

## Fax Reports

- [Set the Transmission Verification Report's Style](#)
- [Set the Fax Journal's Interval Period](#)
- [Print Reports](#)

## Set the Transmission Verification Report's Style

You can use the Transmission Verification Report as proof that you sent a fax. This report lists the receiving party's name or fax number, the time and date of transmission, duration of transmission, number of pages sent, and whether or not the transmission was successful.

There are several settings available for the Transmission Verification Report:

Option	Description
On	Prints a report after every fax you send.
On (+Image)	Prints a report after every fax you send. A portion of the fax's first page appears on the report.
Error only	Prints a report if your fax is unsuccessful due to a transmission error.
Error only (+Image)	Prints a report if your fax is unsuccessful due to a transmission error. A portion of the fax's first page appears on the report.
Off	The report will not be printed.

1. Press  [Settings] > [All Settings] > [Fax] > [Report Setting] > [XMIT Report].

2. Press the option you want.

If you select [On (+Image)] or [Error only (+Image)], the image will not appear on the Transmission Verification Report if Real Time Transmission is set to [On]. The image will not appear on the report when you send a colour fax.

3. Press .



If the transmission is successful, [OK] appears next to [RESULT] on the Transmission Verification Report. If the transmission is not successful, [ERROR] appears next to [RESULT].

### Related Information

- [Fax Reports](#)

## Set the Fax Journal's Interval Period

You can set the machine to print a Fax Journal at specific intervals (every 50 faxes, 6, 12 or 24 hours, 2 or 7 days).

1. Press  [Settings] > [All Settings] > [Fax] > [Report Setting] > [Journal Period].
2. Press [Journal Period].
3. Press ▲ or ▼ to select an interval.
  - 6, 12, 24 hours, 2 or 7 days  
The machine will print the report at the selected interval and then erase all fax jobs from the Journal's memory. If the memory becomes full with 200 jobs before the time you selected has passed, the machine will print the Journal early and then erase all fax jobs from the memory. If you want an extra report before it is due to print, you can print it without erasing the jobs.
  - Every 50 Faxes  
The machine will print the Journal when the machine has stored 50 fax jobs.
4. If you selected 6, 12, 24 hours, 2 or 7 days, press [Time] and enter the time of day using the touchscreen. Press [OK].
5. If you selected [Every 7 Days], press [Day]. Press ▲ or ▼ to display the [Every Monday], [Every Tuesday], [Every Wednesday], [Every Thursday], [Every Friday], [Every Saturday] or [Every Sunday] option, and then press the first day of the seven-day countdown.
6. Press .

### Related Information

- [Fax Reports](#)

#### Related Topics:

- [Set the Machine to Power Off Automatically](#)

## PC-FAX

- [PC-FAX for Windows](#)
- [PC-FAX for Mac](#)

## PC-FAX for Windows

- [PC-FAX Overview \(Windows\)](#)
- [Send a Fax Using PC-FAX \(Windows\)](#)
- [Receive Faxes on Your Computer \(Windows\)](#)

## PC-FAX Overview (Windows)

Reduce paper consumption and save time by using the Brother PC-FAX software to send faxes directly from your computer.

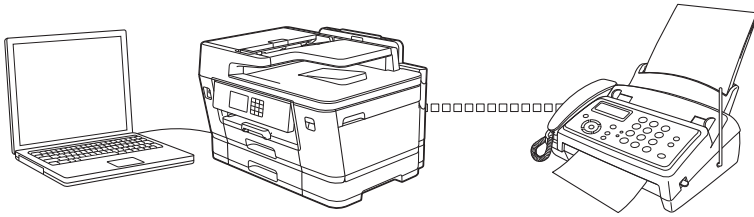

- [Configure PC-FAX \(Windows\)](#)
- [Configure your PC-Fax Address Book \(Windows\)](#)

## Configure PC-FAX (Windows)

Before sending faxes using PC-FAX, personalise the send options in each tab of the **PC-FAX Setup** dialog box.

1. Launch  (**Brother Utilities**), and then click the drop-down list and select your model name (if not already selected).
2. Click **PC-FAX** in the left navigation bar, and then click **Setup Sending**.

The **PC-FAX Setup** dialog box appears.

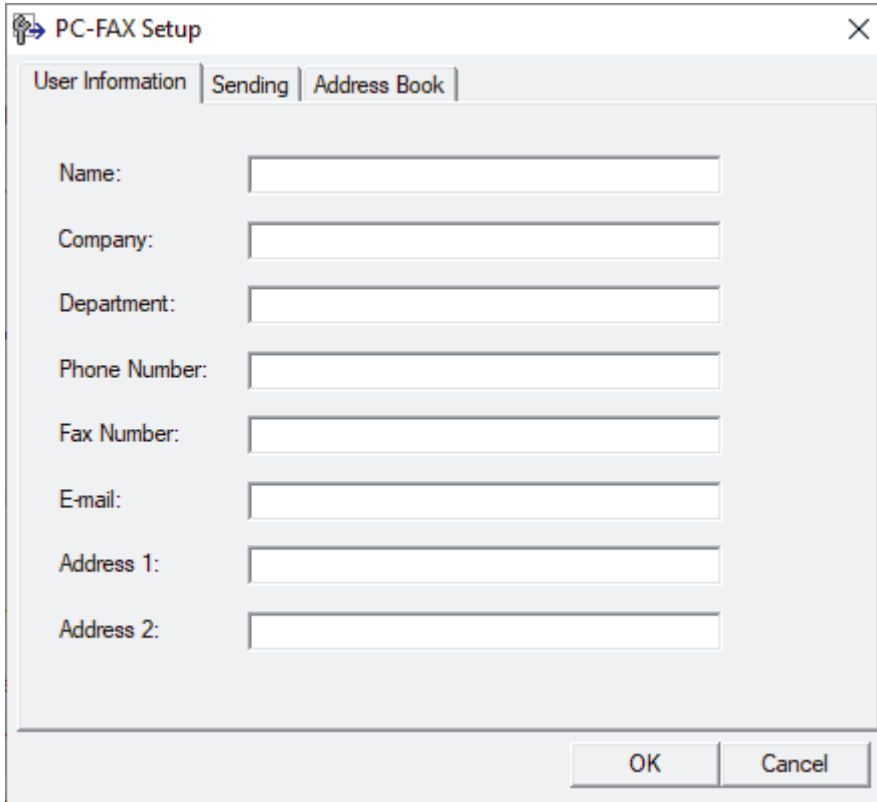

3. Do one of the following:
  - Click the **User Information** tab, and then type your user information in the fields.



Each Microsoft account can have its own customised **User Information** screen for custom fax headers and cover pages.

- Click the **Sending** tab, and then type the number needed to access an outside line (if needed) in the **Outside line access** field. Select the **Include header** check box to include the header information.
- Click the **Address Book** tab, and then select the address book you want to use for PC-FAX from the **Select Address Book** drop-down list.

4. Click **OK**.



### Related Information

- [PC-FAX Overview \(Windows\)](#)

## Configure your PC-Fax Address Book (Windows)

Add, edit and delete members and groups to personalise your **Address Book**.

- [Add a Member to your PC-FAX Address Book \(Windows\)](#)
- [Create a Group in your PC-FAX Address Book \(Windows\)](#)
- [Edit Member or Group Information in your PC-FAX Address Book \(Windows\)](#)
- [Delete a Member or Group in your PC-FAX Address Book \(Windows\)](#)
- [Export your PC-FAX Address Book \(Windows\)](#)
- [Import Information to your PC-FAX Address Book \(Windows\)](#)

## Add a Member to your PC-FAX Address Book (Windows)

Add new people and their fax information to the PC-Fax Address Book if you want to send a fax using the Brother PC-Fax software.

1. Launch  (**Brother Utilities**), and then click the drop-down list and select your model name (if not already selected).
2. Click **PC-FAX** in the left navigation bar, and then click **Address Book (Send)**.

The **Address Book** dialog box appears.

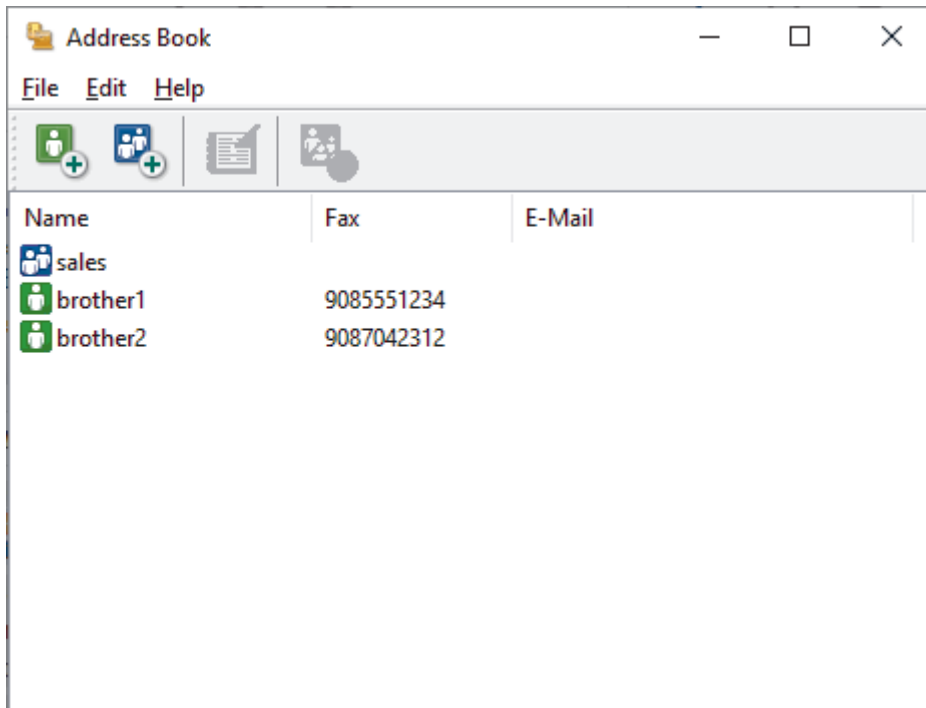

3. Click .

The **Address Book Member Setup** dialog box appears.

4. Type the member's information in the corresponding fields. Only the **Name** field is required.
5. Click **OK**.

### Related Information

- [Configure your PC-Fax Address Book \(Windows\)](#)

## Create a Group in your PC-FAX Address Book (Windows)

Create a group to broadcast the same PC-FAX to several recipients at one time.

1. Launch  (**Brother Utilities**), and then click the drop-down list and select your model name (if not already selected).
2. Click **PC-FAX** in the left navigation bar, and then click **Address Book (Send)**.

The **Address Book** dialog box appears.

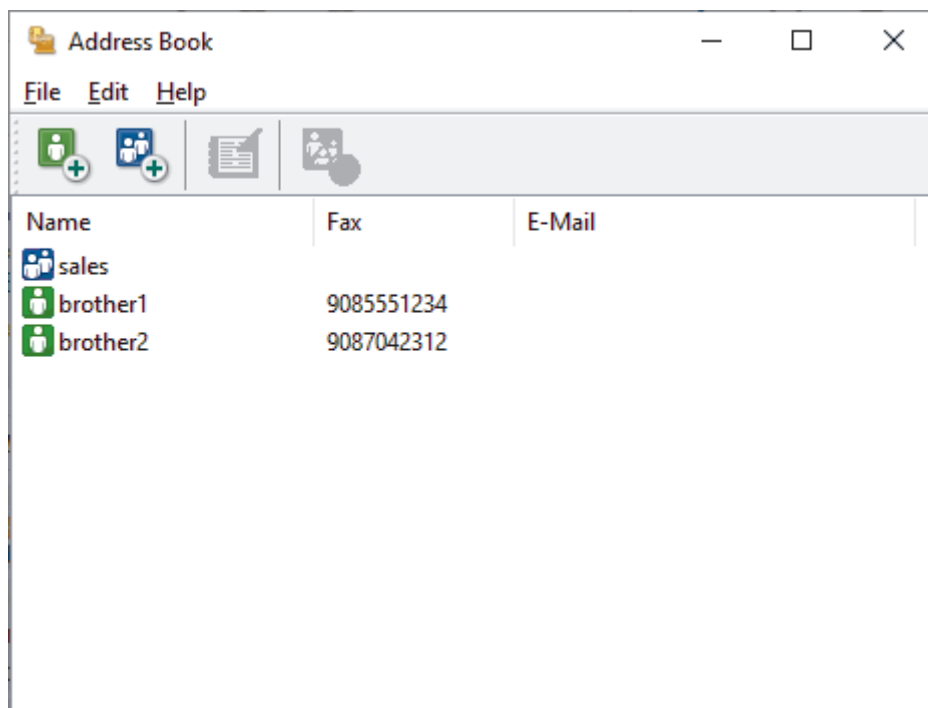

3. Click .

The **Address Book Group Setup** dialog box appears.

4. Type the name of the new group in the **Group Name** field.
5. In the **Available Names** field, select each name you want to include in the group, and then click **Add >>**.  
Members added to the group appear in the **Group Members** box.
6. When finished, click **OK**.



Each group can contain up to 50 members.



### Related Information

- [Configure your PC-Fax Address Book \(Windows\)](#)

## Edit Member or Group Information in your PC-FAX Address Book (Windows)

1. Launch  (**Brother Utilities**), and then click the drop-down list and select your model name (if not already selected).
2. Click **PC-FAX** in the left navigation bar, and then click **Address Book (Send)**.

The **Address Book** dialog box appears.

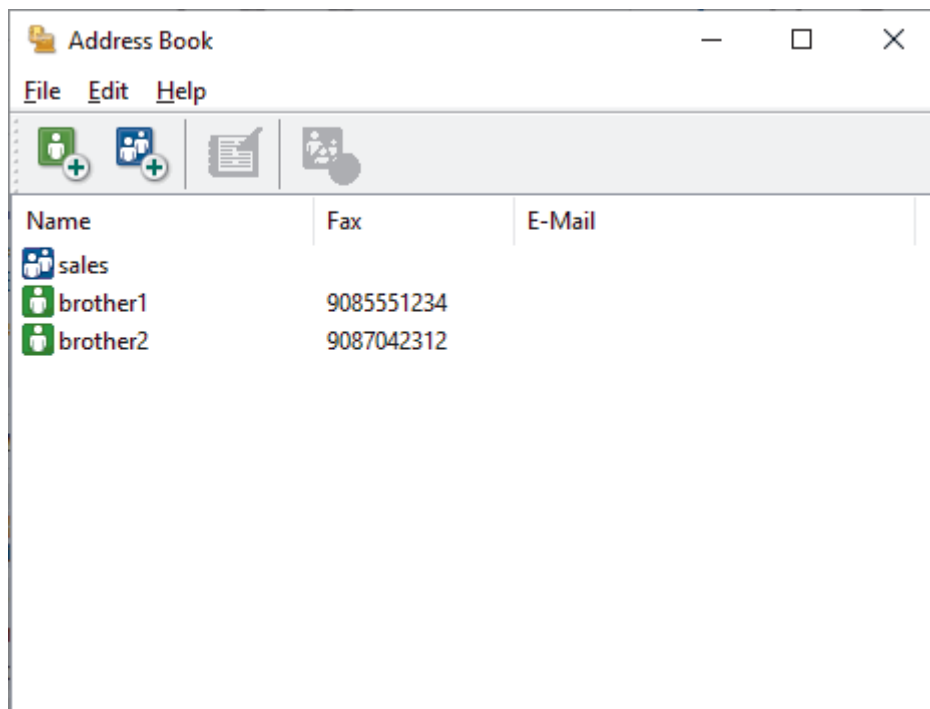

3. Select the member or group you want to edit.
4. Click  (**Properties**).
5. Change the member or group information.
6. Click **OK**.

### Related Information

- [Configure your PC-Fax Address Book \(Windows\)](#)

## Delete a Member or Group in your PC-FAX Address Book (Windows)

1. Launch  (**Brother Utilities**), and then click the drop-down list and select your model name (if not already selected).
2. Click **PC-FAX** in the left navigation bar, and then click **Address Book (Send)**.

The **Address Book** dialog box appears.

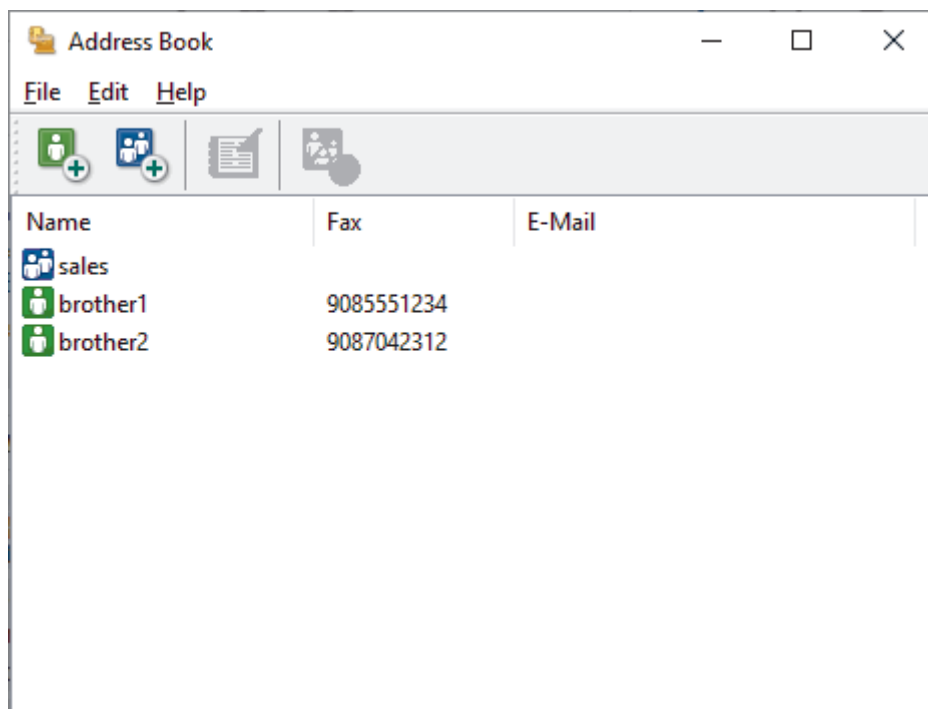

3. Select the member or group you want to delete.
4. Click  (**Delete**).
5. When the confirmation dialog box appears, click **OK**.

### Related Information

- [Configure your PC-Fax Address Book \(Windows\)](#)

## Export your PC-FAX Address Book (Windows)

You can export the Address Book as an ASCII text file (\*.csv) or a vCard (an electronic business card) and save it on your computer.

- You cannot export the group settings when you export the **Address Book** data.

- Launch  (**Brother Utilities**), and then click the drop-down list and select your model name (if not already selected).
- Click **PC-FAX** in the left navigation bar, and then click **Address Book (Send)**.

The **Address Book** dialog box appears.

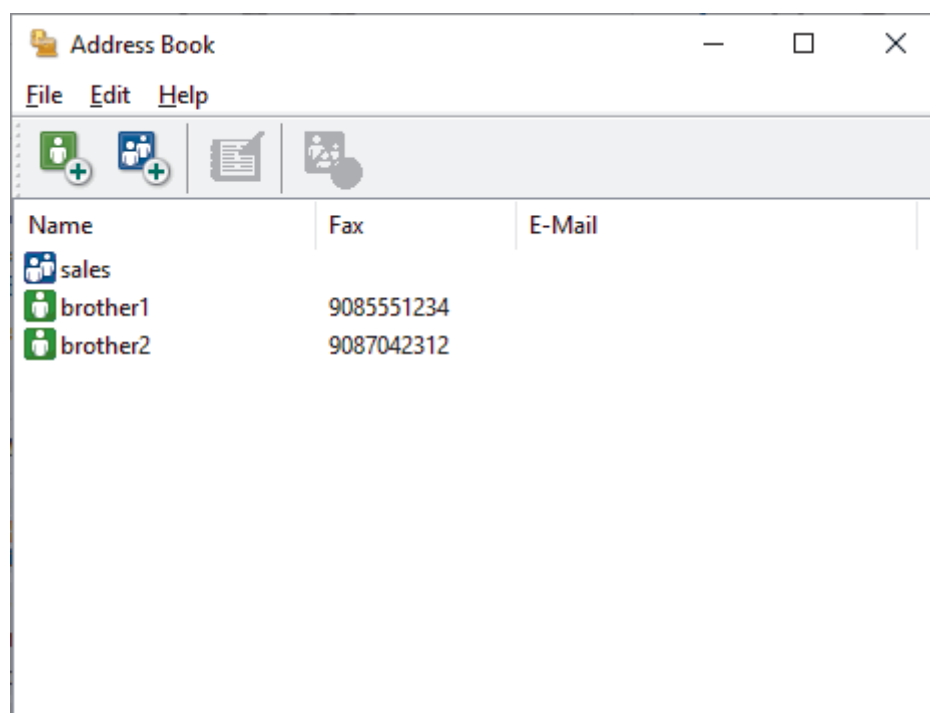

- Click **File > Export**.
- Select one of the following:
  - Text**  
The **Select Items** dialog box appears. Go to the next step.
  - vCard**  
You must select the member you want to export from your address book before selecting this option. Browse to the folder where you want to save the vCard, type the vCard name in the **File name** field, and then click **Save**.
- In the **Available Items** field, select the data you want to export, and then click **Add >>**.



Select and add the items in the order you want them listed.

- If you are exporting to an ASCII file, under the **Divide Character** section, select the **Tab** or **Comma** option to separate the data fields.
- Click **OK**.
- Browse to the folder on your computer where you want to save the data, type the file name, and then click **Save**.



## Related Information

- [Configure your PC-Fax Address Book \(Windows\)](#)
-

## Import Information to your PC-FAX Address Book (Windows)

You can import ASCII text files (\*.csv) or vCards (electronic business cards) into your Address Book.

1. Launch  (**Brother Utilities**), and then click the drop-down list and select your model name (if not already selected).
2. Click **PC-FAX** in the left navigation bar, and then click **Address Book (Send)**.

The **Address Book** dialog box appears.

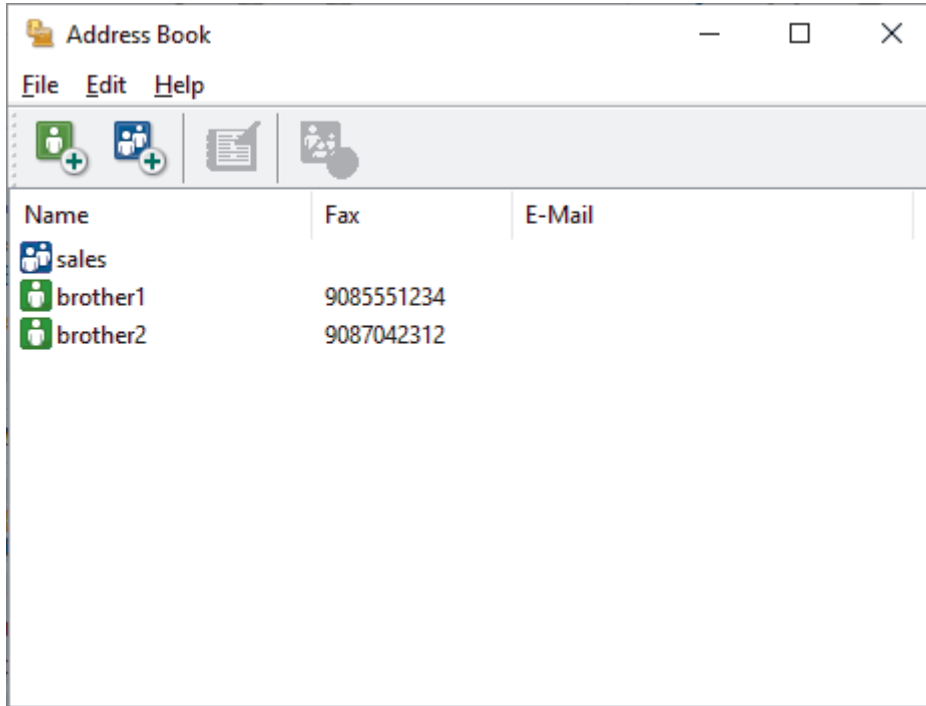

3. Click **File > Import**.
4. Select one of the following:
  - **Text**  
The **Select Items** dialog box appears. Go to step 5.
  - **vCard**  
Go to step 8.
5. In the **Available Items** field, select the data you want to import, and then click **Add >>**.



You must select and add fields from the **Available Items** list in the same order they are listed in the import text file.

6. If you are importing an ASCII file, under the **Divide Character** section, select the **Tab** or **Comma** option to separate the data fields.
7. Click **OK**.
8. Browse to the folder where you want to import the data, type the file name, and then click **Open**.



### Related Information

- [Configure your PC-Fax Address Book \(Windows\)](#)

## Send a Fax Using PC-FAX (Windows)

PC-FAX supports only monochrome faxes. A monochrome fax will be sent even if the original data is colour and the receiving fax machine supports colour faxes.

1. Create a file in any application on your computer.
2. Select the print command in your application.
3. Select **Brother PC-FAX** as your printer, and then complete your print operation.

The **Brother PC-FAX** dialog box appears.

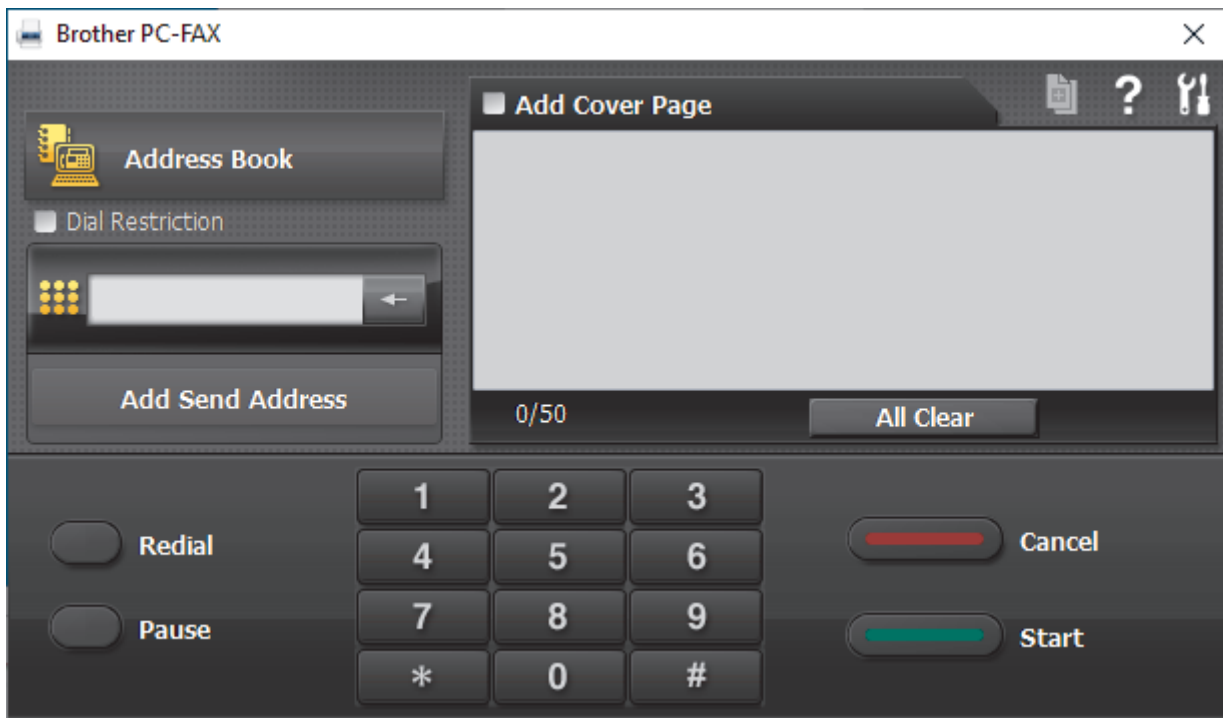

4. Type a fax number using one of the following methods:
  - Click the numbers on the dial pad to type the number, and then click **Add Send Address**.

 If you select the **Dial Restriction** check box, a confirmation dialog box will appear for you to re-type the fax number using the keyboard. This feature helps to prevent transmissions to the wrong destination.

- Click the **Address Book** button, and then select a member or group from the Address Book.

 If you make a mistake, click **All Clear** to delete all entries.

5. To include a cover page, select the **Add Cover Page** check box. You can also click  to create or edit a cover page.
6. Click **Start** to send the fax.

- To cancel the fax, click **Cancel**.
- To redial a number, click **Redial** to show the last five fax numbers, select a number, and then click **Start**.

### Related Information

- [PC-FAX for Windows](#)

## Receive Faxes on Your Computer (Windows)

Use the Brother PC-FAX software to receive faxes on your computer, screen them and print only those faxes you want.

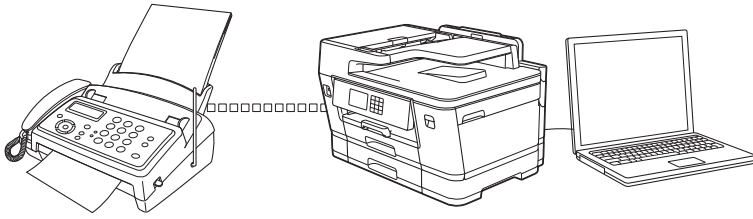

- [Receive Faxes Using PC-FAX Receive \(Windows\)](#)

## Receive Faxes Using PC-FAX Receive (Windows)

The Brother PC-FAX Receive software lets you view and store faxes on your computer. It is automatically installed when you install your machine's software and drivers and works on locally or network-connected machines.

- PC-FAX Receive supports only monochrome faxes. When you receive a colour fax, your machine prints the colour fax at your machine but does not send the fax to your computer.

When you turn off your computer, your machine will continue to receive and store faxes in your machine's memory. The machine's LCD will display the number of stored faxes received. When you start this application, the software will transfer all received faxes to your computer at once. You can enable the Backup Print option if you want the machine to print a copy of the fax before the fax is sent to your computer, or before the computer is switched off. You can configure the Backup Print settings from your machine.

### ✓ Related Information

- [Receive Faxes on Your Computer \(Windows\)](#)
  - [Run the Brother PC-FAX Receive on Your Computer \(Windows\)](#)
  - [View Received PC-FAX Messages \(Windows\)](#)

#### Related Topics:

- [Use PC-Fax Receive to Transfer Received Faxes to Your Computer \(Windows only\)](#)

## Run the Brother PC-FAX Receive on Your Computer (Windows)



We recommend selecting the **Start PC-FAX Receive on computer startup** check box so that the software runs automatically and can transfer any faxes upon computer startup.

1. Launch  (**Brother Utilities**), and then click the drop-down list and select your model name (if not already selected).
2. Click **PC-FAX** in the left navigation bar, and then click **Receive**.
3. Confirm the message and click **Yes**.

The **PC-FAX Receive** window appears. The  (**PC-FAX Receive**) icon also appears in your computer task tray.



### Related Information

- [Receive Faxes Using PC-FAX Receive \(Windows\)](#)
  - [Set Up Your Computer for PC-FAX Receiving \(Windows\)](#)
  - [Add Your Machine to PC-FAX Receiving \(Windows\)](#)

## Set Up Your Computer for PC-FAX Receiving (Windows)

1. Double-click the  (**PC-FAX Receive**) icon in your computer task tray.

The **PC-FAX Receive** window appears.

2. Click **Settings**.
3. Configure these options as needed:

### Preferences

Configure to start PC-FAX Receive automatically when you start Windows.

### Save

Configure the path to save PC-FAX files and select the received document format.

### Upload to

Configure the path to the server and select the option to upload automatically or manually (available only for Administrators).

### Device

Select the machine where you want to receive PC-FAX files.

### Lock (available only for Administrators)

Restrict users who do not have administrator privileges from configuring the settings options shown above.

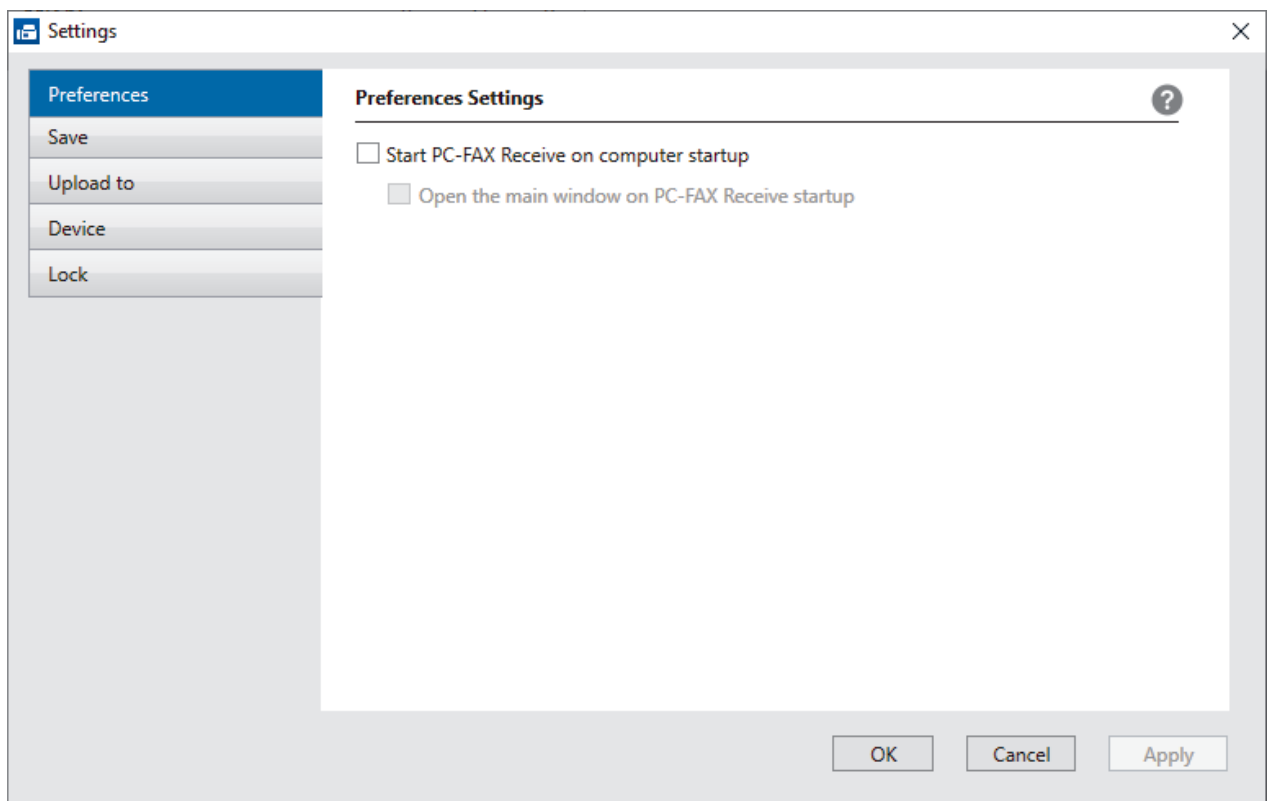

4. Click **OK**.



### Related Information

- [Run the Brother PC-FAX Receive on Your Computer \(Windows\)](#)

## Add Your Machine to PC-FAX Receiving (Windows)

- If you installed the machine following the instructions for a network user, then the machine should already be configured for your network.

- Double-click the  (**PC-FAX Receive**) icon in your computer task tray.

The **PC-FAX Receive** window appears.

- Click **Settings**.
- Click **Device > Add**.

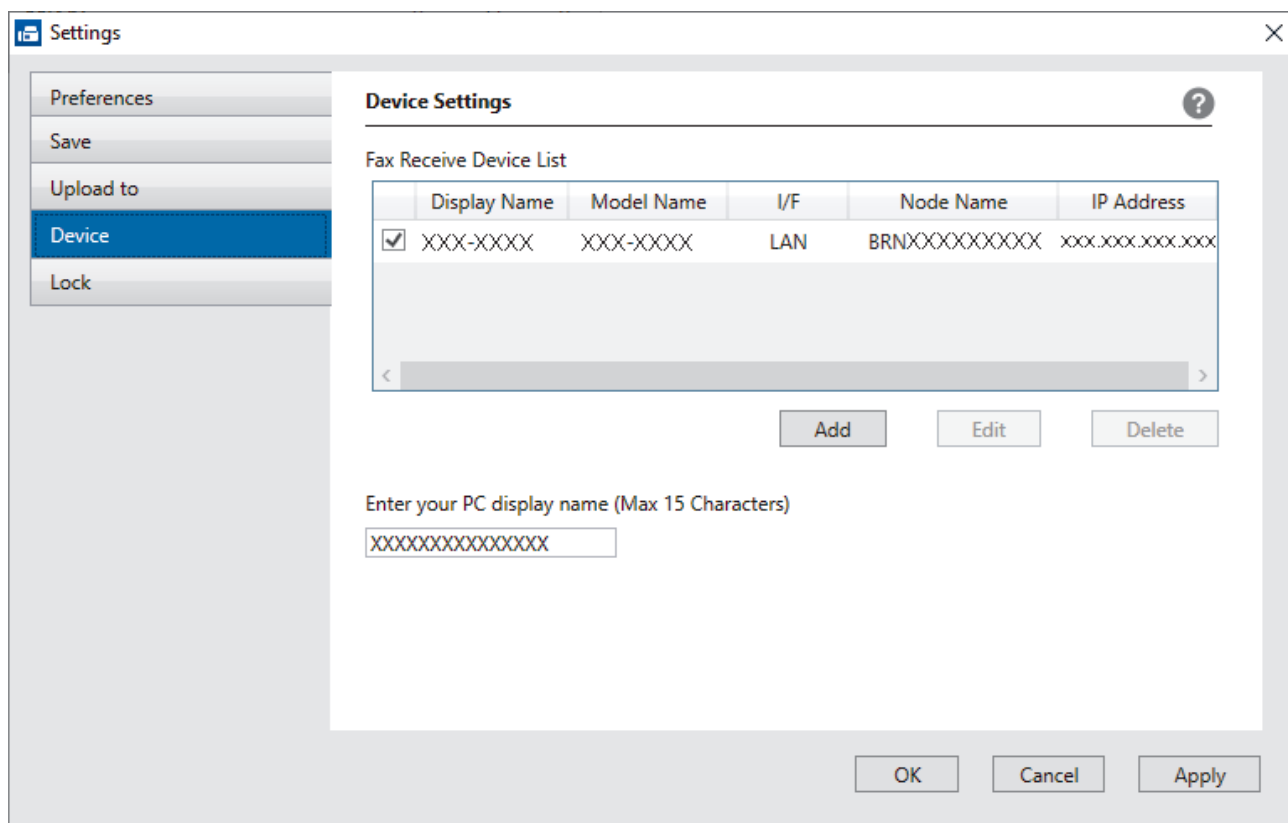

- Select the appropriate connection method.

### Select your machine from the automatic search results below.

A list of connected machines appears. Select the machine you want. Click **OK**.

### Specify your machine by IP address

Type the machine's IP address in the **IP Address** field, and then click **OK**.



- To change the computer name that will appear on the machine's LCD, type the new name in the **Enter your PC display name (Max 15 Characters)** field.
- Click **OK**.

## ✓ Related Information

- [Run the Brother PC-FAX Receive on Your Computer \(Windows\)](#)

## View Received PC-FAX Messages (Windows)

### Receiving Status

Icon	Indicated Status
	Standby mode No unread messages
	Receiving messages
	Messages received Unread messages

1. Double-click the  (PC-FAX Receive) icon in your computer task tray.

The PC-FAX Receive window appears.

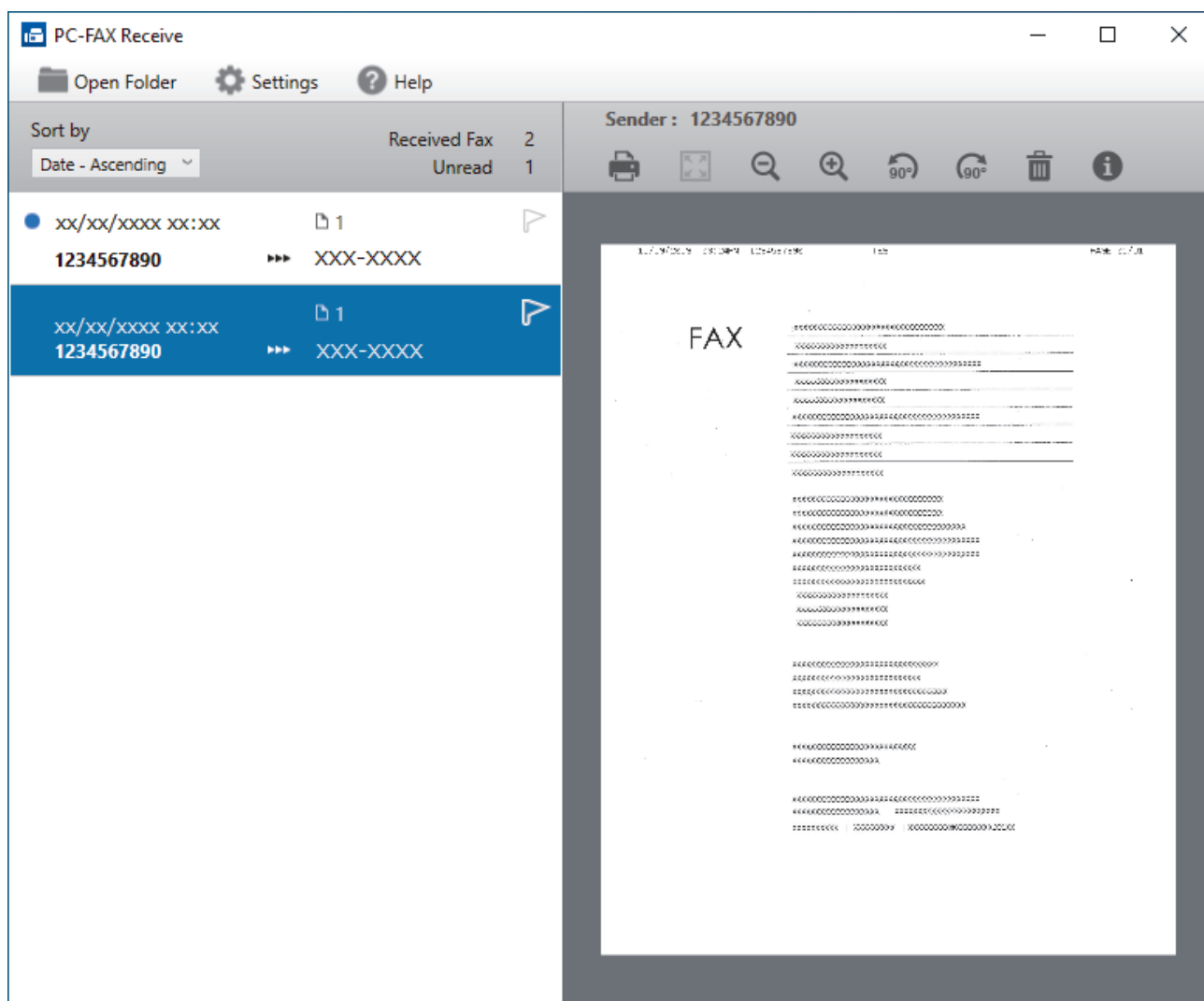

2. Click any faxes in the list to view them.
3. When finished, close the window.



Even after closing the window, PC-FAX Receive is active and the  (PC-FAX Receive) icon will remain in your computer task tray. To close PC-FAX Receive, click the icon in the computer task tray and click **Close**.



## Related Information

- [Receive Faxes Using PC-FAX Receive \(Windows\)](#)
-

## PC-FAX for Mac

- [Send a Fax Using AirPrint \(macOS\)](#)

## Network

- [Supported Basic Network Features](#)
- [Configure Network Settings](#)
- [Wireless Network Settings](#)
- [Network Features](#)

## Supported Basic Network Features

The machine supports various features depending on the operating system. Use this table to see which network features and connections are supported by each operating system.

Operating Systems	Windows	Windows Server	macOS
Printing	Yes	Yes	Yes
Scanning	Yes	No	Yes
PC Fax Send	Yes	No	Yes
PC Fax Receive	Yes	No	No
Web Based Management <sup>1</sup>	Yes	Yes	Yes
Status Monitor	Yes	No	No
Driver Deployment Wizard	Yes	Yes	No

<sup>1</sup> The default password to manage this machine's settings is located on the back of the machine and marked "**Pwd**". We recommend immediately changing the default password to protect your machine from unauthorised access.



When connecting your machine to an outside network such as the Internet, make sure your network environment is protected by a separate firewall or other means in order to prevent information leaks due to inadequate settings or unauthorised access by malicious third parties.



### Related Information

- [Network](#)

#### Related Topics:

- [Set or Change a Login Password for Web Based Management](#)

## Configure Network Settings

- [Configure Network Settings Using the Control Panel](#)
- [Change Machine Settings Using Web Based Management](#)

## Configure Network Settings Using the Control Panel

To configure the machine for your network, use the control panel's [Network] menu selections.



- For information about the network settings you can configure using the control panel, see *Related Information: Settings Tables*.
- You can also use management utilities, such as Web Based Management, to configure and change your Brother machine's network settings.

1. Press  [Settings] > [Network].
2. Press ▲ or ▼ to display the network option, and then press it. Repeat this step until you access the menu you want to configure, and then follow the touchscreen LCD instructions.



### Related Information

- [Configure Network Settings](#)

#### Related Topics:

- [Settings Tables \(2.7"\(67.5 mm\)/3.5"\(87.6 mm\) Touchscreen models\)](#)

## Wireless Network Settings

- [Use the Wireless Network](#)
- [Use Wi-Fi Direct<sup>®</sup>](#)
- [Enable/Disable Wireless LAN](#)
- [Print the WLAN Report](#)

## Use the Wireless Network

- [Before Configuring Your Machine for a Wireless Network](#)
- [Configure Your Machine for a Wireless Network Using the Setup Wizard from Your Computer](#)
- [Configure Your Machine for a Wireless Network Using the Setup Wizard from Your Mobile Device](#)
- [Configure Your Machine for a Wireless Network Using the Machine's Control Panel Setup Wizard](#)
- [Configure Your Machine for a Wireless Network Using the One Push Method of Wi-Fi Protected Setup™ \(WPS\)](#)
- [Configure Your Machine for a Wireless Network Using the PIN Method of Wi-Fi Protected Setup™ \(WPS\)](#)
- [Configure Your Machine for a Wireless Network When the SSID is Not Broadcast](#)
- [Configure Your Machine for an Enterprise Wireless Network](#)

## Before Configuring Your Machine for a Wireless Network

Before attempting to configure a wireless network, confirm the following:

- If you are using an enterprise wireless network, you must know the User ID and Password.
- To achieve optimum results with normal everyday document printing, place your machine as close to the wireless LAN access point/router as possible with minimal obstructions. Large objects and walls between the two devices and interference from other electronic devices can affect the data transfer speed of your documents.

Due to these factors, wireless may not be the best method of connection for all types of documents and applications. If you are printing large files, such as multi-page documents with mixed text and large graphics, you may want to consider selecting wired Ethernet for faster data transfer (supported models only), or USB for the fastest throughput speed.

- Although your machine can be used in both a wired and wireless network (supported models only), only one connection method can be used at a time. However, a wireless network connection and Wi-Fi Direct connection, or a wired network connection (supported models only) and Wi-Fi Direct connection can be used at the same time.
- If there is a signal in the vicinity, wireless LAN allows you to freely make a LAN connection. However, if security settings are not correctly configured, the signal may be intercepted by malicious third-parties, possibly resulting in:
  - Theft of personal or confidential information
  - Improper transmission of information to parties impersonating the specified individuals
  - Dissemination of transcribed communication contents that were intercepted



Make sure you know your wireless router/access point's Network Name (SSID) and Network Key (Password). If you cannot find this information, consult the manufacturer of your wireless router/access point, your system administrator, or Internet provider. Brother cannot provide this information.



### Related Information

- [Use the Wireless Network](#)

## Configure Your Machine for a Wireless Network Using the Setup Wizard from Your Computer

1. Do one of the following:
  - Windows  
Download the installer from your model's **Downloads** page at [support.brother.com](http://support.brother.com).
  - Mac
    - a. Download the installer from your model's **Downloads** page at [support.brother.com](http://support.brother.com).
    - b. Start the installer, and then double-click the **Start Here Mac** icon.
2. Follow the on-screen instructions.
3. Select **Wireless Network Connection (Wi-Fi)**, and then click **Next**.
4. Follow the on-screen instructions.

You have completed the wireless network setup.



### Related Information

- [Use the Wireless Network](#)

## Configure Your Machine for a Wireless Network Using the Setup Wizard from Your Mobile Device

1. Do one of the following:
  - Android™ devices  
Download and install Brother Mobile Connect from Google Play™.
  - All iOS or iPadOS supported devices including iPhone, iPad and iPod touch  
Download and install Brother Mobile Connect from the App Store.
2. Start Brother Mobile Connect, and then follow the on-screen instructions to connect your mobile device to your Brother machine.



### Related Information

- [Use the Wireless Network](#)

## Configure Your Machine for a Wireless Network Using the Machine's Control Panel Setup Wizard

Before configuring your machine, we recommend writing down your wireless network settings. You will need this information before you continue with the configuration.

1. Check and record the current wireless network settings of the computer to which you are connecting.

Network Name (SSID)

Network Key (Password)

For example:

Network Name (SSID)
HELLO

Network Key (Password)
12345



- Your access point/router may support the use of multiple WEP keys, but your Brother machine supports the use of only the first WEP key.
- If you need assistance during setup and want to contact Brother customer service, make sure you have your SSID (Network Name) and Network Key (Password) ready. We cannot assist you in locating this information.
- If you do not know this information (SSID and Network Key), you cannot continue the wireless setup.

### How can I find this information?

- Check the documentation provided with your wireless access point/router.
- The initial SSID could be the manufacturer's name or the model name.
- If you do not know the security information, consult the router manufacturer, your system administrator, or your Internet provider.

2. Press  [Settings] > [Network] > [WLAN (Wi-Fi)] > [Find Wi-Fi Network].
3. When [Enable WLAN?] appears, press [Yes].  
The wireless setup wizard starts. To cancel, press [No].
4. The machine searches for your network and displays a list of available SSIDs. When a list of SSIDs appears, press ▲ or ▼ to select the SSID you want. Press [OK].
5. Do one of the following:
  - If you are using an authentication and encryption method that requires a Network Key, enter the Network Key you wrote down in the first step, and then press [OK] to apply your settings.
  - If your authentication method is Open System and your encryption mode is None, go to the next step.
6. The machine attempts to connect to the wireless device you have selected.

If your wireless device is connected successfully, the LCD displays [Connected].

You have completed the wireless network setup. To install the drivers and software necessary to use your machine, go to your model's **Downloads** page at [support.brother.com](http://support.brother.com).



## Related Information

- [Use the Wireless Network](#)
-

## Configure Your Machine for a Wireless Network Using the One Push Method of Wi-Fi Protected Setup™ (WPS)

If your wireless access point/router supports WPS (Push Button Configuration), you can use WPS from your machine's control panel menu to configure your wireless network settings.

1. Press  [Settings] > [Network] > [WLAN (Wi-Fi)] > [WPS/Push Button].
2. When [Enable WLAN?] appears, press [Yes].  
The wireless setup wizard starts. To cancel, press [No].
3. When the touchscreen instructs you to start WPS, press the WPS button on your wireless access point/router. Then press [OK] on your machine. Your machine automatically tries to connect to your wireless network.

If your wireless device is connected successfully, the LCD displays [Connected].

You have completed the wireless network setup. To install the drivers and software necessary to use your machine, go to your model's **Downloads** page at [support.brother.com](http://support.brother.com).



### Related Information

- [Use the Wireless Network](#)

## Configure Your Machine for a Wireless Network Using the PIN Method of Wi-Fi Protected Setup™ (WPS)

If your wireless LAN access point/router supports WPS, you can use the Personal Identification Number (PIN) Method to configure your wireless network settings.

The PIN Method is one of the connection methods developed by the Wi-Fi Alliance®. By submitting a PIN created by an Enrollee (your machine) to the Registrar (a device that manages the wireless LAN), you can set up the wireless network and security settings. For more information on how to access WPS mode, see the instructions provided with your wireless access point/router.

### Type A

Connection when the wireless LAN access point/router (1) doubles as the Registrar.

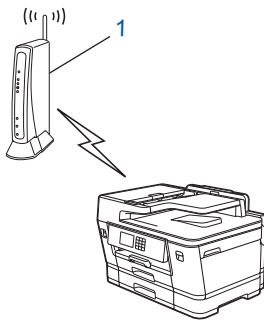

### Type B

Connection when another device (2), such as a computer, is used as the Registrar.

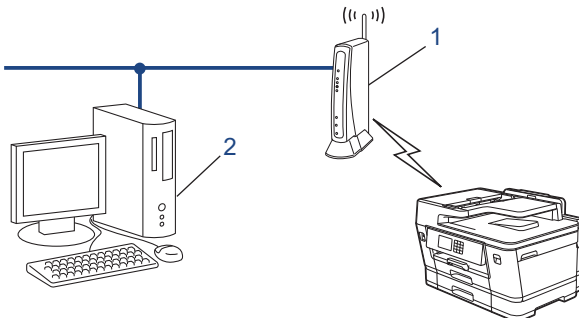

1. Press  [Settings] > [Network] > [WLAN (Wi-Fi)] > [WPS/PIN Code].
2. When [Enable WLAN?] appears, press [Yes].  
The wireless setup wizard starts. To cancel, press [No].
3. The LCD displays an eight-digit PIN and the machine starts searching for a wireless LAN access point/router.
4. Using a computer connected to the network, in your browser's address bar, type the IP address of the device you are using as the Registrar. (For example: <http://192.168.1.2>)
5. Go to the WPS settings page and type the PIN, and then follow the on-screen instructions.



- The Registrar is usually the wireless LAN access point/router.
- The settings page may differ depending on the brand of wireless LAN access point/router. For more information, see the instructions supplied with your wireless LAN access point/router.

If your wireless device is connected successfully, the LCD displays [Connected].

**If you are using a Windows 7, Windows 8.1, or Windows 10 computer as a Registrar, complete the following steps:**

6. Do one of the following:
  - Windows 10

---

Click  > **Windows System** > **Control Panel**. In the **Hardware and Sound** group, click **Add a device**.

- Windows 8.1

Move your mouse to the lower right corner of your desktop. When the menu bar appears, click **Settings** > **Control Panel** > **Hardware and Sound** > **Devices and Printers** > **Add a device**.

- Windows 7

Click  (**Start**) > **Devices and Printers** > **Add a device**.



- To use a Windows 7, Windows 8.1, or Windows 10 computer as a Registrar, you must register it to your network in advance. For more information, see the instructions supplied with your wireless LAN access point/router.
- If you use Windows 7, Windows 8.1, or Windows 10 as a Registrar, you can install the printer driver after the wireless configuration by following the on-screen instructions. To install the driver and software necessary to use your machine, go to your model's **Downloads** page at [support.brother.com](http://support.brother.com).

---

7. Select your machine and click **Next**.

8. Type the PIN displayed on the machine's LCD, and then click **Next**.

9. (Windows 7) Select your network, and then click **Next**.

10. Click **Close**.



### Related Information

- [Use the Wireless Network](#)
-

## Configure Your Machine for a Wireless Network When the SSID is Not Broadcast

Before configuring your machine, we recommend writing down your wireless network settings. You will need this information before you continue with the configuration.

1. Check and write down the current wireless network settings.

Network Name (SSID)		
Authentication Method	Encryption Mode	Network Key (Password)
Open System	NONE	-
	WEP	
Shared Key	WEP	
WPA/WPA2-PSK/WPA3-SAE	TKIP (for WPA/WPA2-PSK)	
	AES	
WPA3-SAE	AES	

For example:

Network Name (SSID)		
HELLO		
Authentication Method	Encryption Mode	Network Key (Password)
WPA2-PSK	AES	12345678



If your router uses WEP encryption, enter the key used as the first WEP key. Your Brother machine supports the use of the first WEP key only.

2. Press  [Settings] > [Network] > [WLAN (Wi-Fi)] > [Find Wi-Fi Network].
3. When [Enable WLAN?] appears, press [Yes].  
The wireless setup wizard starts. To cancel, press [No].
4. The machine searches for your network and displays a list of available SSIDs. Press ▲ or ▼ to display the [<New SSID>] option, and then press it.
5. Press [OK].
6. Enter the SSID name, and then press [OK].



For more information about how to enter text, see *Related Information*.

7. Press ▲ or ▼ to select the Authentication Method, and then press it.
8. Do one of the following:
  - If you selected the [Open System] option, press either [None] or [WEP].  
If you selected the [WEP] option for Encryption type, enter the WEP key, and then press [OK].
  - If you selected the [Shared Key] option, enter the WEP key, and then press [OK].
  - If you selected the [WPA/WPA2-PSK/WPA3-SAE] option, press either [TKIP+AES] or [AES].  
Enter the WPA key, and then press [OK].
  - If you selected the [WPA3-SAE] option, press [AES].

---

Enter the WPA key, and then press [OK].



- 
- For more information about how to enter text, see *Related Information*.
  - Your Brother machine supports the use of the first WEP key only.
- 

9. The machine attempts to connect to the wireless device you have selected.

If your wireless device is connected successfully, the LCD displays [Connected].

You have completed the wireless network setup. To install the drivers and software necessary to use your machine, go to your model's **Downloads** page at [support.brother.com](http://support.brother.com).



## Related Information

- [Use the Wireless Network](#)

### Related Topics:

- [If You Are Having Difficulty with Your Machine's Network](#)
  - [Enter Text on Your Brother Machine](#)
-

## Configure Your Machine for an Enterprise Wireless Network

Before configuring your machine, we recommend writing down your wireless network settings. You will need this information before you continue with the configuration.

1. Check and record the current wireless network settings.

Network Name (SSID)

Authentication Method	Encryption Mode	User ID	Password
EAP-FAST/NONE	AES		
	TKIP		
EAP-FAST/MS-CHAPv2	AES		
	TKIP		
EAP-FAST/GTC	AES		
	TKIP		
PEAP/MS-CHAPv2	AES		
	TKIP		
PEAP/GTC	AES		
	TKIP		
EAP-TTLS/CHAP	AES		
	TKIP		
EAP-TTLS/MS-CHAP	AES		
	TKIP		
EAP-TTLS/MS-CHAPv2	AES		
	TKIP		
EAP-TTLS/PAP	AES		
	TKIP		
EAP-TLS	AES		-
	TKIP		-

For example:

Network Name (SSID)
HELLO

Authentication Method	Encryption Mode	User ID	Password
EAP-FAST/MS-CHAPv2	AES	Brother	12345678



- If you configure your machine using EAP-TLS authentication, you must install the client certificate issued by a CA before you start configuration. Contact your network administrator about the client certificate. If you have installed more than one certificate, we recommend writing down the certificate name you want to use.
- If you verify your machine using the common name of the server certificate, we recommend writing down the common name before you start configuration. Contact your network administrator about the common name of the server certificate.

- 
2. Press  [Settings] > [Network] > [WLAN (Wi-Fi)] > [Find Wi-Fi Network].
  3. When [Enable WLAN?] appears, press [Yes].  
The wireless setup wizard starts. To cancel, press [No].
  4. The machine searches for your network and displays a list of available SSIDs. Press ▲ or ▼ to display the [<New SSID>] option, and then press it.
  5. Press [OK].
  6. Enter the SSID name, and then press [OK].



---

For more information about how to enter text, see *Related Information*.

---

7. Press ▲ or ▼ to select the Authentication Method, and then press it.
8. Do one of the following:
  - If you selected the [EAP-FAST], [PEAP] or [EAP-TTLS] option, select the Inner Authentication method [NONE], [CHAP], [MS-CHAP], [MS-CHAPv2], [GTC] or [PAP].



---

Depending on your Authentication method, the Inner Authentication method selections differ.

---

Select the encryption type [TKIP+AES] or [AES].

Select the verification method [No Verification], [CA] or [CA + Server ID].

- If you selected the [CA + Server ID] option, enter the server ID, user ID and password (if required), and then press [OK] for each option.
- For other selections, enter the user ID and Password, and then press [OK] for each option.



---

If you have not imported a CA certificate into your machine, the machine displays [No Verification].

---

- If you selected the [EAP-TLS] option, select the encryption type [TKIP+AES] or [AES].  
The machine will display a list of available Client Certificates, and then select the certificate.  
Select the verification method [No Verification], [CA] or [CA + Server ID].
  - If you selected the [CA + Server ID] option, enter the server ID and user ID, and then press [OK] for each option.
  - For other selections, enter the user ID, and then press [OK].

9. The machine attempts to connect to the wireless device you have selected.

If your wireless device is connected successfully, the LCD displays [Connected].

You have completed the wireless network setup. To install the drivers and software necessary to use your machine, go to your model's **Downloads** page at [support.brother.com](http://support.brother.com).



## Related Information

- [Use the Wireless Network](#)

### Related Topics:

- [Enter Text on Your Brother Machine](#)
-

## Use Wi-Fi Direct®

- [Wi-Fi Direct Overview](#)
- [Configure Your Wi-Fi Direct Network Using the Push Button Method](#)
- [Configure a Wi-Fi Direct Network Manually](#)
- [If You Are Having Difficulty with Your Machine's Network](#)

## Wi-Fi Direct Overview

Wi-Fi Direct is one of the wireless configuration methods developed by the Wi-Fi Alliance®. It allows you to securely connect your mobile device to your Brother machine without using a wireless router/access point.

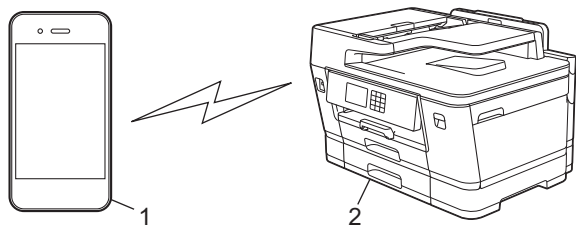

1. Mobile device
2. Your Brother machine



- You can use Wi-Fi Direct with either the wired or wireless network connection at the same time.
- The Wi-Fi Direct supported device can become a Group Owner. When configuring the Wi-Fi Direct network, the Group Owner serves as an access point.



### Related Information

- [Use Wi-Fi Direct®](#)

#### Related Topics:

- [Configure Your Wi-Fi Direct Network Using the Push Button Method](#)
- [Configure a Wi-Fi Direct Network Manually](#)

## Configure Your Wi-Fi Direct Network Using the Push Button Method



When the machine receives the Wi-Fi Direct request from your mobile device, the message [Wi-Fi Direct connection request received. Press [OK] to connect.] will appear on the LCD. Press [OK] to connect.

1. Press  [Settings] > [Network] > [Wi-Fi Direct].
2. If your mobile device does not support Wi-Fi Direct, press [Group Owner] > [On].
3. Press [Push Button].
4. When the [Activate Wi-Fi Direct on other device. Then Press [OK].] message appears, turn your mobile device's Wi-Fi Direct function on (for more information, see your mobile device's user's guide). Press [OK] on your Brother machine.
5. Do one of the following:
  - If your mobile device displays a list of machines with Wi-Fi Direct enabled, select your Brother machine.
  - If your Brother machine displays a list of mobile devices with Wi-Fi Direct enabled, select your mobile device. To search for available devices again, press [Rescan].

When your mobile device connects successfully, the machine displays [Connected].



### Related Information

- [Use Wi-Fi Direct®](#)

#### Related Topics:

- [Wi-Fi Direct Overview](#)
- [Configure a Wi-Fi Direct Network Manually](#)

## Configure a Wi-Fi Direct Network Manually

Configure the Wi-Fi Direct setting from the machine's control panel.

1. Press  [Settings] > [Network] > [Wi-Fi Direct] > [Manual].
2. The machine will display the SSID (Network Name) and Password (Network Key). Go to your mobile device's wireless network settings screen, select the SSID, and then enter the password.

When your mobile device connects successfully, the machine displays [Connected].





### Related Information

- [Use Wi-Fi Direct®](#)

#### Related Topics:

- [Wi-Fi Direct Overview](#)
- [Configure Your Wi-Fi Direct Network Using the Push Button Method](#)

## Enable/Disable Wireless LAN

1. Press  [Settings] > [Network] > [Network I/F].
2. Do one of the following:
  - To enable Wi-Fi, select [WLAN (Wi-Fi)].
  - To disable Wi-Fi, select [Wired LAN].
3. Press .



### Related Information

- [Wireless Network Settings](#)
-

## Print the WLAN Report

The WLAN Report shows your machine's wireless status. If the wireless connection fails, check the error code on the printed report.

1. Press  [Settings] > [All Settings] > [Print Reports] > [WLAN Report] > [Yes].

The machine will print the WLAN Report.

If the WLAN Report does not print, check your machine for errors. If there are no visible errors, wait for one minute and then try to print the report again.

### Related Information

- [Wireless Network Settings](#)
  - [Wireless LAN Report Error Codes](#)

#### Related Topics:

- [Configure IEEE 802.1x Authentication for a Wired or a Wireless Network Using Web Based Management \(Web Browser\)](#)
- [If You Are Having Difficulty with Your Machine's Network](#)

## Wireless LAN Report Error Codes

If the Wireless LAN Report shows that the connection failed, check the error code on the printed report and see the corresponding instructions in the table:

Error Code	Problem and Recommended Solutions
TS-01	<p>The WLAN (Wi-Fi) is not enabled.</p> <p>Check the following points and try to set up your wireless connection again:</p> <ul style="list-style-type: none"><li>• Enable the WLAN setting on your machine.</li><li>• If a network cable is connected to your machine, disconnect it.</li></ul>
TS-02	<p>The wireless router/access point cannot be detected.</p> <p>Check the following points and try to set up your wireless connection again:</p> <ul style="list-style-type: none"><li>• Make sure the wireless router/access point is on.</li><li>• Temporarily place your machine closer to the wireless router/access point when you are configuring the wireless settings.</li><li>• If your wireless router/access point is using MAC address filtering, confirm that the MAC address of the machine is allowed in the filter. You can find the MAC address by printing the Network Configuration Report.</li><li>• If you manually entered the Network Name (SSID) and security information (authentication method/encryption method), the information may be incorrect. Check the Network Name and security information again and re-enter the correct information.</li><li>• Restart your wireless router/access point. If you cannot find the Network Name (SSID) and security information, see the documentation provided with your wireless router/access point, or contact the router manufacturer, your system administrator, or Internet service provider.</li></ul>
TS-03	<p>The wireless enterprise network and security settings you entered may be incorrect.</p> <p>Check the following points and try to set up your wireless connection again:</p> <ul style="list-style-type: none"><li>• Verify the following information:<ul style="list-style-type: none"><li>- Network Name (SSID) you selected to configure your machine.</li><li>- Security information you selected to configure your machine (such as the authentication method, encryption method, or User ID).</li></ul></li></ul> <p>If you still cannot find the Network Name (SSID) and security information, see the documentation provided with your wireless router/access point, or contact the router manufacturer, your system administrator, or Internet service provider.</p>
TS-04	<p>Your machine does not support the authentication and encryption methods used by the selected wireless router/access point.</p> <p>For infrastructure mode (Most common)</p> <p>Change the authentication and encryption methods of the wireless router/access point. Your machine supports the following authentication and encryption methods:</p> <ul style="list-style-type: none"><li>• WPA-Personal:<ul style="list-style-type: none"><li>TKIP / AES</li></ul></li><li>• WPA2-Personal:<ul style="list-style-type: none"><li>TKIP / AES</li></ul></li><li>• WPA3-Personal:<ul style="list-style-type: none"><li>AES</li></ul></li><li>• OPEN:<ul style="list-style-type: none"><li>WEP / NONE (without encryption)</li></ul></li><li>• Shared key:<ul style="list-style-type: none"><li>WEP</li></ul></li></ul> <p>If your issue is not solved, the Network Name (SSID) or security settings you entered may be incorrect. Check that all wireless network settings are correct for your network.</p>

Error Code	Problem and Recommended Solutions
TS-05	<p>The Network Name (SSID) and Network Key (Password) are incorrect.</p> <p>Check the following points and try to set up your wireless connection again:</p> <ul style="list-style-type: none"> <li>• Confirm the Network Name (SSID) and Network Key (Password).</li> <li>• If your Network Key contains upper-case and lower-case letters, make sure you type them correctly.</li> <li>• If you cannot find the Network Name (SSID) and security information, see the documentation provided with your wireless router/access point, or contact the router manufacturer, your system administrator, or Internet service provider.</li> <li>• If your wireless router/access point uses WEP encryption with multiple WEP keys, write down and use only the first WEP key.</li> </ul>
TS-06	<p>The wireless security information (authentication method/encryption method/Network Key (Password)) is incorrect.</p> <p>Check the following points and try to set up your wireless connection again:</p> <ul style="list-style-type: none"> <li>• Confirm the Network Key. If your Network Key contains upper-case and lower-case letters, make sure you type them correctly.</li> <li>• Confirm whether the authentication method entered and the authentication method or encryption method supported by the wireless router/access point are the same.</li> <li>• If the network key, authentication method, and encryption method have been confirmed, restart your wireless router/access point and the machine.</li> <li>• If your wireless router/access point's Stealth Mode is on, you may need to disable it to connect to the wireless network.</li> </ul> <p>If you cannot find the Network Name (SSID) and security information, see the documentation provided with your wireless router/access point, or contact the router manufacturer, your system administrator, or Internet service provider.</p>
TS-07	<p>The machine cannot detect a wireless router/access point that has WPS (Wi-Fi Protected Setup) enabled.</p> <p>Check the following points and try again:</p> <ul style="list-style-type: none"> <li>• To check if your wireless router/access point supports WPS, look for the WPS symbol displayed on the router/access point. For more information, see the documentation provided with your wireless router/access point.</li> <li>• To set up your wireless connection using WPS, you must configure both your machine and the wireless router/access point. For more information, see the user's guide.</li> <li>• If you do not know how to set up your wireless router/access point using WPS, see the documentation provided with your wireless router/access point, or contact the router manufacturer, your system administrator, or Internet service provider.</li> </ul>
TS-08	<p>Two or more wireless routers or access points that have WPS enabled are detected.</p> <p>Check the following points and try again:</p> <ul style="list-style-type: none"> <li>• Make sure that only one wireless router/access point within range has WPS enabled, and then try to connect again.</li> <li>• Try to connect again after a few minutes to avoid interference from other access points/routers.</li> </ul>



---

How to confirm wireless security information (SSID/authentication method/encryption method/Network Key) of your WLAN access point/router:

1. The default security settings may be provided on a label attached to the WLAN access point/router. Or the manufacturer's name or model number of the WLAN access point/router may be used as the default security settings.
2. See the documentation provided with your WLAN access point/router for information on how to find the security settings.
  - If the WLAN access point/router is set to not broadcast the SSID, the SSID will not automatically be detected. You will have to manually enter the SSID name.
  - The Network key may also be described as the Password, Security Key, or Encryption Key.

If you do not know the SSID and wireless security settings of your WLAN access point/router or how to change the configuration, see the documentation provided with your WLAN access point/router, ask the manufacturer of your access point/router or ask your Internet provider or network administrator.

---



## Related Information

- [Print the WLAN Report](#)

### Related Topics:

- [If You Are Having Difficulty with Your Machine's Network](#)
-

## Network Features

- [Print the Network Configuration Report](#)
- [Fax Using the Internet \(I-Fax\)](#)
- [Configure and Operate LDAP Search](#)
- [Synchronize Time with the SNTP Server Using Web Based Management](#)
- [Reset the Network Settings to Factory Default](#)

## Print the Network Configuration Report

The Network Configuration Report lists the network configuration, including the network print server settings.



- **Node Name:** The Node Name appears on the current Network Configuration Report. The default Node Name is "BRNxxxxxxxxxxx" for a wired network or "BRWxxxxxxxxxxx" for a wireless network (where "xxxxxxxxxxx" is your machine's MAC Address / Ethernet Address.)
- If the IP Address on the Network Configuration Report shows 0.0.0.0, wait for one minute and try printing it again.
- You can find your machine's settings, such as the IP address, subnet mask, node name, and MAC Address on the report, for example:
  - IP address: 192.168.0.5
  - Subnet mask: 255.255.255.0
  - Node name: BRN000ca0000499
  - MAC Address: 00-0c-a0-00-04-99

1. Press  [Settings] > [All Settings] > [Print Reports] > [Network Configuration] > [Yes].

The machine prints the current Network Configuration Report.



### Related Information

- [Network Features](#)

#### Related Topics:

- [Check Your Machine's Network Settings](#)
- [Use the Network Connection Repair Tool \(Windows\)](#)
- [Configure IEEE 802.1x Authentication for a Wired or a Wireless Network Using Web Based Management \(Web Browser\)](#)
- [Error and Maintenance Messages](#)
- [If You Are Having Difficulty with Your Machine's Network](#)

## Fax Using the Internet (I-Fax)

With Brother's I-Fax program, you can send and receive fax documents using the Internet as the transport mechanism. Documents are transmitted in email messages as attached TIFF files. Your computer can send and receive documents as long as it has an application that can generate and view TIFF files. You can use any TIFF viewer application. Documents sent via the Brother machine will be converted into a TIFF format automatically. If you want to send and receive messages to and from your Brother machine, your computer's email application must support Multipurpose Internet Mail Extensions (MIME).

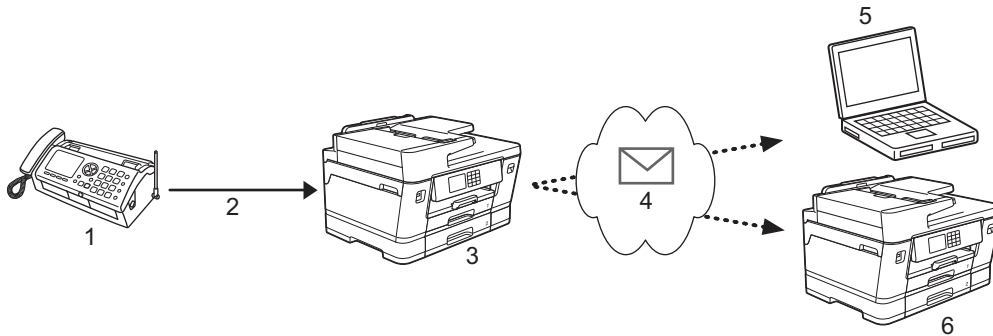

1. Fax (Sender)
2. Telephone line
3. Your Brother Machine (Receiver/Sender)
4. The Internet
5. A computer receives a forwarded email
6. A fax machine receives a forwarded fax



- I-Fax supports sending and receiving documents in Letter or A4 format and in monochrome only.
- If your document is in Ledger or A3 format, it will be reduced to Letter or A4 format automatically when it is sent.



### Related Information

- [Network Features](#)
  - [Important Information about Internet Fax \(I-Fax\)](#)
  - [Configure Your Brother Machine for Email or I-Fax](#)
  - [Send an I-Fax](#)
  - [Poll the Server Manually](#)
  - [I-Fax Options](#)

#### Related Topics:

- [Forward Received Email and Fax Messages](#)

## Important Information about Internet Fax (I-Fax)

I-Fax communication on a LAN is very similar to communication via email; however, it is different from fax communication using standard phone lines. The following is important information for using I-Fax:

- Factors such as the receiver's location, structure of the LAN and how busy the circuit (such as the Internet) is may cause the system to take a longer time than usual to send an error mail.
- When sending confidential documents, we recommend using standard phone lines instead of the Internet (due to its low level of security).
- If the receiver's mail system is not MIME-compatible, you cannot use I-Fax to send documents. If possible, find out in advance, and note that some servers will not send an error reply.
- If a document is too large to send via I-Fax, it may not reach the receiver.
- You cannot change the font or size of the text in any Internet mail you receive.



### Related Information

- [Fax Using the Internet \(I-Fax\)](#)
-

## Configure Your Brother Machine for Email or I-Fax

Before using I-Fax, configure your Brother machine to communicate with your network and mail server. You can configure these items using the machine's control panel or Web Based Management. We recommend using Web Based Management to configure the optional items.

1. Start your web browser.
2. Type "https://machine's IP address" in your browser's address bar (where "machine's IP address" is the machine's IP address).

For example:

https://192.168.1.2

3. If required, type the password in the **Login** field, and then click **Login**.



The default password to manage this machine's settings is located on the back of the machine and marked "Pwd".

4. Go to the navigation menu, and then click **Network > Network > Protocol**.



Start from , if the navigation menu is not shown on the left side of the screen.

5. In the **POP3/IMAP4/SMTP Client** field, click **Advanced Settings** and configure the settings as needed.



If you are unsure of any of these items, contact your system administrator.

6. When finished, click **Submit**.

The **Test Send/Receive E-mail Configuration** dialog box appears.

7. Follow the instructions in the dialog box to test the current settings.



### Related Information

- [Fax Using the Internet \(I-Fax\)](#)
  - [Initial Setup for Email or I-Fax](#)
  - [Receive an I-Fax Automatically](#)
  - [How Received I-Faxes Appear on a Computer](#)

#### Related Topics:

- [Access Web Based Management](#)
- [I-Fax Options](#)

## Initial Setup for Email or I-Fax

Before sending your I-Fax, use Web Based Management to configure sending and receiving options, if needed.

1. Start your web browser.
2. Type "https://machine's IP address" in your browser's address bar (where "machine's IP address" is the machine's IP address).

For example:

https://192.168.1.2

3. If required, type the password in the **Login** field, and then click **Login**.



The default password to manage this machine's settings is located on the back of the machine and marked "Pwd".

4. Go to the navigation menu, and then click **Fax > E-mail Send**.



Start from ☰, if the navigation menu is not shown on the left side of the screen.

5. Configure the settings as needed.

**E-mail Send**

**E-mail Subject**  
Internet Fax Job

**Size Limit**  
 Off  
 On

**Maximum Size**  
1 MB

**Request Delivery Notification (Send)**  
 Off  
 On

[POP3/IMAP4/SMTP Client>>](#)

Cancel Submit

6. When finished, click **Submit**.



### Related Information

- [Configure Your Brother Machine for Email or I-Fax](#)

#### Related Topics:

- [Access Web Based Management](#)
- [Forward Received Email and Fax Messages](#)

## Receive an I-Fax Automatically

To receive an I-Fax automatically, use Web Based Management to configure receiving options, if needed.

1. Start your web browser.
2. Type "https://machine's IP address" in your browser's address bar (where "machine's IP address" is the machine's IP address).  
For example:  
https://192.168.1.2
3. If required, type the password in the **Login** field, and then click **Login**.



The default password to manage this machine's settings is located on the back of the machine and marked "Pwd".

4. Go to the navigation menu, and then click **Fax > E-mail Receive**.



Start from , if the navigation menu is not shown on the left side of the screen.

5. Configure the settings as needed.

### E-mail Receive

---

**Auto Polling**

Off  
 On

---

**Polling Frequency**

10 Mins

---

**Print Mail Header**

None

---

**Delete/Read Receive Error Mail**

Off  
 On

---

**Send Delivery Notification (Receive)**

Off

---

[POP3/IMAP4/SMTP Client>>](#)

---



---

There are two ways to receive email messages:

- POP3/IMAP4 receiving at regular intervals
- POP3/IMAP4 receiving, manually initiated

When using POP3/IMAP4 receiving, the machine polls your email server to receive data. Polling can occur at set intervals (for example, you can configure the machine to poll the email server every ten minutes) or you can manually poll the server.

---

6. When finished, click **Submit**.



- If your machine starts to receive email data, the LCD will display [Receiving]. The email will print automatically.
  - If your machine is out of paper when receiving data, the received data will be held in the machine's memory. This data will be printed automatically after paper is re-inserted into the machine.
  - If the received mail is not in a plain text format, or an attached file is not in the TIFF format, the error message "**ATTACHED FILE FORMAT NOT SUPPORTED.**" will be printed.
  - If the received mail is too large, the error message "**E-MAIL FILE TOO LARGE.**" will be printed.
  - If **Delete/Read Receive Error Mail** is **On** (default), then the error mail will be deleted (POP3) or read (IMAP4) from the email server automatically.
- 



### Related Information

- [Configure Your Brother Machine for Email or I-Fax](#)

#### Related Topics:

- [Access Web Based Management](#)
  - [How Received I-Faxes Appear on a Computer](#)
  - [Forward Received Email and Fax Messages](#)
-

## How Received I-Faxes Appear on a Computer

When a computer receives an I-Fax document, the document is attached to an email message that notifies you in its Subject: line that your email server has received an I-Fax. You can either wait for your Brother machine to poll the email server, or you can manually poll the email server to receive the incoming data.



### Related Information

- [Configure Your Brother Machine for Email or I-Fax](#)

#### Related Topics:



- [Receive an I-Fax Automatically](#)
-

## Send an I-Fax

Sending an I-Fax is like sending a normal fax. Make sure that your recipient's information is saved in your email address book, and load the document you want to I-Fax into your Brother machine.



If the computer to which you want to send a document is not running Windows, ask the computer's owner to install software that can view TIFF files.

1. Load your document.
2. Do one of the following:
  - If [Fax Preview] is set to [Off], press [Fax].
  - If [Fax Preview] is set to [On], press [Fax], and then press [Sending Faxes].
3. To change the fax-sending settings, press  [Options].
4. Press ▲ or ▼ to scroll through the fax settings. When the setting you want is displayed, press it and choose your preference. When you have finished changing settings, press [OK].
5. Do one of the following:
  - Press , and then enter the email address.
  - Press [Address Book], choose the email address of your recipient, and then press [Apply].
6. Press [Fax Start].

The machine starts scanning. After the document is scanned, it is transmitted to the recipient via your SMTP server. You can cancel the send operation by pressing  during scanning. When the transmission is finished, the machine will enter standby mode.



### Related Information

- [Fax Using the Internet \(I-Fax\)](#)

## Poll the Server Manually

1. Press  [Settings] > [All Settings] > [Network] > [E-mail/IFAX] > [Manual Receive] > [Yes].
2. The LCD will display [Receiving] and your machine will print the data from the email server.



### Related Information

- [Fax Using the Internet \(I-Fax\)](#)

#### Related Topics:

- [Forward Received Email and Fax Messages](#)

## I-Fax Options

- [Forward Received Email and Fax Messages](#)
- [Set Up Relay Broadcast on Your Brother Machine](#)
- [Internet Fax \(I-Fax\) Verification Mail](#)
- [Configure Your Brother Machine for Email or I-Fax](#)

## Forward Received Email and Fax Messages

Use Brother I-Fax to forward email or standard fax messages to another computer, to a fax machine, or to another I-Fax machine. Enable the Forwarding function using Web Based Management.

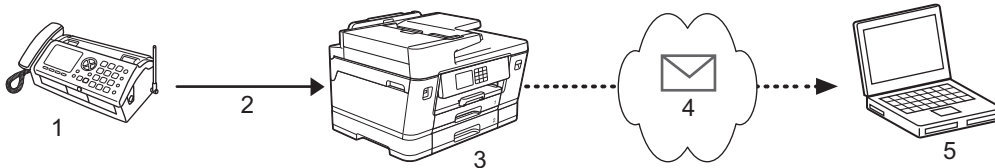

1. Fax (Sender)
2. Telephone line
3. Your Brother Machine (Receiver/Sender)
4. The Internet
5. A computer receives a forwarded email

1. Start your web browser.
2. Type "https://machine's IP address" in your browser's address bar (where "machine's IP address" is the machine's IP address).  
For example:  
https://192.168.1.2
3. If required, type the password in the **Login** field, and then click **Login**.



The default password to manage this machine's settings is located on the back of the machine and marked "Pwd".

4. Go to the navigation menu, and then click **Fax > Remote Fax Options**.



Start from , if the navigation menu is not shown on the left side of the screen.

5. Select **Fax Forward** in the **Fwd/Store/Cloud** field.
6. Select the **E-mail Address** option in **Fax Forward #**, and then type the recipient's email address.
7. When finished, click **Submit**.



### Related Information

- [I-Fax Options](#)

#### Related Topics:

- [Access Web Based Management](#)
- [Poll the Server Manually](#)
- [Fax Using the Internet \(I-Fax\)](#)
- [Initial Setup for Email or I-Fax](#)
- [Receive an I-Fax Automatically](#)

## Set Up Relay Broadcast on Your Brother Machine

A Relay Broadcast is when your Brother machine receives a message over the Internet and then relays it to another fax machine using conventional telephone lines. If you must fax a document over a long distance or abroad, use the "relay broadcast" function to save the communication fee.

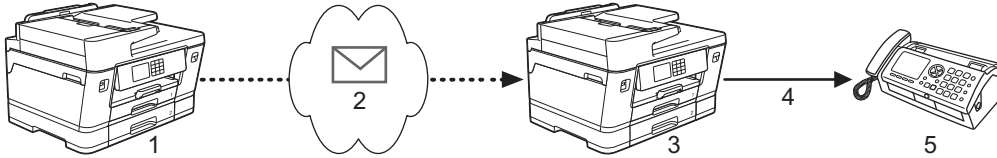

1. Internet-available fax machine
2. The Internet
3. Your Brother Machine
4. Telephone line
5. Fax machine

1. Start your web browser.
2. Type "https://machine's IP address" in your browser's address bar (where "machine's IP address" is the machine's IP address).  
For example:  
https://192.168.1.2
3. If required, type the password in the **Login** field, and then click **Login**.



---

 The default password to manage this machine's settings is located on the back of the machine and marked "Pwd".

---

4. Go to the navigation menu, and then click **Fax > Relay Function**.

---

 Start from , if the navigation menu is not shown on the left side of the screen.

---

5. Configure settings as needed.

---

## Relay Function

---

**Relay Broadcast Function**

Off  
 On

---

**Relay Domain**

---

**Relay Broadcast Report**

Off  
 On

---

- **Relay Broadcast Function**

Set the **Relay Broadcast Function** to **On**.

- **Relay Domain**

Configure your machine's domain name on the machine that will broadcast the document to the conventional fax machine. To use your machine as a relay broadcast device, you must specify the trusted domain name (the portion of the name after the "@" sign) on the machine. Use care in selecting a trusted domain: any user on a trusted domain will be able to send a relay broadcast. You can register up to five domain names.

- **Relay Broadcast Report**

Specify whether or not you want a report to print after the machine completes the relay broadcast.

6. When finished, click **Submit**.



## Related Information

- [I-Fax Options](#)
  - [Relay Broadcast from Your Brother Machine](#)
  - [Relay Broadcast from Your Computer](#)

### Related Topics:

- [Access Web Based Management](#)
-

## Relay Broadcast from Your Brother Machine

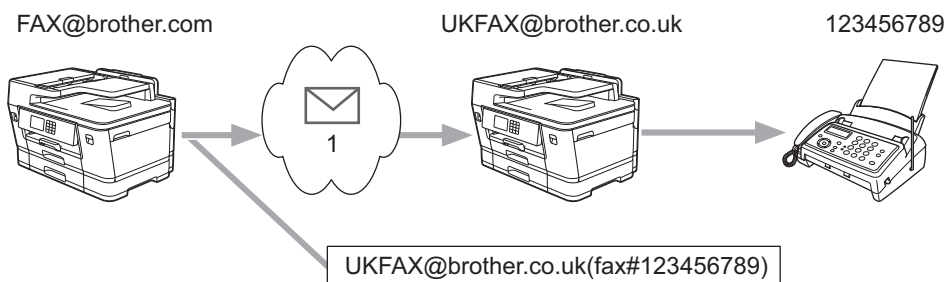

Use the Relay Broadcast Function to send an email from your machine to a conventional fax machine.

Confirm the **POP3/IMAP4/SMTP Client** and **SMTP Server** check boxes are selected in Web Based Management. If the **POP3/IMAP4/SMTP Client** and **SMTP Server** check boxes are not selected, select the **POP3/IMAP4/SMTP Client** and **SMTP Server** check boxes. Click **Submit**, and then restart your machine.



### 1. The Internet

In this example, your machine's email address is FAX@brother.com and you want to send a document from your machine to a standard fax machine in England with the email address UKFAX@brother.co.uk, and you want your machine to send the document using a conventional telephone line.

1. Load your document.
2. Do one of the following:
  - If [Fax Preview] is set to [Off], press [Fax].
  - If [Fax Preview] is set to [On], press [Fax], and then press [Sending Faxes].
3. Press  [Options] > [Broadcasting] > [Add Number].
4. You can add email addresses to the broadcast in the following ways:
  - Press [Add Number] and press , enter the email address and press [OK].
  - Press [Add from Address book]. Select the check box of the email address you want to add to the broadcast. After you have checked all the email addresses you want, press [OK].
  - Press [Search in Address book]. Enter the name and press [OK]. The search results will be displayed. Press the name and then press the email address you want to add to the broadcast.

The following is an example of how to enter the email address and phone number:

UKFAX@brother.co.uk(fax#123456789)

email address                      Fax Phone Number

The word "fax#" must be included with the phone number inside the parenthesis.

After you have entered all of the fax numbers, press [OK].

5. Press [Fax Start].



## Related Information

- [Set Up Relay Broadcast on Your Brother Machine](#)
-

## Relay Broadcast from Your Computer

Use the Relay Broadcast Function to send email from your computer to a conventional fax machine.

- Some email applications do not support sending an email to multiple fax numbers. If your email application cannot support multiple fax numbers, you can relay to only one fax machine at a time.

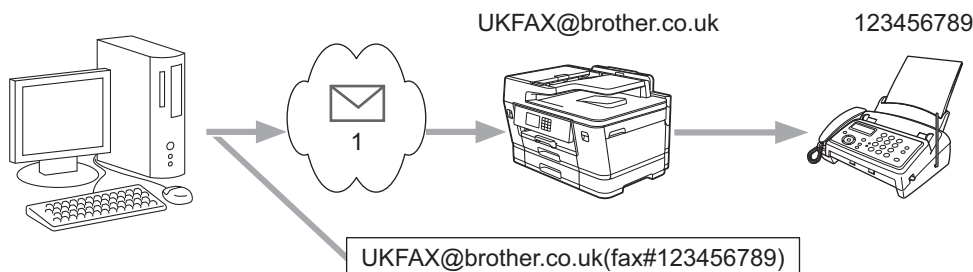

### 1. The Internet

- Confirm the **POP3/IMAP4/SMTP Client** and **SMTP Server** check boxes are selected in Web Based Management. If the **POP3/IMAP4/SMTP Client** and **SMTP Server** check boxes are not selected, select the **POP3/IMAP4/SMTP Client** and **SMTP Server** check boxes. Click **Submit**, and then restart your machine.

If you are sending an email to a conventional fax machine, the method of entering the fax machine's fax number will vary, depending on the mail application you are using.

- In your email application, create a new mail message and type the email address of the relay machine and fax number of the first fax machine in the "TO" box.

The following is an example of how to enter the email address and fax number:

UKFAX@brother.co.uk(fax#123456789)

email address                      Fax Phone Number

The word "fax#" must be included with the phone number inside the parenthesis.



For Microsoft Outlook, the address information must be entered into the address book as follows:

Name: fax#123456789

Email address: UKFAX@brother.co.uk

- Type the email address of the relay machine and fax number of the second fax machine in the "TO" box.
- Send the email.



### Related Information

- [Set Up Relay Broadcast on Your Brother Machine](#)

## Internet Fax (I-Fax) Verification Mail

- Verification Mail for sending allows you to request notification from the receiving station where your I-Fax or email was received and processed.
- Verification Mail for receiving allows you to transmit a default report back to the sending station after successfully receiving and processing an I-Fax or email.

To use this feature, set the [Notification] options in the [Setup Mail RX] and [Setup Mail TX] options of your machine's control panel menu.



### Related Information

- [I-Fax Options](#)
  - [Enable Send Notifications for TX Verification Mail](#)
  - [Enable Receive Notifications for TX Verification Mail](#)
  - [I-Fax Error Mail](#)

## Enable Send Notifications for TX Verification Mail

1. Press  [Settings] > [All Settings] > [Network] > [E-mail/IFAX] > [Setup Mail TX] > [Notification].
2. When switched to [On], an additional field of information is sent with the image data. This field is named MDN (Message Disposition Notification).



---

The receiver must support the MDN field to be able to send a notification report, otherwise the request will be ignored.

---

3. Press .



### Related Information

- [Internet Fax \(I-Fax\) Verification Mail](#)
-

## Enable Receive Notifications for TX Verification Mail

1. Press  [Settings] > [All Settings] > [Network] > [E-mail/IFAX] > [Setup Mail RX] > [Notification].
2. Press one of the three possible settings:

Option	Description
Receive Notification On	When Receive Notification is On, a fixed message is sent back to the sender to indicate successful reception and processing of the message. These fixed messages depend on the operation requested by the sender. Example: SUCCESS: Received From <Mail Address>
Receive Notification MDN	When Receive Notification is MDN, a report to indicate successful reception and processing is sent back to the sender if the originating station sent a request confirmation to the MDN field.
Receive Notification Off	When Receive Notification is Off, all forms of receive notification are disabled and no message is sent back to the sender regardless of the request.



- To send TX verification mail, the Sender must configure these settings:
  - Switch [Notification] in [Setup Mail TX] to [On].
  - Switch [Header] in [Setup Mail RX] to [All] or [Subject+From+To].
- To receive TX verification mail, the Receiver must configure these settings:
  - Switch [Notification] in [Setup Mail RX] to [On].

3. Press .



### Related Information

- [Internet Fax \(I-Fax\) Verification Mail](#)

## I-Fax Error Mail

If there is a delivery error while sending an I-Fax, the mail server will send an error message back to the Brother machine and the error message will be printed.

If there is an error while receiving an I-Fax, an error message will be printed, for example, "The message being sent to the machine was not in a TIFF format."

To receive the error mail and have it print on your machine, in [Setup Mail RX], switch the [Header] option to [All] or to [Subject+From+To].



### Related Information

- [Internet Fax \(I-Fax\) Verification Mail](#)

## Configure and Operate LDAP Search

The LDAP feature allows you to search for information, such as fax numbers and email addresses, on your server. When you use the Fax, I-Fax, or Scan to Email server feature, you can use the LDAP search to find fax numbers or email addresses.



- The LDAP feature does not support simplified Chinese, traditional Chinese, or Korean.
- The LDAP feature supports LDAPv3.
- The LDAP feature does not support SSL/TLS.
- You must use Simple Authentication to communicate with your LDAP server.



### Related Information

- [Network Features](#)
  - [Change LDAP Configuration Using Web Based Management](#)
  - [Perform an LDAP Search Using Your Machine's Control Panel](#)

#### Related Topics:

- [Configure the SNTP Protocol Using Web Based Management](#)

## Change LDAP Configuration Using Web Based Management

Use Web Based Management to configure your LDAP settings in a web browser.

1. Start your web browser.
2. Type "https://machine's IP address" in your browser's address bar (where "machine's IP address" is the machine's IP address).

For example:

https://192.168.1.2

3. If required, type the password in the **Login** field, and then click **Login**.



---

The default password to manage this machine's settings is located on the back of the machine and marked "Pwd".

---

4. Go to the navigation menu, and then click **Network > Network > Protocol**.



---

Start from , if the navigation menu is not shown on the left side of the screen.

---

5. Select the **LDAP** check box, and then click **Submit**.
6. Restart your Brother machine to activate the configuration.
7. On your computer, in Web Based Management, go to the navigation menu, and then click **Address Book > LDAP**.

- **LDAP Search**
- **LDAP Server Address**
- **Port** (The default port number is 389.)
- **Authentication**

- **Username**

This selection will be available depending on the authentication method used.

- **Password**

This selection will be available depending on the authentication method used.



- 
- If the LDAP server supports Kerberos authentication, we recommend selecting Kerberos for the Authentication settings. It provides strong authentication between the LDAP server and your machine.
  - You must configure the SNTP protocol (network time server), or you must set the date, time and time zone correctly on the control panel for Kerberos authentication.
- 

- **Kerberos Server Address**

This selection will be available depending on the authentication method used.

- **Search Root**

- **Timeout for LDAP**

- **Attribute of Name (Search Key)**

- **Attribute of E-mail**

- **Attribute of Fax Number**

8. When finished, click **Submit**. Make sure the **Status** field reads **OK**.



### Related Information

- [Configure and Operate LDAP Search](#)

#### Related Topics:

- [Access Web Based Management](#)

- 
- Synchronize Time with the SNTP Server Using Web Based Management
-

## Perform an LDAP Search Using Your Machine's Control Panel

After you configure LDAP settings, you can use the LDAP search feature to find fax numbers or email addresses to use for:

- Sending a Fax
- Sending an Internet Fax (I-Fax)
- Scanning to Email Server



- The LDAP feature supports LDAPv3.
- The LDAP feature does not support SSL/TLS.
- You may need to use Kerberos Authentication or Simple Authentication to connect to your LDAP server, depending on the security policy set by your network administrator.
- You must configure the SNTP protocol (network time server), or you must set the date, time and time zone correctly on the control panel for Kerberos authentication.

1. Press  to search.
2. Enter the initial characters for your search using the LCD.



- You can enter up to 15 characters.
- For more information about how to enter text, see *Related Information*.

3. Press [OK].

The LDAP search result will be shown on the LCD; the  icon appears before the local address book search results.

- If there is no match on the server or the local address book, the LCD will show [Results cannot be found.] for about 60 seconds.
4. Press ▲ or ▼ to display the name you want.
  5. Press the name.  
To view the details of the name, press [Detail].
  6. If the result includes more than one fax number or email address, the machine will prompt you to select just one. Press [Apply]. Do one of the following:
    - If you are sending a fax and an I-Fax, press [Fax Start].
    - If you are scanning to the email Server, load your document, press [Next], and then press [Start].



### Related Information

- [Configure and Operate LDAP Search](#)

#### Related Topics:

- [Enter Text on Your Brother Machine](#)
- [Synchronize Time with the SNTP Server Using Web Based Management](#)

## Synchronize Time with the SNTP Server Using Web Based Management

The Simple Network Time Protocol (SNTP) is used to synchronize the time used by the machine for authentication with the SNTP time server. (This is not the time displayed on the machine's LCD.) You can automatically or manually synchronize the machine's time with the Coordinated Universal Time (UTC) provided by the SNTP time server.

- [Configure Date and Time Using Web Based Management](#)
- [Configure the SNTP Protocol Using Web Based Management](#)
- [Change LDAP Configuration Using Web Based Management](#)
- [Perform an LDAP Search Using Your Machine's Control Panel](#)

## Configure Date and Time Using Web Based Management

Configure date and time to synchronize the time used by the machine with the SNTP time server.

This feature is not available in some countries.

1. Start your web browser.
2. Type "https://machine's IP address" in your browser's address bar (where "machine's IP address" is the machine's IP address).

For example:

https://192.168.1.2

3. If required, type the password in the **Login** field, and then click **Login**.



The default password to manage this machine's settings is located on the back of the machine and marked "Pwd".

4. Go to the navigation menu, and then click **Administrator > Date&Time**.



Start from , if the navigation menu is not shown on the left side of the screen.

5. Verify the **Time Zone** settings.



Select the time difference between your location and UTC from the **Time Zone** drop-down list. For example, the time zone for Eastern Time in the USA and Canada is UTC-05:00.

6. Select the **Synchronize with SNTP server** check box.
7. Click **Submit**.



You can also configure date and time manually.



### Related Information

- [Synchronize Time with the SNTP Server Using Web Based Management](#)

#### Related Topics:

- [Set up a Scan to Network Profile](#)
- [Access Web Based Management](#)

## Configure the SNTP Protocol Using Web Based Management

Configure the SNTP protocol to synchronize the time the machine uses for authentication with the time kept by the SNTP time server.

1. Start your web browser.
2. Type "https://machine's IP address" in your browser's address bar (where "machine's IP address" is the machine's IP address).

For example:

https://192.168.1.2

3. If required, type the password in the **Login** field, and then click **Login**.



The default password to manage this machine's settings is located on the back of the machine and marked "Pwd".

4. Go to the navigation menu, and then click **Network > Network > Protocol**.



Start from , if the navigation menu is not shown on the left side of the screen.

5. Select the **SNTP** check box to activate the settings.
6. Click **Submit**.
7. Restart your Brother machine to activate the configuration.
8. Next to the SNTP check box, click **Advanced Settings**.
9. Configure the settings.

Option	Description
<b>Status</b>	Displays whether the SNTP protocol is enabled or disabled.
<b>Synchronization Status</b>	Confirm the latest synchronization status.
<b>SNTP Server Method</b>	Select <b>AUTO</b> or <b>STATIC</b> . <ul style="list-style-type: none"><li>• <b>AUTO</b> If you have a DHCP server in your network, the SNTP server will obtain the address from that server automatically.</li><li>• <b>STATIC</b> Type the address you want to use.</li></ul>
<b>Primary SNTP Server Address</b> <b>Secondary SNTP Server Address</b>	Type the server address (up to 64 characters). The secondary SNTP server address is used as a backup to the primary SNTP server address. If the primary server is unavailable, the machine will contact the secondary SNTP server.
<b>Primary SNTP Server Port</b> <b>Secondary SNTP Server Port</b>	Type the port number (1-65535). The secondary SNTP server port is used as a backup to the primary SNTP server port. If the primary port is unavailable, the machine will contact the secondary SNTP port.
<b>Synchronization Interval</b>	Type the number of hours between server synchronization attempts (1-168 hours).

10. Click **Submit**.



### Related Information

- [Synchronize Time with the SNTP Server Using Web Based Management](#)

#### Related Topics:

- [Access Web Based Management](#)

## Reset the Network Settings to Factory Default

You can use your machine's control panel to reset the machine's network settings to its default factory settings. This resets all information, such as the password and IP address.



- This feature restores all wired (supported models only) and wireless network settings to the factory settings.
- You can also reset the print server to its factory settings using Web Based Management.

1. Press  [Settings] > [All Settings] > [Network] > [Network Reset].
2. The reset confirmation message is displayed. Press [OK] for two seconds.  
The machine will restart.



### Related Information

- [Network Features](#)

#### Related Topics:

- [Transfer Your Faxes or Fax Journal Report](#)

## Security

- [Before Using Network Security Features](#)
- [Configure Certificates for Device Security](#)
- [Use SSL/TLS](#)
- [Use SNMPv3](#)
- [Use IPsec](#)
- [Use IEEE 802.1x Authentication for a Wired or a Wireless Network](#)
- [Use Active Directory Authentication](#)
- [Use LDAP Authentication](#)
- [Use Secure Function Lock 3.0](#)
- [Send or Receive an Email Securely](#)

## Before Using Network Security Features

Your machine employs some of the latest network security and encryption protocols available today. These network features can be integrated into your overall network security plan to help protect your data and prevent unauthorised access to the machine.



---

We recommend disabling the FTP and TFTP protocols. Accessing the machine using these protocols is not secure. However, note that if you disable FTP, the Scan to FTP feature will be disabled.

---



### Related Information

- [Security](#)
-

## Configure Certificates for Device Security

You must configure a certificate to manage your networked machine securely using SSL/TLS. You must use Web Based Management to configure a certificate.

- [Supported Security Certificate Features](#)
- [Step by Step Guide for Creating and Installing a Certificate](#)
- [Create a Self-signed Certificate](#)
- [Create CSR and Install a Certificate from a Certificate Authority \(CA\)](#)
- [Import and Export the Certificate and Private Key](#)
- [Import and Export a CA Certificate](#)
- [Manage Multiple Certificates](#)

## Supported Security Certificate Features

Your machine supports the use of multiple security certificates, which allows secure authentication and communication with the machine. The following security certificate features can be used with the machine:

- SSL/TLS communication
- IEEE 802.1x authentication
- IPsec

The Brother machine supports the following:

- Pre-installed certificate

Your machine has a pre-installed self-signed certificate. This certificate enables you to use SSL/TLS communication without creating or installing a different certificate.



---

The pre-installed self-signed certificate protects your communication up to a certain level. We recommend using a certificate that is issued by a trusted organisation for better security.

---

- Self-signed certificate

This print server issues its own certificate. Using this certificate, you can easily use the SSL/TLS communication without creating or installing a different certificate from a CA.

- Certificate from a Certificate Authority (CA)

There are two methods for installing a certificate from a CA. If you already have a certificate from a CA or if you want to use a certificate from an external trusted CA:

- When using a Certificate Signing Request (CSR) from this print server.
- When importing a certificate and a private key.

- Certificate Authority (CA) Certificate

To use a CA certificate that identifies the CA and owns its private key, you must import that CA certificate from the CA before configuring the security features of the Network.



- 
- If you are going to use SSL/TLS communication, we recommend contacting your system administrator first.
  - When you reset the print server back to its default factory settings, the certificate and the private key that are installed will be deleted. If you want to keep the same certificate and the private key after resetting the print server, export them before resetting, and then reinstall them.
- 



### Related Information

- [Configure Certificates for Device Security](#)

#### Related Topics:

- [Configure IEEE 802.1x Authentication for a Wired or a Wireless Network Using Web Based Management \(Web Browser\)](#)
-

## Step by Step Guide for Creating and Installing a Certificate

There are two options when choosing a security certificate: use a self-signed certificate or use a certificate from a Certificate Authority (CA).

### Option 1

#### Self-Signed Certificate

1. Create a self-signed certificate using Web Based Management.
2. Install the self-signed certificate on your computer.

### Option 2

#### Certificate from a CA

1. Create a Certificate Signing Request (CSR) using Web Based Management.
2. Install the certificate issued by the CA on your Brother machine using Web Based Management.
3. Install the certificate on your computer.



#### Related Information

- [Configure Certificates for Device Security](#)
-

## Create a Self-signed Certificate

1. Start your web browser.
2. Type "https://machine's IP address" in your browser's address bar (where "machine's IP address" is the machine's IP address).

For example:

https://192.168.1.2



- If you are using a Domain Name System or enable a NetBIOS name, you can type another name, such as "SharedPrinter" instead of the IP address.

- For example:

https://SharedPrinter

If you enable a NetBIOS name, you can also use the node name.

- For example:

https://brnxxxxxxxxxxxx

The NetBIOS name can be found in the Network Configuration Report.

3. If required, type the password in the **Login** field, and then click **Login**.



The default password to manage this machine's settings is located on the back of the machine and marked "Pwd".

4. Go to the navigation menu, and then click **Network > Security > Certificate**.



Start from , if the navigation menu is not shown on the left side of the screen.

5. Click **Create Self-Signed Certificate**.
6. Enter a **Common Name** and a **Valid Date**.
  - The length of the **Common Name** is less than 64 bytes. Enter an identifier, such as an IP address, node name, or domain name to use when accessing this machine through SSL/TLS communication. The node name is displayed by default.
  - A warning will appear if you use the IPPS or HTTPS protocol and enter a different name in the URL than the **Common Name** that was used for the self-signed certificate.
7. Select your setting from the **Public Key Algorithm** drop-down list. The default setting is **RSA(2048bit)**.
8. Select your setting from the **Digest Algorithm** drop-down list. The default setting is **SHA256**.
9. Click **Submit**.



### Related Information

- [Configure Certificates for Device Security](#)

#### Related Topics:

- [Access Web Based Management](#)

## **Create CSR and Install a Certificate from a Certificate Authority (CA)**

If you already have a certificate from an external trusted CA, you can store the certificate and private key on the machine and manage them by importing and exporting. If you do not have a certificate from an external trusted CA, create a Certificate Signing Request (CSR), send it to a CA for authentication, and install the returned certificate on your machine.

- [Create a Certificate Signing Request \(CSR\)](#)
- [Install a Certificate on Your Machine](#)

## Create a Certificate Signing Request (CSR)

A Certificate Signing Request (CSR) is a request sent to a Certificate Authority (CA) to authenticate the credentials contained within the certificate.

We recommend installing a Root Certificate from the CA on your computer before creating the CSR.

1. Start your web browser.
2. Type "https://machine's IP address" in your browser's address bar (where "machine's IP address" is the machine's IP address).

For example:

https://192.168.1.2



- If you are using a Domain Name System or enable a NetBIOS name, you can type another name, such as "SharedPrinter" instead of the IP address.

- For example:

https://SharedPrinter

If you enable a NetBIOS name, you can also use the node name.

- For example:

https://brnxxxxxxxxxxxx

The NetBIOS name can be found in the Network Configuration Report.

3. If required, type the password in the **Login** field, and then click **Login**.



The default password to manage this machine's settings is located on the back of the machine and marked "Pwd".

4. Go to the navigation menu, and then click **Network > Security > Certificate**.



Start from ☰, if the navigation menu is not shown on the left side of the screen.

5. Click **Create CSR**.
6. Type a **Common Name** (required) and add other information about your **Organization** (optional).



- Your company details are required so that a CA can confirm your identity and verify it to the outside world.
- The length of the **Common Name** must be less than 64 bytes. Enter an identifier, such as an IP address, node name, or domain name to use when accessing this machine through SSL/TLS communication. The node name is displayed by default. The **Common Name** is required.
- A warning will appear if you type a different name in the URL than the Common Name that was used for the certificate.
- The length of the **Organization**, the **Organization Unit**, the **City/Locality** and the **State/Province** must be less than 64 bytes.
- The **Country/Region** should be a two-character ISO 3166 country code.
- If you are configuring an X.509v3 certificate extension, select the **Configure extended partition** check box, and then select **Auto (Register IPv4)** or **Manual**.

7. Select your setting from the **Public Key Algorithm** drop-down list. The default setting is **RSA(2048bit)**.
8. Select your setting from the **Digest Algorithm** drop-down list. The default setting is **SHA256**.
9. Click **Submit**.

The CSR appears on your screen. Save the CSR as a file or copy and paste it into an online CSR form offered by a Certificate Authority.

---

10. Click **Save**.



- Follow your CA's policy regarding the method to send a CSR to your CA.
- If you are using the Enterprise root CA of Windows Server 2008/2008 R2/2012/2012 R2/2016/2019, we recommend using the Web Server for the certificate template to securely create the Client Certificate. If you are creating a Client Certificate for an IEEE 802.1x environment with EAP-TLS authentication, we recommend using User for the certificate template.



### **Related Information**

- [Create CSR and Install a Certificate from a Certificate Authority \(CA\)](#)

#### **Related Topics:**

- [Access Web Based Management](#)
-

## Install a Certificate on Your Machine

When you receive a certificate from a CA, follow the steps below to install it into the print server:

Only a certificate issued with your machine's CSR can be installed onto the machine. When you want to create another CSR, make sure that the certificate is installed before creating another CSR. Create another CSR only after installing the certificate on the machine. If you do not, the CSR you create before installing will be invalid.

1. Start your web browser.
2. Type "https://machine's IP address" in your browser's address bar (where "machine's IP address" is the machine's IP address).

For example:

https://192.168.1.2



- If you are using a Domain Name System or enable a NetBIOS name, you can type another name, such as "SharedPrinter" instead of the IP address.

- For example:

https://SharedPrinter

If you enable a NetBIOS name, you can also use the node name.

- For example:

https://brnxxxxxxxxxxxx

The NetBIOS name can be found in the Network Configuration Report.

3. If required, type the password in the **Login** field, and then click **Login**.



The default password to manage this machine's settings is located on the back of the machine and marked "Pwd".

4. Go to the navigation menu, and then click **Network > Security > Certificate**.



Start from ☰, if the navigation menu is not shown on the left side of the screen.

5. Click **Install Certificate**.
6. Browse to the file that contains the certificate issued by the CA, and then click **Submit**.

The certificate has been created successfully and saved in your machine's memory successfully.

To use SSL/TLS communication, the Root Certificate from the CA must be installed on your computer. Contact your network administrator.



### Related Information

- [Create CSR and Install a Certificate from a Certificate Authority \(CA\)](#)

#### Related Topics:

- [Access Web Based Management](#)

## Import and Export the Certificate and Private Key

Store the certificate and private key on your machine and manage them by importing and exporting them.

- [Import a Certificate and Private Key](#)
- [Export the Certificate and Private Key](#)

## Import a Certificate and Private Key

1. Start your web browser.
2. Type "https://machine's IP address" in your browser's address bar (where "machine's IP address" is the machine's IP address).

For example:

https://192.168.1.2



- If you are using a Domain Name System or enable a NetBIOS name, you can type another name, such as "SharedPrinter" instead of the IP address.

- For example:

https://SharedPrinter

If you enable a NetBIOS name, you can also use the node name.

- For example:

https://brnxxxxxxxxxxxxx

The NetBIOS name can be found in the Network Configuration Report.

3. If required, type the password in the **Login** field, and then click **Login**.



The default password to manage this machine's settings is located on the back of the machine and marked "Pwd".

4. Go to the navigation menu, and then click **Network > Security > Certificate**.



Start from , if the navigation menu is not shown on the left side of the screen.

5. Click **Import Certificate and Private Key**.
6. Browse to the file you want to import.
7. Type the password if the file is encrypted, and then click **Submit**.

The certificate and private key are imported to your machine.



### Related Information

- [Import and Export the Certificate and Private Key](#)

#### Related Topics:

- [Access Web Based Management](#)

## Export the Certificate and Private Key

1. Start your web browser.
2. Type "https://machine's IP address" in your browser's address bar (where "machine's IP address" is the machine's IP address).

For example:

https://192.168.1.2



- If you are using a Domain Name System or enable a NetBIOS name, you can type another name, such as "SharedPrinter" instead of the IP address.

- For example:

https://SharedPrinter

If you enable a NetBIOS name, you can also use the node name.

- For example:

https://brnxxxxxxxxxxxx

The NetBIOS name can be found in the Network Configuration Report.

3. If required, type the password in the **Login** field, and then click **Login**.



The default password to manage this machine's settings is located on the back of the machine and marked "Pwd".

4. Go to the navigation menu, and then click **Network > Security > Certificate**.



Start from , if the navigation menu is not shown on the left side of the screen.

5. Click **Export** shown with **Certificate List**.
6. Enter the password if you want to encrypt the file.  
If a blank password is used, the output is not encrypted.
7. Enter the password again for confirmation, and then click **Submit**.
8. Click **Save**.

The certificate and private key are exported to your computer.

You can also import the certificate to your computer.



### Related Information

- [Import and Export the Certificate and Private Key](#)

#### Related Topics:

- [Access Web Based Management](#)

## Import and Export a CA Certificate

You can import, export and store CA certificates on your Brother machine.

- [Import a CA Certificate](#)
- [Export a CA Certificate](#)

## Import a CA Certificate

1. Start your web browser.
2. Type "https://machine's IP address" in your browser's address bar (where "machine's IP address" is the machine's IP address).

For example:

https://192.168.1.2



- If you are using a Domain Name System or enable a NetBIOS name, you can type another name, such as "SharedPrinter" instead of the IP address.

- For example:

https://SharedPrinter

If you enable a NetBIOS name, you can also use the node name.

- For example:

https://brnxxxxxxxxxxxxx

The NetBIOS name can be found in the Network Configuration Report.

3. If required, type the password in the **Login** field, and then click **Login**.



The default password to manage this machine's settings is located on the back of the machine and marked "Pwd".

4. Go to the navigation menu, and then click **Network > Security > CA Certificate**.



Start from ☰, if the navigation menu is not shown on the left side of the screen.

5. Click **Import CA Certificate**.
6. Browse to the file you want to import.
7. Click **Submit**.



### Related Information

- [Import and Export a CA Certificate](#)

#### Related Topics:

- [Access Web Based Management](#)

## Export a CA Certificate

1. Start your web browser.
2. Type "https://machine's IP address" in your browser's address bar (where "machine's IP address" is the machine's IP address).

For example:

https://192.168.1.2



- If you are using a Domain Name System or enable a NetBIOS name, you can type another name, such as "SharedPrinter" instead of the IP address.

- For example:

https://SharedPrinter

If you enable a NetBIOS name, you can also use the node name.

- For example:

https://brnxxxxxxxxxxxx

The NetBIOS name can be found in the Network Configuration Report.

3. If required, type the password in the **Login** field, and then click **Login**.



The default password to manage this machine's settings is located on the back of the machine and marked "Pwd".

4. Go to the navigation menu, and then click **Network > Security > CA Certificate**.



Start from ☰, if the navigation menu is not shown on the left side of the screen.

5. Select the certificate you want to export and click **Export**.
6. Click **Submit**.
7. Click ▼ next to **Save**, and then specify the location where you want to save the file.



### Related Information

- [Import and Export a CA Certificate](#)

#### Related Topics:

- [Access Web Based Management](#)

## Manage Multiple Certificates

The multiple certificate feature allows you to use Web Based Management to manage each certificate installed on your machine. In Web Based Management, navigate to the **Certificate** or **CA Certificate** screen to view certificate content, delete, or export your certificates.

	Maximum Number of Certificates Stored on Brother Machine
Self-signed Certificate or Certificate Issued by a CA	5
CA Certificate	6

We recommend storing fewer certificates than allowed, reserving an empty spot in case of certificate expiration. When a certificate expires, import a new certificate into the reserved spot, and then delete the expired certificate. This ensures that you avoid configuration failure.



- When you use HTTPS/IPPS or IEEE 802.1x, you must select which certificate you are using.
- When you use SSL for SMTP/POP3/IMAP4 communications (only available for certain models), you do not have to choose the certificate. The necessary certificate will be chosen automatically.



### Related Information

- [Configure Certificates for Device Security](#)

## Use SSL/TLS

- [Introduction to SSL/TLS](#)
- [Manage Your Network Machine Securely Using SSL/TLS](#)
- [Print Documents Securely Using SSL/TLS](#)
- [Send or Receive an Email Securely Using SSL/TLS](#)

## Introduction to SSL/TLS

Secure Socket Layer (SSL) or Transport Layer Security (TLS) is an effective method of protecting data sent over a local or wide area network (LAN or WAN). It works by encrypting data, such as a print job, sent over a network, so anyone trying to capture it will not be able to read it.

SSL/TLS can be configured on both wired and wireless networks and will work with other forms of security such as WPA keys and firewalls.



### Related Information

- [Use SSL/TLS](#)
  - [Brief History of SSL/TLS](#)
  - [Benefits of Using SSL/TLS](#)

## Brief History of SSL/TLS

SSL/TLS was originally created to secure web traffic information, particularly data sent between web browsers and servers. For example, when you use Internet Explorer for Internet Banking and you see https:// and the little padlock icon in the web browser, you are using SSL. SSL grew to work with additional applications, such as Telnet, printer, and FTP software, in order to become a universal solution for online security. Its original design intentions are still being used today by many online retailers and banks to secure sensitive data, such as credit card numbers, customer records, etc.

SSL/TLS uses extremely high levels of encryption and is trusted by banks all over the world.



### Related Information

- [Introduction to SSL/TLS](#)
-

## Benefits of Using SSL/TLS

The primary benefit of using SSL/TLS is to guarantee secure printing over an IP network by restricting unauthorised users from reading data sent to the machine. SSL's key selling point is that it can be used to print confidential data securely. For example, an HR department in a large company may be printing wage slips on a regular basis. Without encryption, the data contained on these wages slips can be read by other network users. However, with SSL/TLS, anyone trying to capture the data will see a confusing page of code and not the actual wage slip.



### Related Information

- [Introduction to SSL/TLS](#)

## Manage Your Network Machine Securely Using SSL/TLS

- [Configure a Certificate for SSL/TLS and Available Protocols](#)
- [Access Web Based Management Using SSL/TLS](#)
- [Install the Self-signed Certificate for Windows users with Administrator Rights](#)
- [Configure Certificates for Device Security](#)

## Configure a Certificate for SSL/TLS and Available Protocols

Configure a certificate on your machine using Web Based Management before you use SSL/TLS communication.

1. Start your web browser.
2. Type "https://machine's IP address" in your browser's address bar (where "machine's IP address" is the machine's IP address).

For example:

https://192.168.1.2



- If you are using a Domain Name System or enable a NetBIOS name, you can type another name, such as "SharedPrinter" instead of the IP address.

- For example:

https://SharedPrinter

If you enable a NetBIOS name, you can also use the node name.

- For example:

https://brnxxxxxxxxxxxx

The NetBIOS name can be found in the Network Configuration Report.

3. If required, type the password in the **Login** field, and then click **Login**.



The default password to manage this machine's settings is located on the back of the machine and marked "Pwd".

4. Go to the navigation menu, and then click **Network > Network > Protocol**.



Start from ☰, if the navigation menu is not shown on the left side of the screen.

5. Click **HTTP Server Settings**.
6. Select the certificate you want to configure from the **Select the Certificate** drop-down list.
7. Click **Submit**.
8. Click **Yes** to restart your print server.



### Related Information

- [Manage Your Network Machine Securely Using SSL/TLS](#)

#### Related Topics:

- [Print Documents Securely Using SSL/TLS](#)
- [Access Web Based Management](#)

## Access Web Based Management Using SSL/TLS

To manage your network machine securely, you must use management utilities with security protocols.



- To use HTTPS protocol, HTTPS must be enabled on your machine. The HTTPS protocol is enabled by default.
- You can change the HTTPS protocol settings using the Web Based Management screen.

1. Start your web browser.
2. Type "https://machine's IP address" in your browser's address bar (where "machine's IP address" is the machine's IP address).

For example:

https://192.168.1.2

3. If required, type the password in the **Login** field, and then click **Login**.



The default password to manage this machine's settings is located on the back of the machine and marked "Pwd".

4. You can now access the machine using HTTPS.



### Related Information





- [Manage Your Network Machine Securely Using SSL/TLS](#)

#### Related Topics:

- [Access Web Based Management](#)

## Install the Self-signed Certificate for Windows users with Administrator Rights

The following steps are for Microsoft Internet Explorer. If you use another web browser, consult the documentation for your web browser to get help with installing certificates.

1. Do one of the following:
  - Windows 10, Windows Server 2016, and Windows Server 2019  
Click  > **Windows Accessories**.
  - Windows 8.1  
Right-click the  (**Internet Explorer**) icon on the taskbar.
  - Windows Server 2012 and Windows Server 2012 R2  
Click  (**Internet Explorer**), and then right-click the  (**Internet Explorer**) icon that appears on the taskbar.
  - Windows 7 and Windows Server 2008  
Click  (**Start**) > **All Programs**.
2. Right-click **Internet Explorer**, and then click **Run as administrator**.



If the **More** option appears, click **More**.

If the **User Account Control** screen appears, click **Yes**.

3. Type "https://machine's IP address" in your browser's address bar to access your machine (where "machine's IP address" is the machine's IP address or the node name that you assigned for the certificate).
4. Click **More information**.
5. Click **Go on to the webpage (not recommended)**.
6. Click **Certificate error**, and then click **View certificates**.

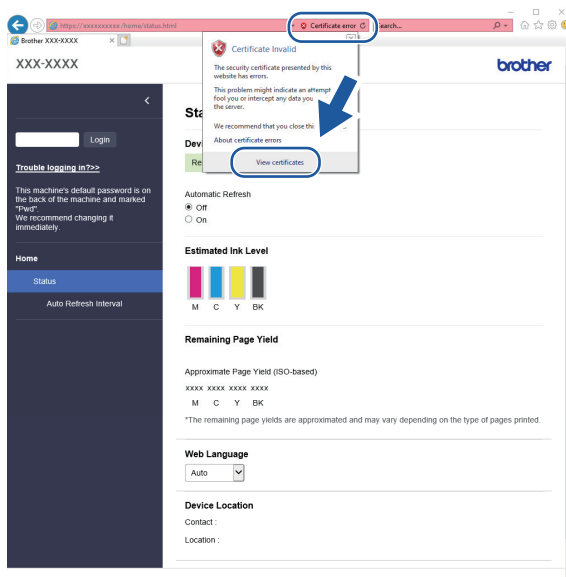

7. Click **Install Certificate....**
8. When the **Certificate Import Wizard** appears, click **Next**.
9. Select **Place all certificates in the following store**, and then click **Browse....**
10. Select **Trusted Root Certification Authorities**, and then click **OK**.

- 
11. Click **Next**.
  12. Click **Finish**.
  13. Click **Yes**, if the fingerprint (thumbprint) is correct.
  14. Click **OK**.



### **Related Information**

- [Manage Your Network Machine Securely Using SSL/TLS](#)
-

## Print Documents Securely Using SSL/TLS

- [Print Documents Using SSL/TLS](#)
- [Configure a Certificate for SSL/TLS and Available Protocols](#)
- [Configure Certificates for Device Security](#)

## Print Documents Using SSL/TLS

To print documents securely with IPP protocol, use the IPPS protocol.

1. Start your web browser.
2. Type "https://machine's IP address" in your browser's address bar (where "machine's IP address" is the machine's IP address).

For example:

https://192.168.1.2



- If you are using a Domain Name System or enable a NetBIOS name, you can type another name, such as "SharedPrinter" instead of the IP address.

- For example:

https://SharedPrinter

If you enable a NetBIOS name, you can also use the node name.

- For example:

https://brnxxxxxxxxxxxx

The NetBIOS name can be found in the Network Configuration Report.

3. If required, type the password in the **Login** field, and then click **Login**.



The default password to manage this machine's settings is located on the back of the machine and marked "Pwd".

4. Go to the navigation menu, and then click **Network > Network > Protocol**.



Start from , if the navigation menu is not shown on the left side of the screen.

5. Make sure the **IPP** check box is selected.



If the **IPP** check box is not selected, select the **IPP** check box, and then click **Submit**.

Restart your machine to activate the configuration.

After the machine restarts, return to the machine's web page, type the password, go to the navigation menu, and then click **Network > Network > Protocol**.

6. Click **HTTP Server Settings**.
7. Select the **HTTPS (Port 443)** check box in the **IPP**, and then click **Submit**.
8. Restart your machine to activate the configuration.

Communication using IPPS cannot prevent unauthorised access to the print server.



### Related Information

- [Print Documents Securely Using SSL/TLS](#)

#### Related Topics:

- [Access Web Based Management](#)

## Use SNMPv3

- [Manage Your Network Machine Securely Using SNMPv3](#)

## Manage Your Network Machine Securely Using SNMPv3

The Simple Network Management Protocol version 3 (SNMPv3) provides user authentication and data encryption to manage network devices securely. To manage your network machine securely, we recommend using the SNMPv3 protocol when you use BRAdmin Professional 4.

1. Start your web browser.
2. Type "https://machine's IP address" in your browser's address bar (where "machine's IP address" is the machine's IP address).

For example:

https://192.168.1.2

3. If required, type the password in the **Login** field, and then click **Login**.





The default password to manage this machine's settings is located on the back of the machine and marked "Pwd".

4. Go to the navigation menu, and then click **Network > Network > Protocol**.



Start from , if the navigation menu is not shown on the left side of the screen.

5. Make sure the **SNMP** setting is enabled, and then click **Advanced Settings**.
6. Configure the SNMP settings. There are three options for **SNMP Mode of Operation**.

Option	Description
<b>SNMP v1/v2c read-write access</b>	The print server uses version 1 and version 2c of the SNMP protocol. You can use all Brother applications in this mode. However, it is not secure since it will not authenticate the user, and data will not be encrypted.
<b>SNMPv3 read-write access and v1/v2c read-only access</b>	<p>The print server uses the read-write access of version 3 and the read-only access of version 1 and version 2c of the SNMP protocol.</p> <p> When you use <b>SNMPv3 read-write access and v1/v2c read-only access</b> mode, some Brother applications (such as BRAdmin Light) that access the print server do not work correctly since they authorize the read-only access of version 1 and version 2c. If you want to use all applications, we recommend using the <b>SNMP v1/v2c read-write access</b> mode.</p>
<b>SNMPv3 read-write access</b>	<p>The print server uses version 3 of the SNMP protocol. If you want to manage the print server securely, use this mode.</p> <p> When you use the <b>SNMPv3 read-write access</b> mode, note the following:</p> <ul style="list-style-type: none"><li>• You can use only BRAdmin Professional or Web Based Management to manage the print server.</li><li>• Except for BRAdmin Professional, all applications that use SNMPv1/v2c will be restricted. To allow the use of SNMPv1/v2c applications, use the <b>SNMPv3 read-write access and v1/v2c read-only access</b> or <b>SNMP v1/v2c read-write access</b> mode.</li></ul>

7. Click **Submit**.



### Related Information

- [Use SNMPv3](#)

---

**Related Topics:**

- [Access Web Based Management](#)
-

## Use IPsec

- [Introduction to IPsec](#)
- [Configure IPsec Using Web Based Management](#)
- [Configure an IPsec Address Template Using Web Based Management](#)
- [Configure an IPsec Template Using Web Based Management](#)

## Introduction to IPsec

IPsec (Internet Protocol Security) is a security protocol that uses an optional Internet Protocol function to prevent data manipulation and ensure the confidentiality of data transmitted as IP packets. IPsec encrypts data carried over the network, such as print data sent from computers to a printer. Because the data is encrypted at the network layer, applications that employ a higher-level protocol use IPsec even if the user is not aware of its use.

IPsec supports the following functions:

- IPsec transmissions

According to the IPsec setting conditions, the network-connected computer sends data to and receives data from the specified device using IPsec. When the devices start communicating using IPsec, keys are exchanged using Internet Key Exchange (IKE) first, and then the encrypted data is transmitted using the keys.

In addition, IPsec has two operation modes: the Transport mode and Tunnel mode. The Transport mode is used mainly for communication between devices and the Tunnel mode is used in environments such as a Virtual Private Network (VPN).



---

For IPsec transmissions, the following conditions are necessary:

- A computer that can communicate using IPsec is connected to the network.
  - Your machine is configured for IPsec communication.
  - The computer connected to your machine is configured for IPsec connections.
- 

- IPsec settings

The settings that are necessary for connections using IPsec. These settings can be configured using Web Based Management.



---

To configure the IPsec settings, you must use the browser on a computer that is connected to the network.

---



### Related Information

- [Use IPsec](#)
-

## Configure IPsec Using Web Based Management

The IPsec connection conditions comprise two **Template** types: **Address** and **IPsec**. You can configure up to 10 connection conditions.

1. Start your web browser.
2. Type "https://machine's IP address" in your browser's address bar (where "machine's IP address" is the machine's IP address).

For example:

https://192.168.1.2

3. If required, type the password in the **Login** field, and then click **Login**.



The default password to manage this machine's settings is located on the back of the machine and marked "Pwd".

4. Go to the navigation menu, and then click **Network > Security > IPsec**.



Start from , if the navigation menu is not shown on the left side of the screen.

5. Configure the settings.

Option	Description
<b>Status</b>	Enable or disable IPsec.
<b>Negotiation Mode</b>	Select <b>Negotiation Mode</b> for IKE Phase 1. IKE is a protocol that is used to exchange encryption keys in order to carry out encrypted communication using IPsec.  In <b>Main</b> mode, the processing speed is slow, but the security is high. In <b>Aggressive</b> mode, the processing speed is faster than <b>Main</b> mode, but the security is lower.
<b>All Non-IPsec Traffic</b>	Select the action to be taken for non-IPsec packets. When using Web Services, you must select <b>Allow</b> for <b>All Non-IPsec Traffic</b> . If you select <b>Drop</b> , Web Services cannot be used.
<b>Broadcast/Multicast Bypass</b>	Select <b>Enabled</b> or <b>Disabled</b> .
<b>Protocol Bypass</b>	Select the check box for the option or options you want.
<b>Rules</b>	Select the <b>Enabled</b> check box to activate the template. When you select multiple check boxes, the lower numbered check boxes have priority if the settings for the selected check boxes conflict.  Click on the corresponding drop-down list to select the <b>Address Template</b> that is used for the IPsec connection conditions. To add an <b>Address Template</b> , click <b>Add Template</b> .  Click on the corresponding drop-down list to select the <b>IPsec Template</b> that is used for the IPsec connection conditions. To add an <b>IPsec Template</b> , click <b>Add Template</b> .

6. Click **Submit**.

If the machine must be restarted to register the new settings, the restart confirmation screen will appear.

If there is a blank item in the template you enabled in the **Rules** table, an error message appears. Confirm your choices and click **Submit** again.



### Related Information

- [Use IPsec](#)

#### Related Topics:

- [Access Web Based Management](#)

- 
- Configure Certificates for Device Security
-

## Configure an IPsec Address Template Using Web Based Management

1. Start your web browser.
2. Type "https://machine's IP address" in your browser's address bar (where "machine's IP address" is the machine's IP address).

For example:

https://192.168.1.2

3. If required, type the password in the **Login** field, and then click **Login**.



The default password to manage this machine's settings is located on the back of the machine and marked "Pwd".

4. Go to the navigation menu, and then click **Network > Security > IPsec Address Template**.



Start from ☰, if the navigation menu is not shown on the left side of the screen.

5. Click the **Delete** button to delete an **Address Template**. When an **Address Template** is in use, it cannot be deleted.
6. Click the **Address Template** that you want to create. The **IPsec Address Template** appears.
7. Configure the settings.

Option	Description
<b>Template Name</b>	Type a name for the template (up to 16 characters).
<b>Local IP Address</b>	<ul style="list-style-type: none"> <li>• <b>IP Address</b> Specify the IP address. Select <b>ALL IPv4 Address</b>, <b>ALL IPv6 Address</b>, <b>ALL Link Local IPv6</b>, or <b>Custom</b> from the drop-down list. If you select <b>Custom</b> from the drop-down list, type the IP address (IPv4 or IPv6) in the text box.</li> <li>• <b>IP Address Range</b> Type the starting and ending IP addresses for the IP address range in the text boxes. If the starting and ending IP addresses are not standardised to IPv4 or IPv6, or the ending IP address is smaller than the starting address, an error will occur.</li> <li>• <b>IP Address / Prefix</b> Specify the IP address using CIDR notation. For example: 192.168.1.1/24 Because the prefix is specified in the form of a 24-bit subnet mask (255.255.255.0) for 192.168.1.1, the addresses 192.168.1.xxx are valid.</li> </ul>
<b>Remote IP Address</b>	<ul style="list-style-type: none"> <li>• <b>Any</b> If you select <b>Any</b>, all IP addresses are enabled.</li> <li>• <b>IP Address</b> Type the specified IP address (IPv4 or IPv6) in the text box.</li> <li>• <b>IP Address Range</b> Type the starting and ending IP addresses for the IP address range. If the starting and ending IP addresses are not standardised to IPv4 or IPv6, or the ending IP address is smaller than the starting address, an error will occur.</li> <li>• <b>IP Address / Prefix</b> Specify the IP address using CIDR notation. For example: 192.168.1.1/24</li> </ul>

---

Option	Description
	Because the prefix is specified in the form of a 24-bit subnet mask (255.255.255.0) for 192.168.1.1, the addresses 192.168.1.xxx are valid.

8. Click **Submit**.



---

When you change the settings for the template currently in use, restart your machine to active the configuration.

---



### Related Information

- [Use IPsec](#)

#### Related Topics:

- [Access Web Based Management](#)
-

## Configure an IPsec Template Using Web Based Management

1. Start your web browser.
2. Type "https://machine's IP address" in your browser's address bar (where "machine's IP address" is the machine's IP address).

For example:

https://192.168.1.2

3. If required, type the password in the **Login** field, and then click **Login**.



The default password to manage this machine's settings is located on the back of the machine and marked "Pwd".

4. Go to the navigation menu, and then click **Network > Security > IPsec Template**.



Start from ☰, if the navigation menu is not shown on the left side of the screen.

5. Click the **Delete** button to delete an **IPsec Template**. When an **IPsec Template** is in use, it cannot be deleted.
6. Click **IPsec Template** that you want to create. The **IPsec Template** screen appears. The configuration fields differ based on the **Use Prefixed Template** and **Internet Key Exchange (IKE)** you select.
7. In the **Template Name** field, type a name for the template (up to 16 characters).
8. If you selected **Custom** in the **Use Prefixed Template** drop-down list, select the **Internet Key Exchange (IKE)** options, and then change the settings if needed.
9. Click **Submit**.



### Related Information



- [Use IPsec](#)
  - [IKEv1 Settings for an IPsec Template](#)
  - [IKEv2 Settings for an IPsec Template](#)
  - [Manual Settings for an IPsec Template](#)

#### Related Topics:

- [Access Web Based Management](#)

## IKEv1 Settings for an IPsec Template

Option	Description
Template Name	Type a name for the template (up to 16 characters).
Use Prefixed Template	Select <b>Custom</b> , <b>IKEv1 High Security</b> or <b>IKEv1 Medium Security</b> . The setting items are different depending on the selected template.
Internet Key Exchange (IKE)	<p>IKE is a communication protocol that is used to exchange encryption keys in order to carry out encrypted communication using IPsec. To carry out encrypted communication for that time only, the encryption algorithm that is necessary for IPsec is determined and the encryption keys are shared. For IKE, the encryption keys are exchanged using the Diffie-Hellman key exchange method, and encrypted communication that is limited to IKE is carried out.</p> <p>If you selected <b>Custom</b> in <b>Use Prefixed Template</b>, select <b>IKEv1</b>.</p>
Authentication Type	<ul style="list-style-type: none"> <li>• <b>Diffie-Hellman Group</b> <p>This key exchange method allows secret keys to be securely exchanged over an unprotected network. The Diffie-Hellman key exchange method uses a discrete logarithm problem, not the secret key, to send and receive open information that was generated using a random number and the secret key.</p> <p>Select <b>Group1</b>, <b>Group2</b>, <b>Group5</b>, or <b>Group14</b>.</p> </li> <li>• <b>Encryption</b> <p>Select <b>DES</b>, <b>3DES</b>, <b>AES-CBC 128</b>, or <b>AES-CBC 256</b>.</p> </li> <li>• <b>Hash</b> <p>Select <b>MD5</b>, <b>SHA1</b>, <b>SHA256</b>, <b>SHA384</b> or <b>SHA512</b>.</p> </li> <li>• <b>SA Lifetime</b> <p>Specify the IKE SA lifetime.</p> <p>Type the time (seconds) and number of kilobytes (KByte).</p> </li> </ul>
Encapsulating Security	<ul style="list-style-type: none"> <li>• <b>Protocol</b> <p>Select <b>ESP</b>, <b>AH</b>, or <b>AH+ESP</b>.</p> <hr/> <ul style="list-style-type: none"> <li>-  ESP is a protocol for carrying out encrypted communication using IPsec. ESP encrypts the payload (communicated contents) and adds additional information. The IP packet comprises the header and the encrypted payload, which follows the header. In addition to the encrypted data, the IP packet also includes information regarding the encryption method and encryption key, the authentication data, and so on.</li> <li>- AH is part of the IPsec protocol that authenticates the sender and prevents manipulation (ensures the completeness) of the data. In the IP packet, the data is inserted immediately after the header. In addition, the packets include hash values, which are calculated using an equation from the communicated contents, secret key, and so on, in order to prevent the falsification of the sender and manipulation of the data. Unlike ESP, the communicated contents are not encrypted, and the data is sent and received as plain text.</li> </ul> <hr/> </li> <li>• <b>Encryption</b> <p>Select <b>DES</b>, <b>3DES</b>, <b>AES-CBC 128</b>, or <b>AES-CBC 256</b>.</p> </li> <li>• <b>Hash</b> <p>Select <b>None</b>, <b>MD5</b>, <b>SHA1</b>, <b>SHA256</b>, <b>SHA384</b> or <b>SHA512</b>.</p> </li> </ul>



Option	Description
	<ul style="list-style-type: none"> <li>• <b>SA Lifetime</b> Specify the IKE SA lifetime. Type the time (seconds) and number of kilobytes (KByte).</li> <li>• <b>Encapsulation Mode</b> Select <b>Transport</b> or <b>Tunnel</b>.</li> <li>• <b>Remote Router IP-Address</b> Type the IP address (IPv4 or IPv6) of the remote router. Enter this information only when the <b>Tunnel</b> mode is selected.</li> </ul> <hr/>  SA (Security Association) is an encrypted communication method using IPsec or IPv6 that exchanges and shares information, such as the encryption method and encryption key, in order to establish a secure communication channel before communication begins. SA may also refer to a virtual encrypted communication channel that has been established. The SA used for IPsec establishes the encryption method, exchanges the keys, and carries out mutual authentication according to the IKE (Internet Key Exchange) standard procedure. In addition, the SA is updated periodically.
<b>Perfect Forward Secrecy (PFS)</b>	<p>PFS does not derive keys from previous keys that were used to encrypt messages. In addition, if a key that is used to encrypt a message was derived from a parent key, that parent key is not used to derive other keys. Therefore, even if a key is compromised, the damage will be limited only to the messages that were encrypted using that key.</p> <p>Select <b>Enabled</b> or <b>Disabled</b>.</p>
<b>Authentication Method</b>	<p>Select the authentication method. Select <b>Pre-Shared Key</b> or <b>Certificates</b>.</p>
<b>Pre-Shared Key</b>	<p>When encrypting communication, the encryption key is exchanged and shared beforehand using another channel.</p> <p>If you selected <b>Pre-Shared Key</b> for the <b>Authentication Method</b>, type the <b>Pre-Shared Key</b> (up to 32 characters).</p> <ul style="list-style-type: none"> <li>• <b>Local/ID Type/ID</b> Select the sender's ID type, and then type the ID. Select <b>IPv4 Address</b>, <b>IPv6 Address</b>, <b>FQDN</b>, <b>E-mail Address</b>, or <b>Certificate</b> for the type. If you select <b>Certificate</b>, type the common name of the certificate in the <b>ID</b> field.</li> <li>• <b>Remote/ID Type/ID</b> Select the recipient's ID type, and then type the ID. Select <b>IPv4 Address</b>, <b>IPv6 Address</b>, <b>FQDN</b>, <b>E-mail Address</b>, or <b>Certificate</b> for the type. If you select <b>Certificate</b>, type the common name of the certificate in the <b>ID</b> field.</li> </ul>
<b>Certificate</b>	<p>If you selected <b>Certificates</b> for <b>Authentication Method</b>, select the certificate.</p> <hr/>  You can select only the certificates that were created using the <b>Certificate</b> page of Web Based Management's Security configuration screen.

### Related Information

- [Configure an IPsec Template Using Web Based Management](#)

## IKEv2 Settings for an IPsec Template

Option	Description
<b>Template Name</b>	Type a name for the template (up to 16 characters).
<b>Use Prefixed Template</b>	Select <b>Custom</b> , <b>IKEv2 High Security</b> , or <b>IKEv2 Medium Security</b> . The setting items are different depending on the selected template.
<b>Internet Key Exchange (IKE)</b>	IKE is a communication protocol that is used to exchange encryption keys in order to carry out encrypted communication using IPsec. To carry out encrypted communication for that time only, the encryption algorithm that is necessary for IPsec is determined and the encryption keys are shared. For IKE, the encryption keys are exchanged using the Diffie-Hellman key exchange method, and encrypted communication that is limited to IKE is carried out. If you selected <b>Custom</b> in <b>Use Prefixed Template</b> , select <b>IKEv2</b> .
<b>Authentication Type</b>	<ul style="list-style-type: none"> <li>• <b>Diffie-Hellman Group</b> This key exchange method allows secret keys to be securely exchanged over an unprotected network. The Diffie-Hellman key exchange method uses a discrete logarithm problem, not the secret key, to send and receive open information that was generated using a random number and the secret key. Select <b>Group1</b>, <b>Group2</b>, <b>Group5</b>, or <b>Group14</b>.</li> <li>• <b>Encryption</b> Select <b>DES</b>, <b>3DES</b>, <b>AES-CBC 128</b>, or <b>AES-CBC 256</b>.</li> <li>• <b>Hash</b> Select <b>MD5</b>, <b>SHA1</b>, <b>SHA256</b>, <b>SHA384</b> or <b>SHA512</b>.</li> <li>• <b>SA Lifetime</b> Specify the IKE SA lifetime. Type the time (seconds) and number of kilobytes (KByte).</li> </ul>
<b>Encapsulating Security</b>	<ul style="list-style-type: none"> <li>• <b>Protocol</b> Select <b>ESP</b>.   ESP is a protocol for carrying out encrypted communication using IPsec. ESP encrypts the payload (communicated contents) and adds additional information. The IP packet comprises the header and the encrypted payload, which follows the header. In addition to the encrypted data, the IP packet also includes information regarding the encryption method and encryption key, the authentication data, and so on.</li> <li>• <b>Encryption</b> Select <b>DES</b>, <b>3DES</b>, <b>AES-CBC 128</b>, or <b>AES-CBC 256</b>.</li> <li>• <b>Hash</b> Select <b>MD5</b>, <b>SHA1</b>, <b>SHA256</b>, <b>SHA384</b>, or <b>SHA512</b>.</li> <li>• <b>SA Lifetime</b> Specify the IKE SA lifetime. Type the time (seconds) and number of kilobytes (KByte).</li> <li>• <b>Encapsulation Mode</b> Select <b>Transport</b> or <b>Tunnel</b>.</li> <li>• <b>Remote Router IP-Address</b> Type the IP address (IPv4 or IPv6) of the remote router. Enter this information only when the <b>Tunnel</b> mode is selected.</li> </ul>

Option	Description
	 SA (Security Association) is an encrypted communication method using IPsec or IPv6 that exchanges and shares information, such as the encryption method and encryption key, in order to establish a secure communication channel before communication begins. SA may also refer to a virtual encrypted communication channel that has been established. The SA used for IPsec establishes the encryption method, exchanges the keys, and carries out mutual authentication according to the IKE (Internet Key Exchange) standard procedure. In addition, the SA is updated periodically.
<b>Perfect Forward Secrecy (PFS)</b>	PFS does not derive keys from previous keys that were used to encrypt messages. In addition, if a key that is used to encrypt a message was derived from a parent key, that parent key is not used to derive other keys. Therefore, even if a key is compromised, the damage will be limited only to the messages that were encrypted using that key. Select <b>Enabled</b> or <b>Disabled</b> .
<b>Authentication Method</b>	Select the authentication method. Select <b>Pre-Shared Key</b> , <b>Certificates</b> , <b>EAP - MD5</b> , or <b>EAP - MS-CHAPv2</b> .   EAP is an authentication protocol that is an extension of PPP. By using EAP with IEEE802.1x, a different key is used for user authentication during each session.  The following settings are necessary only when <b>EAP - MD5</b> or <b>EAP - MS-CHAPv2</b> is selected in <b>Authentication Method</b> : <ul style="list-style-type: none"> <li>• <b>Mode</b> Select <b>Server-Mode</b> or <b>Client-Mode</b>.</li> <li>• <b>Certificate</b> Select the certificate.</li> <li>• <b>User Name</b> Type the user name (up to 32 characters).</li> <li>• <b>Password</b> Type the password (up to 32 characters). The password must be entered two times for confirmation.</li> </ul>
<b>Pre-Shared Key</b>	When encrypting communication, the encryption key is exchanged and shared beforehand using another channel.  If you selected <b>Pre-Shared Key</b> for the <b>Authentication Method</b> , type the <b>Pre-Shared Key</b> (up to 32 characters). <ul style="list-style-type: none"> <li>• <b>Local/ID Type/ID</b> Select the sender's ID type, and then type the ID. Select <b>IPv4 Address</b>, <b>IPv6 Address</b>, <b>FQDN</b>, <b>E-mail Address</b>, or <b>Certificate</b> for the type. If you select <b>Certificate</b>, type the common name of the certificate in the <b>ID</b> field.</li> <li>• <b>Remote/ID Type/ID</b> Select the recipient's ID type, and then type the ID. Select <b>IPv4 Address</b>, <b>IPv6 Address</b>, <b>FQDN</b>, <b>E-mail Address</b>, or <b>Certificate</b> for the type. If you select <b>Certificate</b>, type the common name of the certificate in the <b>ID</b> field.</li> </ul>
<b>Certificate</b>	If you selected <b>Certificates</b> for <b>Authentication Method</b> , select the certificate.

---



Option	Description
	 You can select only the certificates that were created using the <b>Certificate</b> page of Web Based Management's Security configuration screen.



### Related Information

- [Configure an IPsec Template Using Web Based Management](#)
-

## Manual Settings for an IPsec Template

Option	Description
<b>Template Name</b>	Type a name for the template (up to 16 characters).
<b>Use Prefixed Template</b>	Select <b>Custom</b> .
<b>Internet Key Exchange (IKE)</b>	<p>IKE is a communication protocol that is used to exchange encryption keys in order to carry out encrypted communication using IPsec. To carry out encrypted communication for that time only, the encryption algorithm that is necessary for IPsec is determined and the encryption keys are shared. For IKE, the encryption keys are exchanged using the Diffie-Hellman key exchange method, and encrypted communication that is limited to IKE is carried out.</p> <p>Select <b>Manual</b>.</p>
<b>Authentication Key (ESP, AH)</b>	<p>Type the <b>In/Out</b> values.</p> <p>These settings are necessary when <b>Custom</b> is selected for <b>Use Prefixed Template</b>, <b>Manual</b> is selected for <b>Internet Key Exchange (IKE)</b>, and a setting other than <b>None</b> is selected for <b>Hash</b> for <b>Encapsulating Security</b> section.</p> <hr/> <p> The number of characters you can set differs depending on the setting you chose for <b>Hash</b> in the <b>Encapsulating Security</b> section.</p> <p>If the length of the specified authentication key is different than the selected hash algorithm, an error will occur.</p> <ul style="list-style-type: none"> <li>• <b>MD5</b>: 128 bits (16 bytes)</li> <li>• <b>SHA1</b>: 160 bits (20 bytes)</li> <li>• <b>SHA256</b>: 256 bits (32 bytes)</li> <li>• <b>SHA384</b>: 384 bits (48 bytes)</li> <li>• <b>SHA512</b>: 512 bits (64 bytes)</li> </ul> <p>When you specify the key in ASCII Code, enclose the characters in double quotation marks (").</p> <hr/>
<b>Code key (ESP)</b>	<p>Type the <b>In/Out</b> values.</p> <p>These settings are necessary when <b>Custom</b> is selected in <b>Use Prefixed Template</b>, <b>Manual</b> is selected in <b>Internet Key Exchange (IKE)</b>, and <b>ESP</b> is selected in <b>Protocol</b> in <b>Encapsulating Security</b>.</p> <hr/> <p> The number of characters you can set differs depending on the setting you chose for <b>Encryption</b> in the <b>Encapsulating Security</b> section.</p> <p>If the length of the specified code key is different than the selected encryption algorithm, an error will occur.</p> <ul style="list-style-type: none"> <li>• <b>DES</b>: 64 bits (8 bytes)</li> <li>• <b>3DES</b>: 192 bits (24 bytes)</li> <li>• <b>AES-CBC 128</b>: 128 bits (16 bytes)</li> <li>• <b>AES-CBC 256</b>: 256 bits (32 bytes)</li> </ul> <p>When you specify the key in ASCII Code, enclose the characters in double quotation marks (").</p> <hr/>
<b>SPI</b>	<p>These parameters are used to identify security information. Generally, a host has multiple Security Associations (SAs) for several types of IPsec communication. Therefore, it is necessary to identify the applicable SA when an IPsec packet is received. The SPI parameter, which identifies the SA, is included in the Authentication Header (AH) and Encapsulating Security Payload (ESP) header.</p>

Option	Description
	<p>These settings are necessary when <b>Custom</b> is selected for <b>Use Prefixed Template</b>, and <b>Manual</b> is selected for <b>Internet Key Exchange (IKE)</b>.</p> <p>Enter the <b>In/Out</b> values. (3-10 characters)</p>
<p><b>Encapsulating Security</b></p>	<ul style="list-style-type: none"> <li>• <b>Protocol</b> Select <b>ESP</b> or <b>AH</b>.</li> </ul> <hr/> <ul style="list-style-type: none"> <li>✎ - ESP is a protocol for carrying out encrypted communication using IPsec. ESP encrypts the payload (communicated contents) and adds additional information. The IP packet comprises the header and the encrypted payload, which follows the header. In addition to the encrypted data, the IP packet also includes information regarding the encryption method and encryption key, the authentication data, and so on.</li> <li>- AH is part of the IPsec protocol that authenticates the sender and prevents manipulation of the data (ensures the completeness of the data). In the IP packet, the data is inserted immediately after the header. In addition, the packets include hash values, which are calculated using an equation from the communicated contents, secret key, and so on, in order to prevent the falsification of the sender and manipulation of the data. Unlike ESP, the communicated contents are not encrypted, and the data is sent and received as plain text.</li> </ul> <hr/> <ul style="list-style-type: none"> <li>• <b>Encryption</b> Select <b>DES</b>, <b>3DES</b>, <b>AES-CBC 128</b>, or <b>AES-CBC 256</b>.</li> <li>• <b>Hash</b> Select <b>None</b>, <b>MD5</b>, <b>SHA1</b>, <b>SHA256</b>, <b>SHA384</b>, or <b>SHA512</b>. <b>None</b> can be selected only when <b>ESP</b> is selected in <b>Protocol</b>.</li> <li>• <b>SA Lifetime</b> Specify the IKE SA lifetime. Type the time (seconds) and number of kilobytes (KByte).</li> <li>• <b>Encapsulation Mode</b> Select <b>Transport</b> or <b>Tunnel</b>.</li> <li>• <b>Remote Router IP-Address</b> Type the IP address (IPv4 or IPv6) of the remote router. Enter this information only when the <b>Tunnel</b> mode is selected.</li> </ul> <hr/> <ul style="list-style-type: none"> <li>✎ SA (Security Association) is an encrypted communication method using IPsec or IPv6 that exchanges and shares information, such as the encryption method and encryption key, in order to establish a secure communication channel before communication begins. SA may also refer to a virtual encrypted communication channel that has been established. The SA used for IPsec establishes the encryption method, exchanges the keys, and carries out mutual authentication according to the IKE (Internet Key Exchange) standard procedure. In addition, the SA is updated periodically.</li> </ul>



### Related Information

- [Configure an IPsec Template Using Web Based Management](#)

## Use IEEE 802.1x Authentication for a Wired or a Wireless Network

- [What Is IEEE 802.1x Authentication?](#)
- [Configure IEEE 802.1x Authentication for a Wired or a Wireless Network Using Web Based Management \(Web Browser\)](#)
- [IEEE 802.1x Authentication Methods](#)

## What Is IEEE 802.1x Authentication?

IEEE 802.1x is an IEEE standard for wired and wireless networks that limits access from unauthorised network devices. Your Brother machine (supplicant) sends an authentication request to a RADIUS server (Authentication server) through your access point or HUB. After your request has been verified by the RADIUS server, your machine can access the network.



### Related Information

- [Use IEEE 802.1x Authentication for a Wired or a Wireless Network](#)
-

## Configure IEEE 802.1x Authentication for a Wired or a Wireless Network Using Web Based Management (Web Browser)

- If you configure your machine using EAP-TLS authentication, you must install the client certificate issued by a CA before you start configuration. Contact your network administrator about the client certificate. If you have installed more than one certificate, we recommend writing down the certificate name you want to use.
- Before you verify the server certificate, you must import the CA certificate issued by the CA that signed the server certificate. Contact your network administrator or your Internet Service Provider (ISP) to confirm whether a CA certificate import is necessary.



You can also configure IEEE 802.1x authentication using Wireless setup wizard from the control panel (Wireless network).

1. Start your web browser.
2. Type "https://machine's IP address" in your browser's address bar (where "machine's IP address" is the machine's IP address).

For example:

https://192.168.1.2



- If you are using a Domain Name System or enable a NetBIOS name, you can type another name, such as "SharedPrinter" instead of the IP address.

- For example:

https://SharedPrinter

If you enable a NetBIOS name, you can also use the node name.

- For example:

https://brnxxxxxxxxxxxxx

The NetBIOS name can be found in the Network Configuration Report.

3. If required, type the password in the **Login** field, and then click **Login**.



The default password to manage this machine's settings is located on the back of the machine and marked "Pwd".

4. Go to the navigation menu, and then click **Network**.



Start from ☰, if the navigation menu is not shown on the left side of the screen.

5. Do one of the following:
  - For the wired network  
Click **Wired** > **Wired 802.1x Authentication**.
  - For the wireless network  
Click **Wireless** > **Wireless (Enterprise)**.
6. Configure the IEEE 802.1x authentication settings.



- To enable IEEE 802.1x authentication for wired networks, select **Enabled** for **Wired 802.1x status** on the **Wired 802.1x Authentication** page.
- If you are using **EAP-TLS** authentication, you must select the client certificate installed (shown with certificate name) for verification from the **Client Certificate** drop-down list.
- If you select **EAP-FAST**, **PEAP**, **EAP-TTLS**, or **EAP-TLS** authentication, select the verification method from the **Server Certificate Verification** drop-down list. Verify the server certificate using the CA certificate, imported to the machine in advance, issued by the CA that signed the server certificate.

Select one of the following verification methods from the **Server Certificate Verification** drop-down list:

Option	Description
<b>No Verification</b>	The server certificate can always be trusted. The verification is not performed.
<b>CA Cert.</b>	The verification method to check the CA reliability of the server certificate, using the CA certificate issued by the CA that signed the server certificate.
<b>CA Cert. + ServerID</b>	The verification method to check the common name <sup>1</sup> value of the server certificate, in addition to the CA reliability of the server certificate.

7. When finished with configuration, click **Submit**.

For wired networks: After configuring, connect your machine to the IEEE 802.1x supported network. After a few minutes, print the Network Configuration Report to check the **<Wired IEEE 802.1x>** status.

Option	Description
<b>Success</b>	The wired IEEE 802.1x function is enabled and the authentication was successful.
<b>Failed</b>	The wired IEEE 802.1x function is enabled; however, the authentication failed.
<b>Off</b>	The wired IEEE 802.1x function is not available.



## Related Information

- [Use IEEE 802.1x Authentication for a Wired or a Wireless Network](#)

### Related Topics:

- [Print the Network Configuration Report](#)
- [Print the WLAN Report](#)
- [Access Web Based Management](#)
- [Configure Certificates for Device Security](#)
- [Supported Security Certificate Features](#)

<sup>1</sup> The common name verification compares the common name of the server certificate to the character string configured for the **Server ID**. Before you use this method, contact your system administrator about the server certificate's common name and then configure **Server ID**.

## IEEE 802.1x Authentication Methods

### EAP-FAST

Extensible Authentication Protocol-Flexible Authentication via Secured Tunneling (EAP-FAST) has been developed by Cisco Systems, Inc., which uses a user ID and password for authentication, and symmetric key algorithms to achieve a tunnelled authentication process.

The Brother machine supports the following inner authentication methods:

- EAP-FAST/NONE
- EAP-FAST/MS-CHAPv2
- EAP-FAST/GTC

### EAP-MD5 (Wired network)

Extensible Authentication Protocol-Message Digest Algorithm 5 (EAP-MD5) uses a user ID and password for challenge-response authentication.

### PEAP

Protected Extensible Authentication Protocol (PEAP) is a version of EAP method developed by Cisco Systems, Inc., Microsoft Corporation and RSA Security. PEAP creates an encrypted Secure Sockets Layer (SSL)/Transport Layer Security (TLS) tunnel between a client and an authentication server, for sending a user ID and password. PEAP provides mutual authentication between the server and the client.

The Brother machine supports the following inner authentications:

- PEAP/MS-CHAPv2
- PEAP/GTC

### EAP-TTLS

Extensible Authentication Protocol-Tunneled Transport Layer Security (EAP-TTLS) has been developed by Funk Software and Certicom. EAP-TTLS creates a similar encrypted SSL tunnel to PEAP, between a client and an authentication server, for sending a user ID and password. EAP-TTLS provides mutual authentication between the server and the client.

The Brother machine supports the following inner authentications:

- EAP-TTLS/CHAP
- EAP-TTLS/MS-CHAP
- EAP-TTLS/MS-CHAPv2
- EAP-TTLS/PAP

### EAP-TLS

Extensible Authentication Protocol-Transport Layer Security (EAP-TLS) requires digital certificate authentication both at a client and an authentication server.



### Related Information

- [Use IEEE 802.1x Authentication for a Wired or a Wireless Network](#)

## Use Active Directory Authentication

**Related Models:** MFC-J6555DW/MFC-J6955DW/MFC-J6957DW

- [Introduction to Active Directory Authentication](#)
- [Configure Active Directory Authentication Using Web Based Management](#)
- [Log On to Change the Machine Settings Using the Machine's Control Panel \(Active Directory Authentication\)](#)

## Introduction to Active Directory Authentication

**Related Models:** MFC-J6555DW/MFC-J6955DW/MFC-J6957DW

Active Directory Authentication restricts the use of your machine. If Active Directory Authentication is enabled, the machine's control panel will be locked. You cannot change the machine's settings until you enter a User ID and password.

Active Directory Authentication offers the following features:

- Stores incoming fax data
- Obtains the email address from the Active Directory server based on your User ID, when sending scanned data to an email server. To use this feature, select the **On** option for the **Get Mail Address** setting and **LDAP + kerberos** authentication method. Your email address will be set as the sender when the machine sends scanned data to an email server, or as the recipient if you want to send the scanned data to your email address.

When Active Directory Authentication is enabled, your machine stores all incoming fax data. After you log on, the machine prints the stored fax data.

You can change the Active Directory Authentication settings using Web Based Management.



### Related Information

- [Use Active Directory Authentication](#)

## Configure Active Directory Authentication Using Web Based Management

**Related Models:** MFC-J6555DW/MFC-J6955DW/MFC-J6957DW

Active Directory authentication supports Kerberos authentication and NTLMv2 authentication. You must configure the SNTP protocol (network time server) and DNS server configuration for authentication.

1. Start your web browser.
2. Type "https://machine's IP address" in your browser's address bar (where "machine's IP address" is the machine's IP address).

For example:

https://192.168.1.2

3. If required, type the password in the **Login** field, and then click **Login**.



The default password to manage this machine's settings is located on the back of the machine and marked "Pwd".

4. Go to the navigation menu, and then click **Administrator > User Restriction Function**.



Start from , if the navigation menu is not shown on the left side of the screen.

5. Select **Active Directory Authentication**.
6. Click **Submit**.
7. Select the **Active Directory Authentication** menu.
8. Configure the following settings:

Option	Description
<b>Storage Fax RX Data</b>	Select this option to store incoming fax data. You can print all incoming fax data after you log on to the machine.
<b>Remember User ID</b>	Select this option to save your User ID.
<b>Active Directory Server Address</b>	Type the IP address or the server name (for example: ad.example.com) of the Active Directory Server.
<b>Active Directory Domain Name</b>	Type the Active Directory domain name.
<b>Protocol &amp; Authentication Method</b>	Select the protocol and authentication method.
<b>LDAP Server Port</b>	Type the port number to connect the Active Directory server via LDAP (available only for <b>LDAP + kerberos</b> authentication method).
<b>LDAP Search Root</b>	Type the LDAP search root (available only for <b>LDAP + kerberos</b> authentication method).
<b>Get Mail Address</b>	Select this option to obtain logged on user's email address from the Active Directory server. (available only for <b>LDAP + kerberos</b> authentication method)
<b>Get User's Home Directory</b>	Select this option to obtain your home directory as the Scan to Network destination. (available only for <b>LDAP + kerberos</b> authentication method)

---

9. Click **Submit**.



### **Related Information**

- [Use Active Directory Authentication](#)

#### **Related Topics:**

- [Access Web Based Management](#)
-

## Log On to Change the Machine Settings Using the Machine's Control Panel (Active Directory Authentication)

**Related Models:** MFC-J6555DW/MFC-J6955DW/MFC-J6957DW

When Active Directory Authentication is enabled, the machine's control panel will be locked until you enter your User ID and password on the machine's control panel.

1. On the machine's control panel, use the touchscreen to enter your User ID and Password.
2. Press [OK].
3. When authentication is successful, the machine's control panel will be unlocked.



### Related Information

- [Use Active Directory Authentication](#)

## Use LDAP Authentication

**Related Models:** MFC-J6555DW/MFC-J6955DW/MFC-J6957DW

- [Introduction to LDAP Authentication](#)
- [Configure LDAP Authentication Using Web Based Management](#)
- [Log On to Change the Machine Settings Using the Machine's Control Panel \(LDAP Authentication\)](#)

## Introduction to LDAP Authentication

**Related Models:** MFC-J6555DW/MFC-J6955DW/MFC-J6957DW

LDAP Authentication restricts the use of your machine. If LDAP Authentication is enabled, the machine's control panel will be locked. You cannot change the machine's settings until you enter a User ID and password.

LDAP Authentication offers the following features:

- Stores incoming fax data
- Obtains the email address from the LDAP server based on your User ID, when sending scanned data to an email server. To use this feature, select the **On** option for the **Get Mail Address** setting. Your email address will be set as the sender when the machine sends scanned data to an email server, or as the recipient if you want to send the scanned data to your email address.

When LDAP Authentication is enabled, your machine stores all incoming fax data. After you log on, the machine prints the stored fax data.

You can change the LDAP Authentication settings using Web Based Management.



### Related Information

- [Use LDAP Authentication](#)

## Configure LDAP Authentication Using Web Based Management

**Related Models:** MFC-J6555DW/MFC-J6955DW/MFC-J6957DW

1. Start your web browser.
2. Type "https://machine's IP address" in your browser's address bar (where "machine's IP address" is the machine's IP address).  
For example:  
https://192.168.1.2
3. If required, type the password in the **Login** field, and then click **Login**.



The default password to manage this machine's settings is located on the back of the machine and marked "Pwd".

4. Go to the navigation menu, and then click **Administrator > User Restriction Function**.



Start from , if the navigation menu is not shown on the left side of the screen.

5. Select **LDAP Authentication**.
6. Click **Submit**.
7. Click the **LDAP Authentication** menu.
8. Configure the following settings:

Option	Description
<b>Storage Fax RX Data</b>	Select this option to store incoming fax data. You can print all incoming fax data after you log on to the machine.
<b>Remember User ID</b>	Select this option to save your User ID.
<b>LDAP Server Address</b>	Type the IP address or the server name (for example: ldap.example.com) of the LDAP server.
<b>LDAP Server Port</b>	Type the LDAP server port number.
<b>LDAP Search Root</b>	Type the LDAP search root directory.
<b>Attribute of Name (Search Key)</b>	Type the attribute you want to use as a search key.
<b>Get Mail Address</b>	Select this option to obtain the logged user's email address from the LDAP server.
<b>Get User's Home Directory</b>	Select this option to obtain your home directory as the Scan to Network destination.

9. Click **Submit**.



### Related Information

- [Use LDAP Authentication](#)

#### Related Topics:

- [Access Web Based Management](#)

## Log On to Change the Machine Settings Using the Machine's Control Panel (LDAP Authentication)

**Related Models:** MFC-J6555DW/MFC-J6955DW/MFC-J6957DW

When LDAP Authentication is enabled, the machine's control panel will be locked until you enter your User ID and password on the machine's control panel.

1. On the machine's control panel, use the touchscreen to enter your User ID and Password.
2. Press [OK].
3. When authentication is successful, the machine's control panel will be unlocked.



### Related Information

- [Use LDAP Authentication](#)

## Use Secure Function Lock 3.0

Secure Function Lock 3.0 increases security by restricting the functions available on your machine.

- [Before Using Secure Function Lock 3.0](#)
- [Configure Secure Function Lock 3.0 Using Web Based Management](#)
- [Scan Using Secure Function Lock 3.0](#)
- [Configure Public Mode for Secure Function Lock 3.0](#)
- [Additional Secure Function Lock 3.0 Features](#)
- [Register a new IC Card Using the Machine's Control Panel](#)
- [Register an External IC Card Reader](#)

## Before Using Secure Function Lock 3.0

Use Secure Function Lock to configure passwords, set specific user page limits, and grant access to some or all of the functions listed here.

You can configure and change the following Secure Function Lock 3.0 settings using Web Based Management:

- **Print**  
Print includes print jobs sent via AirPrint, Brother iPrint&Scan, and Brother Mobile Connect.  
If you register users' logon names in advance, the users will not need to enter their passwords when they use the print function.
- **Copy**
- **Scan**  
Scan includes scan jobs sent via Brother iPrint&Scan and Brother Mobile Connect.
- **Fax** (supported models only)
  - **Send**
  - **Receive**
- **Media**
  - **Print from**
  - **Scan to**
- **Web Connect** (supported models only)
  - **Upload**
  - **Download**
- **Apps** (supported models only)
- **Page Limits** (\*)
- **Colour Print**
- **Page Counters**
- **Card ID (NFC ID)** (supported models only)



### Related Information

- [Use Secure Function Lock 3.0](#)

## Configure Secure Function Lock 3.0 Using Web Based Management

1. Start your web browser.
2. Type "https://machine's IP address" in your browser's address bar (where "machine's IP address" is the machine's IP address).

For example:

https://192.168.1.2

3. If required, type the password in the **Login** field, and then click **Login**.



The default password to manage this machine's settings is located on the back of the machine and marked "Pwd".

4. Go to the navigation menu, and then click **Administrator** > **Restriction Management** or **User Restriction Function**.



Start from ☰, if the navigation menu is not shown on the left side of the screen.

5. Select **Secure Function Lock**.
6. Click **Submit**.
7. Click the **Restricted Functions** menu.
8. In the **User List / Restricted Functions** field, type a group name or user name.
9. In the **Print** and the other columns, select a check box to allow or clear a check box to restrict the function listed.
10. To configure the maximum page count, select the **On** check box in the **Page Limits** column, and then type the maximum number in the **Max. Pages** field.
11. Click **Submit**.
12. Click the **User List** menu.
13. In the **User List** field, type the user name.
14. In the **Password** field, type a password.



The number of characters you can set differs depending on the model.

15. In the **E-mail Address** field, type the user's email address (available only for certain models).
16. To register the user's Card ID, type the card number in the **Card ID (NFC ID)** field (available only for certain models).
17. Select **User List / Restricted Functions** from the drop-down list for each user.
18. Click **Submit**.



You can also change the user list lockout settings in the **Secure Function Lock** menu.



### Related Information

- [Use Secure Function Lock 3.0](#)

#### Related Topics:

- [Access Web Based Management](#)

## Scan Using Secure Function Lock 3.0

### Setting Scan restrictions (for administrators)

Secure Function Lock 3.0 allows an administrator to restrict which users are allowed to scan. When the Scan feature is set to Off for the public user setting, only users who have the **Scan** check box selected will be able to scan.

### Using the Scan feature (for restricted users)

- To scan using the machine's control panel:  
Restricted users must enter their passwords on the machine's control panel to access Scan mode.
- To scan from a computer:  
Restricted users must enter their passwords on the machine's control panel before scanning from their computers. If the password is not entered on the machine's control panel, an error message will appear on the user's computer.



If the machine supports IC card authentication, restricted users can also access Scan mode by touching the NFC symbol on the machine's control panel with their registered IC cards.



### Related Information

- [Use Secure Function Lock 3.0](#)

## Configure Public Mode for Secure Function Lock 3.0

Use the Secure Function Lock screen to set up Public Mode, which limits the functions available to public users. Public users will not need to enter a password to access the features made available through Public Mode settings.



Public Mode includes print jobs sent via Brother iPrint&Scan and Brother Mobile Connect.

1. Start your web browser.
2. Type "https://machine's IP address" in your browser's address bar (where "machine's IP address" is the machine's IP address).

For example:

https://192.168.1.2

3. If required, type the password in the **Login** field, and then click **Login**.



The default password to manage this machine's settings is located on the back of the machine and marked "Pwd".

4. Go to the navigation menu, and then click **Administrator > Restriction Management** or **User Restriction Function**.



Start from , if the navigation menu is not shown on the left side of the screen.

5. Select **Secure Function Lock**.
6. Click **Submit**.
7. Click the **Restricted Functions** menu.
8. In the **Public Mode** row, select a check box to allow or clear a check box to restrict the function listed.
9. Click **Submit**.



### Related Information

- [Use Secure Function Lock 3.0](#)

#### Related Topics:

- [Access Web Based Management](#)

## Additional Secure Function Lock 3.0 Features

Configure the following features in the Secure Function Lock screen:

### All Counter Reset

Click **All Counter Reset**, in the **Page Counters** column, to reset the page counter.

### Export to CSV file

Click **Export to CSV file**, to export the current and last page counter including **User List / Restricted Functions** information as a CSV file.

### Card ID (NFC ID) (supported models only)

Click the **User List** menu, and then type a users' Card ID in the **Card ID (NFC ID)** field. You can use your IC card for authentication.

### Last Counter Record

Click **Last Counter Record** if you want the machine to retain the page count after the counter has been reset.

### Counter Auto Reset

Click **Counter Auto Reset** to configure the time interval you want between page counter reset. Choose a daily, weekly, or monthly interval.



### Related Information

- [Use Secure Function Lock 3.0](#)

## Register a new IC Card Using the Machine's Control Panel

**Related Models:** MFC-J6955DW/MFC-J6957DW

1. Touch the Near-Field Communication (NFC) symbol on the machine's control panel with a registered Integrated Circuit Card (IC Card).
2. Press  XXXX displayed at the top left of the screen.
3. Press [Register Card].
4. Touch a new IC Card to the NFC symbol.  
The new IC Card's number is then registered to the machine.
5. Press [OK].



### Related Information

- [Use Secure Function Lock 3.0](#)

## Register an External IC Card Reader

When you connect an external IC (Integrated Circuit) card reader, use Web Based Management to register the card reader. Your machine supports HID class driver supported external IC card readers.

1. Start your web browser.
2. Type "https://machine's IP address" in your browser's address bar (where "machine's IP address" is the machine's IP address).

For example:

https://192.168.1.2

3. If required, type the password in the **Login** field, and then click **Login**.



The default password to manage this machine's settings is located on the back of the machine and marked "Pwd".

4. Go to the navigation menu, and then click **Administrator** > **External Card Reader**.



Start from ≡, if the navigation menu is not shown on the left side of the screen.

5. Enter the necessary information, and then click **Submit**.
6. Restart your Brother machine to activate the configuration.
7. Connect the card reader to your machine.

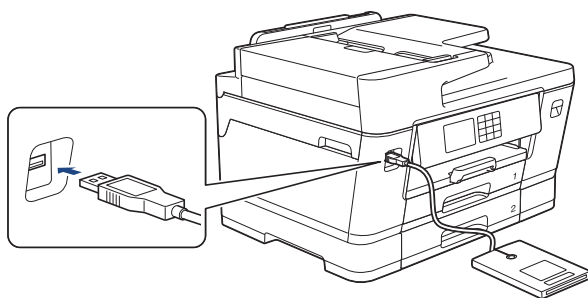

8. Touch the card to the card reader when using card authentication.



### Related Information

- [Use Secure Function Lock 3.0](#)

#### Related Topics:

- [Access Web Based Management](#)

## Send or Receive an Email Securely

- [Configure Email Sending or Receiving Using Web Based Management](#)
- [Send an Email with User Authentication](#)
- [Send or Receive an Email Securely Using SSL/TLS](#)

## Configure Email Sending or Receiving Using Web Based Management

We recommend using Web Based Management to configure secured email sending with user authentication, or email sending and receiving using SSL/TLS.

1. Start your web browser.
2. Type "https://machine's IP address" in your browser's address bar (where "machine's IP address" is the machine's IP address).  
For example:  
https://192.168.1.2
3. If required, type the password in the **Login** field, and then click **Login**.



The default password to manage this machine's settings is located on the back of the machine and marked "Pwd".

4. Go to the navigation menu, and then click **Network > Network > Protocol**.



Start from ☰, if the navigation menu is not shown on the left side of the screen.

5. In the **POP3/IMAP4/SMTP Client** field, click **Advanced Settings** and make sure the status of **POP3/IMAP4/SMTP Client** is **Enabled**.
6. Configure the **POP3/IMAP4/SMTP Client** settings.
  - Confirm that the email settings are correct after configuration by sending a test email.
  - If you do not know the POP3/IMAP4/SMTP server settings, contact your network administrator or Internet Service Provider (ISP).
7. When finished, click **Submit**.  
The **Test Send/Receive E-mail Configuration** dialog box appears.
8. Follow the instructions in the dialog box to test the current settings.



### Related Information

- [Send or Receive an Email Securely](#)

#### Related Topics:

- [Access Web Based Management](#)
- [Send or Receive an Email Securely Using SSL/TLS](#)

## Send an Email with User Authentication

Your machine supports the SMTP-AUTH method to send email via an email server that requires user authentication. This method prevents unauthorised users from accessing the email server.

You can use the SMTP-AUTH method for email notification, email reports and I-Fax.



---

We recommend using Web Based Management to configure the SMTP authentication.

---

### Email Server Settings

You must configure your machine's SMTP authentication method to match the method used by your email server. For details about your email server settings, contact your network administrator or Internet Service Provider (ISP).



---

To enable SMTP server authentication: in the Web Based Management **POP3/IMAP4/SMTP Client** screen, under **Server Authentication Method**, you must select **SMTP-AUTH**.

---



### Related Information

- [Send or Receive an Email Securely](#)
-

## Send or Receive an Email Securely Using SSL/TLS

Your Brother machine supports SSL/TLS communication methods. To use an email server that is using SSL/TLS communication, you must configure the following settings.



We recommend using Web Based Management to configure SSL/TLS.

### Verify Server Certificate

Under **SSL/TLS**, if you choose **SSL** or **TLS**, the **Verify Server Certificate** check box will be selected automatically.



- Before you verify the server certificate, you must import the CA certificate issued by the CA that signed the server certificate. Contact your network administrator or your Internet Service Provider (ISP) to confirm if importing a CA certificate is necessary.
- If you do not need to verify the server certificate, clear the **Verify Server Certificate** check box.

### Port Number

If you select **SSL**, or **TLS**, the **Port** value will be changed to match the protocol. To change the port number manually, type the port number after you select **SSL/TLS** settings.

You must configure your machine's communication method to match the method used by your email server. For details about your email server settings, contact your network administrator or your ISP.

In most cases, the secured webmail services require the following settings:

SMTP	<b>Port</b>	25
	<b>Server Authentication Method</b>	<b>SMTP-AUTH</b>
	<b>SSL/TLS</b>	<b>TLS</b>
POP3	<b>Port</b>	995
	<b>SSL/TLS</b>	<b>SSL</b>
IMAP4	<b>Port</b>	993
	<b>SSL/TLS</b>	<b>SSL</b>



### Related Information

- [Send or Receive an Email Securely](#)

#### Related Topics:

- [Configure Certificates for Device Security](#)
- [Configure Email Sending or Receiving Using Web Based Management](#)

## Administrator

- [Network Features](#)
- [Security Features](#)
- [Brother Management Tools](#)

## Network Features

- [Change Machine Settings Using Web Based Management](#)
- [Print the Network Configuration Report](#)
- [Synchronize Time with the SNTP Server Using Web Based Management](#)

## Security Features

Your machine uses some of the latest network security and encryption protocols. These network features can be integrated into your overall network security plan to help protect your data and prevent unauthorised access to the machine.

- [Network Security](#)
- [User Authentication](#)

## Network Security

- [Disable Unnecessary Protocols](#)
- [Configure Certificates for Device Security](#)
- [Use SSL/TLS](#)
- [Use SNMPv3](#)
- [Use IPsec](#)
- [Use IEEE 802.1x Authentication for a Wired or a Wireless Network](#)

## Disable Unnecessary Protocols

1. Start your web browser.
2. Type "https://machine's IP address" in your browser's address bar (where "machine's IP address" is the machine's IP address).

For example:

https://192.168.1.2

3. If required, type the password in the **Login** field, and then click **Login**.



---

The default password to manage this machine's settings is located on the back of the machine and marked "Pwd".

---

4. Go to the navigation menu, and then click **Network > Network > Protocol**.



---

Start from ☰, if the navigation menu is not shown on the left side of the screen.

---

5. Clear any unnecessary protocol check boxes to disable them.
6. Click **Submit**.
7. Restart your Brother machine to activate the configuration.



### Related Information

- [Network Security](#)

#### Related Topics:

- [Access Web Based Management](#)
-

## User Authentication

- [Use Active Directory Authentication](#)
- [Use LDAP Authentication](#)
- [Use Secure Function Lock 3.0](#)

## Brother Management Tools

Use one of Brother's management tools to configure your Brother machine's network settings.  
Go to your model's **Downloads** page at [support.brother.com](http://support.brother.com) to download the tools.



### Related Information

- [Administrator](#)
-

## Mobile/Web Connect

- [Brother Web Connect](#)
- [AirPrint](#)
- [Mopria® Print Service](#)
- [Brother Mobile Connect](#)
- [Print with Near-Field Communication \(NFC\)](#)

## Brother Web Connect

- [Brother Web Connect Overview](#)
- [Online Services Used with Brother Web Connect](#)
- [Set Up Brother Web Connect](#)
- [Scan and Upload Documents Using Brother Web Connect](#)
- [Upload a Document from an External Memory Device Using Brother Web Connect](#)
- [Download and Print Documents Using Brother Web Connect](#)
- [Download and Save a Document to an External Memory Device Using Brother Web Connect](#)
- [FaxForward to Cloud or E-mail](#)

## Brother Web Connect Overview

Certain websites provide services that allow users to upload and view images and files on the website. Your Brother machine can scan images and upload them to these services, and also download from and print images that are already uploaded to these services.

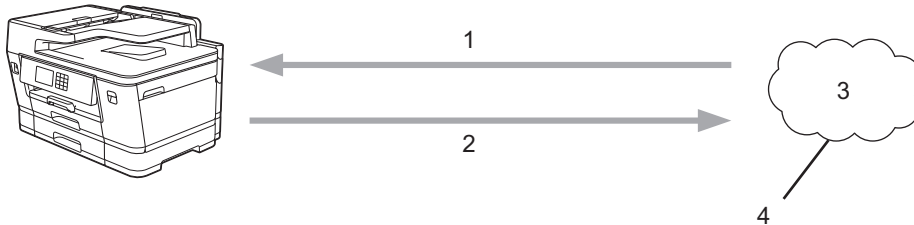



1. Printing
2. Scanning
3. Photos, images, documents and other files
4. Web Service

To use Brother Web Connect, your Brother machine must be connected to a network that has access to the Internet, through either a wired or wireless connection.

For network setups that use a proxy server, the machine must also be configured to use a proxy server. If you are unsure of your network configuration, check with your network administrator.



A proxy server is a computer that serves as an intermediary between computers without a direct Internet connection, and the Internet.

Press  (Web) or  (Apps) on the touchscreen to use Brother Web Connect.

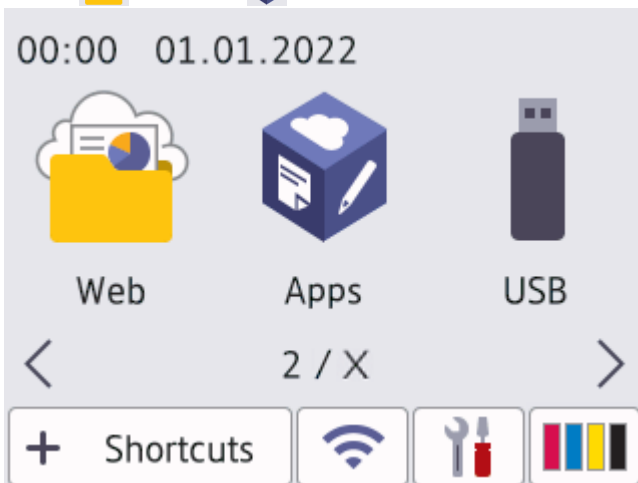



### ✓ Related Information

- [Brother Web Connect](#)
  - [Configure the Proxy Server Settings Using the Machine's Control Panel](#)
  - [Configure the Proxy Server Settings Using Web Based Management](#)

## Configure the Proxy Server Settings Using the Machine's Control Panel

If your network uses a proxy server, the following proxy server information must be configured on the machine:

- Proxy server address
- Port number
- User Name
- Password

1. Press  [Settings] > [All Settings] > [Network] > [Web Connect Settings] > [Proxy Settings] > [Proxy Connection].
2. Press [On].
3. Press the option that you want to set, and then enter the proxy server information.  
Press [OK].
4. Press .

### Related Information

- [Brother Web Connect Overview](#)

## Configure the Proxy Server Settings Using Web Based Management

If your network uses a proxy server, the following proxy server information must be configured using Web Based Management:

- Proxy server address
- Port number
- User Name
- Password



We recommend Microsoft Internet Explorer 11/Microsoft Edge for Windows, Safari 13 for Mac, Google Chrome™ for Android (4.x or later), and Google Chrome™/Safari for iOS (10.x or later). Make sure that JavaScript and Cookies are always enabled in whichever browser you use.

1. Start your web browser.
2. Type "https://machine's IP address" in your browser's address bar (where "machine's IP address" is the machine's IP address).

For example:

https://192.168.1.2

3. If required, type the password in the **Login** field, and then click **Login**.



The default password to manage this machine's settings is located on the back of the machine and marked "Pwd".

4. Go to the navigation menu, and then click **Network > Network > Protocol**.



Start from , if the navigation menu is not shown on the left side of the screen.

5. Make sure the **Proxy** check box is selected, and then click **Submit**.
6. In the **Proxy** field, click **Advanced Settings**.
7. Enter the proxy server information.
8. Click **Submit**.



### Related Information

- [Brother Web Connect Overview](#)

#### Related Topics:

- [Access Web Based Management](#)

## Online Services Used with Brother Web Connect

Use Brother Web Connect to access online services from your Brother machine. Some of these web services offer business versions.

To use Brother Web Connect, you must have an account with the online service you want to use. If you do not already have an account, use a computer to access the service's website and create an account.

You do not need to create an account to use Brother Creative Center. (Brother CreativeCenter is available only for some models.)

### Google Drive™

An online document storage, editing, sharing and file synchronisation service.

URL: [drive.google.com](http://drive.google.com)

### Evernote®

An online file storage and management service.

URL: [www.evernote.com](http://www.evernote.com)

### Dropbox

An online file storage, sharing and synchronisation service.

URL: [www.dropbox.com](http://www.dropbox.com)

### OneDrive

An online file storage, sharing and management service.

URL: <https://onedrive.live.com>

### Box

An online document editing and sharing service.

URL: [www.box.com](http://www.box.com)

### OneNote

An online document editing and sharing service.

URL: [www.onenote.com](http://www.onenote.com)

### Brother Creative Center

A website that offers various templates, such as greeting cards, brochures and calendars that you can print on your Brother machine. (available only for certain countries and models)

<https://www.creativecenter.brother/>

For more information about any of these services, refer to the respective service's website.

The following table describes which file types can be used with each Brother Web Connect feature:

Accessible Services	Google Drive™ Evernote® Dropbox OneDrive Box	OneNote	Brother Creative Center
Download and print images or save them to media	JPEG PDF DOCX XLSX PPTX	JPEG PDF DOCX XLSX PPTX	(Print only)
Upload scanned images	JPEG PDF	JPEG PDF	-

Accessible Services	Google Drive™ Evernote® Dropbox OneDrive Box	OneNote	Brother Creative Center
	DOCX XLSX PPTX TIFF	DOCX XLSX PPTX TIFF	
Upload images saved on media	JPG	-	-
FaxForward to the online services	JPEG PDF TIFF	JPEG PDF TIFF	-



- Not all services are available in all countries.
- For Hong Kong, Taiwan and Korea:  
Brother Web Connect supports only file names written in English. Files named in the local language will not be downloaded.



### Related Information

- [Brother Web Connect](#)

## Set Up Brother Web Connect

- [Brother Web Connect Setup Overview](#)
- [Create an Account for Each Online Service Before Using Brother Web Connect](#)
- [Apply for Brother Web Connect Access](#)
- [Register an Account on Your Brother Machine for Brother Web Connect](#)
- [Set Up Brother Web Connect for Brother CreativeCenter](#)

## Brother Web Connect Setup Overview

Configure the Brother Web Connect settings using the following procedure (when using Brother CreativeCenter, this procedure is not necessary):

### Step 1: Create an account with the service you want to use.

Access the service's website using a computer and create an account. (If you already have an account, there is no need to create an additional account.)

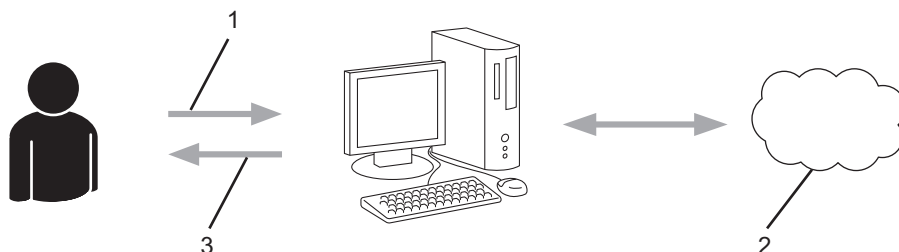

1. User registration
2. Web Service
3. Obtain account

### Step 2: Apply for Brother Web Connect access.

Start Brother Web Connect access using a computer and obtain a temporary ID.

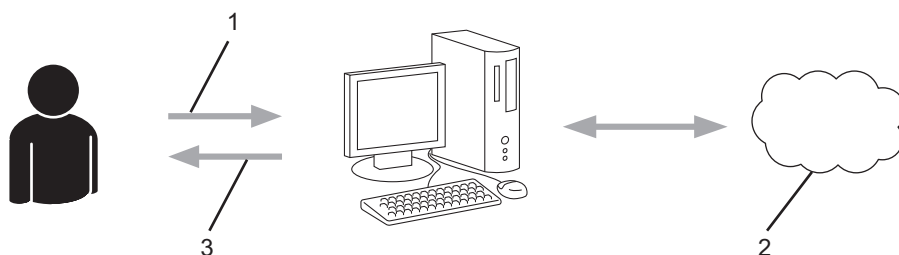

1. Enter account information
2. Brother Web Connect application page
3. Obtain temporary ID

### Step 3: Register your account information on your machine so you can access the service you want to use.

Enter the temporary ID to enable the service on your machine. Specify the account name as you would like it to be displayed on the machine, and enter a PIN if you would like to use one.

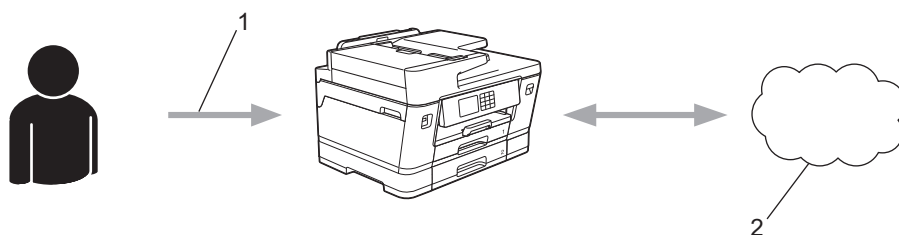

1. Enter temporary ID
2. Web Service

Your Brother machine can now use the service.



## Related Information

- [Set Up Brother Web Connect](#)

## Create an Account for Each Online Service Before Using Brother Web Connect

To use Brother Web Connect to access an online service, you must have an account with that online service. If you do not already have an account, use a computer to access the service's website and create an account. After creating an account, log on and use the account once with a computer before using the Brother Web Connect feature. Otherwise, you may not be able to access the service using Brother Web Connect.

If you already have an account, there is no need to create an additional account.

After you finish creating an account with the online service you want to use, apply for Brother Web Connect access.





### Related Information

- [Set Up Brother Web Connect](#)
-

## Apply for Brother Web Connect Access

To use Brother Web Connect to access online services, you must first apply for Brother Web Connect access using a computer that has the Brother Software installed.

1. Access the Brother Web Connect application website:

Option	Description
Windows	Launch  ( <b>Brother Utilities</b> ), and then click the drop-down list and select your model name (if not already selected). Click <b>Do More</b> in the left navigation bar, and then click <b>Brother Web Connect</b> .
	 You can also access the website directly: Type <a href="http://bwc.brother.com">bwc.brother.com</a> into your web browser's address bar.
Mac	Type <a href="http://bwc.brother.com">bwc.brother.com</a> into your web browser's address bar.

The Brother Web Connect page launches.

2. Select the service you want to use.
3. Follow the on-screen instructions and apply for access.

When finished, your temporary ID will appear.

Get connected with Brother Web Connect

**Finished the registration.**

Please enter the following temporary ID on the LCD screen of your machine.

**Temporary ID (11 digits)**

**XXX XXXX XXXX**

NOTE : The temporary ID will expire in 24 hours.

4. Make a note of your temporary ID, as you will need it to register accounts to the machine. The temporary ID is valid for 24 hours.
5. Close the web browser.

Now that you have a Brother Web Connect access ID, you must register this ID on your machine, and then use your machine to access the web service you want to use.



### Related Information

- [Set Up Brother Web Connect](#)

## Register an Account on Your Brother Machine for Brother Web Connect

You must enter your Brother Web Connect account information and configure your machine so that it can use Brother Web Connect to access the service you want.

- You must apply for Brother Web Connect access to register an account on your machine.
- Before you register an account, confirm that the correct date and time are set on the machine's control panel.

1. Press ◀ or ▶ to display [Web].

Press [Web].



- If information regarding the Internet connection appears on the machine's LCD, read the information and press [OK].
- Occasionally, updates or announcements about Brother Web Connect's features will appear on the LCD. Read the information, and then press [OK].

2. Press ▲ or ▼ to display the service with which you want to register.

Press the service name.

3. If information regarding Brother Web Connect appears, press [OK].

4. Press [Register/Delete] > [Register Account].

5. The machine will prompt you to enter the temporary ID you received when you applied for Brother Web Connect access.

Press [OK].

6. Enter the temporary ID using the LCD, and then press [OK].



An error message will appear on the LCD if the information you entered does not match the temporary ID you received when you applied for access, or if the temporary ID has expired. Either enter the temporary ID correctly, or apply for access again and receive a new temporary ID.

7. The machine will prompt you to enter the account name that you want to be displayed on the LCD.

Press [OK].

8. Enter the name using the LCD, and then press [OK].

9. Do one of the following:

- To set a PIN for the account, press [Yes]. (A PIN prevents unauthorised access to the account.) Enter a four-digit number, and then press [OK].
- If you do not want to set a PIN, press [No].



When the account information you entered appears, confirm that it is correct.

10. Press [Yes] to register your information as entered.

11. Press [OK].

Account registration is complete and your machine can now access the service.

12. Press .



### Related Information

- [Set Up Brother Web Connect](#)

## Set Up Brother Web Connect for Brother CreativeCenter

Brother Web Connect is set up to work with Brother CreativeCenter automatically. No configuration is needed to create the calendars, business cards, posters and greeting cards available at <https://www.creativecenter.brother/>.



Brother CreativeCenter is not available in all countries.



### Related Information

- [Set Up Brother Web Connect](#)
-

## Scan and Upload Documents Using Brother Web Connect

Upload your scanned photos and documents directly to a web service without using a computer.

- When scanning and uploading JPEG files or searchable PDF, monochrome scanning is not available.
- When scanning and uploading Microsoft Office files, monochrome scanning and grey scanning are not available.
- When scanning and uploading JPEG files, each page is uploaded as a separate file.
- Uploaded documents are saved in an album named **From\_BrotherDevice**.

For information regarding restrictions, such as the size or number of documents that can be uploaded, refer to the respective service's website.

If you are a restricted Web Connect user due to the Secure Function Lock feature (available for certain models), you cannot upload the scanned data.

1. Load your document.
2. Press ◀ or ▶ to display [Web].

Press [Web].



- You can also press [Scan] > [to Web].
- If information regarding the Internet connection appears on the machine's LCD, read the information and press [OK].
- Occasionally, updates or announcements about Brother Web Connect's features will appear on the LCD. Read the information, and then press [OK].

3. Press ▲ or ▼ to display the service that hosts the account to which you want to upload.  
Press the service name.
4. Press ▲ or ▼ to display your account name, and then press it.
5. If the PIN entry screen appears, enter the four-digit PIN and press [OK].
6. Press ▲ or ▼ to display [Upload: Scanner].

Press [Upload: Scanner].



If you pressed [Scan] > [to Web], this option does not appear.

7. Follow the on-screen instructions to complete this operation.



### Related Information

- [Brother Web Connect](#)

## Upload a Document from an External Memory Device Using Brother Web Connect

Documents saved on media (such as a USB flash drive) connected to the machine can be uploaded directly to a web service.

- Uploaded documents are saved in an album named **From\_BrotherDevice**.

For information regarding restrictions, such as the size or number of documents that can be uploaded, refer to the respective service's website.

If you are a restricted Web Connect user due to the Secure Function Lock feature (available for certain models), you cannot upload documents saved on media.

### IMPORTANT

DO NOT remove the USB flash drive while the message appears on the LCD. Otherwise, the USB flash drive, or data stored on the USB flash drive could be damaged.



(For Hong Kong, Taiwan and Korea)

Brother Web Connect supports only file names written in English. Files named in the local language will not be uploaded.

1. Insert a USB flash drive into your machine.  
The LCD automatically changes.
2. Press ▲ or ▼ to display the [Web] option, and then press it.



- If information regarding the Internet connection appears on the machine's LCD, read the information and press [OK].
- Occasionally, updates or announcements about Brother Web Connect's features will appear on the LCD. Read the information, and then press [OK].

3. Press ▲ or ▼ to display the service that hosts the account to which you want to upload.  
Press the service name.
4. Press ▲ or ▼ to display your account name, and then press it.
5. If the PIN entry screen appears, enter the four-digit PIN and press [OK].
6. Press ▲ or ▼ to display [Upload: Media].  
Press [Upload: Media].
7. Follow the on-screen instructions to complete this operation.



### Related Information

- [Brother Web Connect](#)

## Download and Print Documents Using Brother Web Connect

Documents that have been uploaded to your account can be downloaded directly to your machine and printed. Documents that other users have uploaded to their own accounts for sharing can also be downloaded to your machine and printed, as long as you have viewing privileges for those documents.

To download other users' documents, you must have access privileges to view the corresponding albums or documents.

If you are a restricted user for Web Connect due to the Secure Function Lock feature (available for certain models), you cannot download the data.

The Secure Function Lock Page Limit feature applies to the print job using Web Connect.



---

For Hong Kong, Taiwan and Korea:

Brother Web Connect supports only file names written in English. Files named in the local language will not be downloaded.

---



### Related Information

- [Brother Web Connect](#)
    - [Download and Print Using Web Services](#)
    - [Download and Print Brother CreativeCenter Templates](#)
-

## Download and Print Using Web Services

For information on Brother CreativeCenter Templates, see *Related Information*.

1. Press ◀ or ▶ to display [Web].

Press [Web].



- If information regarding the Internet connection appears on the machine's LCD, read the information and press [OK].
- Occasionally, updates or announcements about Brother Web Connect's features will appear on the LCD. Read the information, and then press [OK].

2. Press ▲ or ▼ to display the service that hosts the document you want to download and print.

Press the service name.

3. Press ▲ or ▼ to display your account name, and then press it. If the PIN entry screen appears, enter the four-digit PIN and press [OK].

4. Press ▲ or ▼ to display [Download: Print].

Press [Download: Print].

5. Press ▲ or ▼ to display the album you want, and then press it.



- An album is a collection of documents. However, the actual term may differ depending on the service you use. When using Evernote®, you must select the notebook, and then select the note.
- Some services do not require documents to be saved in albums. For documents not saved in albums, select [See Unsorted Files] to select documents.

6. Press the file name you want to print. Confirm the document on the LCD and press [OK]. Select additional documents to print (you can select up to 10 documents).

7. When finished, press [OK].

8. Follow the on-screen instructions to complete this operation.



### Related Information

- [Download and Print Documents Using Brother Web Connect](#)

#### Related Topics:

- [Download and Print Brother CreativeCenter Templates](#)

## Download and Print Brother CreativeCenter Templates

Brother CreativeCenter is not available in all countries.

1. Press ◀ or ▶ to display [Apps].

Press [Apps].



- If information regarding the Internet connection appears on the machine's LCD, read it, and then press [OK].
- Occasionally, updates or announcements about Brother Web Connect's features will appear on the LCD. Read the information, and then press [OK].

2. Press ▲ or ▼ to display [Print "CreativeCenter" Templates].

Press [Print "CreativeCenter" Templates].

3. Press ▲ or ▼ to display the desired category, and then press it.
4. Select the desired file. Enter the number of copies you want to print and then press [OK]. Repeat this step until you have selected all the files that you want to print.
5. When finished, press [OK].



If information regarding the recommended print settings appears on the machine's LCD, read the information and press [OK].

6. Follow the on-screen instructions to complete this operation.



### Related Information

- [Download and Print Documents Using Brother Web Connect](#)

#### Related Topics:

- [Download and Print Using Web Services](#)

## Download and Save a Document to an External Memory Device Using Brother Web Connect

JPEG, PDF and Microsoft Office files can be downloaded from a service and saved directly on media connected to the machine. Documents that other users have uploaded to their own accounts for sharing can also be downloaded to your machine as long as you have viewing privileges for those documents.

- Make sure there is enough available space on your USB flash drive.
- To download other users' documents, you must have access privileges to view the corresponding albums or documents.
- Downloaded files are renamed based on the current date. For example, the first image saved on July 1, would be named 07010001.jpg. Note that the region setting also determines the date format of the file name.
- Images are saved in the "BROTHER" folder, which can be found on the root level of the media.

### IMPORTANT

DO NOT remove the USB flash drive while the message appears on the LCD. Otherwise, the USB flash drive, or data stored on the USB flash drive could be damaged.

1. Insert a USB flash drive into your machine.  
The LCD automatically changes.
2. Press ▲ or ▼ to display the [Web] option, and then press it.



- If information regarding the Internet connection appears on the machine's LCD, read the information and press [OK].
- Occasionally, updates or announcements about Brother Web Connect's features will appear on the LCD. Read the information, and then press [OK].

3. Press ▲ or ▼ to display the service that hosts the document you want to download.  
Press the service name.
4. Press ▲ or ▼ to display your account name, and then press it. If the PIN entry screen appears, enter the four-digit PIN and press [OK].
5. Press ▲ or ▼ to display [Download: Media].  
Press [Download: Media].
6. Follow the on-screen instructions to complete this operation.



- An album is a collection of documents. However, the actual term may differ depending on the service you use. When using Evernote®, you must select the notebook, and then select the note.
- Some services do not require documents to be saved in albums. For documents not saved in albums, select [See Unsorted Files] to select documents.

### ✓ Related Information

- [Brother Web Connect](#)

## FaxForward to Cloud or E-mail

- Use the FaxForward to Cloud feature to automatically forward incoming faxes to your accounts with the available online services.

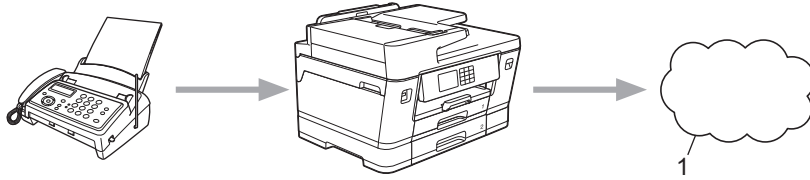

### 1. Web Service

- Use the FaxForward to E-mail feature to automatically forward incoming faxes to an inbox as email attachments.

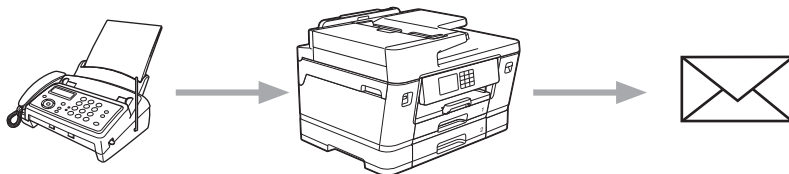

### Related Information

- [Brother Web Connect](#)
  - [Turn On FaxForward to Cloud or E-mail](#)
  - [Turn Off FaxForward to Cloud or E-mail](#)

## Turn On FaxForward to Cloud or E-mail

Turn on the FaxForward feature to automatically forward incoming faxes to either an online service or an inbox as email attachments.

- This feature is available only for monochrome faxes.
- If you turn on this feature, you cannot use the following features:
  - Memory Receive ([Fax Forward], [Fax Storage])
  - [PC Fax Receive]

1. Press ◀ or ▶ to display [Apps].

Press [Apps].



- If information regarding the Internet connection appears on the machine's LCD, read it, and then press [OK].
- Occasionally, updates or announcements about Brother Web Connect's features will appear on the LCD. Read the information, and then press [OK].

2. Press ▲ or ▼ to display [FaxForward to Cloud/E-mail].

Press [FaxForward to Cloud/E-mail].



If information regarding [FaxForward to Cloud/E-mail] appears, read it, and then press [OK].

3. Press [On].

4. Press [Forward to Cloud] or [Forward to E-mail].

- If you selected [Forward to Cloud], choose the online service you want to receive the faxes, and then specify your account name.
- If you selected [Forward to E-mail], select the email address you want to receive the faxes as email attachments.

5. Follow the on-screen instructions to complete this operation.



### Related Information

- [FaxForward to Cloud or E-mail](#)

#### Related Topics:

- [Memory Receive Options](#)

## Turn Off FaxForward to Cloud or E-mail

Turn off FaxForward when you want to stop incoming faxes from automatically going to either an online service or an inbox as email attachments.

If there are received faxes still in your machine's memory, you cannot turn off FaxForward.

1. Press ◀ or ▶ to display [Apps].

Press [Apps].



- If information regarding the Internet connection appears on the machine's LCD, read it, and then press [OK].
- Occasionally, updates or announcements about Brother Web Connect's features will appear on the LCD. Read the information, and then press [OK].

2. Press ▲ or ▼ to display [FaxForward to Cloud/E-mail].

Press [FaxForward to Cloud/E-mail].



If information regarding [FaxForward to Cloud/E-mail] appears, read it, and then press [OK].

3. Press [Off].

4. Press [OK].



### Related Information

- [FaxForward to Cloud or E-mail](#)

## AirPrint

- [AirPrint Overview](#)
- [Before Using AirPrint \(macOS\)](#)
- [Print Using AirPrint](#)
- [Scan Using AirPrint \(macOS\)](#)
- [Send a Fax Using AirPrint \(macOS\)](#)

## AirPrint Overview

AirPrint is a printing solution for Apple operating systems that allows you to wirelessly print photos, email, web pages and documents from your iPad, iPhone, iPod touch and Mac computer without the need to install a driver.

AirPrint also lets you send faxes directly from your Mac computer without printing them and lets you scan documents to your Mac computer.

For more information, visit Apple's website.

Use of the Works with Apple badge means that an accessory has been designed to work specifically with the technology identified in the badge and has been certified by the developer to meet Apple performance standards.



### Related Information

- [AirPrint](#)

## Before Using AirPrint (macOS)

Before printing using macOS, add your machine to the printer list on your Mac computer.

1. Select **System Preferences** from the Apple menu.
2. Click **Printers & Scanners**.
3. Click the + icon below the Printers pane on the left.  
The **Add** screen appears.
4. Select your machine, and then select **AirPrint** from the **Use** pop-up menu.
5. Click **Add**.



### Related Information



- [AirPrint](#)
-

## Print Using AirPrint

- [Print from iPad, iPhone, or iPod touch](#)
- [Print Using AirPrint \(macOS\)](#)

## Print from iPad, iPhone, or iPod touch

The procedure used to print may vary by application. Safari is used in the example below.

1. Make sure your machine is turned on.  
Make sure you have loaded the correct paper in the paper tray and change the paper settings for the paper tray on your machine.
2. Use Safari to open the page that you want to print.
3. Tap  or .
4. Tap **Print**.
5. Make sure your machine is selected.
6. If a different machine (or no printer) is selected, tap **Printer**.  
A list of available machines appears.
7. Tap your machine's name in the list.
8. Select the options you want, such as the number of pages to print and 2-sided printing (if supported by your machine).
9. Tap **Print**.



### Related Information

- [Print Using AirPrint](#)

## Print Using AirPrint (macOS)

The procedure used to print may vary by application. Safari is used in the example below. Before printing, make sure your machine is in the printer list on your Mac computer.

1. Make sure your machine is turned on.  
Make sure you have loaded the correct paper in the paper tray and change the paper settings for the paper tray on your machine.
2. On your Mac computer, use Safari to open the page that you want to print.
3. Click the **File** menu, and then select **Print**.
4. Make sure your machine is selected. If a different machine (or no printer) is selected, click the **Printer** pop-up menu, and then select your machine.
5. Select the desired options, such as the number of pages to print and 2-sided printing (if supported by your machine).
6. Click **Print**.



### Related Information

- [Print Using AirPrint](#)

#### Related Topics:

- [Before Using AirPrint \(macOS\)](#)

## Scan Using AirPrint (macOS)

Before scanning, make sure your machine is in the scanner list on your Mac computer.

1. Load your document.
2. Select **System Preferences** from the Apple menu.
3. Click **Printers & Scanners**.
4. Select your machine from the scanner list.
5. Click the **Scan** tab, and then click the **Open Scanner...** button.  
The Scanner screen appears.
6. If you place the document in the ADF, select **Use Document Feeder** check box, and then select the size of your document from the scan size setting pop-up menu.
7. Select the destination folder or destination application from the destination setting pop-up menu.
8. Click **Show Details** to change the scanning settings if needed.  
You can crop the image manually by dragging the mouse pointer over the portion you want to scan when scanning from the scanner glass.
9. Click **Scan**.



### Related Information

- [AirPrint](#)

#### Related Topics:

- [Before Using AirPrint \(macOS\)](#)

## Send a Fax Using AirPrint (macOS)

Make sure your machine is in the printer list on your Mac computer. Apple TextEdit is used in the example below.



- AirPrint supports only monochrome fax documents.
- Your machine supports the Secure Function Lock feature. Sending faxes via AirPrint is not available if Fax Tx for each user is restricted.

1. Make sure your machine is turned on.
2. On your Mac computer, open the file that you want to send as a fax.
3. Click the **File** menu, and then select **Print**.
4. Click the **Printer** pop-up menu, and then select **Brother XXX-XXXX - Fax** (where XXX-XXXX is the name of your model).
5. Type the fax recipient information.
6. Click **Fax**.



### Related Information

- [AirPrint](#)

#### Related Topics:

- [Before Using AirPrint \(macOS\)](#)

## Mopria® Print Service

Mopria® Print Service is a print feature on Android™ mobile devices developed by the Mopria® Alliance. With this service, you can connect to the same network as your machine and print without additional setup.

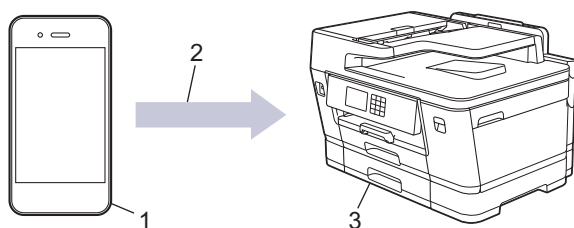

1. Android™ Mobile Device
2. Wi-Fi® Connection
3. Your Machine

You must download the Mopria® Print Service from the Google Play™ Store and install it on your Android™ device. Before using this service, you must turn it on.



### Related Information

- [Mobile/Web Connect](#)

## Brother Mobile Connect

Use Brother Mobile Connect to print and scan from your mobile device.

- For Android™ devices

Brother Mobile Connect allows you to use your Brother machine's features directly from your Android™ device.

Download and install Brother Mobile Connect from Google Play™.

- For all iOS or iPadOS supported devices including iPhone, iPad, and iPod touch

Brother Mobile Connect allows you to use your Brother machine's features directly from your iOS or iPadOS device.

Download and install Brother Mobile Connect from the App Store.



### Related Information

- [Mobile/Web Connect](#)
-

## Print with Near-Field Communication (NFC)

**Related Models:** MFC-J3940DW/MFC-J6940DW

Near-Field Communication (NFC) allows for simple transactions, data exchange, and wireless connections between two devices that are close to each other.

If your Android™ device is NFC-enabled, you can print data (photos, PDF files, and text files) from the device by touching it to the NFC symbol on the machine's control panel.

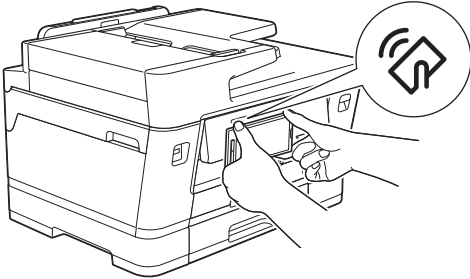

You must download and install Brother Mobile Connect to your Android™ device to use this feature.

### ✓ Related Information

- [Mobile/Web Connect](#)

#### Related Topics:

- [Control Panel Overview](#)

## Troubleshooting

If you think there is a problem with your machine, first check each of the items below, then try to identify the problem, and follow our troubleshooting tips.

You can correct most problems yourself. If you need additional help, visit [support.brother.com](http://support.brother.com) for the latest FAQs and troubleshooting tips:

1. Visit [support.brother.com](http://support.brother.com).
2. Click **FAQs & Troubleshooting** and search for your model name.

First, check the following:

- The machine's power cord is connected correctly and the machine's power is on.
- All of the machine's protective parts have been removed.
- The ink cartridges are installed correctly.
- The Scanner Cover and the Jam Clear Cover are fully closed.
- Paper is inserted correctly in the paper tray.
- The interface cables are securely connected to the machine and the computer, or the wireless connection is set up on both the machine and your computer.
- (For network models) The access point (for wireless), router, or hub is turned on and its link indicator is blinking.
- The machine's LCD is displaying messages.

If you did not solve the problem with the checks, identify the problem and then see *Related Information*.



### Related Information

- [Error and Maintenance Messages](#)
- [Document Jams](#)
- [Printer Jam or Paper Jam](#)
- [If You Are Having Difficulty with Your Machine](#)
- [Check the Machine Information](#)
- [Reset Your Machine](#)

#### Related Topics:

- [Paper Handling and Printing Problems](#)
- [Telephone and Fax Problems](#)
- [Other Problems](#)
- [Network Problems](#)
- [AirPrint Problems](#)

## Error and Maintenance Messages

As with any sophisticated office product, errors may occur and supply items may have to be replaced. If this happens, your machine identifies the error or required routine maintenance and shows the appropriate message. The most common error and maintenance messages are shown in the table.

You can correct most errors and perform routine maintenance yourself. If you need more tips, go to your model's **FAQs & Troubleshooting** page at [support.brother.com](http://support.brother.com).



- (MFC-J3940DW/MFC-J6940DW)

If the touchscreen displays errors and your Android™ device supports the NFC feature, touch your device to the NFC symbol on the control panel and browse the latest FAQs from your device. (Your mobile telephone provider's message and data rates may apply.)

Make sure the NFC settings of both your Brother machine and your Android™ device are set to On.

- *Related Information* references are at the bottom of this page.

Error Message	Cause	Action
B&W Print Only	<p>One or more of the colour ink cartridges have reached the end of their lives.</p> <p>You can use the machine in monochrome mode for approximately four weeks depending on the number of pages you print.</p> <p>While this message appears on the LCD, each operation works in the following way:</p> <ul style="list-style-type: none"> <li>• <b>Printing</b> If the media type is set to <b>Plain Paper</b> and you selected <b>Greyscale</b> in the printer driver, you can use the machine as a monochrome printer.</li> <li>• <b>Copying</b> If the paper type is set to <b>Plain Paper</b>, you can make copies in monochrome.</li> <li>• <b>Faxing</b> If the paper type is set to <b>Plain Paper</b>, the machine will receive and print the faxes in monochrome.</li> </ul>	<p>Replace the ink cartridges.</p> <p>See <i>Related Information: Replace the Ink Cartridges</i>.</p> <p>Although the Cause column lists options for using the machine after this error appears, you may not be able to use the machine until you replace one or more of the ink cartridges under the following condition:</p> <ul style="list-style-type: none"> <li>• If you unplug the machine or remove the ink cartridge.</li> </ul>
<p>Cannot Clean XX</p> <p>Cannot Initialise XX</p> <p>Cannot Print XX</p>	<p>The machine has a mechanical problem.</p> <p><b>-OR-</b></p> <p>A foreign object, such as a paper clip or a piece of ripped paper, is in the machine.</p>	<p>Open the scanner cover and remove any foreign objects and paper scraps from inside the machine. If the error message continues, disconnect the machine from the power for several minutes, and then reconnect it.</p> <p>You can try additional clear paper jam operations.</p> <p>See <i>Related Information: Remove Paper Scraps</i>.</p> <p>(If you cannot print documents and received faxes, transfer them to another fax machine or to your computer.)</p> <p>See <i>Related Information: Transfer Your Faxes or Fax Journal Report</i>.</p>
Cannot Detect	You installed a new ink cartridge too quickly and the machine did not detect it.	Take out the new ink cartridge and reinstall it slowly and firmly until it locks into place.

Error Message	Cause	Action
	An ink cartridge is not installed correctly.	See <i>Related Information: Replace the Ink Cartridges</i> .
	If you are using non Brother Original ink, the machine may not detect the ink cartridge.	Replace the ink cartridge with a Brother Original ink cartridge. If the error message remains, contact Brother customer service or your local Brother dealer.
	The wrong Brother model ink cartridge was installed.	Check the model numbers of the ink cartridges and install the correct ink cartridges.
Cannot Detect Ink Volume	If you are using non Brother Original ink, the machine may not detect the ink volume.	Replace the ink cartridge with a Brother Original ink cartridge. If the error message remains, contact Brother customer service or your local Brother dealer.
Cannot Scan XX	The machine has a mechanical problem.	Disconnect the machine from the power for several minutes, and then reconnect it. (If you cannot print documents and received faxes, transfer them to another fax machine or to your computer.) See <i>Related Information: Transfer Your Faxes or Fax Journal Report</i> .
Comm.Error	Poor telephone line quality caused a communication error.	Send the fax again or connect the machine to another telephone line. If the problem continues, contact the telephone company and ask them to check your telephone line.
Connection Error	Other devices are trying to connect to the Wi-Fi Direct network at the same time.	Make sure there are no other devices trying to connect to the Wi-Fi Direct network, and then try to configure the Wi-Fi Direct settings again.
Connection Failed	The Brother machine and your mobile device cannot communicate during the Wi-Fi Direct network configuration.	<ul style="list-style-type: none"> <li>Move the mobile device closer to your Brother machine.</li> <li>Move your Brother machine and the mobile device to an obstruction-free area.</li> <li>If you are using the PIN Method of WPS, make sure you have entered the correct PIN.</li> </ul>
Cover is Open.	The scanner cover is not locked in the closed position.	Lift the scanner cover and then close it again.
		Make sure the telephone line cord and interface cable (if used) have been guided correctly through the cable channel and out the back of the machine.
	The ink cartridge cover is not locked in the closed position.	Firmly close the ink cartridge cover until it locks into place.
Data Remaining in Memory	Print data is left in the machine's memory.	Press  . The machine will cancel the job and clear it from the memory. Try to print again.
Disconnected	The other person or other person's fax machine stopped the call.	Try to send or receive again. If calls are stopped repeatedly and you are using a VoIP (Voice over IP) system, try changing the Compatibility to Basic (for VoIP). See <i>Related Information: Telephone Line Interference/VoIP</i> .

Error Message	Cause	Action
Document Jam/too Long	The document was not inserted or fed correctly, or the document scanned from the ADF was too long.	Remove the jammed document, and then press  . Set the document in the ADF correctly. <i>See Related Information: Load Documents in the Automatic Document Feeder (ADF).</i> <i>See Related Information: Document Jams.</i>
DR Mode in Use	The machine is in Distinctive Ring mode. You cannot change the Receive Mode from Manual to another mode.	Set Distinctive Ring to Off. <i>See Related Information: Turn off Distinctive Ring.</i>
FaxAbility On	The machine is in FaxAbility mode. You cannot change the Receive Mode from Manual to another mode.	Set FaxAbility to Off. <i>See Related Information: Turn FaxAbility Off or On.</i>
High Temperature	The room temperature is too high.	After cooling the room, allow the machine to cool down to room temperature. Try again when the machine has cooled down.
Hub is Unusable.	A hub or USB flash drive with hub has been connected to the USB direct interface.	Hubs, including a USB flash drive with a built-in hub, are not supported. Unplug the device from the USB direct interface.
Ink Absorber NearFull	The ink absorber box is nearly full.	The ink absorber box must be replaced soon. Contact Brother customer service or your local Brother dealer.
Ink Absorber Pad Full	The ink absorber box is full. These components are periodic maintenance items that may require replacement after a period of time to ensure optimum performance from your Brother machine. Because these components are periodic maintenance items, the replacement is not covered under the warranty. The need to replace these items and the time period before replacement is dependent on the number of purges and flushes required to clean the ink system. These boxes acquire amounts of ink during the different purging and flushing operations. The number of times a machine purges and flushes for cleaning varies depending on different situations. For example, frequently powering the machine on and off will cause numerous cleaning cycles since the machine automatically cleans upon power up. The use of non-Brother ink may cause frequent cleanings because non-Brother ink could cause poor print quality which is resolved by cleaning. The more cleaning the machine requires, the faster these boxes will fill up. <b>Repairs resulting from the use of non-Brother supplies may not be covered under the stated product warranty.</b>	The ink absorber box must be replaced. Contact Brother customer service or your local Brother Authorised Service Centre to have your machine serviced. The machine cleans itself after: <ul style="list-style-type: none"> <li>You remove the power cord and plug it back in.</li> <li>A paper jam has been cleared.</li> <li>Sitting idle for more than 30 days (infrequent use).</li> <li>Ink cartridges of the same colour have been replaced 12 times.</li> </ul>
Ink Low	The ink level is low. If the sending machine has the ability to convert it, the colour fax will be printed at your machine as a monochrome fax.	Prepare a new ink cartridge. You can continue printing until the touchscreen displays <i>Replace Ink</i> . <i>See Related Information: Replace the Ink Cartridges.</i>

Error Message	Cause	Action
		<ul style="list-style-type: none"> <li>You can still scan even if the ink is low or needs to be replaced.</li> </ul>
Install Ink	An ink cartridge is not installed correctly.	Remove the ink cartridge and re-install it slowly and firmly until it locks into place. See <i>Related Information: Replace the Ink Cartridges.</i>
Jam Front/Rear Jam Front Jam Rear Jam MP Tray Jam Manual Feed Slot Jam Front/MP Tray Jam Front/Manual Feed Slot Jam Tray2 Jam Tray3 Repeat Jam XX	The paper is jammed in the machine.	Gently remove the jammed paper. See <i>Related Information: Printer Jam or Paper Jam.</i>
	If there is a repeat paper jam, try another paper jam clear operation. See <i>Related Information: Remove Paper Scraps.</i>	
	The paper guides are not set to the correct paper size.	Make sure the paper guides are set to the correct paper size.
	The machine's paper support is not set correctly.	Make sure the paper support is fully inserted into the machine. See <i>Related Information: Paper is Jammed in the Front of the Machine.</i>
	More than one sheet of paper was placed in the manual feed slot. <b>-OR-</b> Another sheet of paper was placed in the manual feed slot before the touchscreen prompted you to load another sheet of paper.	Do not put more than one sheet of paper in the manual feed slot at any one time. Wait until the touchscreen prompts you to load another sheet of paper before you feed the next sheet of paper in the manual feed slot. Gently remove the jammed paper. See <i>Related Information: Printer Jam or Paper Jam.</i>
	Paper dust has accumulated on the surface of the paper pick-up rollers.	Clean the paper pick-up rollers. See <i>Related Information: Clean the Paper Pick-up Rollers for Paper Tray #1 or Clean the Paper Pick-up Rollers for Paper Tray #2 and Paper Tray #3.</i>
Low Temperature	The room temperature is too low.	After warming the room, allow the machine to warm up to room temperature. Try again when the machine has warmed up.
Media is Full.	The USB flash drive you are using does not have enough free space to scan the document.	Delete unused files from your USB flash drive to free some space, and then try again.
No Caller ID	There is no incoming call history. You did not receive calls or you have not subscribed to the Caller ID service from your telephone company.	To use the Caller ID feature, contact your telephone company. See <i>Related Information: Caller ID.</i>
No Device	When configuring the Wi-Fi Direct network, the Brother machine cannot find your mobile device.	<ul style="list-style-type: none"> <li>Make sure your machine and mobile device are in the Wi-Fi Direct mode.</li> <li>Move the mobile device closer to your Brother machine.</li> <li>Move your Brother machine and the mobile device to an obstruction-free area.</li> <li>If you are manually configuring the Wi-Fi Direct network, make sure you have entered the correct password.</li> </ul>

Error Message	Cause	Action
		<ul style="list-style-type: none"> <li>If your mobile device has a configuration page for how to obtain an IP address, make sure the IP address of your mobile device has been configured via DHCP.</li> </ul>
No File	The USB flash drive in the media drive does not contain a .JPG file.	Reinsert the correct USB flash drive in the slot.
No Paper Fed	The machine is out of paper or paper is not correctly loaded in the paper tray.	Do one of the following: <ul style="list-style-type: none"> <li>Refill the paper tray, and then follow the LCD instructions.</li> <li>Remove and reload the paper, and then follow the LCD instructions.</li> </ul> <i>See Related Information: Load Paper.</i>
	The paper was not inserted in the centre position of the manual feed slot. The paper was not inserted in the centre position of the MP tray.	Remove the paper and reinsert it in the centre of the manual feed slot, and then follow the LCD instructions. Remove the paper and reinsert it in the centre of the MP tray, and then follow the LCD instructions. <i>See Related Information: Load Paper in the Manual Feed Slot.</i> <i>See Related Information: Load Paper in the Multi-purpose Tray (MP Tray).</i>
	The Jam Clear Cover is not closed correctly.	Make sure the Jam Clear Cover is closed evenly at both ends. <i>See Related Information: Printer Jam or Paper Jam.</i>
	Paper dust has accumulated on the surface of the paper pick-up rollers.	Clean the paper pick-up rollers. <i>See Related Information: Clean the Paper Pick-up Rollers for Paper Tray #1 or Clean the Paper Pick-up Rollers for Paper Tray #2 and Paper Tray #3.</i>
No Response	The connected USB device is unresponsive.	Unplug the device from the USB direct interface.
No Response/Busy	The number you dialled does not answer or is busy.	Verify the number and try again.
Out of Fax Memory	The fax memory is full.	Do one of the following: <ul style="list-style-type: none"> <li>Clear the data from the memory. To gain extra memory, you can turn off Memory Receive. <i>See Related Information: Turn Off Memory Receive.</i></li> <li>Print the faxes that are in the memory. <i>See Related Information: Print a Fax Stored in the Machine's Memory.</i></li> </ul>
Out of Memory	The machine's memory is full.	<b>If a fax-sending or copy operation is in progress:</b> <ul style="list-style-type: none"> <li>Press  or Quit and wait until the other operations that are in progress finish, and then try again.</li> <li>Press Partial Print to copy the pages scanned so far.</li> </ul>

Error Message	Cause	Action
		<ul style="list-style-type: none"> <li>• Clear the data stored in the memory. To gain extra memory, you can turn Memory Receive off. <i>See Related Information: Turn Off Memory Receive.</i></li> <li>• Print the faxes stored in the memory. <i>See Related Information: Print a Fax Stored in the Machine's Memory.</i></li> </ul>
Paper Low Tray 1 Paper Low Tray 2 Paper Low Tray 3	The paper tray is nearly empty.	Refill the paper in the paper tray indicated on the LCD.
Paper Size Mismatch	<p>The paper size setting does not match the size of paper in the tray.</p> <p><b>-OR-</b></p> <p>The paper orientation is not correct for the paper size.</p> <p><b>-OR-</b></p> <p>You did not set the paper guides in the tray to the indicators for the paper size you are using.</p>	<ol style="list-style-type: none"> <li>1. Check that the paper size you selected on the machine's display matches the size of the paper in the tray. <i>See Related Information: Change the Paper Size and Paper Type.</i></li> <li>2. Make sure you loaded the paper in the correct orientation and set the paper guides at the indicators for your paper size. <i>See Related Information: Load Paper.</i></li> <li>3. After you have checked the paper size and the paper orientation, follow the LCD instructions.</li> </ol> <p>If you are printing from your computer, make sure the paper size you selected in the printer driver or in the application you use to print matches the size of paper in the tray. <i>See Related Information: Print Settings (Windows).</i></p>
Paper Tray not detected Paper Tray 1 not detected Paper Tray 2 not detected Paper Tray 3 not detected	<p>The paper tray is not completely inserted.</p> <p>Paper or a foreign object has prevented the paper tray from being inserted correctly.</p>	<p>Slowly push the paper tray completely into the machine.</p> <p>Pull the paper tray out of the machine, and remove the jammed paper or foreign object. If you cannot find or remove the jammed paper, see <i>Related Information: Printer Jam or Paper Jam.</i></p>
Repetitive No Paper Fed	<p>The machine is out of paper or paper is not correctly loaded in the paper tray.</p> <p>Paper dust has accumulated on the surface of the paper pick-up rollers.</p>	<p>Do one of the following:</p> <ul style="list-style-type: none"> <li>• Refill the paper tray, and then follow the LCD instructions.</li> <li>• Remove and reload the paper, and then follow the LCD instructions.</li> </ul> <p><i>See Related Information: Load Paper.</i></p> <p>Clean the paper pick-up rollers. <i>See Related Information: Clean the Paper Pick-up Rollers for Paper Tray #1 or Clean the Paper Pick-up Rollers for Paper Tray #2 and Paper Tray #3.</i></p>
Repetitive Paper Jams	A foreign object, such as a paper clip or a piece of ripped paper, is in the machine.	<p>Remove any foreign objects and paper scraps in the machine.</p> <p><i>See Related Information: Remove Paper Scraps.</i></p>

Error Message	Cause	Action
Replace Ink	One or more of the ink cartridges have reached the end of their lives. The machine will stop all print operations. While memory is available, monochrome faxes will be stored in the memory. If the sending machine has the ability to convert it, the colour fax will be stored in the memory as a monochrome fax.	Replace the ink cartridges. <i>See Related Information: Replace the Ink Cartridges.</i> <ul style="list-style-type: none"> <li><b>You can still scan even if the ink is low or needs to be replaced.</b></li> </ul>
Sending Error Wrong Document Size Settings	The document size option does not match the size of your fax document.	Select the correct document size option, and then press <b>Fax Start</b> again.
The maximum number of devices are already connected using Wi-Fi Direct.	The maximum number of mobile devices are already connected to the Wi-Fi Direct network when the Brother machine is the Group Owner.	After the current connection between your Brother machine and another mobile device has shut down, try to configure the Wi-Fi Direct settings again. You can confirm the connection status by printing the Network Configuration Report. <i>See Related Information: Print the Network Configuration Report.</i>
Touchscreen Init. Failed	The touchscreen was pressed before the power on initialisation was completed.	Make sure nothing is touching or resting on the touchscreen, especially when plugging the machine in.
	Debris may be stuck between the lower part of the touchscreen and its frame.	Insert a piece of stiff paper between the lower part of the touchscreen and its frame and slide it back and forth to push out the debris.
Tray Settings Tray 1 Settings Tray 2 Settings Tray 3 Settings MP Tray Settings	This message is displayed when the setting to confirm the paper type and size is enabled.	To not display this confirmation message, change the setting to Off. <i>See Related Information: Change the Check Paper Setting.</i>
Unusable Device Disconnect device from front connector & turn machine off & then on	A broken device is connected to the USB direct interface.	Unplug the device from the USB direct interface. Turn the machine off and then on again.
Unusable Device Please disconnect USB device.	A USB device or USB flash drive that is not supported has been connected to the USB direct interface.	Unplug the device from the USB direct interface.
Wrong Ink Cartridge	The ink cartridge model number is not compatible with your machine.	Verify whether the cartridge model number will work with your machine.
Wrong Ink Colour	An ink cartridge has been installed in the wrong position.	Check which ink cartridges are not matched by colour to their ink cartridge positions and move them to their correct positions.
Wrong Tray Settings	The machine's paper size settings and tray select settings do not match the size of paper in the tray you are using.	Follow the instructions on the touchscreen and try to print again.
		Configure the paper size setting for the tray according to the LCD instructions.



## Related Information

- [Troubleshooting](#)
  - [Transfer Your Faxes or Fax Journal Report](#)

- 
- [Error Messages When Using the Brother Web Connect Feature](#)

**Related Topics:**

- [Touchscreen LCD Overview](#)
  - [Print the Network Configuration Report](#)
  - [Replace the Ink Cartridges](#)
  - [Telephone Line Interference/VoIP](#)
  - [Load Documents in the Automatic Document Feeder \(ADF\)](#)
  - [Document Jams](#)
  - [Turn FaxAbility Off or On](#)
  - [Turn off Distinctive Ring](#)
  - [Caller ID](#)
  - [Load Paper](#)
  - [Load Paper in the Manual Feed Slot](#)
  - [Printer Jam or Paper Jam](#)
  - [Remove Paper Scraps](#)
  - [Clean the Paper Pick-up Rollers for Paper Tray #1](#)
  - [Clean the Paper Pick-up Rollers for Paper Tray #2 and Paper Tray #3](#)
  - [Turn Off Memory Receive](#)
  - [Print a Fax Stored in the Machine's Memory](#)
  - [Print Settings \(Windows\)](#)
  - [Paper Handling and Printing Problems](#)
  - [Change the Check Paper Setting](#)
  - [Load Paper in the Multi-purpose Tray \(MP Tray\)](#)
  - [Paper is Jammed in the Front of the Machine](#)
  - [Change the Paper Size and Paper Type](#)
-

## Transfer Your Faxes or Fax Journal Report

If the LCD shows:

- [Cannot Clean XX]
- [Cannot Initialise XX]
- [Cannot Print XX]
- [Cannot Scan XX]

We recommend transferring your faxes to another fax machine or to your computer.

See *Related Information: Transfer Faxes to Another Fax Machine*.

See *Related Information: Transfer Faxes to Your Computer*.

You can also transfer the Fax Journal report to see if there are any faxes you must transfer.

See *Related Information: Transfer the Fax Journal Report to Another Fax Machine*.

### ✓ Related Information



- [Error and Maintenance Messages](#)
  - [Transfer Faxes to Another Fax Machine](#)
  - [Transfer Faxes to Your Computer](#)
  - [Transfer the Fax Journal Report to Another Fax Machine](#)

#### Related Topics:

- [Use PC-Fax Receive to Transfer Received Faxes to Your Computer \(Windows only\)](#)
- [Reset the Network Settings to Factory Default](#)
- [Reset Your Machine](#)
- [Reset Functions Overview](#)
- [Paper is Jammed in the Front of the Machine](#)
- [Paper is Jammed in the Back of the Machine](#)

## Transfer Faxes to Another Fax Machine

If you have not set up your Station ID, you cannot enter Fax Transfer mode.

1. Press  to clear the error temporarily.
2. Press  [Settings] > [All Settings] > [Service] > [Data Transfer] > [Fax Transfer].
3. Do one of the following:
  - If the touchscreen displays [No Data], there are no faxes left in the machine's memory.  
Press [Close], and then press .
  - Enter the fax number where faxes will be forwarded.
4. Press [Fax Start].



### Related Information



- [Transfer Your Faxes or Fax Journal Report](#)

#### Related Topics:

- [Set Your Station ID](#)

## Transfer Faxes to Your Computer

You can transfer the faxes from your machine's memory to your computer.

1. Press  to clear the error temporarily.
2. Make sure you have installed the Brother software and drivers on your computer, and then turn on **PC-FAX Receive** on the computer.
3. Launch  (**Brother Utilities**), and then click the drop-down list and select your model name (if not already selected).
4. Click **PC-FAX** in the left navigation bar, and then click **Receive**.
5. Read and confirm the instructions on your computer.

Faxes in the machine's memory will be sent to your computer automatically.



---

### When faxes in the machine's memory are not sent to your computer:

Make sure you have set [PC Fax Receive] on the machine.

If faxes are in the machine's memory when you set up PC-Fax Receive, the touchscreen prompts you to transfer the faxes to your computer.

If Fax Preview is set to Off, you will be asked if you want to print backup copies.

Press [Yes] to transfer all faxes in the memory to your computer.

---



### Related Information



- [Transfer Your Faxes or Fax Journal Report](#)

#### Related Topics:

- [Use PC-Fax Receive to Transfer Received Faxes to Your Computer \(Windows only\)](#)
-

## Transfer the Fax Journal Report to Another Fax Machine

If you have not set up your Station ID, you cannot enter fax transfer mode.

1. Press  to clear the error temporarily.
2. Press  [Settings] > [All Settings] > [Service] > [Data Transfer] > [Report Transfer].
3. Enter the fax number where the Fax Journal report will be forwarded.
4. Press [Fax Start].

### Related Information

- [Transfer Your Faxes or Fax Journal Report](#)

#### Related Topics:

- [Set Your Station ID](#)

## Error Messages When Using the Brother Web Connect Feature

Your Brother machine displays an error message if an error occurs. The most common error messages are shown in the chart.

You can correct most errors yourself. If you need more tips, go to your model's **FAQs & Troubleshooting** page at [support.brother.com](http://support.brother.com).

### Connection Error

Error Messages	Cause	Action
Connection Error 02	The machine is not connected to a network.	<ul style="list-style-type: none"> <li>Verify that the network connection is good.</li> <li>If the <b>Web</b> or <b>Apps</b> option was pressed soon after the machine was turned on, the network connection may not have been established yet. Wait and try again.</li> </ul>
Connection Error 03	<ul style="list-style-type: none"> <li>Network or server settings are incorrect.</li> <li>There is a problem with the network or server.</li> </ul>	<ul style="list-style-type: none"> <li>Confirm that network settings are correct, or wait and try again later.</li> <li>If the <b>Web</b> or <b>Apps</b> option was pressed soon after the machine was turned on, the network connection may not have been established yet. Wait and try again.</li> </ul>
Connection Error 07	Date and time settings are incorrect.	Set the date and time correctly. Note that if the machine's power cord is disconnected, the date and time settings may have reset to factory settings.

### Authentication Error

Error Messages	Cause	Action
Authentication Error 01	The PIN you entered to access the account is incorrect. The PIN is the four-digit number that was entered when registering the account to the machine.	Enter the correct PIN.
Authentication Error 02	The temporary ID that was entered is incorrect.	Enter the correct temporary ID.
	The temporary ID that was entered has expired. A temporary ID is valid for 24 hours.	Apply for Brother Web Connect access again and receive a new temporary ID, and then use the new ID to register the account to the machine.
Authentication Error 03	The name you entered as the display name has already been registered to another service user.	Enter a different display name.

---

## Server Error

Error Messages	Cause	Action
Server Error 01	The machine's authentication information (needed to access the service) has expired or is invalid.	Apply for Brother Web Connect access again to receive a new temporary ID, and then use the new ID to register the account to the machine.
Server Error 03	The file you are trying to upload may have one of the following problems: <ul style="list-style-type: none"><li>• The file exceeds the service's limit on number of pixels, file size, etc.</li><li>• The file type is not supported.</li><li>• The file is corrupted.</li></ul>	The file cannot be used: <ul style="list-style-type: none"><li>• Check the service's size or format restrictions.</li><li>• Save the file as a different type.</li><li>• If possible, get a new, uncorrupted version of the file.</li></ul>
Server Error 13	There is a problem with the service and it cannot be used now.	Wait and try again. If you get the message again, access the service from a computer to confirm if it is unavailable.

## Shortcut Error

Error Messages	Cause	Action
Shortcut Error 02	The shortcut cannot be used because the account was deleted after the shortcut was registered.	Delete the shortcut, and then register the account and shortcut again.



### Related Information

- [Error and Maintenance Messages](#)
-

## Document Jams

- [Document is Jammed in the Top of the ADF Unit](#)
- [Document is Jammed in the Bottom of the ADF Unit](#)
- [Document is Jammed inside the ADF Unit](#)
- [Remove Paper Scraps Jammed in the ADF](#)
- [Error and Maintenance Messages](#)

## Document is Jammed in the Top of the ADF Unit

1. Remove any paper from the ADF that is not jammed.
2. Open the ADF cover.
3. Remove the jammed document by pulling it upwards.

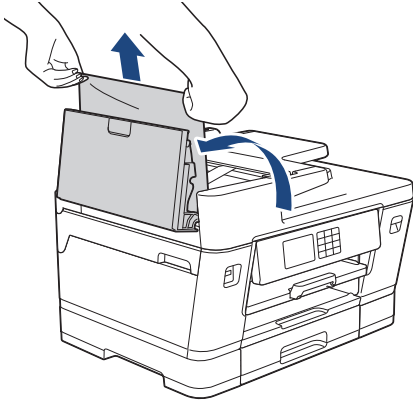

4. Close the ADF cover.
5. Press .

### IMPORTANT

To avoid future document jams, close the ADF cover correctly by pressing it down in the centre.

### Related Information

- [Document Jams](#)

## Document is Jammed in the Bottom of the ADF Unit

1. Remove any paper from the ADF that is not jammed.
2. Lift the ADF document support, and remove the jammed paper.

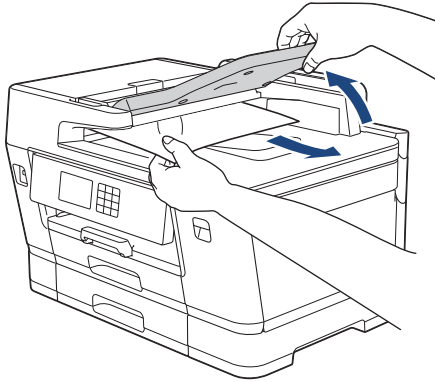

3. Press .





### Related Information

- [Document Jams](#)

## Document is Jammed inside the ADF Unit

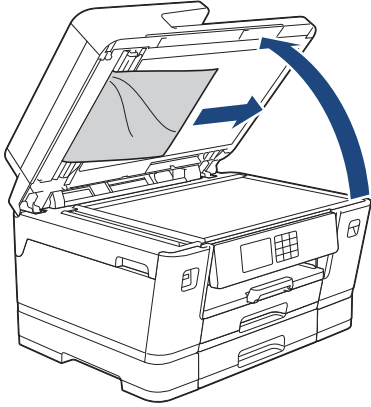
1. Remove any paper from the ADF that is not jammed.
2. Lift the document cover.
3. Pull the jammed document out to the right.



4. Close the document cover.
5. Press .





### Related Information

- [Document Jams](#)

## Remove Paper Scraps Jammed in the ADF

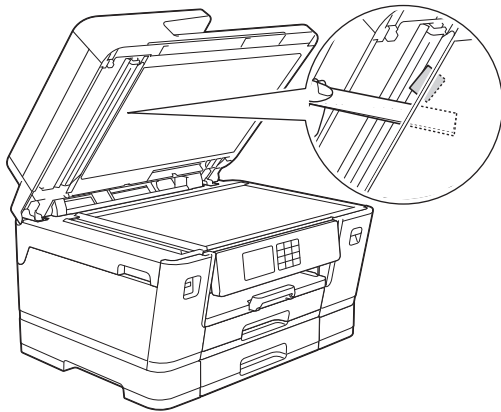
1. Lift the document cover.
2. Insert a piece of stiff paper, such as cardstock, into the ADF to push any small paper scraps through.



3. Close the document cover.
4. Press .



### Related Information

- [Document Jams](#)

## Printer Jam or Paper Jam

Locate and remove the jammed paper.

- [Paper is Jammed in the Front of the Machine](#)
- [Paper is Jammed in the Back of the Machine](#)
- [Remove Paper Scraps](#)
- [Error and Maintenance Messages](#)
- [Paper Handling and Printing Problems](#)

## Paper is Jammed in the Front of the Machine

If the LCD displays the following paper jam messages, follow these steps:

- [Jam Front/Rear], [Repeat Jam Front/Rear]
  - [Jam Front], [Repeat Jam Front]
  - [Jam Front/MP Tray], [Repeat Jam Front/MP Tray]
  - [Jam Front/Manual Feed Slot], [Repeat Jam Front/Manual Feed]
1. Unplug the machine from the electrical socket.
  2. If the paper is loaded in the MP tray, remove the paper. (MFC-J3940DW/MFC-J6555DW/MFC-J6940DW/MFC-J6955DW/MFC-J6957DW)
  3. Pull Tray #1 (1) completely out of the machine as shown by the arrow.

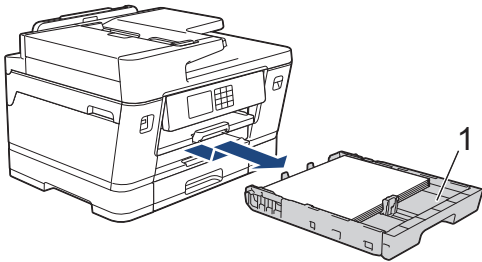

 If your LCD displays repeat paper jam messages, for example [Repeat Jam Front/Rear], lift the paper support (1), and then pull it at an angle completely out of the machine as shown by the arrow.

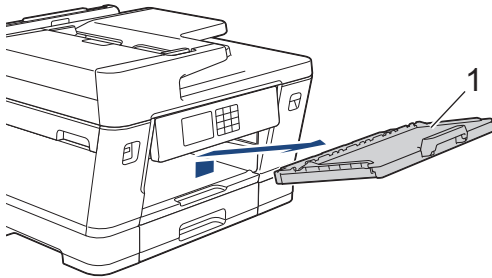

When finished, continue with the next step.

4. Slowly remove the jammed paper (1).

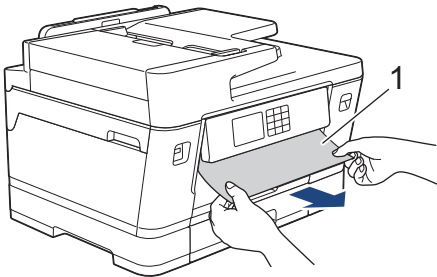



If your LCD displays repeat paper jam messages, for example [Repeat Jam Front/Rear], do the following:

- a. Lift the flap, and remove the jammed paper.

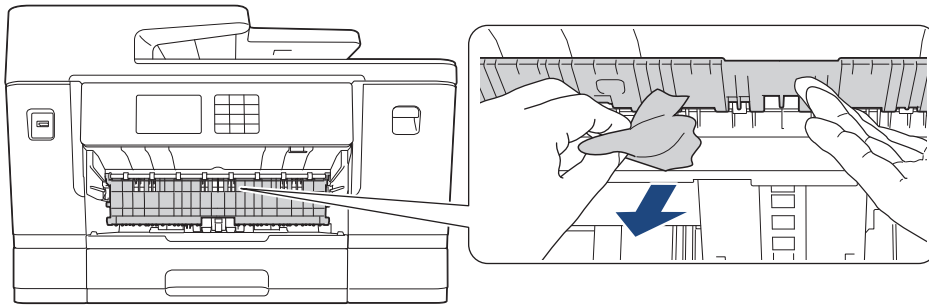

- b. Make sure you look carefully inside (1) for any scraps of paper.

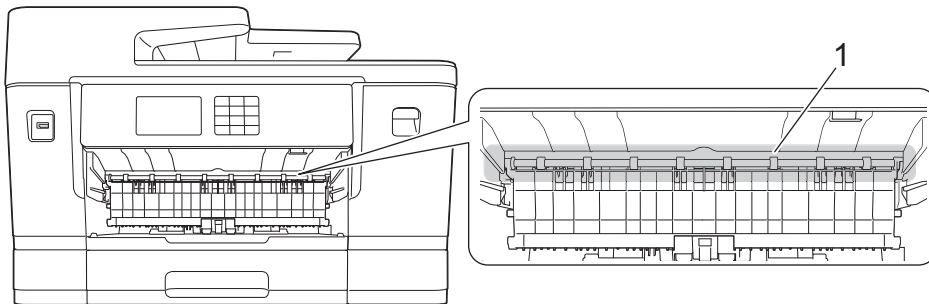

When finished, continue with the next step.

5. Using both hands, use the finger holds on each side of the machine to lift the scanner cover (1) into the open position.

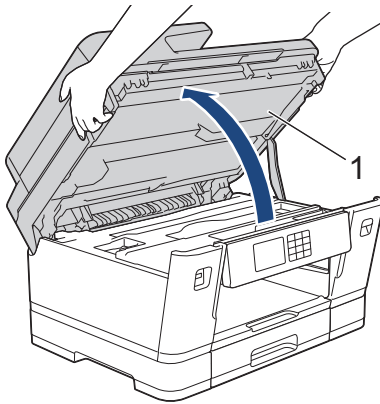

6. Slowly pull the jammed paper (1) out of the machine.

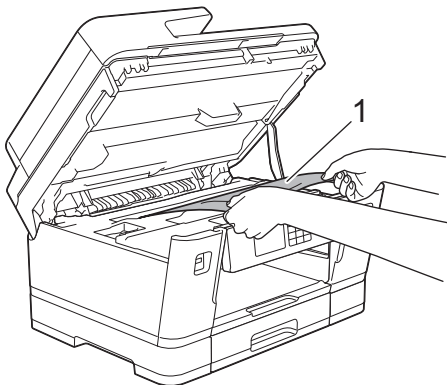



If your LCD displays repeat paper jam messages, for example [Repeat Jam Front/Rear], move the print head, and then remove any paper remaining in this area. Make sure pieces of paper are not left in the corners of the machine (1) and (2).

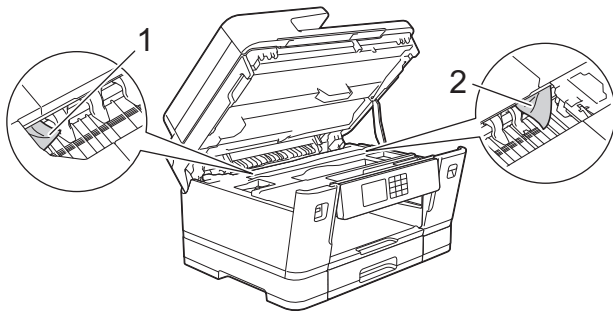

When finished, continue with the next step.

## IMPORTANT

- If the print head is in the right corner as shown in the illustration, you cannot move the print head. Close the scanner cover, and then reconnect the power cord. Open the scanner cover again, and then hold down  until the print head moves to the centre. Then unplug the machine from the power source and remove the paper.

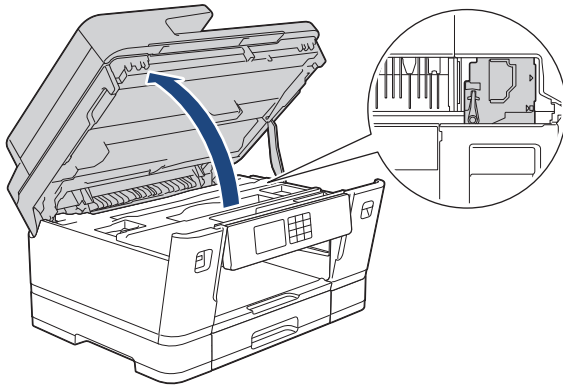

- If the paper is jammed under the print head, unplug the machine from the power source, and then move the print head and remove the paper.
- If ink gets on your skin or clothing, immediately wash it off with soap or detergent.

7. Gently close the scanner cover using the finger holds on each side.

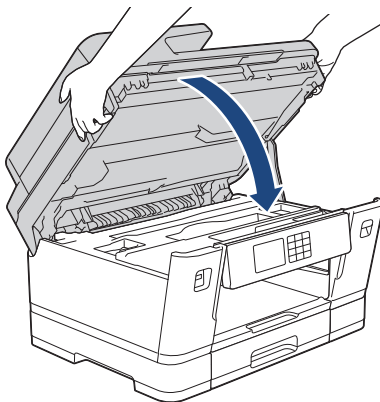

8. If your LCD displays [Jam Front/Rear] or [Repeat Jam Front/Rear], do the following:

- a. Open the Jam Clear Cover (1) at the back of the machine.

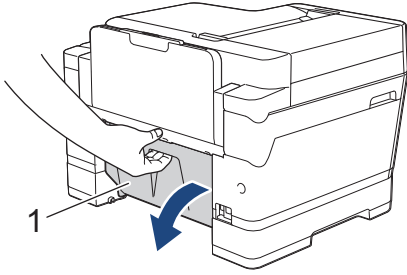

b. Make sure you look carefully inside for jammed paper and slowly pull it out of the machine.

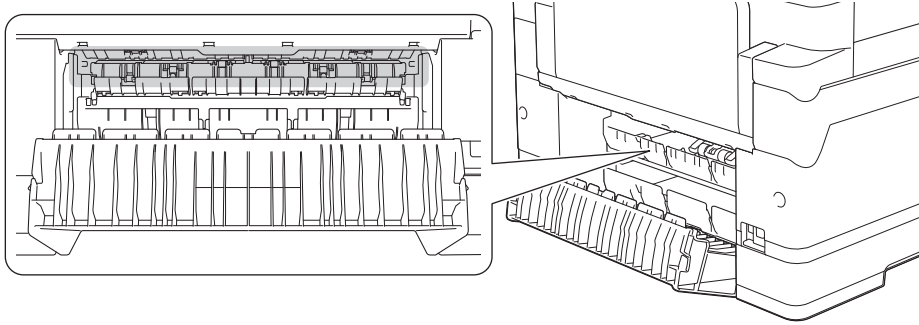

c. Close the Jam Clear Cover. Make sure the cover is closed completely.

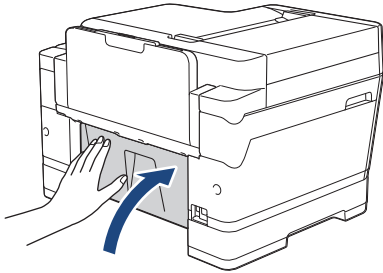

9. If your LCD displays [Jam Front/MP Tray] or [Repeat Jam Front/MP Tray], make sure you look carefully inside the MP tray for jammed paper. Push the release lever (1) towards the back of the machine, and then slowly pull the jammed paper out of the MP tray.



10. If your LCD displays [Jam Front/Manual Feed Slot] or [Repeat Jam Front/Manual Feed], make sure you look carefully inside the manual feed slot for jammed paper and slowly pull it out of the machine.

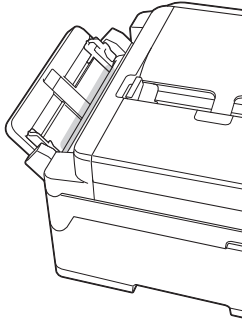

11. If your LCD displays repeat paper jam messages, for example [Repeat Jam Front/Rear], and you removed the paper support, put it firmly back in the machine. Make sure you fit the paper support into the channels.

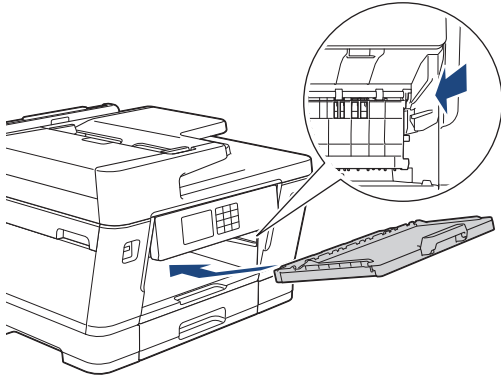

12. Slowly push Tray #1 completely into the machine.

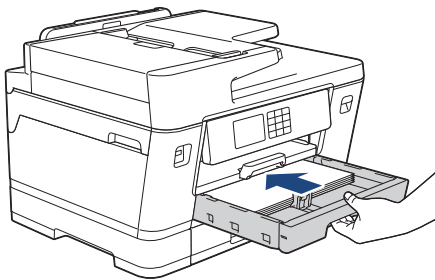

13. Reconnect the power cord.



---

If there is a repeat paper jam, a small piece of paper may be stuck in the machine.  
See *Related Information: Remove Paper Scraps*.

---



### Related Information

- [Printer Jam or Paper Jam](#)

#### Related Topics:

- [Transfer Your Faxes or Fax Journal Report](#)
  - [Error and Maintenance Messages](#)
  - [Remove Paper Scraps](#)
-

## Paper is Jammed in the Back of the Machine

If the LCD displays the following paper jam messages, follow these steps:

- [Jam Rear], [Repeat Jam Rear]
  - [Jam MP Tray], [Repeat Jam MP Tray]
  - [Jam Manual Feed Slot], [Repeat Jam Manual Feed Slot]
  - [Jam Tray2], [Repeat Jam Tray2]
  - [Jam Tray3], [Repeat Jam Tray3]
1. Unplug the machine from the electrical socket.
  2. If the paper is loaded in the MP tray, remove the paper. (MFC-J3940DW/MFC-J6555DW/MFC-J6940DW/MFC-J6955DW/MFC-J6957DW)
  3. Pull Tray #1 (1) completely out of the machine as shown by the arrow.

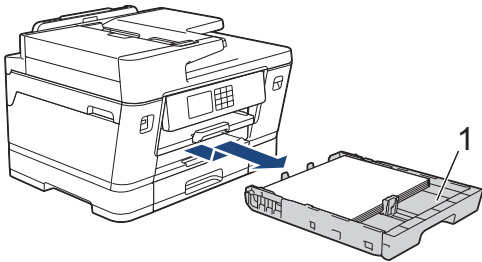

(MFC-J3940DW/MFC-J6740DW/MFC-J6940DW/MFC-J6955DW/MFC-J6957DW) If your LCD displays [Jam Tray2] or [Repeat Jam Tray2], also pull Tray #2 (2) completely out of the machine as shown by the arrow.

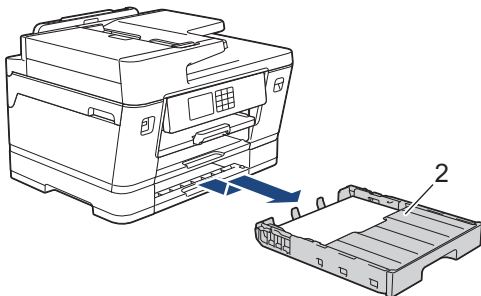

(MFC-J6957DW) If your LCD error displays [Jam Tray3] or [Repeat Jam Tray3], also pull Tray #3 (3) completely out of the machine as shown by the arrow.

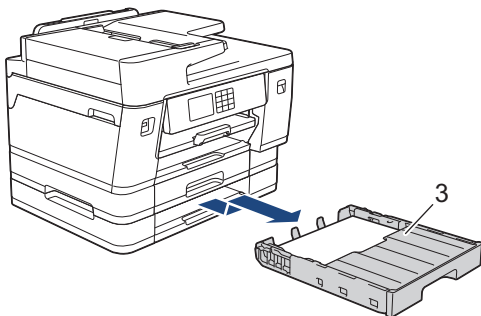

When finished, continue with the next step.

4. If your LCD displays [Jam Rear], [Repeat Jam Rear], [Jam Tray2], [Repeat Jam Tray2], [Jam Tray3] or [Repeat Jam Tray3], do the following:
  - a. Open the Jam Clear Cover (1) at the back of the machine.

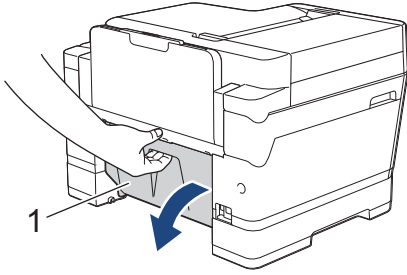

b. Slowly pull the jammed paper out of the machine.

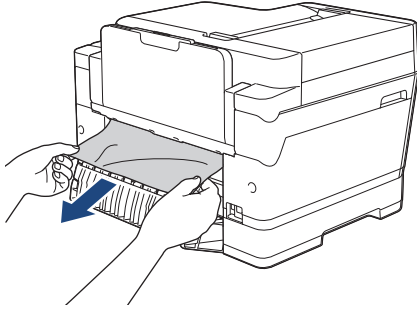

c. Close the Jam Clear Cover. Make sure the cover is closed completely.

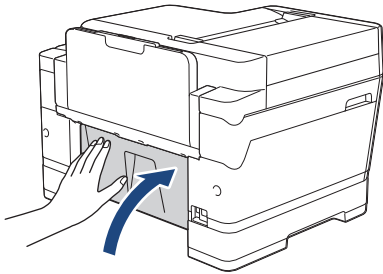

5. If your LCD displays [Jam MP Tray] or [Repeat Jam MP Tray], push the release lever (1) towards the back of the machine, and then slowly pull the jammed paper out of the MP tray.

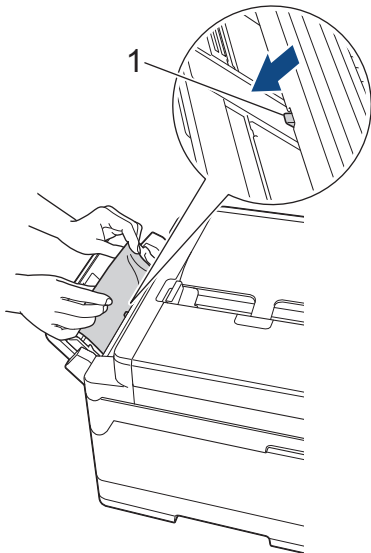

6. If your LCD displays [Jam Manual Feed Slot] or [Repeat Jam Manual Feed Slot], slowly pull the jammed paper out of the manual feed slot.

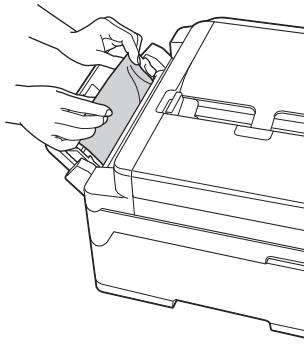

7. Using both hands, use the finger holds on each side of the machine to lift the scanner cover (1) into the open position.

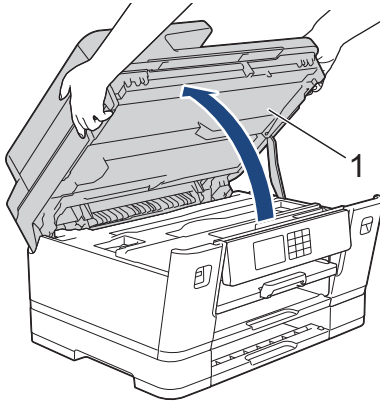

8. Slowly pull the jammed paper (1) out of the machine.

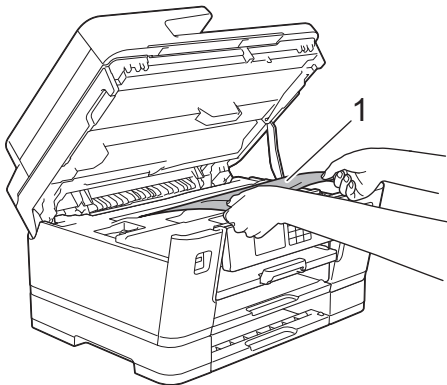

If your LCD displays repeat paper jam messages, for example [Repeat Jam Rear], move the print head, and then remove any paper remaining in this area. Make sure pieces of paper are not left in the corners of the machine (1) and (2).

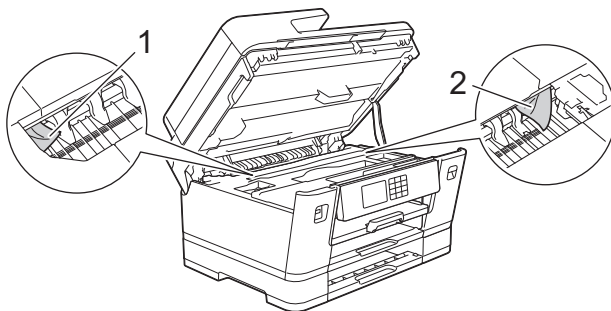

When finished, continue with the next step.

---

## IMPORTANT

- If the print head is in the right corner as shown in the illustration, you cannot move the print head. Close the scanner cover, and then reconnect the power cord. Open the scanner cover again, and then hold down  until the print head moves to the centre. Then unplug the machine from the power source and remove the paper.

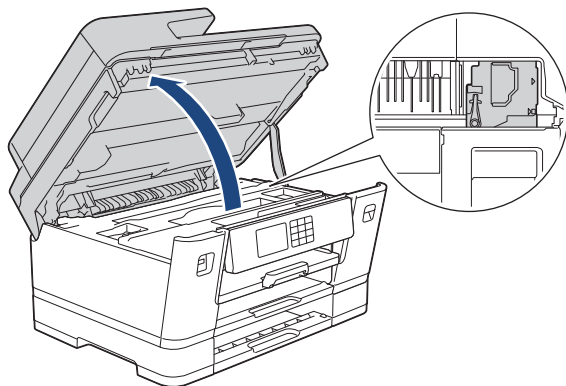

- If the paper is jammed under the print head, unplug the machine from the power source, and then move the print head and remove the paper.
- If ink gets on your skin or clothing, immediately wash it off with soap or detergent.

9. Gently close the scanner cover using the finger holds on each side.

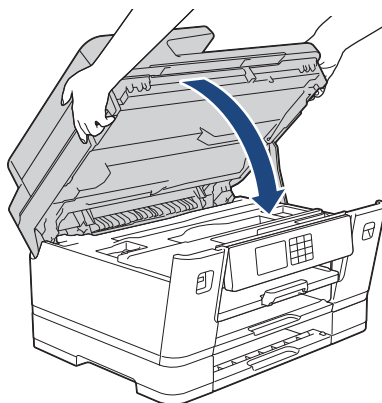

10. Slowly push the paper trays completely into the machine.

- MFC-J3540DW/MFC-J6540DW/MFC-J6555DW

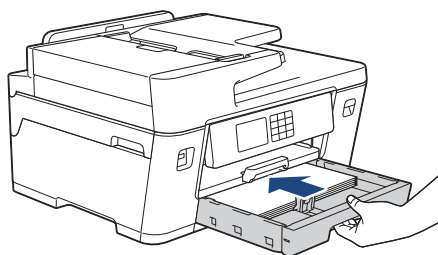

- MFC-J3940DW/MFC-J6740DW/MFC-J6940DW/MFC-J6955DW

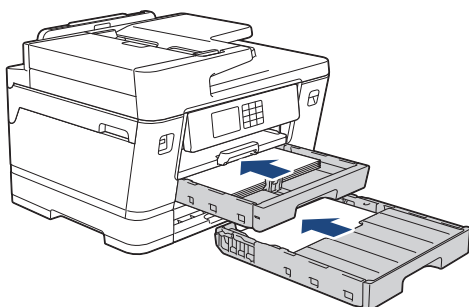

- MFC-J6957DW

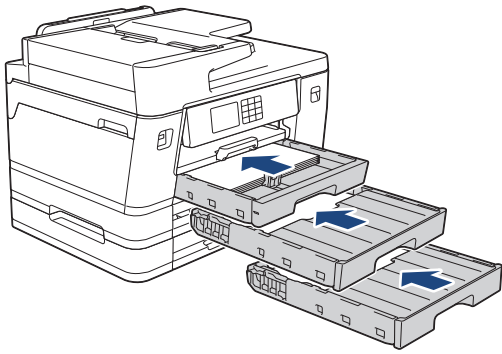

11. Reconnect the power cord.



---

If there is a repeat paper jam, a small piece of paper may be stuck in the machine.  
See *Related Information: Remove Paper Scraps*.

---



### Related Information

- [Printer Jam or Paper Jam](#)

#### Related Topics:

- [Transfer Your Faxes or Fax Journal Report](#)
  - [Remove Paper Scraps](#)
-

## Remove Paper Scraps

1. If you repeatedly experience paper jams (3 times or more), the LCD displays a message asking if you want to remove the scraps.

Press [Yes] to return to the Home screen.

2. Press  [Settings] > [Maintenance] > [Remove Paper Scraps].

3. (MFC-J3540DW/MFC-J6540DW/MFC-J6740DW) Follow the instructions on the LCD to locate and remove the jammed paper.



During the procedure, you must load the Maintenance Sheet (included with your machine) in Landscape orientation in the manual feed slot. (If you do not have the Maintenance Sheet, use one sheet of thick A4 or Letter size paper, such as glossy paper.)

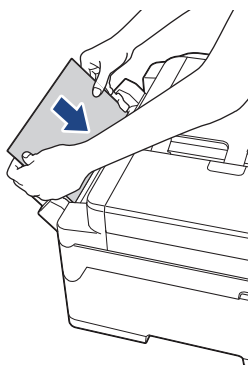

4. (MFC-J3940DW/MFC-J6555DW/MFC-J6940DW/MFC-J6955DW/MFC-J6957DW) Follow the instructions on the LCD to locate and remove the jammed paper.



During the procedure, you must insert the Maintenance Sheet (included with your machine) into the machine in Landscape orientation through the opening as shown, until you feel it grab the paper. (If you do not have the Maintenance Sheet, use one sheet of thick A4 or Letter size paper, such as glossy paper.)

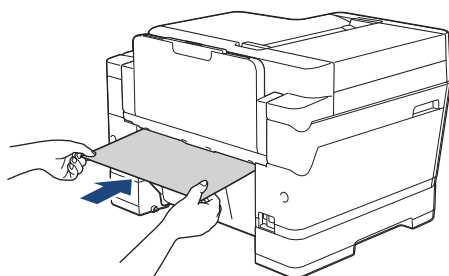

### Related Information

- [Printer Jam or Paper Jam](#)

#### Related Topics:

- [Error and Maintenance Messages](#)
- [Paper Handling and Printing Problems](#)
- [Paper is Jammed in the Front of the Machine](#)
- [Paper is Jammed in the Back of the Machine](#)

## If You Are Having Difficulty with Your Machine



For technical help, you must contact Brother customer support.

If you think there is a problem with your machine, check the following topics. You can correct most problems yourself.

If you need additional help, go to your model's **FAQs & Troubleshooting** page at [support.brother.com](http://support.brother.com).

Using non-Brother supplies may affect the print quality, hardware performance, and machine reliability.



- [Paper Handling and Printing Problems](#)
- [Telephone and Fax Problems](#)
- [Other Problems](#)
- [Network Problems](#)
- [AirPrint Problems](#)



## Paper Handling and Printing Problems

If, after reading this table, you still need help, see the latest **FAQs & Troubleshooting** tips at [support.brother.com](http://support.brother.com).

- >> [Printing Difficulties](#)
- >> [Print Quality Difficulties](#)
- >> [Paper Handling Difficulties](#)
- >> [Printing Received Faxes](#)







### Printing Difficulties

Difficulties	Suggestions
No printout	<p>(Windows)</p> <p>Check that the correct printer driver has been installed and selected.</p> <hr/> <p>Check to see if the machine's display is showing an error message. See <i>Related Information: Error and Maintenance Messages</i>.</p> <hr/> <p>Check that the machine is online:</p> <ul style="list-style-type: none"> <li>• Windows 10, Windows Server 2016, and Windows Server 2019 Click  &gt; <b>Windows System</b> &gt; <b>Control Panel</b>. In the <b>Hardware and Sound</b> group, click <b>View devices and printers</b>. Right-click the <b>Brother XXX-XXXX Printer</b> (where XXX-XXXX is the name of your model). Click <b>See what's printing</b>. If printer driver options appear, select your printer driver. Click <b>Printer</b> in the menu bar and make sure <b>Use Printer Offline</b> is not selected.</li> <li>• Windows 8.1 Move your mouse to the lower right corner of your desktop. When the menu bar appears, click <b>Settings</b> &gt; <b>Control Panel</b>. In the <b>Hardware and Sound</b> group, click <b>View devices and printers</b>. Right-click the <b>Brother XXX-XXXX Printer</b> (where XXX-XXXX is the name of your model). Click <b>See what's printing</b>. If printer driver options appear, select your printer driver. Click <b>Printer</b> in the menu bar and make sure <b>Use Printer Offline</b> is not selected.</li> <li>• Windows Server 2012 R2 Click <b>Control Panel</b> on the <b>Start</b> screen. In the <b>Hardware</b> group, click <b>View devices and printers</b>. Right-click the <b>Brother XXX-XXXX Printer</b> (where XXX-XXXX is the name of your model). Click <b>See what's printing</b>. If printer driver options appear, select your printer driver. Click <b>Printer</b> in the menu bar and make sure <b>Use Printer Offline</b> is not selected.</li> <li>• Windows Server 2012 Move your mouse to the lower right corner of your desktop. When the menu bar appears, click <b>Settings</b> &gt; <b>Control Panel</b>. In the <b>Hardware</b> group, click <b>View devices and printers</b>. Right-click the <b>Brother XXX-XXXX Printer</b> (where XXX-XXXX is the name of your model). Click <b>See what's printing</b>. If printer driver options appear, select your printer driver. Click <b>Printer</b> in the menu bar and make sure <b>Use Printer Offline</b> is not selected.</li> <li>• Windows 7 and Windows Server 2008 R2 Click  (<b>Start</b>) &gt; <b>Devices and Printers</b>. Right-click <b>Brother XXX-XXXX Printer</b> (where XXX-XXXX is the name of your model) and click <b>See what's printing</b>. If printer driver options appear, select your printer driver. Click <b>Printer</b> in the menu bar. Make sure <b>Use Printer Offline</b> is not selected.</li> <li>• Windows Server 2008 Click  (<b>Start</b>) &gt; <b>Control Panel</b> &gt; <b>Hardware and Sound</b> &gt; <b>Printers</b>. Right-click <b>Brother XXX-XXXX Printer</b> (where XXX-XXXX is the name of your model). Make sure <b>Use Printer Online</b> is not listed. If it is listed, click this option to set the driver Online.</li> </ul>

Difficulties	Suggestions
	<p>One or more ink cartridges have reached the end of their life. See <i>Related Information: Replace the Ink Cartridges</i>.</p> <p>If old, unprinted data remains in the printer driver spooler, it will prevent new print jobs from printing. Open the printer icon and delete all data as follows:</p> <ul style="list-style-type: none"> <li>Windows 10, Windows Server 2016, and Windows Server 2019 Click  &gt; <b>Windows System &gt; Control Panel</b>. In the <b>Hardware and Sound</b> group, click <b>View devices and printers &gt; Printers</b>.</li> <li>Windows 8.1 Move your mouse to the lower right corner of your desktop. When the menu bar appears, click <b>Settings &gt; Control Panel</b>. In the <b>Hardware and Sound</b> group, click <b>View devices and printers &gt; Printers</b>.</li> <li>Windows Server 2012 R2 Click <b>Control Panel</b> on the <b>Start</b> screen. In the <b>Hardware</b> group, click <b>View devices and printers &gt; Printers</b>.</li> <li>Windows Server 2012 Move your mouse to the lower right corner of your desktop. When the menu bar appears, click <b>Settings &gt; Control Panel</b>. In the <b>Hardware</b> group, click <b>View devices and printers &gt; Printers</b>.</li> <li>Windows 7 and Windows Server 2008 R2 Click /Start &gt; <b>Devices and Printers &gt; Printers and Faxes</b>.</li> <li>Windows Server 2008 Click  (Start) &gt; <b>Control Panel &gt; Hardware and Sound &gt; Printers</b>.</li> <li>Mac Click the <b>System Preferences &gt; Printers &amp; Scanners</b>.</li> </ul>
The headers or footers appear when the document is displayed on the screen but do not appear when the document is printed.	<p>There is an unprintable area on the top and bottom of the page. Adjust the top and bottom margins in your document to allow for this. See <i>Related Information: Unprintable Area</i>.</p>
Cannot perform 'Page Layout' printing.	<p>(Windows ) Check that the paper size setting in the application and in the printer driver are the same.</p>
Print speed is too slow.	<p>(Windows) Try changing the printer driver setting. The highest resolution needs longer data processing, sending, and printing time. Try the other quality settings in the printer driver as follows: In the printer driver, clear the <b>Colour Enhancement</b> check box on the <b>Advanced</b> tab.</p> <p>Turn the Borderless feature off. Borderless printing is slower than normal printing. See <i>Related Information: Print Settings (Windows)</i>.</p> <p>Turn the Quiet Mode setting off. Print speed is slower in Quiet Mode. See <i>Related Information: Reduce Printing Noise</i>.</p> <p>Make sure the Media Type setting in the printer drivers, your application, or the Paper Type setting on the machine matches the type of paper you are using. See <i>Related Information: Change the Paper Size and Paper Type</i>. See <i>Related Information: Print Settings (Windows)</i>.</p>

## Print Quality Difficulties

Difficulties	Suggestions
Poor print quality	Check the print quality.

Difficulties	Suggestions
	<p>See <i>Related Information: Check the Print Quality.</i></p> <p>Make sure the Media Type setting in the printer drivers, your application, or the Paper Type setting on the machine matches the type of paper you are using. See <i>Related Information: Change the Paper Size and Paper Type.</i> See <i>Related Information: Print Settings (Windows).</i></p> <p>Make sure your ink cartridges are fresh. The following may cause ink to clog:</p> <ul style="list-style-type: none"> <li>• The expiration date written on the cartridge package has passed.</li> <li>• The ink cartridge may not have been stored correctly before use.</li> </ul> <p>Make sure you are using Brother Original ink. Brother does not recommend the use of cartridges other than Brother Original cartridges or the refilling of used cartridges with ink from other sources.</p> <p>Make sure you are using one of the recommended types of paper. See <i>Related Information: Acceptable Print Media.</i></p> <p>The recommended environment for your machine is between 20°C to 33°C.</p>
<p>White lines appear in text or graphics.</p> 	<p>Clean the print head. See <i>Related Information: Clean the Print Head from Your Brother Machine.</i> See <i>Related Information: Clean the Print Head Using Web Based Management.</i> See <i>Related Information: Clean the Print Head from Your Computer (Windows).</i></p> <p>Check and adjust the paper feed. See <i>Related Information: Correct the Paper Feed to Clear Vertical Lines.</i></p> <p>Make sure you are using Brother Original ink.</p> <p>Try using the recommended types of paper. See <i>Related Information: Acceptable Print Media.</i></p> <p>To prolong print head life, provide the best ink cartridge economy and maintain print quality, we do not recommend frequently unplugging the machine and/or leaving the machine unplugged for extended periods of time. We recommend using  to power down the machine. Using  allows minimal power to the machine, resulting in periodic, but less frequent, cleaning of the print head.</p>
<p>Dark lines appear at regular intervals.</p> 	<p>Check and adjust the paper feed. See <i>Related Information: Correct the Paper Feed to Clear Vertical Lines.</i></p>
<p>The machine prints blank pages.</p>	<p>Check the print quality. See <i>Related Information: Check the Print Quality.</i></p> <p>Make sure you are using Brother Original ink.</p> <p>To prolong print head life, provide the best ink cartridge economy and maintain print quality, we do not recommend frequently unplugging the machine and/or leaving the machine unplugged for extended periods of time. We recommend using  to power down the machine. Using  allows minimal power to the machine, resulting in periodic, but less frequent, cleaning of the print head.</p>
<p>Characters and lines are blurred.</p>	<p>Check the printing alignment. See <i>Related Information: Check the Print Alignment from Your Brother Machine.</i></p> <p>Change the print options. See <i>Related Information: Change the Print Options to Improve Your Print Results.</i></p>

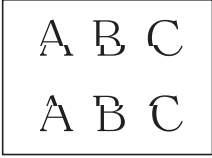
Difficulties	Suggestions
	
Printed text or images are skewed.	Make sure the paper is loaded correctly in the paper tray and the paper guides are adjusted correctly. <i>See Related Information: Load Paper.</i>
	Make sure the Jam Clear Cover is closed correctly.
There are smudges or stains at the top centre of the printed page.	Make sure the paper is not too thick or curled. <i>See Related Information: Acceptable Print Media.</i>
Printing appears dirty or ink seems to run.	Make sure you are using the recommended types of paper. Do not handle the paper until the ink is dry. <i>See Related Information: Acceptable Print Media.</i>
	Make sure the printing surface is face down in the paper tray.
	Make sure you are using Brother Original ink.
	If you are using photo paper, make sure the glossy side of the photo paper is face down in the tray and you have set the correct paper type. If you are printing a photo from your computer, set the Media Type in the printer driver or in the application you use to print.
Ink is smudged or wet when using glossy photo paper.	Be sure to check the front and back of the paper. Place the glossy surface (printing surface) face down. <i>See Related Information: Change the Paper Size and Paper Type.</i>
	If you use glossy photo paper, make sure the paper type setting is correct.
Stains appear on the reverse side or at the bottom of the page.	Make sure the printer platen is not dirty with ink. <i>See Related Information: Clean the Machine's Printer Platen.</i>
	Make sure you are using Brother Original ink.
	Make sure you are using the paper support flap. <i>See Related Information: Load Paper.</i>
	Make sure the paper feed rollers are not dirty with ink. <i>See Related Information: Clean the Paper Feed Rollers.</i>
The printouts are wrinkled.	(Windows) In the printer driver, select the <b>Advanced</b> tab, click <b>Other Print Options</b> , and then click <b>Advanced Colour Settings</b> . Clear the <b>Bi-Directional Printing</b> check box.
	Make sure you are using Brother Original ink.
Smudge or stain on the reverse side of the page when using the automatic 2-sided printing feature.	(Windows) Change the Reduce Smudge option in your printer driver properties or preferences. <i>See Related Information: Prevent Smudged Printouts and Paper Jams (Windows).</i>

## Paper Handling Difficulties

Difficulties	Suggestions
The machine does not feed paper.	Make sure the paper tray is pushed in all the way until it locks into place.
	Make sure the Jam Clear Cover at the back of the machine is closed.
	If the machine's LCD displays a Paper Jam message and you still have a problem, see <i>Related Information: Error and Maintenance Messages</i> .

Difficulties	Suggestions
	<p>If the paper tray is empty, load a new stack of paper into the paper tray.</p> <p>If there is paper in the paper tray, make sure it is straight. If the paper is curled, straighten it. Sometimes it is helpful to remove the paper, turn the stack over and put it back in the paper tray.</p> <p>Reduce the amount of paper in the paper tray, and then try again.</p> <p>Clean the paper pick-up rollers. See <i>Related Information: Clean the Paper Pick-up Rollers for Paper Tray #1 or Clean the Paper Pick-up Rollers for Paper Tray #2 and Paper Tray #3.</i></p> <p>Make sure that the paper is within specifications for the machine. See <i>Related Information: Paper Orientation and Capacity of the Paper Trays.</i></p>
Photo paper does not feed correctly.	When you print on photo paper, load one extra sheet of the same photo paper in the paper tray.
Machine feeds multiple pages.	<ul style="list-style-type: none"> <li>• Make sure the paper is loaded correctly in the paper tray.</li> <li>• Remove all the paper from the tray and fan the stack of paper well, then put it back in the tray.</li> <li>• Make sure you do not push the paper in too far.</li> </ul> <p>See <i>Related Information: Load Paper.</i></p> <p>Make sure the Jam Clear Cover is closed correctly. See <i>Related Information: Printer Jam or Paper Jam.</i></p> <p>Make sure the Base Pad in the paper tray is not dirty. See <i>Related Information: Clean the Base Pad.</i></p>
There is a paper jam.	<p>See <i>Related Information: Printer Jam or Paper Jam.</i></p> <p>Make sure the paper guides are set to the correct paper size.</p> <p>Use the jam prevention settings. For copying: See <i>Related Information: Change the Print Options to Improve Your Print Results.</i> For printing: See <i>Related Information: Prevent Smudged Printouts and Paper Jams (Windows).</i></p>
Paper jam reoccurs.	<p>If there is a repeat paper jam, a small piece of paper may be stuck in the machine. Make sure paper is not still jammed in the machine. See <i>Related Information: Remove Paper Scraps.</i></p>
The paper jams when you use 2-sided print.	<p>If paper jams occur frequently during 2-sided printing, the paper feed rollers may be stained with ink. Clean the paper feed rollers. See <i>Related Information: Clean the Paper Feed Rollers.</i></p>

## Printing Received Faxes

Difficulties	Suggestions
<ul style="list-style-type: none"> <li>• Condensed print</li> <li>• Horizontal streaks</li> <li>• Top and bottom sentences are cut off</li> <li>• Missing lines</li> </ul>	<p>This is usually caused by a poor telephone connection. Make a copy; if your copy looks good, you probably had a bad connection, with static or interference on the telephone line. Ask the other party to send the fax again.</p>
Black lines when receiving.	The sender's scanner may be dirty. Ask the sender to make a copy to see if the problem is with the sending machine. Try receiving from another fax machine.
Left and right margins are cut off or a single page is printed on two pages.	If the received faxes are divided and printed on two pages or if you get an extra blank page, your paper size setting may not be correct for the paper you are using.

Difficulties	Suggestions
	See <i>Related Information: Change the Paper Size and Paper Type</i> .
	Turn on Auto Reduction. See <i>Related Information: Shrink Page Size of an Oversized Incoming Fax</i> .
Received colour fax prints only in monochrome.	Replace the colour ink cartridges that have reached the end of their life, and then ask the other person to send the colour fax again. See <i>Related Information: Replace the Ink Cartridges</i> .



## Related Information

- [If You Are Having Difficulty with Your Machine](#)

### Related Topics:

- [Troubleshooting](#)
- [Error and Maintenance Messages](#)
- [Replace the Ink Cartridges](#)
- [Check the Print Quality](#)
- [Acceptable Print Media](#)
- [Clean the Print Head from Your Brother Machine](#)
- [Clean the Print Head Using Web Based Management](#)
- [Clean the Print Head from Your Computer \(Windows\)](#)
- [Check the Print Alignment from Your Brother Machine](#)
- [Load Paper](#)
- [Clean the Machine's Printer Platen](#)
- [Clean the Paper Feed Rollers](#)
- [Clean the Paper Pick-up Rollers for Paper Tray #1](#)
- [Clean the Paper Pick-up Rollers for Paper Tray #2 and Paper Tray #3](#)
- [Printer Jam or Paper Jam](#)
- [Shrink Page Size of an Oversized Incoming Fax](#)
- [Print Settings \(Windows\)](#)
- [Prevent Smudged Printouts and Paper Jams \(Windows\)](#)
- [Clean the Base Pad](#)
- [Change the Print Options to Improve Your Print Results](#)
- [Reduce Printing Noise](#)
- [Remove Paper Scraps](#)
- [Correct the Paper Feed to Clear Vertical Lines](#)
- [Unprintable Area](#)
- [Change the Paper Size and Paper Type](#)
- [Paper Orientation and Capacity of the Paper Trays](#)

## Telephone and Fax Problems

>> Telephone Line or Connections

>> Handling Incoming Calls

>> Receiving Faxes

>> Sending Faxes

### Telephone Line or Connections

Difficulties	Suggestions
Dialling does not work. (No dial tone)	<p>Check all line cord connections. Make sure the telephone line cord is plugged into the telephone wall socket and the LINE socket of the machine. Make sure your machine has a dial tone by pressing the Hook button in Fax mode. If you subscribe to DSL or VoIP services, contact your service provider for connection instructions.</p> <p>If you are using a VoIP system, try changing the VoIP setting to <i>Basic (for VoIP)</i>. This will lower modem speed and turn off Error Correction Mode (ECM).</p> <p>See <i>Related Information: Telephone Line Interference/VoIP</i>.</p>
	<p>(Available only for some countries.)</p> <p>Change the Tone/Pulse setting.</p> <p>See <i>Related Information: Set Tone or Pulse Dialling Mode</i>.</p>
	<p>(Not available for South Africa)</p> <p>Send a manual fax by pressing the Hook button, and dialling the number. Wait to hear fax-receiving tones before pressing the Start button.</p>
	<p>If there is no dial tone, connect a known working telephone and telephone line cord to the socket. Then lift the external telephone's handset and listen for a dial tone. If there is still no dial tone, ask your telephone company to check the line and/or wall socket.</p>
The machine does not answer when called.	<p>Make sure the machine is in the correct receive mode for your setup.</p> <p>See <i>Related Information: Choose the Correct Receive Mode</i>.</p> <p>Check for a dial tone. If possible, call your machine to hear it answer. If there is still no answer, check that the telephone line cord is plugged into the telephone wall socket and the LINE socket of the machine. Make sure your machine has a dial tone by pressing the Hook button in Fax mode. If there is no ringing when you call your machine, ask your telephone company to check the line.</p>

### Handling Incoming Calls

Difficulties	Suggestions
The machine 'Hears' a voice as a CNG Tone.	<p>If Fax Detect is set to On, your machine is more sensitive to sounds. It may mistakenly interpret certain voices or music on the line as a fax machine calling and respond with fax receiving tones. Deactivate the machine by pressing .</p> <p>Try avoiding this problem by turning Fax Detect Off.</p> <p>See <i>Related Information: Set Fax Detect</i>.</p>
Sending a Fax Call to the machine.	<p>If you answered on an extension or external telephone, press your Remote Activation Code (the factory setting is *51 (*91 for New Zealand)). If you answered on the external telephone, press the Start button to receive the fax.</p> <p>When your machine answers, hang up.</p>
Custom features on a single line.	<p>If you have Call Waiting, Call Waiting/Caller ID, Caller ID, Voice Mail, an answering machine, an alarm system or other custom feature on a single telephone line with your machine, it may create a problem sending or receiving faxes.</p> <p><b>For Example:</b> If you subscribe to Call Waiting or some other custom service and its signal comes through the line while your machine is sending or receiving a</p>

Difficulties	Suggestions
	fax, the signal can temporarily interrupt or disrupt the faxes. Brother's ECM (Error Correction Mode) feature should help overcome this problem. This condition is related to the telephone system industry and is common to all devices that send and receive information on a single, shared line with custom features. If avoiding a slight interruption is crucial to your business, we recommend using a separate telephone line with no custom features.

## Receiving Faxes

Difficulties	Suggestions
Cannot receive a fax.	<p>(Not available for South Africa)</p> <p>Make sure your machine has a dial tone by pressing the Hook button in Fax mode. If you hear static or interference on your fax line, contact your local telephone provider.</p> <p>Check all line cord connections. Make sure the telephone line cord is plugged into the telephone wall socket and the LINE socket of the machine. If you subscribe to DSL or VoIP services, contact your service provider for connection instructions. If you are using a VoIP system, try changing the VoIP setting to <i>Basic (for VoIP)</i>. This will lower modem speed and turn off Error Correction Mode (ECM).</p> <p>See <i>Related Information: Telephone Line Interference/VoIP</i>.</p> <p>Make sure the machine is in the correct Receive Mode. This is determined by the external devices and telephone subscriber services you have on the same line as the Brother machine.</p> <p>See <i>Related Information: Choose the Correct Receive Mode</i>.</p> <ul style="list-style-type: none"> <li>• If you have a dedicated fax line and want your Brother machine to automatically answer all incoming faxes, you should select Fax only mode.</li> <li>• If your Brother machine shares a line with an external answering machine, you should select the External TAD mode. In External TAD mode, your Brother machine will receive incoming faxes automatically and voice callers will be able to leave a message on your answering machine.</li> <li>• If your Brother machine shares a line with other telephones and you want it to automatically answer all incoming faxes, you should select the Fax/Tel mode. In Fax/Tel mode, your Brother machine will receive faxes automatically and produce a pseudo/double-ring to alert you to answer voice calls.</li> <li>• If you do not want your Brother machine to answer any incoming faxes automatically, you should select the Manual mode. In Manual mode, you must answer every incoming call and activate the machine to receive faxes.</li> </ul> <p>Another device or service at your location may be answering the call before your Brother machine answers. To test this, lower the Ring Delay setting:</p> <ul style="list-style-type: none"> <li>• If the Receive Mode is set to Fax Only or Fax/Tel, reduce the Ring Delay to the lowest ring greater than 0.</li> </ul> <p>See <i>Related Information: Set the Number of Rings Before the Machine Answers (Ring Delay)</i>.</p> <ul style="list-style-type: none"> <li>• If the Receive Mode is set to External TAD, reduce the number of rings programmed on your answering machine to two.</li> <li>• If the Receive Mode is set to Manual, DO NOT adjust the Ring Delay setting.</li> </ul> <p>Have someone send you a test fax:</p> <ul style="list-style-type: none"> <li>• If you received the test fax successfully, your machine is operating correctly. Remember to reset your Ring Delay or answering machine setting back to your original setting. If receiving problems recur after resetting the Ring Delay, then a person, device, or subscriber service is answering the fax call before the machine has a chance to answer.</li> <li>• If you were not able to receive the fax, then another device or subscriber service may be interfering with your fax reception or there may be a problem with your fax line.</li> </ul>

Difficulties	Suggestions
	<p>If you are using a telephone answering machine (External TAD mode) on the same line as the Brother machine, make sure your answering machine is set up correctly.</p> <p>See <i>Related Information: Connect an External TAD</i>.</p> <ol style="list-style-type: none"> <li>1. Connect the external TAD as shown in the following topic: See <i>Related Information: External TAD (Telephone Answering Device)</i>.</li> <li>2. Set your answering machine to answer in one or two rings.</li> <li>3. Record the outgoing message on your answering machine. <ul style="list-style-type: none"> <li>• Record five seconds of silence at the beginning of your outgoing message.</li> <li>• Limit your speaking to 20 seconds.</li> <li>• End your outgoing message with your Remote Activation Code for people sending manual faxes. For example: "After the beep, leave a message or press *51 (*91 for New Zealand) and Start to send a fax."</li> </ul> </li> <li>4. Set your answering machine to answer calls.</li> <li>5. Set your Brother machine's Receive Mode to External TAD. See <i>Related Information: Choose the Correct Receive Mode</i>.</li> </ol>
	<p>Make sure your Brother machine's Fax Detect feature is turned On. Fax Detect is a feature that allows you to receive a fax even if you answered the call on an external or extension telephone.</p> <p>See <i>Related Information: Set Fax Detect</i>.</p>
	<p>If you often get transmission errors due to possible interference on the telephone line or if you are using a VoIP system, try changing the Compatibility setting to <i>Basic (for VoIP)</i>.</p> <p>See <i>Related Information: Telephone Line Interference/VoIP</i>.</p>
	<p>(Available only for some countries.)</p> <p>If you connect your machine to a PBX or ISDN line, set the menu setting of Telephone Line Type to your telephone line type.</p> <p>See <i>Related Information: Set the Telephone Line Type</i>.</p>

## Sending Faxes

Difficulties	Suggestions
Cannot send a fax.	<p>Check all line cord connections. Make sure the telephone line cord is plugged into the telephone wall socket and the LINE socket of the machine. Make sure your machine has a dial tone by pressing the Hook button in Fax mode. If you subscribe to DSL or VoIP services, contact your service provider for connection instructions.</p> <p>If you are using a VoIP system, try changing the VoIP setting to <i>Basic (for VoIP)</i>. This will lower modem speed and turn off Error Correction Mode (ECM).</p> <p>See <i>Related Information: Telephone Line Interference/VoIP</i>.</p>
	<p>Print the Transmission Verification Report and check for an error.</p> <p>See <i>Related Information: Print Reports</i>.</p>
	<p>Contact your administrator to check your Secure Function Lock Settings.</p>
	<p>Ask the other party to check that the receiving machine has paper.</p>
Poor sending quality.	<p>Try changing your resolution to Fine or S.Fine. Make a copy to check your machine's scanner operation. If the copy quality is poor, clean the scanner.</p> <p>See <i>Related Information: Clean the Scanner</i>.</p>
Transmission Verification Report says RESULT:NG.	<p>There is probably temporary noise or static on the line. Try sending the fax again. If you are sending a PC-Fax message and get RESULT:NG on the Transmission Verification Report, your machine may be out of memory.</p> <p>To free up extra memory, you can turn off Fax Storage, print fax messages in memory or cancel a delayed fax.</p>

Difficulties	Suggestions
	<p>If the problem continues, ask the telephone company to check your telephone line.</p> <p>See <i>Related Information: Turn Off Memory Receive</i>.</p> <p>See <i>Related Information: Print a Fax Stored in the Machine's Memory</i>.</p> <p>See <i>Related Information: Cancel a Fax in Progress</i>.</p> <p>See <i>Related Information: Check and Cancel a Pending Fax</i>.</p>
	<p>(Available only for some countries.)</p> <p>If you connect your machine to a PBX or ISDN line, set the menu setting of Telephone Line Type to your telephone line type.</p> <p>See <i>Related Information: Set the Telephone Line Type</i>.</p>
	<p>If you often get transmission errors due to possible interference on the telephone line or if you are using a VoIP system, try changing the Compatibility setting to Basic (for VoIP).</p> <p>See <i>Related Information: Telephone Line Interference/VoIP</i>.</p>
Sent faxes are blank.	<p>Make sure you are loading the document correctly.</p> <p>See <i>Related Information: Load Documents in the Automatic Document Feeder (ADF)</i>.</p> <p>See <i>Related Information: Load Documents on the Scanner Glass</i>.</p>
Size of the sent fax is different from the document size.	<p>The machine may not detect the document size correctly for some documents, such as dark-colour documents and transparencies. Select the correct document size option according to the size of your document.</p>
	<p>(MFC-J6555DW/MFC-J6955DW/MFC-J6957DW) The ADF document sensor may detect the wrong document size. Clean the ADF document sensor.</p> <p>See <i>Related Information: Clean the ADF Document Sensor</i>.</p>
Vertical black lines when sending.	<p>Black vertical lines on faxes you send are typically caused by dirt or correction fluid on the glass strip. Clean the glass strip.</p> <p>See <i>Related Information: Clean the Scanner</i>.</p>



## Related Information

- [If You Are Having Difficulty with Your Machine](#)
  - [Set Dial Tone Detection](#)
  - [Telephone Line Interference/VoIP](#)



### Related Topics:

- [Troubleshooting](#)
- [Set Tone or Pulse Dialling Mode](#)
- [Choose the Correct Receive Mode](#)
- [Set Fax Detect](#)
- [Set the Number of Rings Before the Machine Answers \(Ring Delay\)](#)
- [Connect an External TAD](#)
- [External TAD \(Telephone Answering Device\)](#)
- [Set the Telephone Line Type](#)
- [Print Reports](#)
- [Clean the Scanner](#)
- [Clean the ADF Document Sensor](#)
- [Turn Off Memory Receive](#)
- [Print a Fax Stored in the Machine's Memory](#)
- [Cancel a Fax in Progress](#)
- [Check and Cancel a Pending Fax](#)

- 
- Load Documents in the Automatic Document Feeder (ADF)
  - Load Documents on the Scanner Glass
-

## Set Dial Tone Detection

Setting the Dial Tone to [Detection] will shorten the Dial Tone detect pause.

1. Press  [Settings] > [All Settings] > [Initial Setup] > [Dial Tone].
2. Press [Detection] or [No Detection].
3. Press .



### Related Information

- [Telephone and Fax Problems](#)
-

## Telephone Line Interference/VoIP

If you are having problems sending or receiving a fax due to possible interference on the telephone line or if you are using a VoIP system, we recommend changing the modem speed to minimise errors in fax operations.

1. Press  [Settings] > [All Settings] > [Initial Setup] > [Compatibility].

2. Press the option you want.

- [Basic (for VoIP)] reduces the modem speed to 9,600 bps and turns off colour fax receiving and Error Correction Mode (ECM), except for colour fax-sending. Unless interference is a recurring problem on your telephone line, you may prefer to use it only when needed.

To improve compatibility with most VoIP services, Brother recommends changing the compatibility setting to [Basic (for VoIP)].

- [Normal] sets the modem speed at 14,400 bps.
- [High] sets the modem speed at 33,600 bps.

3. Press .



- VoIP (Voice over IP) is a type of phone system that uses an Internet connection, rather than a traditional phone line.
- Brother does not recommend the use of a VoIP line. VoIP limitations in general can cause some functions of the fax machine not to work correctly.



### Related Information

- [Telephone and Fax Problems](#)

#### Related Topics:

- [Voice Over Internet Protocol \(VoIP/Telephone Line Interference\)](#)
- [Error and Maintenance Messages](#)

## Other Problems

- >> Copying Difficulties
- >> Scanning Difficulties
- >> Direct Photo Printing Difficulties
- >> Software Difficulties

### Copying Difficulties

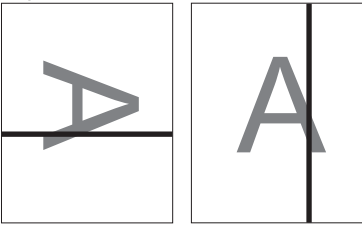
Difficulties	Suggestions
Cannot make a copy.	Contact your administrator to check your Secure Function Lock Settings.
Black lines or streaks appear in copies. 	Black lines on copies are typically caused by dirt or correction fluid on the glass strip. Clean the glass strip, scanner glass, and the white bar and white plastic above them. See <i>Related Information: Clean the Scanner.</i>
Black marks or spots appear in copies.	Black marks or spots on copies are typically caused by dirt or correction fluid on the scanner glass. Clean the scanner glass and white plastic above it. See <i>Related Information: Clean the Scanner.</i>
Copies are blank.	Make sure you are loading the document correctly. See <i>Related Information: Load Documents in the Automatic Document Feeder (ADF).</i> See <i>Related Information: Load Documents on the Scanner Glass.</i>
Poor copy results when using the ADF.	Try using the scanner glass. See <i>Related Information: Load Documents on the Scanner Glass.</i>
Paper size of copies is larger than expected when using the ADF. (MFC-J6555DW/MFC-J6955DW/MFC-J6957DW)	The ADF document sensor may detect the wrong document size. Clean the ADF document sensor. See <i>Related Information: Clean the ADF Document Sensor.</i>
Fit to Page does not work correctly.	Make sure the document is not skewed on the scanner glass. Reposition the document and try again.
	The machine may not detect the document size correctly for some documents, such as dark-colour documents and transparencies. Therefore, Fit to Page may not work. Select an enlargement or reduction ratio other than Fit to Page according to the sizes of your document and paper.
Smudge or stain on the reverse side of the page when using the 2-sided copy feature.	Change the print options. See <i>Related Information: Change the Print Options to Improve Your Print Results.</i>

### Scanning Difficulties

Difficulties	Suggestions
TWAIN or WIA errors appear when starting to scan. (Windows)	Make sure the Brother TWAIN or WIA driver is selected as the primary source in your scanning application. For example, in Nuance™ PaperPort™ 14SE, click <b>Desktop &gt; Scan Settings &gt; Select</b> to choose the Brother TWAIN/WIA driver.
OCR does not work.	Try increasing the scanning resolution.

Difficulties	Suggestions
Poor scanning results when using the ADF. (Black lines appear in the scanned data.)	Clean the white bar and the glass strip underneath it. See <i>Related Information: Clean the Scanner.</i>
	Try using the scanner glass. See <i>Related Information: Load Documents on the Scanner Glass.</i>
Size of scanning results is different from the document size.	The machine may not detect the document size correctly for some documents, such as dark-colour documents and transparencies. Select the correct document size option according to the size of your document.
	(MFC-J6555DW/MFC-J6955DW/MFC-J6957DW) The ADF document sensor may detect the wrong document size. Clean the ADF document sensor. See <i>Related Information: Clean the ADF Document Sensor.</i>

## Direct Photo Printing Difficulties

Difficulties	Suggestions
Part of my photo is missing when printed.	Make sure Borderless printing and Cropping are turned off. See <i>Related Information: Print Borderless Photos from a USB Flash Drive.</i> See <i>Related Information: Print Photos with Auto Cropping.</i>

## Software Difficulties

Difficulties	Suggestions
Cannot print.	Uninstall the drivers (Windows) and the Brother software and reinstall the latest version of both.
"The device is busy." appears on the computer screen.	Make sure there is no error message on the machine's display.

## ✓ Related Information

- [If You Are Having Difficulty with Your Machine](#)

### Related Topics:

- [Troubleshooting](#)
- [Clean the Scanner](#)
- [Load Documents in the Automatic Document Feeder \(ADF\)](#)
- [Load Documents on the Scanner Glass](#)
- [Print Borderless Photos from a USB Flash Drive](#)
- [Print Photos with Auto Cropping](#)
- [Clean the ADF Document Sensor](#)
- [Change the Print Options to Improve Your Print Results](#)

## Network Problems

- [Use the Network Connection Repair Tool \(Windows\)](#)
- [Check Your Machine's Network Settings](#)
- [If You Are Having Difficulty with Your Machine's Network](#)
- [Troubleshooting](#)

## Use the Network Connection Repair Tool (Windows)

Use the Network Connection Repair Tool to fix the Brother machine's network settings. It will assign the correct IP address and Subnet Mask.

Make sure your machine is turned on and is connected to the same network as your computer.

1. Launch  (**Brother Utilities**), and then click the drop-down list and select your model name (if not already selected).
2. Click **Tools** in the left navigation bar, and then click **Network Connection Repair Tool**.
3. Follow the on-screen instructions.
4. Check the diagnosis by printing the Network Configuration Report.



The Network Connection Repair Tool will start automatically if you select the **Enable Connection Repair Tool** option in the Status Monitor. Right-click the Status Monitor screen, and then click **Other Settings > Enable Connection Repair Tool**. This is not recommended when your network administrator has set the IP address to Static, since it will automatically change the IP address.

If the correct IP address and the Subnet Mask are still not assigned even after using the Network Connection Repair Tool, ask your network administrator for this information.



### Related Information

- [Network Problems](#)

#### Related Topics:

- [Print the Network Configuration Report](#)
- [If You Are Having Difficulty with Your Machine's Network](#)

## **Check Your Machine's Network Settings**

- [Print the Network Configuration Report](#)
- [Change Machine Settings Using Web Based Management](#)

## If You Are Having Difficulty with Your Machine's Network



For technical help, you must contact Brother customer support.

If you think there is a problem with your machine, check the following topics. You can correct most problems yourself.

If you need additional help, go to your model's **FAQs & Troubleshooting** page at [support.brother.com](http://support.brother.com).

>> [I Cannot Complete the Wireless Network Setup Configuration](#)

>> [My Brother Machine Cannot Print, Scan, or PC-FAX Receive over the Network](#)

>> [I Want to Check that My Network Devices are Working Correctly](#)

### I Cannot Complete the Wireless Network Setup Configuration

Turn your wireless router off and back on. Then, try to configure the wireless settings again. If you are unable to resolve the problem, follow the instructions below:

Investigate the problem using the WLAN Report.

Cause	Action	Interface
Your security settings (SSID/ Network Key) are not correct.	<ul style="list-style-type: none"> <li>• Confirm the security settings using <b>Wireless Setup Helper</b>. For more information and to download the utility, go to your model's <b>Downloads</b> page at <a href="http://support.brother.com">support.brother.com</a>.</li> <li>• Select and confirm that you are using the correct security settings.                             <ul style="list-style-type: none"> <li>- See the instructions supplied with your wireless LAN access point/router for information on how to find the security settings.</li> <li>- The manufacturer's name or model number of the wireless LAN access point/router may be used as the default security settings.</li> <li>- Consult with the access point/router manufacturer, your Internet provider, or network administrator.</li> </ul> </li> </ul>	Wireless
Your Brother machine's MAC address is not allowed.	Confirm that the Brother machine's MAC Address is allowed in the filter. You can find the MAC Address on your Brother machine's control panel.	Wireless
Your wireless LAN access point/router is in stealth mode (not broadcasting the SSID).	<ul style="list-style-type: none"> <li>• Enter the correct SSID name or Network Key manually.</li> <li>• Check the SSID name or the Network Key in the instructions supplied with your wireless LAN access point/router and reconfigure the wireless network setup.</li> </ul>	Wireless
(For Oceania countries) The current channel of your wireless LAN access point/router is not supported by your machine when you are trying to connect your machine to a 5 GHz Wi-Fi network.	<p>Change the channel on your wireless LAN access point/router to the channel supported by your machine.</p> <ol style="list-style-type: none"> <li>1. Confirm the channels supported by your machine. See the <b>Channels Supported by Brother Machines for 5 GHz Wi-Fi Networks</b> document at <a href="http://support.brother.com/manuals">support.brother.com/manuals</a>.</li> <li>2. Check your wireless LAN access point/router's channel setting. Make sure it is set to one of the channels supported by your machine and is not set to "Auto" or "Automatic". For more information about changing the channel setting, see the instructions supplied with your wireless LAN access point/router.</li> <li>3. Try to connect your machine to your Wi-Fi network again.</li> </ol>	Wireless
Your security settings (SSID/ password) are not correct.	<ul style="list-style-type: none"> <li>• Confirm the SSID and password.                             <ul style="list-style-type: none"> <li>- When you are configuring the network manually, the SSID and password are displayed on your Brother machine. If your mobile device supports the manual configuration, the SSID</li> </ul> </li> </ul>	Wi-Fi Direct



Cause	Action	Interface
	and password will be displayed on your mobile device's screen.	
You are using Android™ 4.0.	If your mobile device disconnects (approximately six minutes after using Wi-Fi Direct), try the one-push configuration using WPS (recommended) and set the Brother machine as a Group Owner.	Wi-Fi Direct
Your Brother machine is placed too far from your mobile device.	Move your Brother machine within about 3.3 feet (1 metre) of the mobile device when you configure the Wi-Fi Direct network settings.	Wi-Fi Direct
There are some obstructions (walls or furniture, for example) between your machine and the mobile device.	Move your Brother machine to an obstruction-free area.	Wi-Fi Direct
There is a wireless computer, Bluetooth®-supported device, microwave oven, or digital cordless phone near the Brother machine or the mobile device.	Move other devices away from the Brother machine or the mobile device.	Wi-Fi Direct
You have checked and tried all of the above, but your Brother machine still cannot complete the Wi-Fi Direct configuration.	<ul style="list-style-type: none"> <li>• Turn your Brother machine off and back on. Then, try to configure the Wi-Fi Direct settings again.</li> <li>• If you are using your Brother machine as a client, confirm how many devices are allowed in the current Wi-Fi Direct network, and then check how many devices are connected.</li> </ul>	Wi-Fi Direct

#### For Windows

If your wireless connection has been interrupted, and you have checked and tried all of the above, we recommend using the Network Connection Repair Tool.

### My Brother Machine Cannot Print, Scan, or PC-FAX Receive over the Network

Cause	Action	Interface
Your security software blocks your machine's access to the network. (The Network scanning feature does not work.)	<ul style="list-style-type: none"> <li>• Windows Configure the third-party Security/Firewall Software to allow Network scanning. To add port 54925 for Network scanning, type the information below: <ul style="list-style-type: none"> <li>- In <b>Name</b>: Type any description, for example Brother NetScan.</li> <li>- In <b>Port number</b>: Type 54925. Type 137. Type 161.</li> <li>- In <b>Protocol</b>: UDP is selected.</li> </ul> See the instruction manual that came with your third-party Security/Firewall Software or contact the software manufacturer.</li> <li>• Mac (Brother iPrint&amp;Scan) In the <b>Finder</b> menu bar, click <b>Go &gt; Applications</b>, and then double-click the Brother iPrint&amp;Scan icon. The Brother iPrint&amp;Scan window appears. Click the <b>Select your Machine</b> button, and then follow the on-screen instructions to reselect your network machine.</li> </ul>	Wired/Wireless
Your security software blocks your machine's	Set the third-party Security/Firewall Software to allow PC-FAX Rx. To add port 54926 for Network PC-FAX Rx, type the information below:	Wired/Wireless

Cause	Action	Interface
<p>access to the network. (The network PC-Fax Receive feature does not work.) (Windows)</p>	<ul style="list-style-type: none"> <li>• <b>In Name:</b> Type any description, for example Brother PC-FAX Rx.</li> <li>• <b>In Port number:</b> Type 54926.</li> <li>• <b>In Protocol:</b> UDP is selected.</li> </ul> <p>See the instruction manual that came with your third-party Security/Firewall Software or contact the software manufacturer.</p>	
<p>Your security software blocks your machine's access to the network.</p>	<p>Some security software might block access without showing a security alert dialog box even after successful installation.</p> <p>To allow access, see the instructions for your security software or ask the software manufacturer.</p>	Wired/Wireless
<p>Your Brother machine was not assigned an available IP address.</p>	<ul style="list-style-type: none"> <li>• Confirm the IP address and the Subnet Mask. Verify that both the IP addresses and Subnet Masks of your computer and the Brother machine are correct and located on the same network. For more information about how to verify the IP address and the Subnet Mask, ask your network administrator.</li> <li>• Windows Confirm the IP address and the Subnet Mask using the Network Connection Repair Tool.</li> <li>• Mac Check your network devices using the ping command. For more information on how to confirm your network settings, see <i>Related Information: Check Network Devices Using the Ping Command</i>.</li> </ul>	Wired/Wireless
<p>The failed print job is still in your computer's print queue.</p>	<ul style="list-style-type: none"> <li>• If the failed print job is still in your computer's print queue, delete it.</li> <li>• Otherwise, double-click the printer icon in the following folder and cancel all documents: <ul style="list-style-type: none"> <li>- Windows 10, Windows Server 2016, and Windows Server 2019 Click  &gt; <b>Windows System</b> &gt; <b>Control Panel</b>. In the <b>Hardware and Sound</b> group, click <b>View devices and printers</b>.</li> <li>- Windows 8.1 Move your mouse to the lower right corner of your desktop. When the menu bar appears, click <b>Settings</b> &gt; <b>Control Panel</b>. In the <b>Hardware and Sound</b> group, click <b>View devices and printers</b>.</li> <li>- Windows Server 2012 R2 Click <b>Control Panel</b> on the <b>Start</b> screen. In the <b>Hardware</b> group, click <b>View devices and printers</b>.</li> <li>- Windows Server 2012 Move your mouse to the lower right corner of your desktop. When the menu bar appears, click <b>Settings</b> &gt; <b>Control Panel</b>. In the <b>Hardware</b> group, click <b>View devices and printers</b> &gt; <b>Printers</b>.</li> <li>- Windows 7 Click  (<b>Start</b>) &gt; <b>Devices and Printers</b>.</li> <li>- Windows Server 2008 Click <b>Start</b> &gt; <b>Control Panel</b> &gt; <b>Printers</b>.</li> <li>- Mac Click <b>System Preferences</b> &gt; <b>Printers &amp; Scanners</b>.</li> </ul> </li> </ul>	Wired/Wireless

Cause	Action	Interface
Your Brother machine is not connected to the wireless network.	Print the WLAN Report to check the error code on the printed report.	Wireless

If you have checked and tried all of the above, but your Brother machine still cannot print and scan, uninstall the drivers (Windows) and the Brother software and reinstall the latest version of both.

## I Want to Check that My Network Devices are Working Correctly

Check	Action	Interface
Check that your Brother machine, access point/router, or network hub is turned on.	<p><b>Check the following:</b></p> <ul style="list-style-type: none"> <li>The power cord is connected correctly and the Brother machine is turned on.</li> <li>The access point/router or hub is turned on and its link indicator is blinking.</li> <li>All protective packaging has been removed from the machine.</li> <li>The ink cartridges are installed correctly.</li> <li>The Scanner Cover and the Jam Clear Cover are fully closed.</li> <li>Paper is inserted correctly in the paper tray.</li> <li>(For wired networks) A network cable is securely connected to the Brother machine and to the router or hub.</li> </ul>	Wired/Wireless
Check that you can "ping" the Brother machine from your computer.	<p>Ping the Brother machine from your computer using the IP address or the node name in the Windows command prompt or Mac Terminal application:</p> <p>ping &lt;ipaddress&gt; or &lt;nodename&gt;.</p> <ul style="list-style-type: none"> <li>Successful: Your Brother machine is working correctly and connected to the same network as your computer.</li> <li>Unsuccessful: Your Brother machine is not connected to the same network as your computer.</li> </ul> <p>Windows: Ask your administrator about the IP address and the subnet mask, and then use the Network Connection Repair Tool.</p> <p>Mac: Confirm that the IP address and the Subnet Mask are set correctly.</p>	Wired/Wireless
Check that your Brother machine is connected to the wireless network.	Print the WLAN Report to check the error code on the printed report.	Wireless

If you have checked and tried all of the above but you are still having problems, see the instructions supplied with your wireless LAN access point/router to find the SSID (Network Name) and the Network Key (Password) information and set them correctly.

### Related Information

- [Network Problems](#)
  - [Check Network Devices Using the Ping Command](#)

#### Related Topics:



- [Configure Your Machine for a Wireless Network When the SSID is Not Broadcast](#)
- [Use Wi-Fi Direct®](#)
- [Print the WLAN Report](#)
- [Wireless LAN Report Error Codes](#)
- [Print the Network Configuration Report](#)
- [Use the Network Connection Repair Tool \(Windows\)](#)

## Check Network Devices Using the Ping Command

Check the IP addresses of both your computer and your Brother machine, and then confirm whether the network is operating correctly.

- >> [Configure the IP Address on your computer \(Windows\)](#)
- >> [Configure the IP Address on your computer \(Mac\)](#)
- >> [Configure the IP Address on your Brother machine](#)

### Configure the IP Address on your computer (Windows)

- Do one of the following:
  - Windows 10  
Click  > **Windows System** > **Command Prompt**.
  - Windows 8.1  
Move your mouse to the lower right corner of your desktop. When the menu bar appears, click **Search** > **Command Prompt**.
  - Windows7  
Click  (**Start**) > **All Programs** > **Accessories** > **Command Prompt**.
- Type "ipconfig" and then press the Enter key on your keyboard.
- Confirm the values for the IPv4 address and subnet mask.
- Type "exit" and then press the Enter key on your keyboard.

### Configure the IP Address on your computer (Mac)

- Select **System Preferences** from the Apple menu.
- Click **Network** > **Advanced** > **TCP/IP**.
- Confirm the values for the IPv4 address and subnet mask.

### Configure the IP Address on your Brother machine

Print the Network Configuration Report, and confirm the values for the IP address and subnet mask.

Check the IP addresses for both your computer and your Brother machine. Confirm that the network address portions are the same. For example, if the subnet mask is "255.255.255.0", it is normal for only the host address portions to be different.

	Network Address	Host Address	
IP Address	192.168.100.	250	Set the final number, which corresponds to "0" in the subnet mask, to 1–254.
Subnet Mask	255.255.255.	0	Usually, there are no problems when the subnet mask is "255.255.255.0". Use the same value for all of your computers.

### Related Information

- [If You Are Having Difficulty with Your Machine's Network](#)

## AirPrint Problems

Difficulty	Suggestions
My machine is not displayed in the printer list.	Make sure your machine is turned on.
	Confirm the network settings.
	Move the mobile device closer to the wireless access point/router, or to your machine.
I cannot print.	Make sure your machine is turned on.
	Confirm the network settings.
I am trying to print a multiple-page document from an iOS device, but ONLY the first page is printing.	Make sure you are running the latest OS version.



### Related Information

- [If You Are Having Difficulty with Your Machine](#)

#### Related Topics:

- [Troubleshooting](#)

## Check the Machine Information

Follow these instructions to check your machine's serial number, firmware version, and firmware update.

1. Press  [Settings] > [All Settings] > [Machine Info.].
2. Press one of the following options:

Option	Description
Serial No.	Check your machine's serial number.
Firmware Version	Check your machine's firmware version.
Firmware Update	Update your machine to the latest firmware. The machine prompts you for a password. <sup>1</sup>
Firmware Auto Check	View firmware information on the Home screen.
Page Counter	Check the total number of pages the machine has printed.

<sup>1</sup> The default password to manage this machine's settings is located on the back of the machine and marked "Pwd".

3. Press .

### Related Information

- [Troubleshooting](#)

## Reset Your Machine

1. Press  [Settings] > [All Settings] > [Initial Setup] > [Reset].
2. Press the reset option you want to use.
3. Press [OK] for two seconds to reboot the machine.
4. Wait until the machine restarts and the Power LED indicator lights up before disconnecting the machine from the power source.



### Related Information

- [Troubleshooting](#)
  - [Reset Functions Overview](#)

#### Related Topics:

- [Transfer Your Faxes or Fax Journal Report](#)
-

## Reset Functions Overview

The following reset functions are available:

1. [Machine Reset]

You can reset all the machine's settings that you have changed.

The Address Book, Fax Reports, and Call History will remain.

2. [Network]

Reset the print server back to its default factory settings (includes Password and IP Address information).

3. [Address Book & Fax]

Address Book & Fax resets the following settings:

- Address Book and Setup Groups
- Programmed fax jobs in the memory  
Delayed Fax and Delayed Batch Transmission
- Station ID  
Name and Number
- Memory Receive Options  
Fax Forwarding
- Report  
Transmission Verification Report, Address Book and Fax Journal
- History  
Caller ID History <sup>1</sup> and Outgoing Call
- Faxes in memory

4. [All Settings]

Use this reset function to reset all of the machine's settings to the settings originally set at the factory.

We strongly recommend you perform this operation when you dispose of the machine.



Unplug the interface cable before you select [Network] or [All Settings].



### Related Information

- [Reset Your Machine](#)

#### Related Topics:

- [Transfer Your Faxes or Fax Journal Report](#)

<sup>1</sup> (Not available for Taiwan and some countries)

## Routine Maintenance

- [Replace the Ink Cartridges](#)
- [Clean Your Brother Machine](#)
- [Check Your Brother Machine](#)
- [Correct the Paper Feed to Clear Vertical Lines](#)
- [Change the Print Options to Improve Your Print Results](#)
- [Pack and Ship Your Machine](#)

## Replace the Ink Cartridges

Your Brother machine is equipped with an ink dot counter. The ink dot counter automatically monitors the level of ink in each of the four ink cartridges. When the machine detects that an ink cartridge is running out of ink, the machine will display a message.

The LCD displays which ink cartridge needs replacing. Be sure to follow the LCD prompts to replace the ink cartridges in the correct order.

Even though the machine tells you to replace an ink cartridge, there will be a small amount of ink left in the ink cartridge. (MFC-J3540DW/MFC-J3940DW/MFC-J6540DW/MFC-J6740DW/MFC-J6940DW) It is necessary to keep some ink in the ink cartridge to prevent air from drying out and damaging the print head assembly.

### **CAUTION**

If the ink gets into your eye, rinse it with water immediately. If left as is, it may cause redness or mild inflammation of the eye. In case of any abnormality, consult with your doctor.

### **IMPORTANT**

Brother strongly recommends that you do not refill the ink cartridges provided with your machine. We also strongly recommend that you continue to use only Brother Original replacement ink cartridges. Use or attempted use of potentially incompatible ink and/or cartridges in the Brother machine may cause damage to the machine and/or may result in unsatisfactory print quality. Our warranty coverage does not apply to any problem that is caused by the use of unauthorised third-party ink and/or cartridges. To protect your investment and obtain premium performance from the Brother machine, we strongly recommend the use of Brother Original ink cartridges.

1. Open the ink cartridge cover (1).

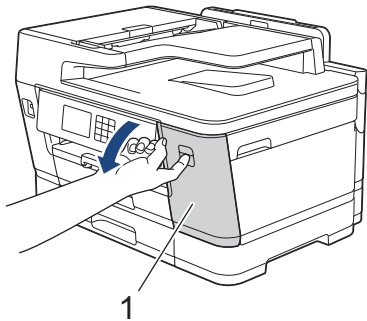

2. Press the lock release lever to release the ink cartridge colour indicated on the LCD and remove the ink cartridge from the machine, as shown in the illustration.

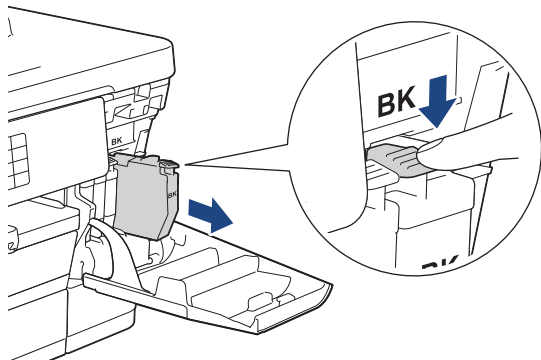

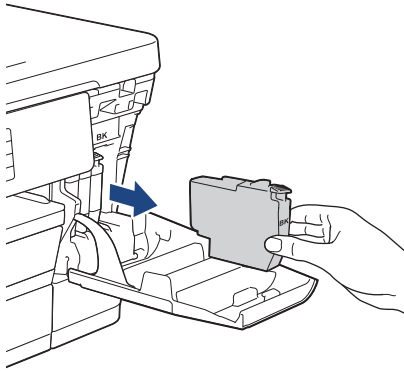

- Open the new ink cartridge bag for the colour indicated on the LCD, and take out the ink cartridge.

## IMPORTANT

- DO NOT touch the ink cartridge in the area indicated (1); this can prevent the machine from detecting the cartridge.

(MFC-J3540DW/MFC-J3940DW/MFC-J6540DW/  
MFC-J6740DW/MFC-J6940DW)

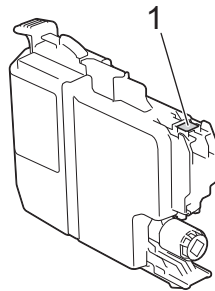

(MFC-J6555DW/MFC-J6955DW/MFC-J6957DW)

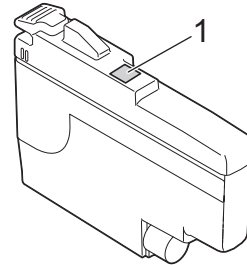

- Quickly shake just the **black** ink cartridge horizontally 15 times as shown, before inserting it into the machine.

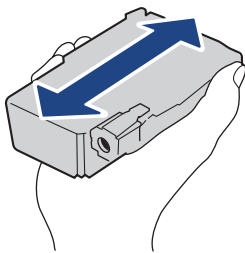

- Insert the ink cartridge in the direction of the arrow on the label.

Each colour has its own correct position.

(MFC-J3540DW/MFC-J3940DW/MFC-J6540DW/  
MFC-J6740DW/MFC-J6940DW)

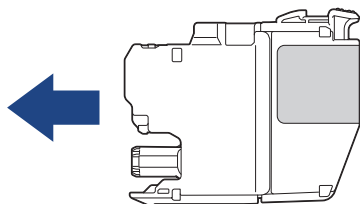

(MFC-J6555DW/MFC-J6955DW/MFC-J6957DW)

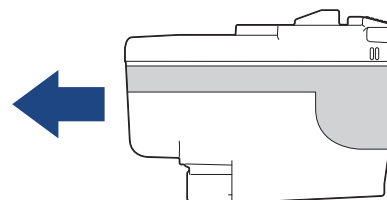

- Gently push the area marked "PUSH" until the ink cartridge locks into place, and then close the ink cartridge cover.

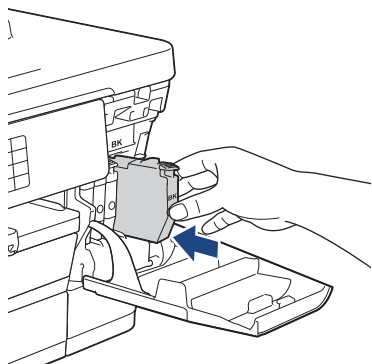

The machine resets the ink dot counter.



If the machine does not detect the ink cartridge after you install it, check that the ink cartridge is installed correctly. Remove the ink cartridge and reinstall it slowly until it locks into place.

## IMPORTANT

- DO NOT shake the ink cartridges, once installed into the machine. If ink stains your skin or clothing, wash with soap or detergent at once.
- DO NOT remove ink cartridges if you do not need to replace them; otherwise, the machine will not know the ink quantity left in the cartridge.
- DO NOT touch the ink cartridge insertion slots; the ink may stain your skin.
- If you mix the colours by installing an ink cartridge in the wrong position, the LCD shows [Wrong Ink Colour].  
Check which ink cartridges are not matched by colour to their ink cartridge positions and move them to their correct positions.
- Use unopened ink cartridges by the expiration date written on the ink cartridge package.
- DO NOT dismantle or tamper with the ink cartridge; this can cause the ink to leak out of the ink cartridge.



## Related Information

- [Routine Maintenance](#)

### Related Topics:

- [Error and Maintenance Messages](#)
- [Paper Handling and Printing Problems](#)
- [Pack and Ship Your Machine](#)

## Clean Your Brother Machine

- [Clean the Print Head from Your Brother Machine](#)
- [Clean the Print Head Using Web Based Management](#)
- [Clean the Print Head from Your Computer \(Windows\)](#)
- [Automatically Detect and Improve the Condition of Print Head Nozzles](#)
- [Clean the Scanner](#)
- [Clean the ADF Document Sensor](#)
- [Clean the Machine's LCD](#)
- [Clean the Outside of the Machine](#)
- [Clean the Machine's Printer Platen](#)
- [Clean the Paper Feed Rollers](#)
- [Clean the Base Pad](#)
- [Clean the Paper Pick-up Rollers for Paper Tray #1](#)
- [Clean the Paper Pick-up Rollers for Paper Tray #2 and Paper Tray #3](#)

## Clean the Print Head from Your Brother Machine

To maintain good print quality, the machine automatically cleans the print head when needed. If there is a print quality problem, start the cleaning process manually.

- Clean the print head if there is a horizontal line or a blank space in the text or graphics on printed pages.
- Cleaning the print head consumes ink.
- Cleaning too often uses ink unnecessarily.



### IMPORTANT

DO NOT touch the print head. Touching the print head may cause permanent damage and may void the print head's warranty.

1. Press  [Ink] > [Print Head Cleaning].
2. Press [Start].  
The machine cleans the print head.

### NOTE

If you clean the print head several times and the print has not improved, try the Special cleaning method. The Special cleaning method uses the most power in cleaning the print head, but also consumes the most ink.

1. Press  [Ink] > [Print Head Cleaning].
2. Press  for five seconds.  
The machine starts cleaning.



- The Special cleaning method requires a large amount of ink to clean the print head.
- Use the Special cleaning method only if you previously cleaned the print head several times and the print quality did not improve.
- You can also clean the print head from your computer.



### Related Information

- [Clean Your Brother Machine](#)

#### Related Topics:

- [Paper Handling and Printing Problems](#)
- [Clean the Print Head from Your Computer \(Windows\)](#)
- [Clean the Print Head Using Web Based Management](#)

## Clean the Print Head Using Web Based Management

To maintain good print quality, the machine automatically cleans the print head when needed. If there is a print quality problem, start the cleaning process manually.

1. Start your web browser.
2. Type "https://machine's IP address" in your browser's address bar (where "machine's IP address" is the machine's IP address).

For example:

https://192.168.1.2

3. If required, type the password in the **Login** field, and then click **Login**.



The default password to manage this machine's settings is located on the back of the machine and marked "Pwd".

4. Go to the navigation menu, and then click **General > Print Head Cleaning**.



Start from ☰, if the navigation menu is not shown on the left side of the screen.

5. If you have print quality problems, try cleaning the print head several times. If the print quality does not improve, use the **Special** option. The **Special** option uses the most power in cleaning the print head, but also consumes the most ink.
6. Click **Start**.



- The **Special** option requires a large amount of ink to clean the print head.

7. Click **Yes**.

The machine starts cleaning.



(Windows) You can also clean the print head using the printer driver.



### Related Information

- [Clean Your Brother Machine](#)

#### Related Topics:

- [Paper Handling and Printing Problems](#)
- [Access Web Based Management](#)
- [Clean the Print Head from Your Brother Machine](#)
- [Clean the Print Head from Your Computer \(Windows\)](#)

## Clean the Print Head from Your Computer (Windows)

To maintain good print quality, the machine automatically cleans the print head when needed. If there is a print quality problem, start the cleaning process manually.

1. Do one of the following:

- For Windows 10, Windows Server 2016, and Windows Server 2019

Click  > **Windows System** > **Control Panel**. In the **Hardware and Sound** group, click **View devices and printers**.

- For Windows 8.1

Move your mouse to the lower right corner of your desktop. When the menu bar appears, click **Settings**, and then click **Control Panel**. In the **Hardware and Sound** group, click **View devices and printers**.

- For Windows Server 2012 R2

Click **Control Panel** on the **Start** screen. In the **Hardware** group, click **View devices and printers**.

- For Windows Server 2012

Move your mouse to the lower right corner of your desktop. When the menu bar appears, click **Settings**, and then click **Control Panel**. In the **Hardware** group, click **View devices and printers**.

- For Windows 7 and Windows Server 2008 R2

Click  (**Start**) > **Devices and Printers**.

- For Windows Server 2008

Click  (**Start**) > **Control Panel** > **Hardware and Sound** > **Printers**.

2. Right-click the **Brother XXX-XXXX Printer** icon (where XXX-XXXX is the name of your model), and then select **Printing preferences**. If printer driver options appear, select your printer driver.

The printer driver dialog box appears.

3. Click the **Maintenance** tab.

4. Select one of the following options:

Option	Description
<b>Check Print Quality...</b>	Use to print the test page and check the print quality.
<b>Print Head Cleaning...</b>	Use to start the cleaning process manually. Select if a line or blank spaces appear in text or graphics on the test page.

5. Click **Start**.

### Related Information



- [Clean Your Brother Machine](#)

#### Related Topics:

- [Paper Handling and Printing Problems](#)
- [Clean the Print Head from Your Brother Machine](#)
- [Clean the Print Head Using Web Based Management](#)

## Automatically Detect and Improve the Condition of Print Head Nozzles

If faded or streaked colours and text appear or if text is missing on your printouts, the print head nozzles may be clogged. When this setting is [On], the machine automatically detects the condition of the print head nozzles and cleans the print head when needed.

- The default setting is [On].
  - Cleaning the print head consumes ink.
1. Press  [Ink] > [Print Quality Auto Check].
  2. Press [On] or [Off].
  3. Press .

### Related Information

- [Clean Your Brother Machine](#)

## Clean the Scanner

1. Unplug the machine from the electrical socket.
2. Lift the document cover (1). Clean the scanner glass (2) and the white plastic (3) with a soft lint-free cloth moistened with water.

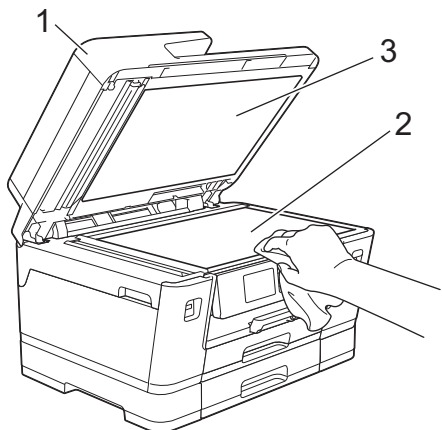

3. In the ADF unit, clean the white bar (1) and the glass strip (2) with a lint-free cloth moistened with water.

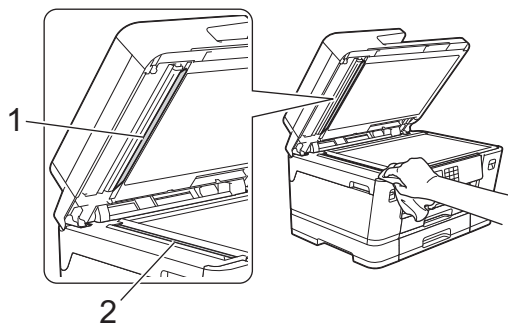

4. (MFC-J3940DW/MFC-J6940DW/MFC-J6955DW/MFC-J6957DW) Open the scanner glass cover (1), and clean the white bar (2) and the glass strip (3) with a soft lint-free cloth moistened with water.

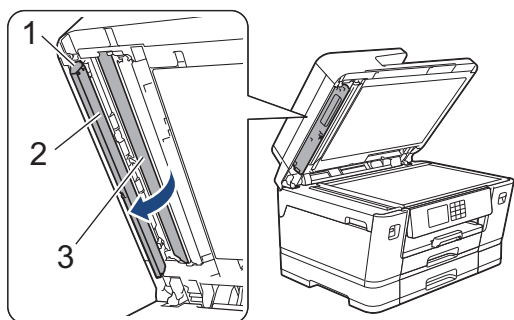



If you feel dirt or debris, clean the glass again. You may need to repeat the cleaning process three or four times. To test, make a copy after each cleaning attempt.



When there is a spot of dirt or correction fluid on the glass strip, the printed sample shows a vertical line.



After the glass strip is cleaned, the vertical line is gone.

---



### Related Information

- [Clean Your Brother Machine](#)

#### Related Topics:

- [Telephone and Fax Problems](#)
  - [Other Problems](#)
-

## Clean the ADF Document Sensor

**Related Models:** MFC-J6555DW/MFC-J6955DW/MFC-J6957DW

Cleaning the ADF document sensor periodically may prevent the machine from detecting the wrong document size.

1. Clean the ADF document sensor (1) with a dry, soft lint-free cloth.

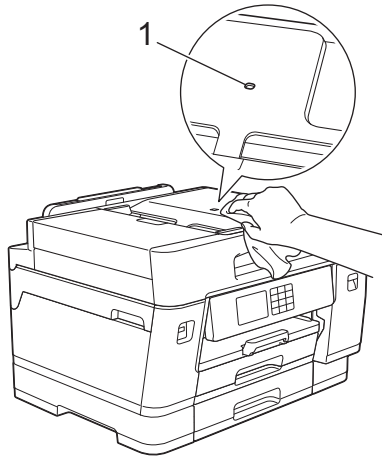

### Related Information

- [Clean Your Brother Machine](#)

#### Related Topics:

- [Telephone and Fax Problems](#)
- [Other Problems](#)

## Clean the Machine's LCD

### IMPORTANT

DO NOT use liquid cleaners (including ethanol).

1. Press and hold down  to turn off the machine. The LCD displays [Shutting Down] for a few seconds before the power goes off.
2. Clean the LCD with a dry, soft lint-free cloth.

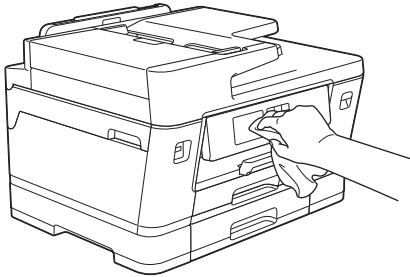

### ✓ Related Information

- [Clean Your Brother Machine](#)

## Clean the Outside of the Machine

### IMPORTANT

- Cleaning with volatile liquids such as thinner or benzine will damage the outside surface of the machine.
- DO NOT use cleaning materials that contain ammonia.
- DO NOT use isopropyl alcohol to remove dirt from the control panel. It may crack the panel.

1. If the paper support flap is open, close it, and then close the paper support.
2. Pull the paper trays (1) completely out of the machine as shown by the arrow.

- Tray #1

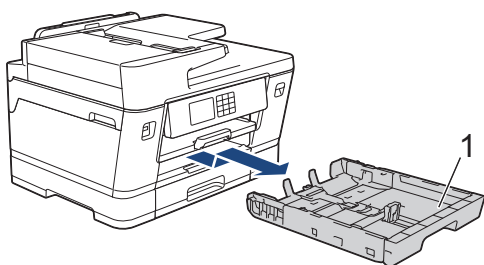

- Tray #2 (MFC-J3940DW/MFC-J6740DW/MFC-J6940DW/MFC-J6955DW/MFC-J6957DW)

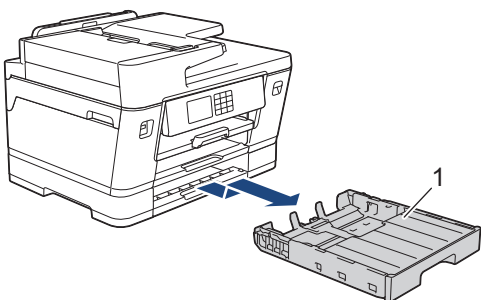

- Tray #3 (MFC-J6957DW)

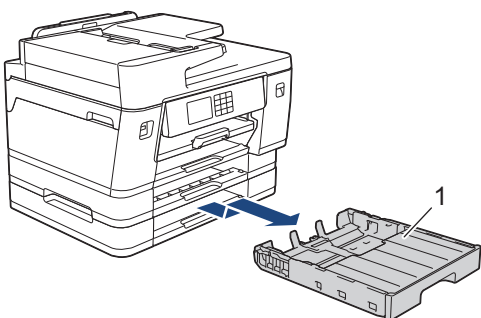

3. Lift the paper support (1), and then pull it at an angle completely out of the machine as shown by the arrow.

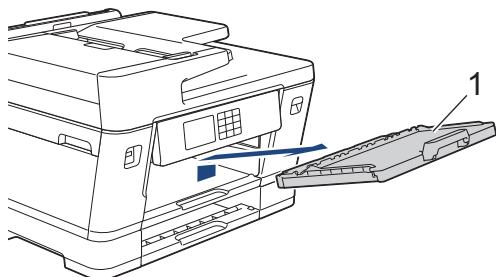

4. Wipe the outside of the machine with a dry, lint-free cloth to remove dust.

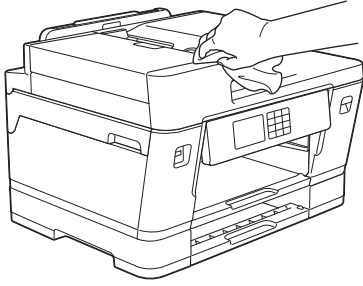

5. Remove anything that is stuck inside the paper tray. Wipe the inside and the outside of the paper tray with a dry, lint-free cloth to remove dust.

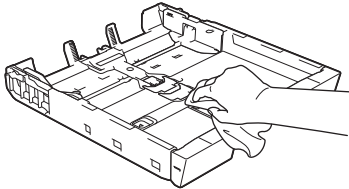

6. Wipe the outside of the paper support with a dry, lint-free cloth to remove dust.

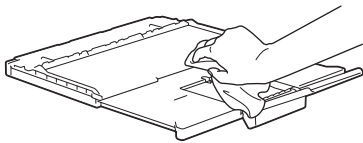

7. Place the paper support firmly back in the machine. Make sure you fit the paper support into the channels.

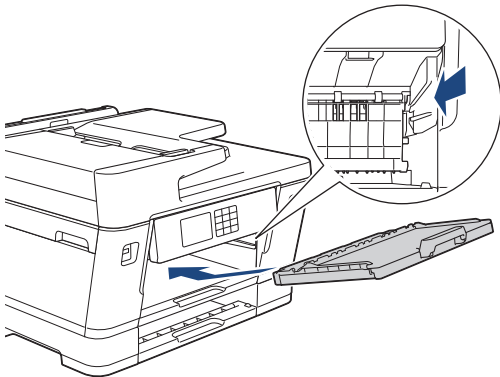

8. Slowly push the paper tray completely into the machine.

### Related Information

- [Clean Your Brother Machine](#)

## Clean the Machine's Printer Platen

### WARNING

 Be sure to unplug the machine from the electrical socket before cleaning the printer platen to avoid an electrical shock.

1. Using both hands, use the finger holds on each side of the machine to lift the scanner cover into the open position.
2. Clean the machine's printer platen (1) and the area around it, wiping off scattered ink with a dry, soft lint-free cloth.

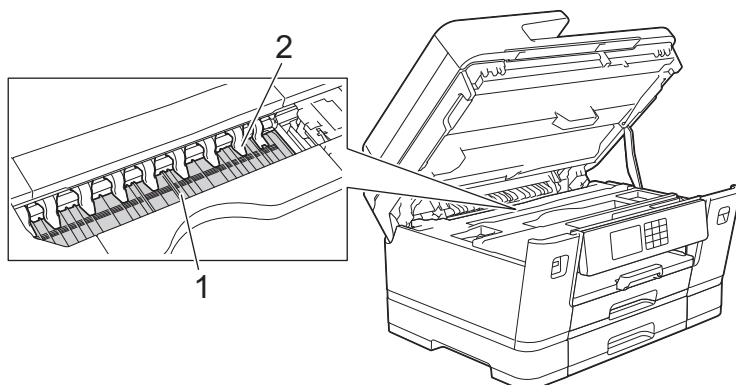

### IMPORTANT

DO NOT bend or apply too much pressure on the nine tabs (2). They could be damaged.

3. Gently close the scanner cover using the finger holds on each side.

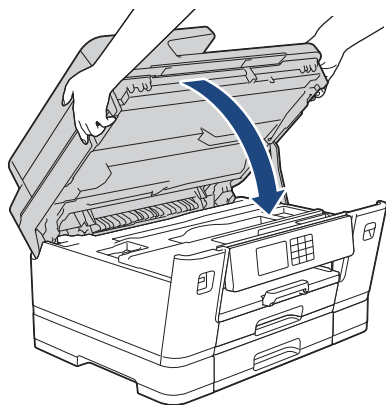

4. Reconnect the power cord.

### Related Information

- [Clean Your Brother Machine](#)

#### Related Topics:

- [Paper Handling and Printing Problems](#)

## Clean the Paper Feed Rollers

If the paper feed rollers are stained with ink or have a buildup of paper dust, it may cause paper feed problems.

1. Unplug the machine from the electrical socket.
2. If the paper support flap is open, close it, and then close the paper support.
3. Pull the paper tray (1) completely out of the machine as shown by the arrow.

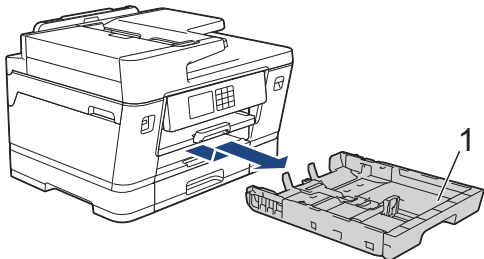

4. Lift the paper support (1), and then pull it at an angle completely out of the machine as shown by the arrow.

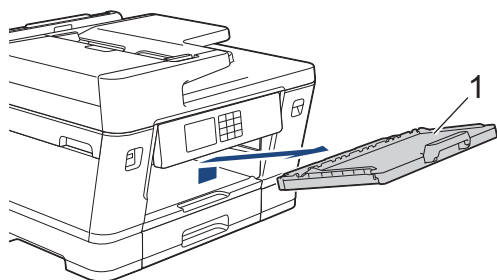

5. Clean the front side of the Paper Feed Rollers (1) with a soft lint-free cloth moistened with water, using a side-to-side motion. After cleaning, wipe the rollers with a dry, soft lint-free cloth to remove all moisture.

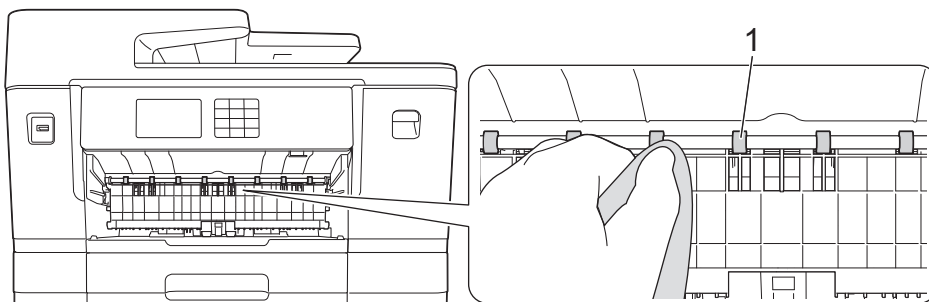

6. Lift the flap (2), and then clean the back side of the Paper Feed Rollers (1) with a soft lint-free cloth moistened with water. After cleaning, wipe the rollers with a dry, soft lint-free cloth to remove all moisture.

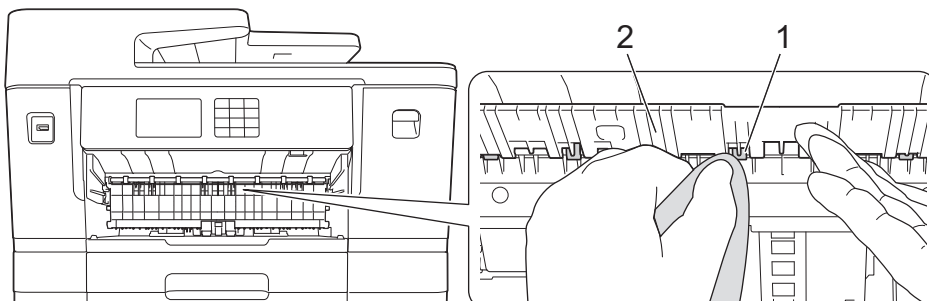

7. Place the paper support firmly back in the machine. Make sure you fit the paper support into the channels.

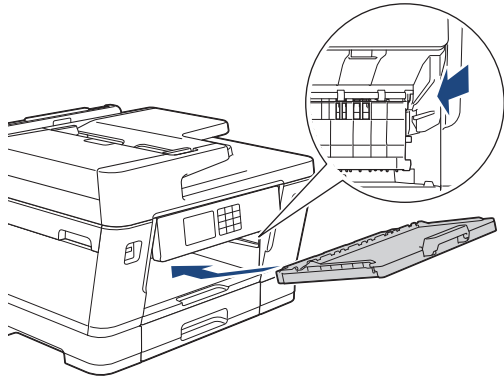

8. Slowly push the paper tray completely into the machine.
9. Reconnect the power cord.



---

Do not use the machine again until the rollers are dry. Using the machine before the rollers are dry may cause paper feed problems.

---



### Related Information

- [Clean Your Brother Machine](#)

#### Related Topics:

- [Paper Handling and Printing Problems](#)
-

## Clean the Base Pad

Cleaning the Base Pad periodically may prevent the machine from feeding multiple sheets of paper when there are only a few sheets of paper left in the tray.

1. If the paper support flap is open, close it, and then close the paper support.
2. Pull the paper trays (1) completely out of the machine as shown by the arrow.
  - Tray #1

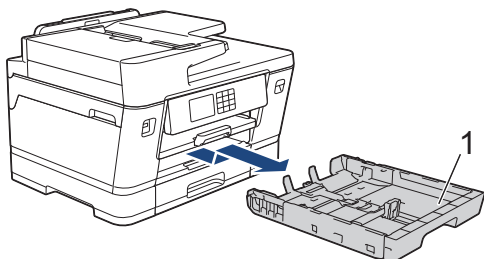

- Tray #2 (MFC-J3940DW/MFC-J6740DW/MFC-J6940DW/MFC-J6955DW/MFC-J6957DW)

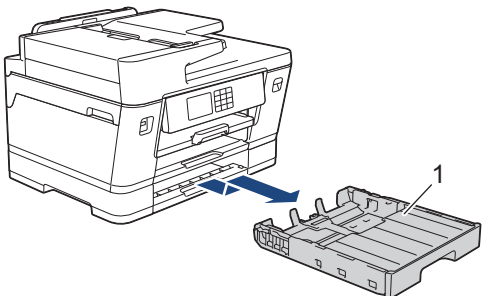

- Tray #3 (MFC-J6957DW)

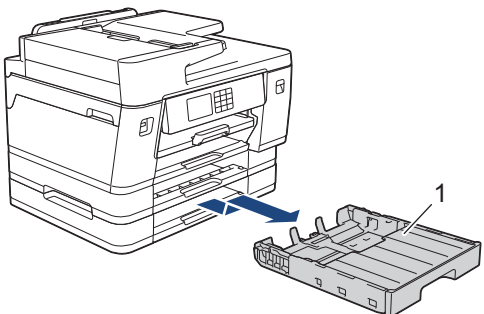

3. Clean the Base Pad (1) with a soft lint-free cloth moistened with water.  
After cleaning, wipe the pad with a dry, soft lint-free cloth to remove any moisture.

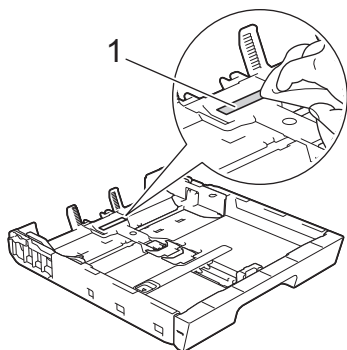

4. Slowly push the paper tray completely into the machine.



### Related Information

- [Clean Your Brother Machine](#)

---

**Related Topics:**

- [Paper Handling and Printing Problems](#)
-

## Clean the Paper Pick-up Rollers for Paper Tray #1

Cleaning the paper pick-up rollers periodically may prevent paper jams by ensuring that paper feeds correctly.



(For some countries) A Cleaning Kit for Paper Pick-up Rollers is supplied with your machine. Clean the paper pick-up rollers using the kit. For more information, see the instructions provided with the cleaning kit.

1. Unplug the machine from the electrical socket.
2. If the paper support flap is open, close it, and then close the paper support.
3. Pull the paper tray (1) completely out of the machine as shown by the arrow.

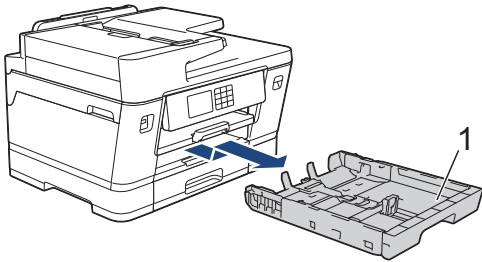

4. Lift the paper support (1), and then pull it at an angle completely out of the machine as shown by the arrow.

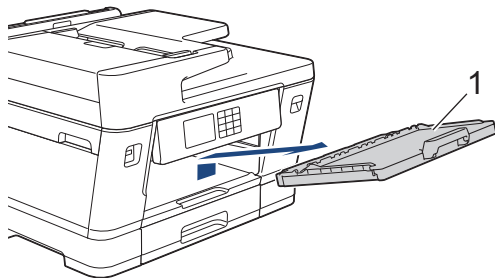

5. Clean the Paper Pick-up Rollers (1) with a soft lint-free cloth moistened with water. Slowly turn the rollers so that the whole surface is cleaned. After cleaning, wipe the rollers with a dry, soft lint-free cloth to remove all moisture.

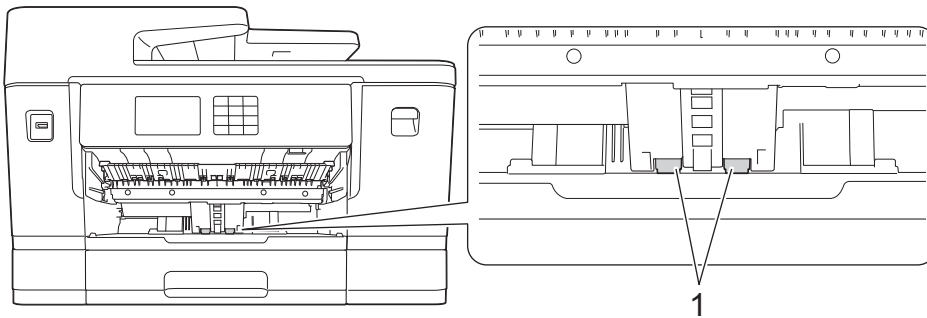

6. Place the paper support firmly back in the machine. Make sure you fit the paper support into the channels.

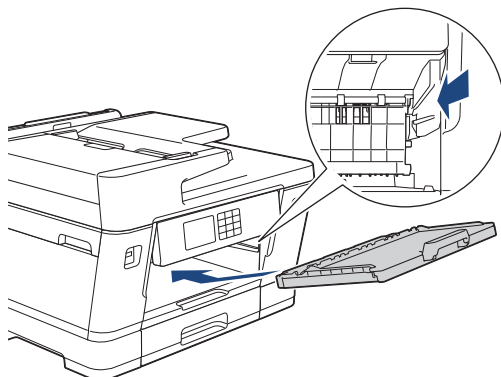

7. Slowly push the paper tray completely into the machine.

---

8. Reconnect the power cord.



### Related Information

- [Clean Your Brother Machine](#)

#### Related Topics:

- [Error and Maintenance Messages](#)
  - [Paper Handling and Printing Problems](#)
-

## Clean the Paper Pick-up Rollers for Paper Tray #2 and Paper Tray #3

**Related Models:** MFC-J3940DW/MFC-J6740DW/MFC-J6940DW/MFC-J6955DW/MFC-J6957DW

These instructions describe how to clean the paper pick-up rollers for Tray #2.

(MFC-J6957DW) The steps for Tray #3 are very similar.



(For some countries) A Cleaning Kit for Paper Pick-up Rollers is supplied with your machine. Clean the paper pick-up rollers using the kit. For more information, see the instructions provided with the cleaning kit.

1. Unplug the machine from the electrical socket.
2. If the paper support flap is open, close it, and then close the paper support.
3. Pull Tray #2 (1) completely out of the machine as shown by the arrow.

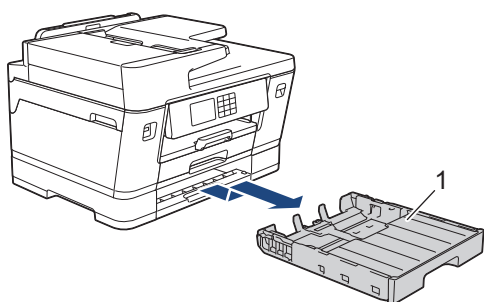

4. Clean the paper pick-up rollers for Tray #2 (1) with a soft lint-free cloth moistened with water. Slowly turn the rollers so that the whole surface is cleaned. After cleaning, wipe the rollers with a dry, soft lint-free cloth to remove all moisture.

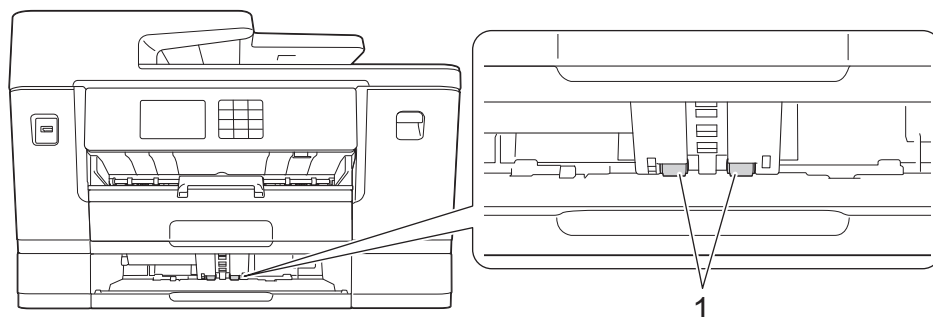

5. Slowly push Tray #2 completely into the machine.
6. Reconnect the power cord.



### Related Information

- [Clean Your Brother Machine](#)

#### Related Topics:



- [Error and Maintenance Messages](#)
- [Paper Handling and Printing Problems](#)

## Check Your Brother Machine

- [Check the Print Quality](#)
- [Check the Print Alignment from Your Brother Machine](#)
- [Check the Ink Volume \(Page Gauge\)](#)
- [Monitor Machine Status from Your Computer \(Windows\)](#)
- [Monitor Machine Status Using Brother iPrint&Scan \(Windows/Mac\)](#)

## Check the Print Quality

If faded or streaked colours and text appear or if text is missing on your printouts, the print head nozzles may be clogged. Print the check sheet and look at the nozzle check pattern.

1. Press  [Ink] > [Improve Print Quality] > [Check Print Quality].
2. Press [Start].  
The machine prints the check sheet.
3. Check the quality of the four colour blocks on the sheet.
4. When an LCD message prompts you to check the print quality, do one of the following:
  - If all lines are clear and visible, press [No], and then press  to finish the Print Quality check.
  - If lines are missing (see **Poor**, as follows), press [Yes].

OK

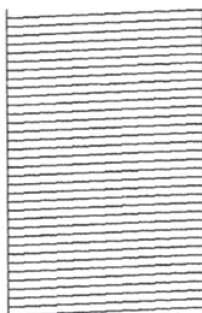

Poor

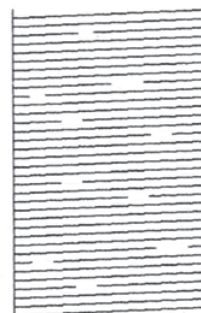

5. When the LCD message prompts you to check the print quality of each colour, press the number of the pattern (1–4) that most closely matches the printing result.
6. Do one of the following:
  - If print head cleaning is needed, press [Start] to start the cleaning procedure.
  - If print head cleaning is not needed, the menu screen reappears on the touchscreen. Press .
7. After the cleaning procedure is finished, the LCD message prompts you to print the check sheet again. Press [Yes], and then press [Start].  
The machine prints the check sheet again. Check the quality of the four colour blocks on the sheet again.

If you clean the print head several times and the print has not improved, try the Special cleaning method. See *Related Information*.

### IMPORTANT

DO NOT touch the print head. Touching the print head may cause permanent damage and may void the print head's warranty.



When a print head nozzle is clogged, the printed sample looks like this:



After the print head nozzle is cleaned, the lines are gone:



### Related Information

- [Check Your Brother Machine](#)

#### **Related Topics:**

- [Paper Handling and Printing Problems](#)
  - [Clean the Print Head from Your Brother Machine](#)
  - [Check the Print Alignment from Your Brother Machine](#)
  - [Correct the Paper Feed to Clear Vertical Lines](#)
-

## Check the Print Alignment from Your Brother Machine

If your printed text becomes blurred or images become faded after transporting the machine, adjust the print alignment.

Before adjusting the print alignment, complete a print quality check first by pressing  [Ink] > [Improve Print Quality] > [Check Print Quality].

1. Press  [Ink] > [Improve Print Quality] > [Alignment].
2. Press [Next].
3. Press [Yes] after a confirmation message if a print quality check has been completed appears on the LCD.
4. Press [Auto] or [Manual].
  - If you select the [Auto] mode, the print alignment is automatically adjusted by scanning the check sheet.
  - If you select the [Manual] mode, you need to input information printed on the check sheet manually.
5. Select the paper size to print the check sheet on.
  - If you selected the [Manual] mode, select either [Basic alignment] or [Advanced alignment] in the following step.
6. Load specified size paper in the tray, and then press [Start].

The machine prints the check sheet.
7. Follow the instructions on the LCD.



When the print alignment is not adjusted correctly, text looks blurry or crooked, like this:

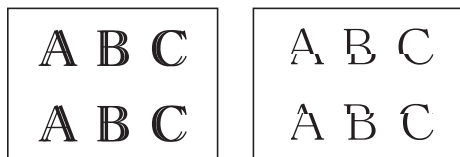

After the print alignment is adjusted correctly, text looks like this:



### Related Information

- [Check Your Brother Machine](#)

#### Related Topics:

- [Paper Handling and Printing Problems](#)

## Check the Ink Volume (Page Gauge)

Although an ink volume icon appears on the machine's LCD, you can view a larger graph that displays the approximate ink remaining in each cartridge.

>> [MFC-J3540DW/MFC-J3940DW/MFC-J6540DW/MFC-J6740DW/MFC-J6940DW](#)

>> [MFC-J6555DW/MFC-J6955DW/MFC-J6957DW](#)

### MFC-J3540DW/MFC-J3940DW/MFC-J6540DW/MFC-J6740DW/MFC-J6940DW

1. Press  [Ink] > [Ink Volume].

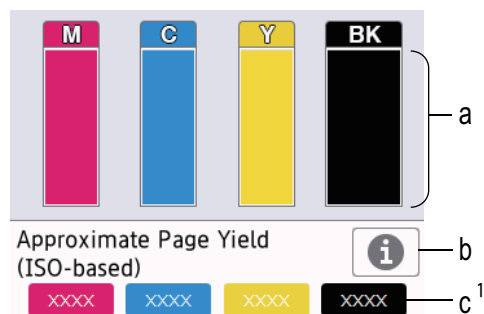

The touchscreen displays the ink volume and the page gauge <sup>1</sup>.



- a. Displays the cartridge ink level.
- b. Press to change the display settings for the approximate page yield.
- c. The page gauge <sup>1</sup> shows the approximate number of remaining pages that can be printed with the cartridges.



- When the ink cartridge is near the end of its life or having a problem, one of the following icons appears:

	The ink level is low.
	The ink cartridge needs to be replaced.
	There is a problem with the ink cartridge.

- To check or print the ink cartridge model numbers, press  (Back) to return to the [Ink] menu screen.

Press [Ink Cartridge Model], and follow the instructions on the touchscreen.

2. Press .



- You can also check the ink volume from your computer.
- For detailed information about the measuring methods used for the approximate yields, visit [support.brother.com/yield](http://support.brother.com/yield).

### MFC-J6555DW/MFC-J6955DW/MFC-J6957DW

1. Press  [Ink] > [Ink Volume].

The touchscreen displays the ink volume and the page gauge <sup>2</sup>.

<sup>1</sup> Page Gauge is an estimate for informational purposes only and does not display the actual remaining page yield. For actual cartridge yield information, visit [support.brother.com/yield](http://support.brother.com/yield).

<sup>2</sup> Page Gauge is an estimate for informational purposes only and does not display the actual remaining page yield. For actual cartridge yield information, visit [support.brother.com/yield](http://support.brother.com/yield).

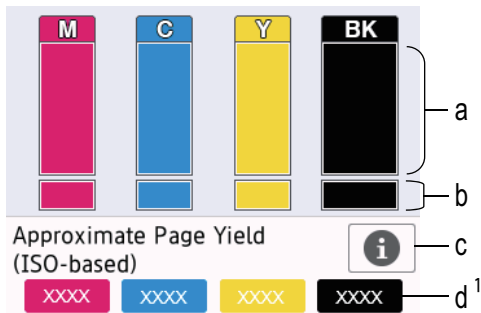

- a. Displays the cartridge ink level.
- b. Displays the ink level remaining in the internal ink reservoir.
- c. Press to change the display settings for the approximate page yield.
- d. The page gauge<sup>2</sup> shows the approximate number of remaining pages that can be printed with the cartridges.



- When the ink cartridge is near the end of its life or having a problem, one of the following icons appears:

	The ink level is low.
	The ink cartridge needs to be replaced.
	There is a problem with the ink cartridge.

- To check or print the ink cartridge model numbers, press (Back) to return to the [Ink] menu screen.

Press [Ink Cartridge Model], and follow the instructions on the touchscreen.

2. Press .



- You can also check the ink volume from your computer.
- For detailed information about the measuring methods used for the approximate yields, visit [support.brother.com/yield](http://support.brother.com/yield).



## Related Information



- [Check Your Brother Machine](#)

### Related Topics:

- [Touchscreen LCD Overview](#)
- [Settings Screen Overview](#)
- [Print a Document \(Windows\)](#)
- [Monitor Machine Status from Your Computer \(Windows\)](#)
- [Monitor Machine Status Using Brother iPrint&Scan \(Windows/Mac\)](#)

## Monitor Machine Status from Your Computer (Windows)

The Status Monitor utility is a configurable software tool for monitoring the status of one or more machines; it allows you to get immediate notification of errors.

- Do one of the following:
  - Double-click the  icon in the task tray.
  - Launch  (**Brother Utilities**), and then click the drop-down list and select your model name (if not already selected). Click **Tools** in the left navigation bar, and then click **Status Monitor**.

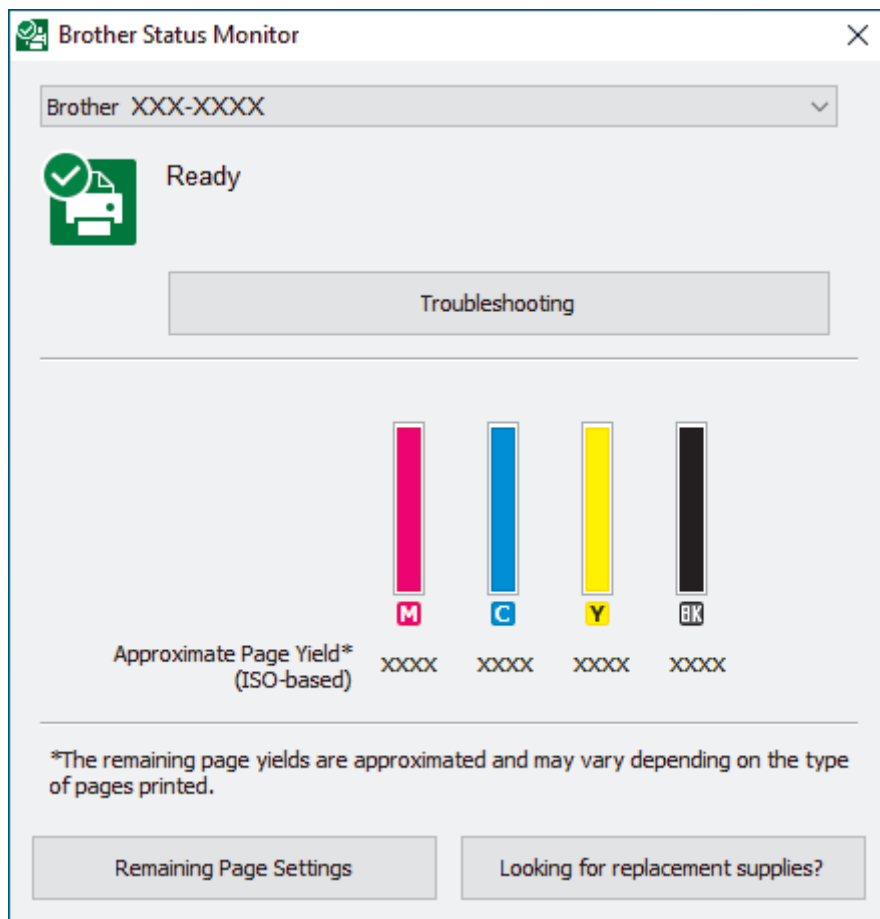

The actual screen may differ from the screen shown above.

### Troubleshooting

Click the **Troubleshooting** button to access the troubleshooting website.



### Remaining Page Settings

Click the **Remaining Page Settings** button to change the display settings for the approximate page yield.

### Looking for replacement supplies?

Click the **Looking for replacement supplies?** button for more information on Brother original supplies.

### Error icons

Icon	Description
	The ink level is low.
	The ink cartridge needs to be replaced.
	There is a problem with the ink cartridge.



- You can also check the ink amount using Web Based Management.

---



## Related Information

---

- [Check Your Brother Machine](#)
  - [Status Monitor Indicators and What They Mean \(Windows\)](#)
  - [Turn Off the Show Status Monitor Feature \(Windows\)](#)
  - [Turn Off the Status Monitor \(Windows\)](#)

### Related Topics:

- [Cancel a Print Job \(Windows\)](#)
  - [Check the Ink Volume \(Page Gauge\)](#)
-

## Status Monitor Indicators and What They Mean (Windows)

When you start up your computer, the **Brother Status Monitor** icon appears on the task tray.

- A green icon indicates the normal stand-by condition.



- A yellow icon indicates a warning.



- A red icon indicates an error has occurred.



- A grey icon indicates the machine is offline.



### Related Information

- [Monitor Machine Status from Your Computer \(Windows\)](#)

## Turn Off the Show Status Monitor Feature (Windows)

The Show Status Monitor feature lets you know if there is a problem with a device that your computer is monitoring. The default setting is **Only when printing from this PC**. To turn it off, follow these steps:

1. Right-click the  (**Brother Status Monitor**) icon or window, select the **Status Monitor Settings** option, and then click **Options**.  
The **Options** window appears.
2. Click the **Show Status Monitor** tab, and then select **Off** for **Status Monitor Display Options**.
3. Click **OK**.



Even if the Show Status Monitor feature is turned off, you can check the machine's status at any time by displaying the Status Monitor.



### Related Information

- [Monitor Machine Status from Your Computer \(Windows\)](#)

## Turn Off the Status Monitor (Windows)

1. Right-click the  (**Brother Status Monitor**) icon or window, and then select **Exit**.
2. Click **OK**.

### Related Information

- [Monitor Machine Status from Your Computer \(Windows\)](#)
-

## Monitor Machine Status Using Brother iPrint&Scan (Windows/Mac)

Brother iPrint&Scan allows you to monitor your Brother machine's status.

1. Start Brother iPrint&Scan.

- Windows

Launch  (Brother iPrint&Scan).

- Mac



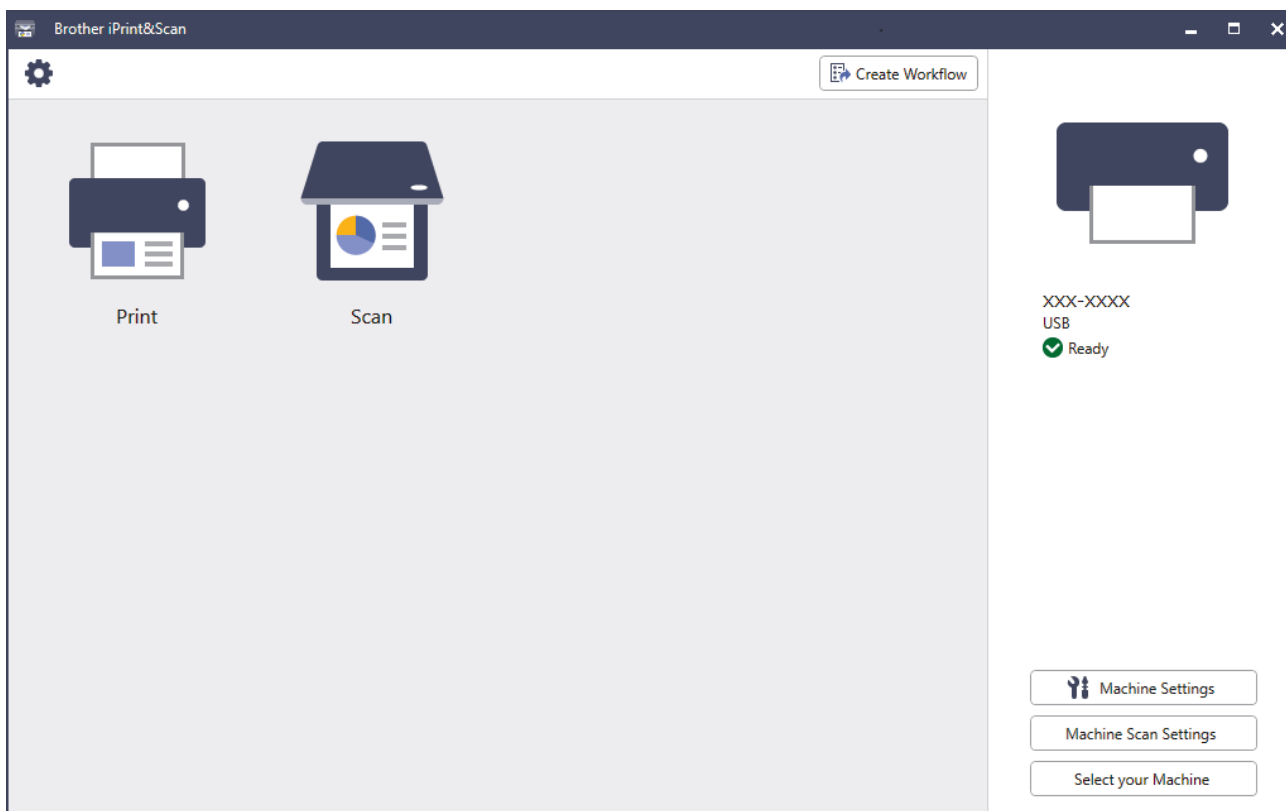

In the **Finder** menu bar, click **Go > Applications**, and then double-click the iPrint&Scan icon.

The Brother iPrint&Scan screen appears.

2. If your Brother machine is not selected, click the **Select your Machine** button, and then select your model name from the list. Click **OK**.





### Status icons

Icon	Description
	A green icon indicates the normal stand-by condition.
	A yellow icon indicates a warning.
	A red icon indicates an error has occurred.
	A grey icon indicates the machine is offline.

---

## Error icons

Icon	Description
	The ink level is low.
	The ink cartridge needs to be replaced.
	There is a problem with the ink cartridge.



- The actual screen may differ depending on the version of the application.
  - The remaining ink amount is approximate and may differ from the actual amount of remaining ink.
  - You can also check the remaining ink amount using Web Based Management.
- 





### Related Information

- [Check Your Brother Machine](#)
-

## Correct the Paper Feed to Clear Vertical Lines

Adjust the paper feed to reduce vertical lines.

Before adjusting the paper feed, complete a print quality check first by pressing  [Ink] > [Improve Print Quality] > [Check Print Quality].

1. Press  [Ink] > [Improve Print Quality] > [Correct Paper Feed].
2. Press [Next].
3. Press [Yes] after a confirmation message if a print quality check has been completed appears on the LCD.
4. Press [Auto] or [Manual].
  - If you select the [Auto] mode, the paper feed is automatically adjusted by scanning the check sheet.
  - If you select the [Manual] mode, you need to input information printed on the check sheet manually.
5. Select the paper size to print the check sheet on.
6. Load specified size paper in the tray, and then press [Start].

The machine prints the check sheet.
7. Follow the instructions on the LCD.



### Related Information

- [Routine Maintenance](#)

#### Related Topics:

- [Paper Handling and Printing Problems](#)

## Change the Print Options to Improve Your Print Results

If your printouts do not look the way you expect, change the print settings on your Brother machine to improve printout quality. Print speed may be slower when using these settings.



- These instructions allow you to improve your print results when you are using your machine for copying or printing from media, or a mobile device.
- If you are experiencing poor print quality when printing from your computer, change the settings in the printer driver or in the application you use to print.

1. Press  [Ink] > [Print Options].

2. Press one of the following options:

Option	Description
Reduce Smudging	Select this option according to your paper type and whether you are using 1-sided or 2-sided printing if you have problems with smudged printouts or paper jams.
Reduce Uneven Lines	Select this option according to your paper size if you have problems with uneven lines.
Enhance Print	Select this option if you have problems with blurred printouts.

3. Follow the LCD menus.

4. Press .



### Related Information

- [Routine Maintenance](#)

#### Related Topics:

- [Paper Handling and Printing Problems](#)
- [Other Problems](#)
- [Prevent Smudged Printouts and Paper Jams \(Windows\)](#)
- [Print Settings \(Windows\)](#)
- [Copy on Both Sides of the Paper \(2-sided Copy\)](#)

## Pack and Ship Your Machine

- When you transport the machine, use the packing materials that came with your machine. Do not tip or turn the product upside down. If you do not pack the machine correctly, any damage that may occur in transit may not be covered by your warranty.
- The machine should be adequately insured with the carrier.

### IMPORTANT

It is important to allow the machine to “park” the print head after a print job. Listen carefully to the machine before unplugging it to make sure that all mechanical noises have stopped. Not allowing the machine to finish this parking process may lead to print problems and possible damage to the print head.

1. Unplug the machine from the electrical socket.
2. Using both hands, use the finger holds on each side of the machine to lift the scanner cover into the open position. Then unplug the machine from the telephone wall socket and take the telephone line cord out of the machine.
3. Unplug the interface cable from the machine, if it is connected.
4. (MFC-J3540DW/MFC-J3940DW/MFC-J6540DW/MFC-J6740DW/MFC-J6940DW) Remove the orange protective part from its storage place inside the machine.

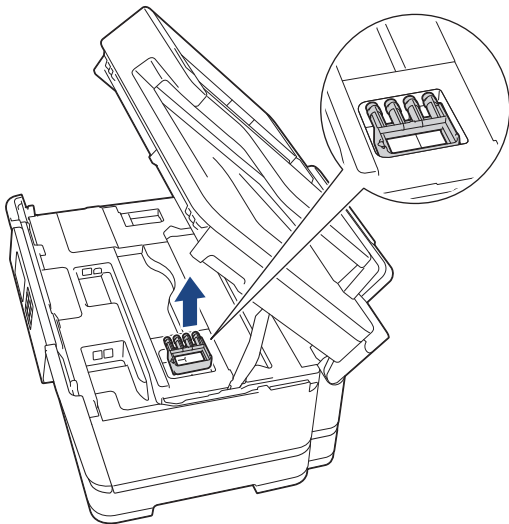

5. Gently close the scanner cover using the finger holds on each side.

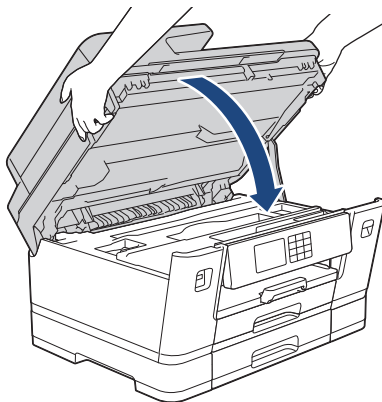

6. Open the ink cartridge cover.
7. Press the ink release levers to release the ink cartridges and then take out the ink cartridges.

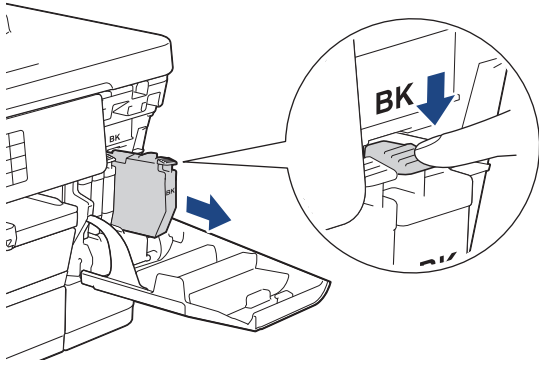

8. (MFC-J3540DW/MFC-J3940DW/MFC-J6540DW/MFC-J6740DW/MFC-J6940DW) Install the orange protective part.

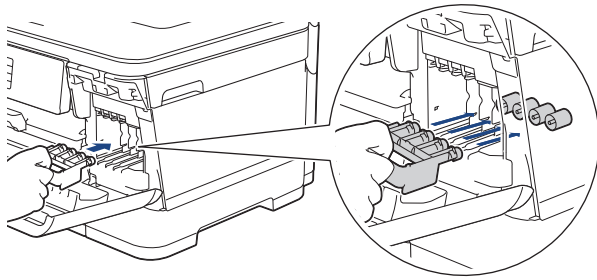

## IMPORTANT

- Make sure the plastic tab on the left side of the orange protective part (1) clicks securely into place (2).

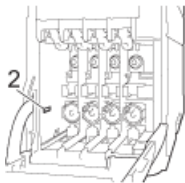
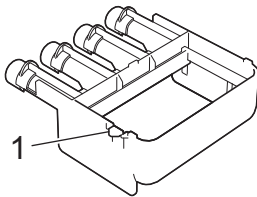

- If you are not able to find the orange protective part, ship the machine without it. DO NOT leave the ink cartridges in the machine during shipping.

9. Close the ink cartridge cover.  
10. Wrap the machine in the bag.

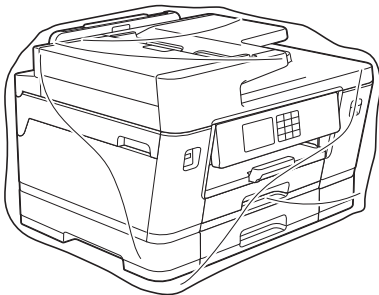

11. Pack the machine in the original carton with the original packing material as shown below. (The original packing material may differ depending on your country.)

Do not pack the used ink cartridge in the carton.

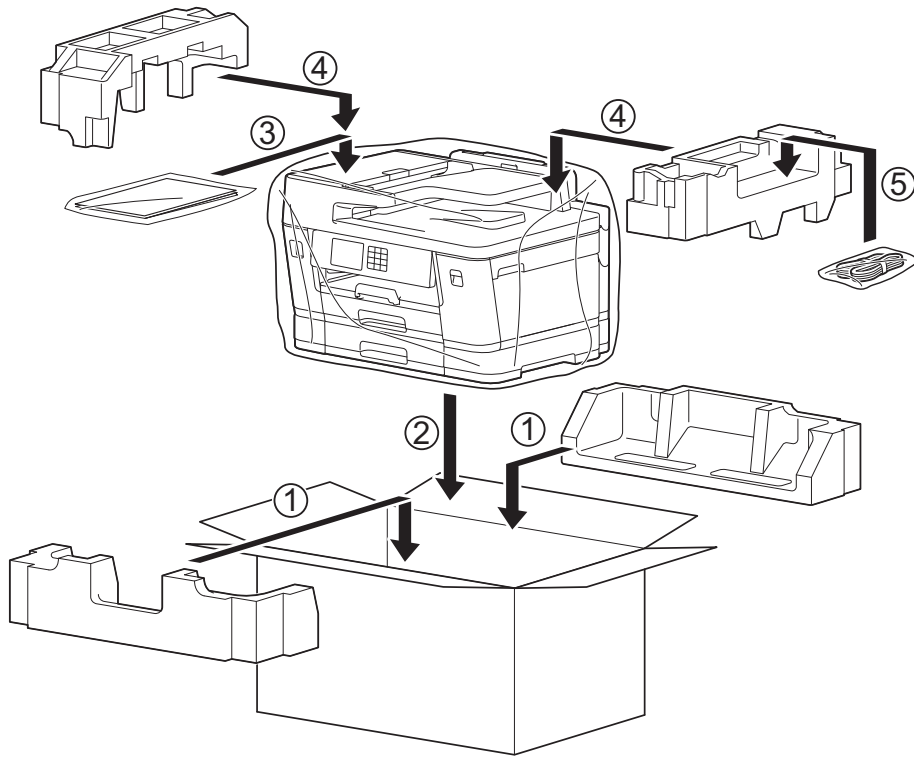

12. Close the carton and tape it shut.

### ✓ Related Information

- [Routine Maintenance](#)

#### Related Topics:

- [Replace the Ink Cartridges](#)

## Machine Settings

Customise settings and features to make your machine a more efficient work tool.

- [Change Machine Settings from the Control Panel](#)
- [Change Machine Settings Using Web Based Management](#)

## Change Machine Settings from the Control Panel

- [In the Event of Power Failure \(Memory Storage\)](#)
- [General Settings](#)
- [Save Your Favourite Settings as a Shortcut](#)
- [Print Reports](#)
- [Settings and Features Tables](#)

## In the Event of Power Failure (Memory Storage)

- Your menu settings are stored permanently and will not be lost.
- Temporary settings (for example: Contrast and Overseas Mode) are lost.
- The date and time and programmed fax timer jobs (for example: Delayed Fax) are retained for approximately 24 hours.
- Other fax jobs in the machine's memory will not be lost.

### Related Information

- [Change Machine Settings from the Control Panel](#)
-

## General Settings

- [Adjust the Machine Volume](#)
- [Change for Daylight Saving Time Automatically](#)
- [Change for Daylight Saving Time Manually](#)
- [Set Sleep Mode Countdown](#)
- [Set the Machine to Power Off Automatically](#)
- [Set the Date and Time](#)
- [Set the Time Zone](#)
- [Adjust the LCD Backlight Brightness](#)
- [Change How Long the LCD Backlight Stays On](#)
- [Set Your Station ID](#)
- [Set Tone or Pulse Dialling Mode](#)
- [Set a Prefix Dial Before Every Fax Number](#)
- [Prevent Dialling a Wrong Number \(Dial Restriction\)](#)
- [Reduce Printing Noise](#)
- [Change the Language Displayed on the LCD](#)
- [Change the Keyboard Setting](#)

## Adjust the Machine Volume

1. Press  [Settings] > [All Settings] > [General Setup] > [Volume].
2. Press one of the following options:

Option	Description
Ring	Adjust the ring volume.
Beep	Adjust the volume when you press a button, make a mistake, or after you send or receive a fax.
Speaker	Adjust the speaker volume.

3. Press ▲ or ▼ to display the [Off], [Low], [Med], or [High] option, and then press the option you want.
4. Press .

### Related Information



- [General Settings](#)

## Change for Daylight Saving Time Automatically

You can program the machine to change automatically for Daylight Saving Time.

It will reset itself forward one hour in the spring, and backward one hour in the autumn. Make sure you have set the correct date and time in the [Date & Time] setting.

This feature is available only in some countries.

1. Press  [Settings].
2. Press  [Date & Time] > [Auto Daylight].
3. Press [On] or [Off].
4. Press .

### Related Information



- [General Settings](#)

## Change for Daylight Saving Time Manually

You can program the machine to change for Daylight Saving Time.

When selecting [Forward Hour] it will forward the time by an hour and backward one hour when selecting [Backward Hour]. Make sure you have set the correct date and time in the [Date & Time] setting.

This feature is available only in some countries.

1. Press  [Settings].
2. Press  [Date & Time] > [Daylight Save].
3. Press [Forward Hour] or [Backward Hour].
4. Press .





### Related Information

- [General Settings](#)

## Set Sleep Mode Countdown

The Sleep Mode (or Power Save Mode) setting can reduce power consumption. When the machine is in Sleep Mode, it acts as though it is turned off. The machine will wake up and start printing when it receives a print job or a fax. Use these instructions to set a time delay (countdown) before the machine enters Sleep Mode.

- The timer will restart if any operation is carried out on the machine, such as receiving a fax or a print job.
- The factory setting is three minutes.

1. Press  [Settings] > [All Settings] > [General Setup] > [Sleep Time].
2. Enter the number of minutes (1-60) you want to set on the touchscreen, and then press [OK].
3. Press .



When the machine goes into Sleep Mode, the LCD backlight turns off.



### Related Information

- [General Settings](#)

#### Related Topics:

- [Set the Machine to Power Off Automatically](#)

## Set the Machine to Power Off Automatically



The Auto Power Off feature can reduce power consumption. Set the amount of time that the machine must be in Sleep Mode before it automatically powers off. When this feature is set to [Off], you must power off the machine manually.

To turn on the machine after the Auto Power Off feature has turned it Off, press .



The machine does not power off automatically when:

- The machine is connected to a telephone line.
- The machine is connected to a wired network.
- The machine is connected to a wireless network.
- [WLAN (Wi-Fi)] is selected in the [Network I/F] setting.
- Secure print jobs are stored in the machine's memory. (MFC-J6955DW/MFC-J6957DW)

1. Press  [Settings] > [All Settings] > [General Setup] > [Auto Power Off].
2. Press ▲ or ▼ to display the [Off], [1 hour], [2 hours], [4 hours], or [8 hours] option, and then press the option you want.
3. Press .



### Related Information



- [General Settings](#)

#### Related Topics:

- [Set the Fax Journal's Interval Period](#)
- [Set Sleep Mode Countdown](#)

## Set the Date and Time

The LCD displays the date and time. If they are not current, re-enter them. You can add the date and time to each fax you send by setting your Station ID.

1. Press  [Settings].
2. Press  [Date & Time].
3. Press [Date].
4. Enter the last two digits of the year on the touchscreen, and then press [OK].
5. Enter two digits for the month on the touchscreen, and then press [OK].
6. Enter two digits for the day on the touchscreen, and then press [OK].
7. Press [Clock Type].
8. Press [12h Clock] or [24h Clock].
9. Press [Time].
10. To enter the time, do one of the following:
  - If you selected [12h Clock], enter the time (in 12-hour format) using the touchscreen, and then press [AM] or [PM].  
Press [OK].
  - If you selected [24h Clock], enter the time (in 24-hour format) using the touchscreen.  
Press [OK].  
(For example, enter 19:45 for 7:45 PM.)
11. Press .

### Related Information

- [General Settings](#)



#### Related Topics:

- [Set Your Station ID](#)

## Set the Time Zone

Set the time zone for your location on the machine.

This feature is available only in some countries.



1. Press  [Settings].
2. Press  [Date & Time] > [Time Zone].
3. Enter your time zone.
4. Press [OK].
5. Press .

### Related Information

- [General Settings](#)

## Adjust the LCD Backlight Brightness

If you are having difficulty reading the LCD, changing the brightness setting may help.

1. Press  [Settings] > [All Settings] > [General Setup] > [LCD Settings] > [Backlight].
2. Press the [Light], [Med], or [Dark] option.
3. Press .





### Related Information

- [General Settings](#)

## Change How Long the LCD Backlight Stays On

Set how long the LCD backlight stays on.

1. Press  [Settings] > [All Settings] > [General Setup] > [LCD Settings] > [Dim Timer].
2. Press ▲ or ▼ to display the [10 Secs], [30 Secs], [1 Min], [2 Mins], [3 Mins], or [5 Mins] option, and then press the option you want.
3. Press .



### Related Information



- [General Settings](#)

## Set Your Station ID

Set the machine's Station ID if you want the date and time to appear on each fax you send.

1. Press  [Settings] > [All Settings] > [Initial Setup] > [Station ID].
2. Press [Fax].
3. Enter your fax number (up to 20 digits) on the touchscreen, and then press [OK].
4. Press [Name].
5. Enter your name (up to 20 characters) using the touchscreen, and then press [OK].



- Press  to cycle between letters, numbers and special symbols. (The available characters may differ depending on your country.)
- If you entered an incorrect character and want to change it, press ◀ or ▶ to move the cursor to it. Press  and then enter the correct character.
- To enter a space, press [Space].

6. Press .

### ✓ Related Information

- [General Settings](#)



#### Related Topics:

- [Transfer Faxes to Another Fax Machine](#)
- [Transfer the Fax Journal Report to Another Fax Machine](#)
- [Enter Text on Your Brother Machine](#)
- [Set the Date and Time](#)

## Set Tone or Pulse Dialling Mode

Your machine is set for a Tone dialling service. If you have a Pulse dialling (rotary) service, you must change the dialling mode.

This feature is not available in some countries.

1. Press  [Settings] > [All Settings] > [Initial Setup] > [Tone/Pulse].
2. Press [Tone] or [Pulse].
3. Press .

### Related Information

- [General Settings](#)

#### Related Topics:

- [Telephone and Fax Problems](#)

## Set a Prefix Dial Before Every Fax Number

The Dial Prefix setting will automatically dial a predefined number before every fax number you dial. For example: If your telephone system requires a 9 to dial an outside number, use this setting to automatically dial 9 for every fax you send.



- This feature is not available in some countries.
- Use the numbers and symbols from 0 to 9, #, and \*. (You cannot use ! with any other numbers or symbols.)
- If your telephone system requires a time break recall (hookflash), press ! on the LCD.
- (not available for some countries) If pulse dialing mode is on, # and \* are not available to use.

1. Press  [Settings] > [All Settings] > [Initial Setup] > [Dial Prefix].
2. Press [On] or [Off].
  - You can turn off the prefix number by pressing [Off].
  - The prefix number will remain off until you press [On].
3. Press [Dial Prefix].
4. Enter the prefix number (up to 5 digits) using the touchscreen, and then press [OK].



To change the prefix number, press ◀ or ▶ to position the cursor to highlight the digit to be deleted and press the Back Space button . Then press the correct digit.

Repeat until the prefix number is correct, and then press [OK].

5. Press .



### Related Information

- [General Settings](#)

## Prevent Dialling a Wrong Number (Dial Restriction)

This feature is to prevent users from sending a fax or call to a wrong number by mistake. You can set the machine to restrict Dialling when you use the dial pad, Address Book, Shortcuts and LDAP search.

1. Press  [Settings] > [All Settings] > [Fax] > [Dial Restriction].
2. Press one of the following options:
  - [Dial Pad]
  - [Address Book]



If you combine Address Book numbers when dialling, the address will be recognised as dial pad input and will not be restricted.

- [Shortcuts]
  - [LDAP Server] (available only for some countries)
3. Press one of the following options:

Option	Description
Enter # Twice	The machine will prompt you to re-enter the number. If you re-enter the same number correctly, the machine will start dialling. If you re-enter the wrong number, the touchscreen will show an error message.
On	The machine will restrict all fax sending and outbound calls for that dialling method.
Off	The machine does not restrict the dialling method.



- The [Enter # Twice] setting will not work if you use an external phone or press [Hook] (Not available for South Africa) before entering the number. You will not be asked to re-enter the number.
- If you selected [On] or [Enter # Twice], you cannot use the Broadcasting feature.

4. Press .



### Related Information

- [General Settings](#)



## Reduce Printing Noise

The Quiet Mode setting can reduce printing noise. When Quiet Mode is turned on, the print speed becomes slower.

The factory setting is [Off].



- When the Quiet Mode setting is turned on,  appears on the Home screen.

1. Press  [Settings] > [All Settings] > [General Setup] > [Quiet Mode].
2. Press [On] or [Off].
3. Press .



### Related Information

- [General Settings](#)



#### Related Topics:

- [Touchscreen LCD Overview](#)
- [Paper Handling and Printing Problems](#)

## Change the Language Displayed on the LCD

Change the LCD language if needed.

This feature is not available in some countries.



1. Press  [Settings] > [All Settings] > [Initial Setup] > [Local Language].
2. Press your language.
3. Press .

### Related Information

- [General Settings](#)
-

## Change the Keyboard Setting

You can choose the type of keyboard for the LCD.

1. Press  [Settings] > [All Settings] > [General Setup] > [Keyboard Settings].
2. Press [QWERTY] or [ABC].
3. Press .



### Related Information

- [General Settings](#)

## Save Your Favourite Settings as a Shortcut

- [Add Shortcuts](#)
- [Change or Delete Shortcuts](#)
- [Assign a Shortcut to an IC Card](#)

## Add Shortcuts

You can add the Fax, Copy, Scan, Web Connect and Apps settings you use most frequently by saving them as your Shortcuts. Later you can press the Shortcut to apply these settings instead of manually re-entering them.



Some Shortcut menus are not available depending on your model.

These instructions describe how to add a Copy Shortcut. The steps for adding a Fax, Scan, Web Connect or Apps Shortcut are very similar.

1. If the Home screen appears, press **+** [Shortcuts].
2. Press a tab from [1] to [3].
3. Press **+** where you have not added a Shortcut.
4. Press **▲** or **▼** to display [Copy].
5. Press [Copy].
6. Press  [Options].
7. Press **▲** or **▼** to display the available settings, and then press the setting you want to change.
8. Press **▲** or **▼** to display the available options for the setting, and then press the option you want.  
Repeat the previous and this steps until you have selected all the settings for this Shortcut. When finished, press [OK].
9. Press [OK].
10. Read and confirm the displayed list of settings you have selected, and then press [OK].
11. Enter a name for the Shortcut using the LCD, and then press [OK].



When adding Fax or Scan to Shortcuts, you will be asked if you want to make this a One Touch Shortcut. Follow the LCD instructions.



### Related Information

- [Save Your Favourite Settings as a Shortcut](#)

## Change or Delete Shortcuts

You can change the settings in a Shortcut.

You cannot change a Web Connect Shortcut or Apps Shortcut. If you need to change them, delete them, and then add a new Shortcut.

1. If the Home screen appears, press **+** [Shortcuts].
2. Press a tab from [1] to [3] to display the Shortcut you want to change.
3. Press and hold the Shortcut you want to change.
4. Press [Edit].



To delete the Shortcut, press [Delete]. To edit the name of the Shortcut, press [Rename] and follow the LCD menus.

5. Press  [Options].
6. Press **▲** or **▼** to display the available settings, and then press the setting you want to change.
7. Change the settings for the Shortcut you selected. Press [OK].
8. Press [OK] when you have finished changing the settings.
9. Press [OK] to confirm.



When changing Fax or Scan Shortcuts, you will be asked if you want to make this a One Touch Shortcut. Follow the LCD instructions.



### Related Information

- [Save Your Favourite Settings as a Shortcut](#)

#### Related Topics:

- [Enter Text on Your Brother Machine](#)

## Assign a Shortcut to an IC Card

- [Assign a Shortcut to an IC Card with NFC](#)
- [Assign a Shortcut to an IC Card with IC Card Reader](#)

## Assign a Shortcut to an IC Card with NFC

**Related Models:** MFC-J6955DW/MFC-J6957DW

You can assign one Shortcut to your IC card. When you touch your IC card to the machine's NFC symbol, your personal Shortcut automatically appears on the touchscreen.



- You cannot use the same IC card for different Shortcuts.
- To use the IC card for another Shortcut, unregister the card first, and then register it with the new Shortcut.

1. If the Home screen appears, press **+** [Shortcuts].
2. Press the tab that contains the Shortcut you want to assign to your IC card.
3. Press and hold the Shortcut until the options appear.
4. Press **▲** or **▼** to display the [Register Card/NFC] option, and then press it.
5. Touch the IC card to the NFC symbol.
6. Press [Register].

The Shortcut is assigned to the IC Card.



### Related Information

- [Assign a Shortcut to an IC Card](#)

## Assign a Shortcut to an IC Card with IC Card Reader

You can assign one Shortcut to your IC card. When you touch your IC card to the IC card reader connected to your machine, your personal Shortcut automatically appears on the touchscreen.



- You cannot use the same IC card for different Shortcuts.
- To use the IC card for another Shortcut, unregister the card first, and then register it with the new Shortcut.

Before you assign a shortcut to an IC card, register an external IC card reader. Use Web Based Management to register the card reader. Your machine supports external IC card readers supporting HID-class drivers.

1. Start your web browser.
2. Type "https://machine's IP address" in your browser's address bar (where "machine's IP address" is the machine's IP address).

For example:

https://192.168.1.2

3. If required, type the password in the **Login** field, and then click **Login**.



The default password to manage this machine's settings is located on the back of the machine and marked "Pwd".

4. Go to the navigation menu, and then click **Administrator** > **External Card Reader**.



Start from , if the navigation menu is not shown on the left side of the screen.

5. Enter the necessary information, and then click **Submit**.
6. Restart your Brother machine to activate the configuration.
7. Connect the card reader to your machine.

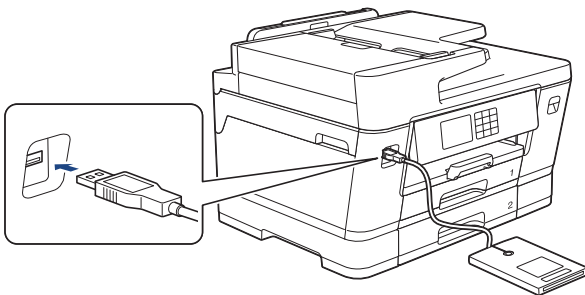

8. If the Home screen appears, press **+** [Shortcuts] on the LCD.
9. Press a tab from [1] to [3] to select the Shortcut screens that contains the Shortcut you want to assign to your IC card.
10. Press and hold the Shortcut until the options appear.
11. Press **▲** or **▼** to display the [Register Card/NFC] option, and then press it.
12. Touch the IC card to the IC card reader connected to your machine.
13. Press [Register].

The Shortcut is assigned to the IC Card.



### Related Information

- [Assign a Shortcut to an IC Card](#)

---

**Related Topics:**

- [Access Web Based Management](#)
-

## Print Reports

- [Reports](#)
- [Print a Report](#)
- [Fax Reports](#)
- [Telephone and Fax Problems](#)

## Reports

The following reports are available:

### Transmission Verify

The Transmission Verify prints a Transmission Verification Report for your last transmission.

### Address Book

The Address Book report prints a list of names and numbers stored in the Address Book memory.

### Fax Journal

The Fax Journal prints a list of information about your last 200 incoming and outgoing faxes. (TX means Transmit, RX means Receive.)

### User Settings

The User Settings report prints a list of your current settings.

### Network Configuration (network models)

The Network Configuration report prints a list of your current network settings.

### WLAN Report (wireless models)

The WLAN Report prints the wireless LAN connectivity diagnosis.

### Caller ID History

The Caller ID History report prints a list of the available Caller ID information for the last 30 received faxes and telephone calls.



(Not available for Taiwan and some countries)



## Related Information

- [Print Reports](#)

## Print a Report

1. Press  [Settings] > [All Settings] > [Print Reports].
2. Press ▲ or ▼ to display the report options, and then press the option you want.
3. Press [Yes].
4. Press .



### Related Information

- [Print Reports](#)

#### Related Topics:

- [Caller ID](#)

## Settings and Features Tables

- Settings Tables (2.7"(67.5 mm)/3.5"(87.6 mm) Touchscreen models)
- Features Tables (2.7"(67.5 mm)/3.5"(87.6 mm) Touchscreen models)

## Settings Tables (2.7"(67.5 mm)/3.5"(87.6 mm) Touchscreen models)

These tables will help you understand your machine's menu selections and options.

>> [Settings]  
 >> [General Setup]  
 >> [Shortcut Settings]  
 >> [Fax]  
 >> [Printer]  
 >> [Network]  
 >> [Print Reports]  
 >> [Machine Info.]  
 >> [Initial Setup]

### [Settings]



#### [Settings]

Level 1	Level 2	Level 3	Descriptions
 (Date & Time)	-	-	Access the Date and Time setting menus.
Maintenance	-	-	Access the Maintenance settings menus.
Network	Wired LAN	-	Access the Wired LAN setting menus.
	WLAN (Wi-Fi)	-	Access the WLAN setting menus.
	Wi-Fi Direct	-	Access the Wi-Fi Direct setting menus.
	Network I/F	-	Select the network connection type.
Tray Setting	-	-	Access the tray setting menus.
Fax Preview	-	-	View received faxes on the LCD.
Wi-Fi Direct	-	-	Access the Wi-Fi Direct setting menus.
All Settings	-	-	Configure the detailed settings.

### [General Setup]



#### [All Settings] > [General Setup]

Level 3	Level 4	Level 5	Descriptions
Maintenance	Improve Print Quality	Check Print Quality	Check and correct the print quality, alignment and paper feeding according to the LCD instructions.
		Alignment	
		Correct Paper Feed	
	Print Head Cleaning	-	Clean the print head according to the LCD instructions.
	Remove Paper Scraps	-	Remove a piece of paper in the machine according to the LCD instructions.
Clean Paper Pick-up Roller	-	Clean the rollers according to the LCD instructions.	

Level 3	Level 4	Level 5	Descriptions	
<b>Maintenance</b>	(Available only for some countries.)			
	<b>Ink Volume</b>	-	Check the available ink volume.	
	<b>Ink Cartridge Model</b>	-	Check your ink cartridge numbers.	
	<b>Print Options</b>	<b>Reduce Smudging</b>		Reduce smudging on the paper or paper jams during printing.
		<b>Reduce Uneven Lines</b>		Reduce uneven lines on the paper during printing.
		<b>Enhance Print</b>		Improve print quality and reduce blurriness.
	<b>Ink Cartridge Check</b>	-	View your ink cartridge information.	
<b>Print Quality Auto Check</b>	-	Automatically detects the Print Head condition and cleans the Print Head when needed.		
<b>Paper Type</b> (MFC-J3540DW/ MFC-J6540DW)	-	-	Set the type of paper in the paper tray.	
<b>Paper Size</b> (MFC-J3540DW/ MFC-J6540DW)	-	-	Set the size of paper in the paper tray.	
<b>Check Paper</b> (MFC-J3540DW/ MFC-J6540DW)	-	-	Check the paper type and paper size when you pull the tray out of the machine.	
<b>Tray Setting</b> (MFC-J3940DW/ MFC-J6555DW/ MFC-J6740DW/ MFC-J6940DW/ MFC-J6955DW/ MFC-J6957DW)	<b>Tray 1</b>	<b>Paper Type</b>	Set the type of paper in the paper tray #1.	
		<b>Paper Size</b>	Set the size of paper in the paper tray #1.	
	<b>Tray 2</b> (MFC-J3940DW/ MFC-J6740DW/ MFC-J6940DW/ MFC-J6955DW/ MFC-J6957DW)	<b>Paper Size</b>	Set the size of paper in the paper tray #2.	
	<b>Tray 3</b> (MFC-J6957DW)	<b>Paper Size</b>	Set the size of paper in the paper tray #3.	
	<b>MP Tray</b> (MFC-J3940DW/ MFC-J6555DW/ MFC-J6940DW/ MFC-J6955DW/ MFC-J6957DW)	<b>Paper Type</b>	Set the type of paper in the MP tray.	
		<b>Paper Size</b>	Set the size of paper in the MP tray.	
	<b>Tray Setting: Copy</b>	<b>Tray Select</b>	Select the tray to be used for copying.	
		<b>Tray Priority</b> (Not available for MFC-J6740DW)	Change the tray priority for copying.	
	<b>Tray Setting: Fax</b>	<b>Tray Select</b>	Select the tray to be used for faxing.	
		<b>Tray Priority</b> (Not available for MFC-J6740DW)	Change the tray priority for faxing.	
	<b>Tray Setting: Print</b>	<b>Tray Priority</b>	Change the tray priority for printing from your computer.	

Level 3	Level 4	Level 5	Descriptions
<b>Tray Setting</b> (MFC-J3940DW/ MFC-J6555DW/ MFC-J6740DW/ MFC-J6940DW/ MFC-J6955DW/ MFC-J6957DW)	(Not available for MFC-J6740DW)		
	<b>Tray Setting: JPEG Print (Media)</b> (Not available for MFC-J6740DW)	<b>Tray Select</b>	Select the tray to be used for printing photos from a USB flash drive.
		<b>Tray Priority</b>	Change the tray priority for printing photos from a USB flash drive.
	<b>Skip Tray</b> (MFC-J6957DW)	-	Select a specific tray you do not want to use; if it is loaded with paper of the wrong size.
	<b>Paper Low Notice</b> (MFC-J6955DW/ MFC-J6957DW)	-	Select whether to display a message telling you that the paper tray is nearly empty.
	<b>Check Paper</b>	-	Check the paper type and paper size when you pull the tray out of the machine or set the paper in the MP tray. (MP tray is not available for MFC-J6740DW.)
<b>Quiet Mode</b>	-	-	Decrease printing noise.
<b>Volume</b>	<b>Ring</b>	-	Adjust the ring volume.
	<b>Beep</b>	-	Adjust the beeper volume.
	<b>Speaker</b>	-	Adjust the speaker volume.
<b>LCD Settings</b>	<b>Backlight</b>	-	Adjust the brightness of the LCD backlight.
	<b>Dim Timer</b>	-	Set how long the LCD backlight stays on after the last finger press.
<b>Screen Settings</b>	<b>Home Screen</b>	-	Set the screen that is displayed when you press  .
	<b>Scan Screen</b>	-	Set the default Scan screen settings.
<b>Notice Settings</b>	<b>Document Alert</b>	-	Displays the alert when a document is left on the scanner glass.
	<b>Copy Tip</b>	-	Displays the document placement guidance when you open the document cover.
	<b>Scan Result(Skip Blank Page)</b>	-	Displays the Skip Blank Page scan results when finished.
<b>Keyboard Settings</b>	-	-	Select the type of keyboard for the LCD.
<b>Sleep Time</b>	-	-	Set how long the machine must be idle before it goes into Sleep Mode.
<b>Auto Power Off</b>	-	-	Select how long the machine must wait before it automatically turns itself off after entering Sleep Mode. When set to Off, the machine does not power off automatically.

## [Shortcut Settings]



[All Settings] > [Shortcut Settings]

Level 3	Level 4	Descriptions
(Select a shortcut button.)	<b>Rename</b>	Change the shortcut name.
	<b>Edit</b>	Change the shortcut settings.
	<b>Delete</b>	Delete the shortcut.
	<b>Register Card/NFC</b>	Assign a Shortcut to an IC card.
	<b>Delete Card/NFC</b>	Remove a Shortcut from an IC card.

## [Fax]



[All Settings] > [Fax]

Level 3	Level 4	Level 5	Descriptions
<b>Setup Receive</b>	<b>Ring Delay</b>	-	Set the number of rings before the machine answers in Fax Only or Fax/Tel mode.
	<b>Receive Mode</b>	-	Select the Receive Mode that best suits your needs.
	<b>F/T Ring Time</b>	-	Set the length of the pseudo/double-ring time in Fax/Tel mode.
	<b>Fax Preview</b>	-	View received faxes on the LCD.
	<b>Fax Detect</b>	-	Receive fax messages automatically when you answer a call and hear fax tones.
	<b>Remote Codes</b>	-	Answer calls at an extension or external telephone and use codes to turn the Remote Codes on or off. You can personalise the codes.
	<b>Auto Reduction</b>	-	Reduce the size of incoming faxes.
	<b>PC Fax Receive</b>	-	Set the machine to send faxes to your computer. You can turn on the Backup Print safety feature.
	<b>Memory Receive</b>	-	Set the machine to forward fax messages, to store incoming faxes in the memory (so you can retrieve them while you are away from your machine), or the cloud service. If you select Fax Forward, or Forward to Cloud, you can turn on the Backup Print safety feature.
<b>Report Setting</b>	<b>Fax Rx Stamp</b>	-	Print the received time and date on the top of incoming faxes.
	<b>XMIT Report</b>	-	Select the initial setup for the Transmission Verification Report.
<b>Print Document</b>	<b>Journal Period</b>	-	Set the interval for automatic printing of the Fax Journal. If you select an option other than Off and Every 50 Faxes, you can set the time for the option. If you select Every 7 Days, you can set the day of the week.
	-	-	Print incoming faxes stored in the machine's memory.
<b>Remote Access</b>	-	-	Set your own code for Remote Retrieval.
<b>Dial Restriction</b>	<b>Dial Pad</b>	-	Restrict dialling when using the dial pad.

Level 3	Level 4	Level 5	Descriptions
Dial Restriction	Address Book	-	Restrict the dialling when using the Address Book.
	Shortcuts	-	Restrict the dialling when using a Shortcut.
	LDAP Server (Available only for some countries.)	-	Restrict dialling when using LDAP search.
Remaining Jobs	-	-	Check which scheduled jobs are in the machine's memory and cancel selected jobs.
Miscellaneous	Distinctive (For some countries)	-	Use with telephone company distinctive ringing service allows you to have a voice number and fax number on the one phone line.
	FaxAbility (For New Zealand only)	-	If you have FaxAbility from Telecom, use this function to store the ringing pattern of your fax number. And if you set in to On, you should use the registered number only.
	Call Waiting (For New Zealand only)	-	If you have Call Waiting service, use this function to answer second call when you are on the phone and someone rings you.

### [Printer]



[All Settings] > [Printer]

(MFC-J6955DW/MFC-J6957DW)

Level 3	Level 4	Level 5	Descriptions
Emulation	-	-	Select the emulation mode.
Print Options	Font List	HP LaserJet	Print a list of the machine's internal fonts.
		BR-Script 3	
	Test Print	-	Print a test page.
2-sided	2-sided Print	-	Enable or disable 2-sided printing and choose long edge or short edge.
HP Tray Command	-	-	Select the correct version of HP LaserJet emulation.
Reset Printer	-	-	Restore the printer settings to the factory settings.

### [Network]



[All Settings] > [Network]

Level 3	Level 4	Level 5	Level 6	Descriptions
Wired LAN	TCP/IP	BOOT Method	-	Select the Boot method that best suits your needs.
		IP Address	-	Enter the IP address.
		Subnet Mask	-	Enter the Subnet mask.
		Gateway	-	Enter the Gateway address.
		Node Name	-	Enter the Node name.
		WINS Configuration	-	Select the WINS configuration mode.

Level 3	Level 4	Level 5	Level 6	Descriptions
Wired LAN	TCP/IP	WINS Server	-	Specify the IP address of the primary or secondary WINS server.
		DNS Server	-	Specify the IP address of the primary or secondary DNS server.
		APIPA	-	Set the machine to allocate the IP address from the link-local address range automatically.
		IPv6	-	Turn the IPv6 protocol on or off.
	Ethernet	-	-	Select the Ethernet link mode.
	Wired Status	-	-	View the current wired status.
	MAC Address	-	-	View the machine's MAC address.
WLAN (Wi-Fi)	Find Wi-Fi Network	-	-	Configure your wireless network settings manually.
	TCP/IP	BOOT Method	-	Select the Boot method that best suits your needs.
		IP Address	-	Enter the IP address.
		Subnet Mask	-	Enter the Subnet mask.
		Gateway	-	Enter the Gateway address.
		Node Name	-	Enter the Node name.
		WINS Configuration	-	Select the WINS configuration mode.
		WINS Server	-	Specify the IP address of the primary or secondary WINS server.
		DNS Server	-	Specify the IP address of the primary or secondary DNS server.
		APIPA	-	Set the machine to allocate the IP address from the link-local address range automatically.
	IPv6	-	Turn the IPv6 protocol on or off.	
	WPS/Push Button	-	-	Configure your wireless network settings using the one-button push method.
	WPS/PIN Code	-	-	Configure your wireless network settings using WPS with a PIN.
	WLAN Status	Status	-	View the current wireless network status.
		Signal	-	View the current wireless network signal strength.
		SSID	-	View the current SSID.

Level 3	Level 4	Level 5	Level 6	Descriptions	
WLAN (Wi-Fi)	WLAN Status	Comm. Mode	-	View the current Communication mode.	
	MAC Address	-	-	View the machine's MAC address.	
Wi-Fi Direct	Manual	-	-	Configure your Wi-Fi Direct network settings manually.	
	Group Owner	-	-	Set your machine as the Group Owner.	
	Push Button	-	-	Configure your Wi-Fi Direct network settings using the one-button push method.	
	PIN Code	-	-	Configure your Wi-Fi Direct network settings using WPS with a PIN code.	
	Device Information	Device Name	-	-	View your machine's device name.
		SSID	-	-	View the Group Owner's SSID. When the machine is not connected, the LCD displays Not Connected.
		IP Address	-	-	View your machine's current IP Address.
	Status Information	Status	-	-	View the current Wi-Fi Direct network status.
		Signal	-	-	View the current Wi-Fi Direct network signal strength. When your machine acts as Group Owner, the LCD always indicates a strong signal.
I/F Enable	-	-	Turn the Wi-Fi Direct connection on or off.		
NFC (MFC-J3940DW/ MFC-J6940DW/ MFC-J6955DW/ MFC-J6957DW)	-	-	-	Turn the NFC function on or off.	
E-mail/IFAX	Mail Address	-	-	Enter the email address. (Up to 60 characters)	
	Setup Server	SMTP	Server	Enter the SMTP server name and address.	
			Port	Enter the SMTP port number.	
			Auth. for SMTP	Select the Security method for email notification.	
			SSL/TLS	Send or receive an email via an email server that requires secure SSL/TLS communication.	
Verify Certification	Verify the SMTP Server Certificate automatically.				

Level 3	Level 4	Level 5	Level 6	Descriptions	
E-mail/IFAX	Setup Server	POP3/IMAP4	Protocol	Select the protocol for receiving an email from the server.	
			Server	Enter the server name and address.	
			Port	Enter the port number.	
			Mailbox Name	Enter the mailbox name. (Up to 60 characters)	
			Mailbox Password	Enter the password to login to the server. (Up to 128 characters)	
			Select Folder	Select the specified folder in the mailbox using the IMAP4 protocol.	
			SSL/TLS	Send or receive an email via an email server that requires secure SSL/TLS communication.	
			Verify Certification	Verify the Server Certificate automatically.	
			APOP	Turn APOP on or off.	
	Setup Mail RX	Auto Polling	Auto Polling	Automatically check the server for new messages.	
			Poll Frequency	Set the interval for checking new messages on the server.	
		Header	-	Select the contents of the email header to be printed.	
		Del/Read Error Mail	-	Set the machine to automatically delete error mails.	
		Notification	-	Receive notification messages.	
	Setup Mail TX	Sender Subject	-	View the subject.	
		Size Limit	Size Limit	Limit the size of email documents.	
			Maximum Size (MB)		
		Notification	-	Send notification messages.	
	Setup Relay	Relay Broadcast	-	Relay a document to another fax machine.	
		Relay Domain	-	Register the Domain name.	
		Relay Report	-	Print the relay Broadcast Report.	
	Manual Receive	-	-	Manually check the POP3 or IMAP4 server for new messages.	
	Message from Brother	Message from Brother	-	-	Display messages and notifications from Brother.
		Status	-	-	

Level 3	Level 4	Level 5	Level 6	Descriptions
Web Connect Settings	Proxy Settings	Proxy Connection	-	Change the Web connection settings.
		Address	-	
		Port	-	
		User Name	-	
		Password	-	
Network I/F	-	-	-	Select the network connection type.
IPsec	-	-	-	IPsec is an optional security feature of the IP protocol that provides authentication and encryption services. We recommend contacting your network administrator before changing this setting.
Network Reset	-	-	-	Restore all network settings back to the factory settings.

### [Print Reports]



[All Settings] > [Print Reports]

Level 3	Descriptions
XMIT Verify	Print a Transmission Verification Report for your last transmission.
Address Book	Print a list of names and numbers stored in the Address Book.
Fax Journal	Print a list of information about your last 200 incoming and outgoing faxes. (TX means Transmit. RX means Receive.)
User Settings	Print a list of your settings.
Network Configuration	Print a list of your Network settings.
WLAN Report	Print the wireless LAN connection results.
Caller ID History (Not available for Taiwan and some countries)	Print a list of the available Caller ID information of the last 30 received faxes and telephone calls.

### [Machine Info.]



[All Settings] > [Machine Info.]

Level 3	Level 4	Descriptions
Serial No.	-	Check your machine's serial number.
Firmware Version	Main Version	Check your machine's firmware version.
	Security Version	
Firmware Update	-	Update your machine to the latest firmware.
Firmware Auto Check	-	View firmware information on the Home screen.
Page Counter	-	Check the total number of pages the machine has printed.

## [Initial Setup]



[All Settings] > [Initial Setup]

Level 3	Level 4	Descriptions
<b>Date &amp; Time</b>	<b>Date</b>	Add the date and time on the screen and in the headings of the faxes you send.
	<b>Time</b>	
	<b>Clock Type</b>	Select the time format (12-hour or 24-hour).
	<b>Auto Daylight</b> (Available only for some countries.)	Set the machine to change automatically for Daylight Saving Time.
	<b>Daylight Save</b> (Available only for some countries.)	Change for Daylight Saving Time manually.
	<b>Time Zone</b>	Set your time zone.
<b>Station ID</b>	<b>Fax</b>	Enter your name and fax number so it appears on each page you fax.
	<b>Name</b>	
<b>Tone/Pulse</b> (Available only for some countries.)	-	Select the dialling mode.
<b>Fax Auto Redial</b>	-	Set the machine to redial the last fax number if the fax did not go through because the line was busy.
<b>Dial Tone</b>	-	Shorten the dial tone detect pause.
<b>Dial Prefix</b> (Available only for some countries.)	-	Set a prefix number to be added before the fax number every time you dial.
<b>Phone Line Set</b> (Available only for some countries.)	-	Select the telephone line type.
<b>Compatibility</b>	-	Adjust the equalisation for transmission difficulties. VoIP service providers offer fax support using various standards. If you regularly experience fax transmission errors, select Basic (for VoIP).
<b>Reset</b>	<b>Machine Reset</b>	Restore all the machine's settings that you have changed, such as Date and Time.
	<b>Network</b>	Restore all network settings back to the factory settings.
	<b>Address Book &amp; Fax</b>	Erase all stored phone numbers and fax settings.
	<b>All Settings</b>	Restore all the machine's settings back to the factory settings.
<b>Local Language</b> (Available only for some countries.)	-	Change your LCD language.













### Related Information

- [Settings and Features Tables](#)

## Features Tables (2.7"(67.5 mm)/3.5"(87.6 mm) Touchscreen models)



These tables will help you understand your machine's feature selections and temporary options.

- >>  [Fax]
- >>  [Copy]
- >>  [Scan]
- >>  [Secure Print]
- >>  [Web]
- >>  [Apps]
- >>  [USB]
- >>  [A3 Copy Shortcuts]
- >>  [Download Software]
- >>  [Print Head Cleaning]
- >>  [Shortcuts]
- >>  [Ink]
- >>  Wi-Fi Setup
- >> When you have put a USB Flash drive in the USB slot

### [Fax]



(When [Fax Preview] is [Off])



Level 3	Level 4	Level 5	Descriptions
Hook	-	-	(Not available for South Africa) Press before dialling if you want to listen to make sure a fax machine has answered, and then press Fax Start.
Address Book	 (Search:)	-	When LDAP is off, the search is within the Local Address Book. When LDAP is on, the search is within the Local Address Book and LDAP Server.
		<b>Detail</b> (Appears only when LDAP is on.) (Available only for some countries.)	View detailed information about the selected address.
	<b>Edit</b>	-	Store Address Book numbers, set up Group numbers for Broadcasting, and change and delete Address Book numbers.
	-	<b>Apply</b>	Start sending a fax using the Address Book.
Call History	<b>Redial</b>	-	Redial the last number you dialled.
	<b>Outgoing Call</b>	<b>Apply</b>	Select a number from the Outgoing Call history and then send a fax to it, add it to the Address Book, or delete it.
		<b>Edit</b>	
<b>Caller ID History</b>	<b>Apply</b>	Select a number from the Caller ID History and then send a fax to it, add it to the Address Book,	

Level 3	Level 4	Level 5	Descriptions
Call History	(Not available for Taiwan and some countries)	Edit	or delete it.
 Options	Fax Resolution	-	Set the resolution for outgoing faxes.
	Contrast	-	Adjust the contrast.
	2-sided Fax (MFC-J3940DW/ MFC-J6940DW/ MFC-J6955DW/ MFC-J6957DW)	-	Set the 2-sided scanning format.
	Document Size	-	Set the document size for outgoing faxes.
	Scan Long Paper	-	Scan a long document using the ADF.
	Broadcasting	Add Number	Send the same fax message to more than one fax number.
	Preview	-	Preview a fax message before you send it.
	Colour Setting	-	Set whether faxes are sent in monochrome or colour.
	Delayed Fax	Delayed Fax	Set the time of day the delayed faxes will be sent.
		Set Time	
	Batch TX	-	Combine delayed faxes to the same fax number at the same time of day into one transmission.
	Real Time TX	-	Send a fax without using the memory.
	Overseas Mode	-	Set to On if you have difficulty sending faxes overseas.
	Call History	Redial	Redial the last number you dialled.
		Outgoing Call	Select a number from the Outgoing Call history and then send a fax to it, add it to the Address Book, or delete it.
		Caller ID History (Not available for Taiwan and some countries)	Select a number from the Caller ID History and then send a fax to it, add it to the Address Book, or delete it.
Address Book	 (Search:)	When LDAP is off, the search is within the Local Address Book. When LDAP is on, the search is within the Local Address Book and LDAP Server.	
	Edit	Store Address Book numbers, set up Group numbers for Broadcasting, and change and delete Address Book numbers.	
Set New Default	-	Save your settings as the default.	
Factory Reset	-	Restore all settings back to the factory settings.	
Save as Shortcut	-	-	Save the current settings as a shortcut.

**(When [Fax Preview] is [On])**

Level 3	Level 4	Level 5	Level 6	Descriptions
Sending Faxes	Hook	-	-	(Not available for South Africa) Press before dialling if you want to listen to make sure a fax



Level 3	Level 4	Level 5	Level 6	Descriptions
Sending Faxes				machine has answered, and then press Fax Start.
	Address Book	 (Search:)	-	When LDAP is off, the search is within the Local Address Book. When LDAP is on, the search is within the Local Address Book and LDAP Server.
			<b>Detail</b> (Appears only when LDAP is on.) (Available only for some countries.)	View detailed information about the selected address.
		<b>Edit</b>	-	Store Address Book numbers, set up Group numbers for Broadcasting, and change and delete Address Book numbers.
		-	<b>Apply</b>	Start sending a fax using the Address Book.
	Call History	<b>Redial</b>	-	Redial the last number you dialled.
		<b>Outgoing Call</b>	<b>Apply</b>	Select a number from the Outgoing Call history and then send a fax to it, add it to the Address Book, or delete it.
			<b>Edit</b>	
	<b>Caller ID History</b> (Not available for Taiwan and some countries)	<b>Apply</b>	Select a number from the Caller ID History and then send a fax to it, add it to the Address Book, or delete it.	
		<b>Edit</b>		
	 <b>Options</b>	<b>Fax Resolution</b>	-	Set the resolution for outgoing faxes.
		<b>Contrast</b>	-	Adjust the contrast.
		<b>2-sided Fax</b> (MFC-J3940DW/ MFC-J6940DW/ MFC-J6955DW/ MFC-J6957DW)	-	Set the 2-sided scanning format.
		<b>Document Size</b>	-	Set the document size for outgoing faxes.
		<b>Scan Long Paper</b>	-	Scan a long document using the ADF.
		<b>Broadcasting</b>	<b>Add Number</b>	Send the same fax message to more than one fax number.
		<b>Preview</b>	-	Preview a fax message before you send it.
		<b>Colour Setting</b>	-	Set whether faxes are sent in monochrome or colour.
		<b>Delayed Fax</b>	<b>Delayed Fax</b>	Set the time of day the delayed faxes will be sent.
			<b>Set Time</b>	

Level 3	Level 4	Level 5	Level 6	Descriptions	
Sending Faxes	 Options	Batch TX	-	Combine delayed faxes to the same fax number at the same time of day into one transmission.	
		Real Time TX	-	Send a fax without using the memory.	
		Overseas Mode	-	Set to On if you have difficulty sending faxes overseas.	
		Call History	Redial		Redial the last number you dialled.
			Outgoing Call		Select a number from the Outgoing Call history and then send a fax to it, add it to the Address Book, or delete it.
			Caller ID History (Not available for Taiwan and some countries)		Select a number from the Caller ID History and then send a fax to it, add it to the Address Book, or delete it.
		Address Book	 (Search:)		When LDAP is off, the search is within the Local Address Book. When LDAP is on, the search is within the Local Address Book and LDAP Server.
			Edit		Store Address Book numbers, set up Group numbers for Broadcasting, and change and delete Address Book numbers.
			Set New Default	-	Save your settings as the default.
			Factory Reset	-	Restore all settings back to the factory settings.
	Save as Shortcut	-	-	Save the current settings as a shortcut.	
Received Faxes	Print/Delete	Print All (New Faxes)	-	Print the new received faxes.	
		Print All (Old Faxes)	-	Print the old received faxes.	
		Delete All (New Faxes)	-	Delete the new received faxes.	
		Delete All (Old Faxes)	-	Delete the old received faxes.	
Address Book	 (Search:)	-	-	When LDAP is off, the search is within the Local Address Book. When LDAP is on, the search is within the Local Address Book and LDAP Server.	
		Detail (Appears only when LDAP is on.) (Available only for some countries.)	-	-	View detailed information about the selected address.
	Edit	-	-	Store Address Book numbers, set up Group numbers for	

Level 3	Level 4	Level 5	Level 6	Descriptions
Address Book				Broadcasting, and change and delete Address Book numbers.
	-	Apply	-	Start sending a fax using the Address Book.
Call History	Redial	-	-	Redial the last number you dialed.
	Outgoing Call	Apply	-	Select a number from the Outgoing Call history and then send a fax to it, add it to the Address Book, or delete it.
		Edit	-	
	Caller ID History (Not available for Taiwan and some countries)	Apply	-	Select a number from the Caller ID History and then send a fax to it, add it to the Address Book, or delete it.
		Edit	-	

















[Copy]



Level 3	Level 4	Level 5	Descriptions	
Save as Shortcut	-	-	Save the current settings as a shortcut.	
ID	-	-	Make an ID card copy.	
 Preview (MFC-J6955DW/ MFC-J6957DW)	-	-	Preview the copied result on the LCD before the machine starts printing.	
 Options	Quality	-	Select the Copy resolution for your document type.	
	Document Size	-	Select the document size option you want.	
	Tray Select (MFC-J3940DW/MFC-J6555DW/ MFC-J6740DW/MFC-J6940DW/ MFC-J6955DW/MFC-J6957DW)	-	Select the tray to be used for Copy mode.	
	Paper Type	-	Select the paper type that matches the paper in the tray.	
	Paper Size	-	Select the paper size that matches the paper in the tray.	
	Enlarge/Reduce	100%	-	
		Fit to Page		Adjust the copy size to fit on the paper size you have set.
		Enlarge		Select an enlargement ratio for the next copy.
		Reduce		Select a reduction ratio for the next copy.
		Custom (25-400 %)		Enter an enlargement or reduction ratio.
Density	-	-	Adjust the density.	
Remove Background Colour	Black Copy Settings		Change the amount of background colour that is removed.	

Level 3	Level 4	Level 5	Descriptions
 Options	Remove Background Colour	Colour Copy Settings	Change the amount of background colour that is removed.
	2-sided Copy	-	Turn off or turn on 2-sided copying and select flip on long edge or flip on short edge.
	Stack/Sort	-	Select to stack or sort multiple copies.
	Page Layout	-	Make N in 1, 2 in 1 ID, 1 to 2, or Poster copies.
	Auto Deskew	-	Set the machine to correct a skewed copy.
	Advanced Settings	-	Select advanced copy settings.
	Preview (MFC-J6955DW/MFC-J6957DW)	-	Preview a copy result on the LCD, before the machine starts printing.
	Set New Default	-	Save your settings as the default.
	Factory Reset	-	Restore all settings back to the factory settings.

 [Scan]

Level 3	Level 4	Level 5	Level 6	Descriptions	
to Media (When a USB Flash drive is inserted)	Other Scan to Actions	-	-	Scan documents and save them directly to a USB flash drive without using a computer.	
	 Options	-	-		
	Save as Shortcut	-	-		
to My E-mail (MFC-J6555DW/ MFC-J6955DW/ MFC-J6957DW)	-	-	-	Scan a monochrome or a colour document to your email address.	
to My Folder (MFC-J6555DW/ MFC-J6955DW/ MFC-J6957DW)	-	-	-	Send scanned data to your folder in the CIFS server on your local network or on the Internet.	
to PC	to File	Other Scan to Actions	-	 Options Save as Shortcut	
		(Select USB or PC)	-		
	to OCR	Other Scan to Actions	-	 Options Save as Shortcut	Convert your scanned document to an editable text file.
		(Select USB or PC)	-		
	to Image	Other Scan to Actions	-	 Options Save as Shortcut	Scan photos or graphics into your graphics applications.
		(Select USB or PC)	-		

Level 3	Level 4	Level 5	Level 6	Descriptions	
to PC	to E-mail	Other Scan to Actions	-	Send a scanned document as an email attachment.	
		(Select USB or PC)	 Options Save as Shortcut		
to E-mail Server	Other Scan to Actions	-	-	Send scanned data to an email server by allowing your machine to communicate with your network and email server.	
	Manual	Next	Save as Shortcut		-
			 Preview (MFC-J6955DW/ MFC-J6957DW)		-
			 Options		-
			Destinations		-
	Add Address	-	-		
	 Destinations	-	-		
	Address Book	Next	Save as Shortcut		-
			 Preview (MFC-J6955DW/ MFC-J6957DW)		-
			 Options		-
Destinations			-		
Add Address			-	-	
 Destinations			-	-	
to FTP (MFC-J3540DW/ MFC-J3940DW/ MFC-J6540DW/ MFC-J6740DW/ MFC-J6940DW)	Other Scan to Actions	-	-	Scan documents directly to an FTP server.	
	(Select Profile name)	 Options	-		
		Save as Shortcut	-		
to FTP/SFTP (MFC-J6555DW/ MFC-J6955DW/ MFC-J6957DW)	Other Scan to Actions	-	-	Send scanned data via FTP/SFTP.	
	(Select Profile name)	 Preview (MFC-J6955DW/ MFC-J6957DW)	-		
		 Options	-		
		Save as Shortcut	-		
to Network	Other Scan to Actions	-	-	Scan documents directly to a CIFS server on your local network.	
	(Select Profile name)	 Preview	-		

Level 3	Level 4	Level 5	Level 6	Descriptions
to Network	(Select Profile name)	(MFC-J6955DW/ MFC-J6957DW)		Scan documents directly to a CIFS server on your local network.
		 Options	-	
		Save as Shortcut	-	
to SharePoint (MFC-J6555DW/ MFC-J6955DW/ MFC-J6957DW)	(Select Profile name)	-	-	Send scanned data via a SharePoint server.
		 Preview (MFC-J6955DW/ MFC-J6957DW)	-	
		 Options	-	
		Save as Shortcut	-	
to Web	-	-	-	Upload the scanned data to an Internet service.
WS Scan (Appears when you install a Web Services Scanner, which is displayed in your computer's Network explorer.)	Other Scan to Actions	-	-	Scan data using the Web Service protocol.
	Scan	-	-	
	Scan for E-mail	-	-	
	Scan for Fax	-	-	
	Scan for Print	-	-	

 [Secure Print]

(MFC-J6955DW/MFC-J6957DW)

Level 1	Level 2	Level 3	Descriptions
Secure Print	(Select User)	-	You can print data saved in the machine's memory when you enter your four-digit password. Active only when the machine has secure print data.





 [Web]

Level 1	Descriptions
Web	Connect the Brother machine to an Internet service.

 [Apps]

Level 1	Descriptions
Apps	Connect the Brother machine to the Brother Apps service.

 [USB]

Level 3	Level 4	Level 5	Level 6	Descriptions
PDF Print (MFC-J6955DW/ MFC-J6957DW)	(Select a PDF file.)	 Print Settings	-	Print a PDF file directly from a USB flash drive.
JPEG Print	Select Files	OK	 Print Settings	Adjust your photos with the options.
		Print All	-	Print all photos in your USB flash drive.
	Index Print	Print Index Sheet	 Print Settings	Print a thumbnail page.
		Print Photos	 Print Settings	Print photos by choosing the index numbers.
Scan to Media	-	-	-	Scan documents into a USB flash drive.
Web	-	-	-	Connect the Brother machine to an Internet service.

 [A3 Copy Shortcuts]

Level 2	Level 3	Level 4	Descriptions
A3 2in1 A3 A4⇒A3 A3⇒A4 A4 + Note (L) A4 + Note (P) A4 + Grid A4 + Blank A4 Centre	 Options	Quality	Select the Copy resolution for your document type.
		Document Size	Select the document size option you want.
		Tray Select (MFC-J3940DW/ MFC-J6555DW/ MFC-J6740DW/ MFC-J6940DW/ MFC-J6955DW/ MFC-J6957DW)	Set the machine to automatically select the tray that contains the most appropriate paper.
		Paper Type	View the available paper type.
		Paper Size	Set the size of paper in the paper tray.
		Density	Adjust the density.
		Auto Deskew	Set the machine to correct a skewed copy.

 [Download Software]

Level 1	Descriptions
Download Software	Displays information about downloading and installing software for mobile devices and computers.



## [Print Head Cleaning]

Level 1	Descriptions
Print Head Cleaning	Clean the print head according to the LCD instructions.



## [Shortcuts]

Level 2	Level 3	Level 4	Descriptions	
+ Add Shortcut	Copy	-	Change the settings in the Copy Options.	
	Fax	-	Change the settings in the Fax Options.	
	Scan	to Media		Scan documents and save them directly to a USB flash drive without using a computer.
		to PC (File)		Scan documents and save them to a folder on your computer.
		to PC (OCR)		Convert your scanned document to an editable text file.
		to PC (Image)		Scan photos or graphics into your graphics applications.
		to PC (E-mail)		Send a scanned document as an email attachment.
		to E-mail Server		Scan a monochrome or a colour document to your email server.
		to Network		Send scanned data to a CIFS server on your local network or on the Internet.
		to FTP (MFC-J3540DW/ MFC-J3940DW/ MFC-J6540DW/ MFC-J6740DW/ MFC-J6940DW)		Send scanned data via FTP.
	to FTP/SFTP (MFC-J6555DW/ MFC-J6955DW/ MFC-J6957DW)		Send scanned data via FTP/SFTP.	
to SharePoint (MFC-J6555DW/ MFC-J6955DW/ MFC-J6957DW)		Send scanned data via a SharePoint server.		
Web	-	Connect the Brother machine to an Internet service.		
Apps	-	Connect the Brother machine to the Brother Apps service.		
This list appears when each Shortcut icon is pressed for 2 seconds.	Rename	-	Change the shortcut name.	
	Edit	-	Change the shortcut settings.	
	Delete	-	Delete the shortcut.	
	Register Card/NFC	-	Assign a Shortcut to an IC card.	
	Delete Card/NFC	-	Remove a Shortcut from an IC card.	

Level 2	Level 3	Level 4	Descriptions
 <b>Edit/Delete</b>	(Select shortcut button.)	<b>Rename</b>	Change the shortcut name.
		<b>Edit</b>	Change the shortcut settings.
		<b>Delete</b>	Delete the shortcut.
		<b>Register Card/NFC</b>	Assign a Shortcut to an IC card.
		<b>Delete Card/NFC</b>	Remove a Shortcut from an IC card.



## [Ink]

Level 2	Level 3	Descriptions
<b>Ink Volume</b>	-	Check the available ink volume.
<b>Ink Cartridge Model</b>	-	Check your ink cartridge numbers.
<b>Improve Print Quality</b>	<b>Check Print Quality</b>	Check and correct the print quality, alignment and paper feeding according to the LCD instructions.
	<b>Alignment</b>	
	<b>Correct Paper Feed</b>	
<b>Print Head Cleaning</b>	-	Clean the print head according to the LCD instructions.
<b>Remove Paper Scraps</b>	-	Remove a piece of paper in the machine according to the LCD instructions.
<b>Clean Paper Pick-up Roller</b> (Available only for some countries.)	-	Clean the rollers according to the LCD instructions.
<b>Print Options</b>	<b>Reduce Smudging</b>	Reduce smudging on the paper or paper jams during printing.
	<b>Reduce Uneven Lines</b>	Reduce uneven lines on the paper during printing.
	<b>Enhance Print</b>	Improve print quality and reduce blurriness.
<b>Ink Cartridge Check</b>	-	View your ink cartridge information.
<b>Print Quality Auto Check</b>	-	Automatically detects the Print Head condition and cleans the Print Head when needed.



## Wi-Fi Setup

Level 2	Descriptions
<b>Find Wi-Fi Network</b>	Configure your wireless network settings manually.
<b>WPS/Push Button</b>	Configure your wireless network settings using the one-button push method.

## When you have put a USB Flash drive in the USB slot

Level 1	Descriptions
<b>PDF Print</b> (MFC-J6955DW/MFC-J6957DW)	Print a PDF file directly from a USB flash drive.
<b>JPEG Print</b>	Select photo menu.
<b>Scan to Media</b>	Scan documents into a USB flash drive.
<b>Web</b>	Connect the Brother machine to an Internet service.



## Related Information

- [Settings and Features Tables](#)

## Change Machine Settings Using Web Based Management

Web Based Management is a utility that uses a standard web browser to manage your machine using the Hyper Text Transfer Protocol (HTTP) or Hyper Text Transfer Protocol over Secure Socket Layer (HTTPS).

- [What is Web Based Management?](#)
- [Access Web Based Management](#)
- [Set or Change a Login Password for Web Based Management](#)
- [Set Up Your Machine's Address Book Using Web Based Management](#)

## What is Web Based Management?

Web Based Management is a utility that uses a standard web browser to manage your machine using the Hyper Text Transfer Protocol (HTTP) or Hyper Text Transfer Protocol over Secure Socket Layer (HTTPS).



- We recommend Microsoft Internet Explorer 11/Microsoft Edge for Windows, Safari 13 for Mac, Google Chrome™ for Android (4.x or later), and Google Chrome™/Safari for iOS (10.x or later). Make sure that JavaScript and Cookies are always enabled in whichever browser you use.
- You must use the TCP/IP protocol on your network and have a valid IP address programmed into the print server and your computer.

The screenshot displays the Brother Web Based Management interface. At the top left, the machine ID 'XXX-XXXX' is shown. The top right features the 'brother' logo. A dark blue sidebar on the left contains a 'Logout' button and a list of menu items: Home, Status (highlighted), Auto Refresh Interval, General, Address Book, Fax, Print, Scan, Administrator, Online Functions, and Network. The main content area is titled 'Status' and includes the following sections: 'Device Status' showing 'Ready' with a green bar; 'Automatic Refresh' with radio buttons for 'Off' (selected) and 'On'; 'Estimated Ink Level' with four colored bars (Magenta, Cyan, Yellow, Black) labeled M, C, Y, BK; 'Remaining Page Yield' showing 'Approximate Page Yield (ISO-based)' with values 'xxxx xxxx xxxx xxxx' for M, C, Y, BK; 'Web Language' with a dropdown menu set to 'Auto'; and 'Device Location' with fields for 'Contact' and 'Location'.

- The actual screen may differ from the screen shown above.



### Related Information

- [Change Machine Settings Using Web Based Management](#)

## Access Web Based Management

- We recommend Microsoft Internet Explorer 11/Microsoft Edge for Windows, Safari 13 for Mac, Google Chrome™ for Android (4.x or later), and Google Chrome™/Safari for iOS (10.x or later). Make sure that JavaScript and Cookies are always enabled in whichever browser you use.
- The default password to manage this machine's settings is located on the back of the machine and marked "Pwd". We recommend immediately changing the default password to protect your machine from unauthorised access. You can also find the default password in the Network Configuration Report.
- If the password is entered incorrectly several times, you will not be able to log in for a while. The lockout settings can be changed in Web Based Management.
- Up to eight computers or mobile devices can be logged in to Web Based Management at the same time. If you log in a ninth device, the first device will be logged out.
- We recommend using the HTTPS security protocol when configuring settings using Web Based Management. If you use HTTP when configuring settings using Web Based Management, follow the screen prompts to switch to a secure HTTPS connection.
- When you use HTTPS for Web Based Management configuration, your browser will display a warning dialog box. To avoid displaying the warning dialog box, you can install a self-signed certificate to use SSL/TLS communication. For more detailed information, see *Related Information*.

>> [Start from Your Web Browser](#)

>> [Start from Brother iPrint&Scan \(Windows/Mac\)](#)

>> [Start from Brother Utilities \(Windows\)](#)

>> [Start from Brother Mobile Connect](#)

### Start from Your Web Browser

1. Start your web browser.
2. Type "https://machine's IP address" in your browser's address bar (where "machine's IP address" is the machine's IP address).

For example:

https://192.168.1.2



- If you are using a Domain Name System or enable a NetBIOS name, you can type another name, such as "SharedPrinter" instead of the IP address.

- For example:

https://SharedPrinter

If you enable a NetBIOS name, you can also use the node name.

- For example:

https://brnxxxxxxxxxxxx

The NetBIOS name can be found in the Network Configuration Report.

3. If required, type the password in the **Login** field, and then click **Login**.
4. If you want to pin the navigation menu on the left side of the screen, click ☰ and then click 🌟.

You can now change the machine settings.

If you change the protocol settings, you must restart the machine after clicking **Submit** to activate the configuration.

After configuring the settings, click **Logout**.

### Start from Brother iPrint&Scan (Windows/Mac)

1. Start Brother iPrint&Scan.



- Windows

Launch  (**Brother iPrint&Scan**).

- Mac

In the **Finder** menu bar, click **Go > Applications**, and then double-click the iPrint&Scan icon.

The Brother iPrint&Scan screen appears.



2. If your Brother machine is not selected, click the **Select your Machine** button, and then select your model name from the list. Click **OK**.
3. Click  (**Machine Settings**).
4. Click **All Settings**.  
Web Based Management appears.
5. If required, type the password in the **Login** field, and then click **Login**.
6. If you want to pin the navigation menu on the left side of the screen, click  and then click .

You can now change the machine settings.

If you change the protocol settings, you must restart the machine after clicking **Submit** to activate the configuration.

After configuring the settings, click **Logout**.

## Start from Brother Utilities (Windows)

1. Launch  (**Brother Utilities**), and then click the drop-down list and select your model name (if not already selected).
2. Click **Tools** in the left navigation bar, and then click **Machine Settings**.  
Web Based Management appears.
3. If required, type the password in the **Login** field, and then click **Login**.
4. If you want to pin the navigation menu on the left side of the screen, click  and then click .



You can now change the machine settings.

If you change the protocol settings, you must restart the machine after clicking **Submit** to activate the configuration.

After configuring the settings, click **Logout**.

## Start from Brother Mobile Connect

You need to install and set up Brother Mobile Connect on your mobile device.

1. Start Brother Mobile Connect on your mobile device.
2. Tap your model name on the top of the screen.
3. Tap **All Machine Settings**.  
Web Based Management appears.
4. If required, type the password in the **Login** field, and then tap **Login**.
5. If you want to pin the navigation menu on the left side of the screen, tap  and then tap .

You can now change the machine settings.

If you change the protocol settings, you must restart the machine after tapping **Submit** to activate the configuration.

After configuring the settings, tap **Logout**.



---

## Related Information

---

- [Change Machine Settings Using Web Based Management](#)

### **Related Topics:**

- [Print the Network Configuration Report](#)
  - [Create a Self-signed Certificate](#)
  - [Install the Self-signed Certificate for Windows users with Administrator Rights](#)
-

## Set or Change a Login Password for Web Based Management

The default password to manage this machine's settings is located on the back of the machine and marked "Pwd". We recommend immediately changing the default password to protect your machine from unauthorised access.

1. Start your web browser.
2. Type "https://machine's IP address" in your browser's address bar (where "machine's IP address" is the machine's IP address).

For example:

https://192.168.1.2



- If you are using a Domain Name System or enable a NetBIOS name, you can type another name, such as "SharedPrinter" instead of the IP address.

- For example:

https://SharedPrinter

If you enable a NetBIOS name, you can also use the node name.

- For example:

https://brnxxxxxxxxxxxx

The NetBIOS name can be found in the Network Configuration Report.

3. Do one of the following:
  - If you have previously set your own password, type it, and then click **Login**.
  - If you have not previously set your own password, type the default login password, and then click **Login**.
4. Go to the navigation menu, and then click **Administrator > Login Password**.



Start from , if the navigation menu is not shown on the left side of the screen.

5. If you want to change the password, type your current password in the **Enter Old Password** field.
6. Following the on-screen **Login Password** guidelines, type your password in the **Enter New Password** field.
7. Retype the password in the **Confirm New Password** field.
8. Click **Submit**.



You can also change the lockout settings in the **Login Password** menu.



### Related Information

- [Change Machine Settings Using Web Based Management](#)

#### Related Topics:

- [Access Web Based Management](#)

## Set Up Your Machine's Address Book Using Web Based Management

- We recommend using the HTTPS security protocol when configuring settings using Web Based Management.
- When you use HTTPS for Web Based Management configuration, your browser will display a warning dialog box.

1. Start your web browser.
2. Type "https://machine's IP address" in your browser's address bar (where "machine's IP address" is the machine's IP address).

For example:

https://192.168.1.2



- If you are using a Domain Name System or enable a NetBIOS name, you can type another name, such as "SharedPrinter" instead of the IP address.

- For example:

https://SharedPrinter

If you enable a NetBIOS name, you can also use the node name.

- For example:

https://brnxxxxxxxxxxxx

The NetBIOS name can be found in the Network Configuration Report.

3. If required, type the password in the **Login** field, and then click **Login**.



The default password to manage this machine's settings is located on the back of the machine and marked "Pwd".

4. Go to the navigation menu, and then click **Address Book > Address XX-XX**.



Start from ☰, if the navigation menu is not shown on the left side of the screen.

5. Add or update the Address Book information as needed.
6. Click **Submit**.



### Related Information

- [Change Machine Settings Using Web Based Management](#)

#### Related Topics:

- [Access Web Based Management](#)

## Appendix

- [Specifications](#)
- [Supply Specifications](#)
- [Brother Help and Customer Support](#)

## Specifications

- >> General Specifications
- >> Document Size Specifications
- >> Print Media Specifications
- >> Fax Specifications
- >> Copy Specifications
- >> USB Flash Drive Specifications
- >> Scanner Specifications
- >> Printer Specifications
- >> Interface Specifications
- >> Network Specifications
- >> Computer Requirements Specifications

### General Specifications

<b>Printer Type</b>	Inkjet	
<b>Print Head</b>	<b>Mono</b>	Piezo with 420 nozzles x 1
	<b>Colour</b>	Piezo with 420 nozzles x 3
<b>Memory Capacity</b>	<ul style="list-style-type: none"> <li>• MFC-J3540DW/MFC-J3940DW/MFC-J6540DW/MFC-J6555DW/MFC-J6740DW/MFC-J6940DW 256 MB</li> <li>• MFC-J6955DW/MFC-J6957DW 512 MB</li> </ul>	
<b>LCD (liquid crystal display) <sup>1</sup></b>	<ul style="list-style-type: none"> <li>• MFC-J3540DW/MFC-J6540DW/MFC-J6740DW 2.7 in. (67.5 mm) TFT Colour Touchscreen LCD</li> <li>• MFC-J3940DW/MFC-J6555DW/MFC-J6940DW/MFC-J6955DW/MFC-J6957DW 3.5 in. (87.6 mm) TFT Colour Touchscreen LCD</li> </ul>	
<b>Power Source</b>	AC 100 to 120 V 50/60 Hz (Taiwan) AC 220 to 240 V 50/60 Hz (Australia and other countries)	
<b>Power Consumption <sup>2</sup></b>	<ul style="list-style-type: none"> <li>• MFC-J3540DW/MFC-J6540DW/MFC-J6740DW <b>Copying</b> <sup>3</sup>: Approx. 29 W <b>Ready</b> <sup>4</sup>: Approx. 5 W <b>Sleep</b> <sup>4</sup>: Approx. 0.9 W <b>Power Off</b> <sup>4 5</sup>: Approx. 0.03 W</li> <li>• MFC-J3940DW (Taiwan) <b>Copying</b> <sup>3</sup>: Approx. 30 W <b>Ready</b> <sup>4</sup>: Approx. 5 W <b>Sleep</b> <sup>4</sup>: Approx. 0.9 W <b>Power Off</b> <sup>4 5</sup>: Approx. 0.02 W</li> <li>• MFC-J3940DW/MFC-J6555DW/MFC-J6940DW (Australia and other countries) <b>Copying</b> <sup>3</sup>: Approx. 29 W <b>Ready</b> <sup>4</sup>: Approx. 5.5 W <b>Sleep</b> <sup>4</sup>: Approx. 0.9 W <b>Power Off</b> <sup>4 5</sup>: Approx. 0.03 W</li> <li>• MFC-J6955DW/MFC-J6957DW <b>Copying</b> <sup>3</sup>: Approx. 31 W <b>Ready</b> <sup>4</sup>: Approx. 6 W</li> </ul>	

**Sleep**<sup>4</sup>: Approx. 0.9 W

**Power Off**<sup>4 5</sup>: Approx. 0.03 W

**Dimensions**

- MFC-J3540DW/MFC-J6540DW

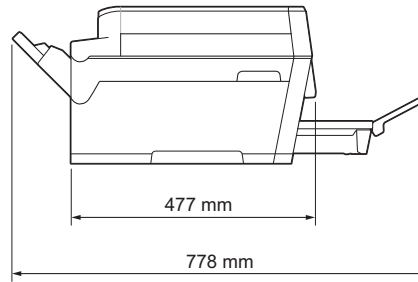
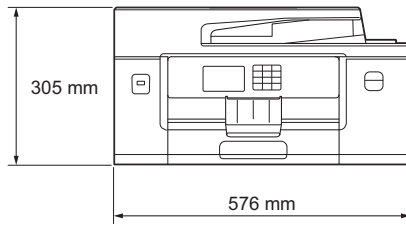

- MFC-J6555DW

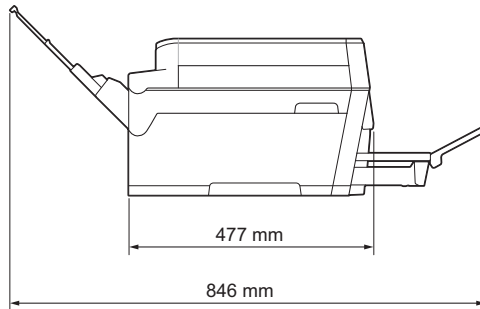
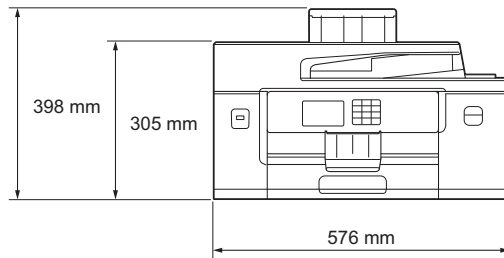

- MFC-J6740DW

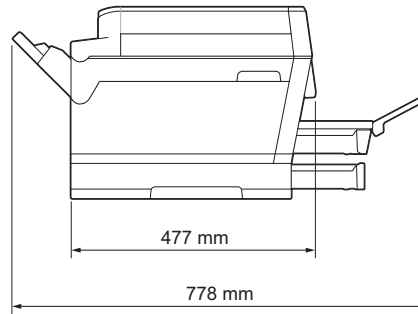
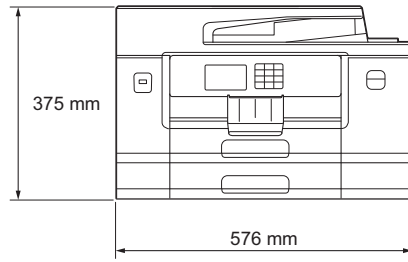

- MFC-J3940DW/MFC-J6940DW/MFC-J6955DW

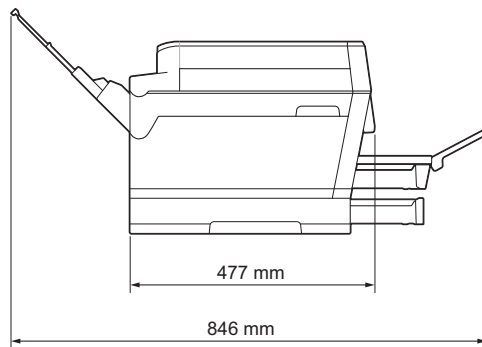
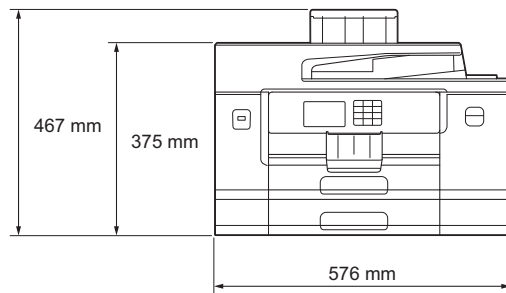

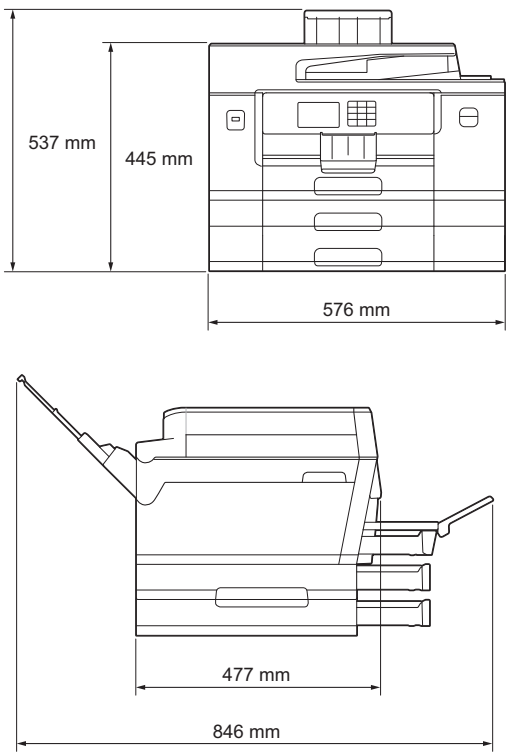
			<ul style="list-style-type: none"> <li>• MFC-J6957DW</li> </ul> 
<b>Weights</b>			<ul style="list-style-type: none"> <li>• MFC-J3540DW/MFC-J6540DW 19.8 kg</li> <li>• MFC-J6555DW 20.1 kg</li> <li>• MFC-J6740DW 23.4 kg</li> <li>• MFC-J3940DW/MFC-J6940DW 23.4 kg</li> <li>• MFC-J6955DW 24.0 kg</li> <li>• MFC-J6957DW 27.5 kg</li> </ul>
<b>Noise Level</b>	<b>Sound Pressure</b> 6	<b>Operating</b>	<ul style="list-style-type: none"> <li>• Printing 50.0 dB (A) (Approx.)</li> <li>• Copying (using the scanner glass) 51.5 dB (A) (Approx.)</li> </ul>
<b>Temperature</b>	<b>Operating</b>		10 to 35°C
	<b>Best Print Quality</b>		20 to 33°C
<b>Humidity</b>	<b>Operating</b>		20 to 80% (without condensation)
	<b>Best Print Quality</b>		20 to 80% (without condensation)
<b>Automatic Document Feeder (ADF)</b>			Up to 50 pages Paper: 80 gsm

1 Measured diagonally.

2 Measured when the machine is connected to the USB interface. Power consumption varies slightly depending on the usage environment or part wear.

3 When using ADF, single-sided printing and scanning, resolution: standard / document: ISO/IEC 24712 printed pattern.

4 Measured according to IEC 62301 Edition 2.0.

5 Even when the machine is turned off, it will automatically turn itself on periodically for print head maintenance, and then turn itself off.

6 Noise depends on printing conditions.

## Document Size Specifications

<b>Document Size</b>	<b>ADF Width</b>	105 to 297 mm
	<b>ADF Length</b> <sup>1</sup>	148 to 431.8 mm
	<b>Scanner Glass Width</b>	Max. 297 mm
	<b>Scanner Glass Length</b>	Max. 431.8 mm

<sup>1</sup> Up to 900 mm when using the long paper function.

## Print Media Specifications

<b>Paper Input</b>	<b>Paper Tray #1</b>	<b>Paper Type</b> <sup>1</sup>	Plain Paper, Inkjet Paper (coated paper), Glossy Paper, Recycled Paper	
		<b>Paper Size</b> <sup>2</sup>	(Landscape) A4, Letter, Executive, B5 (JIS) (Portrait) A3, Ledger, B4 (JIS), Legal, Mexico Legal, India Legal, Folio, A5, B6 (JIS), A6, Envelopes (C5, Com-10, DL, Monarch), Photo (10 x 15 cm), Photo L (9 x 13 cm), Photo 2L (13 x 18 cm), Index card (13 x 20 cm)	
		<b>Maximum Paper Capacity</b>	Up to 250 sheets of 80 gsm plain paper	
	<b>Paper Tray #2</b> (MFC-J3940DW/ MFC-J6740DW/ MFC-J6940DW/ MFC-J6955DW/ MFC-J6957DW)	<b>Paper Type</b>	Plain Paper, Recycled Paper	
		<b>Paper Size</b> <sup>2</sup>	(Landscape) A4, Letter (Portrait) A3, Ledger, B4 (JIS), Legal, Mexico Legal, India Legal, Folio	
		<b>Maximum Paper Capacity</b>	Up to 250 sheets of 80 gsm plain paper	
	<b>Paper Tray #3</b> (MFC-J6957DW)	<b>Paper Type</b>	Plain Paper, Recycled Paper	
		<b>Paper Size</b> <sup>2</sup>	(Landscape) A4, Letter (Portrait) A3, Ledger, B4 (JIS), Legal, Mexico Legal, India Legal, Folio	
		<b>Maximum Paper Capacity</b>	Up to 250 sheets of 80 gsm plain paper	
	<b>Multi-purpose tray (MP tray)</b> <sup>3</sup> (MFC-J3940DW/ MFC-J6555DW/ MFC-J6940DW/ MFC-J6955DW/ MFC-J6957DW)	<b>Paper Type</b> <sup>1</sup>	Plain Paper, Inkjet Paper (coated paper), Glossy Paper, Recycled Paper	
		<b>Paper Size</b> <sup>2</sup> / <b>Maximum Paper Capacity</b>	(Landscape) A4, Letter, Executive, B5 (JIS) (Portrait) A3, Ledger, B4 (JIS), Legal, Mexico Legal, India Legal, Folio, A5, B6 (JIS), A6, Envelopes (C5, Com-10, DL, Monarch), Photo (10 x 15 cm), Photo L (9 x 13 cm), Photo 2L (13 x 18 cm), Index card (13 x 20 cm)	Up to 100 sheets of 80 gsm Plain Paper

			Long Paper (Width: 88.9 - 297 mm / Height: 431.9 - 1200 mm)	Up to 1 sheet
	<b>Manual Feed Slot</b> (MFC-J3540DW/ MFC-J6540DW/ MFC-J6740DW)	<b>Paper Type</b> <sup>1</sup>	Plain Paper, Inkjet Paper (coated paper), Glossy Paper, Recycled Paper	
		<b>Paper Size</b> <sup>2</sup>	(Landscape) A4, Letter, Executive, B5 (JIS) (Portrait) A3, Ledger, B4 (JIS), Legal, Mexico Legal, India Legal, Folio, A5, B6 (JIS), A6, Envelopes (C5, Com-10, DL, Monarch), Photo (10 x 15 cm), Photo L (9 x 13 cm), Photo 2L (13 x 18 cm), Index card (13 x 20 cm)	
		<b>Maximum Paper Capacity</b>	Up to 1 sheet	
<b>Paper Output</b> <sup>1</sup>			<ul style="list-style-type: none"> <li>Up to A4/Letter size paper Up to 100 sheets of 80 gsm Plain Paper (face up print delivery to the output paper tray)</li> <li>Over A4/Letter size paper Up to 50 sheets of 80 gsm Plain Paper (face up print delivery to the output paper tray)</li> </ul>	

<sup>1</sup> For glossy paper, remove any printed pages from the output paper tray immediately to avoid smudging.

<sup>2</sup> B6 (JIS), B5 (JIS) and B4 (JIS) size paper are supported only in some countries.

<sup>3</sup> We recommend using the MP tray for glossy paper.

## Fax Specifications

<b>Compatibility</b>	<ul style="list-style-type: none"> <li>ITU-T Super Group 3</li> </ul>
<b>Modem Speed</b>	<ul style="list-style-type: none"> <li>Automatic Fallback: 33,600 bps</li> </ul>
<b>Scanning Width</b> (Single-sided document)	288 mm (A3)
<b>Scanning Width and Length</b> (2-sided document) (MFC-J3940DW/MFC-J6940DW/MFC-J6955DW/MFC-J6957DW)	Width: 288 mm (A3) (ADF) Length: 425.8 mm (ADF)
<b>Printing Width</b>	291 mm (A3)
<b>Greyscale</b>	Monochrome: 8 bit (256 levels) Colour: 24 bit (8 bit per colour/ 256 levels)
<b>Resolution (Horizontal)</b>	203 dpi
<b>Resolution (Vertical)</b>	Standard: 98 dpi (Mono) 196 dpi (Colour)
	Fine: 196 dpi (Mono) 196 dpi (Colour)
	Superfine: 392 dpi (Mono)
	Photo: 196 dpi (Mono)
<b>Address Book</b>	100 names x 2 numbers or Email addresses
<b>Groups</b>	Up to 6

<b>Broadcasting</b>	250 (200 Address Book/50 Manual Dial)
<b>Automatic Redial</b>	3 times at 5 minute intervals
<b>Memory Transmission</b>	Up to 150 pages <sup>1</sup>
<b>Out of Paper Reception</b>	Up to 150 pages <sup>1</sup>

<sup>1</sup> 'Pages' refers to the 'ITU-T Test Chart #1' (a typical business letter, Standard resolution, MMR code).

## Copy Specifications

<b>Colour/Monochrome</b>	Yes/Yes	
<b>Copy Width</b>	291 mm <sup>1</sup>	
<b>Multiple Copies</b>	Stacks/Sorts up to 999 pages	
<b>Enlarge/Reduce</b>	25% to 400% (in increments of 1%)	
<b>Resolution</b>	Prints up to 1200 × 4800 dpi	
<b>Automatic 2-sided</b> (MFC-J3940DW/MFC-J6940DW/ MFC-J6955DW/MFC-J6957DW)	<b>Paper Type</b>	Plain Paper, Recycled Paper
	<b>Paper Size</b>	A3, Ledger, Legal, Mexico Legal, India Legal, Folio, A4, A5, Letter

<sup>1</sup> When copying on A3 size paper.

## USB Flash Drive Specifications

<b>Compatible Media</b>	USB Flash drive <sup>1</sup>	
<b>JPEG Print</b>	<b>Resolution</b>	Up to 1200 x 4800 dpi
	<b>Paper Type</b>	Plain Paper, Inkjet Paper (coated paper), Glossy Paper, Recycled Paper
	<b>Paper Size</b>	A4, Letter, A3, Ledger, Photo (10 x 15 cm), Photo 2L (13 x 18 cm)
	<b>File Format</b>	JPEG (Progressive JPEG format is not supported)
<b>PDF Print</b> (MFC-J6955DW/MFC-J6957DW)	<b>Resolution</b>	Up to 1200 x 1800 dpi
	<b>Paper Type</b>	Plain Paper, Recycled Paper
	<b>Paper Size</b> <sup>2</sup>	A4, Letter, A3, Ledger, B4 (JIS), Legal, Mexico Legal, India Legal, Folio, B5 (JIS), A5, A6
<b>Scan to Media</b>	<b>File Format</b>	JPEG, PDF (Colour, Grey) TIFF, PDF (Monochrome)

<sup>1</sup> USB Flash drive is not included. Full-Speed USB 2.0. USB Mass Storage standard. Supported formats: FAT12/FAT16/FAT32/exFAT

<sup>2</sup> B5 (JIS) and B4 (JIS) size paper are supported only in some countries.

## Scanner Specifications

<b>Colour/Monochrome</b>	Yes/Yes
<b>TWAIN Compliant</b>	Yes (Windows 7 SP1 / Windows 8.1 / Windows 10)
<b>WIA Compliant</b>	Yes (Windows 7 SP1 / Windows 8.1 / Windows 10)

<b>Colour Depth</b>	48 bit colour processing (Input) 24 bit colour processing (Output)
<b>Greyscale</b>	16 bit colour processing (Input) 8 bit colour processing (Output)
<b>Resolution</b>	Up to 19200 × 19200 dpi (interpolated) <sup>1</sup> Up to 1200 × 2400 dpi (optical) (from Scanner Glass) Up to 600 × 600 dpi (optical) (from ADF)
<b>Scanning Width and Length</b> (Single-sided document)	(Scanner Glass) Width: Up to 295 mm Length: Up to 429.8 mm (ADF) Width: Up to 295 mm Length: Up to 429.8 mm
<b>Scanning Width and Length</b> (2-sided document) (MFC-J3940DW/MFC-J6940DW/MFC-J6955DW/ MFC-J6957DW)	Width: Up to 295 mm (ADF) Length: Up to 429.8 mm (ADF)

<sup>1</sup> Maximum 1200 × 1200 dpi scanning with the WIA driver in Windows 7 SP1, Windows 8.1 and Windows 10 (resolutions up to 19200 × 19200 dpi can be selected using the scanner utility).

## Printer Specifications

<b>Emulation</b> (MFC-J6955DW/MFC-J6957DW)	PCL6, BR-Script3, PDF version1.7, XPS version 1.0	
<b>Resolution</b>	Up to 1200 × 4800 dpi	
<b>Printing Width</b> <sup>1</sup>	291 mm Borderless <sup>2</sup> : 297 mm	
<b>Borderless</b>	A4, Letter, A3, Ledger, A6, Photo (10 x 15 cm), Photo L (9 x 13 cm), Photo 2L (13 x 18 cm), Index card (13 x 20 cm)	
<b>Automatic 2-sided</b>	<b>Paper Type</b>	Plain Paper, Recycled Paper
	<b>Paper Size</b> <sup>3</sup>	A3, Ledger, B4 (JIS), Legal, Mexico Legal, India Legal, Folio, A4, A5, Letter, Executive, B5 (JIS), B6 (JIS)
<b>Print Speed</b>	See your model's page on your local Brother website.	

<sup>1</sup> When printing on A3 size paper.

<sup>2</sup> When the Borderless feature is set to On.

<sup>3</sup> B6 (JIS), B5 (JIS) and B4 (JIS) size paper are supported only in some countries.

## Interface Specifications

<b>USB</b> <sup>1 2</sup>	Use a USB 2.0 interface cable that is no longer than 5 m.
<b>LAN</b>	Use an Ethernet UTP cable category 5 or greater.
<b>Wireless LAN</b>	<ul style="list-style-type: none"> <li>(For Oceania countries) IEEE 802.11a/b/g/n (Infrastructure) IEEE 802.11a/g/n (Wi-Fi Direct)</li> <li>(For ASEAN, Middle East, Africa, South Asian countries and others <sup>3</sup>) IEEE 802.11b/g/n (Infrastructure) IEEE 802.11g/n (Wi-Fi Direct)</li> </ul>

<b>NFC</b> (MFC-J3940DW/MFC-J6940DW/ MFC-J6955DW/MFC-J6957DW)	Yes
---	-----

- 1 Your machine has a USB 2.0 Hi-Speed interface. The machine can also be connected to a computer that has a USB 1.1 interface.
- 2 Third party USB ports are not supported.
- 3 Hong Kong, Macau, and Mongolia.

## Network Specifications



You can connect your machine to a network for Network Printing, Network Scanning, PC-Fax Send, and PC-Fax Receive (Windows only).

<b>Network Security (Wired)</b>	APOP, SMTP-AUTH, SSL/TLS (IPPS, HTTPS, FTPS, SMTP, POP3, IMAP4), SNMP v3, 802.1x (EAP-MD5, EAP-FAST, PEAP, EAP-TLS, EAP-TTLS), Kerberos, IPsec	
<b>Network Security (Wireless)</b>	APOP, SMTP-AUTH, SSL/TLS (IPPS, HTTPS, FTPS, SMTP, POP3, IMAP4), SNMP v3, 802.1x (EAP-FAST, PEAP, EAP-TLS, EAP-TTLS), Kerberos, IPsec	
<b>Wireless Network Security</b> <sup>1</sup>	WEP 64/128 bit, WPA-PSK (TKIP/AES), WPA2-PSK (TKIP/AES), WPA3-SAE (AES)	
<b>Wireless Setup Support Utility</b>	<b>WPS</b>	Yes

- 1 Wi-Fi Direct supports WPA2-PSK (AES) only.

## Computer Requirements Specifications

### Supported Operating Systems And Software Functions

Computer Platform & Operating System Version		PC Interface			Processor	Hard Disk Space to Install <sup>1</sup>	
		USB <sup>2</sup>	Wired LAN	WLAN (Wi-Fi)		For Drivers	For Applications (Including Drivers)
Windows Operating System	Windows 7 SP1 <sup>3 4 5</sup> Windows 8.1 <sup>3 4</sup>	Printing PC Fax <sup>6</sup> Scanning			32 bit (x86) or 64 bit (x64) processor	650 MB	1.3 GB
	Windows 10 Home <sup>3 4</sup> Windows 10 Pro <sup>3 4</sup> Windows 10 Education <sup>3 4</sup> Windows 10 Enterprise <sup>3 4</sup>						
	Windows Server 2008 <sup>5</sup>						
	Windows Server 2008 R2 <sup>5</sup>				64 bit (x64) processor		

	Windows Server 2012 Windows Server 2012 R2 Windows Server 2016 Windows Server 2019				
Mac Operating System 7	macOS v10.14.6 macOS v10.15.x macOS v11	Printing PC-Fax (Send) <sup>6 8</sup> Scanning	64 bit (x64) processor	N/A	550 MB

- 1 An Internet connection is required to install the software if the Brother installation disc is not supplied.
- 2 Third party USB ports are not supported.
- 3 For WIA, 1200 x 1200 resolution. Brother Scanner Utility enables enhancing the resolution up to 19200 x 19200 dpi.
- 4 Nuance™ PaperPort™ 14SE supports Windows 7 SP1, Windows 8.1, Windows 10 Home, Windows 10 Pro, Windows 10 Education and Windows 10 Enterprise.
- 5 Windows 7 SP1 / Windows Server 2008 / Windows Server 2008 R2 supported by Extend Security Updates until Jan 10, 2023.
- 6 PC-Fax supports black and white only.
- 7 Mac OS Disclaimer  
AirPrint capable: Printing or scanning via macOS requires the use of AirPrint. Mac drivers are not provided for this machine.
- 8 AirPrint only.

For the latest driver updates, go to your model's **Downloads** page at [support.brother.com](http://support.brother.com).  
All trademarks, brand and product names are the property of their respective companies.



## Related Information

- [Appendix](#)

## Supply Specifications

>> MFC-J3540DW/MFC-J3940DW/MFC-J6540DW/MFC-J6740DW/MFC-J6940DW  
 >> MFC-J6555DW/MFC-J6955DW/MFC-J6957DW

### MFC-J3540DW/MFC-J3940DW/MFC-J6540DW/MFC-J6740DW/MFC-J6940DW

<b>Ink</b>	The machine uses individual Black, Yellow, Cyan and Magenta ink cartridges that are separate from the print head assembly.			
<b>Service Life of Ink Cartridge</b>	The first time you install a set of ink cartridges the machine will use an amount of ink to fill the ink delivery tubes for high quality printouts. This process will only happen once. After this process is complete the cartridges provided with your machine will have a lower yield than LC432 / LC462 / LC472 cartridges (approximately 65%) <sup>1</sup> . With all following ink cartridges you can print the specified number of pages.			
<b>Replacement Supplies</b>	<b>Ink Cartridge Yield</b>	(For Oceania countries)	(For Middle East, Africa, Pakistan, Bangladesh, and Nepal)	(For other countries)
	Black - Approximately 3000 pages <sup>1</sup> Yellow, Cyan and Magenta - Approximately 1500 pages <sup>1</sup>	<Black> LC432XLBK <Yellow> LC432XLY <Cyan> LC432XLC <Magenta> LC432XLM	<Black> LC472XLBK <Yellow> LC472XLY <Cyan> LC472XLC <Magenta> LC472XLM	<Black> LC462XLBK <Yellow> LC462XLY <Cyan> LC462XLC <Magenta> LC462XLM
	Black, Yellow, Cyan and Magenta - Approximately 550 pages <sup>1</sup>	<Black> LC432BK <Yellow> LC432Y <Cyan> LC432C <Magenta> LC432M	<Black> LC472BK <Yellow> LC472Y <Cyan> LC472C <Magenta> LC472M	<Black> LC462BK <Yellow> LC462Y <Cyan> LC462C <Magenta> LC462M
<b>What is Innobella?</b> 	<p>Innobella is a range of genuine supplies offered by Brother. The name "Innobella" derives from the words "Innovation" and "Bella" (meaning "Beautiful" in Italian) and is a representation of the "innovative" technology providing you with "beautiful" and "long lasting" print results.</p> <p>When you print photo images, Brother recommends Innobella glossy photo paper (BP71 series) for high quality. Brilliant prints are made easier with Innobella Ink and paper.</p>			

<sup>1</sup> All replacement cartridges will provide approximate page yield stated in accordance with ISO/IEC 24711. For more page yield information, see [www.brother.com/pageyield](http://www.brother.com/pageyield).

### MFC-J6555DW/MFC-J6955DW/MFC-J6957DW

<b>Ink</b>	The machine uses individual Black, Yellow, Cyan and Magenta ink cartridges that are separate from the print head assembly.
<b>Service Life of Ink Cartridge</b>	<p>The first time you install a set of ink cartridges the machine will use an amount of ink to fill the ink delivery tubes for high quality printouts. This process will only happen once.</p> <p><b>MFC-J6555DW XL:</b> After this process is complete the cartridges provided with your machine will have a lower yield than LC436XL cartridges (approximately 89% for Black and 80% for colour)<sup>1</sup>. With all following ink cartridges you can print the specified number of pages.</p> <p><b>MFC-J6955DW/MFC-J6957DW:</b> After this process is complete the cartridges provided with your machine will have a lower yield than the replacement cartridges (approximately 78% of LC436 Black and 39% of LC436XL colour)<sup>1</sup>. With all following ink cartridges you can print the specified number of pages.</p>
<b>Replacement Supplies</b>	<Black> LC436XLBK <Yellow> LC436XLY <Cyan> LC436XLC

<b>Replacement Supplies</b>	<Magenta> LC436XLM Black - Approximately 6000 pages <sup>1</sup> Yellow, Cyan and Magenta - Approximately 5000 pages <sup>1</sup>
	<Black> LC436BK <Yellow> LC436Y <Cyan> LC436C <Magenta> LC436M Black - Approximately 3000 pages <sup>1</sup> Yellow, Cyan and Magenta - Approximately 1500 pages <sup>1</sup>

<sup>1</sup> All replacement cartridges will provide approximate page yield stated in accordance with ISO/IEC 24711. For more page yield information, see [www.brother.com/pageyield](http://www.brother.com/pageyield).



## Related Information

- [Appendix](#)

## Brother Help and Customer Support

If you need help with using your Brother product, visit [support.brother.com](http://support.brother.com) for FAQs and troubleshooting tips. You can also download the latest software, drivers and firmware, to improve the performance of your machine, and user documentation, to learn how to get the most from your Brother product.

Further product and support information is available from your local Brother office website. Visit [www.brother.com](http://www.brother.com) to find the contact details for your local Brother office and to register your new product.



### Related Information

- [Appendix](#)
-

brother



OCE/ASA/SAF/GLF  
Version 0