

CDE31 Series

Commercial Display User Guide

IMPORTANT: Please read this User Guide to obtain important information on installing and using your product in a safe manner, as well as registering your product for future service. Warranty information contained in this User Guide will describe your limited coverage from ViewSonic® Corporation, which is also found on our web site at <http://www.viewsonic.com> in English, or in specific languages using the Regional selection box of our website.

Model No. VS20679 | VS20680 | VS20681 | VS20682 | VS20683 | VS20684
P/N: CDE4331 | CDE5531 | CDE6531 | CDE7531 | CDE8631 | CDE9831

Thank you for choosing ViewSonic®

As a world-leading provider of visual solutions, ViewSonic® is dedicated to exceeding the world's expectations for technological evolution, innovation, and simplicity. At ViewSonic®, we believe that our products have the potential to make a positive impact in the world, and we are confident that the ViewSonic® product you have chosen will serve you well.

Once again, thank you for choosing ViewSonic®!

Safety Precautions

Please read the following **Safety Precautions** before you start using the device.

- Keep this user guide in a safe place for later reference.
- Read all warnings and follow all instructions.
- Do not use the device near water. To reduce the risk of fire or electric shock, do not expose the device to moisture.
- Never remove the rear cover. This display contains high-voltage parts. You may be seriously injured if you touch them.
- Avoid exposing the device to direct sunlight or other sources of sustained heat.
- Do not install near any heat sources such as radiators, heat registers, stoves, or other devices (including amplifiers) that may increase the temperature of the device to dangerous levels.
- Use a soft, dry cloth to clean the external housing. For more information, refer to the "Maintenance" section.
- When moving the device, be careful not to drop or bump the device on anything.
- Do not place the device on an uneven or unstable surface. The device may fall over resulting in an injury or a malfunction.
- Do not place any heavy objects on the device or connection cables.
- If smoke, an abnormal noise, or a strange odor is present, immediately turn the device off and call your dealer or ViewSonic®. It is dangerous to continue using the device.
- The device is a monitor with an LED backlight intended for general office use.
- Do not attempt to circumvent the safety provisions of the polarized or grounding-type plug. A polarized plug has two blades with one wider than the other. A grounding-type plug has two blades and a third grounding prong. The wide blade and the third prong are provided for your safety. If the plug does not fit into your outlet, obtain an adapter and do not attempt to force the plug into the outlet.
- When connecting to a power outlet, DO NOT remove the grounding prong. Please ensure grounding prongs are NEVER REMOVED.
- Protect the power cord from being treaded upon or pinched, particularly at the plug, and at the point where it emerges from the equipment. Ensure that the power outlet is located near the equipment so that it is easily accessible.
- Only use attachments/accessories specified by the manufacturer.
- When a cart is used, use with caution when moving the cart/equipment combination to avoid injury from tipping over.

- Disconnect the power plug from the AC outlet if the device is not being used for a long period of time.
- Place the device in a well-ventilated area. Do not place anything on the device that prevents heat dissipation. Also, avoid any direct lighting.

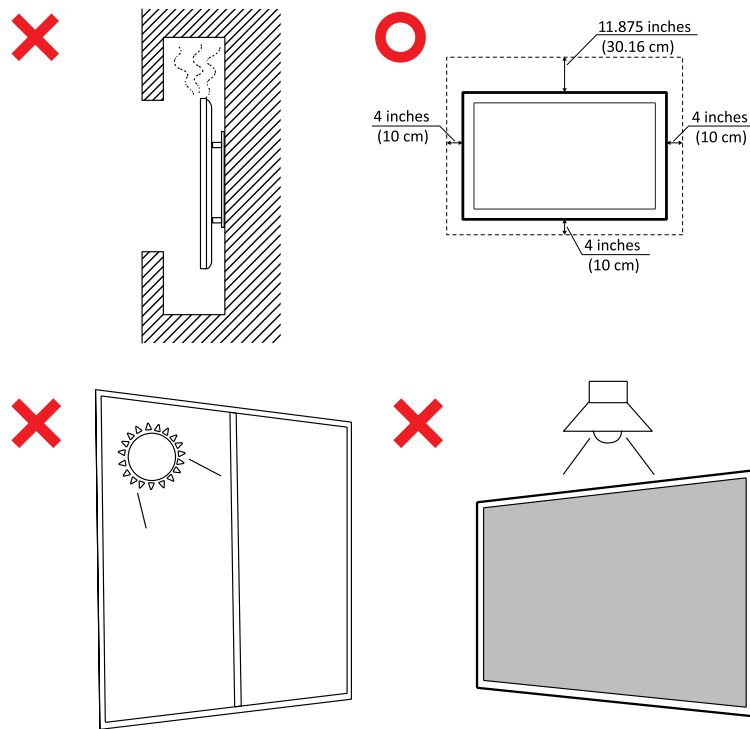

IMPORTANT

To ensure the optimal performance and longevity of your display, it is essential to follow the recommended handling, mounting, and storage procedures. Placing the display in a horizontal position can lead to a range of potential issues, including:

- Excessive stress on the display's structural components, resulting in the formation of cracks or distortions along the edges.
- Uneven weight distribution, which can cause the screen to warp, sustain internal damage, or crack over time.
- Thermal-related damage, as the internal components may not be able to dissipate heat as intended, leading to potential failure or permanent damage.

Furthermore, altering the display's form can also compromise the integrity of its internal components, including the sensitive LCD cells, which can result in a permanent degradation of the display's quality.

To prevent such issues and maintain the display's optimal condition, it is recommended to always mount, handle, transport, and store it in a vertical position. Failure to do so may void the warranty and compromise the display's performance and lifespan.

NOTE: Any damage resulting from the misuse or improper handling of the display is not covered under warranty.

CAUTION:

Immediately unplug your device from the wall outlet and refer servicing to a qualified service personnel under the following conditions:

- When the power supply cord or plug is damaged.
- If liquid has been spilled onto or objects have fallen into the unit.
- If the unit has been exposed to moisture.
- If the unit does not operate normally or has been dropped.

Never place the device in an unstable location. The device may fall, causing serious personal injury or death. Many injuries, particularly to children, can be avoided by taking simple precautions such as:

- Using cabinets or stands recommended by the manufacturer of the device.
- Only using furniture that can safely support the device.
- Ensuring the device is not overhanging the edge of the supporting furniture.
- Not placing the device on tall furniture (e.g., cupboards or bookcases) without anchoring both the furniture and the device to a suitable support.
- Not placing the device on cloth or other materials that may be located between the device and supporting furniture.
- Educating children about the dangers of climbing on furniture to reach the device or its controls.

If the existing device is going to be retained and relocated, the same considerations as above should be applied.

Contents

Safety Precautions.....	3
Contents.....	6
Introduction	10
Package Contents	10
Wall Mounting Specifications (VESA)	11
CDE4331	11
CDE5531	12
CDE6531	13
CDE7531	14
CDE8631	15
CDE9831	16
Product Overview	17
CDE4331	17
CDE5531	18
CDE6531	19
CDE7531	20
CDE8631	21
CDE9831	22
Control Panel	23
I/O Panel.....	24
Remote Control	26
Inserting Remote Control Batteries	27
Remote Control Receiver Range	28

Making Connections	29
Connecting to Power	29
Connecting External Devices	30
USB Type C Connection	30
HDMI Connection	30
RS-232 Connection	31
USB Connection	32
USB Type A	32
USB Type C	32
Network Connection.....	33
Media Connection	33
Audio Connections.....	34
Audio In	34
Audio Out	34
SPDIF	35
Video Output Connection (HDMI Out)	36
Optional Connections	37
Slot-in PC (OPS Slot) Installation	37
Wi-Fi Card (Wi-Fi Slot) Installation	38
Using Your Display	39
Powering On/Off Your Display.....	39
Initial Launch Setup	40
Home Screen	42
General Settings	43
Network.....	44
Device.....	48
System.....	56
General Settings Menu Tree	58
On-Screen Display (OSD) Menu	60
Picture	61
Low Blue Light Filter and Eye Health.....	62
PIP	64
Tiling.....	65
Audio.....	66
Time.....	67
Advanced.....	68
About.....	72
On-Screen Display (OSD) Menu Tree	73

Pre-installed Applications and Settings.....	80
AirSync.....	80
Manager	81
Chromium.....	82
Office	83
Revel Digital Player	84
vSweeper	85
Folders	86
RS-232 Protocol.....	88
Description	88
RS-232 Hardware Specification	88
LAN Hardware Specification.....	89
RS-232 Communication Setting.....	89
LAN Communication Setting	89
Command Message Reference.....	89
Protocol	90
Set-Function Listing.....	90
Appendix.....	95
USB Media Support Format.....	95
Photo.....	95
Video	96
Audio	100
Timing Table	101
HDMI PC Type C.....	101
HDMI	102
Type C.....	103
Troubleshooting	104
Maintenance.....	106

Regulatory and Service Information	107
Compliance Information.....	107
FCC Compliance Statement.....	107
Industry Canada Statement.....	107
CE Conformity for European Countries.....	108
Declaration of RoHS2 Compliance.....	109
ENERGY STAR Statement.....	110
Indian Restriction of Hazardous Substances	111
Product Disposal at End of Product Life	111
Copyright Information	112
Customer Service.....	113
Limited Warranty	114
Mexico Limited Warranty.....	117

Introduction

Package Contents

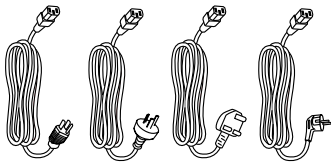

Power Cable (3 m/ 9.84 ft)



HDMI Cable (3 m/9.84 ft)



Remote Control



AAA Battery x 2

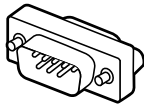

RS-232 Adapter

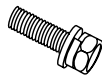

Wall Mount Screw x 4



Compliance Statement



Quick Start Guide

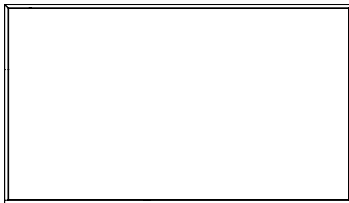

LCD Display

NOTE: This product includes a power cable. The plug type and quantity vary depending on your country. Please contact your local reseller for more information.

Wall Mounting Specifications (VESA)

NOTE: Please follow the instructions in the wall mount installation guide to install your wall mount or mobile mount bracket. If attaching to other building materials, please contact your nearest dealer.

CDE4331

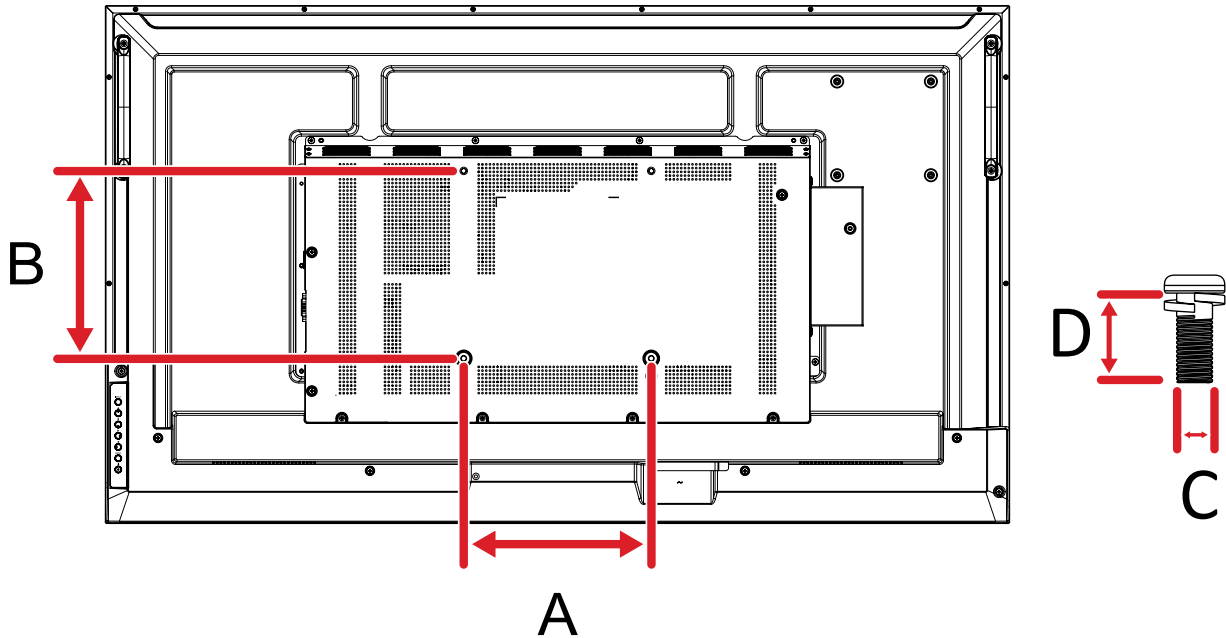

Model	VESA Spec. (A x B)	Standard Screw (C x D)	Quantity
CDE4331	200 x 200 mm	M6 x 12 mm	4

NOTE: Do not use screws that are longer than the standard dimension, as they may cause damage to the inside of the display.

CDE5531

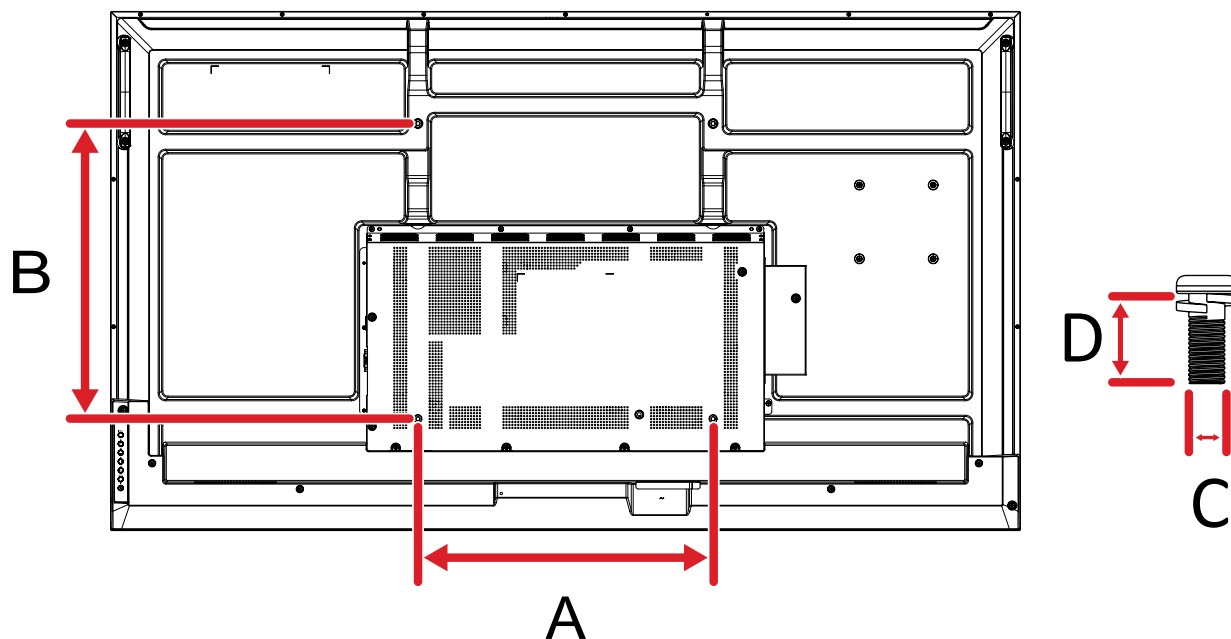

Model	VESA Spec. (A x B)	Standard Screw (C x D)	Quantity
CDE5531	400 x 400 mm	M6 x 12 mm	4

NOTE: Do not use screws that are longer than the standard dimension, as they may cause damage to the inside of the display.

CDE6531

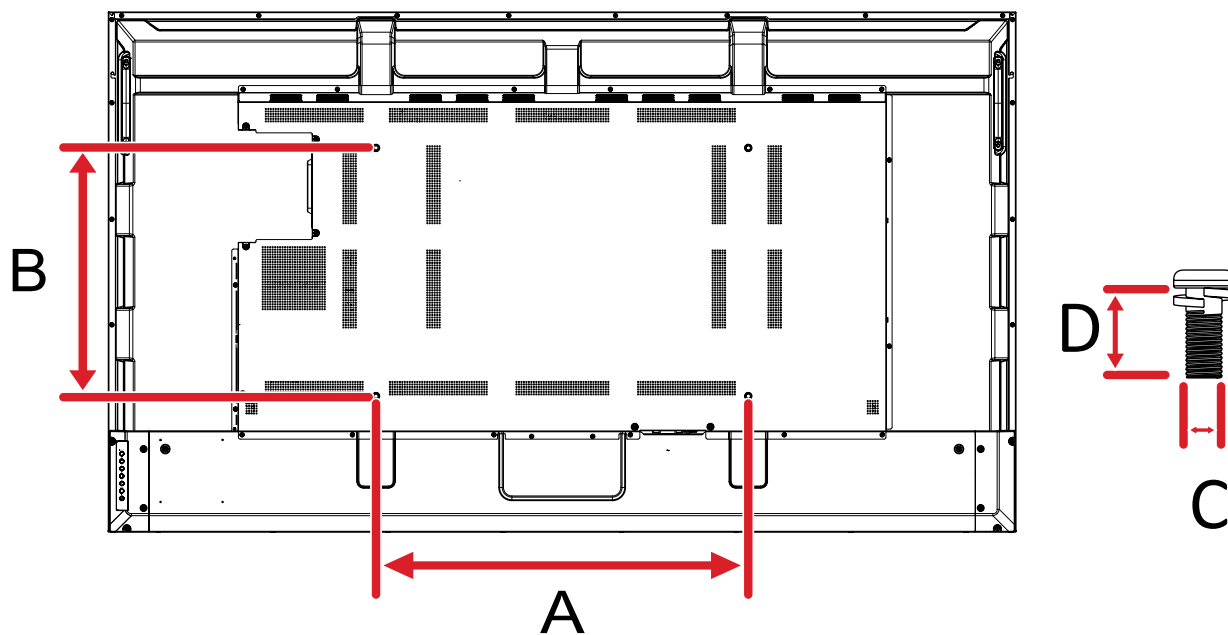

Model	VESA Spec. (A x B)	Standard Screw (C x D)	Quantity
CDE6531	600 x 400 mm	M8 x 25 mm	4

NOTE: Do not use screws that are longer than the standard dimension, as they may cause damage to the inside of the display.

CDE7531

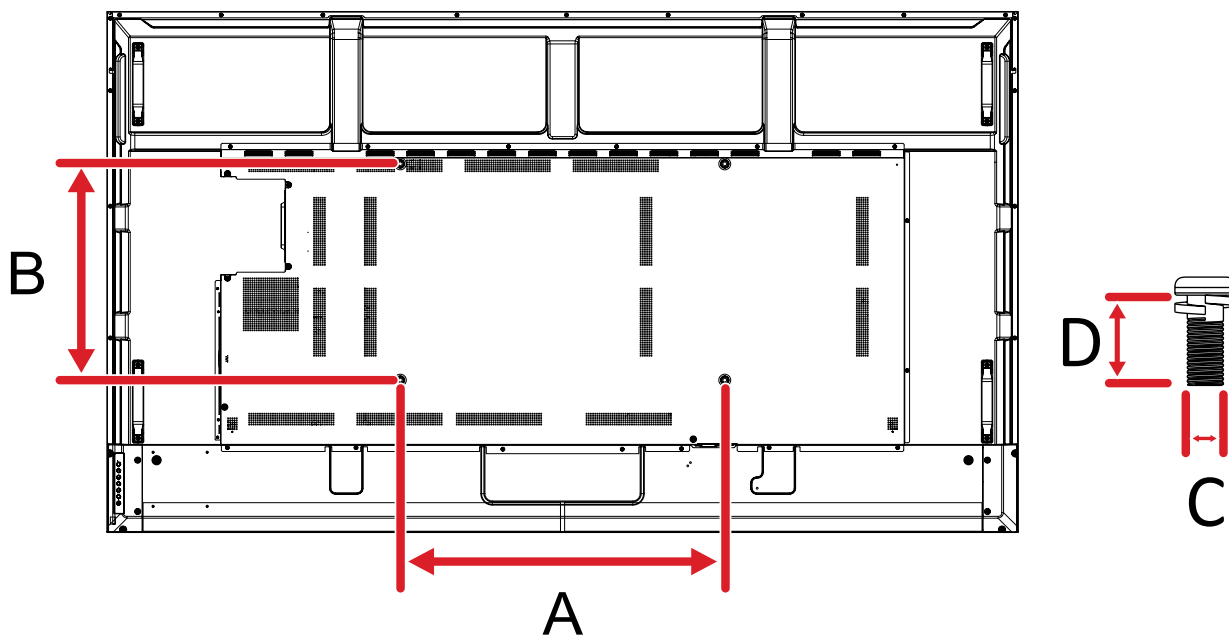

Model	VESA Spec. (A x B)	Standard Screw (C x D)	Quantity
CDE7531	600 x 400 mm	M8 x 25 mm	4

NOTE: Do not use screws that are longer than the standard dimension, as they may cause damage to the inside of the display.

CDE8631

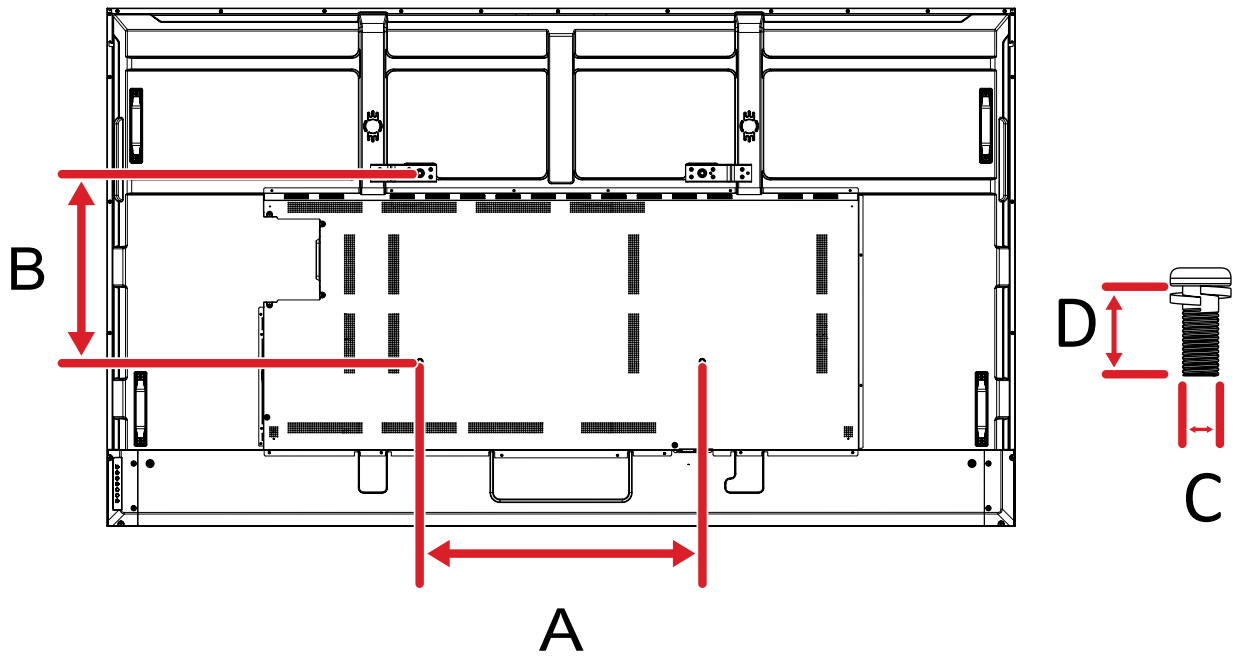

Model	VESA Spec. (A x B)	Standard Screw (C x D)	Quantity
CDE8631	600 x 400 mm	M8 x 25 mm	4

NOTE: Do not use screws that are longer than the standard dimension, as they may cause damage to the inside of the display.

CDE9831

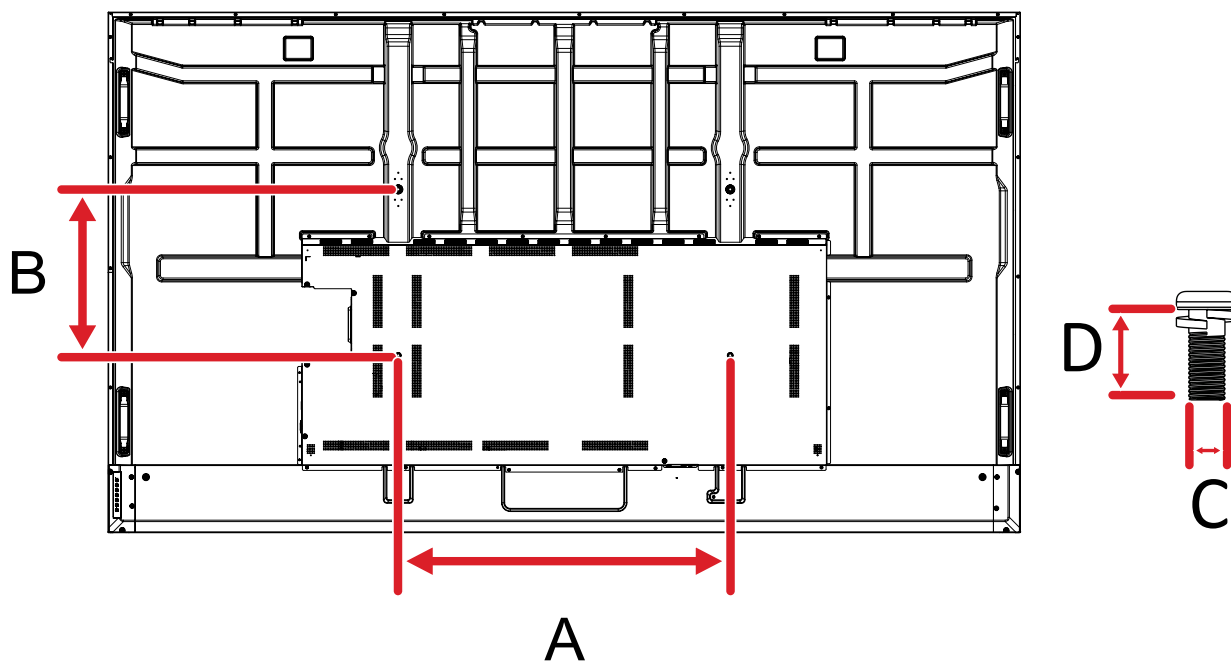

Model	VESA Spec. (A x B)	Standard Screw (C x D)	Quantity
CDE9831	800 x 400 mm	M8 x 25 mm	4

NOTE: Do not use screws that are longer than the standard dimension, as they may cause damage to the inside of the display.

Product Overview

CDE4331

Front Panel



Rear Panel

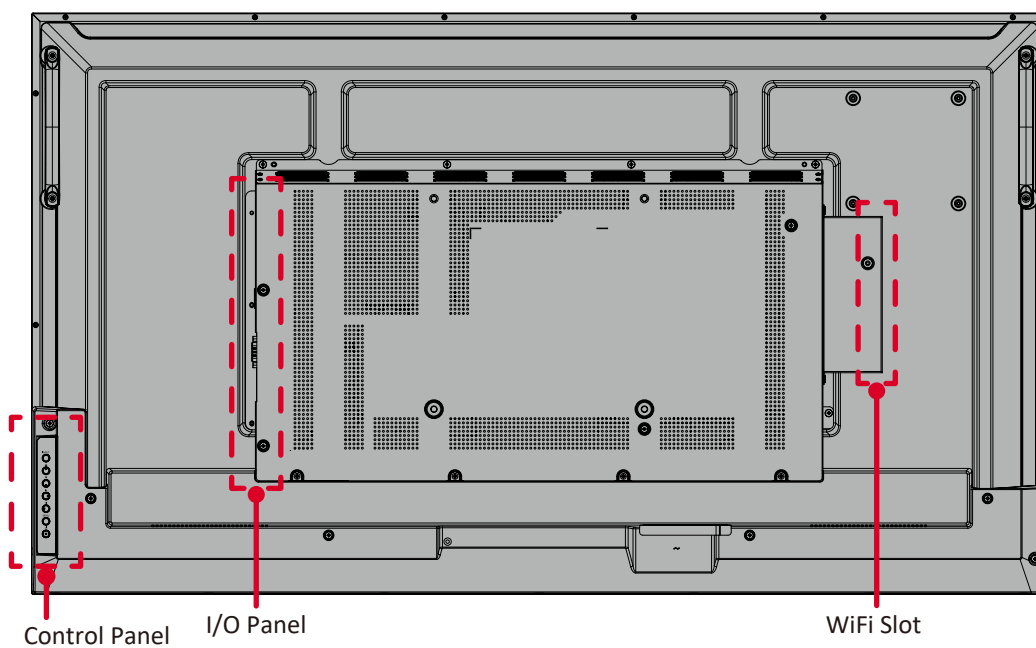

CDE5531

Front Panel



Rear Panel

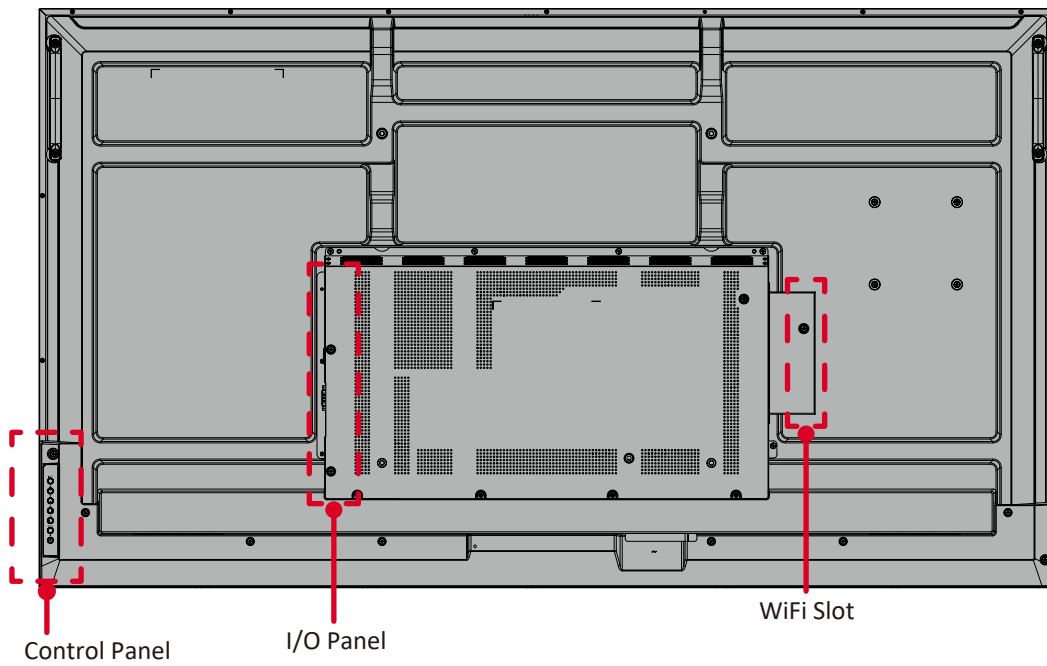

CDE6531

Front Panel



Rear Panel

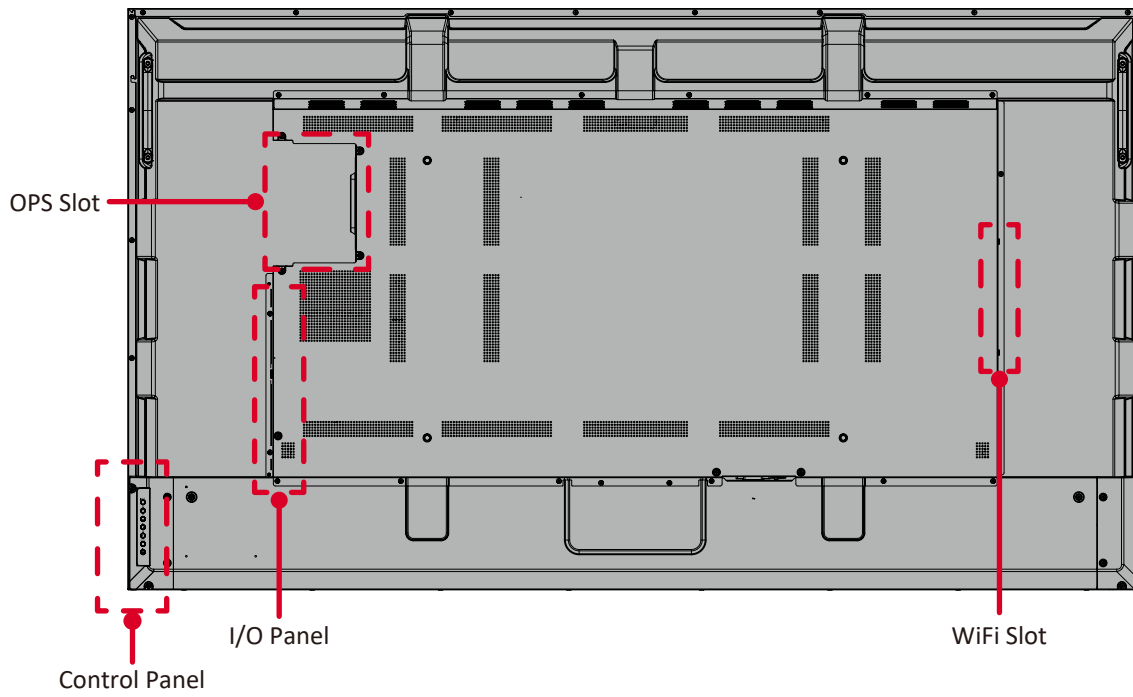

CDE7531

Front Panel



Rear Panel

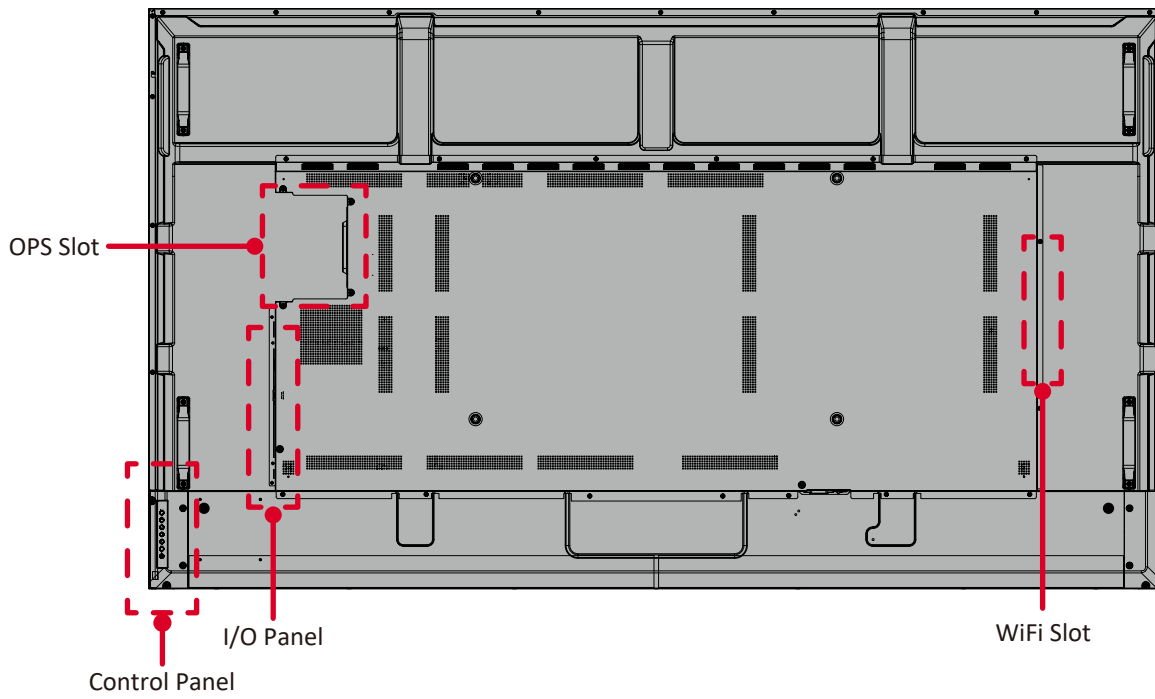

CDE8631

Front Panel



Rear Panel

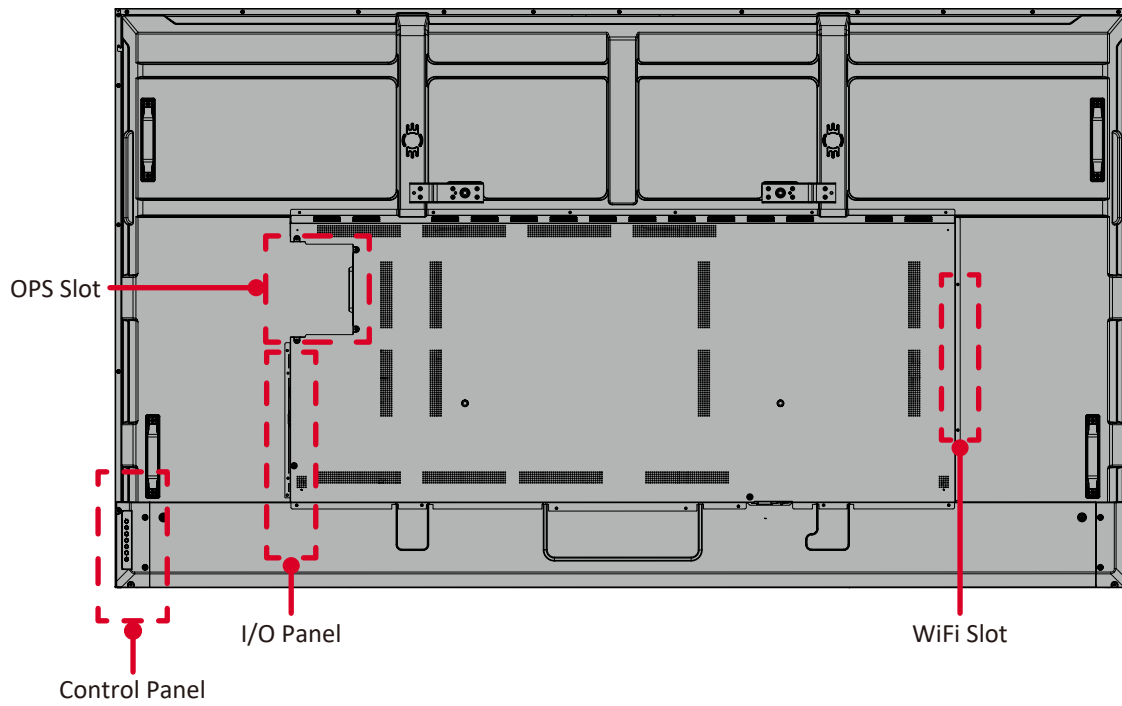

CDE9831

Front Panel



Rear Panel

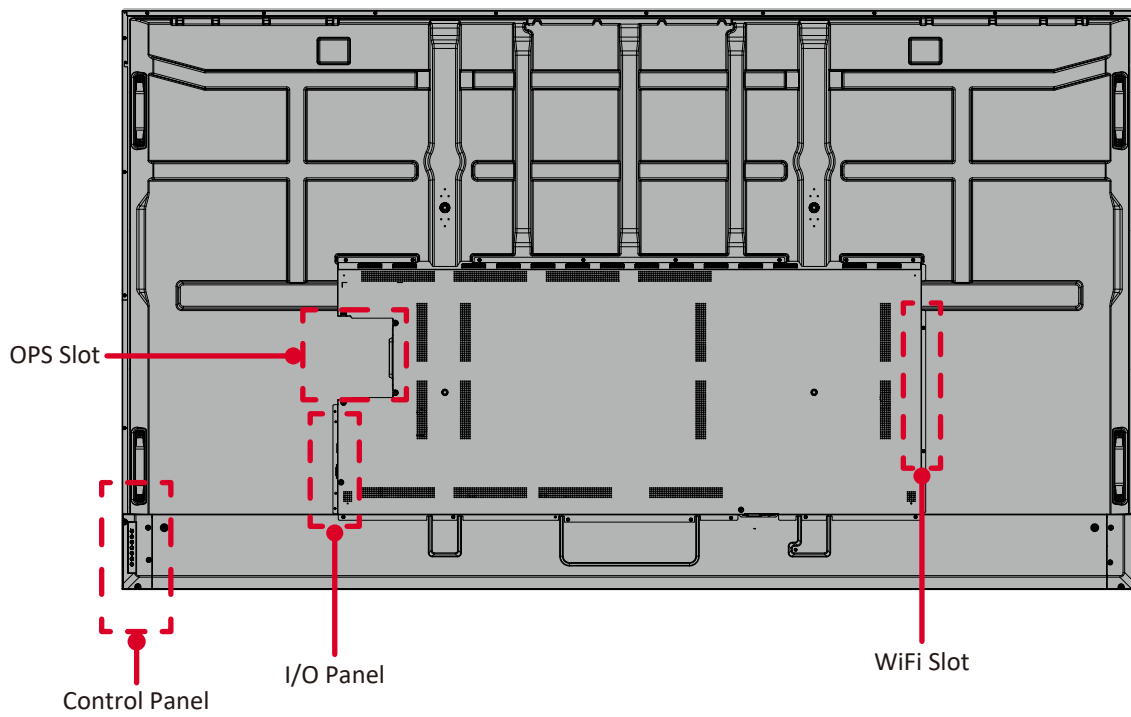

Control Panel

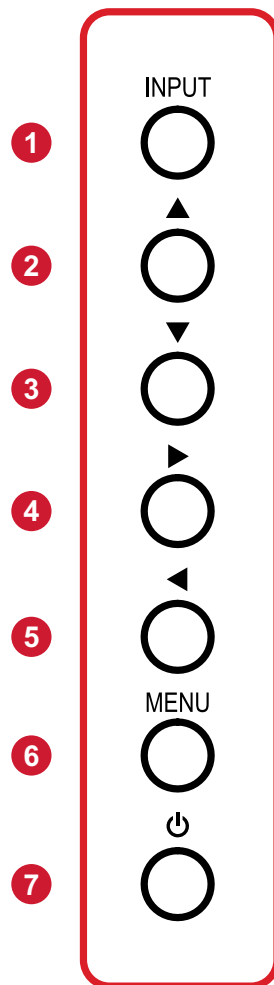

Number	Button	Description
1	Input	<ul style="list-style-type: none"> Press the INPUT key to enter the input source menu, and press the Arrow keys to select the signal source. Confirm an operation under the MENU key operations.
2	Up	In the OSD Menu, press to select an item.
3	Down	In the OSD Menu, press to select an item.
4	Right/Volume Decrease	<ul style="list-style-type: none"> Decrease the volume level. In the OSD Menu, press to adjust the value of the selected item.
5	Left/Volume Increase	<ul style="list-style-type: none"> Increase the volume level. In the OSD Menu, press to adjust the value of the selected item.
6	Menu	<ul style="list-style-type: none"> Press the MENU key to enter the main menu. Confirm the operation in the input source menu.
7	Power	Press to turn on/off the display.

I/O Panel

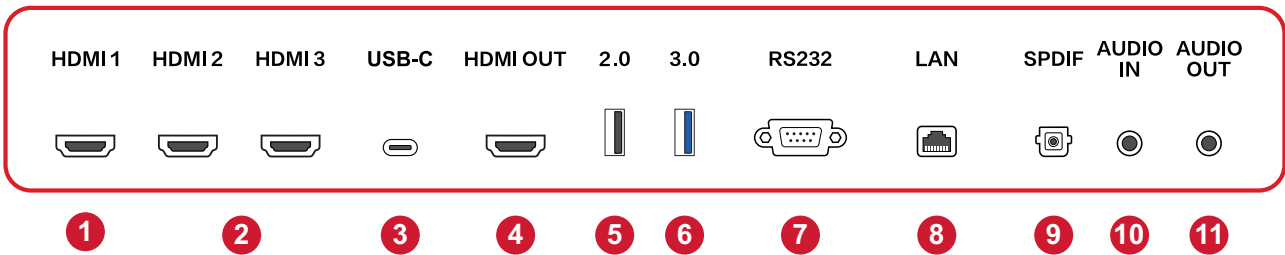

Number	Port	Description
1	HDMI 1	<ul style="list-style-type: none"> Support HDMI v. 2.0; CEC; ARC. High definition input. Connect to a PC with HDMI output, set-top box, or other video device.
2	HDMI 2/3 ¹²	<ul style="list-style-type: none"> Support HDMI v. 2.0; CEC. High definition input. Connect to a PC with HDMI output, set-top box, or other video device. Support connecting multiple displays (tiling).
3	USB-C	<ul style="list-style-type: none"> USB Type C input. USB 2.0 standard with DP 1.2 support. 10M/100M Ethernet. Transfer audio, video, data, and power. Support 5V/3A (15W), 9V/3A (27W), 12V/3A (36W), 15V/3A (45W), 20V/3.25A (65W) power delivery.
4	HDMI OUT ³	<ul style="list-style-type: none"> Support 4K @ 60 Hz, HDCP 2.2. Tiled matrices support up to 5 x 5. HDMI output for external device input.
5	2.0 (Type A)	<ul style="list-style-type: none"> USB Type A input. USB 2.0 standard. Connect USB devices such as thumb drives, keyboard, mouse, etc. Output rating: 5Vdc/900mA.

1– To turn on the display using the **HDMI 2/3** port, make sure **Mode 3** is selected in the **Advanced > Power Save** menu, and **Low Energy Mode** is selected during the initial setup.

2– Unlike the **HDMI 1** port, the **HDMI 2/3** ports are optimized to support the tiling feature. Therefore, when in **Power Save Mode 1, Mode 2, or Mode 4**, the display cannot be turned on via HDMI wake-up. For more information, refer to “Advanced”.

3– The **HDMI Out** port recognizes input signals only from the **HDMI 2/3** port, **USB-C** port, or **OPS slot** (select models). Passthrough from an embedded player or the **HDMI 1** port is not supported.

Number	Port	Description
6	3.0 (Type A)	<ul style="list-style-type: none"> • USB Type A input. • USB 3.2 standard. • Connect USB devices such as thumb drives, keyboard, mouse, etc. • Output rating: 5Vdc/900mA.
7	RS232	Serial interface.
8	LAN	Standard RJ45 (10M/100M/1G) Internet connection and TCP/IP control.
9	SPDIF	Multichannel digital audio output to an external audio amplifier.
10	AUDIO IN	3.5 mm jack for external audio input.
11	AUDIO OUT	3.5 mm jack for audio output to external speakers or an external audio amplifier ⁴ .

4– This output may drive the audio output to potentially dangerous levels.

Remote Control

Number	Description
1	Power on/off
2	Screen capture
3	Back to the Home screen
4	Back/Return to the previous page
5	Increase/Decrease the Volume
6	Number Keypad
7	Information
8	Input source selection
9	Media control buttons: <ul style="list-style-type: none"> • Red: Play/Pause • Green: Stop • Yellow: Forwards • Blue: Backwards
10	Settings menu
11	Up/Down/Right/Left/OK
12	Freeze screen
13	Mute/Unmute
14	Increase/Decrease Brightness
15	Blank Screen
16	Adjust Aspect Ratio

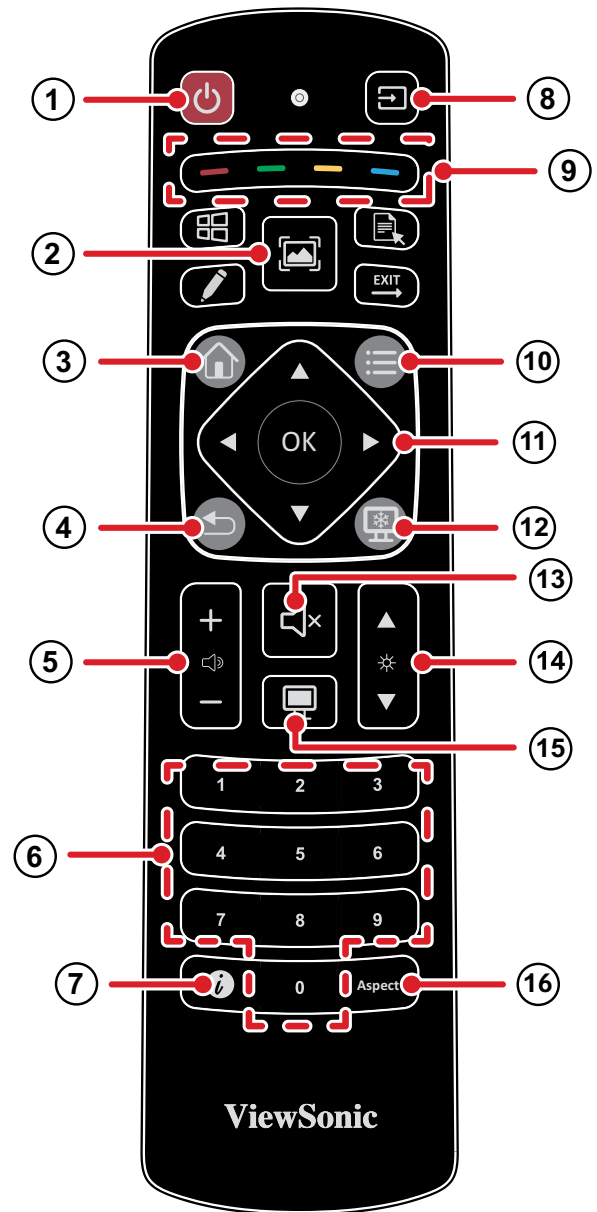

Inserting Remote Control Batteries

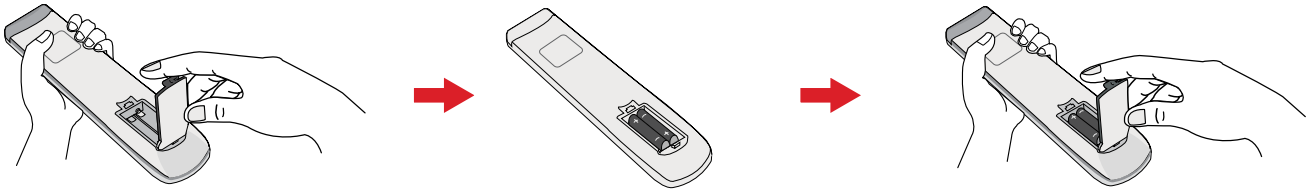

To insert batteries into the remote control:

1. Remove the cover on the rear of the remote control.
2. Insert two “AAA” batteries, ensuring the “+” symbol on the battery matches the “+” on the battery post.
3. Replace the cover by aligning it with the slot on the remote control and snapping the latch shut.

WARNING: There is a risk of explosion if batteries are replaced with the incorrect type.

NOTE:

- It is recommended that you do not mix battery types.
- Always dispose of old batteries in an environmentally friendly way. Contact your local government for more information on how to dispose of batteries safely.

Remote Control Receiver Range

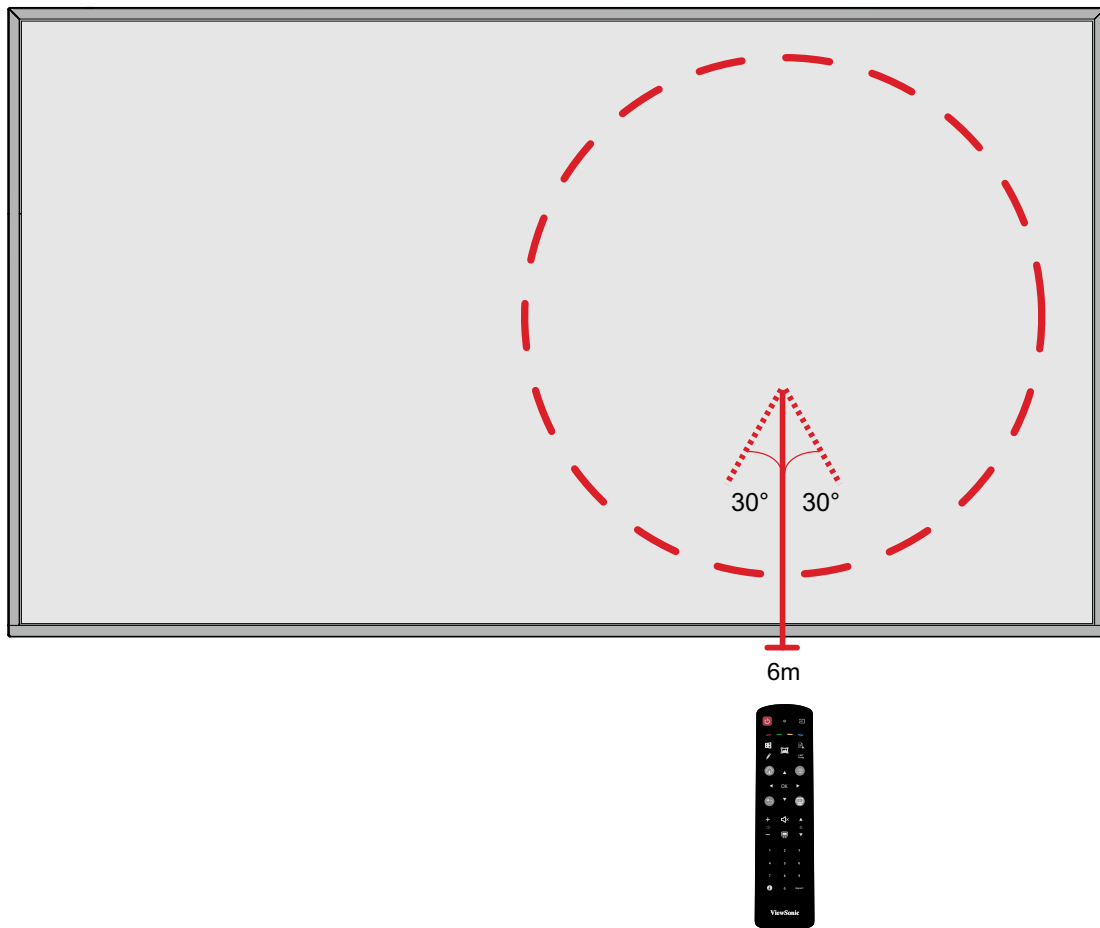

The working range of the remote control is shown here. It has an effective range of 6 meters, 30° degrees left and right. Ensure there is nothing obstructing the remote control's signal to the receiver.

Making Connections

Connecting to Power

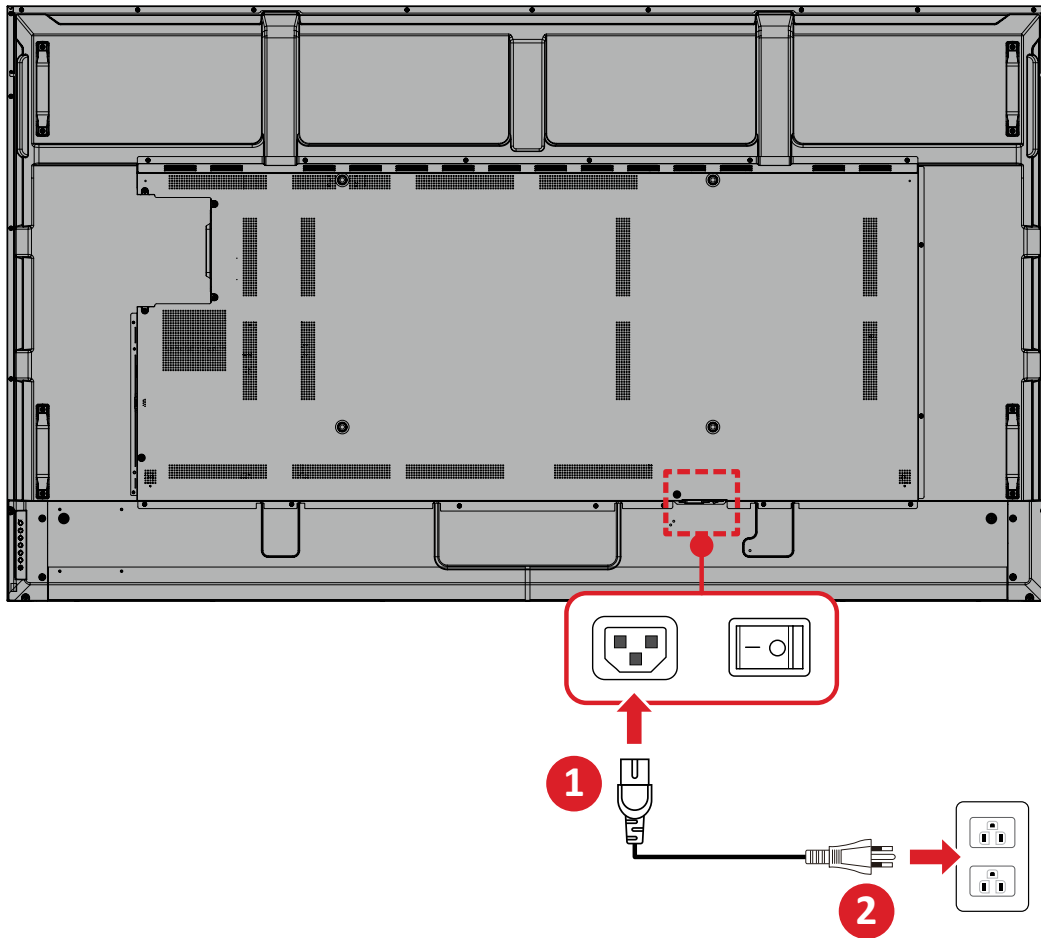

1. Connect the power cord to the **AC IN** jack at the rear of the display.
2. Plug the power cord plug into a power outlet.

Connecting External Devices

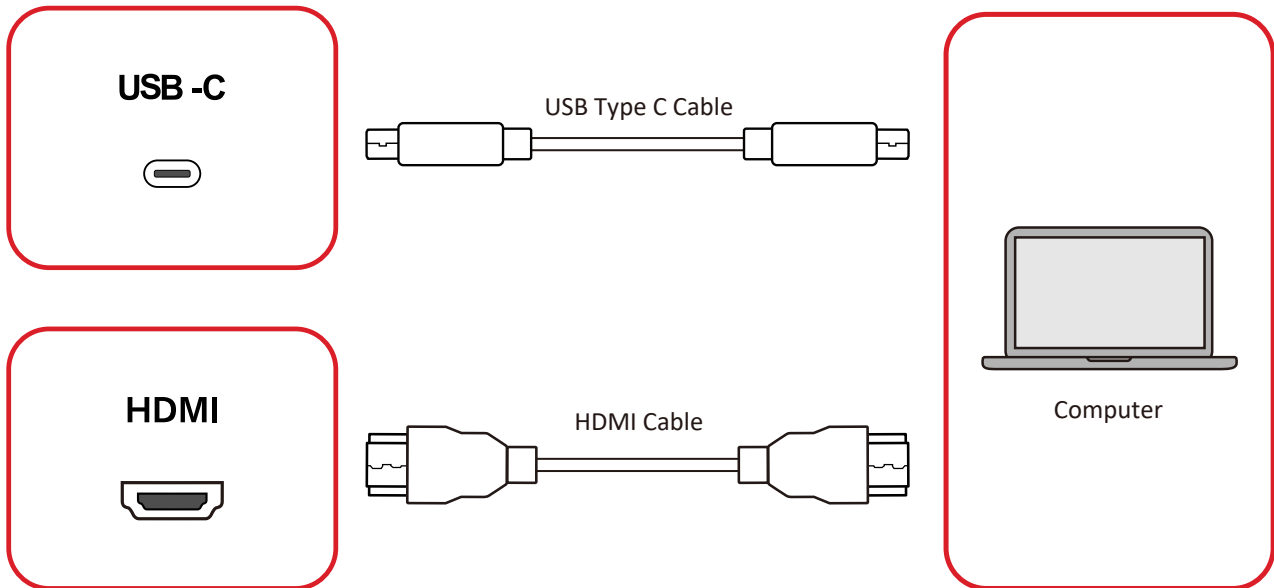

Your external device(s) can be connected in any of the following configurations:

USB Type C Connection

To connect via USB Type C:

Connect a USB Type C cable from your external device to the USB Type C port on the display.

NOTE: For video output use, make sure your USB Type C output device (e.g., laptop) and cable support video signal transmission.

HDMI Connection

To connect via HDMI:

Connect an HDMI cable from your external device to the **HDMI 1/HDMI 2/HDMI 3** port on the display.

RS-232 Connection

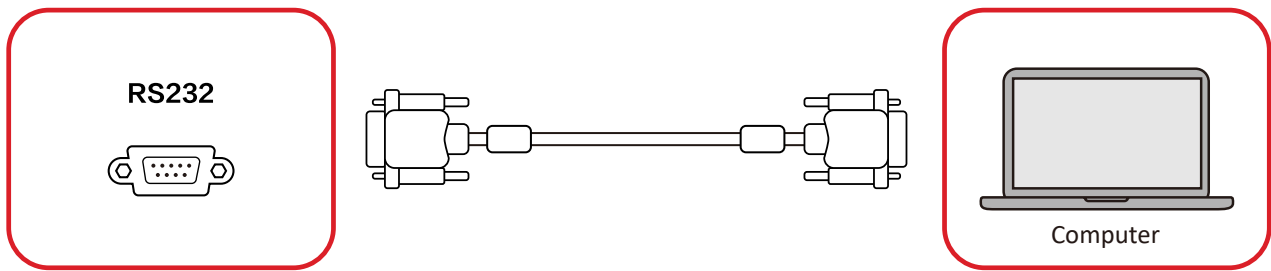

When you use a RS-232 serial cable to connect the display to an external computer or control system, certain functions can be controlled remotely such as: power on and off, volume adjustment, input select, brightness, and more.

NOTE: A crossover cable is required for connection. If you are using a straight-through cable, plug the included adapter (female) to the display's RS-232 port (male).

USB Connection

Just like any PC, it is easy to connect various USB devices and other peripherals to your display.

NOTE: The USB ports only support the FAT32 file system.

USB Type A

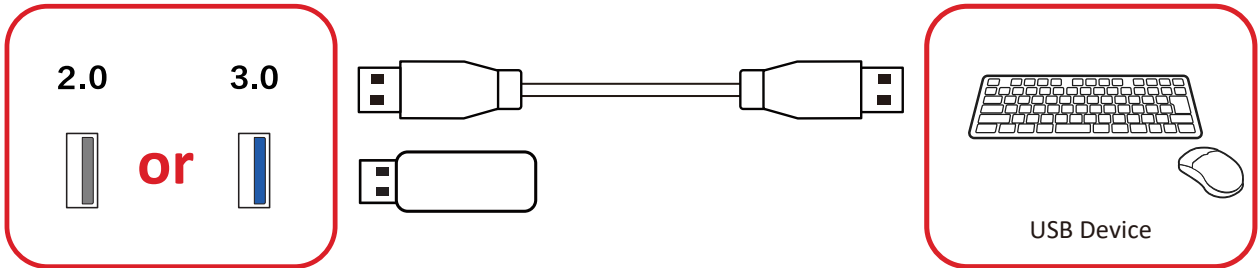

Plug the USB device or storage drive into a USB Type A port of the display.

USB Type C

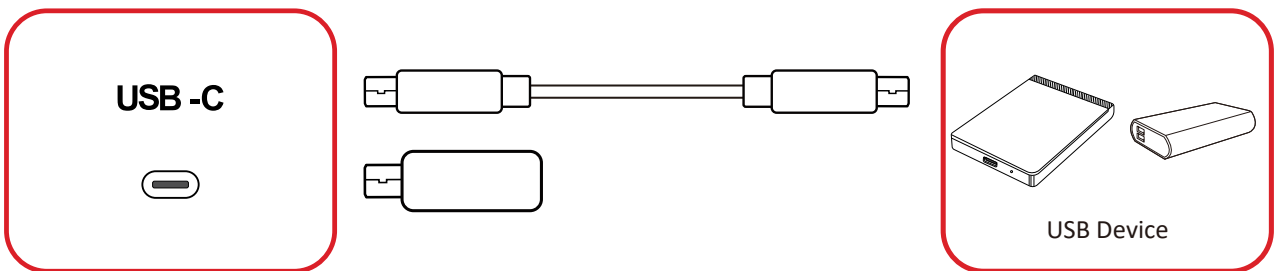

Plug the USB device or storage drive into a USB Type C port of the display.

Network Connection

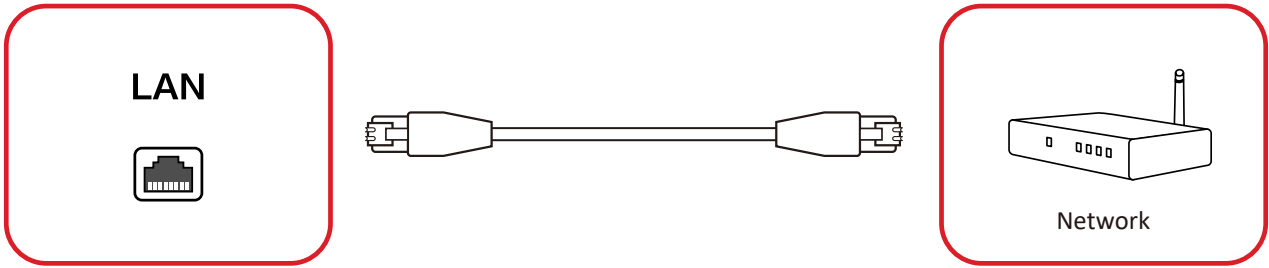

To connect to a local network, connect an Ethernet cable to your network, then connect the other end to a LAN port of the display.

Media Connection

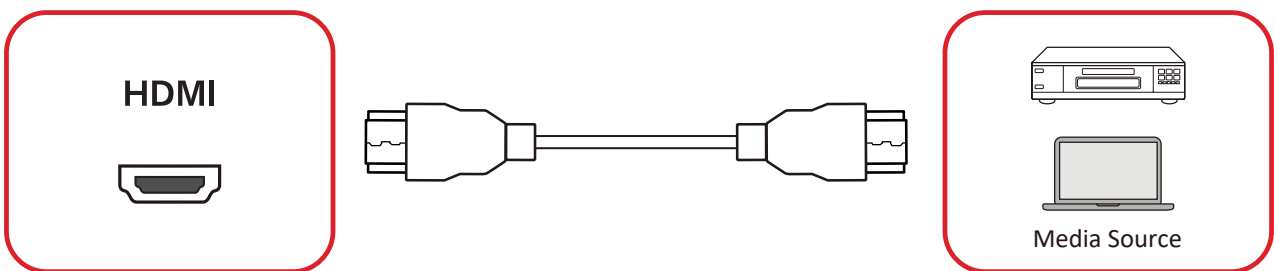

To connect to a media source:

1. Connect an HDMI cable to a **HDMI** port on your display and peripheral device.
2. Plug in the power cord of your display, turn on the power supply switch, then press the **Power** button.

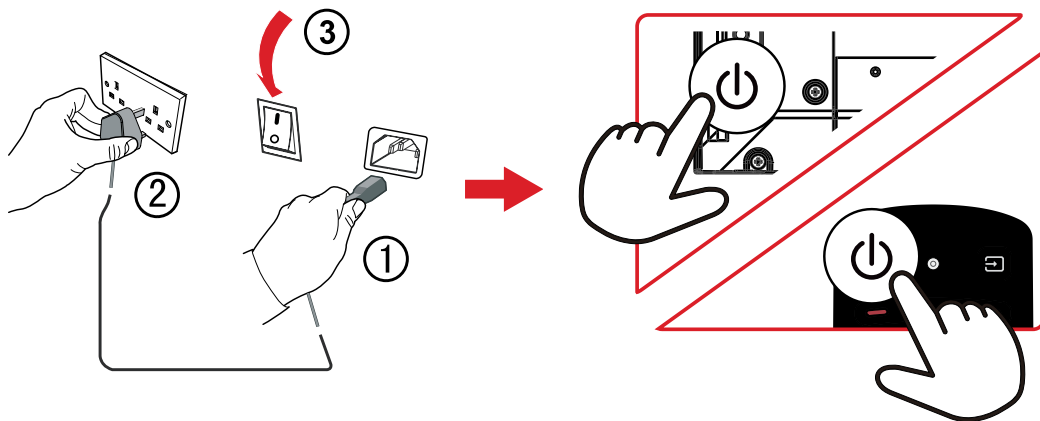

3. Press the **INPUT** button on the display or remote control, and switch to the "HDMI" input source.

Audio Connections

Audio In

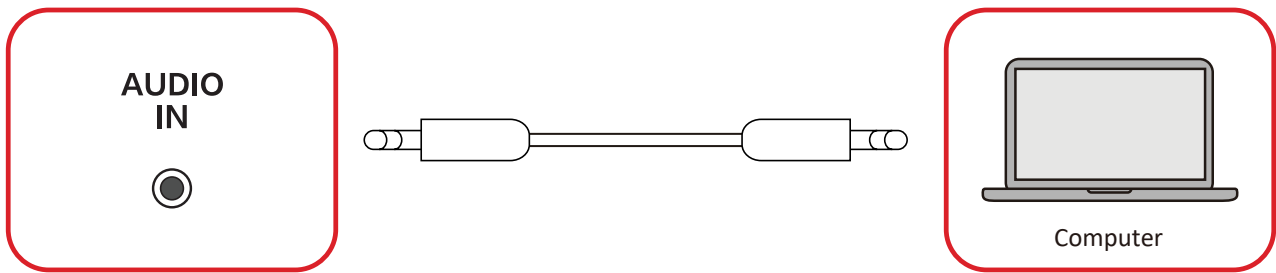

To play audio from your external device through the display's speakers, connect one end of an audio cable to your external device, and the other end to the **AUDIO IN** port of the display.

Audio Out

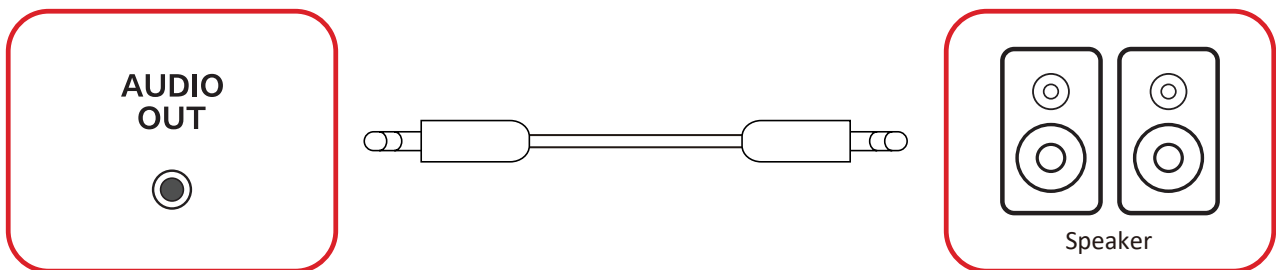

To play audio from the display through external speakers, connect one end of an audio cable to the external speakers, and the other end to the **AUDIO OUT** port of the display.

SPDIF

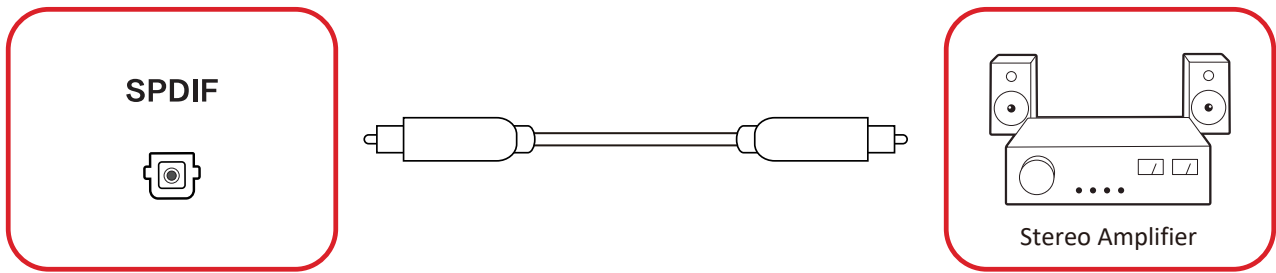

To connect to an external sound system:

1. Connect an optical cable from the **SPDIF** port on the display to your sound system's optical connector.
2. Plug in the power cord of your display, turn on the power supply switch, then Press the **Power** button.

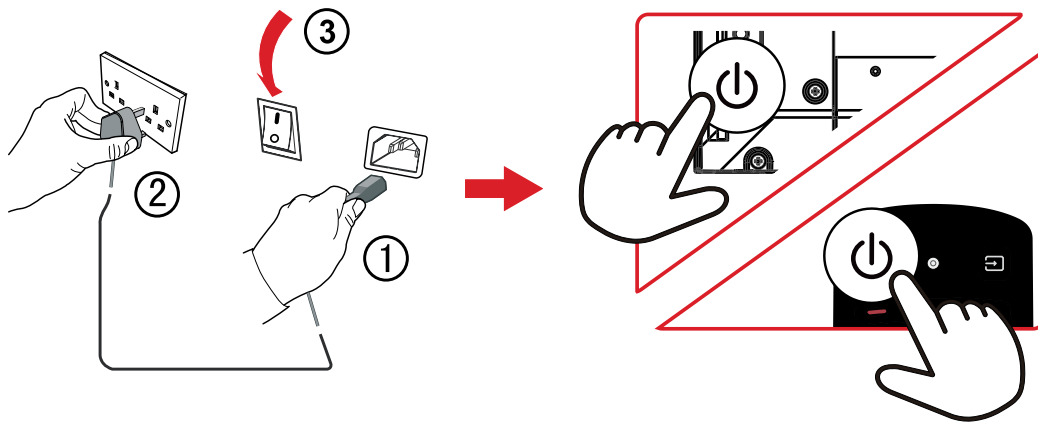

Video Output Connection (HDMI Out)

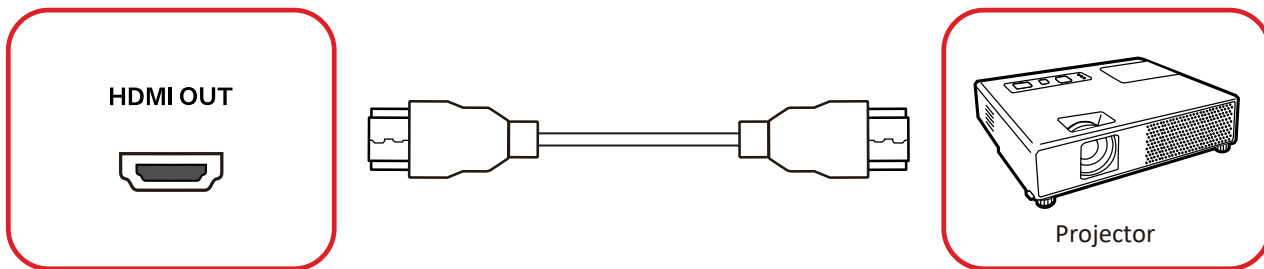

To output video via a display device:

1. Connect an HDMI cable to the **HDMI IN** port of your display device, and the other end to the **HDMI OUT** port of the display.
2. Plug in the power cord of the display, turn on the power supply switch, then press the **Power** button.

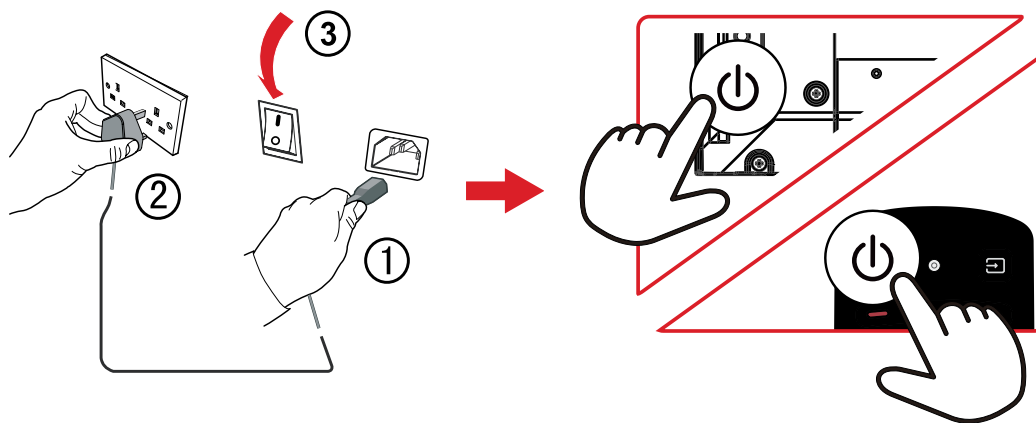

3. Press the **INPUT** button on the display or remote control and switch to the HDMI IN input source.

Optional Connections

NOTE: The following illustrations are for instructional purpose only. For details, please refer to the actual device.

The display comes with an **OPS Slot** as well as a **Wi-Fi Slot** for optional add-ons such as a slot-in PC¹ (e.g., VPCF35-W53-G1) or Wi-Fi card (e.g., VB-WIFI-005).

Slot-in PC (OPS Slot) Installation

1. Make sure the display is turned off.
2. Carefully insert the slot-in PC into the **OPS Slot** of the display.

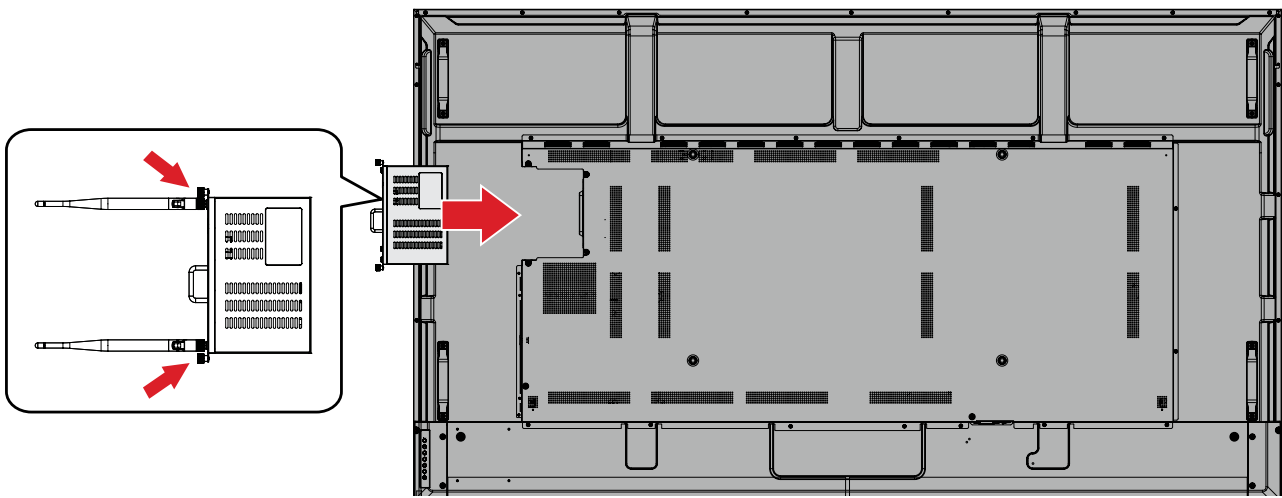

3. Secure the slot-in PC to the display.

¹ – OPS slot is only available for 65" and above.

Wi-Fi Card (Wi-Fi Slot) Installation

1. Remove the **Wi-Fi Slot** cover of the display.

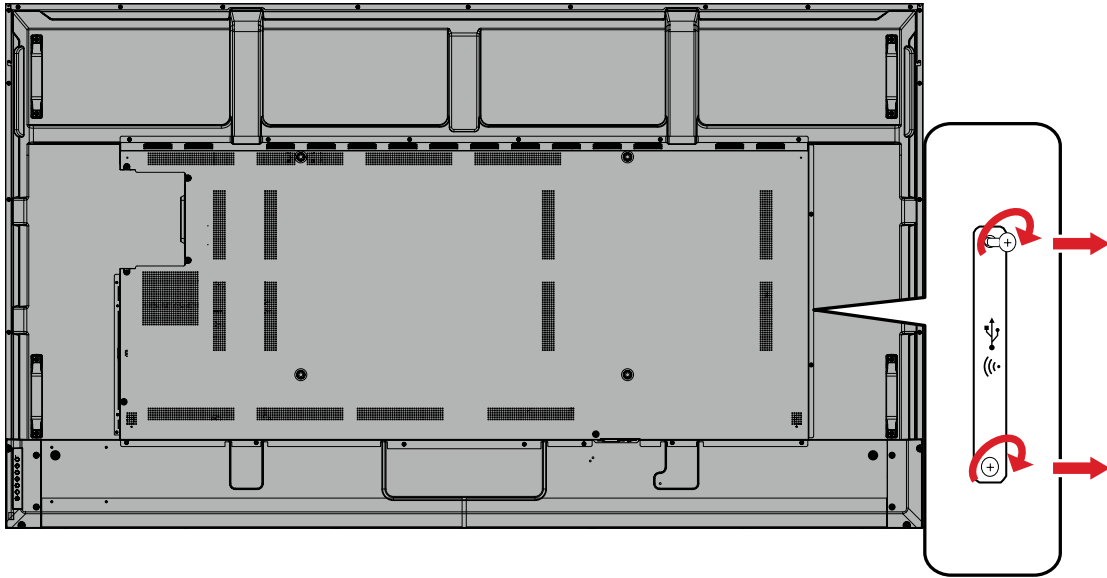

2. Carefully insert the slot-in Wi-Fi card into the **Wi-Fi Slot** of the display.

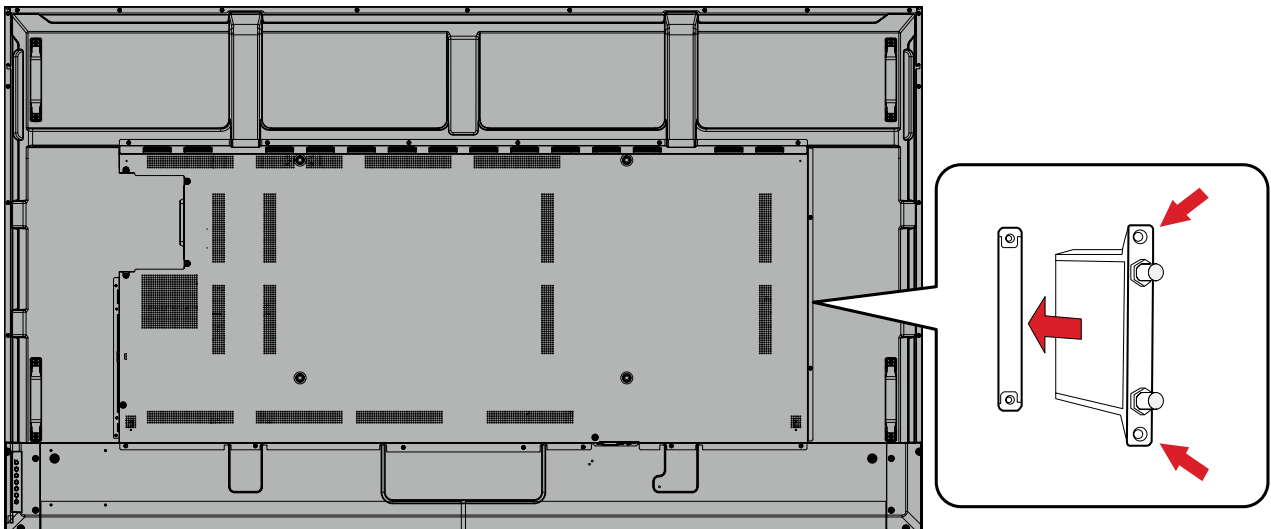

3. Secure the slot-in Wi-Fi card to the display.

Using Your Display

Powering On/Off Your Display

1. Ensure the power cord is connected, plugged into a power outlet, and the power supply switch is in the “On” position.

NOTE: The power supply switch is located at the bottom of the display.

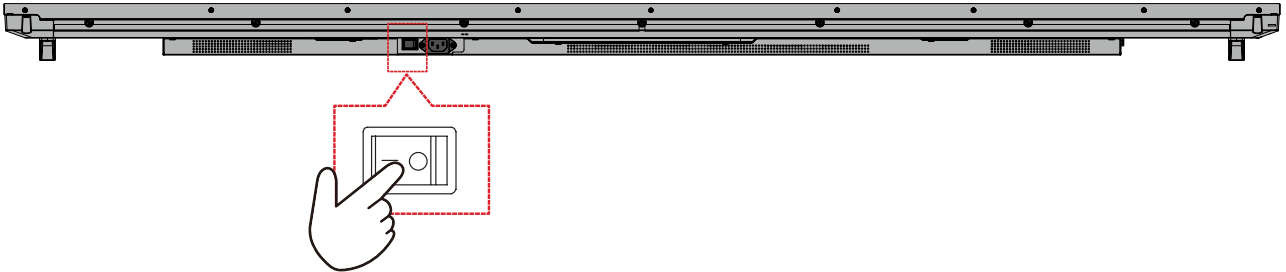

2. Press the **Power** button on the display or the remote control to turn on the display.

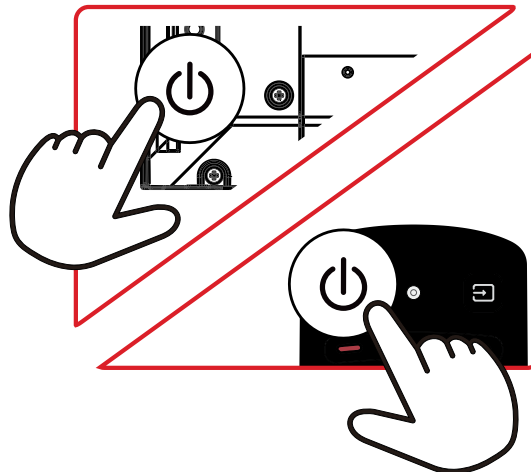

3. To turn the display off, press the **Power** button.

Initial Launch Setup

When you first turn on your display, an initial setup wizard will launch.

1. Select your Language.



2. Set the time zone, time format, and other settings.

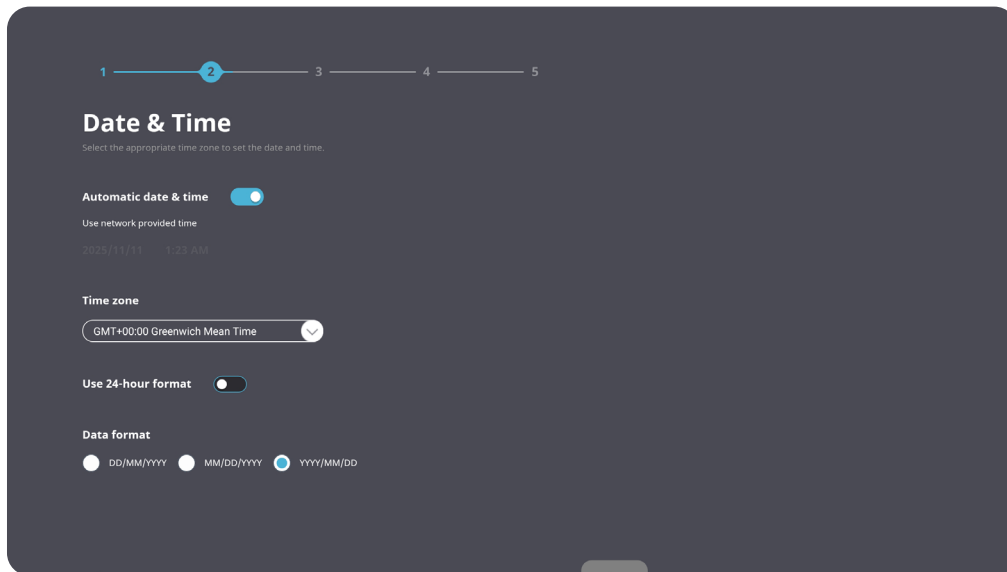

3. Select your Power Saving Plan based on your specific needs and preferences.

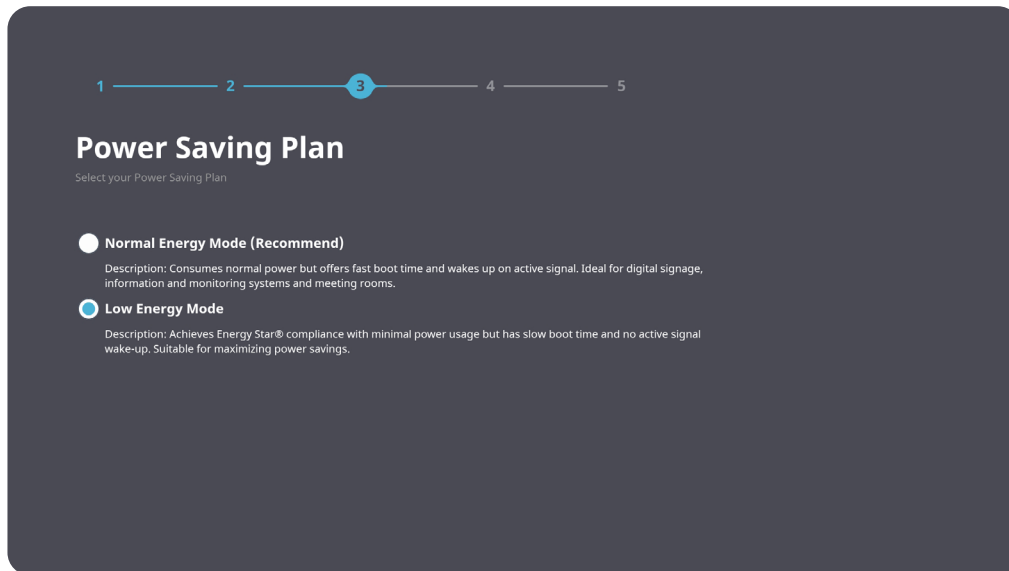

4. Accept or Decline Privacy and Copyright Protection.

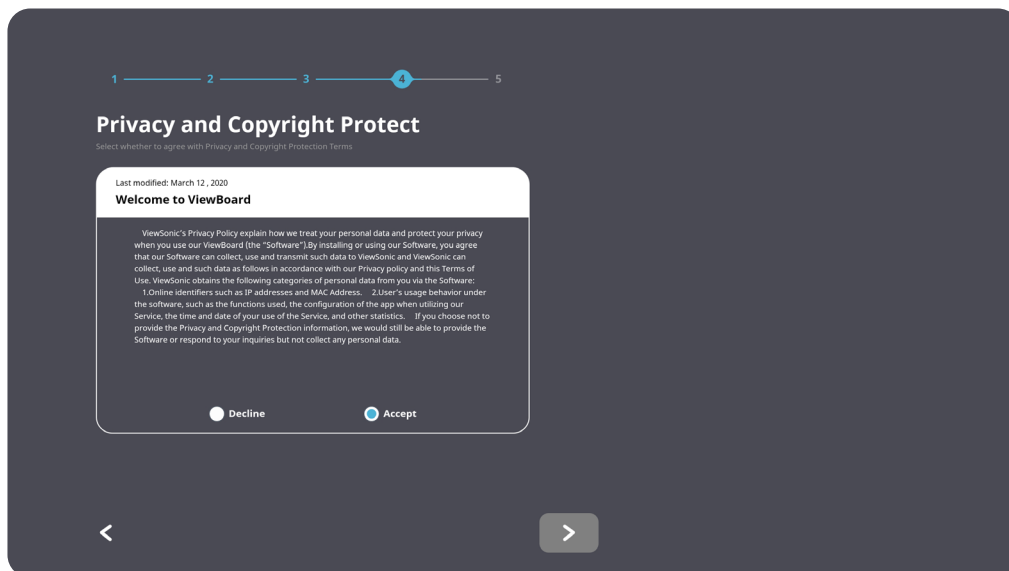

5. Select your Boot Mode.

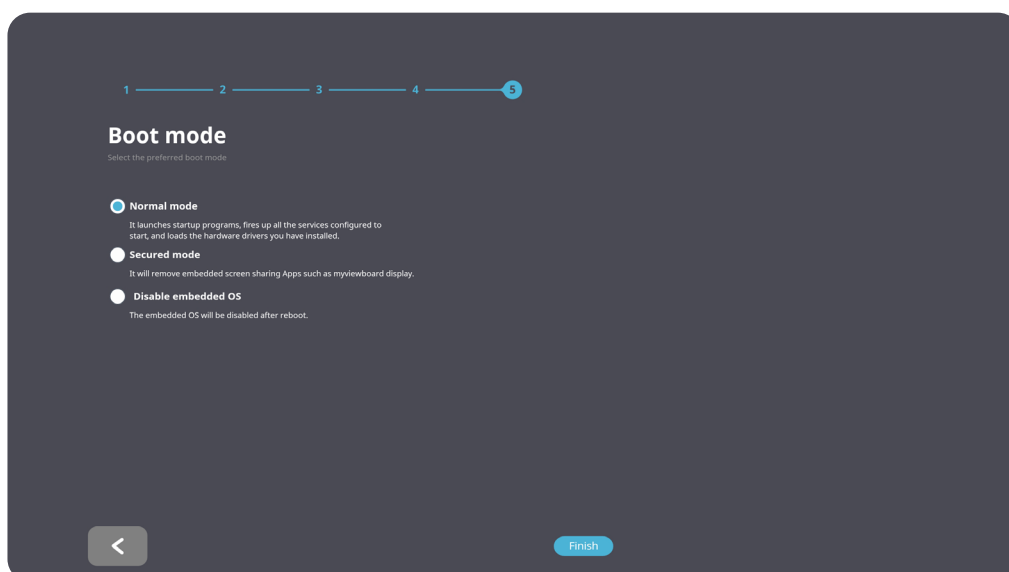

Home Screen

From the **Home screen** all the installed applications can be accessed.

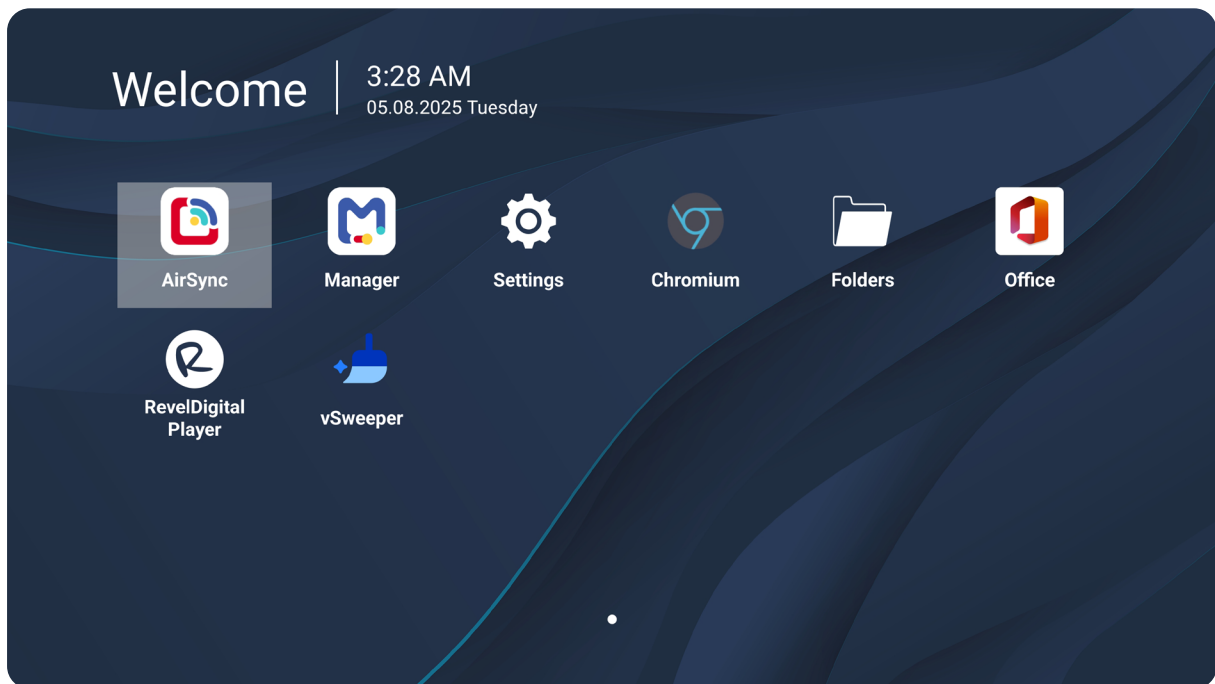

NOTE: Press the **Home** button on the remote control at any time to return to the **Home** screen.

General Settings

Configure basic Network, Device, and System settings.

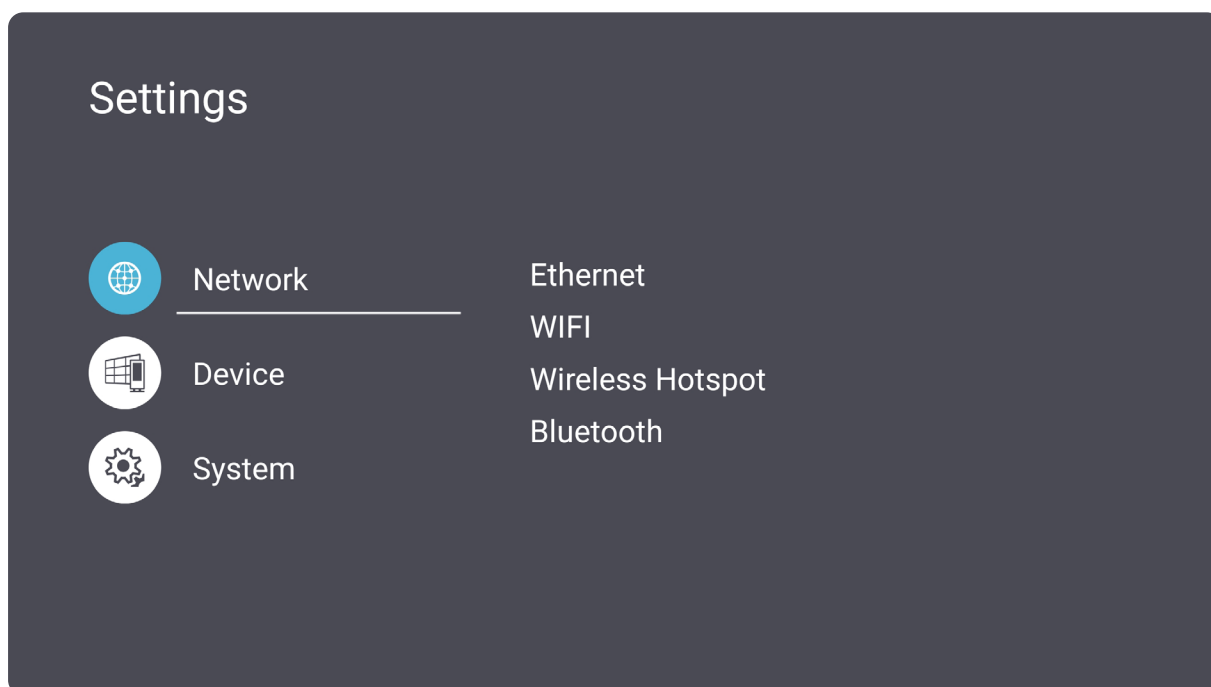

Network

Configure Ethernet, Wi-Fi, Wireless Hotspot, and Bluetooth settings.

NOTE: Wi-Fi, Wireless Hotspot, and Bluetooth settings appear when an optional Wi-Fi card (e.g., VB-WIFI-005) is installed in the **Wi-Fi Slot** of the display.

Ethernet

- Enable/Disable Ethernet.

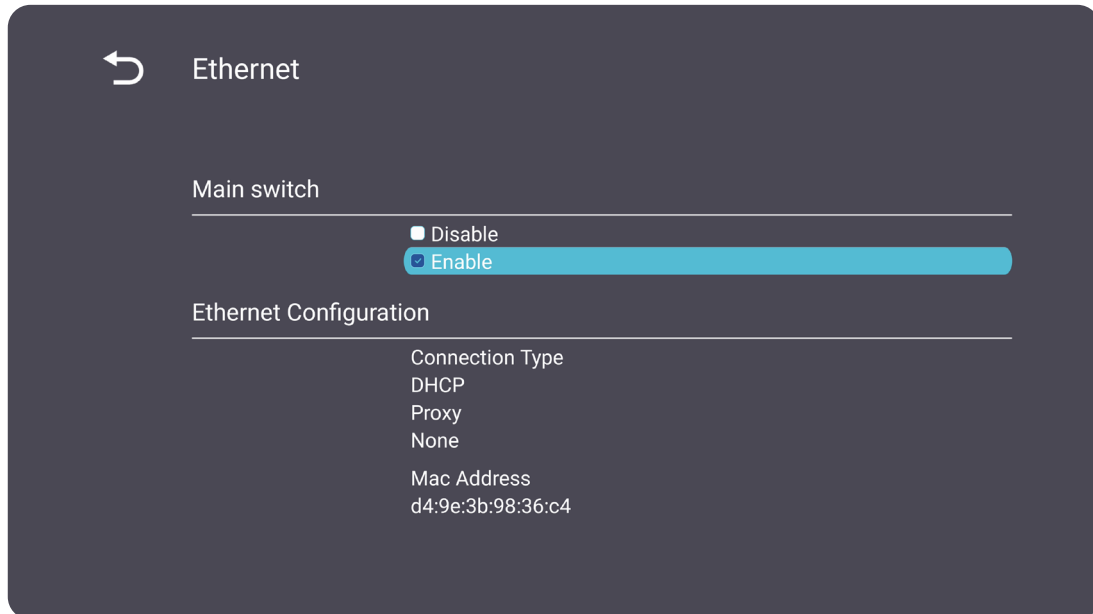

NOTE: After Ethernet is Enabled, the Connection Type and MAC Address will be available.

- Adjust the Connection Type.

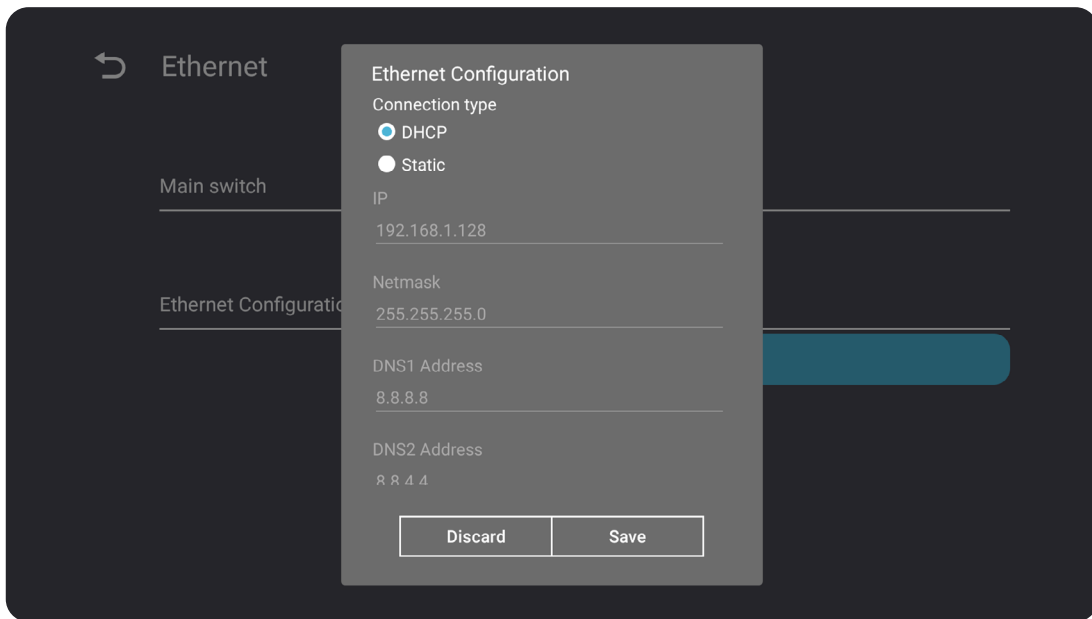

Connection Type	Description
DHCP	Cannot modify IP Address, Netmask, DNS Address and Gateway.
Static IP	Can input IP Address, Netmask, DNS Address and Gateway.

Wi-Fi

- Enable/Disable Wi-Fi.
- Add a Wi-Fi network or choose from the available listed.

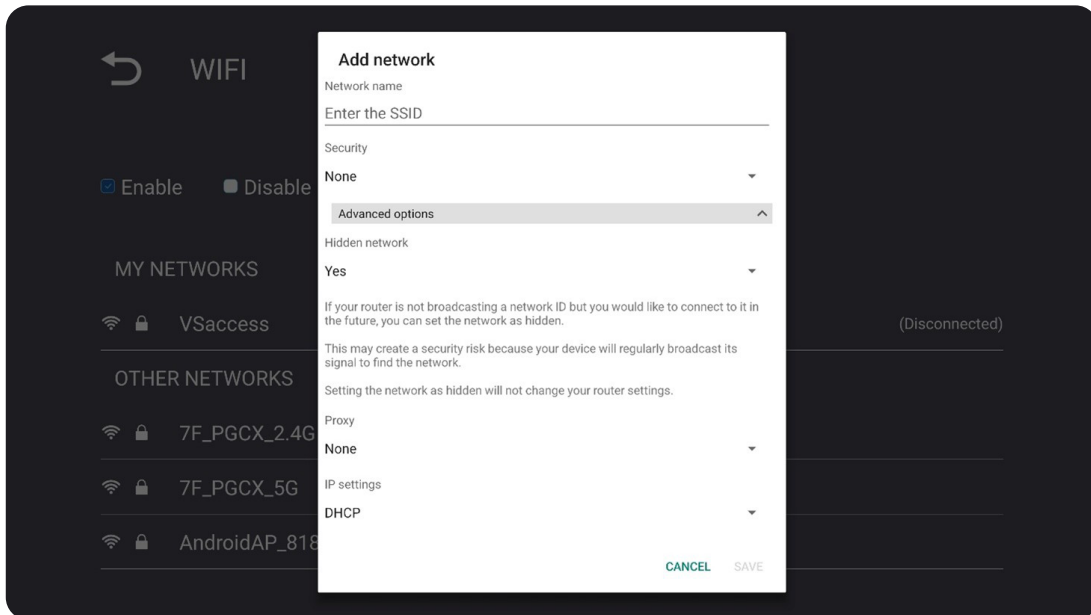

NOTE:

- After Wi-Fi is Enabled, available networks will be listed.
- Only one Wi-Fi network can be connected at a time.
- To forget a Wi-Fi network from the MY NETWORK list, tap the network, then tap forget.

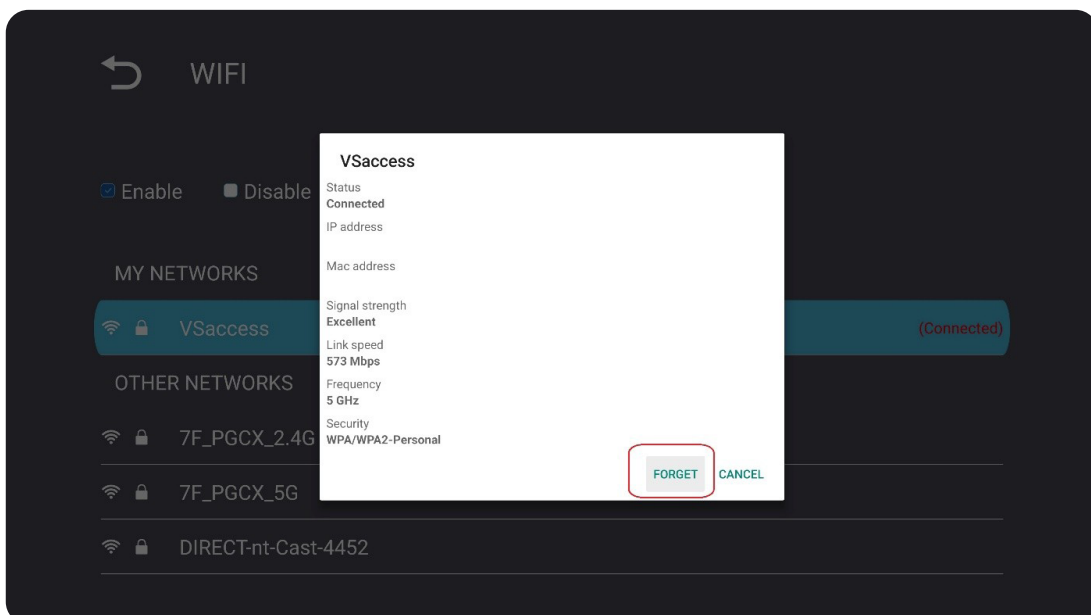

Wireless Hotspot

- Enable/Disable Wireless Hotspot.
- Share an internet connection with your devices once enabled.

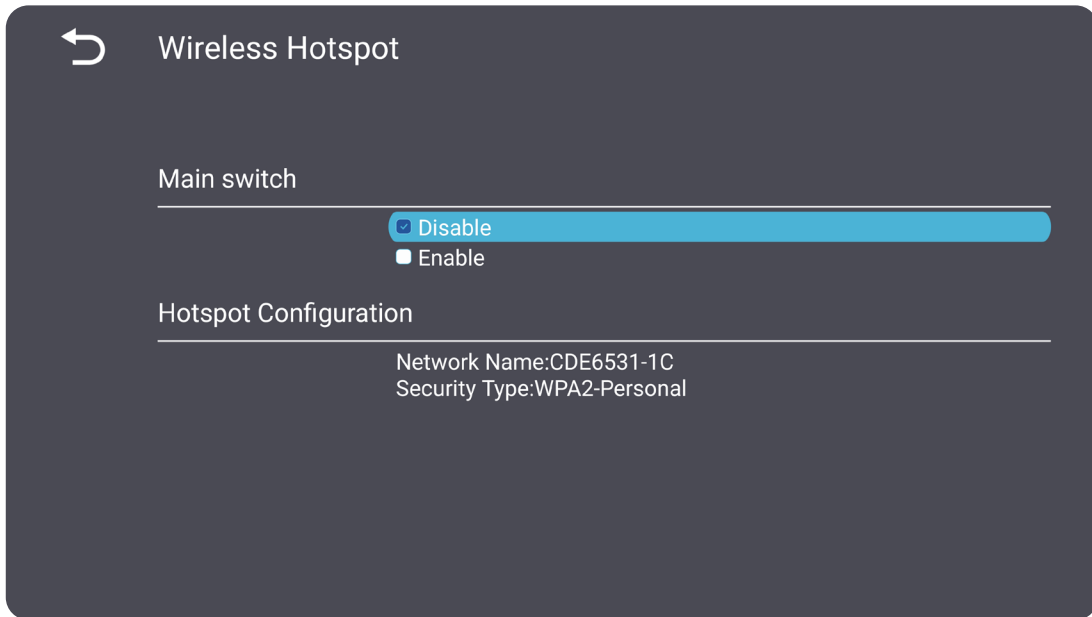

Bluetooth

- Enable/Disable Bluetooth.

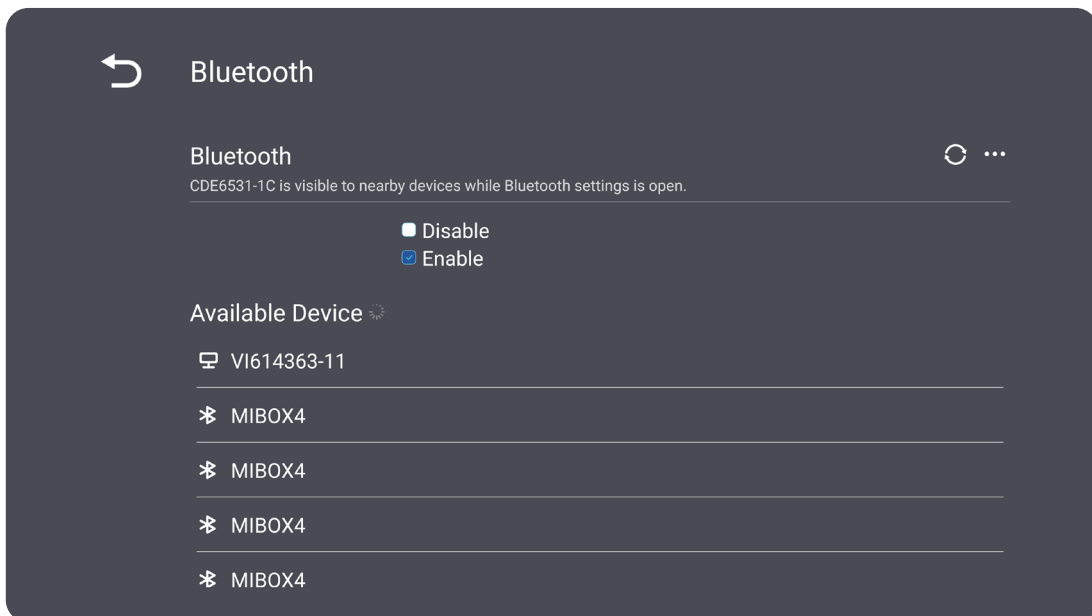

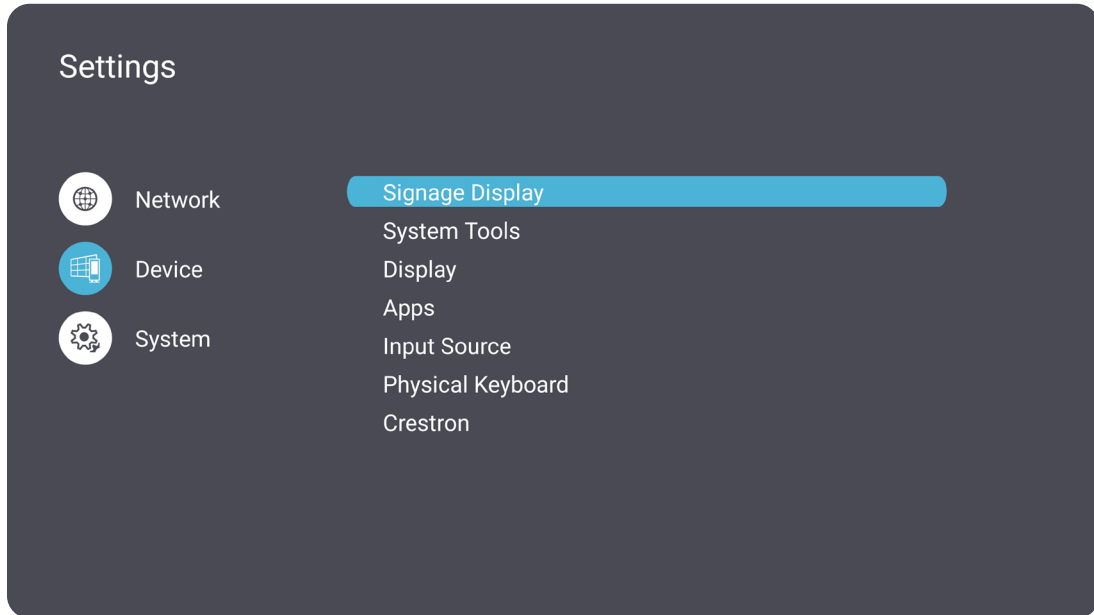

Device

Configure Signage Display, System Tools, Display, Apps, Input Source, Physical Keyboard, and Crestron settings.

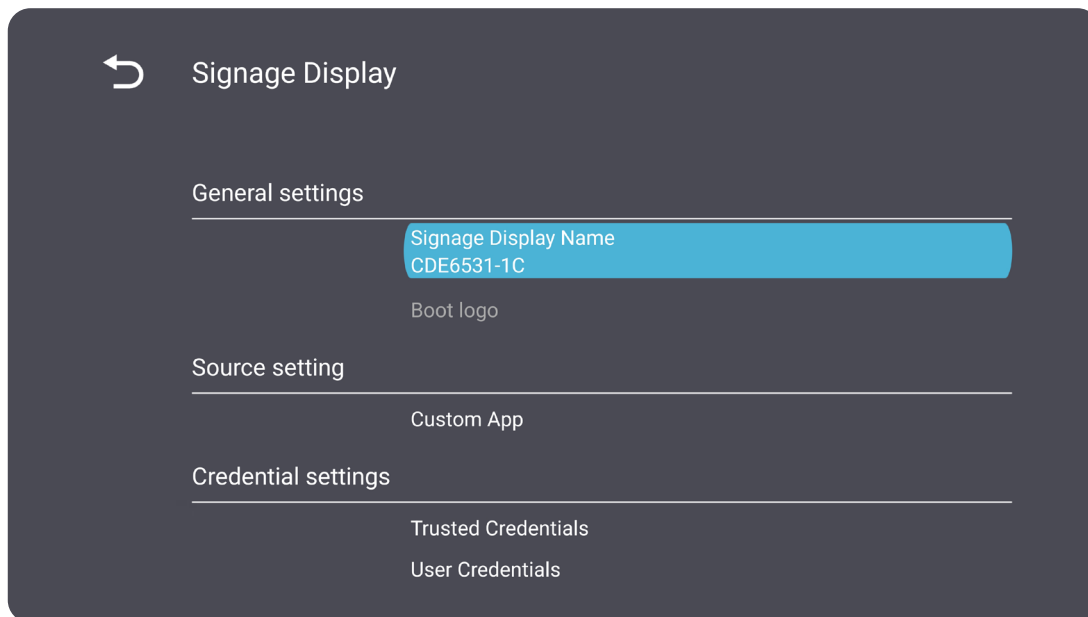

Signage Display

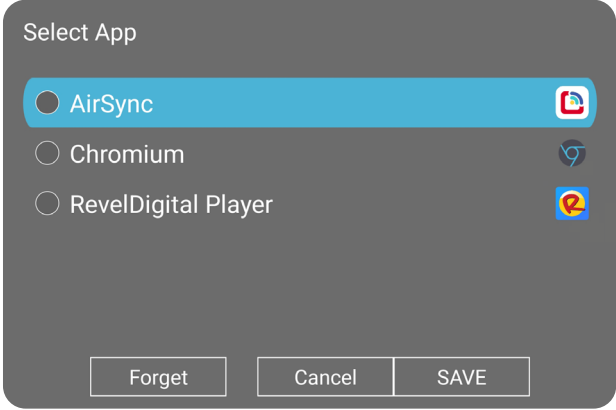

Item	Description	
<p>General Settings</p>	<p>Signage Display Name</p>	<p>Setup the display's name. Maximum of 36 characters.</p>
	<p>Boot Logo</p>	<ul style="list-style-type: none"> • Enable/Disable the boot logo. • Select a custom boot logo or animation file. <div data-bbox="746 1084 1370 1303" style="border: 1px solid #ccc; padding: 5px; margin: 10px 0;"> <p>Change Logo & Change Animation</p> <p> Change Logo</p> <p> Change Animation</p> </div> <p>NOTE: Ensure "Boot on logo" in the Advanced settings of the OSD Menu is set to "User" to be able to select a custom boot logo or animation file.</p>

Item	Description	
Source Setting	Custom App	<p>Setup a custom .apk application for Custom input source. If a Custom App is setup, the display will open the App when the input source is changed to "Custom".</p> 
Credentials Settings	View and clear credentials and install from storage.	
Security	External Storage	<ul style="list-style-type: none"> • Enable/Disable USB storage. • Re-insert any connected USB external storage device(s) after enabling.
	Unknown Sources	Allow or don't allow the installation of unknown .apk files.
	Privacy and Copyright Protection	View the privacy and copyright protection statement.
	App Authority	Set the application permission.

System Tools

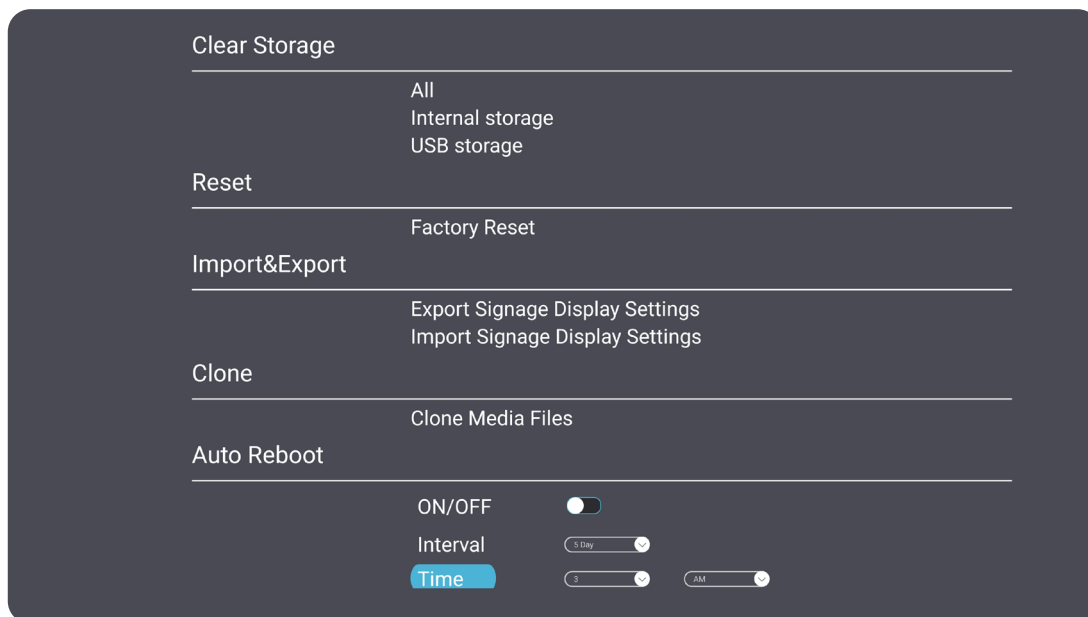

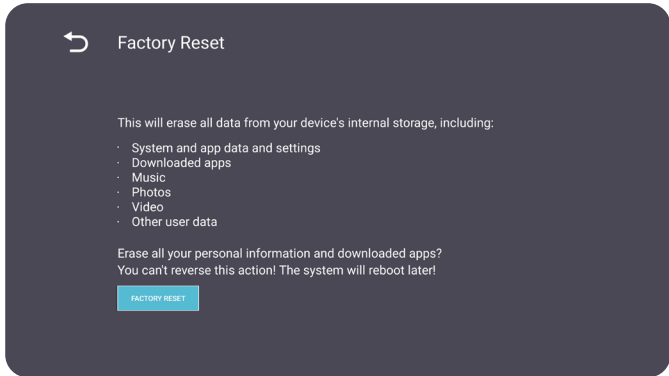
Item	Description	
Clear Storage	All	Clear all folder data.
	Internal Storage	Only clear internal storage folder data.
	USB Storage	Only clear USB storage folder data.
Reset	Factory Reset	<p>Return to factory default settings.</p> 
Import & Export	Export Signage Display Settings	<p>Export display settings to a USB.</p> <p>NOTE: The saved file name will be "vsSettingFile.txt" and saved in a folder titled "ViewSonic".</p>
	Import Signage Display Settings	Import display settings from a USB.

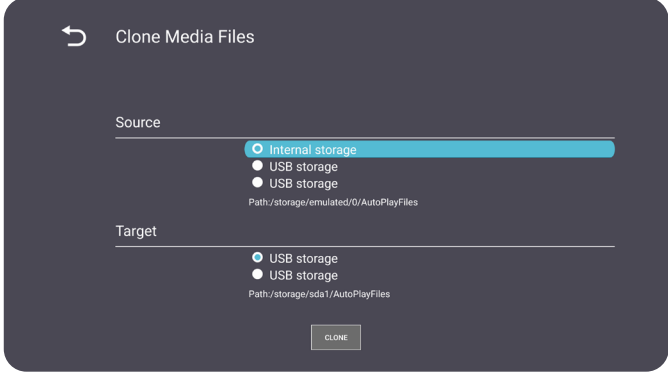
Item	Description	
<p style="text-align: center;">Clone</p>	<p>Create a copy of media files from the internal storage folder "AutoPlayFiles".</p> 	
	<p style="text-align: center;">Source</p>	<p>Choose the media files copy location (Internal Storage or USB).</p>
	<p style="text-align: center;">Target</p>	<p>Select Internal Storage or USB as the target for the copied media files.</p>
<p style="text-align: center;">Auto Reboot</p>	<p style="text-align: center;">On/Off</p>	<p>Restart the display automatically after a set period of time to prevent the accumulation of cached data, ensuring optimal performance and stability. The recommended interval is seven days.</p>
	<p style="text-align: center;">Interval</p>	
	<p style="text-align: center;">Time</p>	

Display

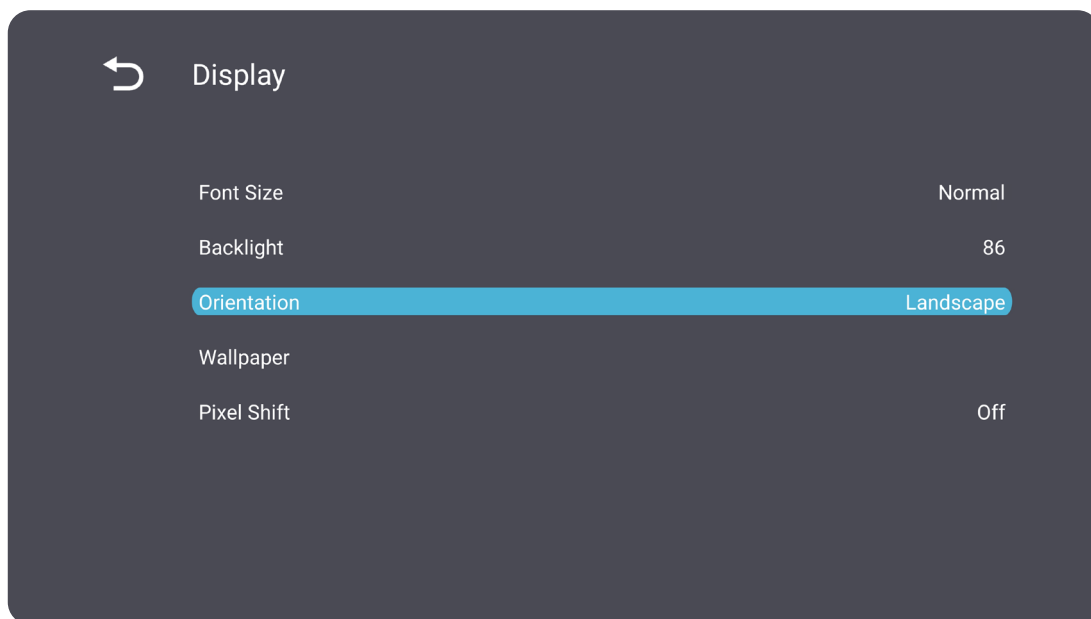

Item	Description
Font Size	Adjust the display's font size.
Backlight	Adjust the brightness of the display.
Orientation	Set the screen orientation: Auto, Landscape mode, or Portrait mode.
Wallpaper	Choose a background image for the display.
Pixel Shift	Avoid screen damage caused by prolonged static images.

Apps

- View any running or installed applications. Select each for more detailed information and options.
- By selecting a running application, more information will be displayed, and the application can be stopped or reported.

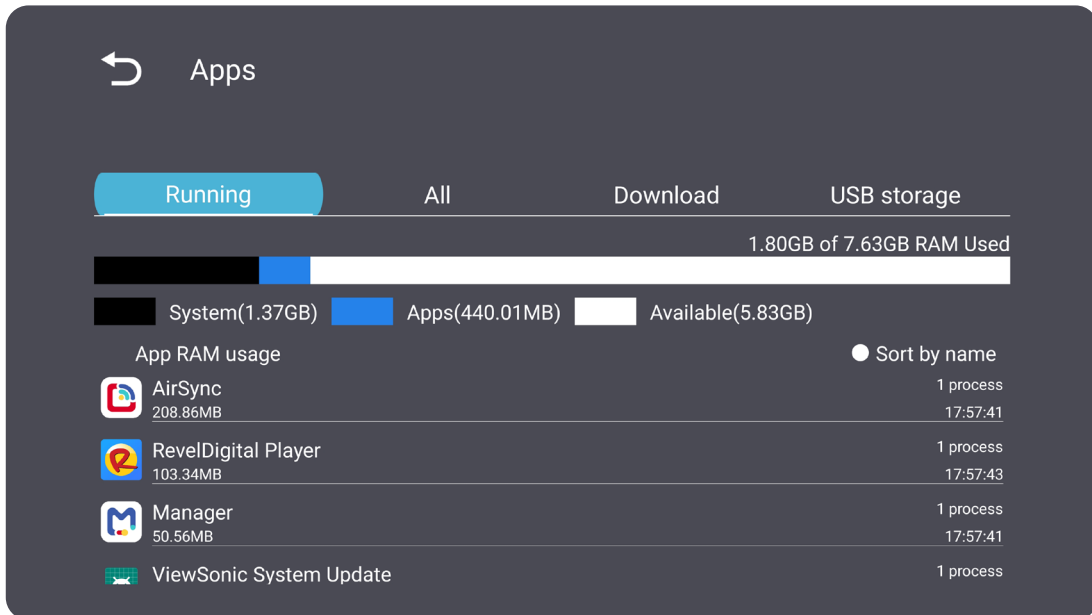

Input Source

Customize input source names.

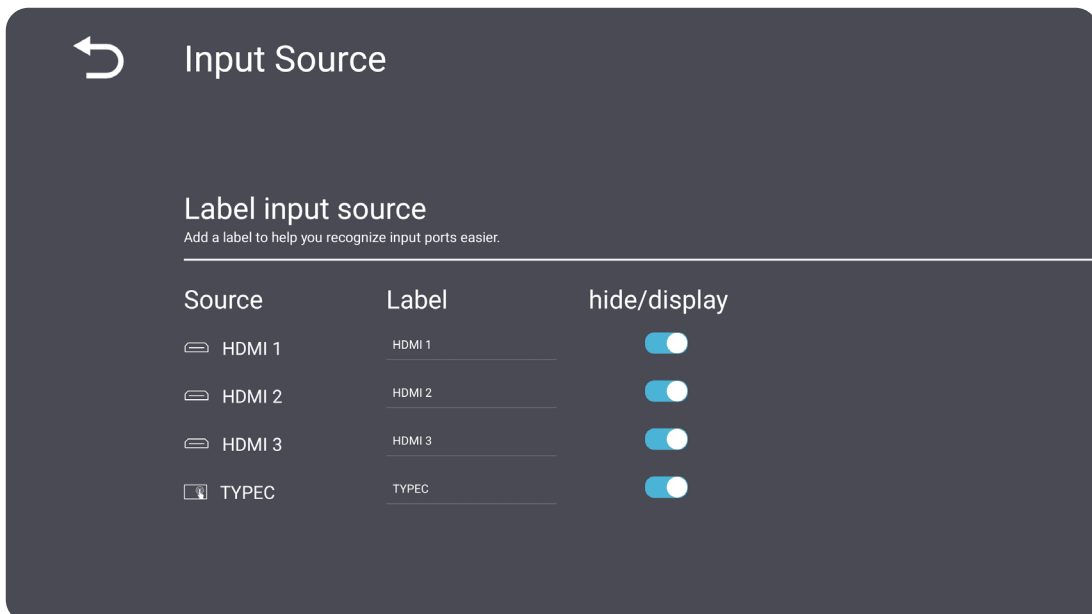

Physical Keyboard

Set the preferred keyboard and layout.

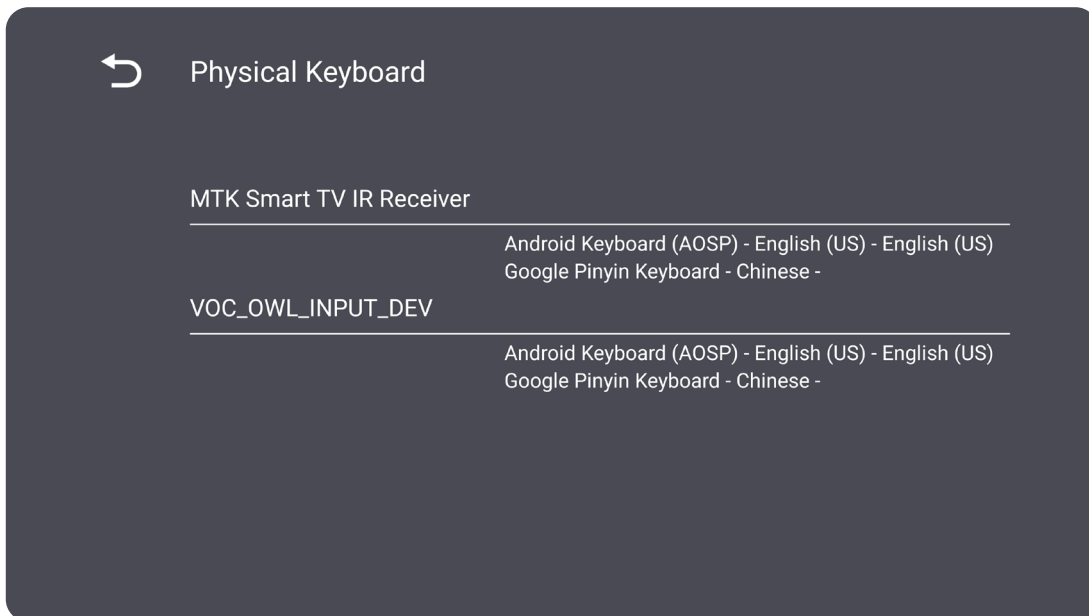

Crestron

Configure the Crestron settings.

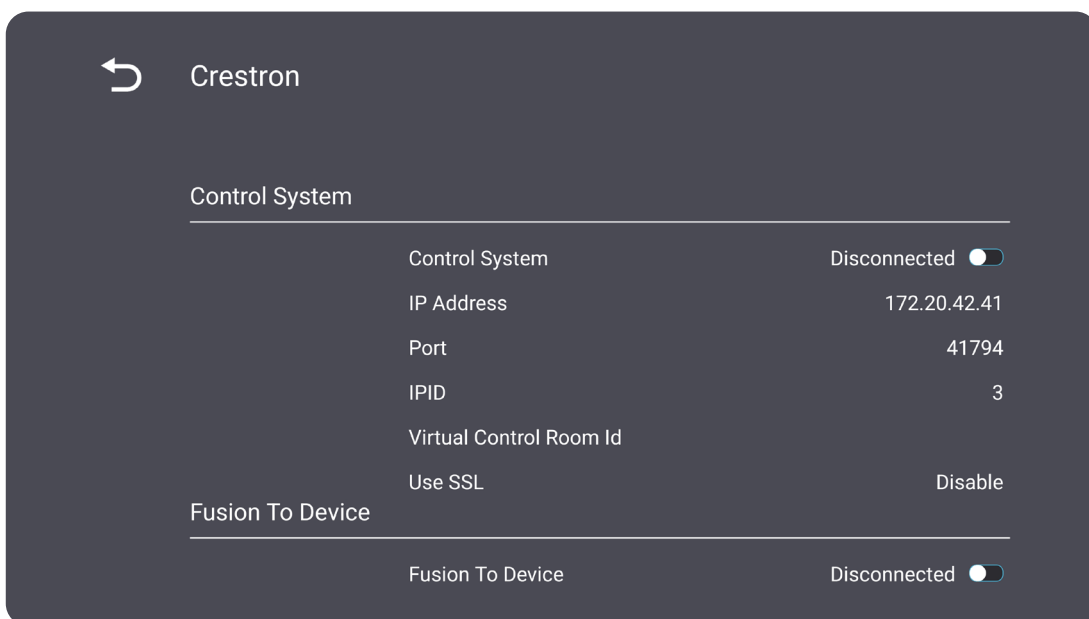

System

Date & Time

Set the time zone and Auto Time settings.

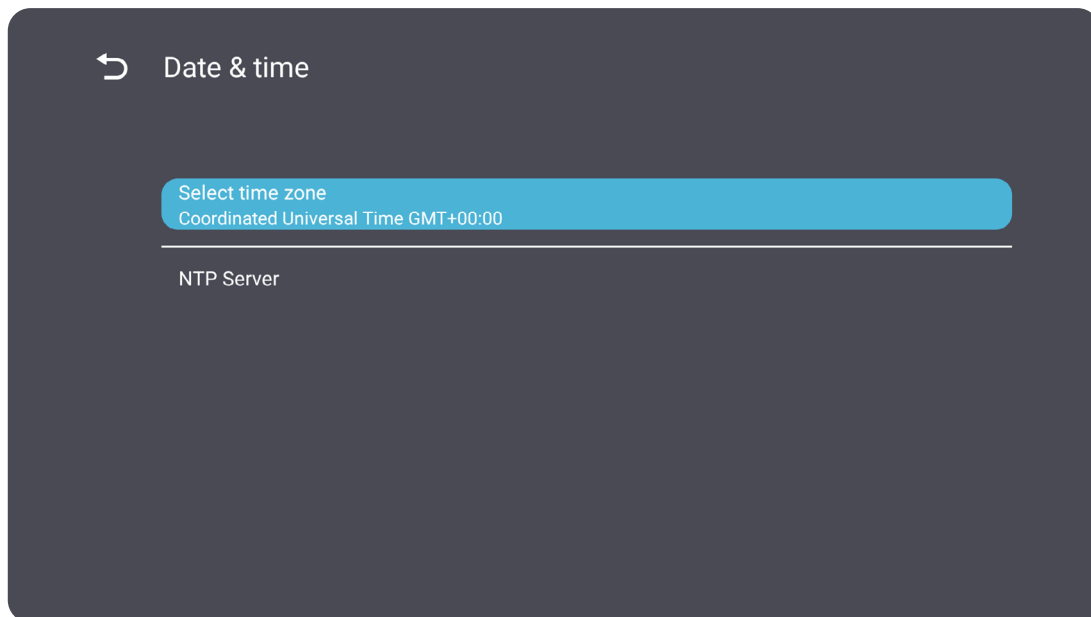

NTP Server

Set the NTP server.

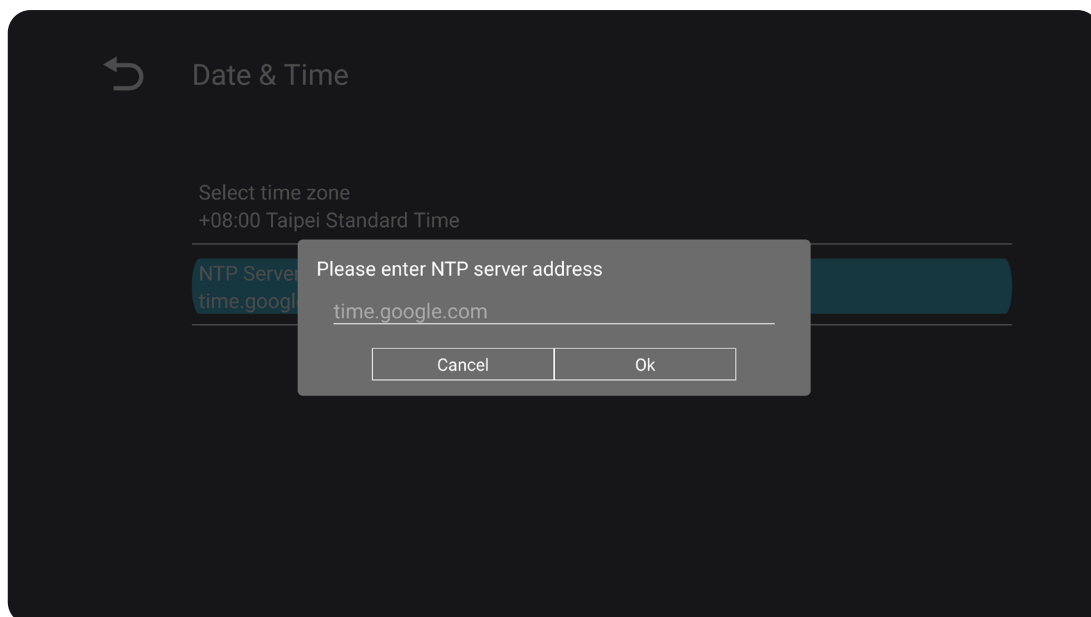

About

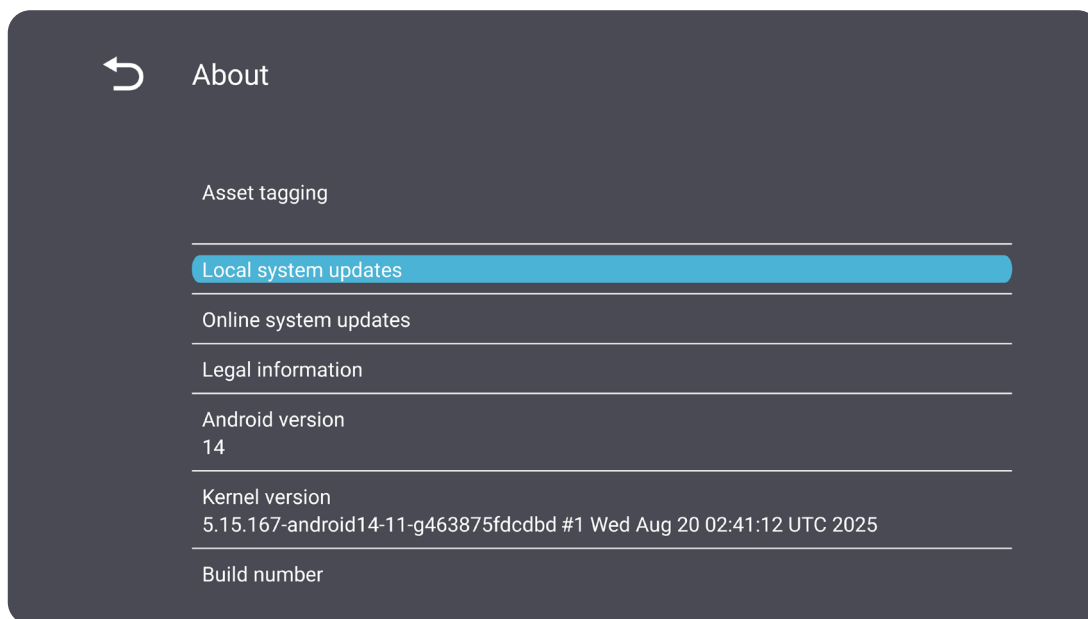

Item	Description
Asset Tagging	Customize an easily-identifiable label for the display.
Local System Updates	Update the software manually with a local file.
Online System Updates	When the display is turned off, the system will automatically check for a new version. If a new version is found, the system will automatically update. After the update is complete, the system will turn off.
Legal Information	Display open source licenses.
Android Version	Current Android version information.
Kernel Version	Kernel version information.
Build Number	Build number information.

General Settings Menu Tree

Main Menu	Sub-menu	Menu Option	
Network	Ethernet	Main Switch	Enable
			Disable
		Ethernet Configuration	Connection Type
			MAC Address
	Wi-Fi	Enable	
		Disable	
		Add Network	
	Wireless Hotspot	Main Switch	Enable
			Disable
		Hotspot Configuration	
	Bluetooth	Bluetooth	Enable
			Disable
Available Devices			
Device	Signage Display	General Settings	Signage Display Name
			Boot Logo
			Source Setting
		Credentials Settings	Trusted Credentials
			User Credentials
			Install from Storage
			Clear Credentials
		Security	External Storage
			Unknown Sources
			Privacy and Copyright Protection
			App Authority

Main Menu	Sub-menu	Menu Option			
Device	System Tools	Clear Storage	All		
			Internal Storage		
			USB Storage		
		Reset	Factory Reset		
		Import & Export	Export Signage Display Settings		
			Import Signage Display Settings		
		Clone	Clone Media Files		Source
		Auto Reboot	On/Off		Target
			Interval		
			Time		
	Display	Font Size			
		Backlight			
		Orientation	Auto		
			Landscape Mode		
			Portrait Mode		
		Wallpaper			
		Pixel Shift			
	Apps				
	Input Source				
	Physical Keyboard				
	Crestron				
	System	Date & Time	Select Time Zone		
			NTP Server		
About		Asset Tagging			
		Local System Updates			
		Online System Updates			
		Legal Information			
		Android Version			
		Kernel Version			
		Build Number			

On-Screen Display (OSD) Menu

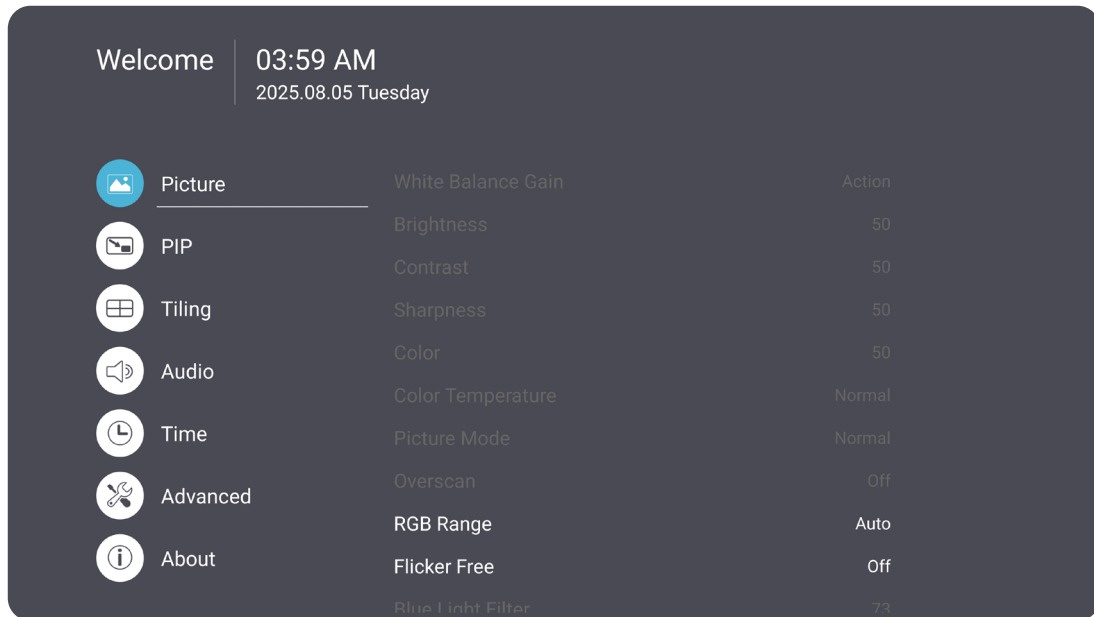

To open and operate the OSD Menu:

1. Press the **Settings** button on the remote control.
2. Press the **Directional** buttons (↓/↑/←/→) on the remote control to select menu items or adjust values.
3. Press **OK** to confirm your selection.
4. Press the **Back** button to go back to the previous menu level.
5. Press the **Settings** button again to exit the OSD Menu.

Picture

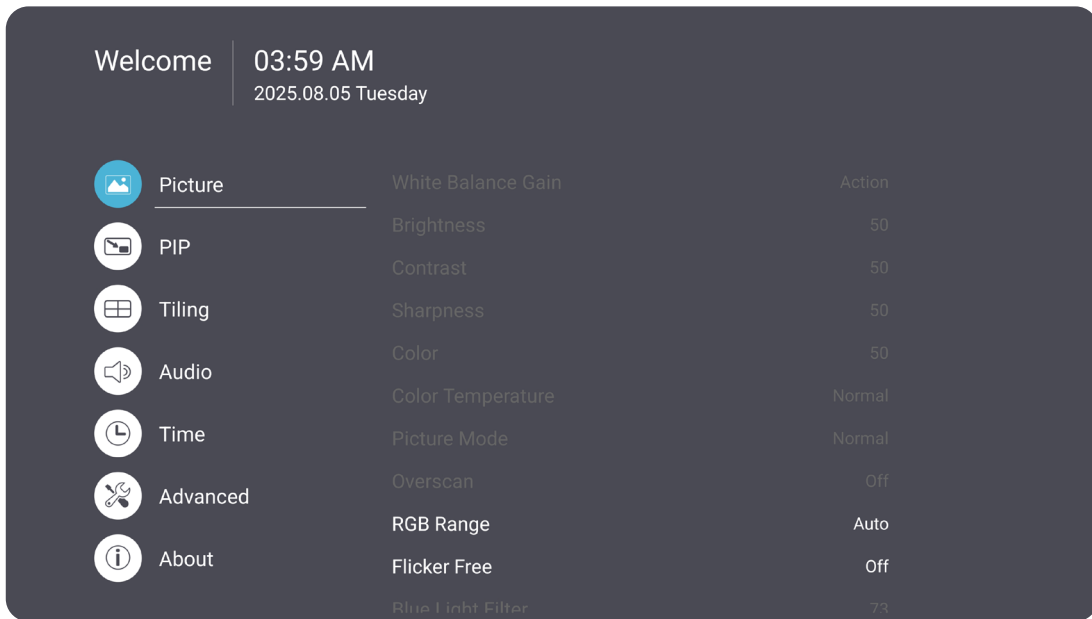

Item	Description
White Balance Gain	Adjust the white balance for the upmost control when manipulating contrast and dark scenes.
Brightness	Adjust the background black levels of the screen image.
Contrast	Adjust the degree of difference between the lightest and darkest parts of the picture and change the amount of black and white in the image.
Sharpness	Adjust the picture's sharpness.
Color	Adjust the amount of color present.
Color Temperature	Adjust the color temperature.
Picture Mode	Select a predefined picture setting.
Overscan	Automatically enlarge the original picture horizontally and vertically to an equal aspect ratio that fills the screen.
RGB Range	Manually change the color format options to fit the correct color format range if the colors are not displayed correctly.
Flicker Free	Reduce or eliminate screen flicker.
Blue Light Filter	Adjusts the filter that blocks high-energy blue light for a more comfortable viewing experience.
Noise Reduction	Reduce image noise and distortion.
Gamma Set	Reflect the relationship between input source and picture brightness.
HDR10	Reduce the overall contrast of a given scene so that detail in the highlights and shadows can be seen.
Picture Reset	Reset all Picture menu settings to default.

Low Blue Light Filter and Eye Health

The Blue Light Filter blocks high-energy blue light for a more comfortable viewing experience.

Calculating Breaks

When viewing screens for extended periods, it is recommended to take periodic breaks from viewing. Short breaks of at least 10 minutes are recommended after one (1) hour of continuous viewing.

Taking shorter, more frequent breaks are generally more beneficial than longer, less frequent breaks.

Focus Fatigue (20-20-20 Rule)

To reduce the risk of eye fatigue by constantly looking at the screen, look away from the screen at least every 20 minutes and gaze at a distant object (at least 20 feet away) for at least 20 seconds.

Looking at Distant Objects

While taking breaks, users can further reduce eye strain and dryness by focusing on objects that are further away from them for 10-15 seconds, then gaze at something up close for 10-15 seconds. Repeat this up to 10 times. This exercise reduces the risk of your eyes' focusing ability to "lock up" after prolonged computer work.

Eye and Neck Exercises

Eye Exercises

Eye exercises can help minimize eye strain. Slowly roll your eyes to the left, right, up, and down. Repeat as many times as needed.

Exercises for the eyes

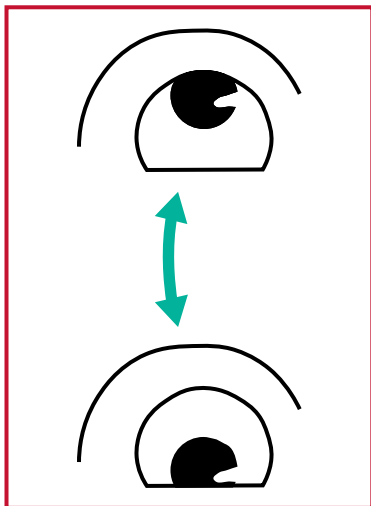

(1) Keep the body and the head upright. Move the eyes up to look at the ceiling, then turn down to look at the floor.

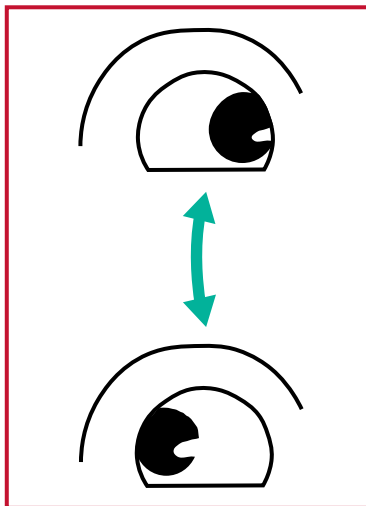

(2) Move the eyes left and right slowly to look at objects on the two sides.

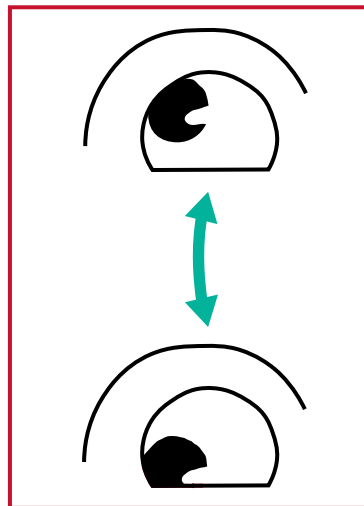

(3) Move the eyes to look at objects at the right upper direction and then right lower direction. Repeat for the left upper and left lower directions.

Neck Exercises

Neck exercises can also help minimize eye strain. Relax your arms and let them hang at your sides, bend forward slightly to stretch the neck, turn your head to the right and to the left. Repeat as many times as needed.

Flicker-Free

The CDE31 series uses DC-adjustable backlighting, which does not produce a visible or invisible flicker within the 0~3000 Hz range and therefore can reduce eye fatigue.

PIP



Item	Description	
Sub Mode	Off	Disable this function.
	PIP	Overlay another source, a main window and an inset window. User can specify the input source for each screen.
	PBP	Display two windows, a dual split screen, side-by-side on the left and right of the screen. User can specify the input source for each screen.
PIP Size	Small	Select the size of the sub picture in the PIP mode.
	Medium	
	Large	
PIP Position	Bottom-Right	Select the position of the sub picture in the PIP mode.
	Bottom-Left	
	Top-Right	
	Top-Left	
PIP Source	Select the input signal for the sub-picture.	
PIP Audio	Main	Select audio from the main picture.
	Sub	Select audio from the sub-picture.
PIP Reset	Reset all settings in the PIP menu to factory preset values.	

Tiling

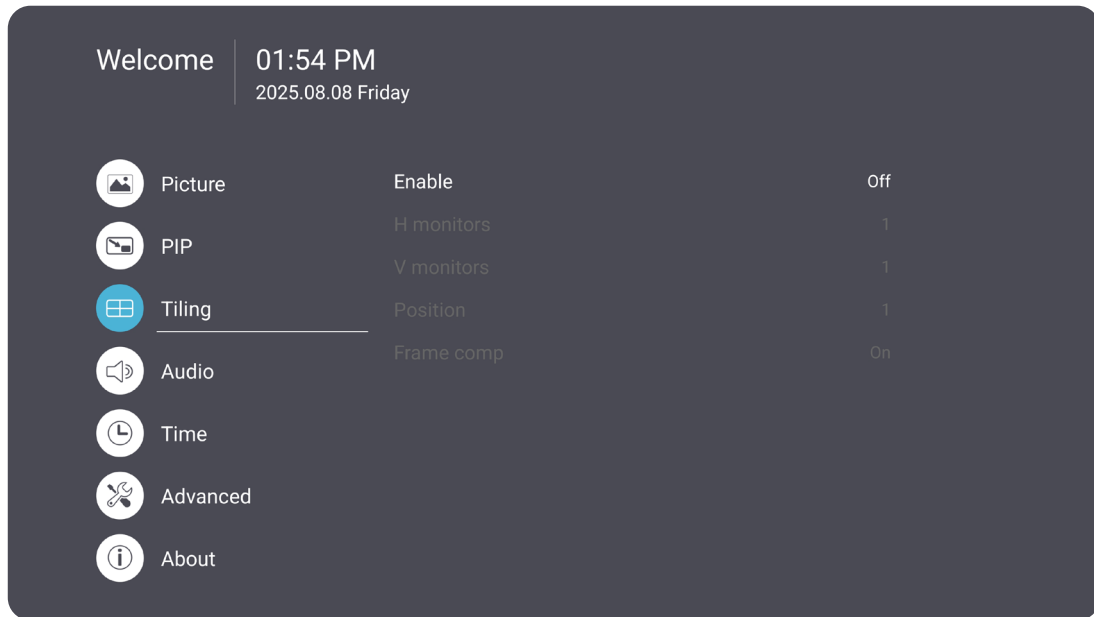

Item	Description
Enable	Choose ON or OFF for the Tiling function. If turned on, the display will apply the settings in H Monitors, V Monitors, Position, and Frame Compensation.
H Monitors	Adjust displays on the horizontal side.
V Monitors	Adjust displays on the vertical side.
Position	Adjust the position of the display in the screen matrix.
Frame Comp	Choose to turn the frame compensation function on or off. If turned on, the display will adjust the image to compensate for the width of the display bezels in order to accurately display the image.

Audio

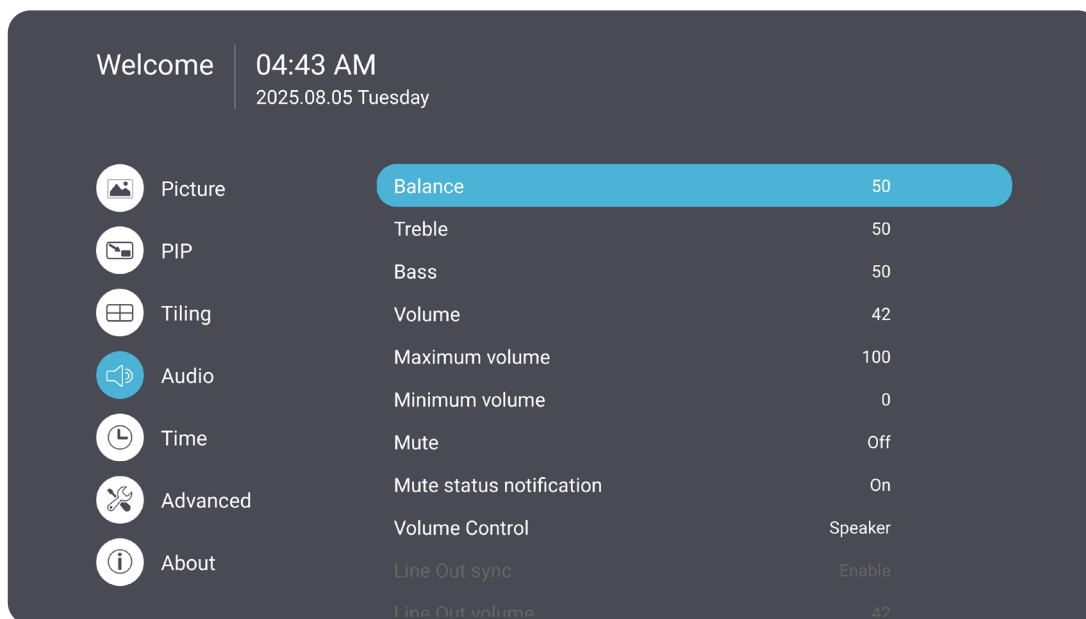

Item	Description
Balance	Adjust the left/right speaker balance.
Treble	Increase/decrease the treble level (higher-pitched sounds).
Bass	Increase/decrease the bass level (lower-pitched sounds).
Volume	Increase/decrease the display's volume level.
Maximum Volume	Set the display's maximum volume level.
Minimum Volume	Set the display's minimum volume level.
Mute	Mute the volume.
Mute Status Notification	Mute all notifications and alerts.
Volume Control	Control audio source from internal speaker or Audio Out port.
Line Out Sync	Sync Audio Out volume with the display's speakers.
Line Out Volume	Increase/decrease the Audio Out volume.
Audio Reset	Reset all Audio menu settings to default.

Time

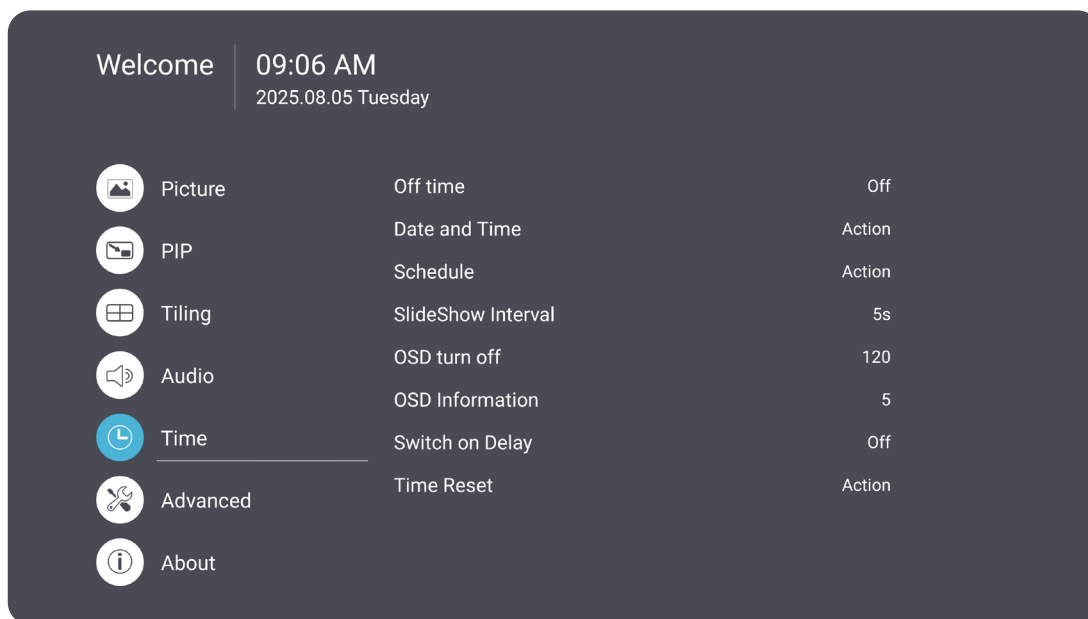

Item	Description	
Off Time	Set the auto power off time.	
Schedule	Schedule List	Set a schedule to turn on or off the display.
	Enable	Turn on this function.
	Start Time	Set the time to turn on the display.
	End Time	Set the time to turn off the display.
	Input	The display will be turned on automatically when detecting an input signal.
	HDMI 1/HDMI 2/ HDMI 3/TYPE C/ USB Auto Play/ Custom	The display will be turned on automatically when detecting the selected input signal.
	Day Of The Week	Set a day of the week to turn on the display automatically.
Every Week	Turn on the display every week.	
SlideShow Interval	Set the time period between each picture.	
OSD Turn Off	Set the time period the OSD Menu stays on the screen.	
OSD Information	Set the time period the OSD information will be displayed in the upper left corner of the display.	
Switch on Delay	Set the power-on delay time (in seconds).	
Time Reset	Reset all Time menu settings to default.	

Advanced

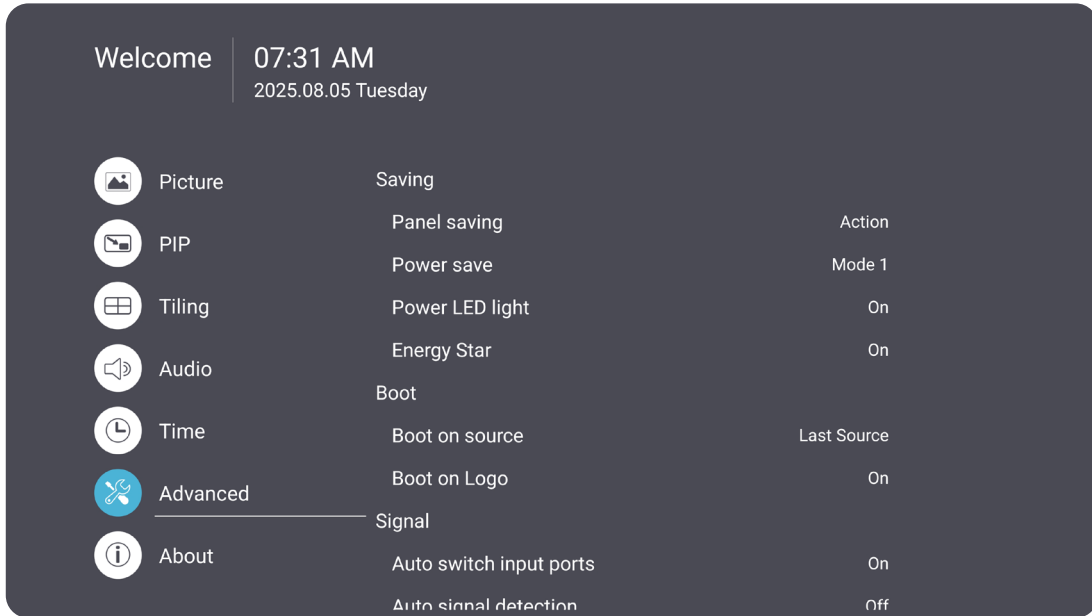

Item	Description	
Panel Saving	Reduce the risk of Image Burn-in when enabled.	
Power Save	Reduce power consumption.	
	Mode 1	Consume lowest power and support multiple remote wake-up methods (e.g., WoL, CEC wake-up, etc.). Each boot time is around 30 seconds.
	Recommended for use cases that prioritize energy savings above all else and infrequent boot-ups.	
	Mode 2	Consume less power and support multiple remote wake-up methods (e.g., WoL, CEC wake-up, etc.). After the first boot-up, the subsequent boot-ups take around seven seconds.
	Recommended for use cases that require energy efficiency and moderate boot speed.	
	Mode 3	Consume moderate power. Boot up in two seconds when being turned on or a video signal is detected.
	Recommended for use cases that require a frequent, fast boot time.	
	Mode 4	Consume moderate power. Boot up in two seconds only when being turned on.
Recommended for use cases that require a frequent, fast boot time.		

Item	Description	
Power LED Light	Turn On/Off the Power LED indicator.	
Energy Star	Reduce automatically power consumption.	
Boot on Source	Last Input	Select the input source after boot up.
	HDMI 1	
	HDMI 2	
	HDMI 3	
	TYPE C	
	USB Auto Play	
	Custom	
Boot on Logo	Enable/Disable a logo when the display is turned on.	
	Off	Neither the ViewSonic nor animation logo will show.
	On	The ViewSonic logo and animation will show.
	User	If a custom logo option is set in General Settings , then the custom logo will show. If there is no custom logo set then no logo will show.
Auto Switch Input Ports	Switch to the input source automatically when a display cable is connected.	
Auto Signal Detection¹	Search automatically for available input signals.	
	Off	Do not search for an available input signal when the current signal is lost.
	Auto	Search automatically for available input signals.
	Last	Search for the last input signal when the current signal is lost. If no signal is detected, the “No Signal Standby” notification displays and the display shuts down.
	Fail Over	Customize a priority list for input signals. When the primary signal is lost, the display will switch automatically to the next available source, ensuring uninterrupted media playback.
No Signal Standby	Off	Set the time period to enter Standby Mode when there is no signal.
	0 min	
	5 min	
	15 min	
	30 min	

¹– Available input signals include HDMI, USB Type C, and OPS.

Item	Description	
HDMI with One Wire	Enable/Disable CEC (Consumer Electronics Control). CEC synchronizes power on/off operation via HDMI connection. That is, if a device that also supports CEC is connected to the HDMI input of the display, when the display's power is turned off, the power of the connected device will also be turned off automatically. When the power of the connected device is turned on, the display's power will be turned on automatically.	
USB Cloning	Import	Save the OSD Menu configuration to a USB storage.
	Export	Export the OSD Menu configuration from a USB storage.
HDMI Version²	Set the HDMI version.	
USB Auto Play	If set to ON, the display will copy media files from the external USB storage to the display's internal storage, then play the media files automatically. For more information, refer to "Setting the Display to AutoPlay on Boot".	
Power Off Reminder	Stop the power-off notification when any of the following actions are performed. <ul style="list-style-type: none"> • Press the Power button on the display or remote control. • Turn off the display remotely. 	
Switch on State	Select the display status for the next time the power cord is connected to a power outlet.	
	Power Off	The display will remain off when the power cord is connected.
	Forced On	The display will turn on when the power cord is connected.
Last Status	The display will return to the previous power status.	
WOL	Enable/Disable the Wake on LAN (WOL) feature.	
Monitor ID	Assign a number to remote control the display by RS-232. NOTE: The number range is: 1~98; 99 is reserved for "All Displays".	
Language	Select OSD Menu language.	
Factory Reset	Reset all OSD Menu settings to default.	
Advanced Reset	Reset all Advanced menu settings to default.	

²– For HDMI input only.

Setting the Display to AutoPlay on Boot

The display supports autoplay only from a USB thumb drive. For other devices, use a content management system software.

From USB Thumb Drive

1. Plug the USB thumb drive that has media files (e.g., photos, music, or videos) into a USB Type A port of the display.
2. Press the **Settings** button on the remote control to open the On-Screen Display Menu.
3. Go to **Advanced**, then turn on the **USB Auto Play** toggle. This action creates a folder called "AutoPlayFiles" and copies all the media files in the USB thumb drive to the folder automatically.
4. On the **Advanced** menu, go to **Boot on Source**, then turn on the **USB Auto Play** toggle.
5. Next time the display is turned on, the media files in the folder will autoplay.

Using a CMS software

1. Downloaded the CMS software to the display.
2. Press the **Settings** button on the remote control to open the On-Screen Display Menu.
3. Go to **Advanced > Boot on Source > Custom**, then select the installed CMS software.
4. Next time the display is turned on, the CMS software will launch automatically.

About

Show the display's current heat status and other information.

Welcome | 02:17 PM
2025.11.14 Friday

- Picture
- PIP
- Tiling
- Audio
- Time
- Advanced
- About

Heat status 67.0 °C

Monitor Information

- Model name CDE6531-1C
- Serial NO.
- Operation hours 3062 h 20 min
- SW Version 20250916.152310

On-Screen Display (OSD) Menu Tree

Main Menu	Sub-menu	Menu Option		
Picture	White Balance Gain	RGB Gain Adjust	0~255	
	Brightness	(-/+ , 0~100)/1		
	Contrast	(-/+ , 0~100)/1		
	Sharpness	(-/+ , 0~100)/10		
	Color	(-/+ , 0~100)/1		
	Color Temperature	Warm		
		Normal		
		Cool		
		User		
	Picture Mode	Normal		
		Dynamic		
		Soft		
		User		
	Overscan	Off		
		On		
	RGB Range			
	Flicker Free	Off		
		On		
	Blue Light Filter	(-/+ , 0~100)/1		
	Noise Reduction	Off		
		Low		
		Medium		
High				
Gamma Set	Native			
	2.2			
	2.4			
	DICOM			
HDR10				
Picture Reset	Cancel			
	Reset			

Main Menu	Sub-menu	Menu Option
PIP	Sub Mode	Off
		PIP
		PBP
	PIP Size	Small
		Medium
		Large
	PIP Position	Bottom-Right
		Bottom-Left
		Top-Right
		Top-Left
	PIP Source	
	PIP Audio	Main
		Sub
PIP Reset		
Tiling	Enable	On
		Off
	H Monitors	(-/+ , 1~5)/1
	V Monitors	(-/+ , 1~5)/1
	Position	(-/+ , 1~25)/1
	Frame Comp	On
Off		

Main Menu	Sub-menu	Menu Option
Audio	Balance	(-/+ , 0~100)
	Treble	(-/+ , 0~100)
	Bass	(-/+ , 0~100)
	Volume	(-/+ , 0~100)/1
	Maximum Volume	(-/+ , 0~100)/1
	Minimum Volume	(-/+ , 0~100)/1
	Mute	Off
		On
	Mute Status Notification	On
		Off
		3s Show
	Volume Control	Speaker
		Audio Out
		Sync
	Line Out Sync	Enable
		Disable
	Line Out Volume	(-/+ , 0~100)/1
	Audio Reset	Cancel
Reset		

Main Menu	Sub-menu	Menu Option			
Time	Off Time	Off			
		10/20/30/60/90/120/ 180/204 min			
	Day and Time	User Network Provided Time			
		Set Date			
		Set Time			
		Choose Time Zone			
		Use 24-Hour Format			
		Set Date Format			
		Schedule	Schedule List		
	Enable				
	Start Time				
	End Time				
	Input		HDMI 1		
			HDMI 2		
			HDMI 3		
			TYPE C		
			USB Auto Play		
			Custom		
	Day of the Week	Day of the Week			
		Every Week			
	Slideshow Interval	5/10/15/20 seconds			
		User			
	OSD Turn Off	Off			
		-		(-/+ , 5~120)/5 Seconds	
	OSD Information	Off			
		-		(-/+ , 1~60)/1 Second	
	Switch on Delay	Off			
On					
Time Reset	Cancel				
	Reset				

Main Menu	Sub-menu	Menu Option
Advanced	Panel Saving	Off
		On
	Power Save	Mode 1
		Mode 2
		Mode 3
		Mode 4
	Power LED Light	Off
		On
	Boot on Source	Last Input
		HDMI 1
		HDMI 2
		HDMI 3
		TYPE C
		USB Auto Play
		Custom
	Boot on Logo	Off
		On
		User
	Auto Switch Input Ports	Off
		On
	Auto Signal Detection	Off
		Auto
		Last
		Fail Over
	No Signal Standby	Off
		0 min
		5 min
		15 min
		30 min
	HDMI with One Wire	Off
		On
	USB Cloning	Import
Export		

Main Menu	Sub-menu	Menu Option
Advanced	HDMI Version	Standard 1
		Standard 2
		Enhanced
	USB Auto Play	Off
		On
	Power Off Reminder	Off
		On
	Switch On State	Power Off
		Forced On
		Last Status
	WOL	Off
		On
	Monitor ID	(-/+ , 1~98)/1
	Language	Česká
		Dansk
		Deutsch
		English
		Español
		Français
		Italiano
		日本語
		Norsk Bokmål
		Polski
		Русский
		Svenska
		Türkçe
		繁體中文
	简体中文	
	Factory Reset	Cancel
		Reset
	Advanced Reset	Cancel
		Reset

Main Menu	Sub-menu	Menu Option	
About	Heat Status		
	Monitor Information	Model Name	
		Serial No.	
		Operation Hours	
		SW Version	

Pre-installed Applications and Settings

AirSync

Wirelessly share a device's screen to a larger display.

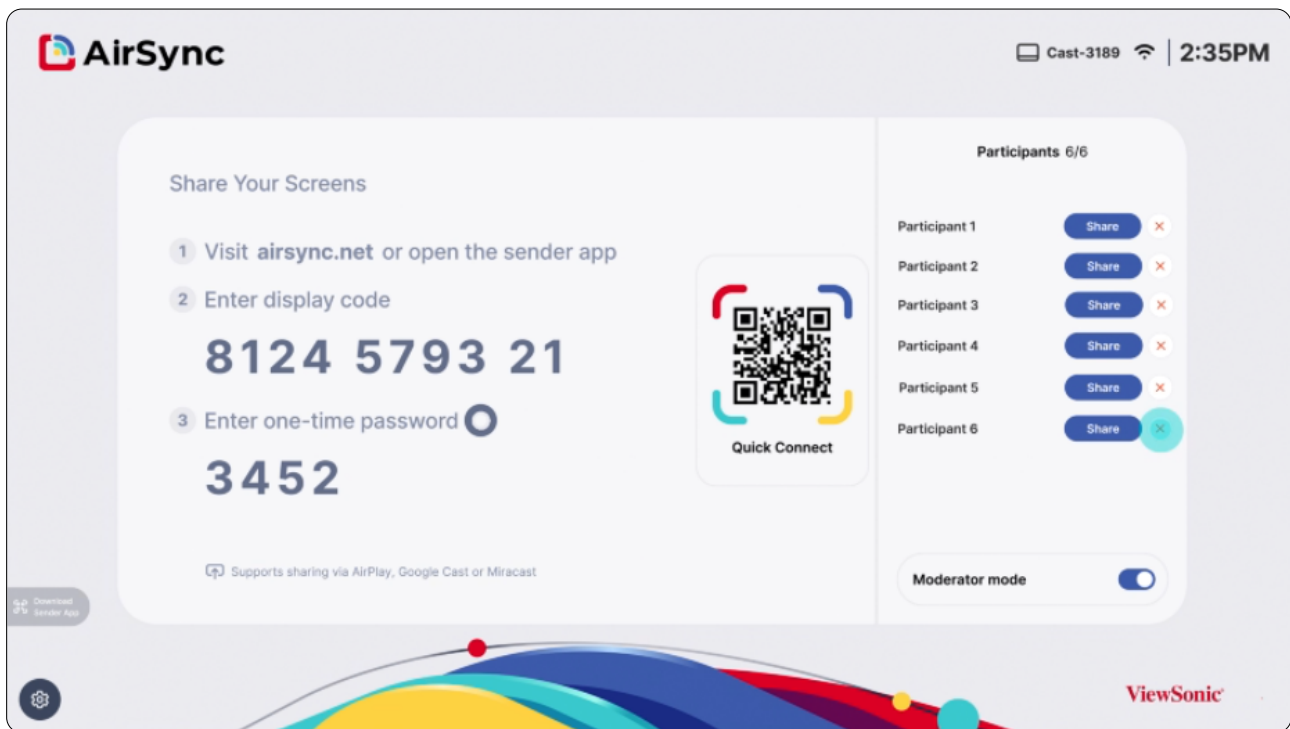

NOTE: To learn more about AirSync, visit the [ViewSonic Apps and ViewBoard Knowledge Base](#).

Manager

Remotely manage multiple ViewSonic device installations.

NOTE: Only Entity Admins, after logging into myviewboard.com, have access to this feature.

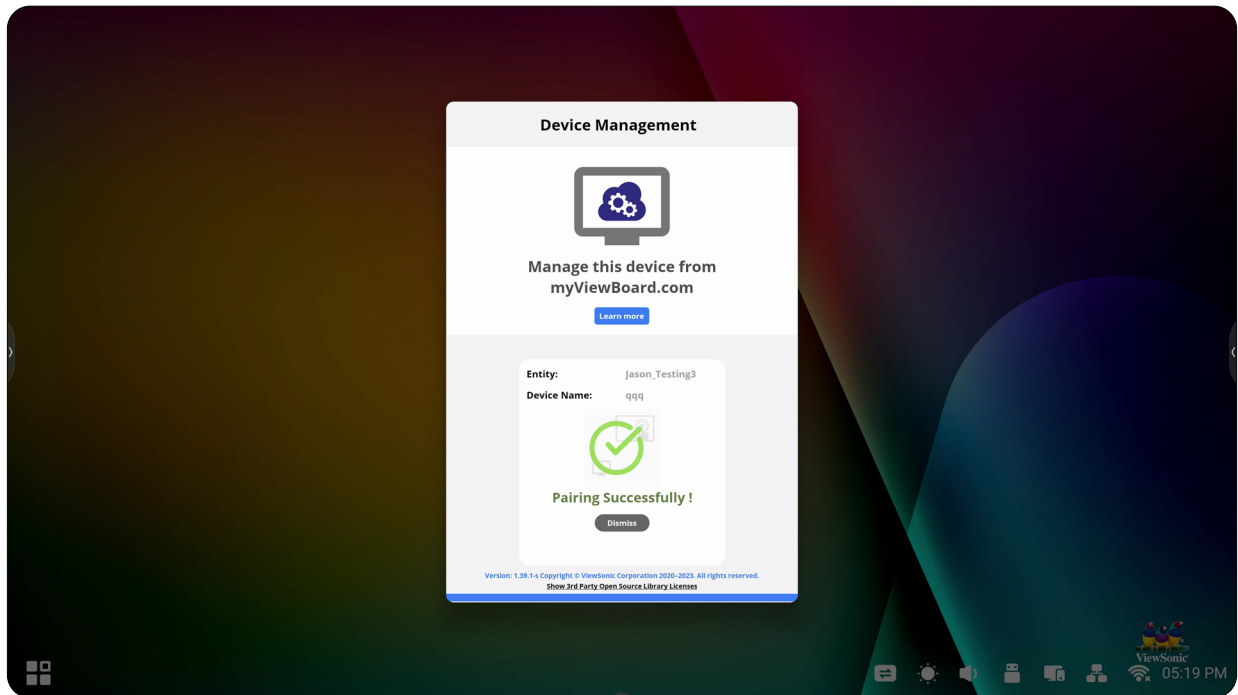

After setting up devices and installing Manager, you can add them to an entity and manage them remotely from the Manager web application.

NOTE: To learn more about Manager, visit the [ViewSonic Apps and ViewBoard Knowledge Base](#).

Chromium

A web browser for surfing the Internet.

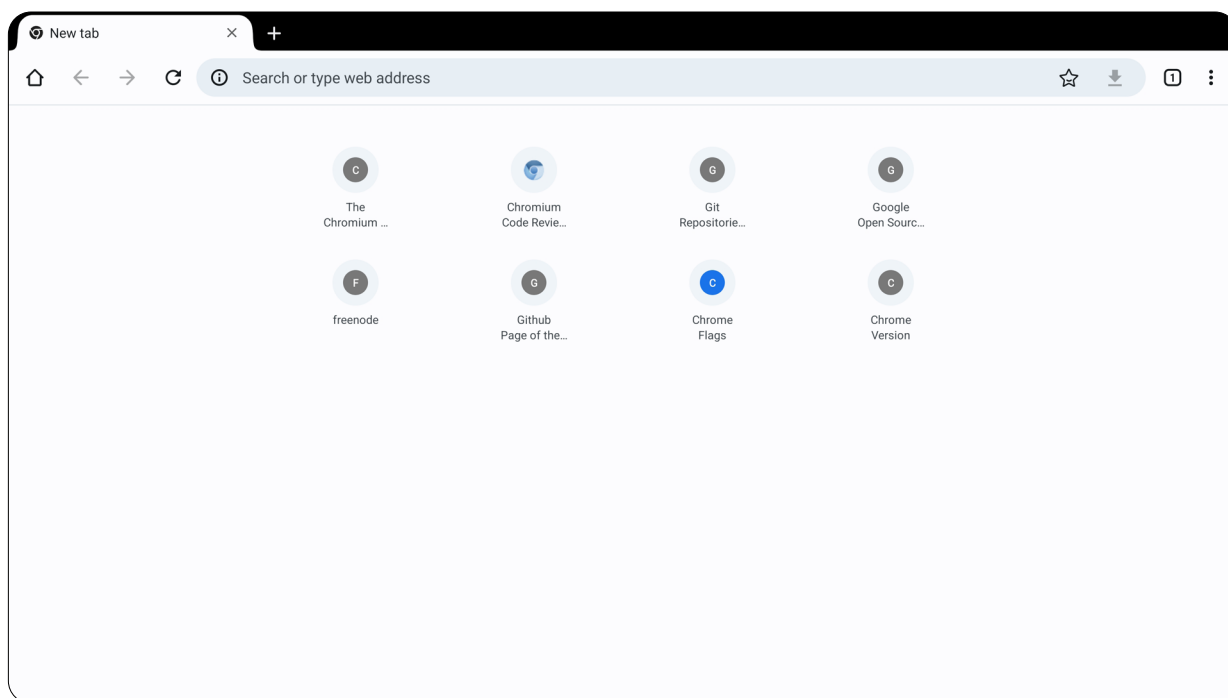

NOTE: To learn more about Chromium, visit the [Chromium Projects](#).

Office

Create, edit, and view documents, memos, presentations, and spreadsheets.

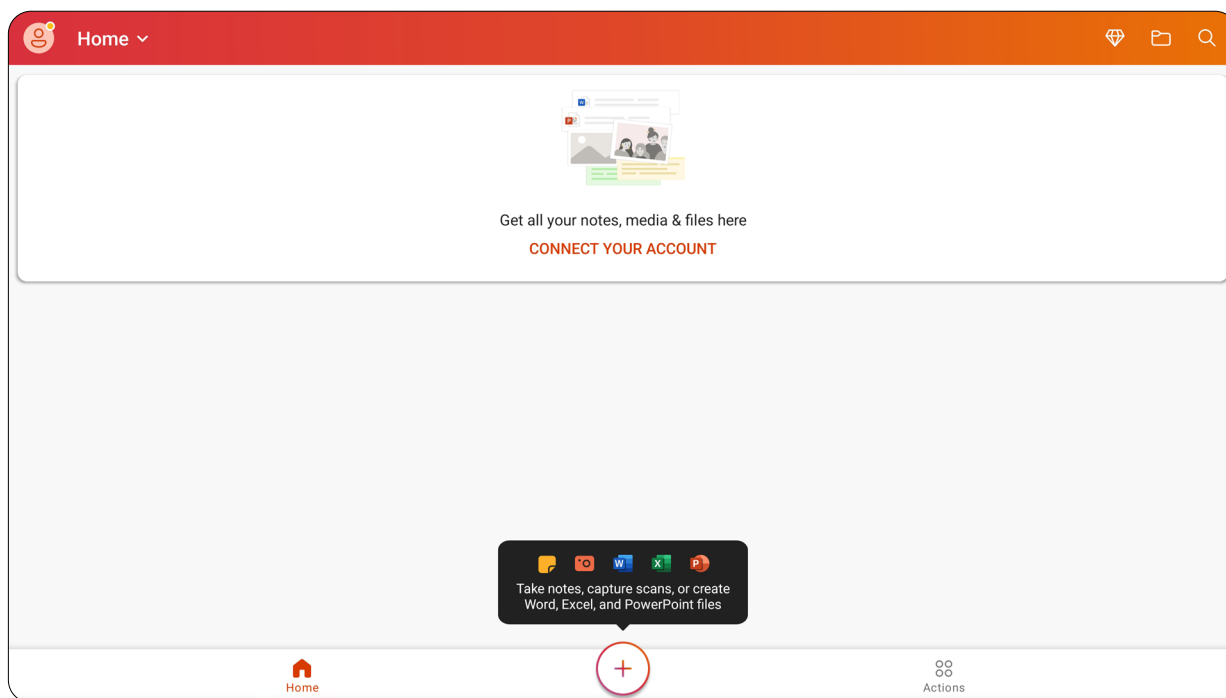

NOTE: To learn more about Office, visit the [Microsoft Office](#).

Revel Digital Player

Manage digital signage.



NOTE: To learn more about Revel Digital Player, visit the [Revel Digital](#).

vSweeper

Clear unnecessary data and unwanted files.

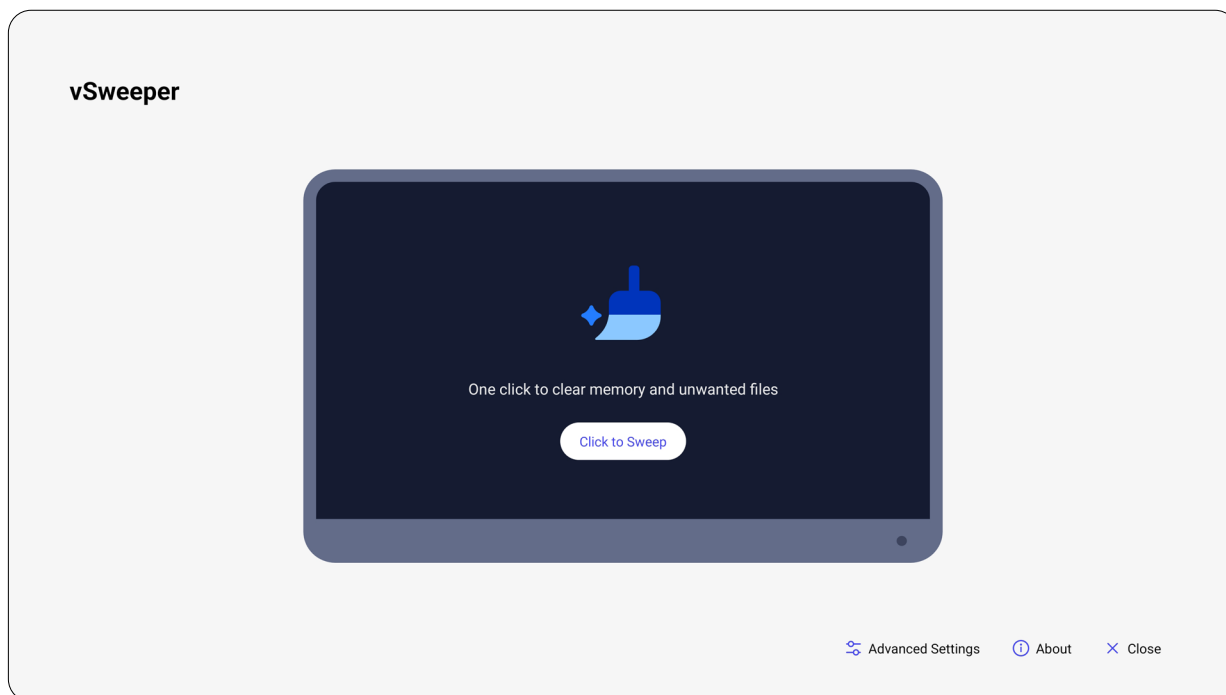

Advanced Settings can also be customized to the user's needs.

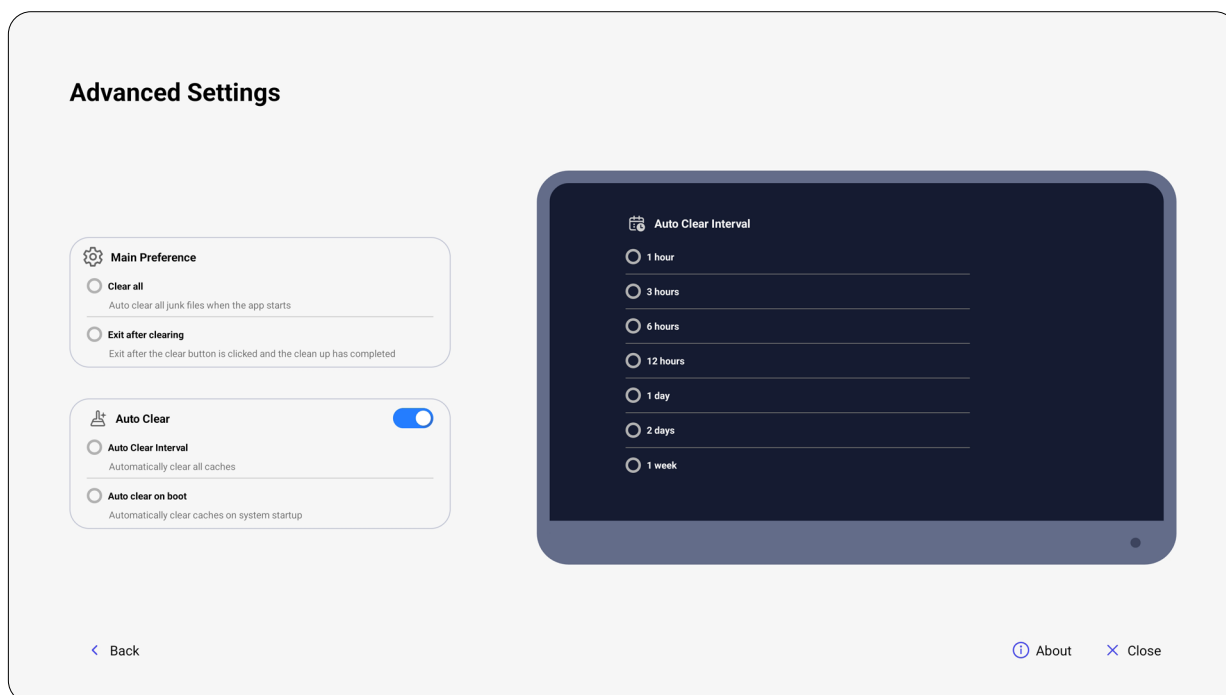



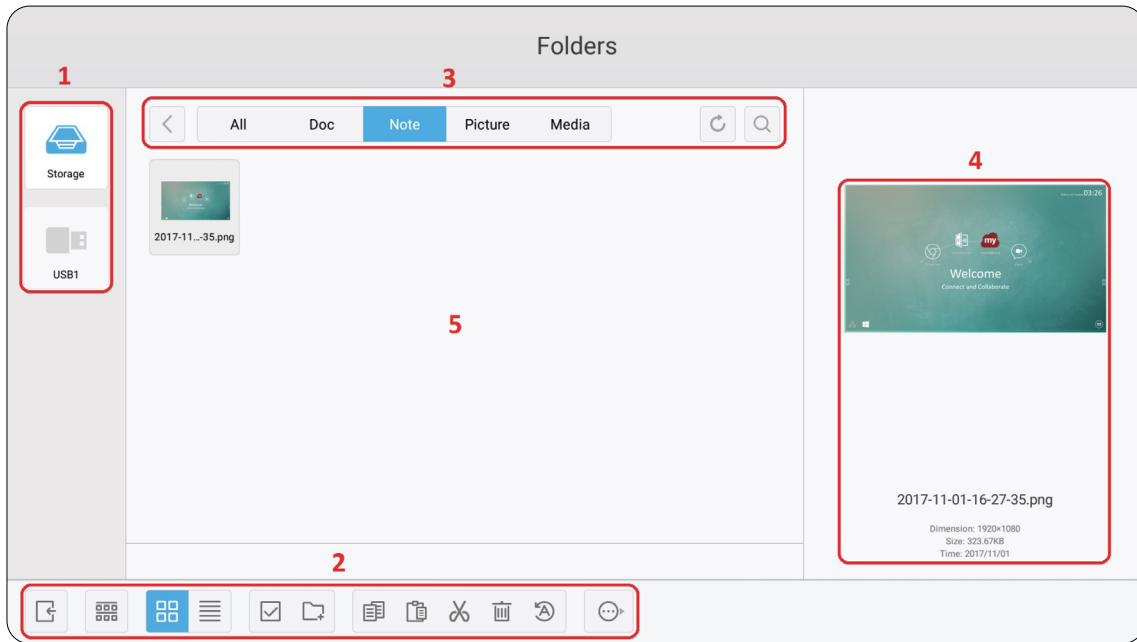









Folders



1. Storage Device Display

Select the appropriate storage device.

2. Icons

	Item	Description
	Exit	Exit Folders
	Sort	Sort the files
	Thumbnail	Display files by thumbnail view
	List	Display files by list view
	Select	Select a file
	Add folder	Add a folder
	Copy	Copy a file
	Paste	Paste a file
	Cut	Cut a file
	Delete	Delete a file
	Rename	Rename a file
	More	Show more functions

3. File Type Menu

Item	Description
All	All types
Doc	Office files
Note	Images stored by myViewBoard, Side Tool Bar, and remote control Screen Capture button.
Picture	Image files
Media	Audio and Video files

4. File Information

Preview the file, show the file's name, size, resolution, and creation date.

5. Main Display Area

Display files of corresponding type.

RS-232 Protocol

This document describes the hardware interface spec and software protocols of the RS-232 interface communication between ViewSonic LFD and a PC or other control units with RS-232 protocol.

The protocol contains three command sections:

- Set-Function
- Get-Function
- Remote control pass-through mode

NOTE: Below, “PC” represents all the control units that can send or receive the RS-232 protocol command.

Description

RS-232 Hardware Specification

ViewSonic LFD communication port on the rear side:

1. Connector type: DSUB 9-Pin Male (female or 3.5 mm barrel connector)
2. Use of crossover (null modem) cable for connection
3. Pin Assignment:

Male DSUB 9-Pin
(preferred)

1 2 3 4 5



6 7 8 9

Female DSUB 9-Pin

5 4 3 2 1

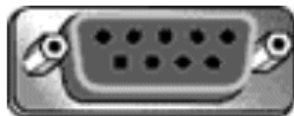

9 8 7 6

3.5 mm barrel
connector (alternative
for limited space)



Pin #	Signal	Remark
1	NC	
2	RXD	Input to Display
3	TXD	Output from Display
4	NC	
5	GND	
6	NC	
7	NC	
8	NC	
9	NC	
frame	GND	

Item	Signal	Remark
Tip	TXD	Output from Display
Ring	RXD	Input to Display
Sleeve	GND	

LAN Hardware Specification

ViewSonic LFD communication port on the rear side:

1. Connector type: 8P8C RJ45
2. Pin Assignment:

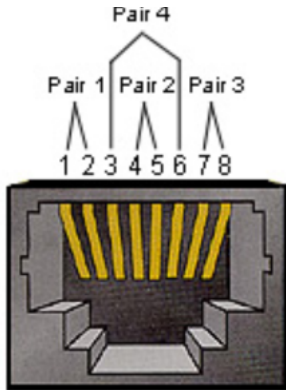

Pin #	Signal	Remark
1	TX+	Output from Display
2	TX-	Output from Display
3	RX+	Input to Display
4	BI_D3+	For 1G case
5	BI_D3-	For 1G case
6	RX-	Input to Display
7	BI_D4+	For 1G case
8	BI_D4-	For 1G case
frame	GND	

RS-232 Communication Setting

- Baud Rate Select: 9600bps (fixed)
- Data bits: 8 bits (fixed)
- Parity: None (fixed)
- Stop Bits: 1(fixed)

LAN Communication Setting

- Type: Ethernet
- Protocol: TCP/IP
- Port: 5000 (fixed)
- WOL Port: 9 (fixed) for UDP ^{*3.2.0}
- Cross subnet: No
- Logon Credentials: No

Command Message Reference

PC sends to LFD command packet followed by “CR”. Every time PC sends control command to Display, the Display shall respond as follows:

1. If the message is received correctly it will send “+” (02Bh) followed by “CR” (00Dh)
2. If the message is received incorrectly it will send “-” (02Dh) followed by “CR” (00Dh)

Protocol

Set-Function Listing

The PC can control the Display for specific actions. The Set-Function command allows you to control the Display behavior at a remote site through the RS-232 port. The Set-Function packet format consists of 9 bytes.

Set-Function Description:

- Length:** Total Byte of Message excluding "CR"
- LFD ID** Identification for each of Display (01~98; default is 01)
ID "99" means to apply the set command for all connected displays. Under such circumstances, only ID#1 display has to reply.
The LFD ID can be set via the OSD menu for each Display.
- Command Type** Identify command type,
"s" (0x73h): Set Command
"+" (0x2Bh): Valid command Reply
"- " (0x2Dh): Invalid command Reply
- Command:** Function command code: One byte ASCII code.
- Value[1~3]:** Three bytes ASCII that defines the value.
- CR** 0x0D

Set-Function Format

Send: (Command Type="s")

Name	Length	ID	Command Type	Command	Value1	Value2	Value3	CR
Byte Count	1 Byte	2 Byte	1 Byte	1 Byte	1 Byte	1 Byte	1 Byte	1 Byte
Bytes order	1	2~3	4	5	6	7	8	9

Reply: (Command Type="+" or "-")

Name	Length	ID	Command Type	CR
Byte Count	1 Byte	2 Byte	1 Byte	1 Byte
Bytes order	1	2~3	4	5

NOTE: When PC applies command to all displays (ID=99), only the #1 set needs to reply by the name of ID=1.

Example 1: Set Brightness as 76 for Display (#02) and this command is valid

Send (Hex Format)

Name	Length	ID	Command Type	Command	Value1	Value2	Value3	CR
Hex	0x38	0x30 0x32	0x73	0x24	0x30	0x37	0x36	0x0D

Reply (Hex Format)

Name	Length	ID	Command Type	CR
Hex	0x34	0x30 0x32	0x2B	0x0D

Example 2: Set Brightness as 75 for Display (#02) and this command is NOT valid

Send (Hex Format)

Name	Length	ID	Command Type	Command	Value1	Value2	Value3	CR
Hex	0x38	0x30 0x32	0x73	0x24	0x30	0x37	0x35	0x0D

Reply (Hex Format)

Name	Length	ID	Command Type	CR
Hex	0x34	0x30 0x32	0x2D	0x0D

Set-Function Table

A. Basic Function

Set Function	Length	ID	Command		Value Range	Comments
			Type (ASCII)	Code (ASCII) Code (Hex)		
Power on *3.2.1/ off (standby)	8		s	!	21 000: STBY 001: ON	1. The Power-on via LAN control may work only under specific mode. To see display UG for details. *3.1.1 2. "WOL by MAC address" may available as alternative.*3.2.1
Input Select	8		s	"	22 004: HDMI1 014: HDMI2 024: HDMI3 006: VGA 007: Slot-in PC (OPS) 009: DP 019: Type-C *3.2.4 00A: Embedded/ Main (Android)	1. No need for USB 2. For the case of two more same sources, the 2nd digital is used to indicate the extension. 3. The HEX of 00A is 30 30 41.
Brightness	8		s	\$	24 000 ~ 100 900: Bright down (-1) 901: Bright up (+1) *3.1.1	
Backlight *3.2.0	8		A	B	42 000 ~ 100	1. For Android platform whose main mode is controlled by backlight and the other sources are controlled by brightness. 2. Derived from Color calibration. *3.2.0
Power lock	8		s	4	34 000: Unlock 001: Lock	*See note in details
Volume	8		s	5	35 000 ~ 100 900: Volume down(-1) 901:Volume up(+1)	
Mute	8		s	6	36 000: OFF 001: ON (mute)	
Button lock	8		s	8	38 000: Unlock 001: Lock	*See note in details
Menu lock	8		s	>	3E 000: Unlock 001: Lock	*See note in details

Set Function	Length	ID	Command	Command	Value Range	Comments	
Number *3.1.1	8		s	@	40	000~009	
Key Pad *3.1.1	8		s	A	41	000: UP 001: DOWN 002: LEFT 003: RIGHT 004: ENTER 005: INPUT 006: MENU/(EXIT) 007: EXIT	
Remote Control	8		s	B	42	000: Disable 001: Enable 002: Pass through	Disable: RCU will be no function Enabled: RCU controls normally Pass through: Display will bypass the RC code to connected device via the RS-232 port, but not react itself.
Restore default	8		s	~	7E	000	Recover to factory setting

B. Optional Function

Set Function	Length	ID	Command		Value Range (Three ASCII bytes)	Comments
			Type (ASCII)	Code (ASCII) Code (Hex)		
Contrast	8		s	# 23	000 ~ 100	
Sharpness	8		s	% 25	000 ~ 100	
Color	8		s	& 26	000 ~ 100	
Tint	8		s	' 27	000 ~ 100	
Backlight On_Off *3.2.3	8		s	(29	000: Off 001: On	
Color mode	8		s) 29	000: Normal 001: Warm 002: Cold 003: Personal	
Freeze On_Off *3.2.5	8		s	* 2A	000: Off 001: On	
Bass	8		s	. 2E	000 ~ 100	
Treble	8		s	/ 2F	000 ~ 100	
Balance	8		s	0 30	000 ~ 100	050 is central
Picture Size	8		s	1 31	000: FULL (16:9) 001: NORMAL (4:3) 002: REAL (1:1) *3.1.0	
OSD language	8		s	2 32	000: English 001: French 002: Spanish	Could be extended for more supported languages by model
Date: Year	8		s	V 56	Y17~Y99	Last 2 digits (20)17~(20)99
Date: Month	8		s	V 56	M01~M12	2 digits
Date: Day	8		s	V 56	D01~D31	2 digits
Time: Hour	8		s	W 57	H00~H23	24-hr format. 2 digits.
Time: Min	8		s	W 57	M00~M59	2 digits
Time: Sec	8		s	W 57	S00~S59	2 digits
Customized Hot Keys *3.2.6	8		s	X 58	001~999 001: Open MVBA app *3.2.6	

Appendix

USB Media Support Format

Photo

File Extension	Format	Supported Range	Note
.jpeg/jpg	JPEG	Baseline: 16383 x 16383	Hardware decoder
		Progressive: 1920 x 1080	
.png	PNG	8192 x 4320	The maximum value of the resolution depends on the size of the DRAM memory.
.bmp	BMP		
.gif	GIF		

Video

File Extension	Video	Audio	Maximum Transmit Ratio
.3gp/3GP2	VP8	MPEG1/2 Layer1/2/3, AAC-1.C, HEAAC, VORBIS, LPCM, FLAG	1920 x 1080 @ 60 fps, 40 Mbps
	H.263		1408 x 1152 @ 60 fps, 60 Mbps
	H.264		3840 x 2160 @ 60 fps (up to: 4096 x 2304), 1920 x 1080 @ 120 fps, 135 Mbps
	H.265		3840 x 2160 @ 60 fps (up to: 4096 x 2304), 1920 x 1080 @ 120 fps, 100 Mbps
	MPEG-1		720 x 576 @ 30 fps, 60Mbps
	MPEG-2		3840 x 2160 @ 60 fps (up to: 4096 x 2304), 1920 x 1080 @ 120 fps, 60 Mbps
	VP9		3840 x 2160 @ 60 fps (up to: 4096 x 2304), 1920 x 1080 @ 120 fps, 100 Mbps
	MJPEG		1920 x 1080 @ 60 fps, 60 Mbps
	MPEG-4		1920 x 1080 @ 60 fps, 60 Mbps
.avi	VP8	MPEG1/2 Layer1/2/3, AAC-1.C, HEAAC, VORBIS, LPCM	1920 x 1080 @ 60 fps, 40 Mbps
	H.263		1408 x 1152 @ 60 fps, 60 Mbps
	H.264		3840 x 2160 @60 fps (up to: 4096 x 2304), 1920 x 1080 @ 120 fps, 135 Mbps
	H.265		3840 x 2160 @ 60 fps (up to: 4096 x 2304), 1920 x 1080 @ 120 fps, 100 Mbps
	MPEG-1		720 x 576 @ 30 fps, 60 Mbps
	MJPEG		1920 x 1080 @ 60 fps, 60 Mbps
	MPEG-2		3840 x 2160 @ 60 fps (up to: 4096 x 2304), 1920 x 1080 @ 120 fps, 60 Mbps
	MPEG-4		1920 x 1080 @ 60 fps, 60 Mbps

File Extension	Video	Audio	Maximum Transmit Ratio
.dat	H.264	MPEG1/2 Layer1/2/3, AAC-LC, HEAAC, LPCM	3840 x 2160 @ 60 fps (up to: 4096 x 2304), 1920 x 1080 @ 120 fps, 135 Mbps
	MPEG-1		720 x 576 @ 30 fps, 60 Mbps
	MPEG-2		3840 x 2160 @ 60 fps (up to: 4096 x 2304), 1920 x 1080 @ 120 fps, 60 Mbps
	MPEG-4		1920 x 1080 @ 60 fps, 60 Mbps
.flv	H.264	1/2 Layer1/2/3, AAC-LC, HEAAC, LPCM	3840 x 2160 @ 60 fps (up to: 4096 x 2304), 1920 x 1080 @ 120 fps, 135 Mbps
	H.265		3840 x 2160 @ 60 fps (up to: 4096 x 2304), 1920 x 1080 @ 120 fps, 100 Mbps
.mkv	VP8	MPEG1/2 Layer1/2/3, AAC-LC, HEAAC, LPCM, FLAC, OPUS	1920 x 1080 @ 60 fps, 40 Mbps
	VP9		3840 x 2160 @ 60 fps (up to: 4096 x 2304), 1920 x 1080 @ 120 fps, 100 Mbps
	H.264		3840 x 2160 @ 60 fps (up to: 4096 x 2304), 1920 x 1080 @ 120 fps, 135 Mbps
	H.265		3840 x 2160 @ 60 fps (up to: 4096 x 2304), 1920 x 1080 @ 120 fps, 100 Mbps
	MPEG-1		720 x 576 @ 30 fps, 60 Mbps
	MPEG-2		3840 x 2160 @ 60 fps (up to: 4096 x 2304), 1920 x 1080 @ 120 fps, 60 Mbps
	MJPEG		1920 x 1080 @ 60 fps, 60 Mbps
	MPEG-4		1920 x 1080 @ 60 fps, 60 Mbps

File Extension	Video	Audio	Maximum Transmit Ratio
.mov	VP8	MPEG1/2 Layer1/2/3, AAC-LC, HEAAC, LPCM, FLAC	1920 x 1080 @ 60 fps, 40 Mbps
	VP9		3840 x 2160 @ 60 fps (up to: 4096 x 2304), 1920 x 1080 @ 120 fps, 100 Mbps
	H.263		1408 x 1152 @ 60 fps, 60 Mbps
	H.264		3840 x 2160 @ 60 fps (up to: 4096 x 2304), 1920 x 1080 @ 120 fps, 135 Mbps
	H.265		3840 x 2160 @ 60 fps (up to: 4096 x 2304), 1920 x 1080 @ 120 fps, 100 Mbps
	MPEG-1		720 x 576 @ 30 fps, 60 Mbps
	MPEG-2		3840 x 2160 @ 60 fps (up to: 4096 x 2304), 1920 x 1080 @ 120 fps, 60 Mbps
	MJPEG		1920 x 1080 @ 60 fps, 60 Mbps
	MPEG-4		1920 x 1080 @ 60 fps, 60 Mbps
.mp4	VP8	MPEG1/2 Layer1/2/3, AAC-LC, HEAAC, LPCM, FLAC	1920x1080@60fps, 40Mbps
	VP9		3840 x 2160 @ 60 fps (up to: 4096 x 2304), 1920 x 1080 @ 120 fps, 100 Mbps
	H.263		1408 x 1152 @ 60 fps, 60 Mbps
	H.264		3840 x 2160 @ 60 fps (up to: 4096 x 2304), 1920 x 1080 @ 120 fps, 135 Mbps
	H.265		3840 x 2160 @ 60 fps (up to: 4096 x 2304), 1920 x 1080 @ 120 fps, 100 Mbps
	MPEG-1		720 x 576 @ 30 fps, 60 Mbps
	MPEG-2		3840 x 2160 @ 60 fps (up to: 4096 x 2304), 1920 x 1080 @ 120 fps, 60 Mbps
	MJPEG		1920 x 1080 @ 60 fps, 60 Mbps
	MPEG-4		1920 x 1080 @ 60 fps, 60 Mbps

File Extension	Video	Audio	Maximum Transmit Ratio
.vob	H.264	MPEG1/2 Layer1/2/3, AAC-LC, HEAAC, LPCM	3840 x 2160 @ 60 fps (up to: 4096 x 2304), 1920 x 1080 @ 120 fps, 135 Mbps
	MPEG-1		720 x 576 @ 30 fps, 60 Mbps
	MPEG-2		3840 x 2160 @ 60 fps (up to: 4096 x 2304), 1920 x 1080 @ 120 fps, 60 Mbps
	MPEG-4		1920 x 1080 @ 60 fps, 60 Mbps
.mpg/.mpeg	H.264	MPEG1/2 Layer1/2/3, AAC-LC, HEAAC, LPCM	3840 x 2160 @ 60 fps (up to: 4096 x 2304), 1920 x 1080 @ 120 fps, 135 Mbps
	MPEG-1		720 x 576 @ 30 fps, 60 Mbps
	MPEG-2		3840 x 2160 @ 60 fps (up to: 4096 x 2304), 1920 x 1080 @ 120 fps, 60 Mbps
	MPEG-4		1920 x 1080 @ 60 fps, 60 Mbps
.webm	VP8	VORBIS, OPUS	1920 x 1080 @ 60 fps, 40 Mbps
	VP9		3840 x 2160 @ 60 fps (up to: 4096 x 2304), 1920 x 1080 @ 120 fps, 100 Mbps
.ts	H.264	MPEG1/2 Layer1/2/3, AAC-LC, HEAAC, LPCM	3840 x 2160 @ 60 fps (up to: 4096 x 2304), 1920 x 1080 @ 120 fps, 135 Mbps
	MPEG-1		720 x 576 @ 30 fps, 60 Mbps
	MPEG-2		3840 x 2160 @ 60 fps (up to: 4096 x 2304), 1920 x 1080 @ 120 fps, 60 Mbps
	H.265		3840 x 2160 @ 60 fps (up to: 4096 x 2304), 1920 x 1080 @ 120 fps, 100Mbps
	MPEG-4		1920 x 1080 @ 60 fps, 60 Mbps

Audio

File Extension	Format	Audio Codec	Supported Range
.aac/.m4a	AAC, M4A	AAC-LC, HEAAC	<ul style="list-style-type: none"> • Sample Rate: 8KHz~48KHz • Bit Rate: 12Kbps~576Kbps
.mpg	MP2, MP3	MPEG1/2/ Layer1/2/3	<ul style="list-style-type: none"> • Sample Rate: 16KHz~48KHz • Bit Rate: 8Kbps~384Kbps
	AAC,M4A	AAC-LC, HEAAC	<ul style="list-style-type: none"> • Sample Rate: 8KHz~48KHz • Bit Rate: 12Kbps~576Kbps
	LPCM	LPCM	<ul style="list-style-type: none"> • Sample Rate: 8KHz~48KHz • Bit Rate: 64Kbps~1.5Mbps
.flac	FLAC	FLAC	<ul style="list-style-type: none"> • Sample Rate: 8KHz~44KHz • Bit Rate: < 1.6Mbps
.mp3	MPEG Audio Layer3	MPEG1/2/ Layer13	<ul style="list-style-type: none"> • Sample Rate: 8KHz~48KHz • Bit Rate: 8Kbps~320Kbps
.ogg	Vorbis	Vorbis	<ul style="list-style-type: none"> • Sample Rate: ~48KHz • Bit Rate: NA
	OPUS	OPUS	<ul style="list-style-type: none"> • Sample Rate: 8KHz~48KHz • Bit Rate: 6Kbps~510Kbps
.wav	AAC,M4A	AAC-LC, HEAAC	<ul style="list-style-type: none"> • Sample Rate: 8KHz~48KH • Bit Rate: 12Kbps~576Kbps
	LPCM	LPCM	<ul style="list-style-type: none"> • Sample Rate: 8KHz~48KHz • Bil Rate: 64Kbps~1.5Mbps

Timing Table

HDMI PC | Type C

Resolution	Refresh Rate (V Frenquency/Hz)	H Frenquency (kHz)	Pixel Rate (MHz)	Stand for Mode
640 x 480	59.94	31.469	25.175	VESA
800 x 600	56.25	35.156	36.000	VESA
800 x 600	60.32	37.879	40.000	VESA
1024 x 768	60.00	48.363	65.000	VESA
1280 x 800	59.81	49.702	83.500	VESA
1280 x 1024	60.02	63.981	108.000	VESA
1360 x 768	60.02	47.712	85.500	VESA
1680 x 1050	59.95	65.290	146.250	VESA
1920 x 1080	60.00	67.500	148.500	VESA
2560 x 1440	59.95	88.787	241.5	VESA

HDMI

Video	Refresh Rate (V Frequency/Hz)	H Frequency (kHz)	Pixel Rate (MHz)	Stand for Mode
480p	27.027	31.500	60.00	CEA-861
576p	27.000	31.250	50.00	
720p	74.250	37.500	50.00	
	45.000	60.00	60.00	
1080p	74.175	26.973	23.98	
	74.250	27.000	24.00	
	74.250	28.125	25.00	
	74.175	33.716	29.97	
	74.250	33.750	35.00	
	148.500	56.250	50.00	
148.500	67.500	60.00		
720 (1440) x 480i	27.000	15.734	59.94	
720 (1440) x 576i	27.000	15.625	50.00	
1080i	74.250	28.125	50.00	
	74.250	33.750	60.00	
3840 x 2160	297.000	54.000	23.98	CTA
	297.000	56.250	25.00	
	297.000	67.500	29.97	
	594.000	112.500	50.00	
	594.000	135.000	59.94	

Type C

Video	Refresh Rate (V Frequency/Hz)	H Frequency (kHz)	Pixel Rate (MHz)	Stand for Mode
480p	27.027	31.500	60.00	CEA-861
576p	27.000	31.250	50.00	
720p	74.250	37.500	50.00	
	45.000	60.00	60.00	
1080p	74.175	26.973	23.98	
	74.250	27.000	24.00	
	74.250	28.125	25.00	
	74.175	33.716	29.97	
	74.250	33.750	35.00	
	148.500	56.250	50.00	
3840 x 2160	148.500	67.500	60.00	CTA
	297.000	54.000	23.98	
	297.000	56.250	25.00	
	297.000	67.500	29.97	
	594.000	112.500	50.00	
	594.000	135.000	59.94	

Troubleshooting

This section describes some common problems that you may experience when using the display.

Problem or Issue	Possible Solutions
Remote Control is not working	<ol style="list-style-type: none">1. Check whether something is obstructing the display's remote control receiver.2. Check whether the batteries in the remote control are installed correctly.3. Check whether the batteries need to be replaced.
The unit turns off unexpectedly	<ol style="list-style-type: none">1. Check whether Sleep mode is enabled.2. Check if there is a power outage in your area.3. Turn on the display and see if the problem is with the signal and control system.

PC Mode

Problem or Issue	Possible Solutions
No PC signal	<ol style="list-style-type: none">1. Check the display settings.2. Check the display resolution.3. Adjust the Hs & Vs (synchronization) settings using the OSD menu.
Background streaking	<ol style="list-style-type: none">1. Choose auto adjust.2. Adjust clock and phase.
False color	<ol style="list-style-type: none">1. Check the connection.2. Adjust the chroma, brightness, and contrast settings.
Unsupported format	<ol style="list-style-type: none">1. Choose auto adjust.2. Adjust clock and phase settings.

Video Not Working Properly

Problem or Issue	Possible Solutions
No picture/ No sound	<ol style="list-style-type: none">1. Check the Power status.2. Check the signal cable.3. Check that the internal PC is installed correctly.
Picture is unclear or cuts in and out	<ol style="list-style-type: none">1. Check the signal cable.2. Check if other electronics are interrupting the signal.
Poor picture	<ol style="list-style-type: none">1. Adjust chroma, brightness, and contrast settings in the menu.2. Check the signal cable.

Audio Not Working Properly

Problem or Issue	Possible Solutions
No sound	<ol style="list-style-type: none">1. Press the Mute/Unmute button.2. Adjust the volume.3. Check the audio cable.
One speaker only	<ol style="list-style-type: none">1. Adjust the sound balance in the menu.2. Check the sound control panel settings of the computer.3. Check the audio cable.

Maintenance

General Precautions

- Make sure the device is turned off and the power cable is unplugged from the power outlet.
- Never spray or pour any liquid directly onto the screen or case.
- Handle the device with care, as a darker-colored device, if scuffed, may show marks more clearly than a lighter-colored device.
- Do not use the system continuously for long periods of time.

Cleaning the Screen

- Wipe the screen with a clean, soft, lint-free cloth. This removes dust and other particles.
- If the screen is still not clean, apply a small amount of non-ammonia, non-alcohol based glass cleaner onto a clean, soft, lint-free cloth; then wipe the screen.

Cleaning the Case

- Use a soft, dry cloth.
- If the case is still not clean, apply a small amount of non-ammonia, non-alcohol based, mild non-abrasive detergent onto a clean, soft, lint-free cloth, then wipe the surface.

Disclaimer

- ViewSonic® does not recommend the use of any ammonia or alcohol-based cleaners on the display screen or case. Some chemical cleaners have been reported to damage the screen and/or case of the device.
- ViewSonic® will not be liable for damage resulting from use of any ammonia or alcohol-based cleaners.

NOTE: If condensation appears between the glass and the panel, keep the display turned on until the moisture disappears.

Regulatory and Service Information

Compliance Information

This section addresses all connected requirements and statements regarding regulations. Confirmed corresponding applications shall refer to nameplate labels and relevant markings on the unit.

FCC Compliance Statement

This device complies with part 15 of FCC Rules. Operation is subject to the following two conditions: (1) this device may not cause harmful interference, and (2) this device must accept any interference received, including interference that may cause undesired operation.

This equipment has been tested and found to comply with the limits for a Class B digital device, pursuant to part 15 of the FCC Rules. These limits are designed to provide reasonable protection against harmful interference in a residential installation. This equipment generates, uses, and can radiate radio frequency energy, and if not installed and used in accordance with the instructions, may cause harmful interference to radio communications. However, there is no guarantee that interference will not occur in a particular installation. If this equipment does cause harmful interference to radio or television reception, which can be determined by turning the equipment off and on, the user is encouraged to try to correct the interference by one or more of the following measures:

- Reorient or relocate the receiving antenna.
- Increase the separation between the equipment and receiver.
- Connect the equipment into an outlet on a circuit different from that to which the receiver is connected.
- Consult the dealer or an experienced radio/TV technician for help.

Warning: You are cautioned that changes or modifications not expressly approved by the party responsible for compliance could void your authority to operate the equipment.

Industry Canada Statement

CAN ICES (B) / NMB (B)

CE Conformity for European Countries

CE The device complies with the EMC Directive 2014/30/EU and Low Voltage Directive 2014/35/EU.

The following information is only for EU-member states:

The mark shown to the right is in compliance with the Waste Electrical and Electronic Equipment Directive 2012/19/EU (WEEE). The mark indicates the requirement NOT to dispose of the equipment as unsorted municipal waste, but use the return and collection systems according to local law.



Declaration of RoHS2 Compliance

This product has been designed and manufactured in compliance with Directive 2011/65/EU of the European Parliament and the Council on restriction of the use of certain hazardous substances in electrical and electronic equipment (RoHS2 Directive) and is deemed to comply with the maximum concentration values issued by the European Technical Adaptation Committee (TAC) as shown below:

Substance	Proposed Maximum Concentration	Actual Concentration
Lead (Pb)	0.1%	< 0.1%
Mercury (Hg)	0.1%	< 0.1%
Cadmium (Cd)	0.01%	< 0.01%
Hexavalent Chromium (Cr6 ⁺)	0.1%	< 0.1%
Polybrominated biphenyls (PBB)	0.1%	< 0.1%
Polybrominated diphenyl ethers (PBDE)	0.1%	< 0.1%
Bis (2-ethylhexyl) phthalate (DEHP)	0.1%	< 0.1%
Butyl benzyl phthalate (BBP)	0.1%	< 0.1%
Dibutyl phthalate (DBP)	0.1%	< 0.1%
Diisobutyl phthalate (DIBP)	0.1%	< 0.1%

Certain components of products as stated above are exempted under the Annex III of the RoHS2 Directives as noted below. Examples of exempted components are:

- Copper alloy containing up to 4% lead by weight.
- Lead in high melting temperature type solders (i.e. lead-based alloys containing 85% by weight or more lead).
- Electrical and electronic components containing lead in a glass or ceramic other than dielectric ceramic in capacitors, e.g. piezoelectronic devices, or in a glass or ceramic matrix compound.
- Lead in dielectric ceramic in capacitors for a rated voltage of 125V AC or 250V DC or higher.

ENERGY STAR Statement

ENERGY STAR is a U.S. Environmental Protection Agency voluntary program that helps businesses and individuals save money and protect our climate through superior energy efficiency. Products that earn the ENERGY STAR prevent greenhouse gas emissions by meeting strict energy efficiency criteria or requirements set by the U.S. Environmental Protection Agency.

As an ENERGY STAR Partner, ViewSonic is determined to meet the Energy star Guidelines and mark all certified models with the ENERGY STAR logo.

The following logo appears on all ENERGY STAR-certified models:



NOTE: The power management features significantly reduce energy consumption when the product is not in use. Power management allows the device to automatically enter a low power “sleep” mode after a defined period of inactivity. And the power management features also enter Sleep Mode or Off Mode within 5 minutes of being disconnected from a host computer. Please note any change in energy settings will increase energy consumption.

Indian Restriction of Hazardous Substances

Restriction on Hazardous Substances statement (India). This product complies with the “India E-waste Rule 2011” and prohibits use of lead, mercury, hexavalent chromium, polybrominated biphenyls or polybrominated diphenyl ethers in concentrations exceeding 0.1 weight % and 0.01 weight % for cadmium, except for the exemptions set in Schedule 2 of the Rule.

Product Disposal at End of Product Life

ViewSonic® respects the environment and is committed to working and living green. Thank you for being part of Smarter, Greener Computing. Please visit the ViewSonic® website to learn more.

USA & Canada:

<https://www.viewsonic.com/us/go-green-with-viewsonic>

Europe:

<https://www.viewsonic.com/eu/environmental-social-governance/recycle>

Taiwan:

<https://recycle.moenv.gov.tw/>

For EU users, please contact us for any safety/accident issue experienced with this product:

ViewSonic Europe Limited



Haaksbergweg 75
1101 BR Amsterdam
Netherlands



+31 (0) 650608655



EPREL@viewsoniceurope.com



<https://www.viewsonic.com/eu/>

Copyright Information

Copyright© ViewSonic® Corporation, 2025. All rights reserved.

Macintosh and Power Macintosh are registered trademarks of Apple Inc.

Microsoft, Windows, and the Windows logo are registered trademarks of Microsoft Corporation in the United States and other countries.

ViewSonic® and the three birds logo are registered trademarks of ViewSonic® Corporation.

VESA is a registered trademark of the Video Electronics Standards Association. DPMS, DisplayPort, and DDC are trademarks of VESA.

Disclaimer: ViewSonic® Corporation shall not be liable for technical or editorial errors or omissions contained herein; nor for incidental or consequential damages resulting from furnishing this material, or the performance or use of this product.

In the interest of continuing product improvement, ViewSonic® Corporation reserves the right to change product specifications without notice. Information in this document may change without notice.

No part of this document may be copied, reproduced, or transmitted by any means, for any purpose without prior written permission from ViewSonic® Corporation.

Customer Service

For technical support or product service, see the table below or contact your reseller.

NOTE: You will need the product’s serial number.

Country/Region	Website	Country/Region	Website
Asia Pacific & Africa			
Australia	www.viewsonic.com/au/	Bangladesh	www.viewsonic.com/bd/
中国 (China)	www.viewsonic.com.cn	香港 (繁體中文)	www.viewsonic.com/hk/
Hong Kong (English)	www.viewsonic.com/hk-en/	India	www.viewsonic.com/in/
Indonesia	www.viewsonic.com/id/	Israel	www.viewsonic.com/il/
日本 (Japan)	www.viewsonic.com/jp/	Korea	www.viewsonic.com/kr/
Malaysia	www.viewsonic.com/my/	Middle East	www.viewsonic.com/me/
Myanmar	www.viewsonic.com/mm/	Nepal	www.viewsonic.com/np/
New Zealand	www.viewsonic.com/nz/	Pakistan	www.viewsonic.com/pk/
Philippines	www.viewsonic.com/ph/	Singapore	www.viewsonic.com/sg/
臺灣 (Taiwan)	www.viewsonic.com/tw/	ประเทศไทย	www.viewsonic.com/th/
Việt Nam	www.viewsonic.com/vn/	South Africa & Mauritius	www.viewsonic.com/za/
Americas			
United States	www.viewsonic.com/us	Canada	www.viewsonic.com/us
Latin America	www.viewsonic.com/la		
Europe			
Europe	www.viewsonic.com/eu/	France	www.viewsonic.com/fr/
Deutschland	www.viewsonic.com/de/	Қазақстан	www.viewsonic.com/kz/
Россия	www.viewsonic.com/ru/	España	www.viewsonic.com/es/
Türkiye	www.viewsonic.com/tr/	Україна	www.viewsonic.com/ua/
United Kingdom	www.viewsonic.com/uk/		

Limited Warranty

ViewSonic® Display

What the warranty covers:

ViewSonic® warrants its products to be free from defects in material and workmanship during the warranty period. If a product proves to be defective in material or workmanship during the warranty period, ViewSonic® will, at its sole option, and as your sole remedy, repair or replace the product with a similar product. Replacement Product or parts may include remanufactured or refurbished parts or components. The repair or replacement unit or parts or components will be covered by the balance of the time remaining on the customer's original limited warranty and the warranty period will not be extended. ViewSonic® provides no warranty for any third-party software whether included with the product or installed by the customer, installation of any unauthorized hardware parts or components (e.g. Projector Lamps). (Please refer to: "What the warranty excludes and does not cover" section).

How long the warranty is effective:

ViewSonic® displays are warranted for between 1 and 3 years, depending on your country of purchase, for all parts including the light source and for all labor from the date of the first consumer purchase.

Who the warranty protects:

This warranty is valid only for the first consumer purchaser.

What the warranty excludes and does not cover:

- Any product on which the serial number has been defaced, modified, or removed.
- Damage, deterioration, or malfunction resulting from:
 - » Accident, misuse, neglect, fire, water, lightning, or other acts of nature, unauthorized product modification, or failure to follow instructions supplied with the product.
 - » Repair or attempted repair by anyone not authorized by ViewSonic®.
 - » Damage to or loss of any programs, data, or removable storage media.
 - » Normal wear and tear.
 - » Removal or installation of the product.
- Software or data loss occurring during repair or replacement.

- Any damage of the product due to shipment.
- Causes external to the product, such as electric power fluctuations or failure.
- Use of supplies or parts not meeting ViewSonic's specifications.
- Failure of owner to perform periodic product maintenance as stated in the User Guide.
- Any other cause which does not relate to a product defect.
- Damage caused by static (non-moving) images displayed for lengthy periods of time (also referred to as image burn-in).
- Software - Any third-party software included with the product or installed by the customer.
- Hardware/Accessories/Parts/Components – Installation of any unauthorized hardware, accessories, consumable parts or components (e.g. Projector Lamps).
- Damage to, or abuse of, the coating on the surface of the display through inappropriate cleaning as described in the product User Guide.
- Removal, installation, and set-up service charges, including wall-mounting of the product.

How to get service:

- For information about receiving service under warranty, contact ViewSonic® Customer Support (Please refer to the "Customer Service" page). You will need to provide your product's serial number.
- To obtain warranty service, you will be required to provide: (a) the original dated sales slip, (b) your name, (c) your address, (d) a description of the problem, and (e) the serial number of the product.
- Take or ship the product, freight prepaid, in the original container to an authorized ViewSonic® service center or ViewSonic®.
- For additional information or the name of the nearest ViewSonic® service center, contact ViewSonic®.

Limitation of implied warranties:

There are no warranties, express or implied, which extend beyond the description contained herein including the implied warranty of merchantability and fitness for a particular purpose.

Exclusion of damages:

ViewSonic's liability is limited to the cost of repair or replacement of the product. ViewSonic® shall not be liable for:

- Damage to other property caused by any defects in the product, damages based upon inconvenience, loss of use of the product, loss of time, loss of profits, loss of business opportunity, loss of goodwill, interference with business relationships, or other commercial loss, even if advised of the possibility of such damages.
- Any other damages, whether incidental, consequential or otherwise.
- Any claim against the customer by any other party.
- Repair or attempted repair by anyone not authorized by ViewSonic®.

Effect of state law:

This warranty gives you specific legal rights, and you may also have other rights which vary from state to state. Some states do not allow limitations on implied warranties and/or do not allow the exclusion of incidental or consequential damages, so the above limitations and exclusions may not apply to you.

Sales outside the U.S.A. and Canada:

For warranty information and service on ViewSonic® products sold outside of the U.S.A. and Canada, contact ViewSonic® or your local ViewSonic® dealer.

The warranty period for this product in mainland China (Hong Kong, Macao, and Taiwan Excluded) is subject to the terms and conditions of the Maintenance Guarantee Card.

For users in Europe and Russia, full details of warranty provided can be found at: <http://www.viewsonic.com/eu/> under "Support/Warranty Information".

Mexico Limited Warranty

ViewSonic® Display

What the warranty covers:

ViewSonic® warrants its products to be free from defects in material and workmanship, under normal use, during the warranty period. If a product proves to be defective in material or workmanship during the warranty period, ViewSonic® will, at its sole option, repair or replace the product with a like product. Replacement product or parts may include remanufactured or refurbished parts or components & accessories.

How long the warranty is effective:

ViewSonic® LCD displays are warranted for between 1 and 3 years, depending on your country of purchase, for all parts including the light source and for all labour from the date of the first consumer purchase.

Who the warranty protects:

This warranty is valid only for the first consumer purchaser.

What the warranty excludes and does not cover:

- Any product on which the serial number has been defaced, modified or removed.
- Damage, deterioration, or malfunction resulting from:
 - » Accident, misuse, neglect, fire, water, lightning, or other acts of nature, unauthorized product modification, unauthorized attempted repair, or failure to follow instructions supplied with the product.
 - » Causes external to the product, such as electrical power fluctuations or failure.
 - » Use of supplies or parts not meeting ViewSonic®'s specifications.
 - » Normal wear and tear.
 - » Any other cause which does not relate to a product defect.
- Any product exhibiting a condition commonly known as “image burn-in” which results when a static image is displayed on the product for an extended period of time.
- Removal, installation, insurance, and set-up service charges.

How to get service:

For information about receiving service under warranty, contact ViewSonic® Customer Support (Please refer to the attached “Customer Service” page). You will need to provide your product’s serial number, so please record the product information in the space provided below on your purchase for your future use. Please retain your receipt of proof of purchase to support your warranty claim.

For Your Records

Product Name: _____ Model Number: _____

Document Number: _____ Serial Number: _____

Purchase Date: _____ Extended Warranty Purchase? _____ (Y/N)

If so, what date does warranty expire? _____

- To obtain warranty service, you will be required to provide (a) the original dated sales slip, (b) your name, (c) your address, (d) a description of the problem, and (e) the serial number of the product.
- Take or ship the product, in the original container packaging, to an authorized ViewSonic® service center.
- Round trip transportation costs for in-warranty products will be paid by ViewSonic®.

Limitation of implied warranties:

There are no warranties, express or implied, which extend beyond the description contained herein including the implied warranty of merchantability and fitness for a particular purpose.

Exclusion of damages:

ViewSonic®’s liability is limited to the cost of repair or replacement of the product.

ViewSonic® shall not be liable for:

- Damage to other property caused by any defects in the product, damages based upon inconvenience, loss of use of the product, loss of time, loss of profits, loss of business opportunity, loss of goodwill, interference with business relationships, or other commercial loss, even if advised of the possibility of such damages.
- Any other damages, whether incidental, consequential or otherwise.
- Any claim against the customer by any other party.
- Repair or attempted repair by anyone not authorized by ViewSonic®.

Contact Information for Sales & Authorized Service (Centro Autorizado de Servicio) within Mexico:	
Name, address, of manufacturer and importers: México, Av. de la Palma #8 Piso 2 Despacho 203, Corporativo Interpalmas, Col. San Fernando Huixquilucan, Estado de México Tel: (55) 3605-1099 http://www.viewsonic.com/la/soporte/index.htm	
NÚMERO GRATIS DE ASISTENCIA TÉCNICA PARA TODO MÉXICO: 001.866.823.2004	
Hermosillo: Distribuciones y Servicios Computacionales SA de CV. Calle Juárez 284 local 2 Col. Bugambilias C.P: 83140 Tel: 01-66-22-14-9005 E-Mail: disc2@hmo.megared.net.mx	Villahermosa: Compumantenimientos Garantizados, S.A. de C.V. AV. GREGORIO MENDEZ #1504 COL, FLORIDA C.P. 86040 Tel: 01 (993) 3 52 00 47 / 3522074 / 3 52 20 09 E-Mail: compumantenimientos@prodigy.net.mx
Puebla, Pue. (Matriz): RENTA Y DATOS, S.A. DE C.V. Domicilio: 29 SUR 721 COL. LA PAZ 72160 PUEBLA, PUE. Tel: 01(52).222.891.55.77 CON 10 LINEAS E-Mail: datos@puebla.megared.net.mx	Veracruz, Ver.: CONEXION Y DESARROLLO, S.A DE C.V. Av. Americas # 419 ENTRE PINZÓN Y ALVARADO Fracc. Reforma C.P. 91919 Tel: 01-22-91-00-31-67 E-Mail: gacosta@qplus.com.mx
Chihuahua: Soluciones Globales en Computación C. Magisterio # 3321 Col. Magisterial Chihuahua, Chih. Tel: 4136954 E-Mail: Cefeo@soluglobales.com	Cuernavaca: Compusupport de Cuernavaca SA de CV Francisco Leyva # 178 Col. Miguel Hidalgo C.P. 62040, Cuernavaca Morelos Tel: 01 777 3180579 / 01 777 3124014 E-Mail: aquevedo@compusupportcva.com
Distrito Federal: QPLUS, S.A. de C.V. Av. Coyoacán 931 Col. Del Valle 03100, México, D.F. Tel: 01(52)55-50-00-27-35 E-Mail : gacosta@qplus.com.mx	Guadalajara, Jal.: SERVICRECE, S.A. de C.V. Av. Niños Héroes # 2281 Col. Arcos Sur, Sector Juárez 44170, Guadalajara, Jalisco Tel: 01(52)33-36-15-15-43 E-Mail: mmiranda@servicrece.com
Guerrero Acapulco: GS Computación (Grupo Sesicomp) Progreso #6-A, Colo Centro 39300 Acapulco, Guerrero Tel: 744-48-32627	Monterrey: Global Product Services Mar Caribe # 1987, Esquina con Golfo Pérsico Fracc. Bernardo Reyes, CP 64280 Monterrey N.L. México Tel: 8129-5103 E-Mail: aydeem@gps1.com.mx
MERIDA: ELECTROSER Av Reforma No. 403Gx39 y 41 Mérida, Yucatán, México CP97000 Tel: (52) 999-925-1916 E-Mail: rrrb@sureste.com	Oaxaca, Oax.: CENTRO DE DISTRIBUCION Y SERVICIO, S.A. de C.V. Murguía # 708 P.A., Col. Centro, 68000, Oaxaca Tel: 01(52)95-15-15-22-22 Fax: 01(52)95-15-13-67-00 E-Mail: gpotai2001@hotmail.com
Tijuana: STD Av Ferrocarril Sonora #3780 L-C Col 20 de Noviembre Tijuana, Mexico	FOR USA SUPPORT: ViewSonic® Corporation 10 Pointe Drive 2nd Floor, Brea, CA 92821 USA Tel: 800-688-6688 E-Mail: http://www.viewsonic.com



ViewSonic®