

# User's Guide

Dell C5517H

Model No.: C5517H

Regulatory model: C5517Hc



# Notes, cautions, and warnings



**NOTE:** A NOTE indicates important information that helps you make better use of your computer.



**CAUTION:** A CAUTION indicates potential damage to hardware or loss of data if instructions are not followed.



**WARNING:** A WARNING indicates a potential for property damage, personal injury or death.

---

**Information in this document is subject to change without notice.**

**© 2016 Dell Inc. All rights reserved.**

Reproduction of these materials in any manner whatsoever without the written permission of Dell Inc. is strictly forbidden.

Trademarks used in this text: *Dell* and the *DELL* logo are trademarks of Dell Inc.; *Microsoft* and *Windows* are either trademarks or registered trademarks of Microsoft Corporation in the United States and/or other countries; *Intel* is a registered trademark of Intel Corporation in the U.S. and other countries; and *ATI* is a trademark of Advanced Micro Devices, Inc.

Other trademarks and trade names may be used in this document to refer to either the entities claiming the marks and names or their products. Dell Inc. disclaims any proprietary interest in trademarks and trade names other than its own.

# Contents

<b>About Your Monitor</b> .....	<b>5</b>
Package Contents .....	5
Product Features .....	6
Remote Control .....	7
Identifying Parts and Controls .....	10
Monitor Specifications .....	13
Plug and Play Capability .....	21
LCD Monitor Quality & Pixel Policy .....	26
Maintenance Guidelines .....	26
<b>Setting Up the Monitor</b> .....	<b>27</b>
Attaching the Monitor .....	27
Connecting Your Monitor .....	28
Removing the Monitor Stand .....	30
Wall Mounting (Optional) .....	31
<b>Operating the Monitor</b> .....	<b>32</b>
Power On the Monitor .....	32
Using the Function Controls .....	32
Using the On-Screen Display (OSD) Menu .....	34
OSD Warning Messages .....	44
Setting the Maximum Resolution .....	47
<b>Troubleshooting</b> .....	<b>48</b>
Self-Test .....	48
Built-in Diagnostics .....	50

Product-Specific Problems . . . . .	55
<b>Appendix . . . . .</b>	<b>56</b>
FCC Notices (U.S. Only) and Other Regulatory Information . . . . .	56
Contact Dell . . . . .	56
<b>Setting Up Your Monitor . . . . .</b>	<b>57</b>
Setting the display resolution to 1920 x 1080 (Maximum)	57
If you have a Dell desktop or a Dell portable computer with Internet access . . . . .	58
If you have a non Dell desktop, portable computer, or graphics card . . . . .	58
Procedures for setting up dual monitors in Windows 7, Windows 8/Windows 8.1 or Windows 10. . . . .	59
<b>Dell Display Manager User's Guide . . . . .</b>	<b>74</b>
Overview . . . . .	74
Using the Quick Settings Dialog . . . . .	74
Setting Basic Display Functions . . . . .	75
Assigning Preset Modes to Applications . . . . .	77
Organizing Windows with Easy Arrange . . . . .	78









# About Your Monitor

## Package Contents

Your monitor ships with all the components shown below. Ensure that you have received all the components and [Contact Dell](#) if anything is missing.

 **NOTE:** Some items may be optional and may not ship with your monitor. Some features or media may not be available in certain countries.

	<ul style="list-style-type: none"><li>• Monitor</li></ul>
	<ul style="list-style-type: none"><li>• Monitor Base</li></ul>
	<ul style="list-style-type: none"><li>• Screws: M4 (12 mm) x 4</li></ul>
	<ul style="list-style-type: none"><li>• Remote Control &amp; Batteries (AAA x 2)</li></ul>
	<ul style="list-style-type: none"><li>• Power Cable (varies by countries)</li></ul>
	<ul style="list-style-type: none"><li>• VGA Cable (3 m)</li></ul>
	<ul style="list-style-type: none"><li>• HDMI Cable (3 m)</li></ul>
	<ul style="list-style-type: none"><li>• DP to DP Cable (3 m)</li></ul>

	<ul style="list-style-type: none"> <li>• USB Upstream Cable (enable the USB ports on the monitor) (3m)</li> </ul>
	<ul style="list-style-type: none"> <li>• Cable clips: 3 pcs</li> </ul>
	<ul style="list-style-type: none"> <li>• Drivers and Documentation media</li> <li>• Quick Setup Guide</li> <li>• Safety, Environment, and Regulatory Information (SERI)</li> </ul>

## Product Features

The **Dell C5517H** flat-panel display has an active matrix, Thin-Film Transistor, Liquid Crystal Display. The monitor's features include:

- **C5517H:** 1386.84 mm (54.6 inches) diagonal viewable image size, 1920 x 1080 resolution, plus full-screen support for lower resolutions.
- LED backlight.
- Removable pedestal and Video Electronics Standards Association (VESA) 400 mm x 400 mm mounting holes for flexible mounting solutions.
- Plug and play capability if supported by your system.
- VGA, HDMI and DP connectivity make it simple and easy to connect with legacy and new system.
- Audio out
- On-Screen Display (OSD) adjustments for ease of set-up and screen optimization.
- Software and documentation media which includes an information file (INF), Image Color Matching File (ICM), and product documentation.
- Dell Display Manager Software (comes in the CD shipped with the monitor).
- Asset Management Capability.
- Build-in Speaker (10W)x2
- RoHS compliant.
- BFR/PVC Free (Halogen-Free) monitor excluding external cables.
- Arsenic-Free glass and Mercury-Free for panel only.

## Remote Control



### ① Power On/Off

Switch this monitor on or off.

### ② Input Source

Select input source. Press [**<**] or [**>**] button to select from **HDMI1**, **HDMI2**, **VGA** or **DP**. Press [**✓**] button to confirm and exit.

### ③ Up

Press to move the selection up in OSD menu.

### ④ Left

Press to move the selection left in OSD menu.

### ⑤ Down

Press to move the selection down in OSD menu.

### ⑥ Menu

Press to turn on the OSD menu.

### ⑦ Brightness -

Press to decrease the Brightness.

### ⑧ Volume -

Press to decrease the Volume.

### ⑨ MUTE

Press to turn the mute function on/off.

### ⑩ Preset Modes

Display information about Preset Modes.

### ⑪ Right

Press to move the selection right in OSD menu.

### ⑫ OK

Confirm an entry or selection.

### ⑬ Exit

Press to exit the Menu.

### ⑭ Brightness +

Press to increase the Brightness.

### ⑮ Volume +

Press to increase the Volume.

## Inserting the batteries in the remote control

The remote control is powered by two 1.5V AAA batteries.

To install or replace batteries:

1. Press and then slide the cover to open it.
2. Align the batteries according to the (+) and (-) indications inside the battery compartment.
3. Replace the cover.

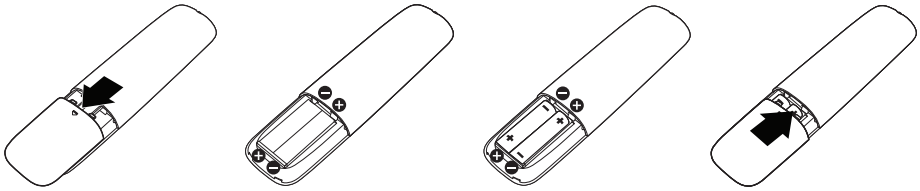

### CAUTION:

The incorrect use of batteries can result in leaks or bursting. Be sure to follow these instructions:

- Place “AAA” batteries matching the (+) and (-) signs on each battery to the (+) and (-) signs of the battery compartment.
- Do not mix battery types.
- Do not combine new batteries with used ones. It causes shorter life or leakage of batteries.
- Remove the dead batteries immediately to prevent them from liquid leaking in the battery compartment. Don't touch exposed battery acid, as it can damage your skin.

 **NOTE:** If you do not intend to use the remote control for a long period, remove the batteries.

## Handling the remote control

- Do not subject to strong shock.
- Do not allow water or other liquid to splash the remote control. If the remote control gets wet, wipe it dry immediately.
- Avoid exposure to heat and steam.
- Other than to install the batteries, do not open the remote control.

## Operating range of the remote control

Point the top of the remote control toward the LCD monitor's remote sensor during button operation.

Use the remote control within a distance of about 8 m from remote control sensor or at a horizontal and vertical angle of within  $15^\circ$  within a distance of about 5.6 m.

**NOTE:** The remote control may not function properly when the remote control sensor on the display is under direct sunlight or strong illumination, or when there is an obstacle in the path of signal transmission.



# Identifying Parts and Controls

## Front View



1	IR Lens (with LED indicator)
---	------------------------------

## Back View

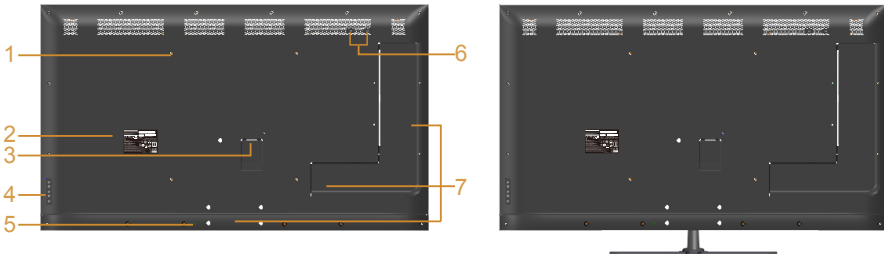

Back View with monitor stand

Label	Description	Use
1	VESA mounting holes (400 mm x 400 mm)	Wall mount monitor using VESA-compatible wall mount kit (400 mm x 400 mm).
2	Regulatory label	Lists the regulatory approvals.
3	AC power connector	To connect the monitor power cable.
4	Function buttons (For more information, see <a href="#">Operating the Monitor</a> )	Use the keys on the back of the monitor to adjust the image settings.
5	Security lock slot	Secures monitor with security lock.

6	Screw Hole	For accessory mounting.
7	Cable clips position	Sticking cable clips on these positions to organize the cables.

## Side View

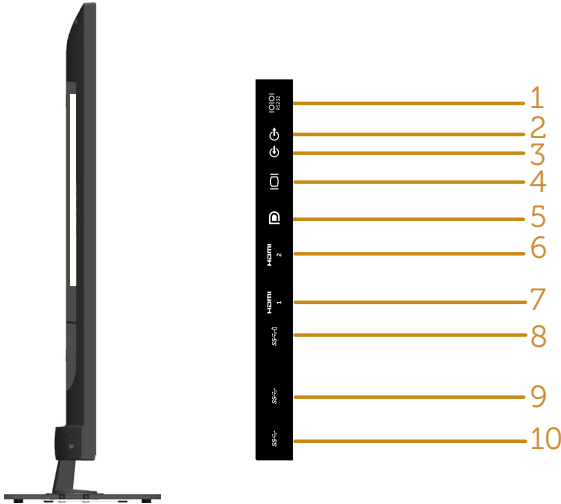

Label	Description	Use
1	RS232 port	To connect your computer to the monitor using a RS232 cable.
2	Audio Line Out Port	Connect speakers to playback audio coming through VGA or HDMI or DP audio channels. Only supports 2-channel audio. <b>NOTE:</b> The audio line-out port does not support headphones.
3	Audio Line In Port	Connect the audio cable (optional purchase) from the source device to the monitor.
4	VGA port	To connect your computer to the monitor using a VGA cable.
5	DisplayPort	To connect your computer to the monitor using a DP to DP cable.

6	HDMI 2 port connector	To connect your computer to the monitor using HDMI cable
7	HDMI 1 port connector	
8	USB downstream port	Connect your USB device. You can only use this connector after you have connected the USB cable to the computer and USB upstream connector on the monitor.*
9	USB downstream port	Connect your USB device. You can only use this connector after you have connected the USB cable to the computer and USB upstream connector on the monitor.
10	USB upstream port	Connect the USB cable that comes with your monitor to the computer. Once this cable is connected, you can use the USB connectors on the monitor.

\* Supports battery charging. 

### Bottom View

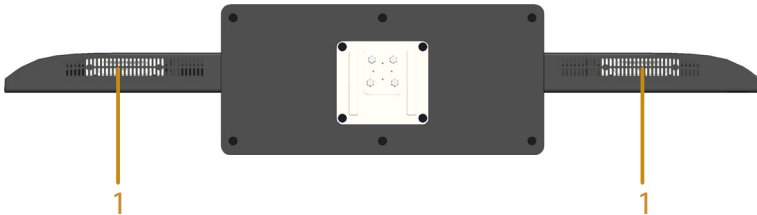

1	Speakers
---	----------



## Monitor Specifications

The following sections give you information about the various power management modes and pin assignments for the various connectors of your monitor.

### Power Management Modes

If you have VESA's DPM compliance display card or software installed in your PC, the monitor automatically reduces its power consumption when not in use. This is referred to as Power Save Mode. If the computer detects input from keyboard, mouse, or other input devices, the monitor automatically resumes functioning. The following table shows the power consumption and signaling of this automatic power saving feature:

VESA Modes	Horizontal Sync	Vertical Sync	Video	Power Indicator	Power Consumption
Normal operation	Active	Active	Active	White	170 W (Maximum)** 80 W (Typical)***
Active-off mode	Inactive	Inactive	Blank	Glowing white	Less than 0.3 W
Switch off	-	-		Off	Less than 0.3 W*

\* Zero-power consumption in OFF mode can only be achieved by disconnecting the main cable from the monitor.

\*\* Maximum power consumption with max luminance and contrast.

\*\*\* Typical power consumption with OSD default setting, audio and USB inactive.

The OSD will only function in the normal operation mode. When any button except power button is pressed in Active-off mode, the following messages will be displayed:

#### Dell C5517H

There is no signal coming from your computer. Press any key on the keyboard or move the mouse to wake it up. If there is no display, press the monitor button now to select the correct input source on the On-Screen-Display menu.



Activate the computer and monitor to gain access to the [Using the On-Screen Display \(OSD\) Menu](#).

### Pin Assignments

#### 15-pin D-Sub connector

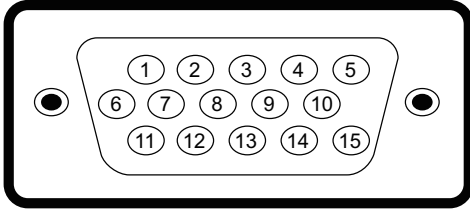

Pin Number	Monitor Side of the 15-pin Side Signal Cable
1	Video-Red
2	Video-Green
3	Video-Blue
4	GND
5	Self-test
6	GND-R
7	GND-G
8	GND-B
9	DDC +5 V
10	GND-sync
11	GND
12	DDC data
13	H-sync
14	V-sync
15	DDC clock

## 19-pin HDMI connector

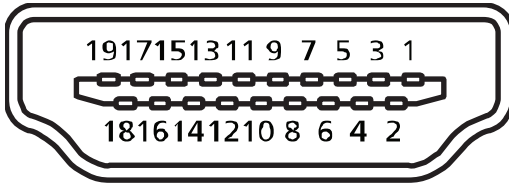

Pin Number	Monitor Side of the 19-pin Side Signal Cable
1	TMDS Data2+
2	TMDS Data2 Shield
3	TMDS Data2-
4	TMDS Data1+
5	TMDS Data1 Shield
6	TMDS Data1-
7	TMDS Data0+
8	TMDS Data0 Shield
9	TMDS Data0-
10	TMDS Clock+
11	TMDS Clock Shield
12	TMDS Clock-
13	CEC
14	Reserved (N.C. on device)
15	SCL
16	SDA
17	DDC/CEC Ground
18	+5V Power
19	Hot Plug Detect

## DP connector

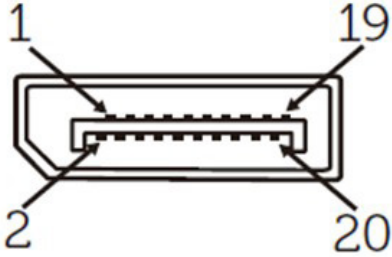

Pin Number	20-pin Side of the Connected Signal Cable
1	ML0 (p)
2	GND
3	ML0 (n)
4	ML1 (p)
5	GND
6	ML1 (n)
7	ML2 (p)
8	GND
9	ML2 (n)
10	ML3 (p)
11	GND
12	ML3 (n)
13	GND
14	GND
15	AUX (p)
16	GND
17	AUX (n)
18	GND
19	Re-PWR
20	+3.3 V DP_PWR

## Universal Serial Bus (USB) Interface

This section gives you information about the USB ports that are available on the monitor.

**NOTE:** This monitor is Super-Speed USB 3.0 compatible.

Transfer Speed	Data Rate	Power Consumption*
2 Super-speed	5 Gbps	4.5 W (Max, each port)
High speed	480 Mbps	4.5 W (Max, each port)
Full speed	12 Mbps	4.5 W (Max, each port)

\* Up to 2.5A on USB downstream port (port with  battery icon) with BC1.2 compliance devices or normal USB devices.

### USB Upstream Connector

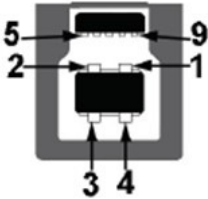

Pin Number	9-pin Side of the Connector
1	VCC
2	D-
3	D+
4	GND
5	SSTX-
6	SSTX+
7	GND
8	SSRX-
9	SSRX+

## USB Downstream Connector



Pin Number	9-pin Side of the Connector
1	VCC
2	D-
3	D+
4	GND
5	SSTX-
6	SSTX+
7	GND
8	SSRX-
9	SSRX+

## USB Ports

- 1 upstream - blue
- 3 downstream - blue
- Power Charging Port - the port with  battery icon; supports current charging capability if the device is BC1.2 compatible.

 **NOTE:** USB 3.0 functionality requires a USB 3.0-capable computer

 **NOTE:** The monitor's USB interface works only when the monitor is on or in the power save mode. If you turn off the monitor and then turn it on, the attached peripherals may take a few seconds to resume normal functionality.

## RS232 connector

RS232 Monitor Pin Assignment (Facing Monitor)

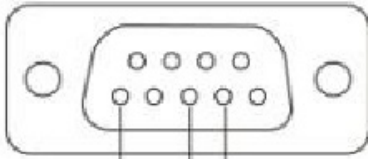

Male      GND TXRX

RS232 Serial Communication Cable Pin Assignment (Facing Cable)

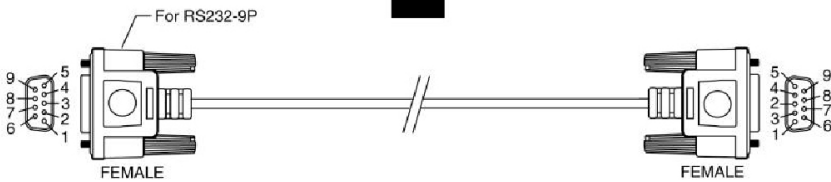

Pin Assignments

RS232	PIN DESCRIPTION	RS232
1		
2	TXD	2
3	RXD	3
4		
5	GROUND	5
6		
7	Not Used	7
8	Not Used	8
9		

## RS232 Protocol Communication Settings

<b>Connection Settings</b>	<b>Value</b>
Baud Rate	9600 bps
Data Bits	8 bits
Parity	None
Stop Bits	1 bit
Flow control	None



## Plug and Play Capability

You can install the monitor in any Plug and Play compatible system. The monitor automatically provides the computer with its Extended Display Identification Data (EDID) using Display Data Channel (DDC) protocols so that the system can configure itself and optimize the monitor settings. Most monitor installations are automatic. You can select different settings if required.

## Flat-Panel Specifications

<b>Model number</b>	<b>Dell C5517H monitor</b>
Screen type	Active matrix - TFT LCD
Panel type	Vertical Alignment
Viewable image	
Diagonal	1386.8 mm (54.6 inches)
Horizontal, Active Area	1209.6 mm (47.6 inches)
Vertical, Active Area	680.4 mm (26.8 inches)
Area	823011.8 mm <sup>2</sup> (1275.7 inch <sup>2</sup> )
Pixel pitch (Sub pixel)	0.21 mm (W) * 0.63 mm (H)
Viewing angle:	
Horizontal	178° typical
Vertical	178° typical
Luminance output	350 cd/m <sup>2</sup> (typical)
Contrast ratio	3000 : 1 (typical)
Faceplate coating	Antiglare with hard-coating 3H, 2% Haze
Backlight	LED light bar system
Response time	8ms Typical (G to G)
Color depth	16.7 mil colors
Color gamut	85 % (typical) **

\*\* [C5517H] color gamut (typical) is based on CIE1976 (85 %) and CIE1931 (72 %) test standards.

## Resolution Specifications

<b>Model number</b>	<b>Dell C5517H monitor</b>
Horizontal Scan range	30 kHz to 83 kHz (automatic)
Vertical Scan range	56 Hz to 76 Hz (automatic)
Maximum preset resolution	1920 x 1080 at 60 Hz

## Support Video Mode

<b>Model number</b>	<b>Dell C5517H monitor</b>
Video display capability (HDMI&DP playback)	480p, 576p, 720p, 1080p, 1080i

## Electrical Specifications

<b>Model number</b>	<b>Dell C5517H monitor</b>
Video input signals	Analog RGB: 0.7 Volts +/- 5 %, 75 ohm input impedance Digital HDMI: 600 mV for each differential line, 100 ohm input impedance Digital DisplayPort Maximum Output differential Voltage Level 1.38V, 100ohm input impedance
Synchronization input signals	Separate horizontal and vertical synchronizations, polarity-free TTL level, SOG (Composite SYNC on green)
AC input voltage / frequency / current	100 VAC to 240 VAC/50 Hz or 60 Hz +/- 3 Hz/2.5 A (Max.)
Inrush current	120 V: 30 A (Max.) 240 V: 60 A (Max.)

## Preset Display Modes

The following table lists the preset modes for which Dell guarantees image size and centering:

Display Mode	Horizontal Frequency (kHz)	Vertical Frequency (Hz)	Pixel Clock (MHz)	Sync Polarity (Horizontal/Vertical)
VESA, 720 x 400	31.5	70.0	28.3	-/+
VESA, 640 x 480	31.5	60.0	25.2	-/-
VESA, 640 x 480	37.5	75.0	31.5	-/-
VESA, 800 x 600	37.9	60.3	40.0	+/+
VESA, 800 x 600	46.9	75.0	49.5	+/+
VESA, 1024 x 768	48.4	60.0	65.0	-/-
VESA, 1024 x 768	60.0	75.0	78.8	+/+
VESA, 1152 x 864	67.5	75.0	108.0	+/+
VESA, 1280 x 1024	64.0	60.0	108.0	+/+
VESA, 1280 x 1024	80.0	75.0	135.0	+/+
VESA, 1600 x 900	55.5	60.0	97.8	+/-
VESA, 1920 x 1080	67.5	60.0	148.5	+/+

## Physical Characteristics

The following table lists the monitor's physical characteristics:

<b>Model Number</b>	<b>Dell C5517H monitor</b>
<b>Connector type</b>	D-subminiature, black connector HDMI, black connector DP, black connector
<b>Signal cable type</b>	D-sub: Detachable, Analog, 15-pin HDMI: Detachable, Digital, 19-pin DP: Detachable Digital, 20-pins
<b>Dimensions: (with stand)</b>	
Height	788.6 mm (31.1 inches)
Width	1241.0 mm (48.9 inches)
Depth	245.0 mm (9.7 inches)
<b>Dimensions: (without stand)</b>	
Height	721.5 mm (28.4 inches)
Width	1241.0 mm (48.9 inches)
Depth	64.8 mm (2.6 inches)
<b>Stand dimensions</b>	
Height	154.9 mm (6.1 inches)
Width	530.0 mm (20.9 inches)
Depth	245.0 mm (9.6 inches)
<b>Weight</b>	
Weight with packaging	32.2 kg (70.8 lb)
Weight with stand assembly and cables	24.6 kg (54.1 lb)
Weight without stand assembly (For wall mount or VESA mount considerations - no cables)	20.4 kg (44.9 lb)
Weight of stand assembly	3.3 kg (7.3 lb)

## Environmental Characteristics

The following table lists the environmental conditions for your monitor:

<b>Model Number</b>	<b>Dell C5517H monitor</b>
<b>Temperature</b>	
Operating	0 °C to 40 °C (32 °F to 104 °F)
Non-operating	<ul style="list-style-type: none"><li>• Storage: -20 °C to 60 °C (-4 °F to 140 °F)</li><li>• Shipping: -20 °C to 60 °C (-4 °F to 140 °F)</li></ul>
<b>Humidity</b>	
Operating	20 % to 80 % (non-condensing)
Non-operating	<ul style="list-style-type: none"><li>• Storage: 10 % to 90 % (non-condensing)</li><li>• Shipping: 10 % to 90 % (non-condensing)</li></ul>
<b>Altitude</b>	
Operating	5,000 m (16,387 ft) max
Non-operating	12,191 m (40,000 ft) max
<b>Thermal dissipation</b>	
Maximum	<ul style="list-style-type: none"><li>• 410 BTU/hour</li></ul>
Typical	<ul style="list-style-type: none"><li>• 273 BTU/hour</li></ul>

## LCD Monitor Quality & Pixel Policy

During the LCD Monitor manufacturing process, it is not uncommon for one or more pixels to become fixed in an unchanging state. The visible result is a fixed pixel that appears as an extremely tiny dark or bright discolored spot. When the pixel remains permanently lit, it is known as a “bright dot.” When the pixel remains black, it is known as a “dark dot.”

In almost every case, these fixed pixels are hard to see and do not detract from display quality or usability. A display with 1 to 5 fixed pixels is considered normal and within competitive standards. For more information, see Dell Support site at:

<http://www.dell.com/support/monitors>.

## Maintenance Guidelines

### Caring for Your Monitor

 **CAUTION: Read and follow the safety instructions before cleaning the monitor.**

 **CAUTION: Before cleaning the monitor, unplug the monitor power cable from the electrical outlet.**

For best practices, follow the instructions in the list below while unpacking, cleaning, or handling your monitor:

- To clean your antistatic screen, slightly dampen a soft, clean cloth with water. If possible, use a special screen-cleaning tissue or solution suitable for the antistatic coating. Do not use benzene, thinner, ammonia, abrasive cleaners, or compressed air.
- Use a slightly dampened, warm cloth to clean the plastics. Avoid using detergent of any kind as some detergents leave a milky film on the plastics.
- If you notice a white powder when you unpack your monitor, wipe it off with a cloth. This white powder occurs during the shipping of the monitor.
- Handle your monitor with care as a darker-colored monitor may scratch and show white scuff marks more than a lighter-colored monitor.
- To help maintain the best image quality on your monitor, use a dynamically changing screen saver and power off your monitor when not in use.

# Setting Up the Monitor

## Attaching the Monitor

 **NOTE:** The base is detached when the monitor is shipped from the factory.

To attach the monitor base:

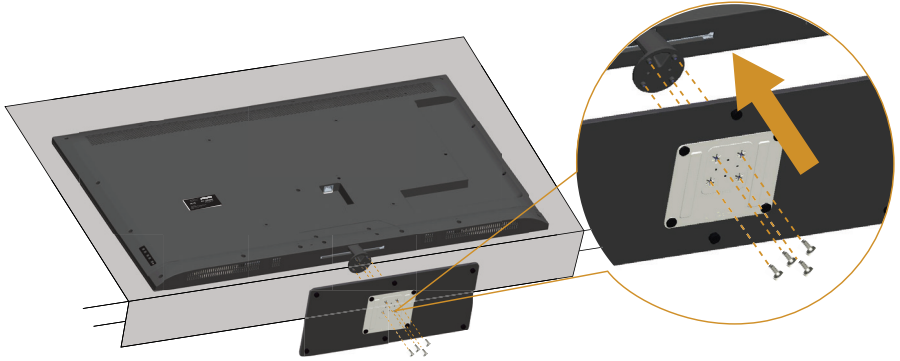

1. Place the monitor on a flat surface.
2. Insert the screws to the base.
3. Tighten the screws.

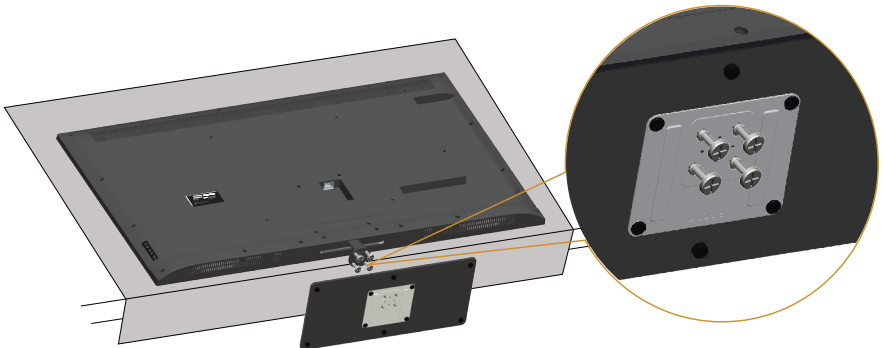

## Connecting Your Monitor

**⚠ WARNING:** Before you begin any of the procedures in this section, follow the [Safety Instructions](#).

To connect your monitor to the computer:

1. Turn off your computer and disconnect the power cable.
2. Connect either the blue analog VGA or black HDMI/DP display connector cable to the corresponding video port on the back of your computer. Do not use both cables on the same computer. Use both the cables only when they are connected to two different computers with appropriate video systems.

### Connecting the black VGA Cable

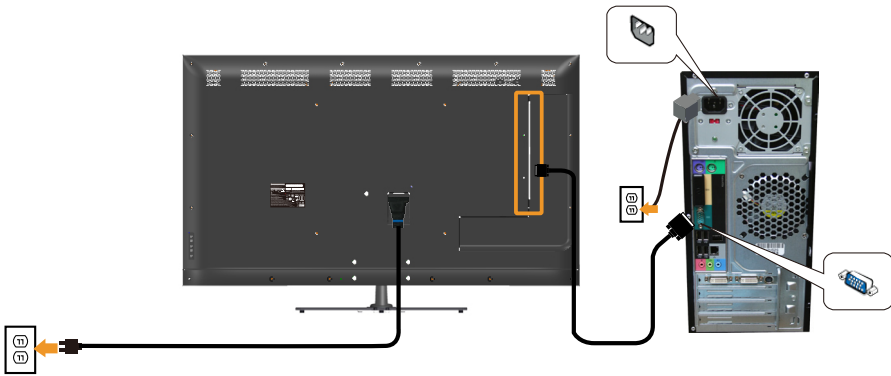

### Connecting the black HDMI Cable

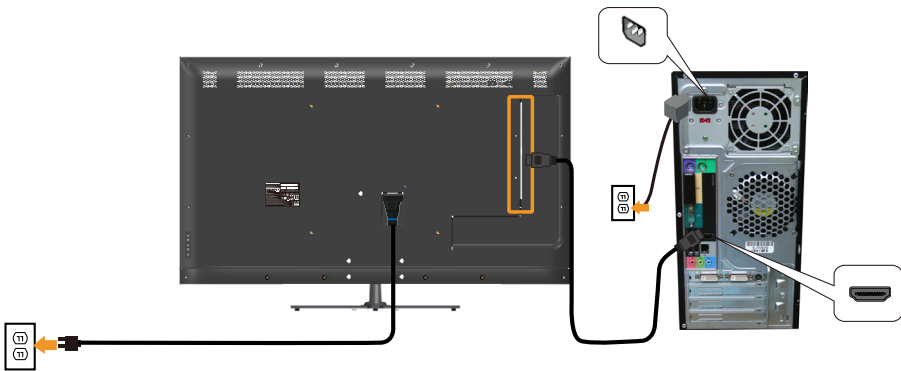



## Connecting the black DP Cable

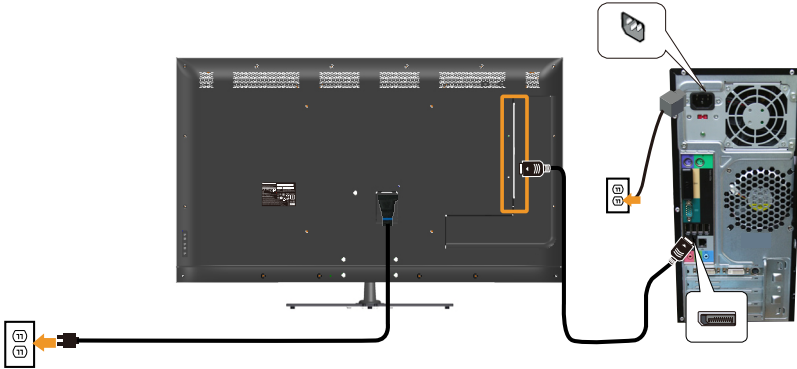

## Connecting the USB cable

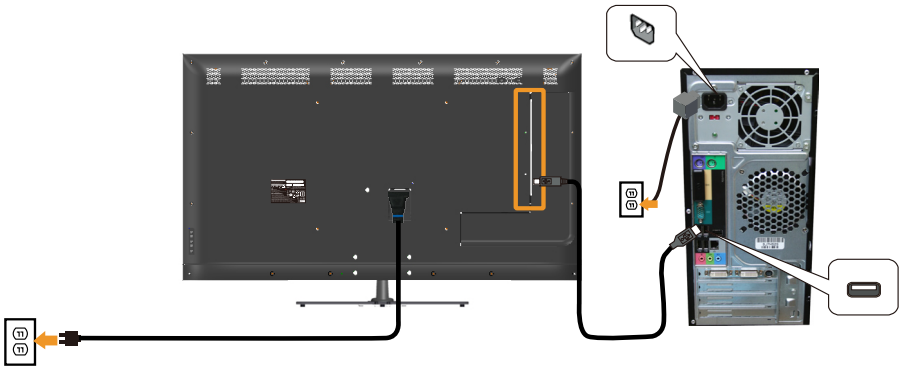

## Connecting the audio cable (Optional Purchase)

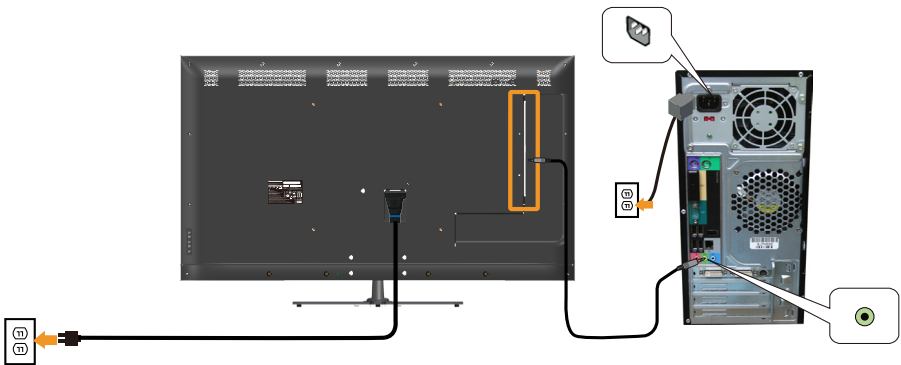

**NOTE:** The graphics are used for the purpose of illustration only. Appearance on the computer may vary.

## Removing the Monitor Stand

**NOTE:** To prevent scratches on the LCD screen while removing the stand, ensure that the monitor is placed on a soft, clean surface.

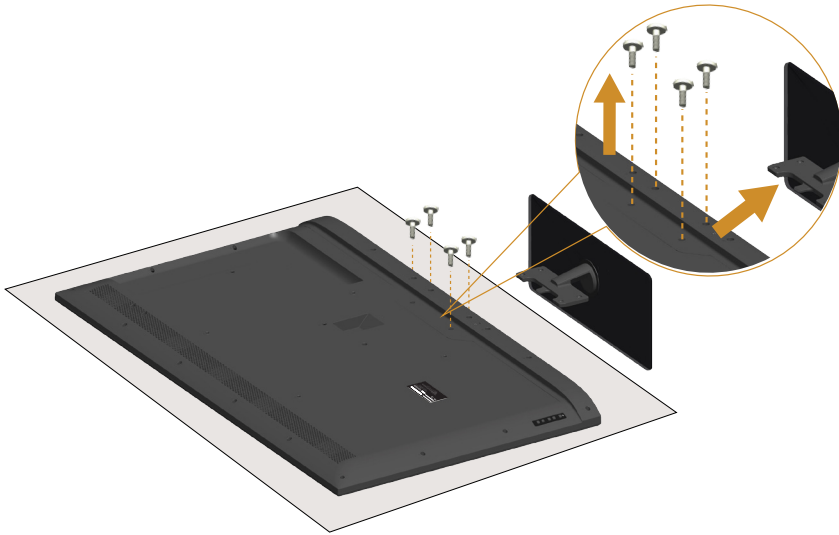

To remove the stand:

1. Place the monitor on a flat surface.
2. Release the screws located on the back cover.
3. Remove the stand from the monitor.

## Wall Mounting (Optional)

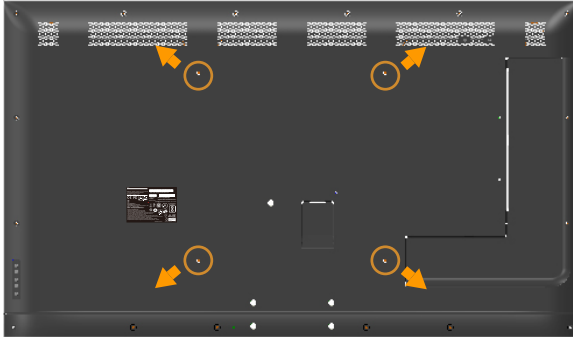

(Screw dimension: M6 x 30 mm).\*

\*Depending on your mounting solution, you may need longer than 30 mm screws.

Refer to the instructions that come with the VESA-compatible base mounting kit.

1. Place the monitor panel on a soft cloth or cushion on a stable, flat table.
2. Remove the stand.
3. Attach the mounting bracket from the wall mounting kit to the LCD.
4. Mount the LCD on the wall by following the instructions that came with the wall mounting kit.

**NOTE:** For use only with UL-listed wall mount bracket with minimum weight/load bearing capacity of 81.2 kg.

# Operating the Monitor

## Power On the Monitor

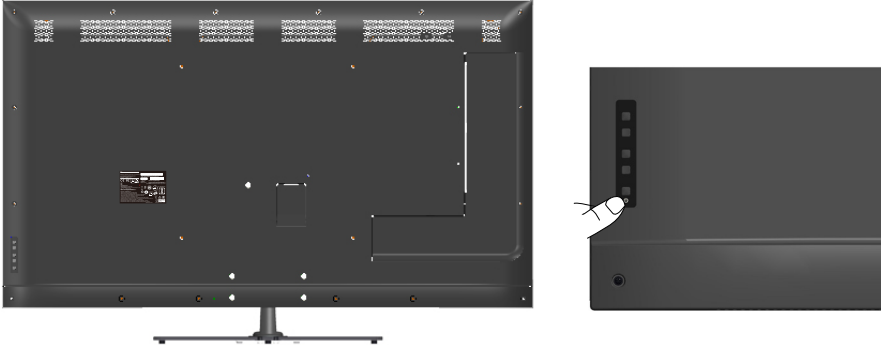

Press the  button to turn on the monitor.



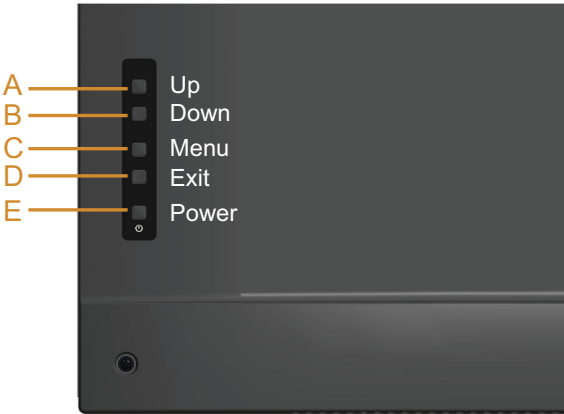

## Using the Function Controls

Use the keys on the back of the monitor to adjust the image settings.





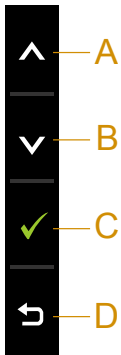

Key Pad		Description
A	 Up	Use the <b>Up</b> key to adjust (increase ranges) items in the OSD menu.
B	 Down	Use the <b>Down</b> key to adjust (decrease ranges) items in the OSD menu.

C	 Menu	Use the <b>Menu</b> key to open the on-screen display (OSD).
D	 Exit	Use the <b>Exit</b> key to exit on-screen display (OSD) from menu and sub-menus. Hold about 10 seconds will enable or disable OSD lock.
E	 Power	Press the Power button to turn on/off the monitor.

### Key Pad



Key Pad		Description
A	 Up	Use the <b>Up</b> key to adjust (increase ranges) items in the OSD menu.
B	 Down	Use the <b>Down</b> key to adjust (decrease ranges) items in the OSD menu.
C	 OK	Use the <b>OK</b> key to confirm your selection.
D	 Back	Use the <b>Back</b> key to go back to the previous menu.

# Using the On-Screen Display (OSD) Menu









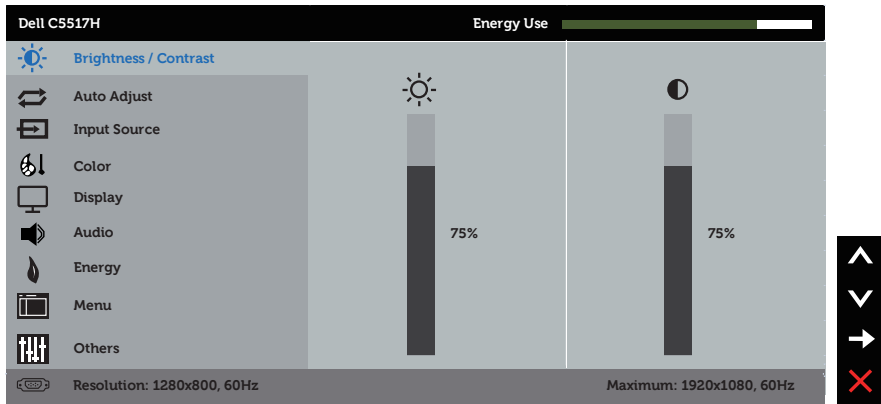

## Accessing the Menu System

**NOTE:** If you change the settings and then either proceed to another menu or exit the OSD menu, the monitor automatically saves those changes. The changes are also saved if you change the settings and then wait for the OSD menu to disappear.







1. Press the  button to open the OSD menu and display the main menu.

## Main Menu



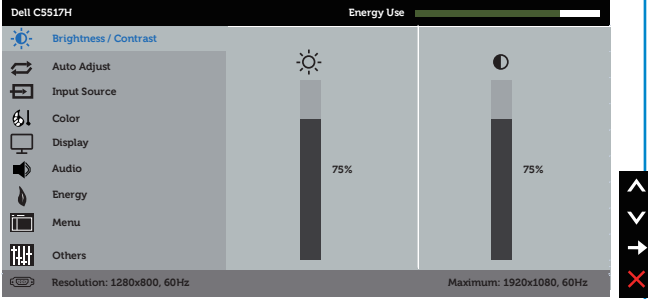

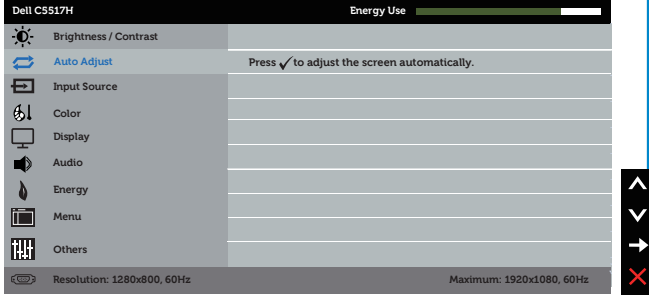

2. Press the  and  buttons to toggle between options in the Menu. As you move from one icon to another, the option name is highlighted.
3. To select the highlighted item on the menu press the  button again.
4. Press the  and  buttons to select the desired parameter.
5. Press the  button to enter the slide bar and then use the  or  buttons, according to the indicators on the menu, to make your changes.
6. Select the  to return to previous menu without accepting current settings or  to accept and return to previous menu.

The table below provides a list of all the OSD menu options and their functions.



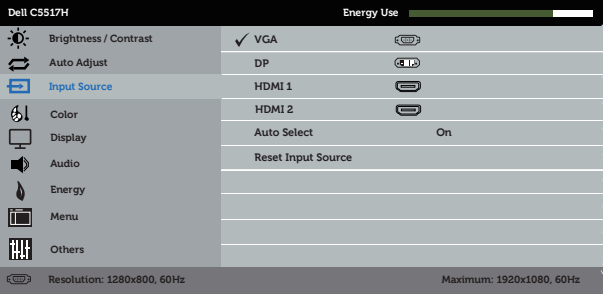



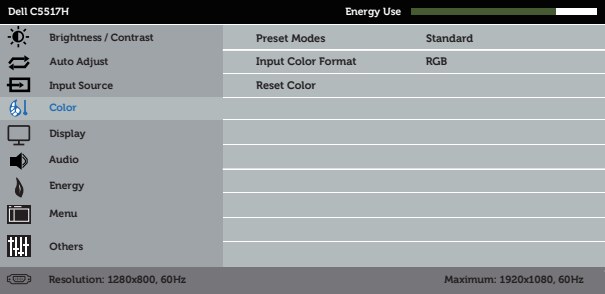

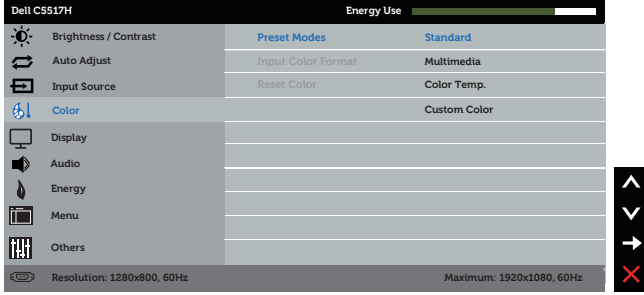

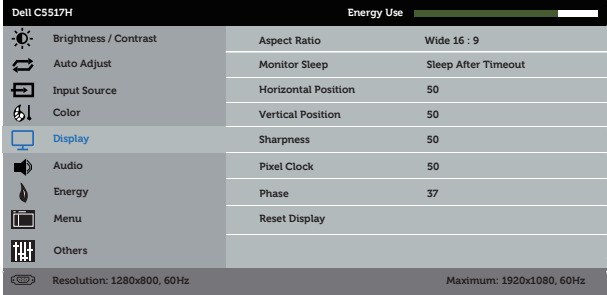
Icon	Menu and Submenus	Description
	<b>Energy Use</b>	This meter shows the energy level being consumed by the monitor in real time.
	<b>Brightness/Contrast</b>	<p>Use the <b>Brightness</b> and <b>Contrast</b> menu to adjust the Brightness/Contrast.</p> 
	<b>Brightness</b>	<p>Allows you to adjust the brightness or luminance of the backlight.</p> <p>Press the  key to increase brightness and press the  key to decrease brightness (min 0 ~ max 100).</p>
	<b>Contrast</b>	<p>Allows you to adjust the contrast or the degree of difference between darkness and lightness on the monitor screen. Adjust brightness first, and adjust contrast only if you need further adjustment.</p> <p>Press the  key to increase contrast and press the  key to decrease contrast (min 0 ~ max 100).</p>

Icon	Menu and Submenus	Description
	<b>Auto Adjust</b>	<p>Use this key to activate automatic setup and adjust menu.</p>  <p>The following dialog appears on a black screen as the monitor self-adjusts to the current input:</p> <p style="text-align: center;"><b>Auto Adjustment in Progress...</b></p> <p>Auto Adjustment allows the monitor to self-adjust to the incoming video signal. After using Auto Adjustment, you can further tune your monitor by using the Pixel Clock (Coarse) and Phase (Fine) controls under <b>Display Settings</b>.</p> <p><b>NOTE:</b> Auto Adjust does not occur if you press the button while there are no active video signals or attached cables.</p> <p>This option is only available when you are using the analog (VGA) connector.</p>











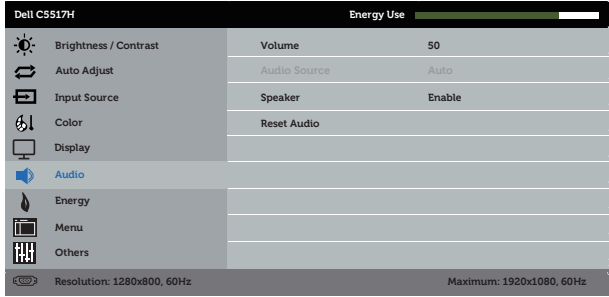

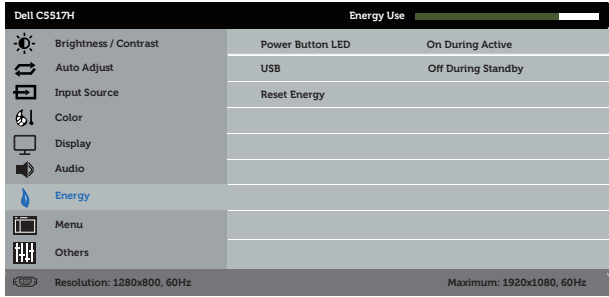

Icon	Menu and Submenus	Description
	<b>Input Source</b>	<p>Use the <b>Input Source</b> menu to select between different video signals that may be connected to your monitor.</p> 
	<b>VGA</b>	Select <b>VGA</b> input when you are using the analog (VGA) connector. Push  to select the VGA input source.
	<b>DP</b>	Select DisplayPort input when you are using the DisplayPort (DP) connector. Push  to select the DisplayPort input source.
	<b>HDMI 1</b> <b>HDMI 2</b>	Select <b>HDMI 1</b> or <b>HDMI 2</b> input when you are using the HDMI connectors. Press  to select the HDMI 1 or HDMI 2 input source.
	<b>Auto Select</b>	Select <b>Auto Select</b> to scan for available input signals.
	<b>Reset Input Source</b>	Resets your monitor's input source to the factory defaults.
	<b>Color</b>	<p>Use the <b>Color</b> menu to adjust the monitor's color settings.</p> 

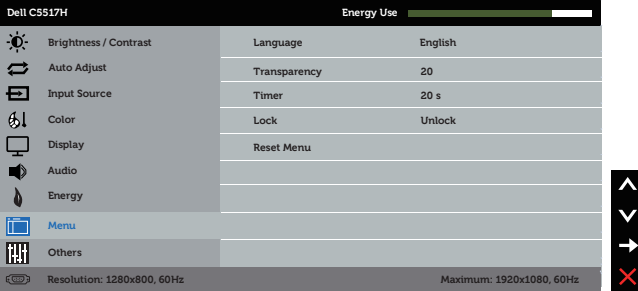
Icon	Menu and Submenus	Description
	<b>Preset Modes</b>	<p>Allows you to choose from a list of preset color modes.</p>  <ul style="list-style-type: none"> <li>• <b>Standard:</b> Loads the monitor's default color settings. This is the default preset mode.</li> <li>• <b>Multimedia:</b> Loads color settings ideal for multimedia applications.</li> <li>• <b>Color temp.:</b> Adjusts the Color temperature as 5000K, 5700K, 6500K, 7500K, 9300K, 10000K.</li> <li>• <b>Custom Color:</b> Allows you to manually adjust the color settings. Press the ▲ and ▼ keys to adjust the Red, Green, and Blue values and create your own preset color mode.</li> </ul>
	<b>Input Color Format</b>	<p>Allows you to set the video input mode to:</p> <ul style="list-style-type: none"> <li>• <b>RGB:</b> Select this option if your monitor is connected to a computer or DVD player using the HDMI cable (or DisplayPort cable).</li> <li>• <b>YPbPr:</b> Select this option if your DVD player supports only YPbPr output.</li> </ul>
	<b>Reset Color</b>	<p>Resets your monitor's color settings to the factory defaults.</p>

Icon	Menu and Submenus	Description
	<b>Display</b>	<p>Use the <b>Displays</b> menu to adjust the monitor's display settings.</p> 
	<b>Aspect Ratio</b>	<p>Adjusts the image ratio as Wide 16:9, 4:3, or 5:4.</p> <p> <b>NOTE:</b> Wide 16:9 adjustment is not required at maximum preset resolution 1920 x 1080.</p>
	<b>Monitor Sleep</b>	<p>Monitor sleep is to define the action after the source has no signal. It will go to sleep or never go to sleep.</p>
	<b>Horizontal Position</b>	<p>Use  or  the buttons to adjust image left and right. Minimum is '0' (-). Maximum is '100' (+).</p>
	<b>Vertical Position</b>	<p>Use the  or  buttons to adjust image up and down. Minimum is '0' (-). Maximum is '100' (+).</p>
	<b>Sharpness</b>	<p>This feature can make the image look sharper or softer. Use  or  to adjust the sharpness from '0' to '100'.</p>
	<b>Pixel Clock</b>	<p>The Phase and Pixel Clock adjustments allow you to adjust your monitor to your preference. Use  or  buttons to adjust for best image quality. Minimum is '0' (-). Maximum is '100' (+).</p>
	<b>Phase</b>	<p>If satisfactory results are not obtained using the Phase adjustment, use the Pixel Clock (coarse) adjustment and then use Phase (fine), again. Minimum is '0' (-). Maximum is '100' (+).</p>
	<b>Reset Display</b>	<p>Select this option to restore default display settings.</p>

 **NOTE:** Horizontal Position, Vertical Position, Pixel Clock and Phase adjustment are only available for VGA input.

Icon	Menu and Submenus	Description
	<b>Audio</b>	
	<b>Volume</b>	Use the buttons to adjust the volume. Minimum is '0' (-). Maximum is '100' (+).
	<b>Audio Source</b>	Allows you to set the Audio Source mode to: <ul style="list-style-type: none"> <li>• PC Audio</li> <li>• HDMI1 (or HDMI2 or DP)</li> </ul>
	<b>Speaker</b>	Allows you to enable or disable speaker function.
	<b>Reset Audio</b>	Select this option to restore default display settings.
	<b>Energy</b>	
	<b>Power Button LED</b>	Allows you to set the power LED indicator on or off to save energy.
	<b>USB</b>	Allows you to enable or disable USB function during monitor standby mode. <p> <b>NOTE:</b> USB ON/OFF under standby mode is only available when USB upstream cable unplugged. This option will be greyed out when USB upstream cable is plugged in.</p>
	<b>Reset Energy</b>	Select this option to restore default Energy Settings.

Icon	Menu and Submenus	Description
	<b>Menu</b>	<p>Select this option to adjust the settings of the OSD such as, the languages of the OSD, the amount of time the menu remains on screen, and so on.</p> 
	<b>Language</b>	<p>Allows you to set the OSD display to one of eight languages: English, Spanish, French, German, Portuguese (Brazil), Russian, Simplified Chinese, or Japanese.</p>
	<b>Transparency</b>	<p>Allows you to adjust the OSD background from opaque to transparent. Press  and  to make the adjustment (min 0 ~ max 100, default 20).</p>
	<b>Timer</b>	<p>Allows you to set the time for which the OSD remains active after you press a key on the monitor.</p> <p>Use the  and  keys to adjust the slider in 1 second increments, from 5 to 60 seconds.</p>
	<b>Lock</b>	<p>Controls user access to adjustments. When Lock is selected, no user adjustments are allowed. All keys are locked except  key.</p> <p> <b>NOTE:</b> When the OSD is locked, pressing the menu key takes you directly to the OSD settings menu, with 'OSD Lock' pre-selected on entry. Press and hold  key for 10 seconds to unlock and allow user access to all applicable settings.</p>
	<b>Reset Menu</b>	<p>Select this option to restore default menu settings.</p>

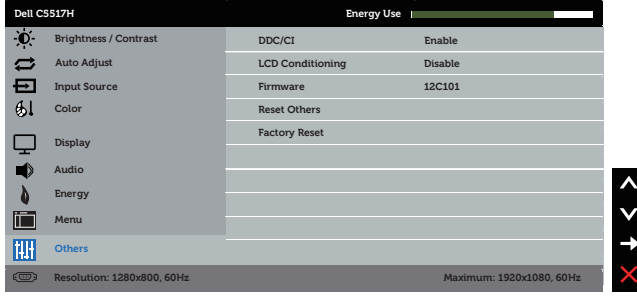
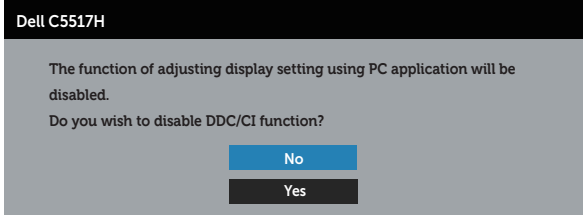
Icon	Menu and Submenus	Description
	<b>Others</b>	
	<b>DDC/CI</b>	<p>DDC/CI (Display Data Channel/Command Interface) allows a software on your computer to adjust the monitor display settings like the brightness, color balance etc.</p> <p>Enable (Default): Optimizes the performance of your monitor and provides a better customer experience.</p> <p>Disable: Disables the DDC/CI option and the following message appears on the screen.</p> 

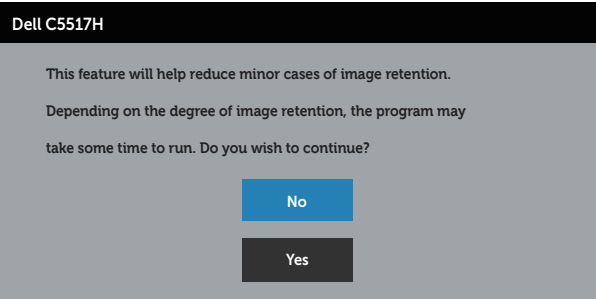
Icon	Menu and Submenus	Description
	<b>LCD Conditioning</b>	<p>This feature will help reduce minor cases of image retention.</p> <p>If an image appears to be stuck on the monitor, select <b>LCD Conditioning</b> to help eliminate any image retention. Using the LCD Conditioning feature may take some time. LCD Conditioning feature cannot remove severe cases of image retention or burn-in.</p> <p> <b>NOTE:</b> Use LCD Conditioning only when you experience a problem with image retention.</p> <p>The below warning message appears once user selects "Enable" LCD Conditioning.</p>  <p>The screenshot shows a warning dialog box with a black header "Dell C5517H". The main text reads: "This feature will help reduce minor cases of image retention. Depending on the degree of image retention, the program may take some time to run. Do you wish to continue?". There are two buttons: a blue "No" button and a black "Yes" button.</p>
	<b>Firmware</b>	Firmware version.
	<b>Reset Other Settings</b>	Select this option to restore default other settings, such as DDC/CI.
	<b>Factory Reset</b>	Resets all OSD settings to the factory preset values.

## OSD Warning Messages

When the monitor does not support a particular resolution mode you will see the following message:

### Dell C5517H

The current input timing is not supported by the monitor display.

Please change your input timing to **1920x1080, 60Hz** or any other monitor listed timing as per the monitor specifications.



This means that the monitor cannot synchronize with the signal that it is receiving from the computer. See [Monitor Specifications](#) for the horizontal and vertical frequency ranges addressable by this monitor. Recommended mode is 1920 x 1080.

You will see the following message before the DDC/CI function is disabled.

### Dell C5517H

The function of adjusting display setting using PC application will be disabled.

Do you wish to disable DDC/CI function?

No

Yes

When the monitor enters the **Power Save** mode, the following message appears:

### Dell C5517H

Entering Power Save Mode.





Activate the computer and wake up the monitor to gain access to the [Using the On-Screen Display \(OSD\) Menu](#).

If you press any button other than the power button, the following messages will appear depending on the selected input:

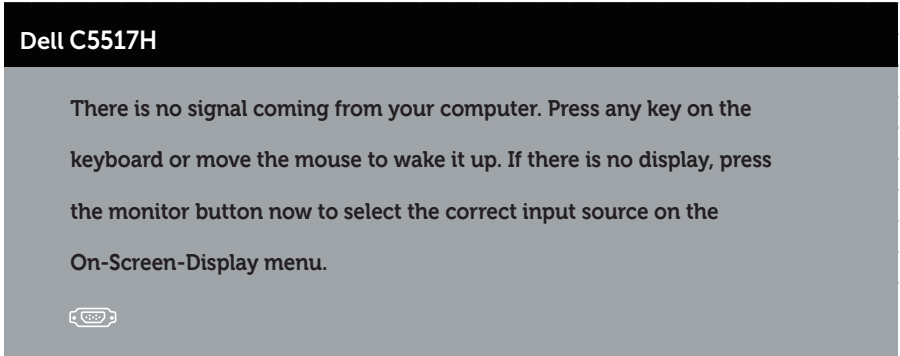

If VGA, HDMI or DP cable is not connected, a floating dialog box as shown below appears. The monitor will enter **Power Save Mode after 4 minutes** if left at this state.

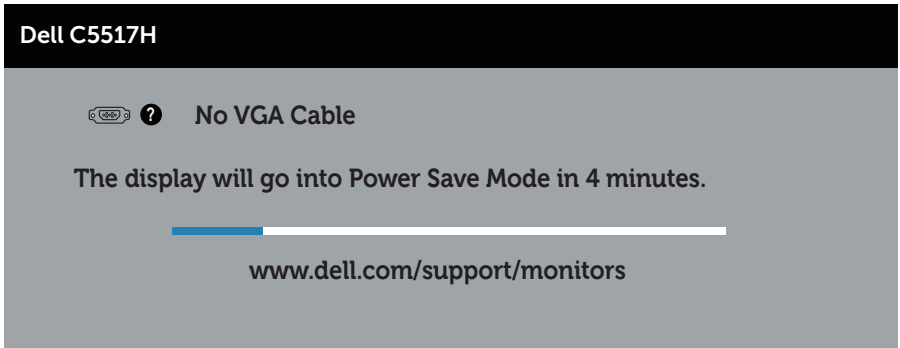

## Dell C5517H

 ? No HDMI 1 Cable

The display will go into Power Save Mode in 4 minutes.

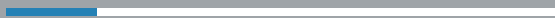

[www.dell.com/support/monitors](http://www.dell.com/support/monitors)

## Dell C5517H

 ? No HDMI 2 Cable

The display will go into Power Save Mode in 4 minutes.



[www.dell.com/support/monitors](http://www.dell.com/support/monitors)

## Dell C5517H

 ? No DP Cable

The display will go into Power Save Mode in 4 minutes.



[www.dell.com/support/monitors](http://www.dell.com/support/monitors)

See [Solving Problems](#) for more information.

## Setting the Maximum Resolution

To set the Maximum resolution for the monitor:

### In Windows 7, Windows 8/Windows 8.1:

1. For Windows 8/Windows 8.1 only, select the Desktop tile to switch to classic desktop.
2. Right-click on the desktop and click **Screen Resolution**.
3. Click the dropdown list of the screen resolution and select 1920 x 1080.
4. Click OK.

### In Windows 10:

1. Right-click on the desktop and click **Display settings**.
2. Click **Advanced display settings**.
3. Click the dropdown list of **Resolution** and select 1920 x 1080.
4. Click **Apply**.

If you do not see 1920 x 1080 as an option, you may need to update your graphics driver. Depending on your computer, complete one of the following procedures:

If you have a Dell desktop or portable computer:

- Go to [www.dell.com/support](http://www.dell.com/support), enter your service tag, and download the latest driver for your graphics card.

If you are using a non-Dell computer (portable or desktop):

- Go to the support site for your computer and download the latest graphic drivers.
- Go to your graphics card website and download the latest graphic drivers.

# Troubleshooting

**⚠ WARNING:** Before you begin any of the procedures in this section, follow the [Safety Instruction](#)

## Self-Test

Your monitor provides a self-test feature that allows you to check whether your monitor is functioning properly. If your monitor and computer are properly connected but the monitor screen remains dark, run the monitor self-test by performing the following steps:

1. Turn off both your computer and the monitor.
2. Unplug the video cable from the back of the computer. To ensure proper Self-Test operation, remove Digital (black connector), the Analog (blue connector) cables and DP (black connector) from the back of computer.
3. Turn on the monitor.

The floating dialog box should appear on-screen (against a black background) if the monitor cannot sense a video signal and is working correctly. While in self-test mode, the power LED remains white. Also, depending upon the selected input, one of the dialogs shown below will continuously scroll through the screen.

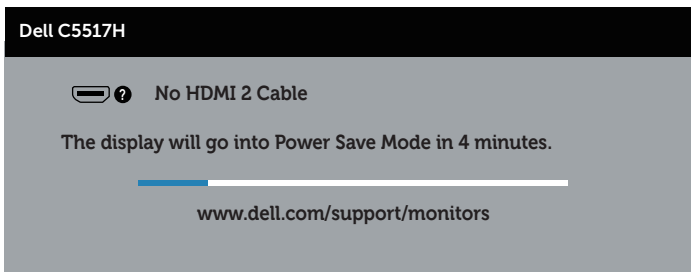
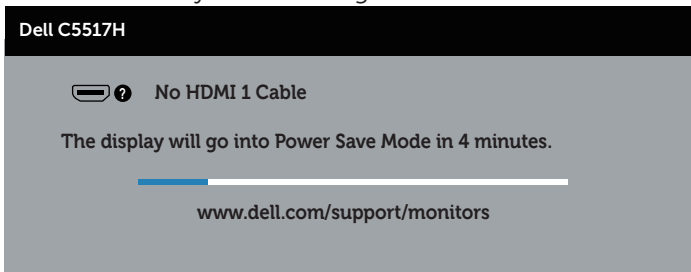

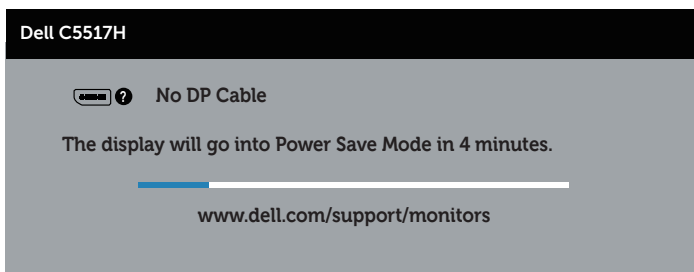
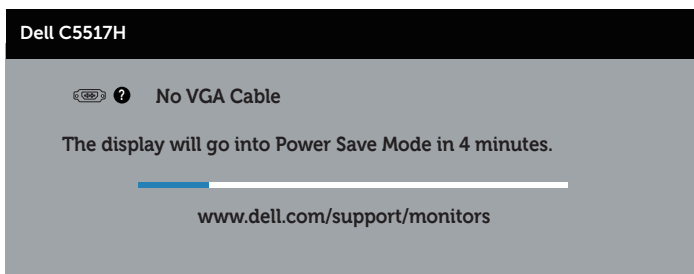

4. This box also appears during normal system operation, if the video cable becomes disconnected or damaged. The monitor will enter **Power Save Mode after 4 minutes** if left at this state.
5. Turn off your monitor and reconnect the video cable; then turn on both your computer and the monitor.

If your monitor screen remains blank after you use the previous procedure, check your video controller and computer, because your monitor is functioning properly.

## Built-in Diagnostics

Your monitor has a built-in diagnostic tool that helps you determine if the screen abnormality you are experiencing is an inherent problem with your monitor, or with your computer and video card.

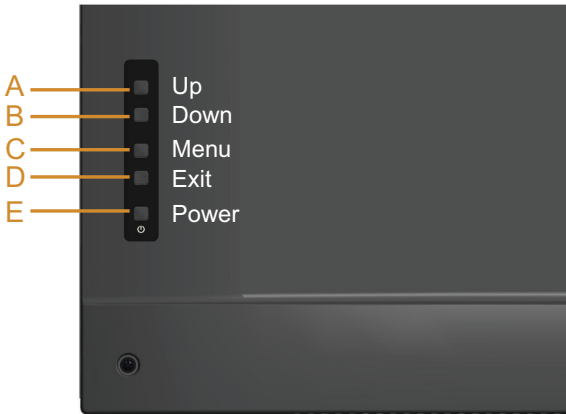

**NOTE:** You can run the built-in diagnostics only when the video cable is unplugged and the monitor is in self-test mode.

To run the built-in diagnostics:

1. Ensure that the screen is clean (no dust particles on the surface of the screen).
2. Unplug the video cable(s) from the back of the computer or monitor. The monitor then goes into the self-test mode.
3. Press and hold the **Button A** for 5 seconds. A gray screen appears.
4. Carefully inspect the screen for abnormalities.
5. Press the **Button A** on the back cover again. The color of the screen changes to red.
6. Inspect the display for any abnormalities.
7. Repeat steps 5 and 6 to inspect the display in green, blue, black, white screens.

The test is complete when the white screen appears. To exit, press the **Button A** again.

If you do not detect any screen abnormalities upon using the built-in diagnostic tool, the monitor is functioning properly. Check the video card and computer.

## Common Problems

The following table contains general information about common monitor problems you might encounter and the possible solutions.

Common Symptoms	What You Experience	Possible Solutions
No Video/Power LED off	No picture	<ul style="list-style-type: none"> <li>• Ensure that the video cable connecting the monitor and the computer is properly connected and secure.</li> <li>• Verify that the power outlet is functioning properly using any other electrical equipment.</li> <li>• Ensure that the power button is depressed fully.</li> </ul>
No Video/Power LED on	No picture or no brightness	<ul style="list-style-type: none"> <li>• Increase brightness &amp; contrast controls via OSD.</li> <li>• Perform monitor self-test feature check.</li> <li>• Check for bent or broken pins in the video cable connector.</li> <li>• Ensure that the correct input source is selected via the <a href="#">Input Source</a> Select menu.</li> <li>• Run the built-in diagnostics.</li> </ul>
Poor Focus	Picture is fuzzy, blurry, or ghosting	<ul style="list-style-type: none"> <li>• Perform Auto Adjust via OSD.</li> <li>• Adjust the Phase and Pixel Clock controls via OSD. (For VGA source only)</li> <li>• Eliminate video extension cables.</li> <li>• Reset the monitor to <b>Factory Settings</b>.</li> <li>• Change the video resolution to the correct aspect ratio (16:9).</li> </ul>
Shaky/Jittery Video	Wavy picture or fine movement	<ul style="list-style-type: none"> <li>• Perform Auto Adjust via OSD. (For VGA source only)</li> <li>• Adjust the Phase and Pixel Clock controls via OSD. (For VGA source only)</li> <li>• Reset the monitor to <b>Factory Settings</b>.</li> <li>• Check environmental factors.</li> <li>• Relocate the monitor and test in another room.</li> </ul>

Common Symptoms	What You Experience	Possible Solutions
Missing Pixels	LCD screen has spots	<ul style="list-style-type: none"> <li>• Cycle power on-off.</li> <li>• Pixel that is permanently off is a natural defect that can occur in LCD technology.</li> </ul> <p>For more information on Dell Monitor Quality and Pixel Policy, see Dell Support site at: <a href="http://www.dell.com/support/monitors">www.dell.com/support/monitors</a>.</p>
Stuck-on Pixels	LCD screen has bright spots	<ul style="list-style-type: none"> <li>• Cycle power on-off.</li> <li>• Pixel that is permanently off is a natural defect that can occur in LCD technology.</li> </ul> <p>For more information on Dell Monitor Quality and Pixel Policy, see Dell Support site at: <a href="http://www.dell.com/support/monitors">www.dell.com/support/monitors</a>.</p>
Brightness Problems	Picture too dim or too bright	<ul style="list-style-type: none"> <li>• Reset the monitor to <b>Factory Settings</b>.</li> <li>• Auto Adjust via OSD.</li> <li>• Adjust brightness &amp; contrast controls via OSD.</li> </ul>
Geometric Distortion	Screen not centered correctly	<ul style="list-style-type: none"> <li>• Reset the monitor to <b>Factory Settings</b>.</li> <li>• Auto Adjust via OSD.</li> <li>• Adjust brightness &amp; contrast controls via OSD.</li> </ul>
Horizontal/Vertical Lines	Screen has one or more lines	<ul style="list-style-type: none"> <li>• Reset the monitor to <b>Factory Settings</b>.</li> <li>• Perform Auto Adjust via OSD.</li> <li>• Adjust Phase and Pixel Clock controls via OSD.</li> <li>• Perform monitor self-test feature check and determine if these lines are also in self-test mode.</li> <li>• Check for bent or broken pins in the video cable connector.</li> </ul>



Common Symptoms	What You Experience	Possible Solutions
Synchronization Problems	Screen is scrambled or appears torn	<ul style="list-style-type: none"> <li>• Reset the monitor to <b>Factory Settings</b>.</li> <li>• Perform Auto Adjust via OSD. (For VGA source only)</li> <li>• Adjust Phase and Pixel Clock controls via OSD. (For VGA source only)</li> <li>• Perform monitor self-test feature check to determine if the scrambled screen appears in self-test mode.</li> <li>• Check for bent or broken pins in the video cable connector.</li> <li>• Restart the computer in the safe mode.</li> </ul>
Safety-Related Issues	Visible signs of smoke or sparks	<ul style="list-style-type: none"> <li>• Do not perform any troubleshooting steps.</li> <li>• Contact Dell immediately.</li> </ul>
Intermittent Problems	Monitor malfunctions on & off	<ul style="list-style-type: none"> <li>• Ensure that the video cable connecting the monitor to the computer is connected properly and is secure.</li> <li>• Reset the monitor to <b>Factory Settings</b>.</li> <li>• Perform monitor self-test feature check to determine if the intermittent problem occurs in self-test mode.</li> </ul>
Missing Color	Picture missing color	<ul style="list-style-type: none"> <li>• Perform monitor self-test feature check.</li> <li>• Ensure that the video cable connecting the monitor to the computer is connected properly and is secure.</li> <li>• Check for bent or broken pins in the video cable connector.</li> </ul>
Wrong Color	Picture color not good	<ul style="list-style-type: none"> <li>• Change the Color Setting Mode in the Color Settings OSD to Graphics or Video depending on the application.</li> <li>• Try different Color Preset Settings in Color Settings OSD. Adjust R/G/B value in Color Settings OSD if the Color Management is turned off.</li> <li>• Change the Input Color Format to PC RGB or YPbPr in the Advance Setting OSD.</li> </ul>

Common Symptoms	What You Experience	Possible Solutions
No sound or sound is low	Monitor has no sound or sound is low	<ul style="list-style-type: none"> <li>• Make sure the audio cable is properly connected to the monitor.</li> <li>• Adjust the volume settings of both your monitor and computer.</li> <li>• Make sure the computer sound card driver is properly installed and activated.</li> <li>• Make sure the audio source is correct on the OSD.</li> </ul>
Image retention from a static image left on the monitor for a long period of time	Faint shadow from the static image displayed appears on the screen	<ul style="list-style-type: none"> <li>• Use the Power Management feature to turn off the monitor at all times when not in use (for more information, see <a href="#">Power Management Modes</a>).</li> <li>• Alternatively, use a dynamically changing screensaver.</li> </ul>

 **NOTE:** When using 'HDMI' or DP mode, the positioning adjustments are not available.

## Product-Specific Problems

Specific Symptoms	What You Experience	Possible Solutions
Screen image is too small	Image is centered on screen, but does not fill entire viewing area	<ul style="list-style-type: none"> <li>• Reset the monitor to <b>Factory Settings</b>.</li> </ul>
Cannot adjust the monitor with the buttons on the front panel	OSD does not appear on the screen	<ul style="list-style-type: none"> <li>• Turn off the monitor, unplug the power cord, plug back, and then turn on the monitor.</li> </ul>
No Input Signal when user controls are pressed	No picture, the LED light is white. When you press "up", "down" or "Menu" key, the message "No input signal" will appear.	<ul style="list-style-type: none"> <li>• Check the signal source. Ensure the computer is not in the power saving mode by moving the mouse or pressing any key on the keyboard.</li> <li>• Check whether the signal cable is plugged in properly. Re-plug the signal cable if necessary.</li> <li>• Reset the computer or video player.</li> </ul>
The picture does not fill the entire screen	The picture cannot fill the height or width of the screen	<ul style="list-style-type: none"> <li>• Due to different video formats (aspect ratio) of DVDs, the monitor may display in full screen.</li> <li>• The option you select in Display Settings-Aspect Ratio might also influence the picture fitting on screen.</li> <li>• Run the built-in diagnostics.</li> </ul>

 **NOTE:** When choosing HDMI or DP mode, the Auto Adjust function is not available.

# Appendix

## **WARNING: Safety Instructions**

 **WARNING:** Use of controls, adjustments, or procedures other than those specified in this documentation may result in exposure to shock, electrical hazards, and/or mechanical hazards.

For information on safety instructions, see the *Product Information Guide*.

## **FCC Notices (U.S. Only) and Other Regulatory Information**

For FCC notices and other regulatory information, see the regulatory compliance website located at [www.dell.com/regulatory\\_compliance](http://www.dell.com/regulatory_compliance).

**This device complies with Part 15 of the FCC Rules. Operation is subject to the following two conditions:**

- (1) this device may not cause harmful interference
- (2) this device must accept any interference received including interference that may cause undesired operation

## **Contact Dell**

**For customers in the United States, call 800-WWW-DELL (800-999-3355).**

 **NOTE:** If you do not have an active Internet connection, you can find contact information on your purchase invoice, packing slip, bill, or Dell product catalog.

**Dell provides several online and telephone-based support and service options. Availability varies by country and product, and some services may not be available in your area.**

**To get online monitor support content:**

1. Visit [www.dell.com/support/monitors](http://www.dell.com/support/monitors)

**To contact Dell for sales, technical support, or customer service issues:**

1. Visit [www.dell.com/support](http://www.dell.com/support).
2. Verify your country or region in the **Choose A Country/Region** drop-down menu at the top left of the page.
3. Click **Contact Us** on the top left side of the page.
4. Select the appropriate service or support link based on your need.
5. Choose the method of contacting Dell that is convenient for you.

# Setting Up Your Monitor

## Setting the display resolution to 1920 x 1080 (Maximum)

For optimal display performance while using the Microsoft Windows operating systems, set the display resolution to 1920 x 1080 pixels by performing the following steps:

### In Windows 7, Windows 8/Windows 8.1:

1. For Windows 8/Windows 8.1 only, select the Desktop tile to switch to classic desktop.
2. Right-click on the desktop and click Screen Resolution.
3. Click the dropdown list of the screen resolution and select 1920 x 1080.
4. Click OK.

### In Windows 10:

1. Right-click on the desktop and click **Display settings**.
2. Click **Advanced display settings**.
3. Click the dropdown list of **Resolution** and select 1920 x 1080.
4. Click **Apply**.

If you do not see 1920 x 1080 as an option, you may need to update your graphics driver. Please choose the scenario below that best describes the computer system you are using, and follow the provided

- 1: [If you have a Dell desktop or a Dell portable computer with Internet access](#)
- 2: [If you have a non Dell desktop, portable computer, or graphics card](#)

## If you have a Dell desktop or a Dell portable computer with Internet access

1. Go to <http://www.dell.com/support>, enter your service tag, and download the latest driver for your graphics
2. After installing the drivers for your graphics adapter, attempt to set the resolution to 1920 x 1080 again.

 **NOTE:** If you are unable to set the resolution to 1920 x 1080, please contact Dell to inquire about a graphics adapter that supports these resolutions.

## If you have a non Dell desktop, portable computer, or graphics card

### In Windows 7, Windows 8/Windows 8.1:

1. For Windows 8/Windows 8.1 only, select the Desktop tile to switch to classic desktop.
2. Right-click on the desktop and click Personalization.
3. Click Change Display Settings.
4. Click Advanced Settings.
5. Identify your graphics controller supplier from the description at the top of the window (e.g. NVIDIA, ATI, Intel etc.).
6. Please refer to the graphics card provider website for updated driver (for example, <http://www.ATI.com> OR <http://www.NVIDIA.com> ).
7. After installing the drivers for your graphics adapter, attempt to set the resolution to 1920 x 1080 again.

### In Windows 10:

1. Right-click on the desktop and click **Display settings**.
2. Click **Advanced display settings**.
3. Click **Display adapter properties**.
4. Identify your graphics controller supplier from the description at the top of the window (e.g. NVIDIA, ATI, Intel etc.).
5. Please refer to the graphics card provider website for updated driver (for example, <http://www.ATI.com> OR <http://www.NVIDIA.com> ).
6. After installing the drivers for your graphics adapter, attempt to set the resolution to 1920 x 1080 again.

 **NOTE:** If you are unable to set the resolution to 1920 x 1080, please contact the manufacturer of your computer or consider purchasing a graphics adapter that will support the video resolution of 1920 x 1080.

# Procedures for setting up dual monitors in Windows 7, Windows 8/Windows 8.1 or Windows 10

## For Windows 7

Connect the external monitor(s) to your laptop or desktop using a video cable (VGA, HDMI, DP etc.) and follow any of the below setup method.

### Method 1: Using keyboard shortcut "Win+P"

1. Press the **Windows logo key + P** on your keyboard.
2. While holding down the **Windows logo key**, press **P** to toggle between the display selections.

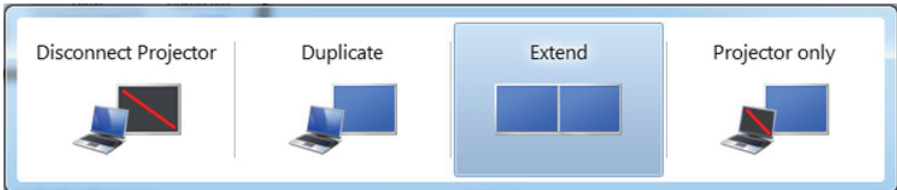

### Method 2: Using the "Screen Resolution" menu

1. Right-click on the desktop and click **Screen resolution**.

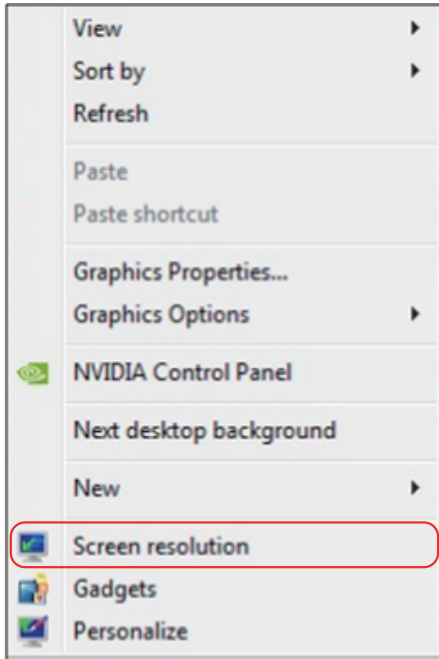

2. Click **Multiple displays** to choose a display selection. If you do not see the additional monitor listed, click **Detect**.
- You may need to restart your system and repeat steps 1 to 3 if the system does not detect the added monitor.

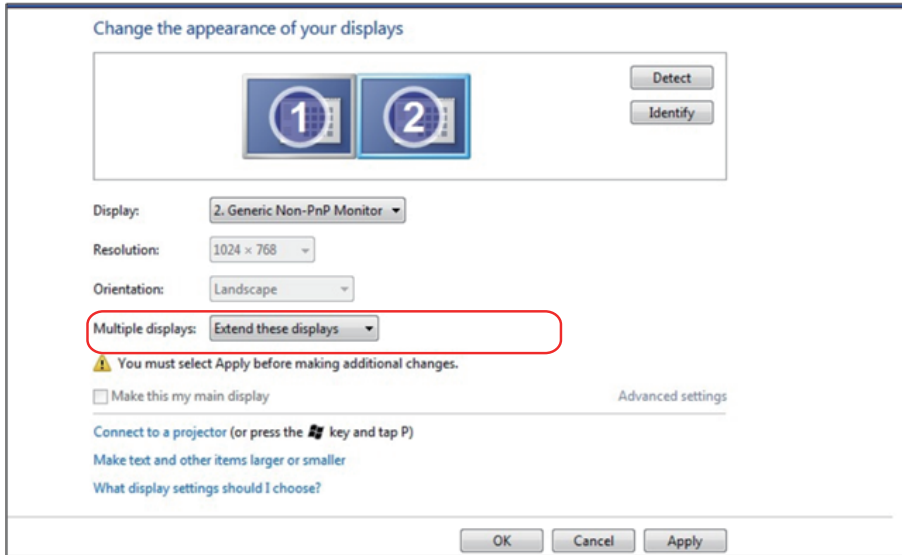





## For Windows 8/Windows 8.1

Connect the external monitor(s) to your laptop or desktop using a video cable (VGA, HDMI, DP etc.) and follow any of the below setup method.

### Method 1: Using keyboard shortcut “Win+P”

1. Press the **Windows logo key + P** on your keyboard.  + 
2. While holding down the **Windows logo key**, press **P** to toggle between the display selections.

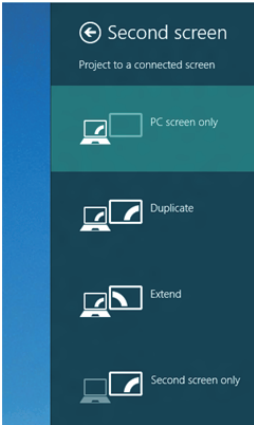

### Method 2: Using the “Screen Resolution” menu

1. From the Start screen, select **Desktop** tile to switch to the Classic Windows desktop.



2. Right-click on the desktop and click **Screen resolution**.

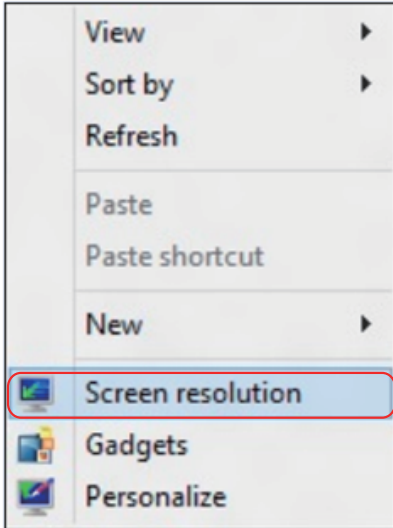

3. Click **Multiple displays** to choose a display selection. If you do not see the additional monitor listed, click Detect.
- You may need to restart your system and repeat steps 1 to 3 if the system does not detect the added monitor.

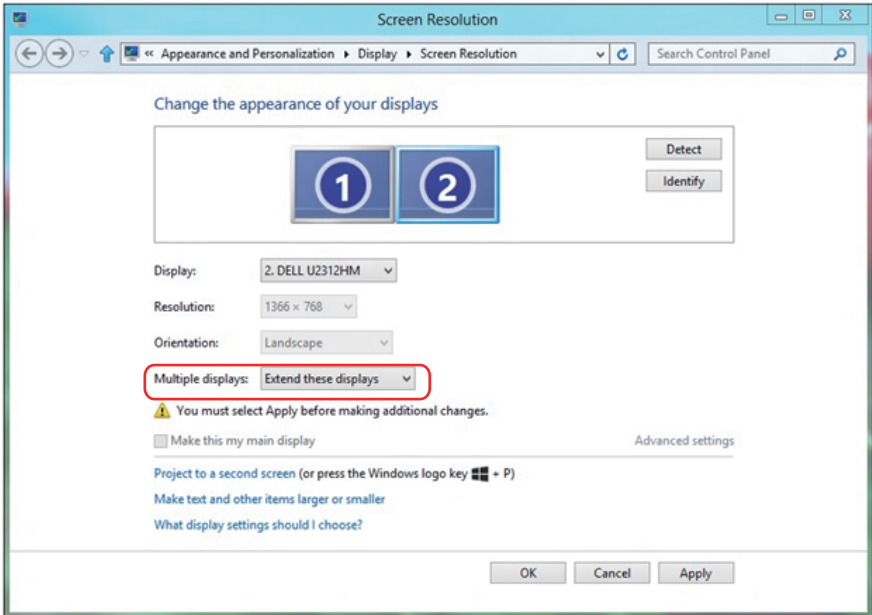

## Setting Display Styles For Multiple Monitor in Windows 7 or Windows 8/ Windows 8.1

After the external monitor(s) have been set up, users can select the desired display style from **Multiple displays** menu: Duplicate, Extend, Show Desktop On.

- **Duplicate these displays:** Duplicate the same screen on two monitors with the same resolution, chosen based on the monitor with a lower resolution.

### For Windows 8/Windows 8.1

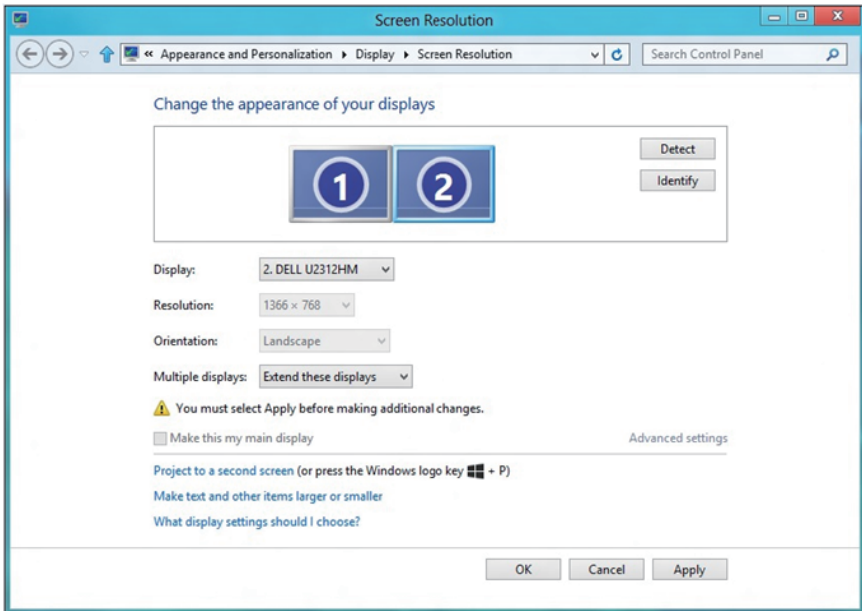

- **Show desktop only on:** Display the status of a particular monitor. This option is typically chosen when the laptop is used as a PC so the user can enjoy a large external monitor. Most current laptops support mainstream resolutions. As shown in the figure above, the resolution of the laptop monitor is only 1280 x 800, but after connecting a 27" external LCD monitor, users can immediately improve their visual enjoyment to 1920 x 1080 Full HD quality.

## For Windows 7

### Change the appearance of your displays

The screenshot shows the Windows 7 'Change the appearance of your displays' dialog box. At the top, there are two monitor icons labeled '1' and '2'. To the right are 'Detect' and 'Identify' buttons. Below the icons, the 'Display:' dropdown is set to '1. Mobile PC Display'. The 'Resolution:' dropdown is set to '1024 x 768'. The 'Orientation:' dropdown is set to 'Landscape'. The 'Multiple displays:' dropdown is open, showing four options: 'Show desktop only on 1' (which is highlighted), 'Duplicate these displays', 'Extend these displays', and 'Show desktop only on 2'. A yellow warning icon is next to the text 'You must select one of these options to apply any additional changes.' Below this, there is a checkbox for 'Make this my main display' which is currently unchecked. To the right of the checkbox is a link for 'Advanced settings'. At the bottom of the dialog, there are three buttons: 'OK', 'Cancel', and 'Apply'. Below the buttons, there are three links: 'Connect to a projector (or press the Windows key and tap P)', 'Make text and other items larger or smaller', and 'What display settings should I choose?'.

## Change the appearance of your displays

Display: 1. Mobile PC Display

Resolution: 1024 × 768

Orientation: Landscape

Multiple displays: Show desktop only on 2

**⚠ You must select** Duplicate these displays **onal changes.**  
Extend these displays  
Show desktop only on 1  
Show desktop only on 2

Make this my main display

Advanced settings

Connect to a projector (or press the **⌘** key and tap P)

Make text and other items larger or smaller

What display settings should I choose?

OK Cancel Apply

## For Windows 8/Windows 8.1

Screen Resolution

Appearance and Personalization > Display > Screen Resolution

Change the appearance of your displays

Display: 2. DELL U2312HM

Resolution: 1366 × 768

Orientation: Landscape

Multiple displays: Show desktop only on 1

**⚠ You must select** Duplicate these displays **onal changes.**  
Extend these displays  
Show desktop only on 1  
Show desktop only on 2

Make this my main display

Advanced settings

Project to a second screen (or press the Windows logo key **⌘** + P)

Make text and other items larger or smaller

What display settings should I choose?

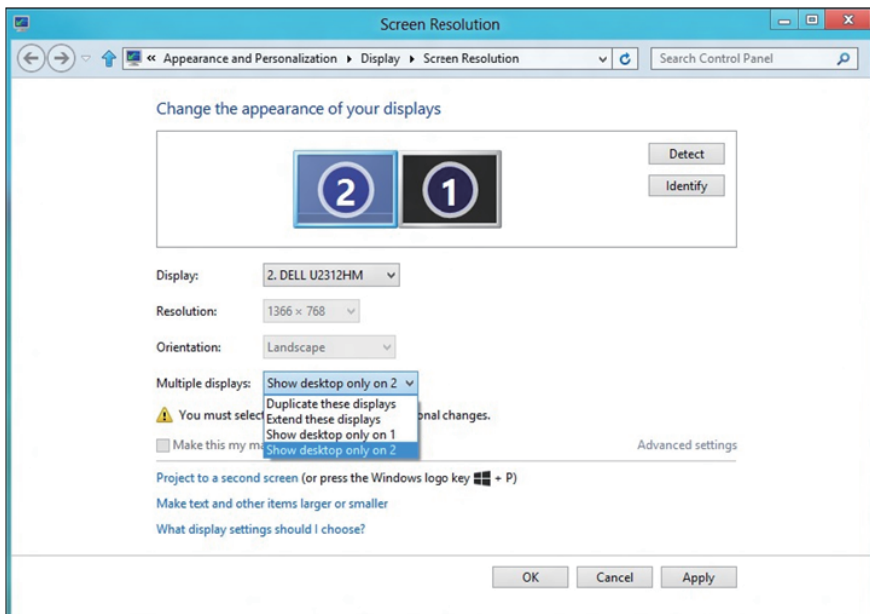

OK Cancel Apply



## For Windows 10

Connect the external monitor(s) to your laptop or desktop using a video cable (VGA, DVI, DP, HDMI etc.) and follow any of the below setup method.

### Method 1: Using keyboard shortcut “Win+P”

1. Press the **Windows logo key + P** on your keyboard.  + 
2. While holding down the **Windows logo key**, press **P** to toggle between the display selections.

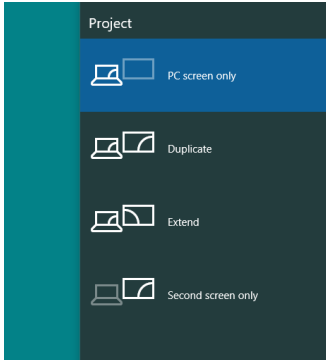

### Method 2: Using the “Screen Resolution” menu

1. Right-click on the desktop and click **Display Settings**.

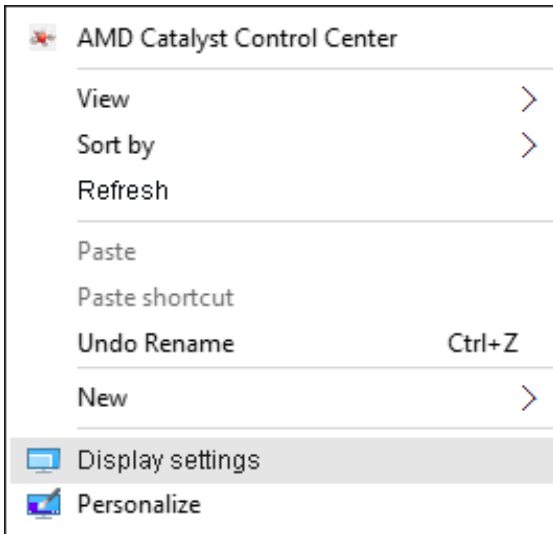

2. Click **Customize your display** to choose a display selection. If you do not see the additional monitor listed, click Detect.
  - You may need to restart your system and repeat steps 1 to 2 if the



system does not detect the added monitor.

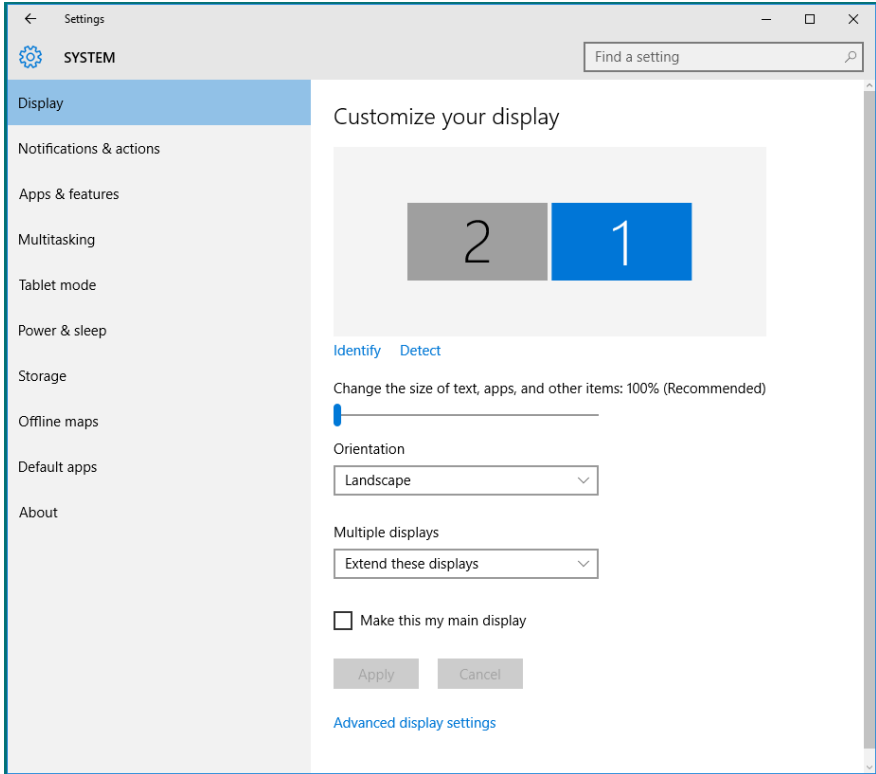

## Setting Display Styles For Multiple Monitors in Windows 10

After the external monitor(s) have been set up, users can select the desired display style from **Multiple displays** menu: Duplicate, Extend, Show only On, Disconnect.

- **Duplicate these displays:** Duplicate the same screen on two monitors with the same resolution, chosen based on the monitor with a lower resolution.

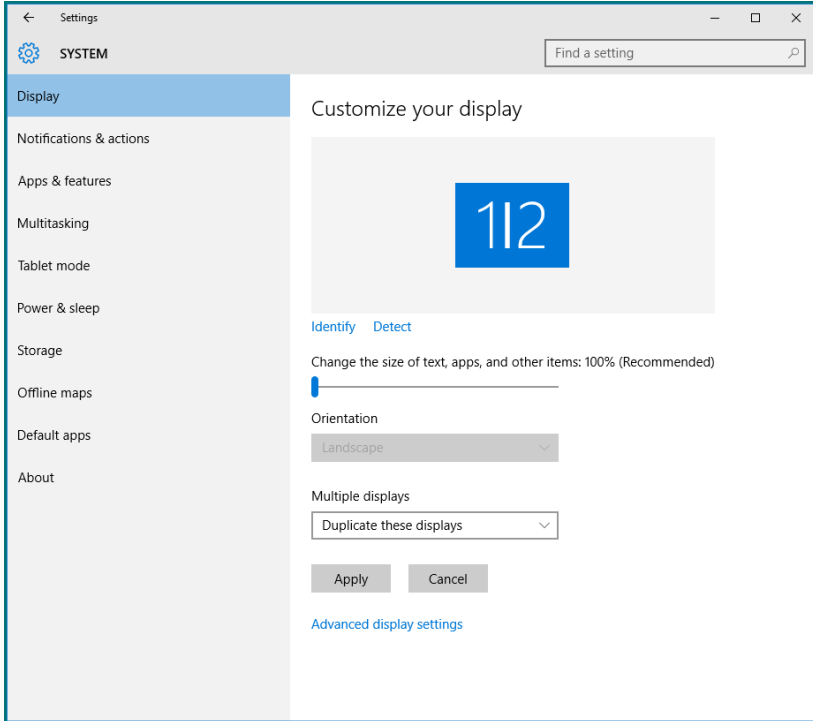

- **Extend these displays:** This option is recommended when an external monitor is connected to a laptop, and each monitor can display different screen independently to improve user convenience. The relative position of the screens can be set up here, for example monitor 1 may be set up to be to the left of monitor 2 or vice versa. This depends on the physical position of the LCD monitor in relation to the laptop. The horizontal line displayed on both monitors can be based on the laptop or external monitor. These are all adjustable options, and all a user need do is drag the monitor of the main screen to the extended monitor.

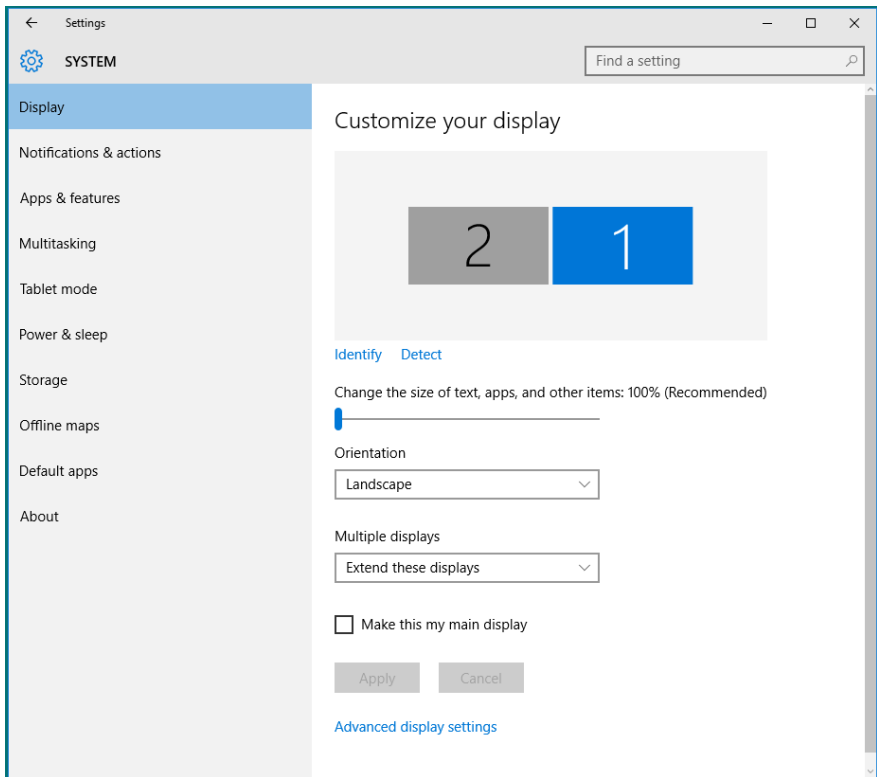

- **Show only on...:** Display the status of a particular monitor. This option is typically chosen when the laptop is used as a PC so the user can enjoy a large external monitor. Most current laptops support mainstream resolutions. As shown in the figure below, the resolution of the laptop monitor is only 1280 x 800, but after connecting a 27" external LCD monitor, users can immediately improve their visual enjoyment to 1920 x 1080 Full HD quality.

