

USER'S MANUAL

DTH-3220



[About the Wacom Cintiq Pro](#)
[Features of your Wacom Cintiq Pro](#)
[Set up your device](#)
[Get started with your creative pen display](#)
[Work with your pen](#)
[Customize your device in Wacom Tablet Properties](#)
[Use On-Screen Controls as shortcuts](#)
[Access application-specific settings](#)
[Multi-Touch](#)
[Wacom Desktop Center](#)
[Customize Wacom Display Settings](#)
[Care for your device](#)
[Technical Support](#)
[About this Document](#)



wacom®

Table of Contents

Table of Contents	2
About the Wacom Cintiq Pro	5
Included with your Wacom Cintiq Pro	5
About the Wacom Cintiq Pro Engine	6
Included with your Wacom Cintiq Pro Engine	6
Finding more information	6
Features of your Wacom Cintiq Pro	7
Features of your Wacom Cintiq Pro Engine	8
Use Touch Keys as shortcuts	10
Set up your device	11
Install the driver	12
Update the driver	12
Get started with your creative pen display	13
Access user help	13
Connect to your computer	14
Install Your Wacom Cintiq Pro Engine to Create the Wacom Cintiq Pro Studio	15
Calibration	17
Work with your pen	18
Personalize your pen with a color ring	18
Specialty pens	18
Use your pen	19
Pen tip and eraser	19
Pen buttons	19
Store your pen	20
Customize your pen functions	21
Assign settings to the pen button and pen tip	21
Customize other pen properties	21
Eraser	23
Replace the pen nib	24
Where to find replacement nibs	24
Where to find the nib replacement tool	24
Use your pen with Windows Ink	25
Advanced pen and eraser	26
Customize your device in Wacom Tablet Properties	27
What can I customize in Wacom Tablet Properties?	27
Where can I access settings and other options in Wacom Tablet Properties?	27
Open Wacom Tablet Properties	28
Assign settings in Wacom Tablet Properties	29
Example of assigning a setting in Wacom Tablet Properties	30

What settings can I assign?	31
Assign keystrokes	35
ExpressKeys™	36
Touch Ring	37
Settings View	38
Display Toggle	39
Customize user options	41
Use On-Screen Controls as shortcuts	42
How to create and use an On-Screen Control	42
On-Screen Control layouts	42
Create On-Screen Controls	44
Assign settings to Radial Menus and Screen Keys	46
Assign settings to Keypads	47
Assign On-Screen Controls	48
Access application-specific settings	49
Application-specific settings assigned by you	50
Settings assigned by applications	52
How do I know what setting is assigned?	52
Settings assignments work differently for different customizable components	52
Imported settings assigned by applications	53
Multi-Touch	54
Touch Options	55
My Gestures	57
Standard Gestures	58
Wacom Desktop Center	60
Customizing your device	60
Running the Setup Wizard	60
Redeeming Software	60
Backing up your settings	60
Backing up your files	61
Updating your tablet	61
Getting apps and products	61
Getting Support for Wacom products	61
Logging in with your Wacom ID	61
Customize Wacom Display Settings	62
Customize advanced Wacom Display Settings	64
Wacom Display Settings - Set Color	66
Care for your device	67
Technical Support	68
Test the creative pen display	69
Test the pen	70

Diagnose issues using Wacom Tablet Properties	70
Test touch	72
Glossary	73
Order parts and accessories	75
Privacy	76
About This Document	77
Things to Know About User Help	77
Device Features in User Help	77
Trademarks	78



About the Wacom Cintiq Pro

Your Cintiq Pro creative pen display helps you express yourself by allowing you to create directly on your screen.

- Draw, paint, or design with the Pen included with your Cintiq Pro, or use other Wacom Pens and tools compatible with the Cintiq Pro.
- Use the included [ExpressKey Remote](#), which gives you 17 customizable ExpressKeys™ and a convenient Touch Ring, to quickly access your most-used functions.
- Visit the [Wacom Store](#) to find more accessories that can help you work with the Cintiq Pro, such as a display stand or Color Manager.

Review the [features of your Wacom Cintiq Pro](#) and learn how to [get started with your creative pen display](#).

Included with your Wacom Cintiq Pro

After unpacking your Cintiq Pro, make sure that you have the following items:

- Cintiq Pro creative pen display
- ExpressKey Remote with charging cable and wireless connection dongle
- Wacom Pro Pen 2
- Pen stand with extra nibs
- Pen holder
- Pen color rings
- Quick Start Guide (booklet in Wacom Cintiq Pro box)
- USB-A cable
- USB-C cable
- DisplayPort cable
- HDMI cable
- DisplayPort to Mini DisplayPort adapter
- AC power adapter
- Power cable(s)
- Cleaning cloth

About the Wacom Cintiq Pro Engine

The Cintiq Pro Engine is a creative PC module that combines with your Cintiq Pro. The result is the Cintiq Pro Studio: an all-in-one solution for creative professionals.

- The Cintiq Pro and the Cintiq Pro Engine fit together easily and securely, providing fast and reliable installation.
- Enjoy the Cintiq Pro Studio's sleek and compact industrial design, which gives you a minimalist workspace, free of cords and clutter.
- Windows 10 Pro is pre-installed on the Cintiq Pro Studio.
- The Cintiq Pro Engine is available in two performance models, giving you the option to use the model that fits your needs best.

Included with your Wacom Cintiq Pro Engine

Before assembling your Cintiq Pro Studio, make sure that you have the following items:

- Cintiq Pro Engine creative PC module
- Quick Start Guide (booklet in Cintiq Pro Engine box)
- AC power adapter
- Power cable
- Panel screws (x2)
- Screw tool

Finding more information

- Access FAQs and other product information on the [Wacom Cintiq Pro Getting Started](#) page, or the [Wacom Cintiq Pro Engine Getting Started](#) page of the Wacom website.
- Review the Important Product Information, which describes safety precautions, specifications, warranties, and the license agreement for your device, on the [Wacom Desktop Center](#).

Features of your Wacom Cintiq Pro

- **Touch Keys:** Buttons on the display which light up when you turn on the Cintiq Pro. [The Touch Keys are shortcuts](#) to commonly used utilities and functions.



- **USB-C port:** You can use this port to attach both video and pen/touch.
- **DisplayPort:** You can use this port to attach video.
- **HDMI port:** You can also use this port to attach video.
- **Back USB-A ports:** You can use these ports to attach pen/touch and your [ExpressKey Remote](#).
- **Side USB-A ports:** You can use these ports to attach other devices.
- **Headphone jack:** This jack can be used to attach your headphones.
- **Built-in Microphone:** This microphone can be used communicate and record.
- **Folding legs:** You can unfold the legs to prop up the creative pen display at an angle for easier use. Fold in the legs for a lower angle.
- **Power LED:** The Power LED indicates the current power state of the creative pen display.
 - The LED is blue when the creative pen display has full power.
 - The LED is orange when the creative pen display is in standby.
 - The LED is off when the creative pen display is off.
- **Power button:** Press the power button to turn the device on and off.
- **Status LED:** The Status LED lights when the Cintiq Pro has power and is communicating with the attached computer.
- **SD Card reader:** You can insert an external SD card to transfer files.
- **Kensington Security Slot:** This slot can be used to attach a locking cable to secure your creative pen display to a specific location, like your desk.

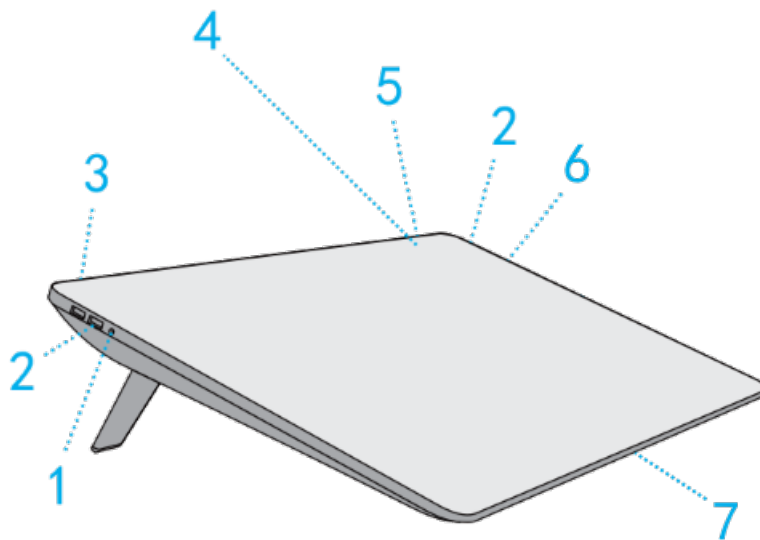

Number	Item
1	Headphone jack

2	USB-A ports
3	Kensington Security Slot
4	Touch Keys
5	Power button and Power/Status LEDs
6	SD Card reader
7	Built-in Microphone

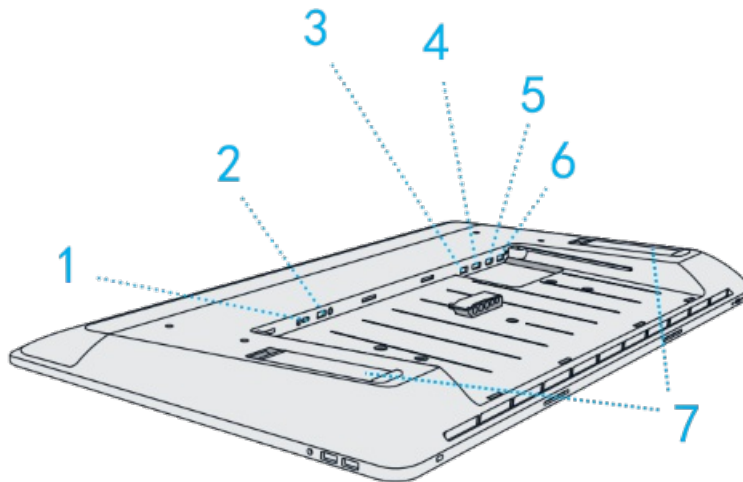

Number	Item
1	USB-C port
2	Power connection
3	USB-A port for computer connection
4	DisplayPort
5	HDMI port
6	USB-A port for ExpressKey Remote
7	Folding legs

Features of your Wacom Cintiq Pro Engine

The following features and connections are found on the back of your Cintiq Pro Engine. These features remain available when you install the Cintiq Pro Engine into your Cintiq Pro to create the Cintiq Pro Studio.

- **Two USB-C ports:** You can use these ports to attach additional displays or other devices.
- **Mini HDMI port:** You can use this port to attach additional displays.
- **Mini Display port:** You can use this port to attach additional displays.
- **LAN/Ethernet:** You can use this port for a wired network connection.

- **Power button:** Press the power button to turn the device on and off.

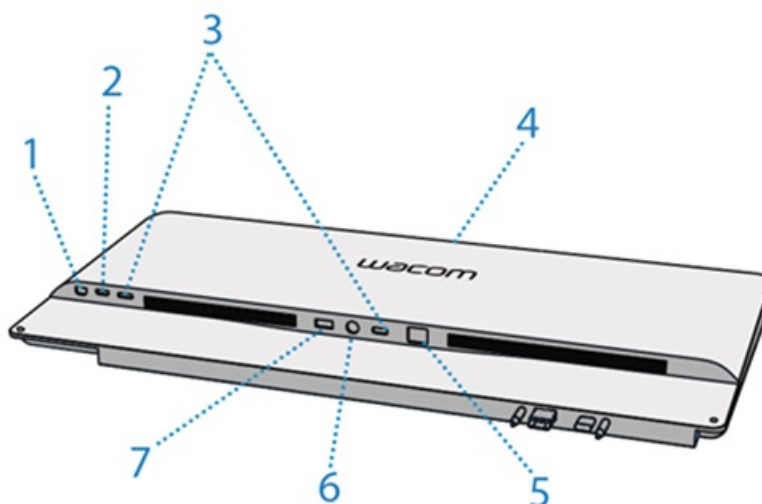

Number	Item
1	Mini DisplayPort
2	Mini HDMI port
3	USB-C port
4	Power button and Power/Status LEDs
5	LAN/Ethernet port
6	Cintiq Pro Engine power connection
7	Cintiq Pro power connection

Use Touch Keys as shortcuts

You can tap the Touch Keys to use them as shortcuts to specific functions. The Touch Keys light up across the top of the creative pen display when you turn it on.

**Video Input Source:**

Tap to switch between the display inputs attached to your creative pen display.

**Wacom Desktop Center:**

Tap to open the [Wacom Desktop Center](#) to customize and manage your device. Tap it again to close it.

**Toggle Keyboard:**

Tap to display the on-screen keyboard. Tap it again to close it.

**Wacom Display Settings:**

Tap to open [Wacom Display Settings](#) to adjust display settings such as brightness and sharpness. Tap it again to close it.

**Touch On/Off:**

Tap to turn on touch. Tap it again to turn touch off. Pen-only models do not have this touch key.

Set up your device

1. First, follow the directions in this section of user help. The Quick Start Guide included in the box contains images that can help.
 - Attach any stands that are included with your device.
 - Set up your work area.
2. After you set up your device, follow the directions in the **Get started** section of this user help so you can start using your device.
 - Connect your device to your computer.
 - Install the driver.

Install the driver

Important: You must install the driver for your device to work properly, unless your device comes with a pre-installed driver. Refer to the Quick Start Guide to discover if your device has a pre-installed driver or not.

1. Go to the Wacom [drivers page](#).
2. Click **Download** next to the latest driver that corresponds to your computer's operating system.
3. Follow the prompts to finish the driver installation.

Update the driver

Updated drivers are available on the [Wacom Desktop Center](#) and at the Wacom [drivers page](#) periodically. Check in and update regularly so that your device has the latest features and functionality.

- From the Wacom Desktop Center, select **Updates**, and then click the update to install it.
- If the Wacom Desktop Center is not available for your device, go to the Wacom [drivers page](#) to find the latest updates.

Note: Your device will not work if you uninstall the driver. If you uninstall the driver, reinstall the latest driver from the [drivers page](#) so that your device works again. If the driver is reinstalled, your device will revert to default settings.

Get started with your creative pen display

The Quick Start Guide included in the box with your device contains images that can help you to set up your pen display.

1. Connect your device to your computer.
2. Install the driver software on your computer.

Access user help

- You can access user help topics directly from [Wacom Tablet Properties](#). When you click the ? icon, you are directed to a help topic about the feature you are currently using.
- You can also open user help from the [Wacom Desktop Center Help](#) menu.
- You also can access user help from the **Product Manuals** page of the [Customer Support](#) website.

Notes:

- User help is common to Windows and Mac computers. Screenshots are from a Windows computer, unless otherwise noted.
- Information about your specific computer hardware, operating system, and application software is not included. Refer to the product information provided with those products.

Connect to your computer

Complete the following steps to setup your Wacom Cintiq Pro:

1. Gently lay the Cintiq Pro face down on a flat surface clear of debris.
2. Remove the back cover by pulling it away at the cable opening.
3. Connect your device to a power source using the power cable and AC adapter.
4. Determine what ports are available on your computer and attach your Cintiq Pro:
 - **USB-C:** Attach the USB-C cable from your computer to the Cintiq Pro.
 - **DisplayPort:** Attach the DisplayPort cable and the USB-A cable from your computer to the Cintiq Pro.
 - **HDMI:** Attach the HDMI cable and the USB-A cable from your computer to the Cintiq Pro.
 - **Other:** To function correctly both data and video cables must be attached from your computer to the Cintiq Pro. Data is communicated by the USB connection. If you have none of the above video connections available you may be able to [purchase a converter](#) which will allow you to connect video. Please contact [Customer Support](#) if you need assistance.
5. Bundle the cables with the attached cable ties.
6. Reattach the back cover, allowing the cables to pass through the cable opening.
7. Gently flip the Cintiq Pro so that it is face up and positioned for use.
8. Confirm your computer is on, and then turn on your Cintiq Pro by pressing the power button.
9. You must [install the driver](#) for pen & touch to function on your Cintiq Pro.
10. Your Cintiq Pro should now be functional. Check [Testing the Creative Pen Display](#) if you are not seeing input from pen and touch.
11. Wacom recommends that you click **UPDATES** in the [Wacom Desktop Center](#) to check for updates for the Wacom device driver and firmware.

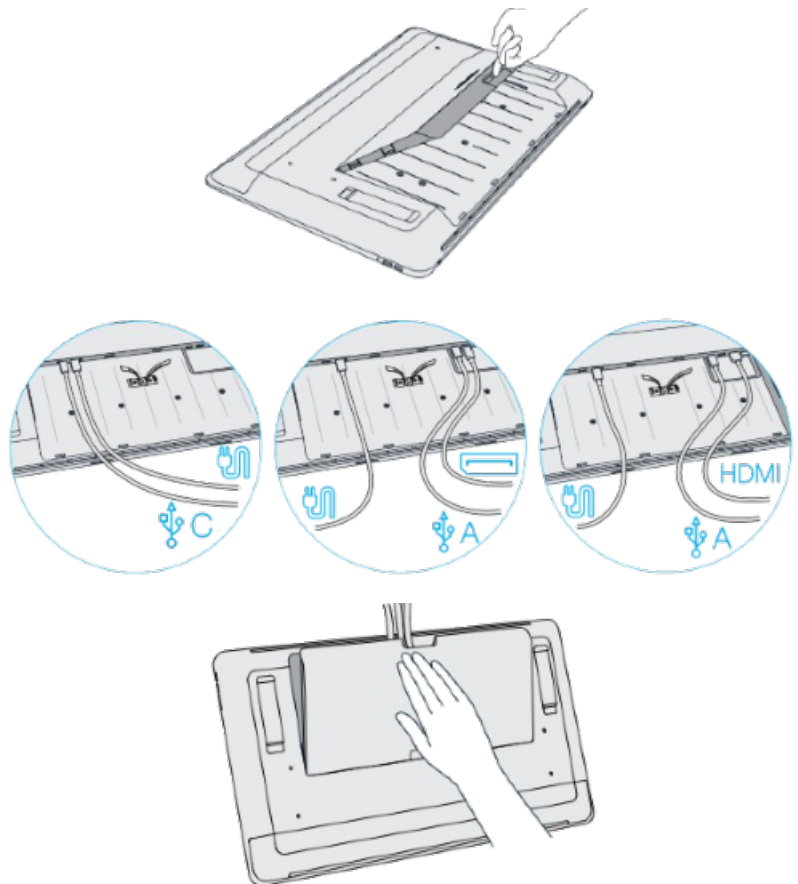

12. A short tutorial to help you learn about and understand your Cintiq Pro is available in the Tutorials section of the [Wacom Desktop Center](#).
13. Access FAQs and other product information on the [Wacom Cintiq Pro Getting Started](#) page of the Wacom website.

Install Your Wacom Cintiq Pro Engine to Create the Wacom Cintiq Pro Studio

The Cintiq Pro combines with the optional Cintiq Pro Engine to create the Cintiq Pro Studio. Complete the following steps to set up your Cintiq Pro Studio:

1. Gently lay the Wacom Cintiq Pro face down on a flat surface clear of debris.
2. Remove the back cover by pulling it away at the cable opening.

Note: Before proceeding, ensure there are no wired connections to your Cintiq Pro, including removing the power cable, AC adapter, and all USB connections. All ports on the back of your Cintiq Pro must be open for proper installation of the Cintiq Pro Engine.

3. Use the provided tool to remove the screws securing the attached cable ties, and then remove the cable ties.
4. Gently insert the Cintiq Pro Engine into the Cintiq Pro, using the guide rails to ensure proper alignment.
5. Use the provided tool to tighten the two screws securing the Cintiq Pro Engine to the Cintiq Pro.
6. Connect the Cintiq Pro power cable to the Cintiq Pro Engine.
7. Connect the Cintiq Pro Engine power cable to the Cintiq Pro Engine.
8. Gently flip your Cintiq Pro Studio so that it is face up and positioned for use. If desired, extend the stand legs to position your Cintiq Pro Studio at an angle.
9. Turn on your Cintiq Pro Studio by pressing the power button.
10. Your Cintiq Pro Studio should now be functional. Check [Testing the Creative Pen Display](#) if you are not seeing input from pen and touch.
11. Wacom recommends that you click **UPDATES** in the [Wacom Desktop Center](#) to check for updates for the Wacom device driver and firmware.
12. A short tutorial to help you learn about and understand your Cintiq Pro Studio is available in the Tutorials section of the [Wacom Desktop Center](#).
13. Access FAQs and other product information on the

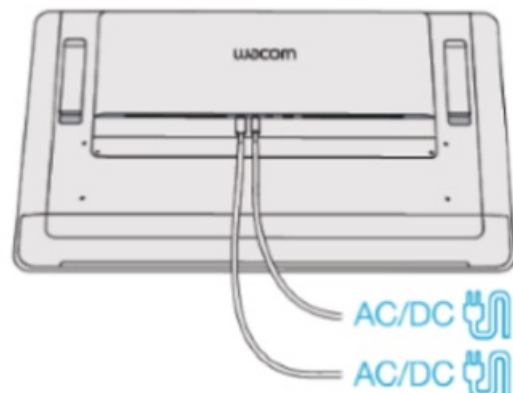
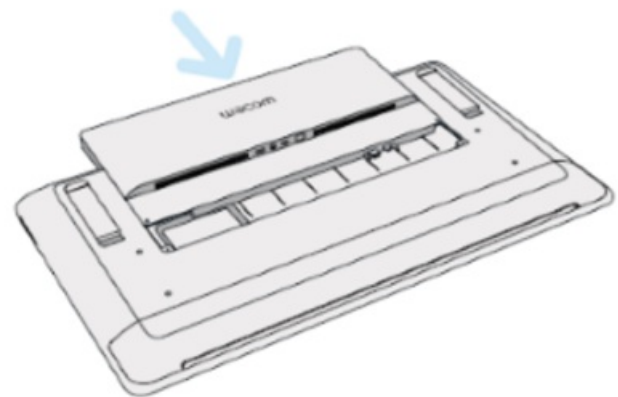
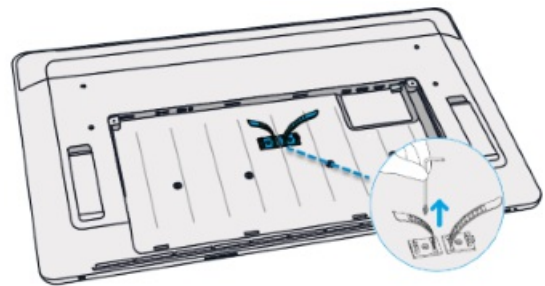

[Wacom Cintiq Pro Studio Getting Started](#) page of the Wacom website.

Calibration

For optimum performance, calibrate your pen display to align the screen cursor with the position of the pen on the screen. This is required to compensate for viewing angle, and to adjust for parallax.

1. Set up your pen display in its working position.
2. Open [Wacom Tablet Properties](#). If more than one pen display is installed on your system, select the one you are working with from the **Device** list.
3. Select a pen from the **Tool** list.
4. Select the **Calibrate** tab.

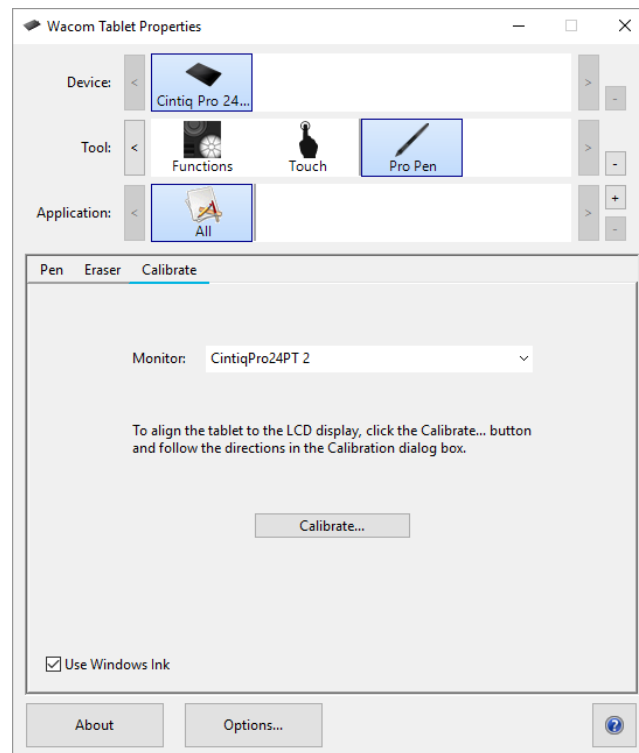

The above screenshot is for descriptive purposes; it may not match your screen.

5. If you are working with multiple monitors, select the monitor corresponding to your pen display from the dropdown menu.
6. Click **Calibrate...** to activate the calibration screen.
7. Holding the pen, sit or stand as you normally would when working with the pen display. Use the pen tip to click on the center of the crosshairs in the upper-left corner.
8. Click on the center of the crosshairs that are displayed in the remaining corners.
9. Test the alignment by positioning the pen at a few different points on the display.
10. Click **OK** to accept the calibration, or **Try Again** to recalibrate.

Work with your pen

All pen tablets and pen displays include a cordless, battery-free pen that you use to interact with your device. You can hold, write, and draw as you normally would with a pen or pencil.

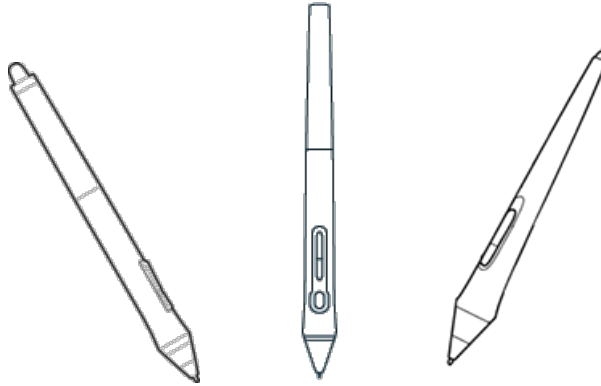

Pen styles vary depending on the pen tablet or pen display that you purchased.

Personalize your pen with a color ring

If your pen includes color rings, you can use them to identify and personalize your pen.

1. Unscrew the cone near the pen tip.
2. Remove the color ring that is already on the pen and slide on your preferred color ring.
3. Replace the cone.

Specialty pens

Pens designed for more advanced work, such as the Wacom Pro Pen 3D, Art Pen, or Airbrush, can be used with many pen tablets and pen displays.

To discover other pens and tools that can be used with your pen tablet or pen display, go to the [Wacom Store](#).

Use your pen

Use your pen to interact with your device. This includes drawing, writing, or moving items, and activating settings that you assign to pen buttons.

Tips:

- Hold the pen as you would normally hold a pen or pencil. Adjust your grip so that you can press any pen buttons easily with your thumb (recommended) or index finger without accidentally pressing it.
- To make it easier to access tools in applications like Adobe Photoshop, assign modifiers, such as Alt and Ctrl, to your pen buttons so that you do not have to use your keyboard keys.

! **Important:** You can customize [user options](#) that change the way your pen works with your device. Try both **Pen Button modes** to see which works best for you.

Pen tip and eraser

- **Draw or sign:** Draw or sign with the pen tip directly on the device surface.

Note: Pens are pressure-sensitive, so the harder you press, the thicker your lines and the denser the color.

- **Move the cursor:** Move the pen while holding it slightly above the device without touching the screen surface.
- **Double-click:** Quickly tap the screen twice in the same place with the pen tip.
- **Erase:** Flip the pen to the side opposite the pen tip and move the eraser over the area you want to erase, just as you would use the eraser on a pencil.

Note: Some pens do not have an eraser.

- **Select an item:** Tap the screen once with the pen tip.
- **Move an item:** Select the item with the pen tip, then slide the pen tip across the screen to move it.

Pen buttons

Use pen buttons as shortcuts to [settings](#). You can view and change the assigned settings on the **Pen** tab in [Wacom Tablet Properties](#).

Note: Some pens do not have buttons.

You activate settings differently depending on your [Pen Button mode](#).

- If your [Pen Button mode](#) is **Hover Click**, then hold the pen tip slightly above the surface of your device and press the button.
- If your [Pen Button mode](#) is **Click & Tap**, then touch the device surface and press the pen button.

If your pen has a long, thin button, press the upper part of the button for one setting and the lower part for another.

Store your pen

Store your pen properly keep it in good condition and help the pen tip last longer.

! **Important:** Store your pen so there is no pressure on the pen tip or eraser.

- If your device has a pen stand, store the pen with the tip down in the stand.
- If your device included a pen case, store the pen in the pen case.
- If your device has a pen sleeve, holder, or tray, the pen can be stored there.

Tip: Do not leave the pen on the device when you are not using the pen. This might cause issues when you are using a mouse and might prevent your computer from going to sleep.

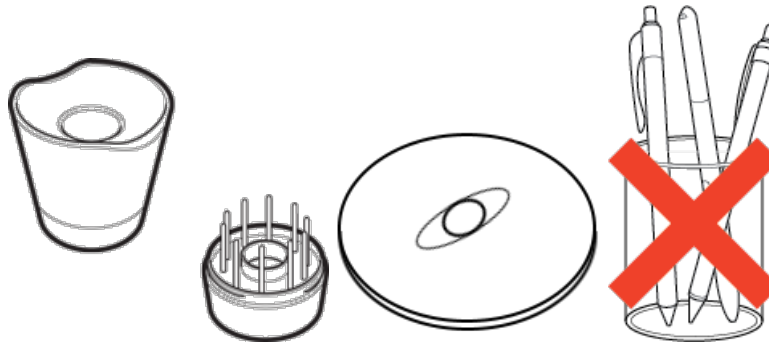

Pen stands vary depending on the pen tablet or pen display that you purchased.

Customize your pen functions

Customize your pen functions by assigning settings to pen buttons, adjusting the pen tip feel and pressure, and selecting how you perform a right-click.

Note: Some pens do not have buttons or an eraser.

Assign settings to the pen button and pen tip

1. [Open Wacom Tablet Properties.](#)

Note: The options available in Wacom Tablet Properties will vary depending on your device.

2. If there is a **Tool** row, select your pen.
3. Select the **Pen** tab.
4. For each of the pen buttons, select the setting you want from the drop-down menu next to the pen.
5. For the pen tip, double-click the pen tip in the image to display a drop-down menu. Then, select a setting for the pen to perform when you tap the tablet surface with it.

Warning: The tip must be set to **Click** in order to draw for most graphics applications.

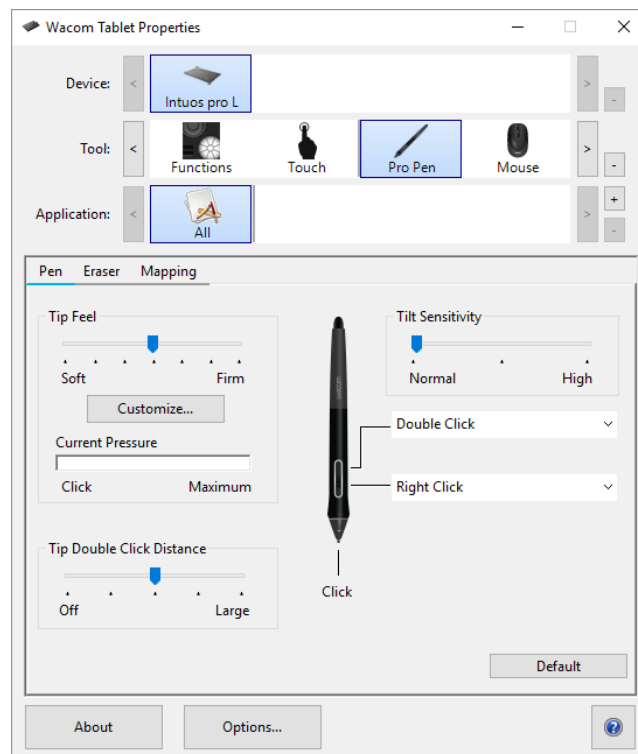

The above screenshot is for descriptive purposes, it may not match your screen.

Customize other pen properties

- **Tip Double Click Distance:** To change the distance between your pen and the tablet surface during a double-click, move the slider.
- **Current Pressure:** To see how hard you need to press with the pen, check your Current Pressure by pressing down with the pen tip or eraser in an empty area of the Wacom Tablet Properties window.

- If you want to change the amount of pressure you need to use the pen tip or eraser, move the **Tip Feel** and **Eraser Feel** sliders.
- **Options**: To select the way you right-click with the pen, click Options and select a different **Pen Button Mode**.
- **Tilt Sensitivity**: To change how much the tilt of your hand affects your pen strokes, drag the slider. Open an application that supports tilt to test while you are adjusting, so you can see how your changes affect your strokes.
- **Pen Feel Details**: To change the tip sensitivity, click **Customize** and adjust advanced pen and eraser options.

Tips:

- Set the pen tip to **Click** and one of the pen buttons to **Double-Click**.
- If you want a narrower range of pressure values in a pressure-sensitive application, select a soft **Tip Feel**.
- If the pen overreacts to slight pressure, try a firmer **Tip Feel** setting.
- If you notice a delay at the beginning of brush strokes, inking strokes, or drag actions, try a smaller **Tip Double Click Distance** or set a pen button to double-click instead of the pen tip.
- You can return the pen to default settings by going to the **Pen** tab in [Wacom Tablet Properties](#) and clicking **Default**.

Eraser

Select the Eraser tab to adjust eraser sensitivity.

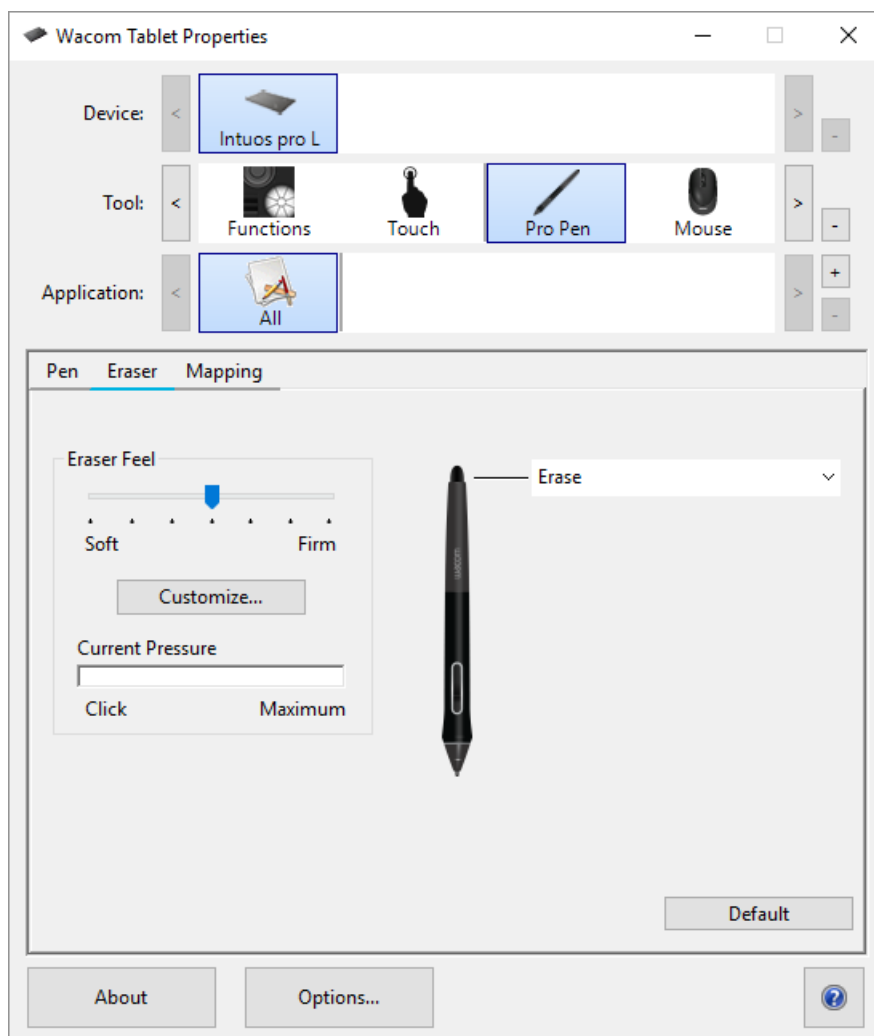

The above screenshot is for descriptive purposes it may not match your screen.

- Use the **Eraser Feel** slider to customize the amount of pressure needed to erase.
- From the **Erase** dropdown menu, select the function to perform when using the eraser.
- Click **Customize** to further adjust the eraser sensitivity.
- With your screen cursor positioned over an empty area of the control panel, press down on the **Current Pressure** bar with the eraser to determine pressure levels.

Replace the pen nib

Tip: Replace your pen nib when it is approximately 1 mm (1/25 inch) or has a sharp edge.

1. Grab the old nib and pull it out of the pen.

You can use the nib removal tool or the hole in the stand, case, or pen end, depending on what was included with your device.

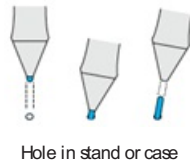

2. Get a replacement nib and slide the end of the new nib straight into the barrel of the pen.

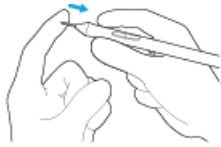

3. Push the nib in slowly and firmly until it stops.

Where to find replacement nibs

The extra nibs are stored in different places for different devices. First, look in the box that your device was packaged in. If you do not see the nibs there, try these places.

- If your device included a pen case, check there.
- If your device has a removable compartment cover on the back, slide it open.
- If your device included a pen stand, unscrew the pen stand.
 - **Tip for the Pro Pen 2 stand:** To screw the stand back together, line up the dots on the bottom of the stand and the recess. Then, gently guide the bottom of the stand to the right until you feel it click into place.

If you need more nibs, you can purchase them from the [Wacom Store](#).

Where to find the nib replacement tool

- For some devices, the nib replacement tool is a metal ring included with your device.
- Otherwise, use the small hole in pen stands and cases as the nib removal tool.

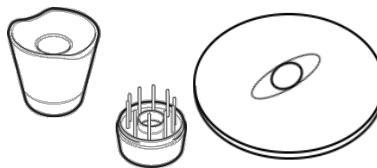

Pen stands vary depending on the pen tablet or pen display that you purchased.

Use your pen with Windows Ink

Take advantage of a wide variety of features supported by Microsoft Windows, including Windows 7, Windows XP, and Windows Vista. Additional features are supported by Windows 10 and the Windows Ink Workspace.

- **Handwriting recognition:** Convert your handwritten content to typed text.
- **Digital Ink** (Microsoft Office 2007 or later): Use the enhanced digital mark-up and inking tools found on the Review tab in applicable applications.
- **Windows Input Panel:** Use handwriting or an on-screen keyboard to directly enter text with your Wacom pen.

Note: The Pen Flicks and press-and-hold-to-right-click features are disabled in some graphics applications.

Windows Ink is ON by default. If you want to turn OFF Windows Ink, unselect **Use Windows Ink** in [Wacom Tablet Properties](#).

Advanced pen and eraser

To further customize tip or eraser pressure settings, select the Pen or Eraser tab and then click the **Customize** button. Options within the Pen Feel Details dialog let you independently change the tip or eraser pressure sensitivity and click threshold settings.

Note: The available features on your pen may vary depending on your device.

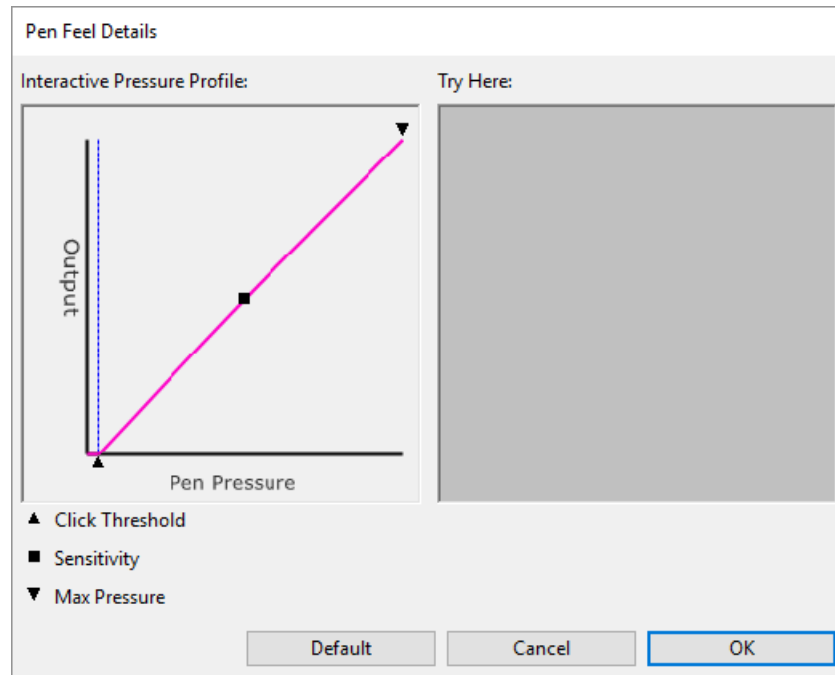

- The **Pen Feel Details** dialog shows the selected pressure sensitivity curve and click threshold settings. Move the pressure controls to change the settings.
- **Click Threshold** determines the amount of force required to register pressure or generate a pen click.
- **Sensitivity** changes the slope of the pressure response curve.
- **Max Pressure** determines how hard you must press the pen tip to reach maximum pressure.
- Using your pen tip or eraser, make several strokes within the **Try Here** box to test the results of your changes.
- A curve that increases quickly makes the pen feel more sensitive.

Note: In the Pen and Eraser tabs, pressure and sensitivity settings are adjusted with the **Tip Feel** or **Eraser Feel** slider, which will override the advanced pressure settings.

Customize your device in Wacom Tablet Properties

You can customize your device, pen, and other tools in Wacom Tablet Properties so that they work the way you want. [Open Wacom Tablet Properties](#) to view the settings [you can customize](#).

Note: The options available in Wacom Tablet Properties will vary depending on your device.

What can I customize in Wacom Tablet Properties?

- Assign **Functions** to components like ExpressKeys™, Touch Rings, Rocker Rings, Touch Strips, pen buttons, and the pen tip.
- Select the settings that you want **Touch** gestures to activate.
- Assign settings that change depending on which application you are using by creating **Application Specific** settings.
- Create and assign **On-Screen Controls**, such as Screen Key panels and Radial menus.
- Define which devices to switch between when you **Display Toggle**, if you are using multiple devices or monitors.
- Return the settings on the tab that you are viewing to **Default** settings.
- Set advanced **Options**, such as how your pen tip performs clicks.

Where can I access settings and other options in Wacom Tablet Properties?

- **Device list**
 - There is an icon in this list for each device that is currently connected to your computer. To add a new device to this list, connect it to your computer.
 - Select a device from the **Device** list to view the **Functions** and **Touch** settings for it.
 - For some products, the Device List will not be present when only one tablet is attached.
- **Tool list**
 - There is an icon in this list for each tool that you recently used on this device. To add a new tool to this list, use the tool on your device.
 - Select a tool to view the settings for it.
 - Select **Functions** to view the settings for the device that you selected from the Device list, such as settings for ExpressKeys™ and Touch Rings.
 - For some products, the Tool List will not be present.
- **Application list**
 - Select **All** from the **Application** list to view the settings that apply across all applications.
 - If you created [Application Specific Settings](#), select an application icon from the **Application** list to view the settings that are specific to that application.
- **About button:** Select **About** to view software version information and access the **Diagnose** tool that can help you test your device.
- **? icon:** Select the ? icon to view User Help topics for the settings that you are currently viewing.

Open Wacom Tablet Properties

Once you open [Wacom Tablet Properties](#), you can view customizable settings for your device and tools.

Note: The tabs and options that you see in Wacom Tablet Properties will vary depending on your device.

To open Wacom Tablet Properties:

- **Windows and Mac:** If supported by your device, you can open Wacom Tablet Properties from the **Wacom Desktop Center**. Click on the name of your device under **My Devices**, and then select one of the settings.
- **Windows 10:** Click on the Windows Start button and select **Wacom Tablet > Wacom Tablet Properties**.
- **Windows 8.1:** Right-click in the bottom left-hand corner of the Start screen. Select **Wacom Tablet > Wacom Tablet Properties**.
- **Windows 8.1 Classic View:** Press the Windows key on your keyboard or select the Windows icon in the Charms bar to access the Start screen. Right-click in the bottom left-hand corner of the screen. Select **Wacom Tablet > Wacom Tablet Properties**.
- **Windows 7:** Click on the Windows Start button and select **All Programs**. Select **Wacom Tablet > Wacom Tablet Properties**.
- **Mac:** Open **System Preferences** from the Apple menu or from the Applications folder and click on the **Wacom Tablet** icon.

Assign settings in Wacom Tablet Properties

You can set a customizable component of your device to perform a specific function so that you can easily access your frequently used settings. Some examples of customizable components are ExpressKeys™, pen buttons, the pen tip, Touch Rings, Rocker Rings, On-Screen Controls, touch gestures, and Touch Strips.

Note: The customizable components and the options available in Wacom Tablet Properties may vary depending on your device.

1. Open Wacom Tablet Properties.

- **Note:** Make sure that your device is connected to your computer or Wacom Tablet Properties will not open.

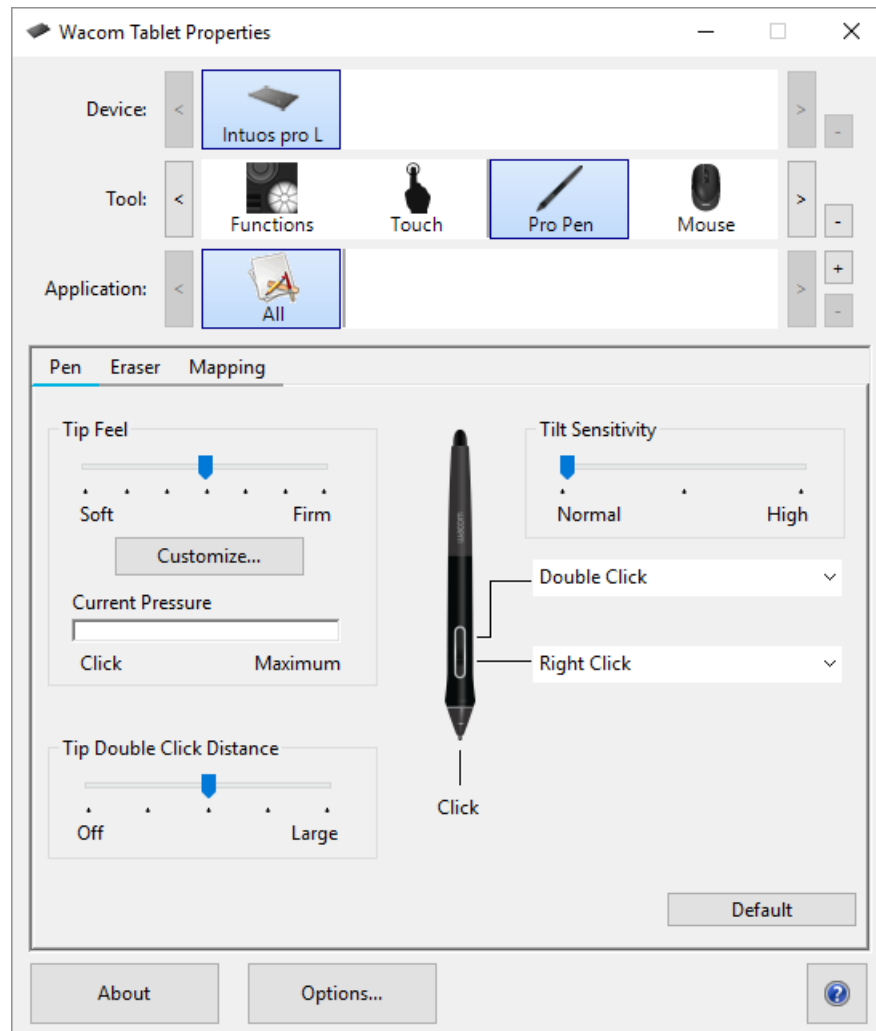

The above screenshot is for descriptive purposes; it may not match your screen.

2. Select your **Device**.

- Any settings that you customize apply to this device only, except for On-Screen Controls.
- For some products, the Device List will not be present when only one tablet is attached.

3. Select the **Tool** you want to customize.

- If you want to assign settings to customizable components, like ExpressKeys™ or On-Screen Controls, select **Functions** from **Tools**.
- If you want to assign settings to your pen or touch, choose the corresponding icon from **Tools**.
- For some products, the Tool List will not be present.

4. Select the tab of the component you want to change.
5. From the drop-down menu next to the component that you want to customize, select the [setting](#) that you want to assign to it.
 - Any changes you make take effect immediately.
6. Engage the component that you customized, and the setting that you assigned is performed.

Tip: You can assign settings that [apply only in a specific application](#).

Example of assigning a setting in Wacom Tablet Properties

Here is how you can customize a pen button to **Zoom In**.

- Open Wacom Tablet Properties.
- Select your pen from the **Tool** list.
- Select the **Pen** tab.
 - An image of your pen is displayed on the tab.
 - Each pen button has a drop-down menu next to it that tells you the current setting assigned to it.
- From the drop-down next to one of the pen buttons, select **Zoom In**.
- Press that pen button, and your application zooms in.

What settings can I assign?

You can change the settings assigned to ExpressKeys™, Touch Rings, On-Screen Controls, pen buttons, and other customizable components of your device in [Wacom Tablet Properties](#). Then, when you engage that component, such as pressing an ExpressKey or pen button, the function that you assigned to it is performed.

Refer to this list of settings to help you decide if you want to change any settings that are already assigned.

Note: The available features and customizable components in this list may vary depending on your device. Refer to the drop-down menus on the **settings** tabs in [Wacom Tablet Properties](#) to see which options are available for the components specific to your device.

 **Warning:** Make sure that the **Click** setting is assigned to at least one customizable component so you can always navigate and click.

4th click or 5th click	Performs a 4th or 5th mouse button click.
Application Defined	The application you are working in assigned a setting for this component.
Auto Scroll/Zoom	Assign this setting to the Touch Ring to zoom in most graphics applications or scroll in most other applications. Refer to the documentation for the application you are working in to see which setting has been assigned.
Back	Returns you to the previous step, similar to how Back works in browsers.
Click	Performs a mouse button click.
Click Lock	<p>Presses and holds the mouse button.</p> <ul style="list-style-type: none"> Begin the click lock by engaging a component, and then engage it again to release it. For example, if Click Lock is assigned to a pen button, press the pen button once to begin Click Lock and press it again to release the lock. <p>Tip: Click Lock is helpful when you are dragging objects and selecting blocks of text.</p>
Default	Resets the component to its default setting.
Disabled	Disables the component so that when you engage the component, such as pressing the pen button, nothing happens.
Display Toggle	Toggles between your devices and monitors, if you are using your device with multiple monitors or devices.
Double Click	<p>Performs a double-click.</p> <p>Tip: For easier double-clicking, assign this setting to a component, such as a pen button, instead of tapping twice with the pen tip.</p>
Erase	<p>Sets your strokes with the pen to erase instead of draw.</p> <p>For example, if you assign Erase to your pen button, you can move your pen over an area you want to erase while pressing the pen button.</p>
Forward	Directs you to a step ahead of where you are in your history, similar to how Forward works in browsers.
	Toggles Ink on and off.

<p>Ink Toggle (Mac)</p>	<ul style="list-style-type: none"> When Handwriting recognition is turned on, Ink recognizes and converts your handwriting into text and inserts it into a document.
<p>Keystroke</p>	<p>Performs the keystroke or combination of keystrokes that you assign.</p> <p>When you select Keystroke, the Define Keystroke window appears so you can select a keystroke or create a keystroke combination.</p>
<p>Launchpad</p>	<p>Displays the Launchpad menu, where you can start applications.</p>
<p>Middle Click</p>	<p>Performs a middle mouse button click.</p>
<p>Mode Toggle</p>	<p>Assign this setting to a pen button to toggle between Pen mode and Mouse mode.</p> <ul style="list-style-type: none"> When you first set a pen button to Mode Toggle, the Mouse Mode window appears. Move the sliders to adjust the mouse acceleration and speed. In Pen mode, you use the pen like a regular pen. The cursor jumps to the point where you place your pen, and you define which portion of your device maps to which portion of your monitors. In Mouse mode, you use the pen like a mouse. The cursor stays on the point you left it when you pick up your pen, and you interact with your device like you interact with a mousepad.
<p>Modifier</p>	<p>Performs a modifier (Shift, Alt, Ctrl, Option, Command) plus a mouse button click or mouse wheel scroll.</p> <ul style="list-style-type: none"> When you select Modifier, the Define Modifier window appears. Select the modifier and then select a mouse button click or mouse wheel scroll to assign that combination.
<p>On-Screen Controls</p>	<p>Displays the On-Screen Control that you select.</p> <ul style="list-style-type: none"> When you select On-Screen Controls, the list of Screen Key panels, Radial Menus, and Keypads from the On-Screen Controls tab appears. Select the On-Screen Control that you want to assign.
<p>On-Screen Keyboard</p>	<p>Toggles the Windows On-Screen Keyboard open and closed.</p>
<p>Open/Run</p>	<p>Opens or runs the application, file, or a script you choose.</p> <ul style="list-style-type: none"> When you select Open/Run, the Run Application window appears. Click Browse and select the item. Click OK.
<p>Pan/Scroll</p>	<p>Allows you to pan or scroll in a document or item by moving the pen tip up and down or right and left.</p> <p>When you select Pan/Scroll, the Scroll Speed window appears. Move the slider to your preferred scrolling speed.</p>
	<p>Pans or zooms, depending on whether you are hovering or touching the device surface.</p> <ul style="list-style-type: none"> To pan, hover above (but do not touch) the device surface, and then press and hold the button while moving your pen. To zoom, press and hold the button while touching the device surface and move the pen towards the top

<p>Pan/Zoom</p>	<p>to zoom out or towards the bottom to zoom in.</p> <ul style="list-style-type: none"> ◦ If you pick up your pen to hover, zooming stops. As long as you continue to hover and hold the button, you can still zoom when you touch the pen tip to the surface again. • If you want to pan again after zooming, release the button and press it again. <p>Notes</p> <ul style="list-style-type: none"> • If the application does not support Pan/Zoom, the following happens instead: <ul style="list-style-type: none"> ◦ Pressing the button while hovering activates a Ctrl + Right-Click. ◦ Pressing the button while touching the surface activates a mouse wheel scroll. • When you select Pan/Zoom to assign it to a button, the Zoom Speed window appears. Move the slider to your preferred zooming speed. • Changing the pen button mode does not affect this setting.
<p>Precision Mode</p>	<p>Toggles between normal precision and a precision that you choose, from Fine to Ultra Fine.</p> <ul style="list-style-type: none"> • In the Precision Mode window that appears, move the slider to set the precision that you toggle into. • For example, if you assign Precision Mode to a pen button, when you press the pen button, you switch to working in the precision that you selected from the slider. When you press the pen button again, you switch back to working in the normal precision.
<p>Pressure Hold</p>	<p>Locks the pressure at the current level until you release the component.</p> <p>For example, if you assign this setting to a pen button, you can paint with pressure sensitivity enabled in your application until you reach the brush size you like. Then, press and hold the pen button to lock in that brush size as long as you are pressing and holding the button.</p>
<p>Right Click</p>	<p>Performs a right mouse button click.</p>
<p>Scroll</p>	<p>Scrolls when you use the Touch Ring.</p>
<p>Scroll Down</p>	<p>Scrolls your active application down.</p>
<p>Scroll Up</p>	<p>Scrolls your active application up.</p>
<p>Settings</p>	<p>Displays the current settings of your customizable components, including ExpressKeys™, the Touch Ring, pen, and touch.</p> <p>Click on any item that displays to open Wacom Tablet Properties so you can adjust setting assignments, if desired.</p>
<p>Show Desktop</p>	<p>Minimizes all open windows so you can view your desktop.</p>
<p>Skip</p>	<p>Assign this setting to the Touch Ring center button so you can skip one of the settings that you assigned to the Touch Ring.</p>
<p>Switch Application</p>	<p>Toggles between the applications that you have open.</p>
<p>Tablet PC Settings</p>	<p>Displays the Tablet PC Settings menu.</p>

Touch On/Off	<p>Toggles touch on and off.</p> <p>This setting is not available on devices that have a built-in touch on/off switch or button.</p>
Tumble	<p>Tumbles, orbits, or rotates items in 3D applications.</p> <p>If the application does not support Tumble, pressing the button activates a middle-click instead.</p>
Zoom	<p>Zooms the active application on your computer.</p> <p>Assigned to a Touch Ring: Slide your finger around the ring clockwise to zoom in and counterclockwise to zoom out.</p> <p>Assigned to a pen button or ExpressKey: Press and hold the button while touching the pen tip to the device surface and move towards the top to zoom out or towards the bottom to zoom in. If you pick up your pen to hover, zooming stops. As long as you continue to hover and hold the button, you can still zoom when you touch the pen tip to the surface again.</p> <p>Notes</p> <ul style="list-style-type: none"> • If the application does not support Zoom, pressing the button activates a mouse wheel scroll instead. • When you select Zoom to assign it, the Zoom Speed window appears. Move the slider to your preferred zooming speed. • Changing the pen button mode does not affect this setting.
Zoom In	Zooms your active application in.
Zoom Out	Zooms your active application out.

Assign keystrokes

You can assign keystrokes to customizable components of your device, like ExpressKeys™ and pen buttons. As a result, pressing a button on your device performs the specified function instead of pressing the keystroke on your keyboard. You can also assign a combination of keystrokes, so you only have to press one button instead of an entire keystroke combination.

1. Go to [Wacom Tablet Properties](#).
2. Select **Keystroke** from the drop-down menu of one of your device's customizable components. The **Define Keystroke** window appears.

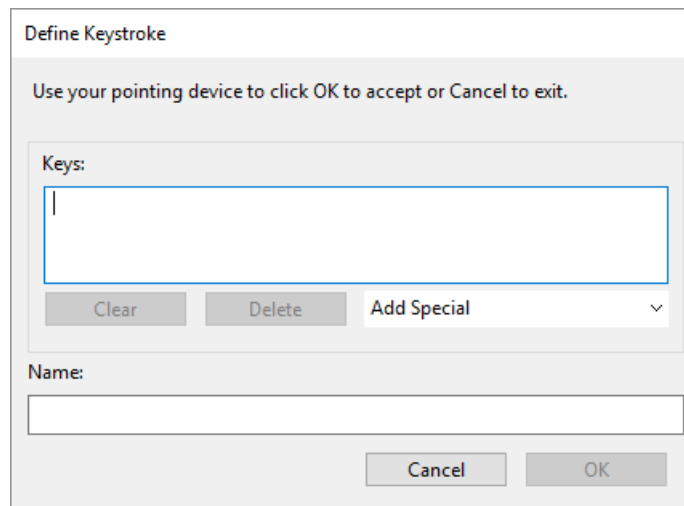

3. In the **Keys** box, enter the keystroke that you want to assign. If you want to assign a combination of keystrokes, enter each keystroke that you want in the combination.
 - You can enter letters, numbers, function keys, and modifier keys. You can also choose combinations from the **Add Special** drop-down.
 - Click **Delete** to remove only the last keystroke you entered.
 - Click **Clear** to remove all the keystrokes you entered so you can start over.

Note: Two **Keys** boxes appear for Touch Rings and mouse wheels. Enter the keystroke for clockwise or forward wheel movement in the first box and counterclockwise or backward wheel movement in the second box.

4. Enter a **Name** for your keystroke and click **OK**.
 - The name appears on On-Screen Controls, in Wacom Tablet Properties, and in Settings view, so enter a name that indicates the keystroke you assigned.
 - If you are assigning numbers to a Keypad, it is best practice to name the Keystroke the number that you assigned. For example, if you assign the number 8 to a Keypad button, name the Keystroke **8**.

Tip: You can assign different keystroke combinations to [the same customizable component for different applications](#).

To learn which keystroke combinations are built-in as shortcuts for a particular application, refer to the documentation for the application.

ExpressKeys™

Your device may have shipped with a ExpressKey Remote which can be configured to trigger [ExpressKey](#) functions.

If not included, one can be purchased from the [Wacom Store](#).

Touch Ring

Your device may have shipped with a ExpressKey Remote which can be configured to trigger [Touch Ring](#) functions.

If not included, one can be purchased from the [Wacom Store](#).

Settings View

You can view the current settings for the ExpressKeys™, Rocker Ring, Touch Ring, Center or Home button, Touch Strips, Touch on/off, and the pen for your Pen Display at any time. Your display will vary, depending on model.

To use Settings View:

- In the **Tablet Properties** ExpressKeys™ tab, set an ExpressKey to **Settings**.
- To view the settings on the screen, press that ExpressKey.
- To close the Settings View screen, click on it with your mouse, tap it with your pen, or press the ExpressKey a second time.
- To open the **Tablet Properties** tab for **ExpressKeys™**, **Pen**, or **Touch**, click the **Properties...** button for that item on the Settings View screen.

If an ExpressKey has been disabled it will be displayed as disabled.

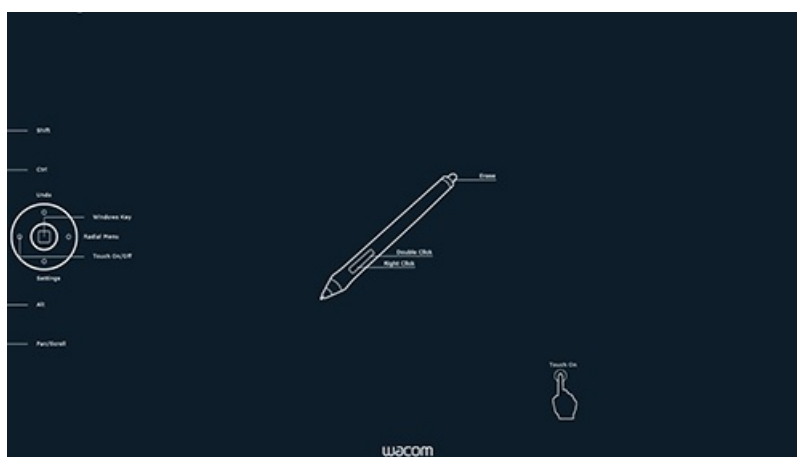

The above screenshot is for descriptive purposes, it may not match your screen.

Note: Some applications can override and control the ExpressKey functions.

Display Toggle

Display Toggle is available when working on multiple monitor systems. This feature allows you to work with your pen display on all other connected displays, or on one display at a time.

In [Wacom Tablet Properties](#), the Display Toggle tab is automatically available when your pen tablet is installed on a multi-monitor system. This tab lets you select the monitor(s) to be included in the toggle sequence.

After setting an ExpressKey or pen button to Display Toggle, you can use it to toggle the current tablet mapping between a base mapping and other monitors. The display options are:

- **Pen display to desktop** toggles the screen cursor from your pen display to the entire system desktop. Press the button a second time to return the cursor to pen display.
- **Pen display to other displays** toggles the screen cursor from your pen display to another active pen display or monitor. The cursor toggles to each connected display in turn, then returns to the device where the first toggle began.

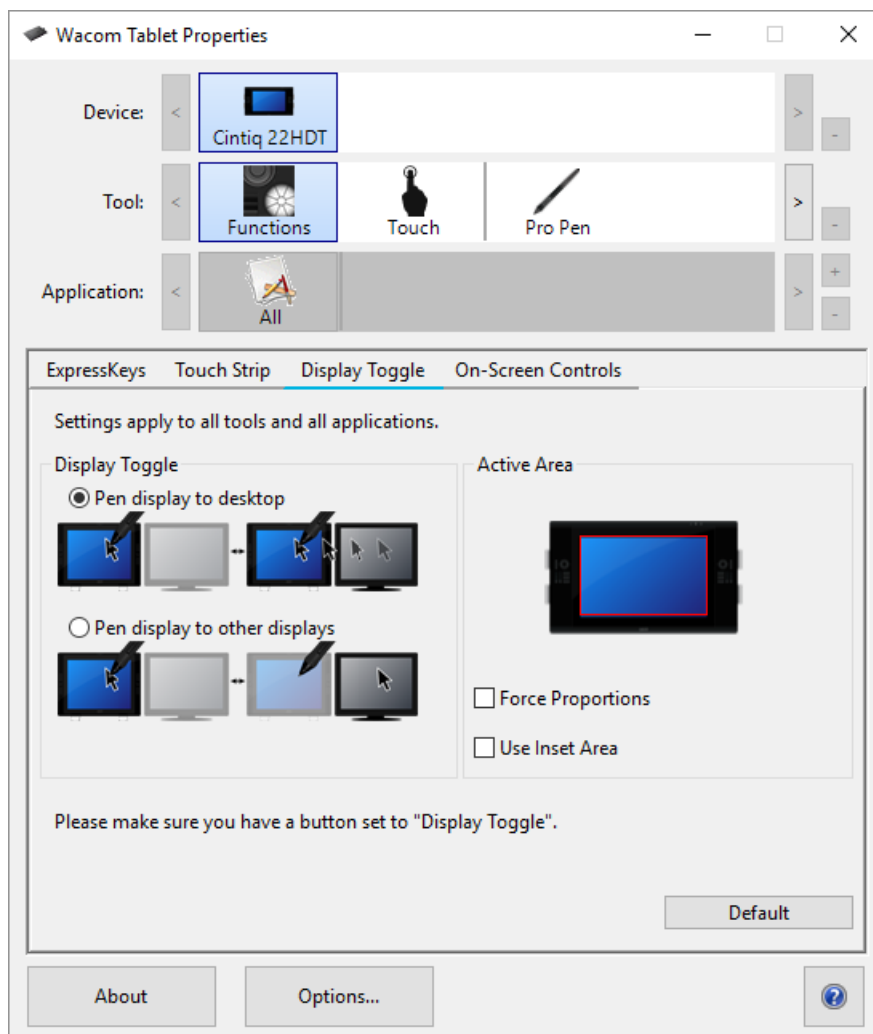

The above screenshot is for descriptive purposes, it may not match your screen.

- **Active Area** options determine the size of the area where the pen will function on the pen display.
- **Force Proportions** adjusts the size of the active area to maintain correct vertical and horizontal proportions between your pen display and the entire desktop or display. Depending on your settings, some portions of the active area may no longer be usable when this option is selected. When deselected, the correct scale or proportions are not maintained.
- **Use Inset Area** limits the active area to a sizing of 6 x 8 inches. If **Force Proportions** is also selected, this sizing may be

less. When deselected, as much of the active area as possible will be used for tablet-to-display mapping.

Important: When using application-specific settings with Display Toggle, be sure that each customized application in the **Application** list (including **All Other**) has a tool button or ExpressKey assigned to Display Toggle.

Any of the following actions will return the toggle sequence to the base mapping:

- Launching a graphics application that supports pressure sensitivity.
- Logging out of or rebooting the system.
- Switching users.
- Placing the system in sleep mode.
- Changing the Display Toggle settings.
- Changing the resolution or number of displays on your system.
- Using the Mode Toggle... function.
- Selecting Pen Mode or Mouse Mode from On-Screen Controls.

Note: The Display Toggle feature is not available on devices in mobile mode.

Customize user options

Click on **Options** in [Wacom Tablet Properties](#) to customize pen button mode and other preferences for your device.

Note: The available options may vary depending on your device.

- **Hover Click** is the default and allows you to click by pressing the pen button while holding the pen tip slightly above the device surface.
- Select **Click & Tap** if you want to click by pressing the pen button and tapping the pen tip to the device surface.
 - Choose this option for more precise placement of clicks.
- Move the **Brightness Adjustment** slider to adjust the brightness level or to turn off status LEDs and active area markers.
- If you are using graphics applications that support a maximum of 1024 levels of pressure, select **Pressure Compatibility**.
- For devices that support wireless, select **Show wireless tablet battery** if you want to display the battery status icon in your system tray during wireless operation.
- For devices that have ExpressKeys™ on both the right and left sides and that are connected to a macOS computer, change the **Handedness** to swap the ExpressKey settings.

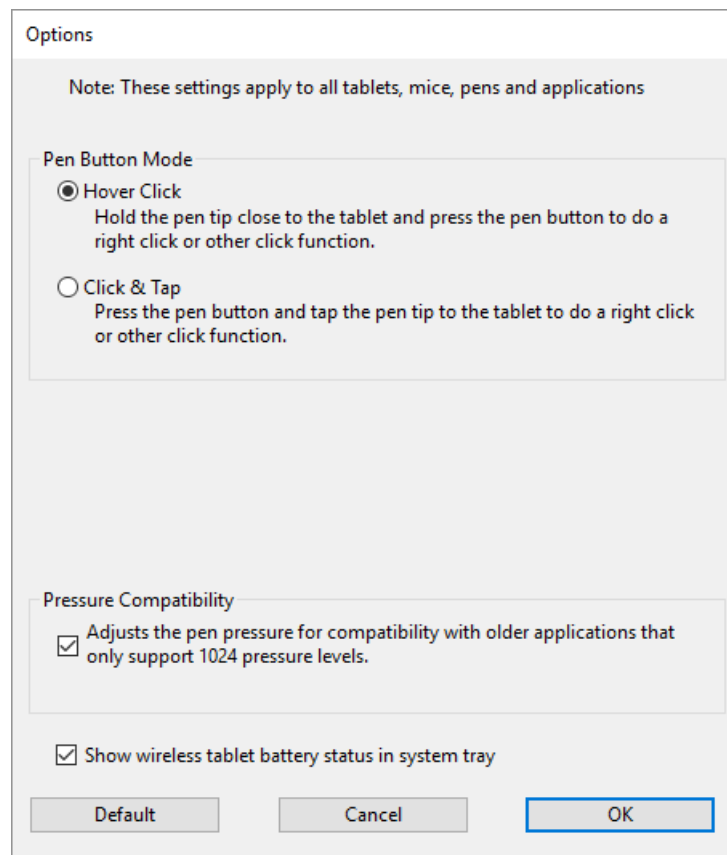

The above screenshot is for descriptive purposes; it may not match your screen.

Use On-Screen Controls as shortcuts

On-Screen Controls are menus that display on your pen display screen or monitor. You can use On-Screen Controls as shortcuts to the settings that you use the most.

How to create and use an On-Screen Control

1. Create a new [On-Screen Control](#).
2. Assign settings to the [Radial Menus](#), [Screen Keys](#) and [Keypads](#) that you created.
3. [Assign the On-Screen Control to a customizable component](#) of your device, such as an ExpressKey™ or pen button.
4. Press the button, ExpressKey™, or other component to open the On-Screen Control.
 - For example, if you assigned an On-Screen Control to an ExpressKey™, press the ExpressKey™ to display the On-Screen Control.
5. Click a button or slice in the On-Screen Control to activate the setting you assigned.
 - For example, if you assigned **Zoom In** to a Screen Key, click that Screen Key to zoom in.

Tip: Instead of opening the On-Screen Control every time you need it, you can select the push pin icon to keep it open at all times.

On-Screen Control layouts

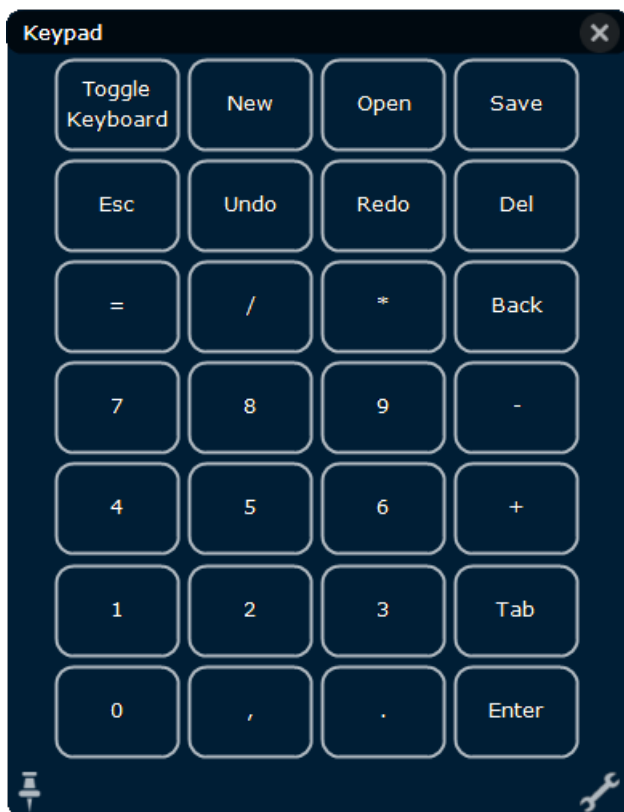

Keypad: A Keypad is a similar to your keyboard keypad, displayed on your monitor.



Screen Key panel: A Screen Key panel is a row of buttons that displays in the layout you choose.



Radial menu: A Radial menu is a circle split into slices, and each slice has its own setting.

Tip: You can select the wrench icon to open [Wacom Tablet Properties](#).

Create On-Screen Controls

You must first create a new On-Screen Control, or copy an existing one, and then you can [assign settings to it](#).

! Important: On-Screen Controls are not specific to a device. You can assign them to a customizable component of any device that appears in Wacom Tablet Properties.

1. Open [Wacom Tablet Properties](#).
2. Select **Functions** from the **Tool** list.
3. Select the **On-Screen Controls** tab.

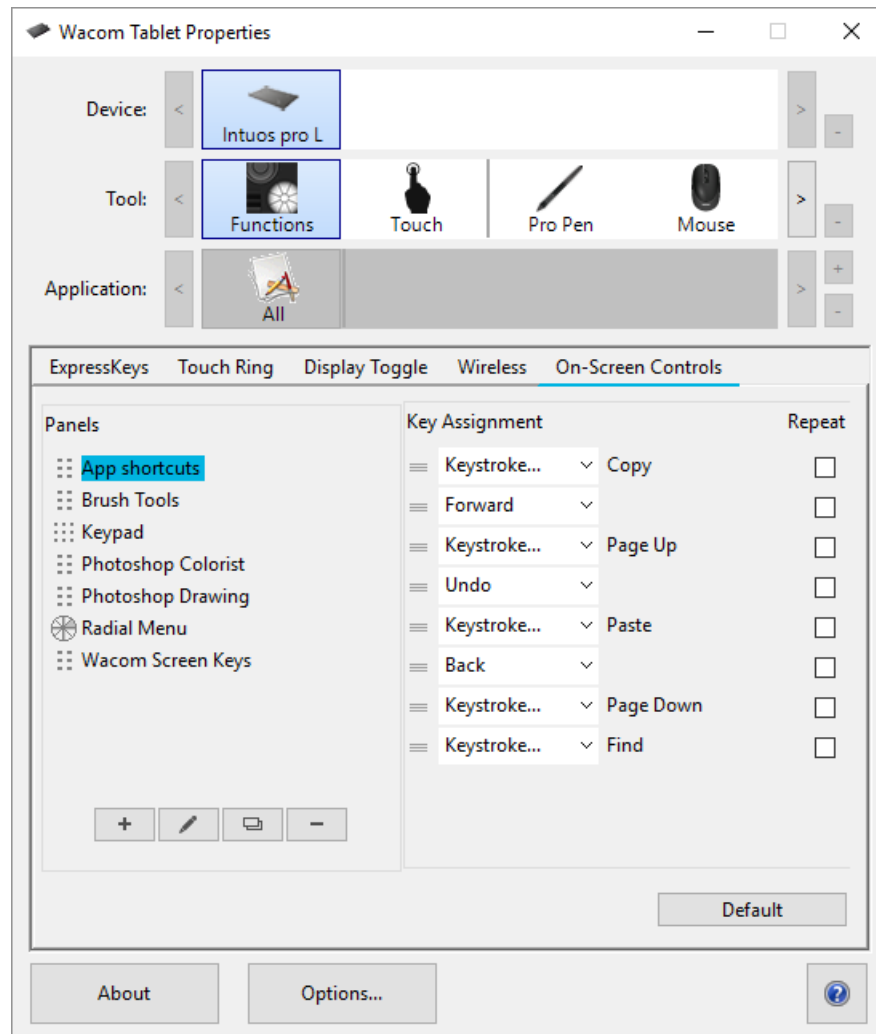

The above screenshot is for descriptive purposes; it may not match your screen.

4. Select if you want to create a new On-Screen Control or select if you want to copy an existing one.

Note: You can also select an existing On-Screen Control and click to edit it or to delete it.

5. In the window that appears, enter a **Name** and select a **Layout** by clicking one of the layout buttons.

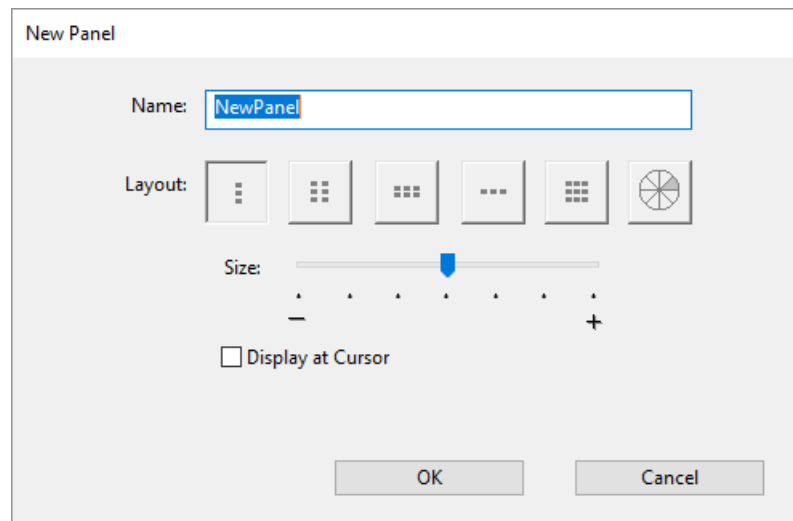

- You can move the **Size** slider to change the size of the On-Screen Control when it appears on your screen.
- You can select **Display at Cursor** if you want the On-Screen Control to appear next to your cursor when you open it. If you do not select this, the On-Screen Control appears in the same location every time you open it.

6. Click **OK**.

- The On-Screen Control that you just created appears in the **Panels** list on the **On-Screen Controls** tab.

7. Assign settings to your [Radial Menus](#), [Screen Keys](#) and [Keypads](#).

Tip: You can create an On-Screen Control and then switch the layout whenever you want.

- From the **Panels** list, select the On-Screen Control that you want to change.
- Click  to edit.
- Select a new layout, and click **OK**.

If you switch to an On-Screen Control that has fewer settings than your original one, your settings are not lost. For example, if you create a Keypad and then change it to a Radial Menu, your first eight settings display in the Radial menu. If you switch back, all of your original Keypad settings are still there.

Assign settings to Radial Menus and Screen Keys

After you [create a Radial Menu or Screen Key panel](#), you need to assign settings to the buttons and slices. You can change the settings at any time if you decide that you want different settings.

- In Wacom Tablet Properties on the **On-Screen Controls** tab, select the name of the On-Screen Control in the **Panels** list.
 - A drop-down menu for each button in your On-Screen Control displays under **Key Assignment**.
- Select the [setting](#) that you want to assign to each button from the drop-down menus.
 - You must assign a setting to at least one button. For any buttons that you do not want to use, select **Disabled**.
 - If you select **Keystroke**, you are prompted to [select a keystroke or create a keystroke combination](#).

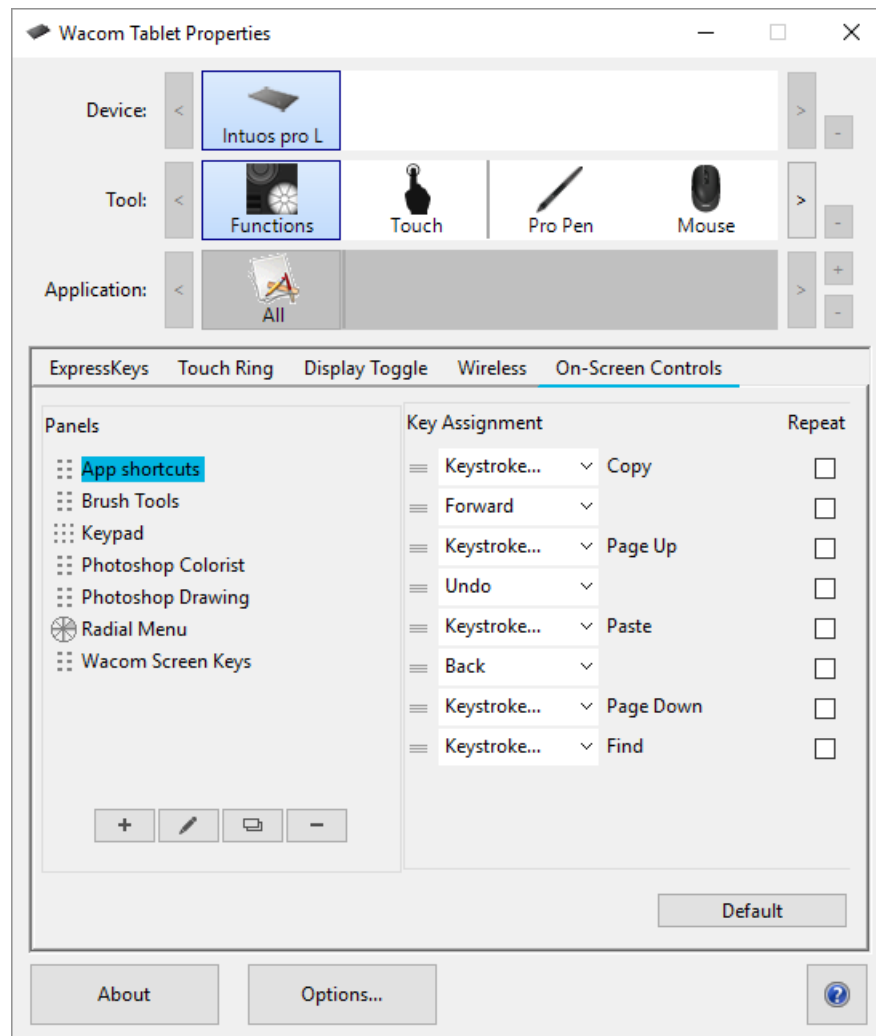

The above screenshot is for descriptive purposes, it may not match your screen.

- Change any of the optional features:
 - To change the order of the settings, click  and drag it to a new position.
 - If you want the setting to repeat when you click and hold the On-Screen Control button, select **Repeat**.

Important: [Assign your On-Screen Control to a customizable component](#), like an ExpressKey or pen button, so that you can open it when you want to use it.

Assign settings to Keypads

After you [create a Keypad](#), you can change the settings assigned to the buttons so that the Keypad includes the settings you want.

- In Wacom Tablet Properties on the **On-Screen Controls** tab, select the name of the Keypad in the **Panels** list.
 - An image of a Keypad appears under **Key Assignment** with default settings assigned to it.

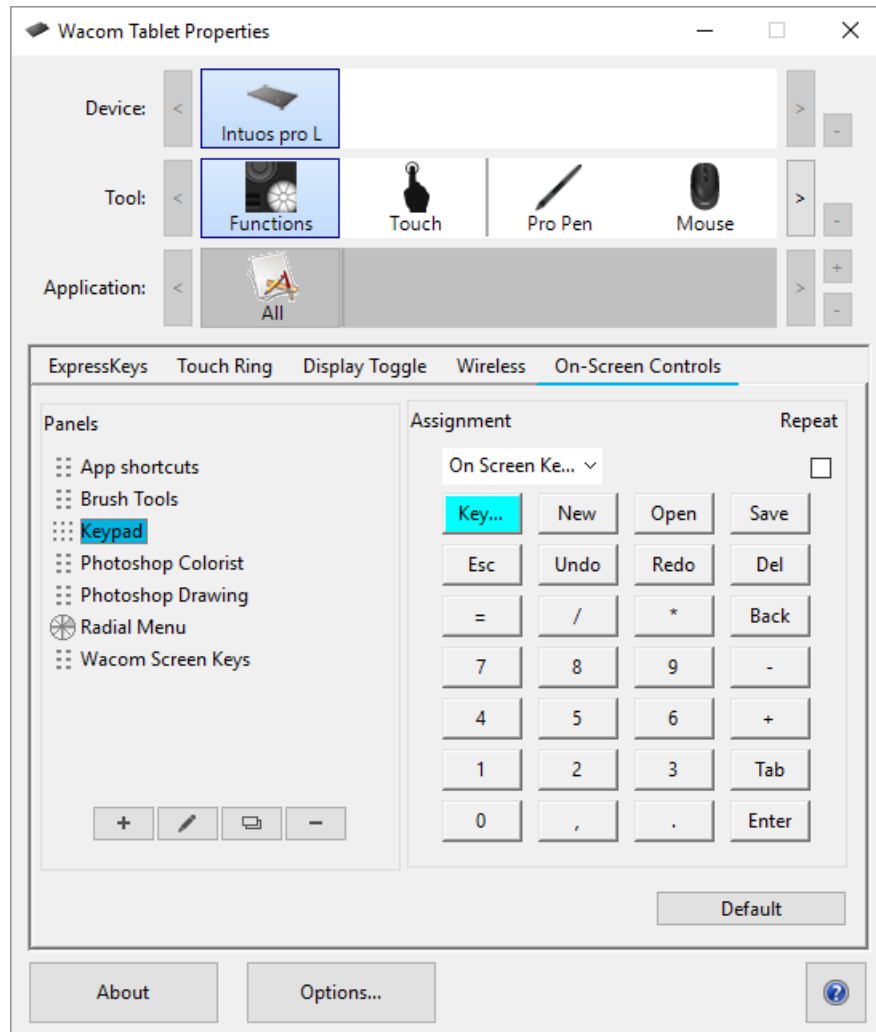

- Click a Keypad button that you want to change.
- Select the [setting](#) that you want to assign from the **Assignment** drop-down above the Keypad.
 - To assign numbers, select **Keyboard > Keystroke**. When you select **Keystroke**, you are prompted to [select a keystroke or create a keystroke combination](#).
 - If you want the setting to repeat when you press and hold the Keypad button, select **Repeat**.
 - You must assign a setting to at least one button. For any buttons that you do not want to use, select **Disabled**.

[Assign your On-Screen Control to a customizable component](#), like an ExpressKey or pen button, so that you can open it when you want to use it.

Assign On-Screen Controls

After you [create an On-Screen Control](#) and [assign settings to it](#), you need to assign the On-Screen Control to one of your device's components so that you can open it. You can assign On-Screen Controls to ExpressKeys™, touch gestures, and pen buttons, depending on the features available on your device.

In this example, you can see how to assign an On-Screen Control to an ExpressKey™.

- Open Wacom Tablet Properties and select your **Device**.
- Select **Functions**.
- Select the **ExpressKeys™** tab.
- From the drop-down next to one of the ExpressKeys™, select **On-Screen Controls**.
- From the list that appears, select the name of an On-Screen Control.
 - The assignment takes effect immediately.
- Press the ExpressKey™, and the On-Screen Control that you selected displays on your device or monitor. Click one of the buttons in the On-Screen Control to activate the setting that you assigned to it.

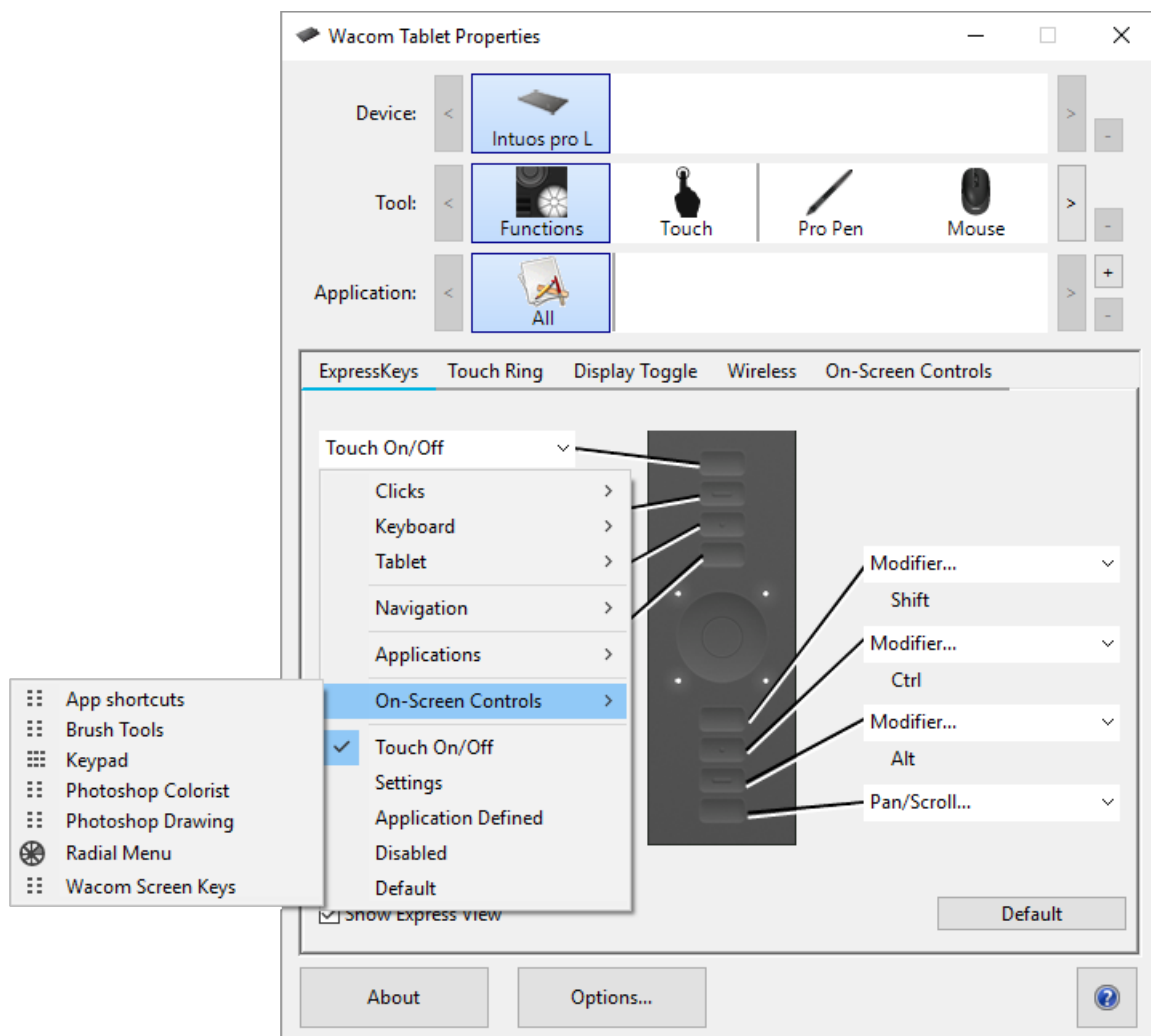

The above screenshot is for descriptive purposes; it may not match your screen.

Access application-specific settings

Settings assigned to customizable components can be further customized for a specific application. This makes performing functions in the application faster and easier. There are multiple ways to access those application-specific settings.

- **Settings assigned by you:** You can assign your own settings that change depending on the application you are working in.
- **Settings assigned by applications:** Some applications assign settings to customizable components so that when you open that application, you are automatically using the settings assigned by it.
- **Imported settings assigned by applications:** Some applications include an XML file that assigns settings to customizable components. After you import the file and open that application, you are automatically using the settings assigned by the settings file.

Some examples of customizable components that might have customized settings assigned are ExpressKeys™, pen buttons, the pen tip, Touch Rings, Rocker Rings, On-Screen Controls, touch gestures, and Touch Strips.

Note: The customizable components available may vary depending on your device.

Application-specific settings assigned by you

The **Application** list enables you to add individual applications, and then customize your tool settings for that application. For example, if you select an application icon and change the Pen settings, the changes will apply to the Pen only while you are using that application. Application-specific settings can be used with all Wacom pen tablets and pen displays, and with the ExpressKey Remote device.

- When application-specific settings are added, the **All** icon changes to **All Other**, and an application icon is displayed for the newly added application(s).
- After adding an application, its icon appears in the Application list whenever the associated tool is selected in the **Tool** list.
- Select the application, then customize the [Wacom Tablet Properties](#) tab settings for your tool and application.

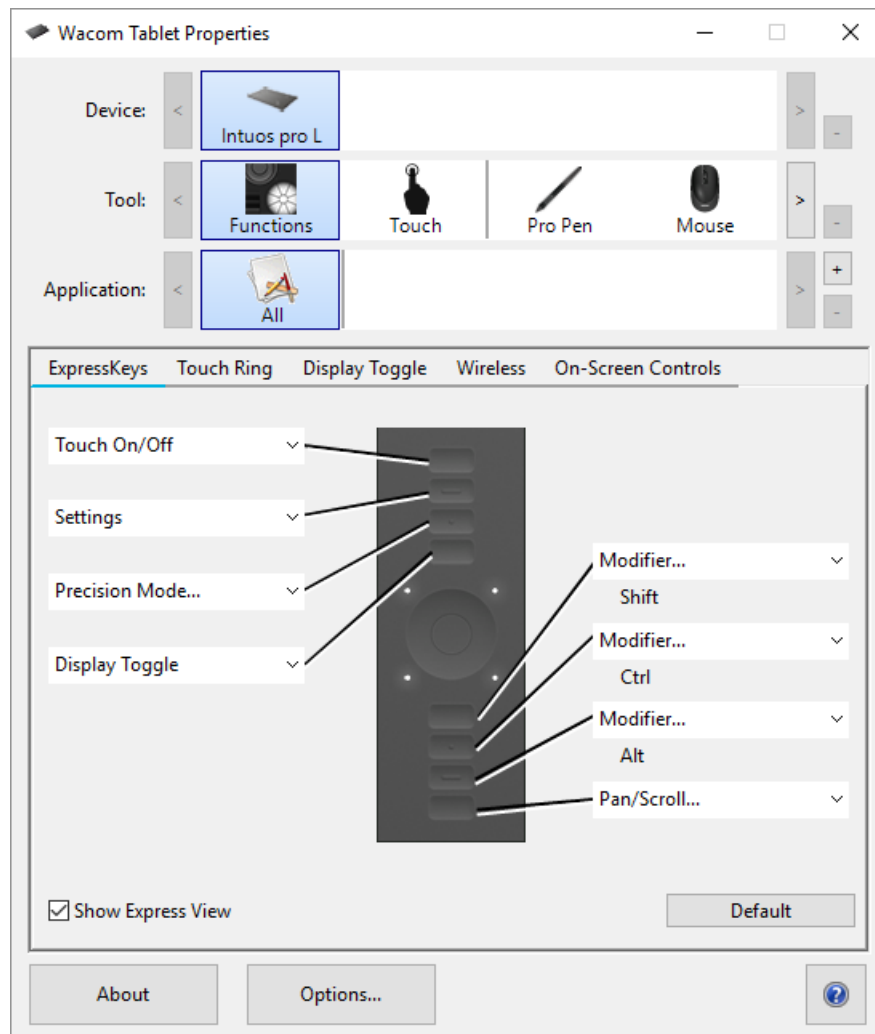

The above screenshot is for descriptive purposes; it may not match your screen.

To create an application-specific setting:

1. In the Tablet Properties, choose the **Device** and **Tool** for which you want to create an application-specific setting.
2. In the **Application** list click the **+** button.
3. In the **Currently Open Applications** box, select an application for which to create custom settings, or browse to select the executable file of any application installed on your computer.
4. Click **OK**.

To remove an application-specific setting:

1. In the **Tool** list, select the tool from which you want to remove the application-specific setting.
2. In the **Application** list, select the application you want to remove.
3. Click on the **Application** list - button. In the dialog, click **Delete** to confirm your selection. The selected application is removed from the list, along with any custom tool settings.
4. To remove all application-specific settings from a tool, remove it from the **Tool** list. Then place the tool back on the tablet. The tool will be added back to the **Tool** list using the default settings.

Note: This method cannot be used to remove custom **Functions** settings.

If you are working with a commonly used application such as Photoshop or Illustrator, your tablet's software will identify the application and set the ExpressKeys™ to commonly used functions for that application.

Notes:

- If two programs have the same executable file name, they will share the same customized settings.
- If you are using an application for which you have already customized your ExpressKeys™, those settings will take precedence over any automatic ExpressKey default settings provided by that application. Default settings will take effect automatically only if you have not entered your own ExpressKey settings for that application.

Settings assigned by applications

Some applications assign settings to [customizable components](#). When you open that application, you are automatically using the settings assigned by it.

How do I know what setting is assigned?

- After you open an application that assigns settings, you can view the assigned settings in Wacom Tablet Properties.
 - If you see **Application Defined** in the drop-down next to a component, it means that the application you are working in has assigned that setting. But, **Application Defined** does not display for every assigned setting. Sometimes, the name of the function displays instead. Refer to the documentation for that application to learn which settings are assigned.
- When you close the application or when you start working in another application, the settings revert back to their previous assignments.

Tip: You do not have to use the settings assigned by applications. You can [change the settings](#) in Wacom Tablet Properties.

Settings assignments work differently for different customizable components

Note: The customizable components available will vary depending on your device.

- An application may assign settings to some, but not all, **ExpressKeys™**. To find out if an application assigned settings to any ExpressKeys™, refer to the documentation for that application.
- If an application assigns a setting to any part of a **Touch Ring** or **Touch Strip**, all settings for the Touch Ring or Touch Strip are changed. If the application did not assign settings to cover the entire Touch Ring or Touch Strip, the unassigned settings are changed to **Skip**.

Imported settings assigned by applications

Some applications include an XML settings file that assigns settings to [customizable components](#). After you import the file and open that application, you are automatically using the settings assigned by the settings file.

Note: If the settings file does not assign a setting for a customizable component, then the setting stays the same as it was before the import.

1. Back up your settings by going to **Backup Settings** in the [Wacom Desktop Center](#).
2. After you back up your settings, double-click the customized settings file.
3. Follow the prompts in the window that appears.

Open [Wacom Tablet Properties](#) to view the imported settings.

Tip: You do not have to use the settings assigned by the settings file. You can [change the settings](#) in Wacom Tablet Properties.

Multi-Touch

The multi-touch features of your pen tablet or pen display enable you to interact with a computer using only your fingertips on the surface.

You can use touch as you would on any other Mac or Windows device. Touch is activated whenever you touch the tablet in the active area.

When using touch, you can usually position your fingers as far apart as is comfortable. However, placing your fingers too closely together may be interpreted by the tablet as input from a single finger, or the tablet may confuse which finger performed an action. Keep your fingers within the active area.

Take care to prevent accidental touches on the tablet when making gestures. For example, if the palm of your hand touches the active area of the tablet during while scrolling or zooming, you may trigger an unanticipated right-click.

In some cases, touch is enabled and disabled with a physical switch on the device.

On some tablet models that support both pen input and touch, the pen disengages touch whenever the pen tip or eraser is within the tablet proximity range. Lift the pen and your hand away from the tablet active area to enable touch.

Touch Options

The touch options control the basic touch functionality of your pen display.

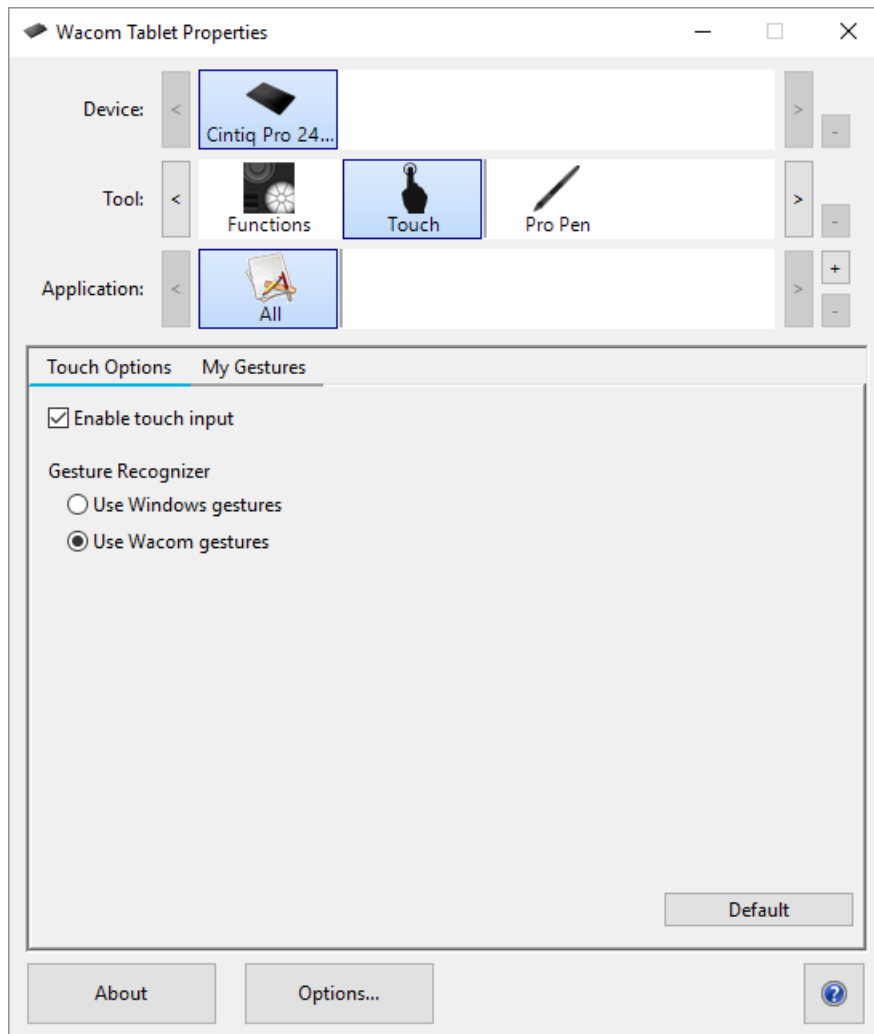

The above screenshot is for descriptive purposes it may not match your screen.

You can set your pen display for touch by selecting the Standard Gestures tab on a Mac. In Windows, select the Touch Options or My Gestures tab. From the Touch Options tab, select the **Use Wacom Gestures** option.

- Enable touch by clicking the **Enable touch input** checkbox.
- Choose an option for Gesture Recognizer. This is a global option and will apply to all of your applications. The default is Use Wacom gestures, which will provide a consistent touch experience across applications.

On a Mac:

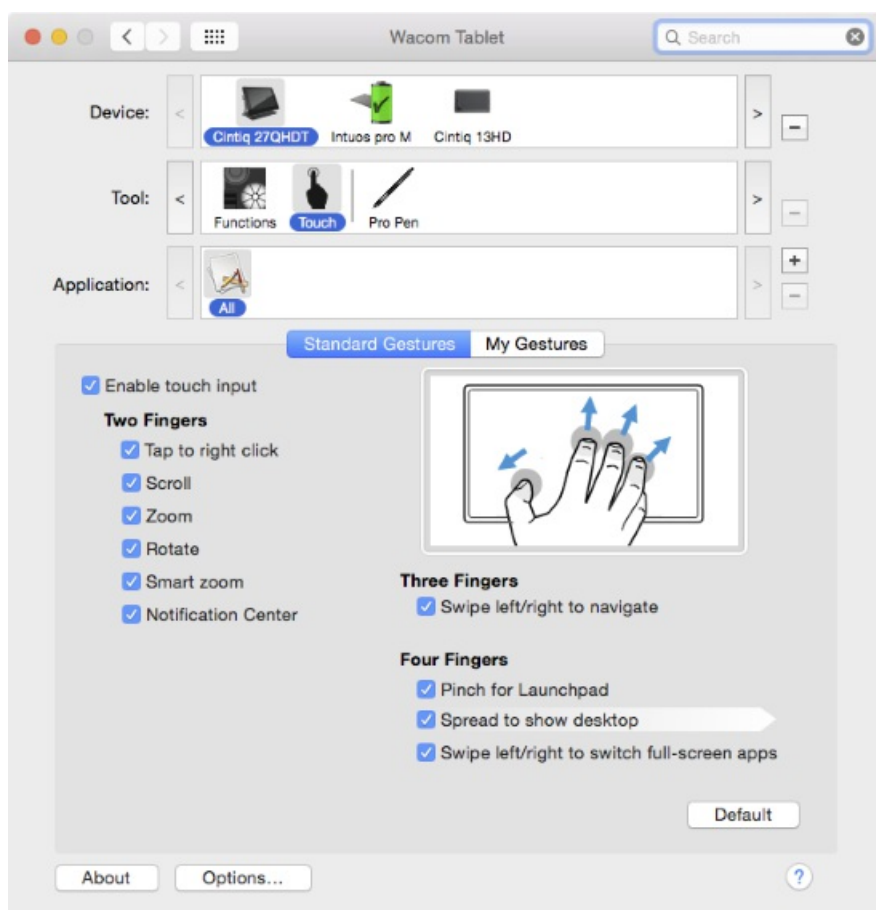

The above screenshot is for descriptive purposes, it may not match your screen.

On the Touch tabs, position the screen cursor over an option to see a static image of that function. If you do not choose a specific option to view, the control panel will display each option sequentially, from top to bottom. Available options may vary, depending on your operating system and version.

My Gestures

To create custom touch gestures, select the My Gestures tab. Touch gestures are available when selected, and can be selected or modified from the dropdown menus.

Position the cursor over a touch option to see a static image of that function. If you do not choose a specific option, the [Wacom Tablet Properties](#) will display each option sequentially, from top to bottom.

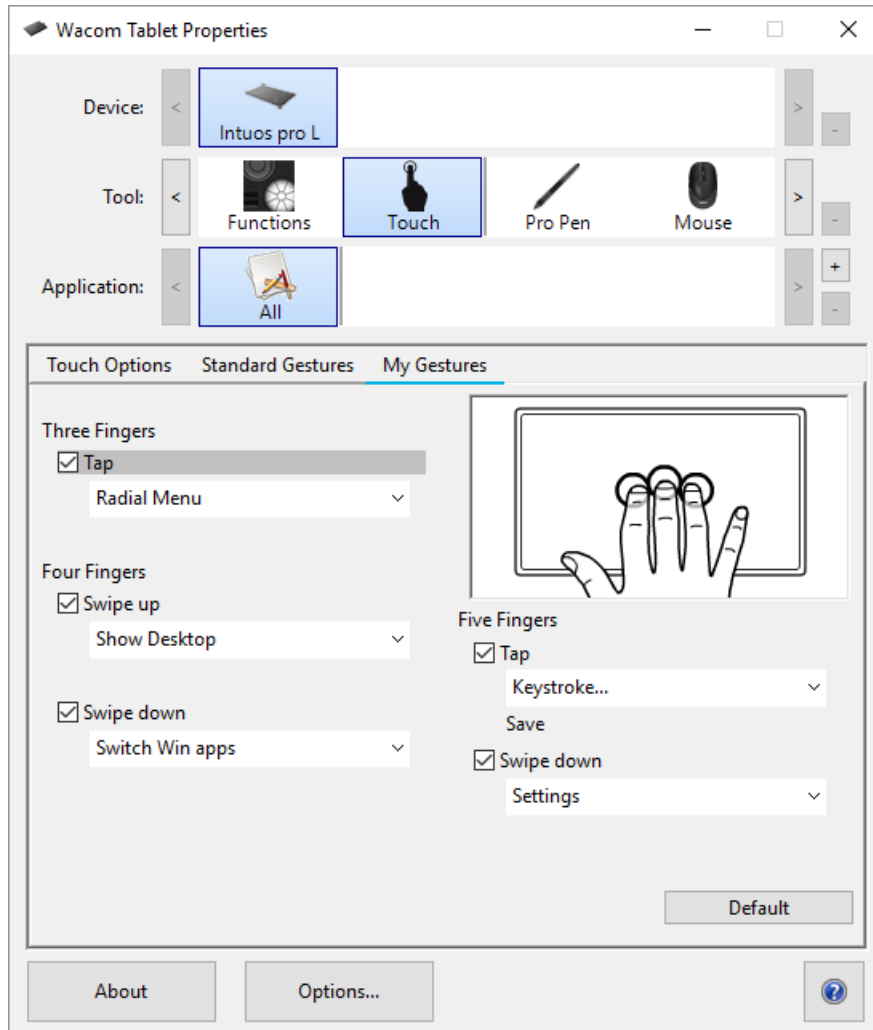

The above screenshot is for descriptive purposes; it may not match your screen.

Standard Gestures

Touch options can be individually enabled or disabled within [Wacom Tablet Properties](#). Touch is on when it is selected in the Touch Options tab, or when the toggle switch is set to enable touch.

The Standard Gestures tab lets you set non-custom gestures. For scrolling, select Natural or Standard from the dropdown menu to determine the direction of movement when you are scrolling. For three-finger gestures, select your preference from the dropdown menu.

Note: Windows does not support the Standard Gestures tab on Pen display products.

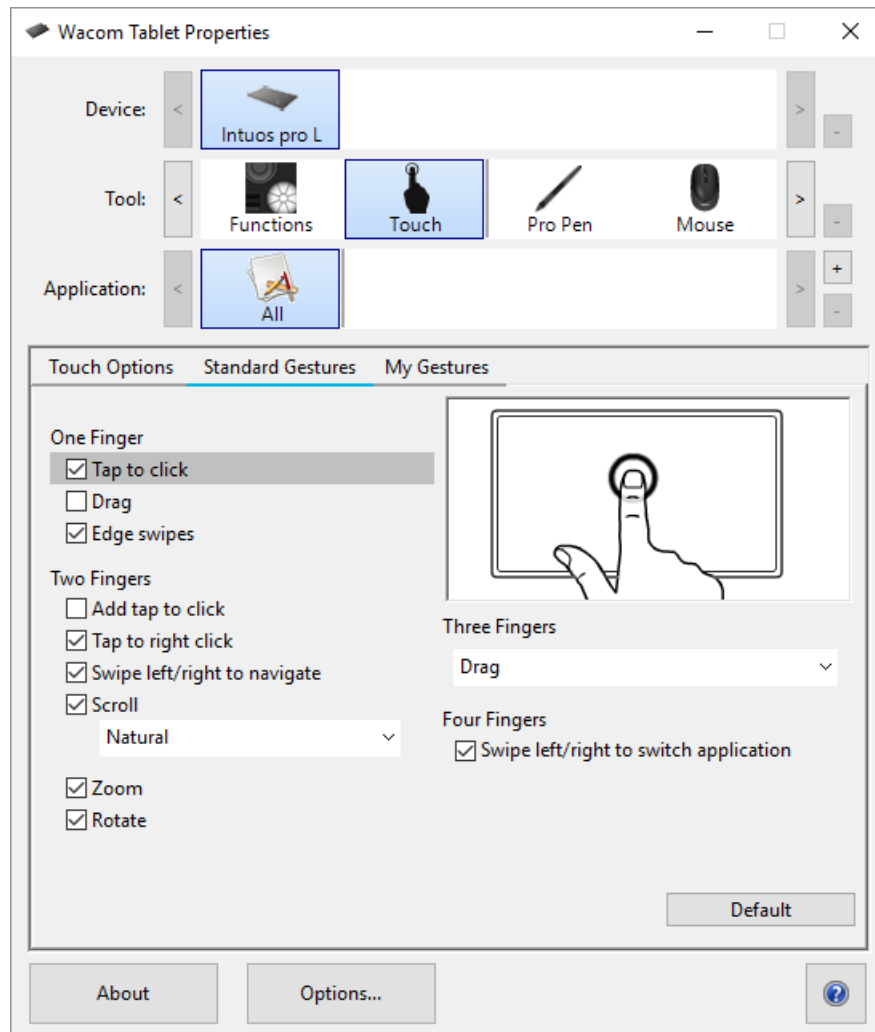

The above screenshot is for descriptive purposes, it may not match your screen.

- Use basic actions to navigate and perform typical mouse operations.
- Use gestures to scroll, zoom, rotate, and perform other functions. Some gestures may provide a visual cue on your display screen to indicate when the gesture has been recognized.
- Perform functions such as a right-click using different actions or gestures.
- Position the screen cursor over a touch option to see a static image of that function.

If you do not choose a specific option to view, the [Wacom Tablet Properties](#) will display each option sequentially, from top to bottom.

You can also:

- Customize your touch experience, and customize the ExpressKeys™ to perform some touch functions. See [Using multi-touch](#).
- Change settings using available options by selecting the Touch icon in the **Tool** list, then selecting an appropriate tab to customize.

Wacom Desktop Center

The Wacom Desktop Center helps you keep your driver and products up-to-date, customize your devices, and learn more about how to use pen tablets and pen displays.

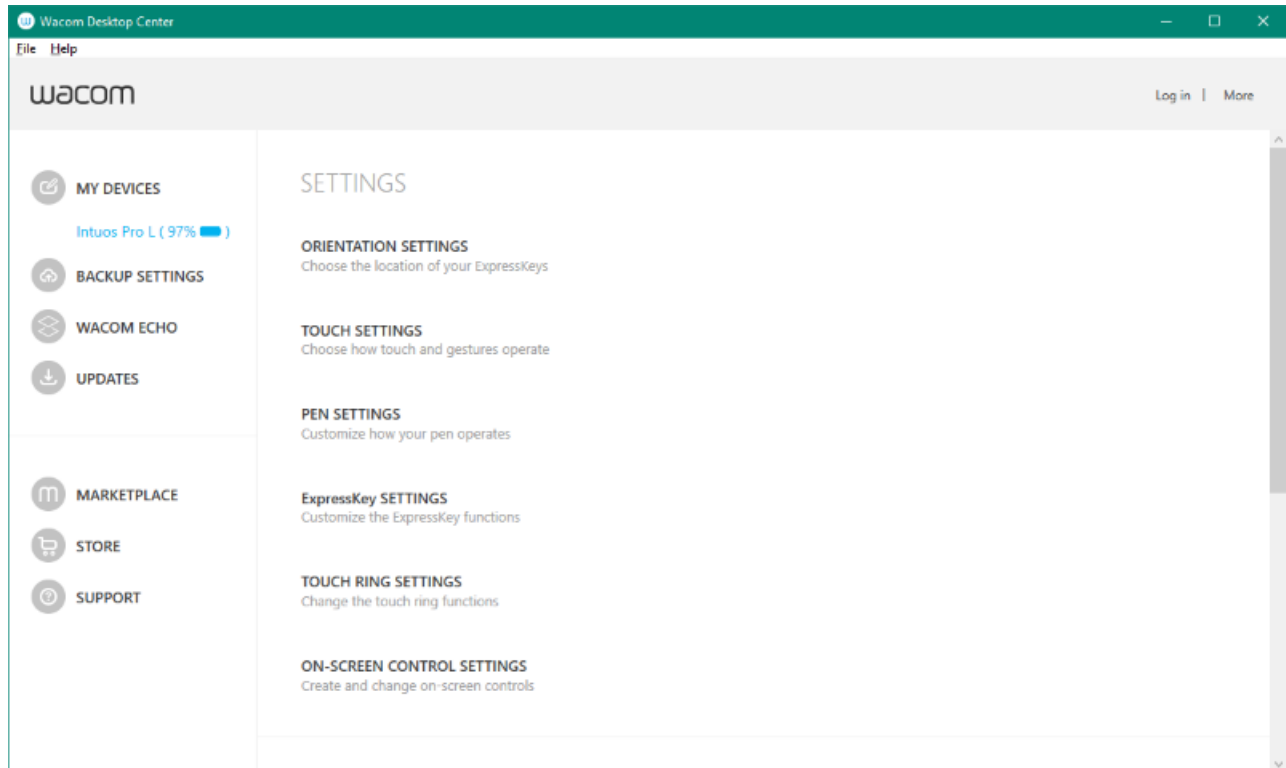

The above screenshot is for descriptive purposes, it may not match your screen.

Customizing your device

- If available for your device, the pen displays and pen tablets that are connected to your computer display under **My Devices**.
- Select a device to display settings menus.
- Select one of the settings menus, and Wacom Tablet Properties opens so you can change the settings.

Running the Setup Wizard

- If available for your device, select your device from **My Devices**, and select **Run Setup Wizard**. Follow the prompts.

Redeeming Software

- If available for your device, select your device from **My Devices**, and select **Redeem Software**. Register your product to get the software that came with it.

Backing up your settings

- Click **Backup Settings** to backup, restore, and reset your device settings.
- These settings can be stored locally or to your Wacom ID.

Note: Settings can only be restored to the device that they were created on.

Backing up your files

- If available for your device, use **Wacom Echo** to automatically back up your drawings, notes, and any other files stored on your tablet or computer.

Updating your tablet

- If available for your device, you are notified of driver, firmware, or BIOS updates by a notification next to **Updates**.
- Select **Updates**, and then click the update to install it.

Getting apps and products

- Click **Marketplace** to find apps that can improve your workflow.
- Click **Store** to research and purchase Wacom products.

Getting Support for Wacom products

- Select **Support** to view FAQs and tutorials on the Wacom website and to contact Support.
- If available for your device, select a device under **My Devices** to view documentation, tutorials, and Important Product Information.
- Go to **More > Online Help** or **Help > Online Help** to view help topics.

Logging in with your Wacom ID

- **Log in** with your Wacom ID so you can access the Wacom Cloud.
- Click your name to view and update your profile.

Click **More** to change privacy settings, to configure how the Wacom Desktop Center starts up, to access help, and to find Wacom on social media.

Customize Wacom Display Settings

The Wacom Display Settings utility allows you to customize Pen display settings. To open the Wacom Display Settings dialog, select the **Display Settings** option in the [Wacom Desktop Center](#).

- Select the **Display** to be customized from the dropdown menu.
- Adjust the brightness and contrast as needed.
- Select a **Color Setting** if you would like a particular type of display for your work. In the **Color Setting** menu:
 - Select **Color Temperature** to make Color Temperature and Gamma options available.
 - Select **Color Space** to make Color Space and Gamma options available.
 - Select **Custom Color** and click Set button to open the [Set Color dialog](#).
- Click the **Reset Color** button to reset your color settings to factory defaults.
- Click the **Advanced** button for additional settings for your display.
- Click the **Save** button to save the current settings in the dialog.
- Click the **Revert** button to undo any changes since the last Save, or since the display settings were started if a Save has not been done. Settings revert to that previous point.

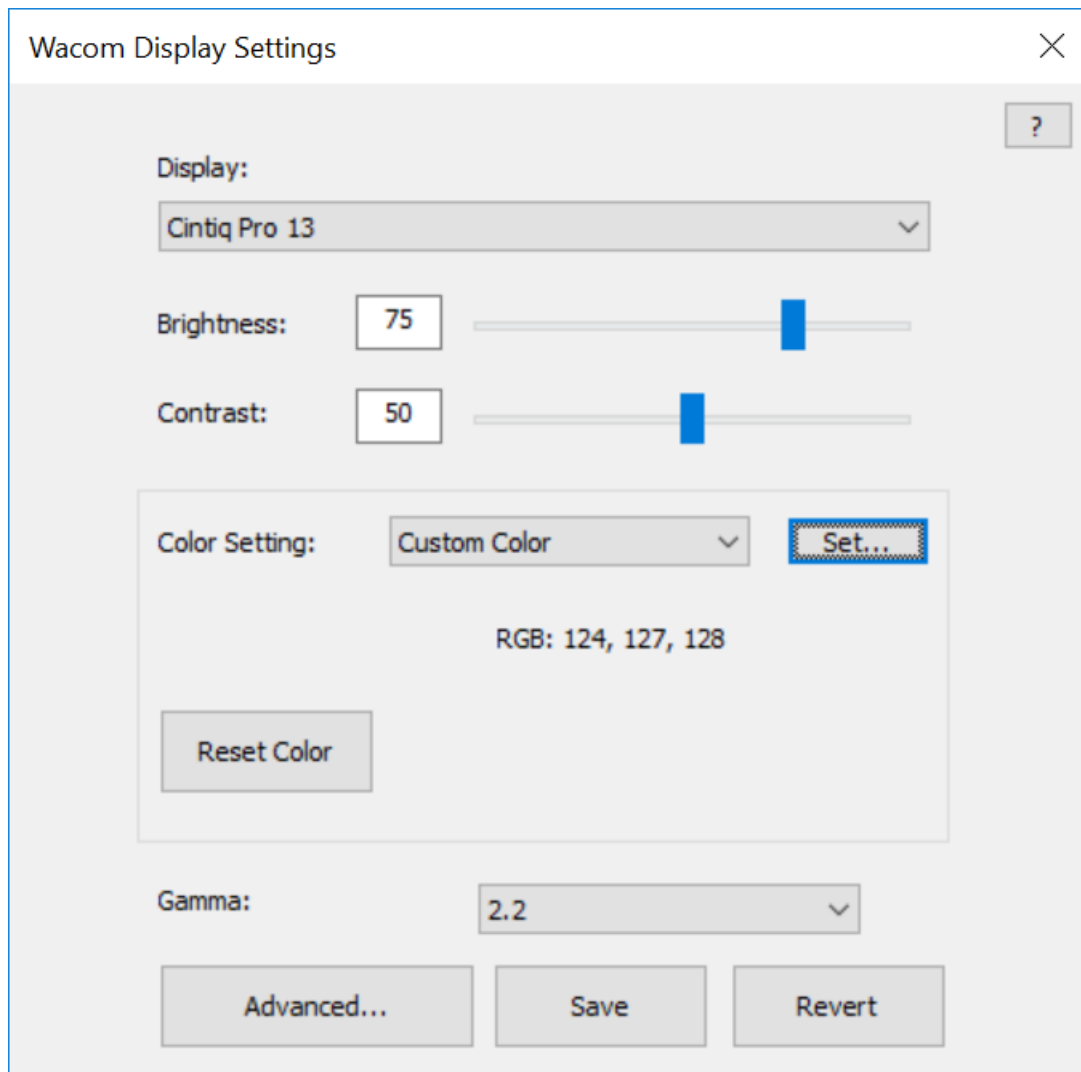

The above screenshot is for descriptive purposes; it may not match your screen.

Notes:

- Not all setting options may be available on your Pen display.
- Wacom Display Settings are not supported on Pen displays in Mobile Mode.

Customize advanced Wacom Display Settings

Click **Advanced** in [Wacom Display Settings](#) to customize advanced display settings such as aspect ratio, sharpness, auto power down, and more.

Important: The available options may vary depending on your device.

- Change the **Aspect Ratio** so that the screen displays the ratio of width to height that you want.
 - Select **Full** to fill the entire screen.
 - Select **Aspect** to fill as much of the screen as possible while maintaining the correct aspect ratio.
 - Select **1:1** to display a 1:1 screen aspect ratio.
- Move the **Sharpness** slider to the right for a sharper display and to the left for a softer one.
- Turn **Uniformity Compensation** to **On** to automatically adjust different areas of the screen with respect to the center. This results in uniform brightness and color over the entire screen.
- Turn **Dynamic Contrast** to **On** so that your screen is automatically adjusted to maintain a constant contrast.
- Turn **Energy Smart** to **On** so that your pen display goes to sleep if you do not interact with it for more than a few minutes.
- **Start LCD Conditioning** to automatically adjust the display so that instances of color do not remain on the screen for long periods of time. This prevents image persistence.
- **Auto Power Down** is **On** by default so that your pen display automatically powers off if you do not interact with it for over 120 minutes.
- Click **Factory Reset** to return the display settings to their defaults.

Tip: If you change display settings and your screen becomes too dark to see the **Factory Reset** button, you can press **CTRL + ALT + R** on your keyboard to reset display settings to their defaults.

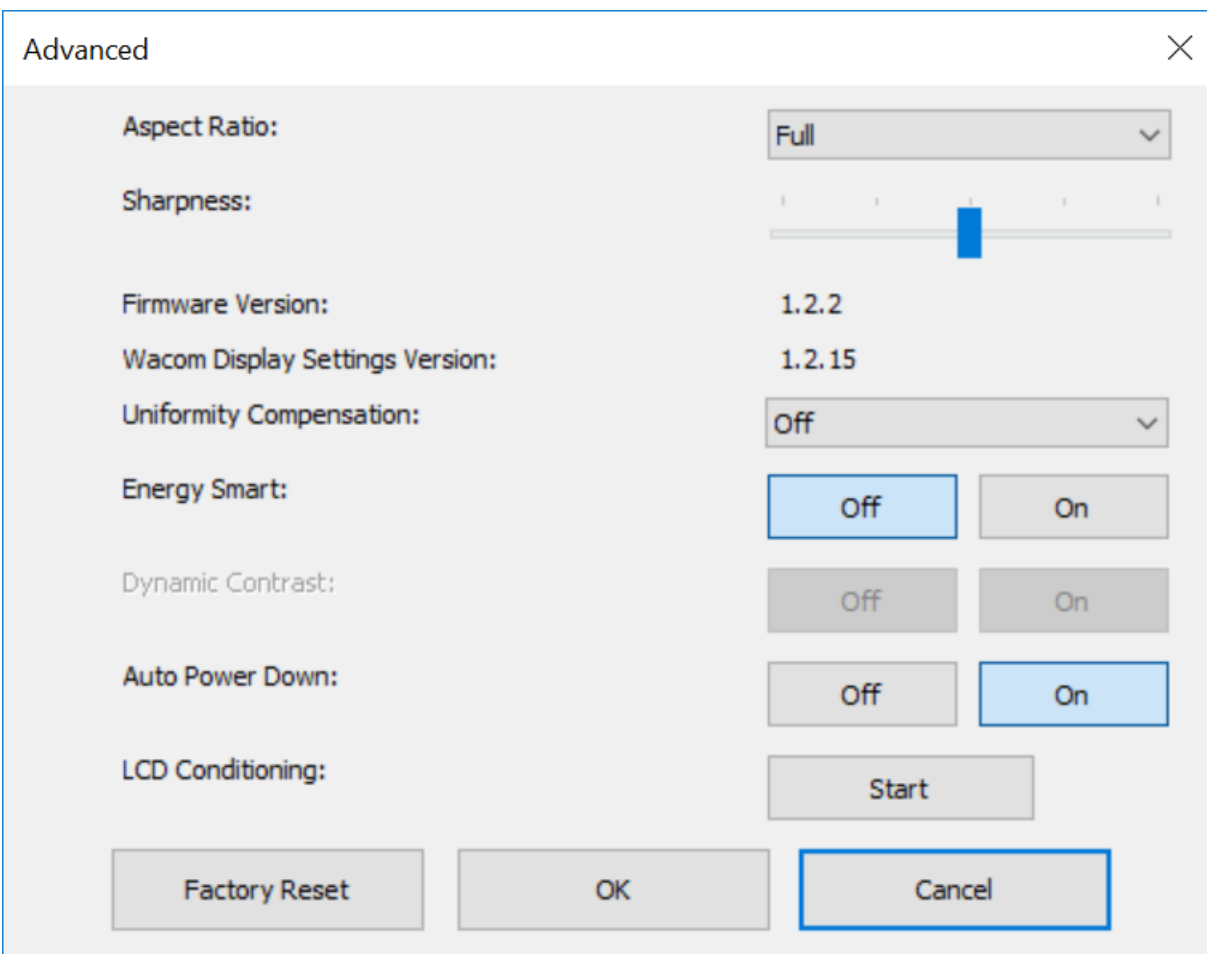

The above screenshot is for descriptive purposes, it may not match your screen.

Wacom Display Settings - Set Color

The Set Color dialog of the Wacom Display Settings utility allows you to further customize Pen display settings. To open the dialog, choose Custom Color from the **Color Setting** menu in the main [Display settings](#) dialog.

If supported by your device, you can also adjust the following color qualities:

- **Attribute:** Sets the sliders for RGB or CMYK color for the following attributes:
 - Hue: The overall appearance of a particular color, without changes to brightness or saturation.
 - Saturation: The depth of a color.
 - Gain: The range of a color.
 - Offset: The brightness of a color.

The Set Color dialog provides sliders for adjusting individual RGB and CMYK colors. You can also enter the hex value of a particular color and then adjust it with the sliders.

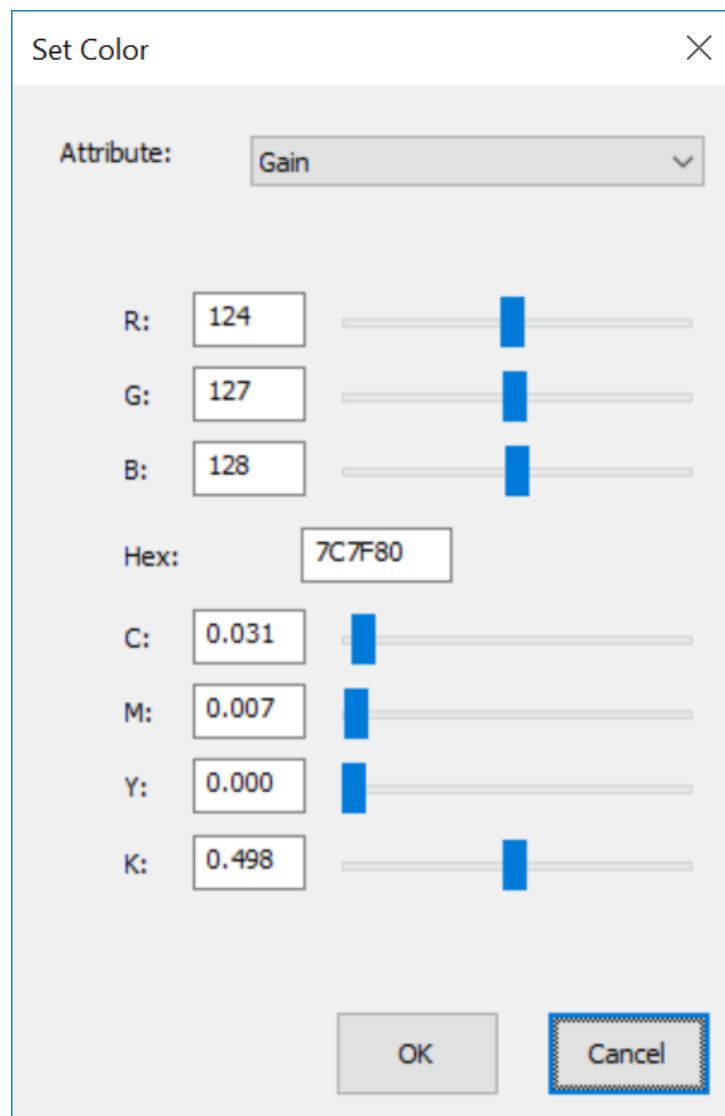

The above screenshot is for descriptive purposes; it may not match your screen.

Care for your device

Follow these care and maintenance tips to ensure optimum performance of your device.

 **Warning:** Do not spill liquids onto your device or pen. The devices may fail if exposed to liquids.

- Clean your device using an anti-static cloth or slightly damp cloth and light pressure.

 **Warning:** Do not use alcohol or detergent to clean your device.

- Do not wrap the cables around the device when storing it.
- Replace your pen nibs frequently to avoid scratching the surface with worn pen nibs.
- Avoid extremes in temperature.

 **Important:** Do not disassemble the device or the pen. Disassembling the device voids the warranty.

Make sure to review the **Important Product Information** for additional safety precautions. You can find it in the [Wacom Desktop Center](#), if supported for your device, or from [Customer Support](#).

Technical Support

If you encounter an issue with your pen tablet or pen display, perform the recommended action in any error message that appears on your screen. If that does not resolve the issue, try the following:

- Review the Quick Start Guide and make sure that the tablet is set up correctly, including that all plugs and connectors are firmly in place.
- Check the User Help for information regarding the issue.
- Visit the [Wacom website](#) to view the product FAQs (Frequently Asked Questions) to see if any apply to your issue.
- Go to [Customer Support](#) to see if a new driver is available and install it.
- Test your device and tools.

If you tried these suggestions and still have an issue, contact [Customer Support](#). Please be near your computer with the following information available:

- The make and model of your computer and the version of your operating system.
- Which devices were connected to your computer when the issue occurred.
- The name and version of the software application that you were using when the issue occurred.
- What happened and what you were doing when the issue occurred.
- The exact wording of any error messages that appeared on your screen.
- How you tried to solve the problem.

Test the creative pen display

If nothing appears on the screen after you have connected your pen display to your computer and installed the driver, check the following connections and elements.

1. Turn on your computer and wait until it is ready to use.
2. Verify that any power cables or adapters are properly connected, and that their LED status lights are on.
3. If your pen display is connected to your computer, check the USB connection.
 - Make sure the USB cable is securely connected to an active USB port on your computer.
 - Check the pen display USB cable for damage.
 - If you are connecting the pen display to a USB hub (or hub device with USB ports), be sure the USB hub is properly connected to your computer and is active.
 - If a status LED does not illuminate after your computer is on and has finished booting up, your USB port may be disabled. Verify that you have connected the pen display to an active USB port.
 - Connect the pen display to a different USB port, or to a USB port on another computer, and see if the problem persists.
 - For best results when troubleshooting no power to the pen display, plug it directly into the USB port on your computer.
 - Temporarily eliminate any external hubs in use until you determine that the system recognizes the pen display and that it is functional. When the pen display is working properly, you can then usually move its connection to a USB hub.
4. Test touch, if your pen display supports touch. Attempt to move the screen cursor by tracking your finger across the surface. Then tap to select an item.
 - If the driver does not load properly, basic touch movement will be recognized, but other actions and gestures will not. If gestures are not recognized, re-install the driver.
5. Check the ExpressKeys™ and Rocker Ring.
6. Check any other tool(s) you may be using.
7. If any of these tests fail, you may have defective hardware. See [Technical Support](#).
8. After testing, use [Wacom Tablet Properties](#) to reconfigure your pen display and tools for any custom settings you may have been using.

Test the pen

If your pen does not work properly, try these fixes first.

Note: The available features on your pen may vary depending on your device.

1. Go to the **Pen** tab in [Wacom Tablet Properties](#) and check that the settings assigned to the pen tip and pen buttons are what you expect.
2. If the assigned settings are as expected, restart your computer.
3. If restarting does not fix the issue, update your driver software.
4. If updating your driver does not fix the issue, **Reset settings** in the [Wacom Desktop Center](#).
5. If resetting does not fix the issue, diagnose issues using Wacom Tablet Properties.

Diagnose issues using Wacom Tablet Properties

- [Open Wacom Tablet Properties](#).
- If you have more than one device connected to your system, select the device you are using the pen with from the **Device** list.
- Click **About**, and then click **Diagnose**.

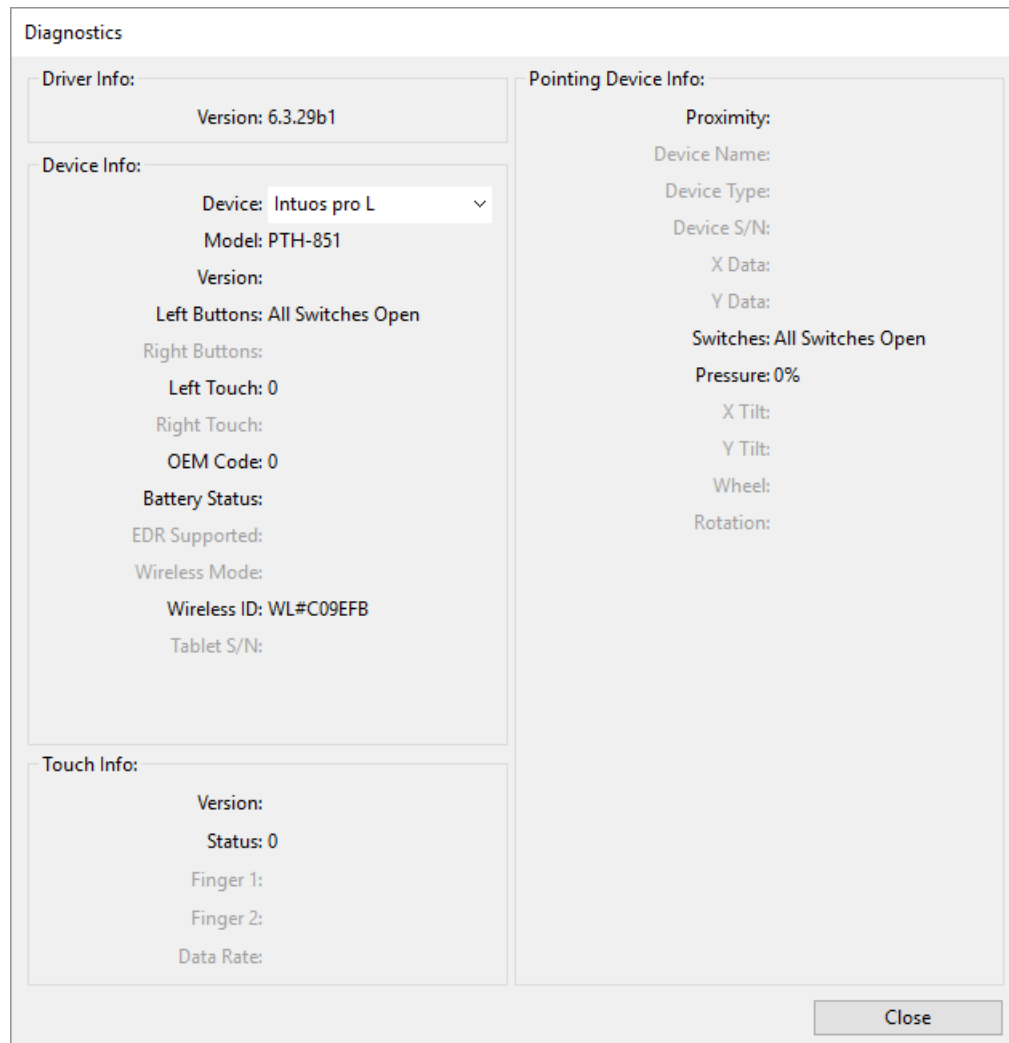

The above screenshot is for descriptive purposes; it may not match your screen.

- Hold your pen within 10 mm (0.4 inch) of the surface of the device while watching the **Pointing Device Info**.
 - You should see a value appear after **Proximity**, **Device Name**, **Device Type**, and **Device S/N** (serial number).
- Move the pen along the surface of the device.
 - As you move the pen, the **X Data** and **Y Data** values should change.
- Press on the surface with the pen tip and then with the eraser.
 - As you are pressing, the **Switches** and **Pressure** values should change from approximately 0% to approximately 100% when you are pressing with full pressure.
- Press the tip, eraser, and each pen button, one at a time. When you are pressing each pen button, hold the pen tip slightly above the device surface.
 - As you press each item, the **Switches** number should change to match these numbers:

- Pen tip = 1
- Pen button (***) = 3
- Pen button (**) = 2
- Pen button (*) = 2, 3
- Pen eraser = 1
- Airbrush tip = 1
- Airbrush pen button = 2
- Airbrush eraser = 1

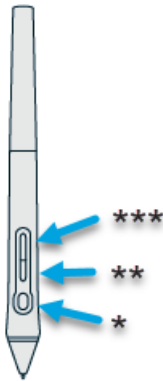

- Move the pen from a vertical position toward the right and then toward the left.
 - The **X Tilt** value should change to approximately +60 when you move to the right.
 - The **X Tilt** value should change to approximately -60 when you move to the left.
- Move the pen from a vertical position toward the bottom of the device and then toward the top of the device.
 - The **Y Tilt** value should change to approximately +60 when you move toward the bottom.
 - The **Y Tilt** value should change to approximately -60 when you move toward the top.
- If you are testing an Art Pen, place the pen tip on the surface of the device and slowly rotate the pen on its axis.
 - The **Rotation** value should change as you rotate the pen.
- If you are testing an Airbrush, move the fingerwheel forward and backward.
 - The **Wheel** value should decrease to approximately 0 when the fingerwheel is all the way forward.
 - The **Wheel** value should increase to approximately 1000 when the fingerwheel is all the way backward.

Test touch

Important: If basic touch functions work, such as the cursor tracking your finger, but other touch functions do not, [reinstall the driver](#).

- Move your finger across the surface of the device. The cursor should move with your finger.
- Tap on an item or tap twice on a folder or program. The item should be selected or the folder or program should open.
- If your device has a status LED, the LED should brighten when you touch the active area of the device.

If the tests fail, you may have defective hardware. Contact Wacom Customer Support for help.

Glossary

Application-specific settings. Pen tablet tool and tablet settings that have been customized for individual applications. Application-specific settings are in effect whenever you use the application.

Aspect. The ratio between the vertical and horizontal dimension of the tablet or display.

Bluetooth. A method of wireless communication between devices.

Click force. The amount of force you must apply to the pen tip for a click to occur.

Digital Ink. Typically, handwritten content which has been created using a pen on a computer in the form of sketches, ink mark-up, or handwriting. The handwriting can be converted to typewritten text or used in its original format.

Display Toggle. A feature that allows you to work with your tablet on all displays or on one display at a time. Available only on multiple monitor systems.

Double-click assist. A feature that makes it easier to double-click by setting the size of the double-click distance.

Double-click distance. The maximum distance (in screen pixels) that the screen cursor can move between clicks and still be accepted as a double-click. Increasing the double-click distance makes double-clicking easier, but may cause a delay in brush strokes in some graphics applications.

Double-click speed. The maximum time that can pass between clicks and still be accepted as a double-click.

Eraser-aware application. A software application that has built-in support for the pen eraser. These applications take advantage of the eraser in different ways, depending on what makes sense for the application.

Expand. A motion used when navigating with touch. Touch the tablet surface with two fingers spaced closely together, then move your fingers apart.

ExpressKeys™. The customizable component buttons located on your pen tablet.

Fingerwheel. The control wheel on the optional Airbrush.

Modifier. Modifier keys include Shift, Alt, and Ctrl for Windows, or Shift, Control, Command, and Option for Mac. You can customize your tool buttons or ExpressKeys™ to simulate a modifier key.

Nib. The replaceable pen tip.

Pairing. A method of creating a virtual cable (Bluetooth) link between two devices.

Pan. A motion used when navigating with touch. Touch the tablet surface with your fingers and move them in the same direction.

Pen input. A method of controlling a computer using the pen.

Pinch. A motion used when navigating with touch. Touch the tablet with two fingers spaced slightly apart, then move or 'pinch' your fingers together on the tablet surface.

Pixel. The smallest unit of measure on your display screen.

Pressure sensitive. A quality of the Wacom pen tip and eraser that senses the amount of pressure being applied. This is used to create natural-looking pen, brush, and eraser strokes in applications that are pressure-sensitive.

Pressure-sensitive application. Any application that supports pressure-sensitive input.

Proximity. The height above the tablet active area where pen detection occurs.

Rotate. A motion used when navigating with touch. Touch the tablet with two fingers spaced slightly apart and rotate them in a

circular fashion, move them in opposing directions, or hold one finger stationary and track your other finger around the stationary finger.

Swipe. A motion used when navigating with touch. Touch the tablet surface with three, four, or five fingers and sweep them quickly across the tablet in the same direction.

Tap. A motion used when navigating with touch. Touch and lift a single finger (or multiple fingers, depending on the gesture) from the tablet.

Tilt-sensitive. A quality of the pen tip and eraser that senses the amount of tilt between the tool and the tablet. This is used to create natural-looking pen, brush, and eraser strokes in applications that are tilt-sensitive.

Touch. A method of interacting with a computer using only your fingers on the tablet. May also be referred to as touch input.

Touch Ring. The customizable control ring located on your pen tablet.

Touch Strips. The customizable control strips located on the back of the Cintiq 22.

Touch sensor. The navigation area of your pen tablet where touch is detected. The touch sensor resides within the active area, and does not accept pen input.

Track. A motion used when navigating with touch. Touch and move a single finger across the tablet surface.

Wacom Link adaptor Adapter for creative pen displays on machines without a USB-C port.

Order parts and accessories

To purchase parts and accessories for your device, go to the [Wacom Store](#).

You may also contact your local dealer, distributor, or [Customer Support](#) for your region.

Note: Some parts and accessories may not be available in all regions.

Privacy

At Wacom, we value your Privacy. We use analytics to collect basic information about browsing to improve our User Help.

Please see our [Privacy Policy](#) for more information.

About This Document

This document is referred to as User Help. User Help is intended to assist with the setup, features, and advanced use of Wacom devices, including tablets, pens, and accessories.

User Help is an additional resource to the Quick Start Guide, which is included in the box with your Wacom device. The Quick Start Guide will give you the fastest overview of the initial setup or installation process so you can begin using your Wacom device immediately.

Things to Know About User Help

When viewing User Help, there are several callouts to pay special attention to that give you important information regarding using your Wacom device. The following callouts are present in User Help:

 **Important:** this callout provides specific information that may be necessary for the optimal use of your device or information that you should know about your device.

 **Warning:** this callout provides specific information that may be necessary for the safe use of your device, including but not limited to physical safety or the safe management of your files and data, and best-practice measures to ensure your device works properly.

Note: this callout provides general information about the use of your device, including efficiencies and feature details, variations, or limitations. This callout is also used to identify if a feature or function is not available on all devices.

Tip: this callout provides additional information on how to use your device, including shortcuts and helpful recommendations.

The User Help also contains links to other helpful or relevant information. Clicking on a link will take you to another URL location, most commonly another User Help page or to the [Wacom website](#).

Device Features in User Help

User Help provides an in-depth look into the features of Wacom devices. This includes feature definitions, examples, screenshots, and instructions for use to help users make the most out of their experiences with their devices. For this reason, the User Help may contain features that are not available on your specific device. Wacom does its best to annotate the instances where a device feature is mentioned but is not available on all devices.

Trademarks

Copyright © 2018 Wacom Co., Ltd.

All rights reserved. Wacom, Intuos, Cintiq, and their respective logos are trademarks and/or registered trademarks of Wacom Co., Ltd.

No part of this information may be reproduced except for your express personal use.

Wacom makes reasonable efforts to provide current and accurate information. However, Wacom reserves the right to change any specifications and product configurations at its discretion, without prior notice and without obligation to include such changes.

Illustrator and Photoshop are either registered trademarks or trademarks of Adobe Systems Incorporated in the United States and/or other countries. Microsoft and Windows are either registered trademarks or trademarks of Microsoft Corporation in the United States and/or other countries. Apple, the Apple logo, and Mac are registered trademarks of Apple, Inc., registered in the U.S. and other countries. ExpressKey is a trademark of Ginsan Industries, Inc., and is used with permission.

Many Wacom devices incorporate High Definition Multimedia Interface (HDMI) technology. HDMI, the HDMI logo, and High Definition Multimedia Interface are trademarks or registered trademarks of HDMI Licensing LLC.

All additional company and product names mentioned in this documentation may be trademarked and/or registered as trademarks. Mention of third-party products is for information purposes only and constitutes neither an endorsement nor a recommendation. Wacom assumes no responsibility with regard to the performance or use of these products.