

Canon

EOS 80D

EOS 80D (W)



Camera

Wireless Function

Basic Instruction Manual

Instruction manuals (PDF files) and software can be downloaded from the Canon website (p.4, 233).

www.canon.com/icpd

ENGLISH

Canon

EOS 80D
EOS 80D (W)

Camera Basic Instruction Manual

The Camera Basic Instruction Manual covers the most basic operations and functions.

Introduction

The EOS 80D (W) is a digital single-lens reflex camera featuring a fine-detail CMOS sensor with approx. 24.2 effective megapixels, DIGIC 6, high-precision and high-speed 45-point AF (Cross-type AF point: Max. 45 points), max. approx. 7.0 fps continuous shooting, Live View shooting, Full High-Definition (Full HD) movie shooting, and wireless functions (Wi-Fi/NFC).

Before Starting to Shoot, Be Sure to Read the Following

To avoid botched pictures and accidents, first read the “Safety Precautions” (p.14-16) and “Handling Precautions” (p.17-19). Also, read this manual carefully to ensure that you use the camera correctly.

Refer to This Manual while Using the Camera to Further Familiarize Yourself with the Camera

While reading this manual, take a few test shots and see how they come out. You can then better understand the camera. Be sure to store this manual safely, too, so that you can refer to it again when necessary.

Testing the Camera Before Use and Liability

After shooting, play images back and check whether they have been properly recorded. If the camera or memory card is faulty and the images cannot be recorded or downloaded to a computer, Canon cannot be held liable for any loss or inconvenience caused.

Copyrights

Copyright laws in your country may prohibit the use of your recorded images or copyrighted music and images with music on the memory card for anything other than private enjoyment. Also be aware that certain public performances, exhibitions, etc., may prohibit photography even for private enjoyment.

Item Check List

Before starting, check that all the following items are included with your camera. If anything is missing, contact your dealer.

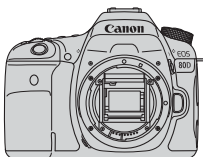

Camera
(with body cap)

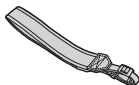

Wide Strap



**Battery Pack
LP-E6N**
(with protective
cover)



**Battery Charger
LC-E6/LC-E6E***

* Battery Charger LC-E6 or LC-E6E is provided. (The LC-E6E comes with a power cord.)

- **The camera does not come with an interface cable or HDMI cable.**
- The Instruction Manuals provided are listed on the next page.
- If you purchased a Lens Kit, check that the lenses are included.
- Depending on the Lens Kit type, lens instruction manuals may also be included.
- Be careful not to lose any of the above items.



When you need Lens Instruction Manuals, download them from the Canon website (p.4).

The lens instruction manuals (PDF) are for lenses sold individually. Note that when purchasing the lens kit, some of the accessories included with the lens may not match those listed in the Lens Instruction Manual.

Instruction Manuals



Camera and Wireless Function Basic Instruction Manual

The booklet is the Basic Instruction Manual.
More detailed Instruction Manuals (PDF files) can be downloaded from the Canon website.

Downloading and Viewing the Instruction Manuals (PDF Files)

1 Download the Instruction Manuals (PDF files).

- Connect to the Internet and access the following Canon website.
www.canon.com/icpd
- Select your country or region of residence and download the Instruction Manuals.

Instruction Manuals Available for Download

- Camera Instruction Manual
- Wireless Function Instruction Manual
- Camera and Wireless Function Basic Instruction Manual
- Lens Instruction Manuals
- Software Instruction Manuals

2 View the Instruction Manuals (PDF files).

- Double-click a downloaded Instruction Manual (PDF file) to open it.
- To view the Instruction Manuals (PDF files), Adobe Acrobat Reader DC or other Adobe PDF viewer (most recent version recommended) is required.
- Adobe Acrobat Reader DC can be downloaded free from the Internet.
- To learn how to use a PDF viewer, refer to its Help section.



Software can be downloaded from the Canon website (p.233).

Compatible Cards



The following cards can be used with the camera regardless of capacity: **If the card is new or was previously formatted by another camera or computer, format the card with this camera (p.58).**

- **SD/SDHC*/SDXC* memory cards**

* UHS-I cards supported.

Cards that Can Record Movies

When shooting movies, use a large-capacity card with a reading/writing speed class at least as high as shown in the following table.

| Movie Recording Size (p.207) | | Recording Formats | |
|------------------------------|---|-----------------------------|-----------------------------|
| | | MOV | MP4 |
| ALL-I (For editing) | | UHS Speed Class 3 or faster | - |
| IPB (Standard) |  :   | - | SD Speed Class 10 or faster |
| | Other than above | - | SD Speed Class 6 or faster |
| IPB (Light) | | - | SD Speed Class 4 or faster |

- If you use a slow-writing card when shooting movies, the movie may not be recorded properly. Also, if you play back a movie on a card with a slow reading speed, the movie may not play back properly.
- To check the card's reading/writing speed, refer to the card manufacturer's website.



In this manual, "card" refers to SD memory cards, SDHC memory cards, and SDXC memory cards.

* **The camera does not come with a card for recording images/movies.** Please purchase it separately.

Quick Start Guide

1

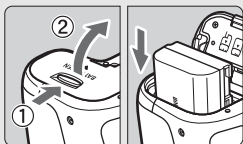

Insert the battery (p.30).

- To charge the battery, see page 28.

2

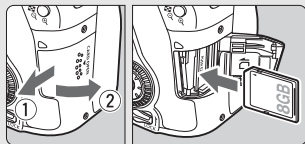

Insert the card (p.31).

- With the card's label facing toward the back of the camera, insert it into the card slot.

3

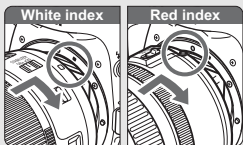

Attach the lens (p.41).

- Align the lens's white or red mount index with the camera's mount index of the same color.

4

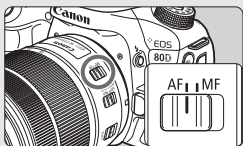

Set the lens's focus mode switch to <AF> (p.41).

5

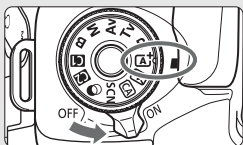

Set the power switch to <ON>, then set the Mode Dial to <AI+> (Scene Intelligent Auto) (p.72).

- Turn the Mode Dial while holding down the lock release button at the center.
- All the necessary camera settings will be set automatically.

6

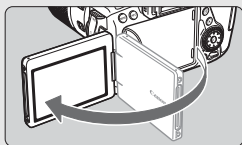
**Flip out the LCD monitor** (p.34).

- When the LCD monitor displays the date/time/zone setting screens, see page 37.

7

**Focus on the subject** (p.44).

- Look through the viewfinder and aim the viewfinder center over the subject.
- Press the shutter button halfway, and the camera will focus on the subject.
- If necessary, the built-in flash will be raised.

8

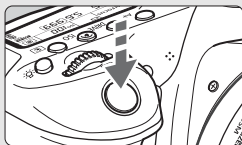
**Take the picture** (p.44).

- Press the shutter button completely to take the picture.

9

**Review the picture.**

- The captured image will be displayed for approx. 2 sec. on the LCD monitor.
- To display the image again, press the <▶> button (p.216).
- To shoot while looking at the LCD monitor, see “Live View Shooting” (p.173).
- To view the images captured so far, see “Image Playback” (p.216).
- To delete an image, see “Erasing Images” (p.229).

Conventions Used in this Manual

Icons in this Manual



: Indicates the Main Dial.



: Indicates the Quick Control Dial.



<▲> <▼> <◀> <▶>: Indicates the Multi-controller and the push direction.



: Indicates the Setting button.

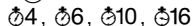

: Indicates that each function remains active for approx. 4 sec., 6 sec., 10 sec., or 16 sec. after you let go of the button.

* In addition to the above, the icons and symbols used on the camera's buttons and displayed on the LCD monitor are also used in this manual when discussing relevant operations and functionality.



: Indicates a function that can be changed by pressing the <MENU> button to change its settings.



: When shown on the upper right of a page, it indicates that the function is available only in the Creative Zone modes (p.25).

(p.**)

: Reference page numbers for more information.



: Warning to prevent shooting problems.



: Supplemental information.



: Tips or advice for better shooting.



: Troubleshooting advice.

Basic Assumptions

- All operations explained in this manual assume that the power switch is set to <ON> and the <LOCK> switch is set down (Multi function lock released) (p.35, 48).
- It is assumed that all the menu settings and Custom Functions are set to their defaults.
- The illustrations in this manual show the camera attached with the EF-S18-135mm f/3.5-5.6 IS USM lens as an example.

Chapters



| | | |
|----------|--|------------|
| | Introduction | 2 |
| 1 | Getting Started | 27 |
| 2 | Basic Shooting | 71 |
| 3 | Setting the AF and Drive Modes | 109 |
| 4 | Image Settings | 131 |
| 5 | Advanced Operations | 155 |
| 6 | Shooting with the LCD Monitor (Live View Shooting) | 173 |
| 7 | Shooting Movies | 197 |
| 8 | Image Playback | 215 |
| 9 | Software Start Guide / Downloading Images to a Computer | 231 |

Contents

Introduction 2

















| | |
|--------------------------------------|----|
| Item Check List..... | 3 |
| Instruction Manuals | 4 |
| Compatible Cards..... | 5 |
| Quick Start Guide | 6 |
| Conventions Used in this Manual..... | 8 |
| Chapters..... | 9 |
| Safety Precautions | 14 |
| Handling Precautions | 17 |
| Nomenclature | 20 |

1 Getting Started 27



| | |
|--|----|
| Charging the Battery | 28 |
| Installing and Removing the Battery..... | 30 |
| Installing and Removing the Card | 31 |
| Using the LCD Monitor | 34 |
| Turning on the Power | 35 |
| Setting the Date, Time, and Zone..... | 37 |
| Selecting the Interface Language..... | 40 |
| Attaching and Detaching a Lens..... | 41 |
| Basic Operation..... | 43 |
|  Quick Control for Shooting Functions | 50 |
|  Menu Operations | 52 |
|  Using the Touch Screen | 55 |
| Before You Start | 58 |
| Formatting the Card..... | 58 |
| Disabling the Beeper | 60 |
| Setting the Power-off Time/Auto Power Off | 60 |
| Setting the Image Review Time | 61 |
| Turning the LCD Monitor Off/On..... | 61 |
| Reverting the Camera to the Default Settings | 62 |









| | |
|--|----|
| Displaying the Grid..... | 65 |
|  Displaying the Electronic Level..... | 66 |
| Displaying the Flicker Detection..... | 68 |
| Feature Guide and Help..... | 69 |

2 Basic Shooting 71

| | |
|--|-----|
|  Fully Automatic Shooting (Scene Intelligent Auto)..... | 72 |
|  Full Auto Techniques (Scene Intelligent Auto)..... | 75 |
|  Disabling Flash..... | 77 |
|  Creative Auto Shooting..... | 78 |
| SCN: Special Scene Mode | 82 |
|  Shooting Food..... | 83 |
|  Shooting Children..... | 84 |
|  Shooting Candlelight Portraits..... | 85 |
|  Shooting Night Portraits (With a Tripod)..... | 86 |
|  Shooting Night Scenes (Handheld)..... | 87 |
|  Shooting Backlit Scenes..... | 88 |
|  Shooting Portraits..... | 89 |
|  Shooting Landscapes..... | 90 |
|  Shooting Close-ups..... | 91 |
|  Shooting Moving Subjects..... | 92 |
|  Applying Creative Filters..... | 95 |
|  Quick Control..... | 100 |
| Shooting with Ambience Selection..... | 102 |
| Shooting by Lighting or Scene Type..... | 106 |

3 Setting the AF and Drive Modes 109

| | |
|---|-----|
| AF: Selecting the AF Operation..... | 110 |
|  Selecting the AF Area and AF Point..... | 114 |
| AF Sensor..... | 118 |
| Lenses and Usable AF Points..... | 119 |
| MF: Manual Focus..... | 127 |
|  Selecting the Drive Mode..... | 128 |

| | | |
|---|--|------------|
|  | Using the Self-timer..... | 130 |
| 4 | Image Settings | 131 |
| | Setting the Image-Recording Quality | 132 |
| | ISO: Setting the ISO Speed for Still Photos | 135 |
| |  Selecting a Picture Style | 137 |
| | Setting the White Balance | 139 |
| | White Balance..... | 140 |
| | AWB Setting the Auto White Balance | 140 |
| | Auto Correction of Brightness and Contrast..... | 142 |
| | Setting Noise Reduction..... | 143 |
| | Highlight Tone Priority | 147 |
| | Correction of Lens Peripheral Illumination and Aberrations | 148 |
| | Reducing Flicker..... | 152 |
| 5 | Advanced Operations | 155 |
| | P : Program AE | 156 |
| | Tv : Shutter-Priority AE..... | 158 |
| | Av : Aperture-Priority AE | 160 |
| | Depth-of-Field Preview | 161 |
| | M : Manual Exposure | 162 |
| |  Selecting the Metering Mode..... | 164 |
| |  Setting Exposure Compensation..... | 166 |
| | Auto Exposure Bracketing (AEB) | 167 |
| |  AE Lock..... | 169 |
| |  Using the Built-in Flash..... | 170 |
| 6 | Shooting with the LCD Monitor (Live View Shooting) | 173 |
| |  Shooting with the LCD Monitor | 174 |
| | Selecting the AF Operation | 178 |
| | Focusing with AF (AF Method)..... | 180 |
| |  Shooting with the Touch Shutter..... | 190 |
| | MF: Focusing Manually | 192 |

| | | |
|----------|---|------------|
| 7 | Shooting Movies | 197 |
| | 🎥 Shooting Movies | 198 |
| | Setting the Movie Recording Size | 207 |
| 8 | Image Playback | 215 |
| | ▶ Image Playback | 216 |
| | INFO.: Shooting Information Display | 218 |
| | ▶ Searching for Images Quickly | 222 |
| | 🔍/🔍 Magnified View | 223 |
| | 👉 Playing Back with the Touch Screen | 224 |
| | 🎥 Playing Back Movies | 226 |
| | 🗑 Erasing Images | 229 |
| 9 | Software Start Guide / Downloading Images to a Computer | 231 |
| | Software Start Guide | 232 |
| | Downloading and Viewing the Software Instruction Manuals (PDF Files) | 234 |
| | Downloading Images to a Computer | 235 |
| | Index | 241 |



For Troubleshooting guide and Specifications, refer to the Instruction Manual downloadable from the Canon website. For how to download the Instruction Manual, see page 4.



Certification Logo

Select [**4: Certification Logo Display**] and press <SET> to display some of the logos of the camera's certifications. Other certification logos can be found in this Instruction Manual, on the camera body, and on the camera's package.

Safety Precautions

The following precautions are provided to prevent harm or injury to yourself and others. Make sure to thoroughly understand and follow these precautions before using the product.

If you experience any malfunctions, problems, or damage to the product, contact the nearest Canon Service Center or the dealer from whom you purchased the product.



Warnings: Follow the warnings below. Otherwise, death or serious injuries may result.

- To prevent fire, excessive heat, chemical leakage, explosions, and electrical shock, follow the safeguards below:
 - Do not use any batteries, power sources, or accessories not specified in the Instruction Manual. Do not use any home-made or modified batteries, or the product if it is damaged.
 - Do not short-circuit, disassemble, or modify the battery. Do not apply heat or solder to the battery. Do not expose the battery to fire or water. Do not subject the battery to strong physical shock.
 - Do not insert the battery's plus and minus ends incorrectly.
 - Do not recharge the battery in temperatures outside the allowable charging (working) temperature range. Also, do not exceed the recharging time indicated in the Instruction Manual.
 - Do not insert any foreign metallic objects into the electrical contacts of the camera, accessories, connecting cables, etc.
- When disposing of a battery, insulate the electrical contacts with tape. Contact with other metallic objects or batteries may cause a fire or an explosion.
- If excessive heat, smoke, or fumes are emitted when recharging the battery, immediately unplug the battery charger from the power outlet to stop recharging. Otherwise, it may cause a fire, heat damage, or electrical shock.
- If the battery leaks, changes color, deforms, or emits smoke or fumes, remove it immediately. Be careful not to get burned in the process. It may cause a fire, electrical shock or burns if you keep using it.
- Prevent any battery leakage from contacting your eyes, skin, and clothing. It can cause blindness or skin problems. If the battery leakage comes in contact with your eyes, skin, or clothing, flush the affected area with lots of clean water without rubbing it. See a physician immediately.
- Do not leave any cords near a heat source. It can deform the cord or melt the insulation and cause a fire or electrical shock.
- Do not hold the camera in the same position for long periods of time. Even if the camera does not feel too hot, prolonged contact with the same body part may cause skin redness or blistering due to low-temperature contact burns. Using a tripod is recommended for people with circulation problems or very sensitive skin, or when using the camera in very hot places.
- Do not fire the flash at anyone driving a car or other vehicle. It may cause an accident.

- When the camera or accessories are not in use, make sure to remove the battery, and disconnect the power plug and connecting cables from the equipment before storing. This is to prevent electrical shock, excessive heat, fire, and corrosion.
- Do not use the equipment where there is flammable gas. This is to prevent an explosion or a fire.
- If you drop the equipment and the casing breaks open to expose the internal parts, do not touch the exposed parts. There is a possibility of an electrical shock.
- Do not disassemble or modify the equipment. High-voltage internal parts may cause electrical shock.
- Do not look at the sun or an extremely bright light source through the camera or lens. Doing so may damage your vision.
- Keep equipment out of the reach of children and infants, including when in use. Straps or cords may accidentally cause choking, electrical shock, or injury. Choking or injury may also occur if a child or infant accidentally swallows a camera part or accessory. If a child or infant swallows a part or accessory, consult a physician immediately.
- Do not use or store the equipment in dusty or humid places. Likewise, keep the battery away from metallic items and store it with its protective cover attached to prevent short-circuit. This is to prevent fire, excessive heat, electrical shock, and burns.
- Before using the camera inside an airplane or hospital, check if it is allowed. Electromagnetic waves emitted by the camera may interfere with the plane's instruments or the hospital's medical equipment.
- To prevent a fire and electrical shock, follow the safeguards below:
 - Always insert the power plug all the way in.
 - Do not handle a power plug with wet hands.
 - When unplugging a power plug, grasp and pull the plug instead of the cord.
 - Do not scratch, cut, or excessively bend the cord or put a heavy object on the cord. Also, do not twist or tie the cords.
 - Do not connect too many power plugs to the same power outlet.
 - Do not use a cord whose wire is broken or insulation is damaged.
- Unplug the power plug periodically and clean off the dust around the power outlet with a dry cloth. If the surrounding is dusty, humid, or oily, the dust on the power outlet may become moist and short-circuit the outlet, causing a fire.
- Do not connect the battery directly to an electrical outlet or a car's cigarette lighter outlet. The battery may leak, generate excessive heat or explode, causing fire, burns, or injuries.
- A thorough explanation of how to use the product by an adult is required when the product is used by children. Supervise children while they are using the product. Incorrect usage may result in electrical shock or injury.
- Do not leave a lens or lens-attached camera in the sun without the lens cap attached. Otherwise, the lens may concentrate the sun's rays and cause a fire.
- Do not cover or wrap the product with a cloth. Doing so may trap heat within and cause the casing to deform or catch fire.
- Be careful not to get the camera wet. If you drop the product in the water or if water or metal get inside the product, promptly remove the battery. This is to prevent fire, electrical shock, and burns.
- Do not use paint thinner, benzene, or other organic solvents to clean the product. Doing so may cause fire or a health hazard.



Cautions: Follow the cautions below. Otherwise, physical injury or property damage may result.

- Do not use or store the product in a high-temperature location such as inside a car under the hot sun. The product may become hot and cause burns. Doing so may also cause battery leakage or explosion, which will degrade the performance or shorten the life of the product.
- Do not carry the camera around when it is attached to a tripod. Doing so may cause an injury or an accident. Also make sure the tripod is sturdy enough to support the camera and lens.
- Do not leave the product in a low-temperature environment for an extended period of time. The product will become cold and may cause injury when touched.
- Do not fire the flash near the eyes. It may hurt the eyes.

Handling Precautions

Camera Care

- This camera is a precision instrument. Do not drop it or subject it to physical shock.
- The camera is not waterproof and cannot be used underwater. If you accidentally drop the camera into water, promptly consult the nearest Canon Service Center. Wipe off any water droplets with a dry and clean cloth. If the camera has been exposed to salty air, wipe it with a clean, well-wrung wet cloth.
- Never leave the camera near anything having a strong magnetic field such as a magnet or electric motor. Also, avoid using or leaving the camera near anything emitting strong radio waves, such as a large antenna. Strong magnetic fields can cause camera misoperation or destroy image data.
- Do not leave the camera in excessive heat, such as in a car in direct sunlight. High temperatures can cause the camera to malfunction.
- The camera contains precision electronic circuitry. Never attempt to disassemble the camera yourself.
- Do not block the built-in flash or mirror operation with your finger, etc. Doing so may cause a malfunction.
- Use only a commercially-available blower to blow away dust when it adheres to the lens, viewfinder, reflex mirror, focusing screen, etc. Do not use cleaners that contain organic solvents to clean the camera body or lens. For stubborn dirt, take the camera to the nearest Canon Service Center.
- Do not touch the camera's electrical contacts with your fingers. This is to prevent the contacts from corroding. Corroded contacts may cause camera malfunction.
- If the camera is suddenly brought in from the cold into a warm room, condensation may form on the camera and internal parts. To prevent condensation, first put the camera in a sealed plastic bag and let it adjust to the warmer temperature before taking it out of the bag.

- If condensation forms on the camera, do not use the camera. This is to avoid damaging the camera. If there is condensation, remove the lens, card and battery from the camera, and wait until condensation has evaporated before using the camera.
- If the camera will not be used for an extended period, remove the battery and store the camera in a cool, dry, well-ventilated location. Even while the camera is in storage, press the shutter button a few times once in a while to check that the camera is still working.
- Avoid storing the camera where there are chemicals that result in rust and corrosion such as in a chemical lab.
- If the camera has not been used for an extended period, test all its functions before using it. If you have not used the camera for some time or if there is an important shoot such as a foreign trip coming up, have the camera checked by your nearest Canon Service Center or check the camera yourself and make sure it is working properly.
- If you use continuous shooting, Live View shooting, or movie shooting for a prolonged period, the camera may become hot. This is not a malfunction.
- If there is a bright light source inside or outside the image area, ghosting may occur.

LCD Panel and LCD Monitor

- Although the LCD monitor is manufactured with very high precision technology with over 99.99% effective pixels, there may be a few dead pixels displaying only black or red, etc. among the remaining 0.01% or less pixels. Dead pixels are not a malfunction. They do not affect the images recorded.
- If the LCD monitor is left on for a prolonged period, screen burn-in may occur where you see remnants of what was displayed. However, this is only temporary and will disappear when the camera is left unused for a few days.
- The LCD monitor display may seem slow in low temperatures, or look black in high temperatures. It will return to normal at room temperature.

Cards

To protect the card and its recorded data, note the following:

- Do not drop, bend, or wet the card. Do not subject it to excessive force, physical shock, or vibration.
- Do not touch the card's electronic contacts with your fingers or anything metallic.
- Do not affix any stickers, etc., on the card.
- Do not store or use the card near anything that has a strong magnetic field, such as a TV set, speakers, or magnets. Also avoid places prone to having static electricity.
- Do not leave the card in direct sunlight or near a heat source.
- Store the card in a case, etc.
- Do not store the card in hot, dusty, or humid locations.

Lens

After detaching the lens from the camera, put down the lens with the rear end up and attach the rear lens cap to avoid scratching the lens surface and electrical contacts.



Nomenclature

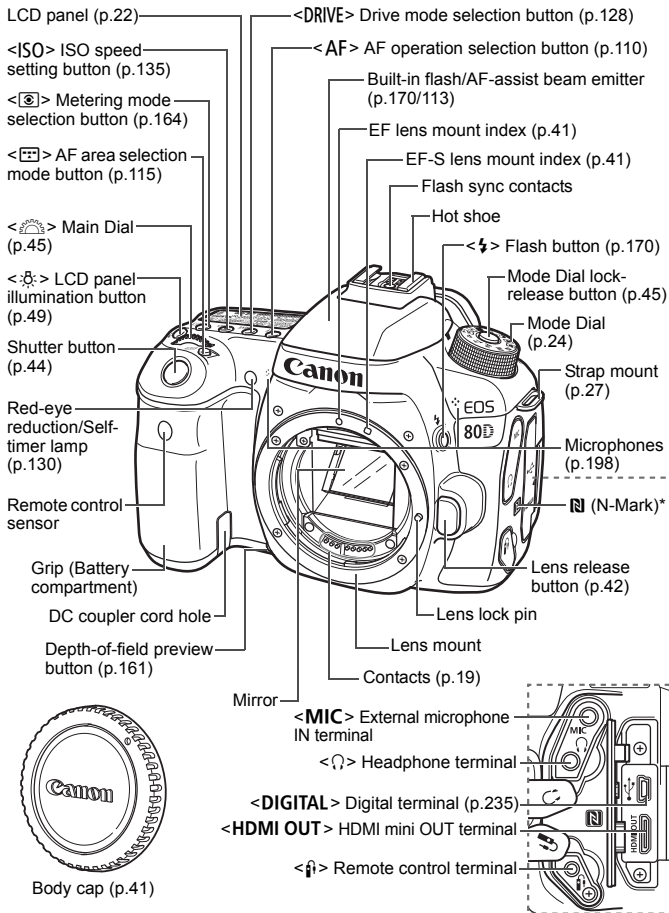

* Used for wireless connections via the NFC function.

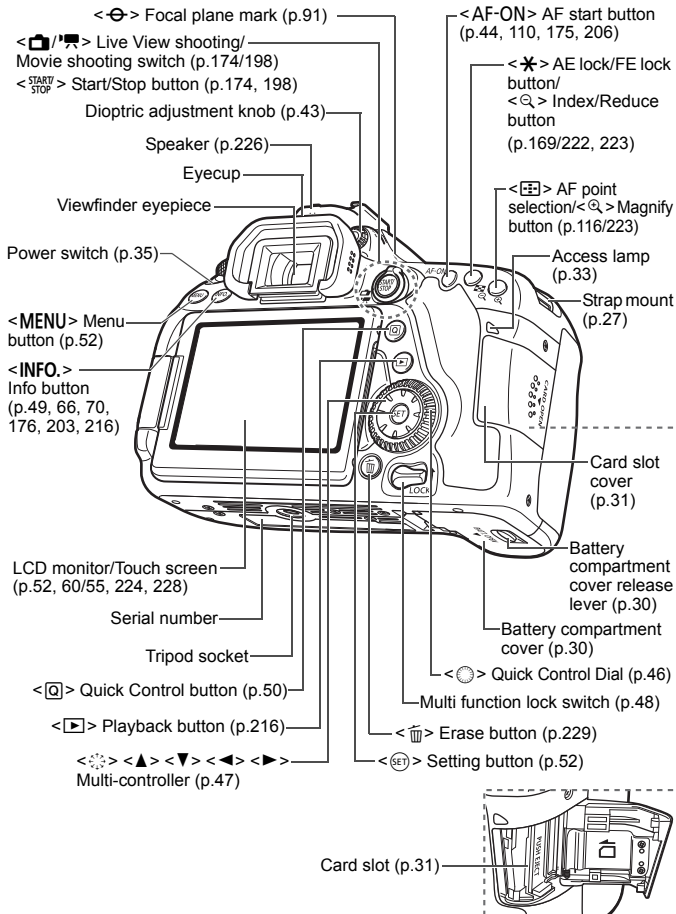

LCD Panel

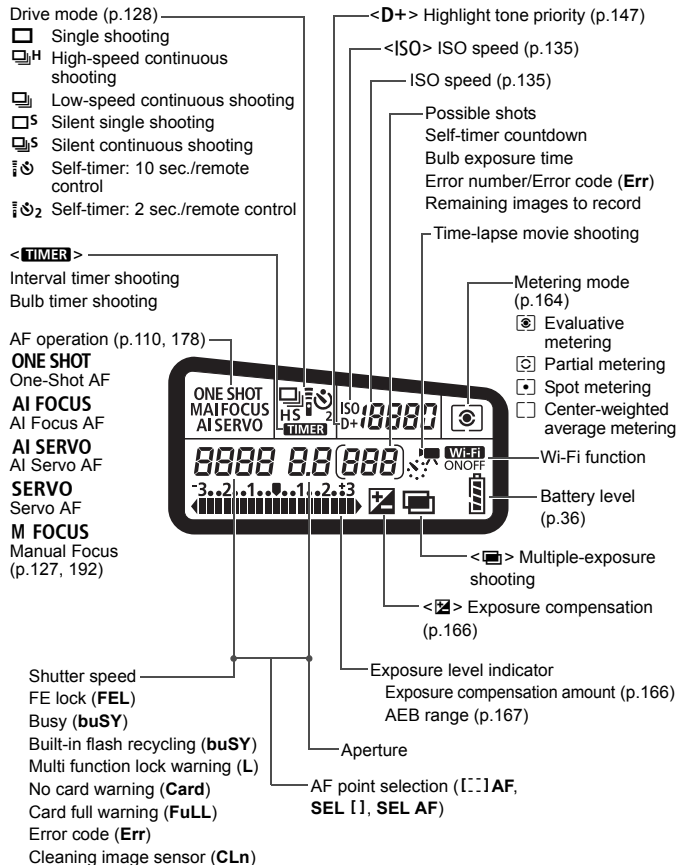

- The display will show only the settings currently applied.

Viewfinder Information

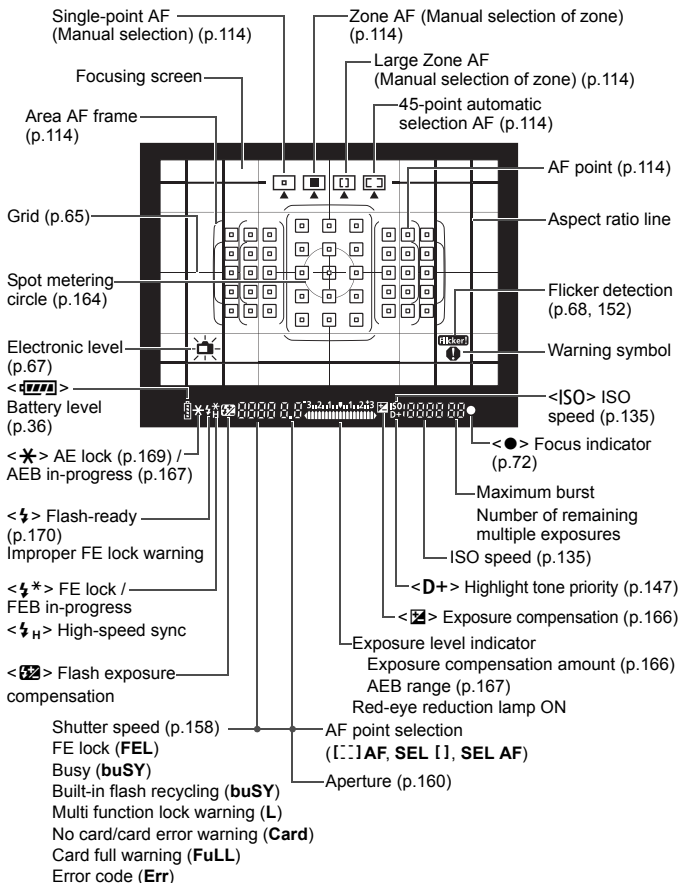

- The display will show only the settings currently applied.

Mode Dial

Turn the Mode Dial while holding down the Mode Dial center (Mode Dial lock-release button).



Basic Zone

All you do is press the shutter button. The camera sets everything to suit the subject or scene for shooting.

A+ : Scene Intelligent Auto (p.72)

Flash Off (p.77)

CA : Creative Auto (p.78)

SCN : Special scene (p.82)

| | | | |
|--|-----------------------------|--|------------------------------|
| | Food (p.83) | | HDR Backlight Control (p.88) |
| | Kids (p.84) | | Portrait (p.89) |
| | Candlelight (p.85) | | Landscape (p.90) |
| | Night Portrait (p.86) | | Close-up (p.91) |
| | Handheld Night Scene (p.87) | | Sports (p.92) |

Creative filters (p.95)

| | | | |
|--|--------------------------|--|------------------------------|
| | Grainy B/W (p.97) | | Water painting effect (p.98) |
| | Soft focus (p.97) | | HDR art standard (p.98) |
| | Fish-eye effect (p.98) | | HDR art vivid (p.99) |
| | Toy camera effect (p.98) | | HDR art bold (p.99) |
| | Miniature effect (p.98) | | HDR art embossed (p.99) |

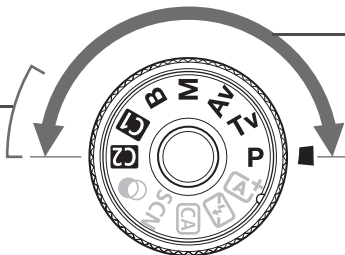



Creative Zone

These modes give you more control for shooting various subjects as desired.

- P** : Program AE (p.156)
- Tv** : Shutter-priority AE (p.158)
- Av** : Aperture-priority AE (p.160)
- M** : Manual exposure (p.162)
- B** : Bulb

Custom shooting mode

You can register the shooting mode (**P/Tv/Av/M/B**), AF operation, menu settings, etc., to ,  Mode Dial positions.

Battery Charger LC-E6

Charger for Battery Pack LP-E6N/LP-E6 (p.28).

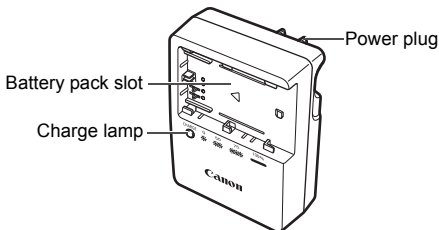

**IMPORTANT SAFETY INSTRUCTIONS-SAVE THESE INSTRUCTIONS.
DANGER-TO REDUCE THE RISK OF FIRE OR ELECTRIC SHOCK,
CAREFULLY FOLLOW THESE INSTRUCTIONS.**

For connection to a supply not in the U.S.A., use an attachment plug adapter of the proper configuration for the power outlet, if needed.

Battery Charger LC-E6E

Charger for Battery Pack LP-E6N/LP-E6 (p.28).

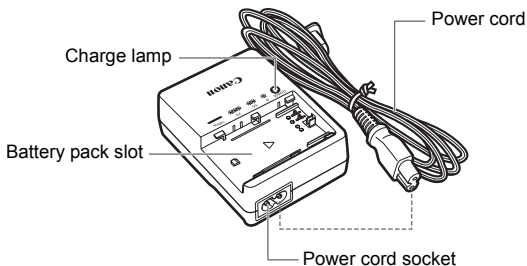

1

Getting Started

This chapter explains preparatory steps before you start shooting and basic camera operations.

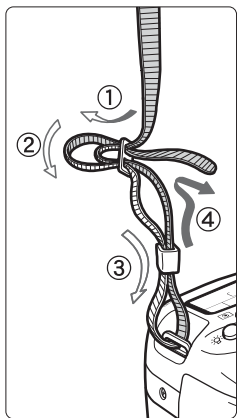

Attaching the Strap

Pass the end of the strap through the camera's strap mount eyelet from the bottom. Then pass it through the strap's buckle as shown in the illustration. Pull the strap to take up any slack and make sure the strap will not loosen from the buckle.

- The eyepiece cover is attached to the strap.

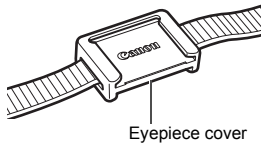

Charging the Battery

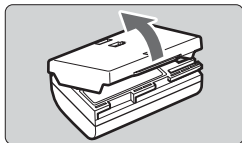

- 1 Remove the protective cover.**
- Detach the protective cover provided with the battery.

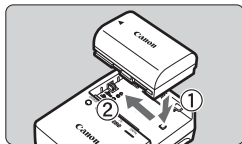

- 2 Attach the battery.**
- As shown in the illustration, attach the battery securely to the charger.
 - To detach the battery, follow the above procedure in reverse.

LC-E6

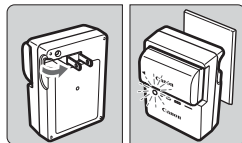

- 3 Recharge the battery.**
- For LC-E6**

- As shown by the arrow, flip out the battery charger's prongs and insert the prongs into a power outlet.

LC-E6E

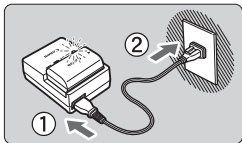

For LC-E6E

- Connect the power cord to the charger and insert the plug into a power outlet.
- Recharging starts automatically and the charge lamp blinks in orange.

| Charge Level | Charge lamp | |
|---------------|-------------|-------------------------------|
| | Color | Display |
| 0-49% | Orange | Blinks once per second |
| 50-74% | | Blinks twice per second |
| 75% or higher | | Blinks three times per second |
| Fully charged | Green | Lights up |

- **It takes approx. 2 hr. and 30 min. to fully recharge a completely exhausted battery at room temperature (23°C / 73°F).** The time required to recharge the battery will vary greatly depending on the ambient temperature and the battery's remaining capacity.
- For safety reasons, recharging in low temperatures (5°C - 10°C / 41°F - 50°F) will take longer (up to approx. 4 hr.).



Tips for Using the Battery and Charger

- **Upon purchase, the battery is not fully charged.**
Charge the battery before use.
- **Recharge the battery on the day before or on the day it is to be used.**
Even during storage, a charged battery will gradually drain and lose its capacity.
- **After recharging the battery, detach it and disconnect the charger from the power outlet.**
- **You can attach the cover in a different orientation to indicate whether the battery has been recharged or not.**

If the battery has been recharged, attach the cover so that the battery-shaped hole is aligned over the blue sticker on the battery. If the battery is exhausted, attach the cover in the opposite orientation.

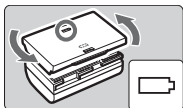

- **When not using the camera, remove the battery.**
If the battery is left in the camera for a prolonged period, a small amount of power current is released, resulting in excess discharge and shorter battery life. Store the battery with the protective cover attached. Storing the battery when it is fully charged may lower the battery's performance.
- **The battery charger can also be used in foreign countries.**
The battery charger is compatible with a 100 V AC to 240 V AC 50/60 Hz power source. If necessary, attach a commercially-available plug adapter for the respective country or region. Do not attach any portable voltage transformer to the battery charger. Doing so can damage the battery charger.
- **If the battery becomes exhausted quickly even after being fully charged, the battery has reached the end of its service life.**
Check the battery's recharge performance and purchase a new battery.



- After disconnecting the charger's power plug, do not touch the prongs for approx. 10 sec.
- If the battery's remaining capacity is 94% or higher, the battery will not be recharged.
- The charger cannot charge any battery other than Battery Pack LP-E6N/LP-E6.

Installing and Removing the Battery

Load a fully-charged Battery Pack LP-E6N (or LP-E6) into the camera. The camera's viewfinder becomes bright when a battery is installed, and darkens when the battery is removed. If the battery is not installed, the picture in the viewfinder becomes blurred and focus cannot be achieved.

Installing the Battery

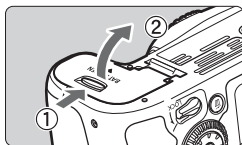

1 Open the cover.

- Slide the lever as shown by the arrows and open the cover.

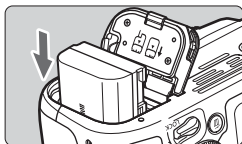

2 Insert the battery.

- Insert the end with the electrical contacts.
- Insert the battery until it locks in place.

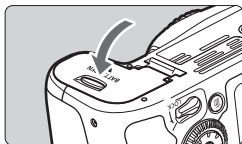

3 Close the cover.

- Press the cover until it snaps shut.

 Only Battery Pack LP-E6N/LP-E6 can be used.

Removing the Battery

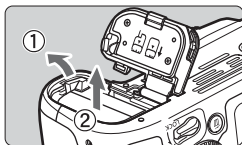

Open the cover and remove the battery.

- Press the battery lock lever as shown by the arrow and remove the battery.
- To prevent short circuiting of the electrical contacts, be sure to attach the provided protective cover (p.28) to the battery.

Installing and Removing the Card

You can use an SD, SDHC, or SDXC memory card (sold separately) with the camera. SDHC and SDXC memory cards with UHS-I can also be used. The captured images are recorded onto the card.

- Make sure the card's write-protect switch is set upward to enable writing and erasing.

Installing the Card

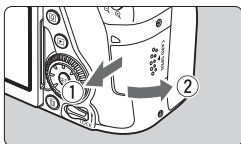

1 Open the cover.

- Slide the cover as shown by the arrows to open it.

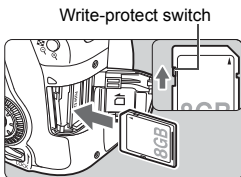

2 Insert the card.

- As shown by the illustration, face the card's label side toward you and insert it until it clicks in place.

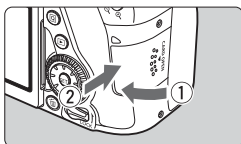

3 Close the cover.

- Close the cover and slide it in the direction shown by the arrows until it snaps shut.
- When you set the power switch to <ON>, the number of possible shots will be displayed on the LCD panel.

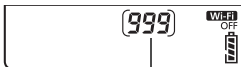

Possible shots

- The number of possible shots depends on the remaining capacity of the card, image-recording quality, ISO speed, etc.
- Setting [**1**: **Release shutter without card**] to [**Disable**] will prevent you from shooting without a card inserted.

Removing the Card

Access lamp

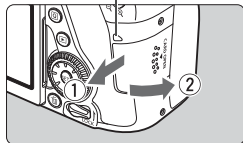

1 Open the cover.

- Set the power switch to <OFF>.
- **Make sure the access lamp is off, then open the cover.**
- If [**Recording...**] is displayed, close the cover.

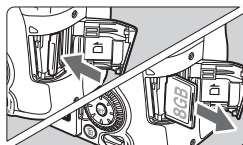

2 Remove the card.

- Gently push in the card, then let go to eject it.
- Pull the card straight out, then close the cover.



- **When the access lamp is lit or blinking, it indicates that images are being written to, read from, or erased from the card, or data is being transferred. Do not open the card slot cover during this time. Also, never do any of the following while the access lamp is lit or blinking. Otherwise, it can damage the image data, card, or camera.**
 - **Removing the card.**
 - **Removing the battery.**
 - **Shaking or banging the camera around.**
 - **Unplugging and connecting a power cord** (when household power outlet accessories (sold separately) are used).
- If the card already contains recorded images, the image number may not start from 0001.
- If a card-related error message is displayed on the LCD monitor, remove and reinsert the card. If the error persists, use a different card. If you can transfer all the images on the card to a computer, transfer all the images and then format the card with the camera (p.58). The card may then return to normal.
- Do not touch the card's contacts with your fingers or metal objects. Do not expose the contacts to dust or water. If a smudge adheres to the contacts, contact failure may result.
- Multimedia cards (MMC) cannot be used (card error will be displayed).

Using the LCD Monitor

After you flip out the LCD monitor, you can set menu functions, use Live View shooting, shoot movies, or play back images and movies. You can change the direction and angle of the LCD monitor.

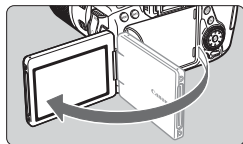

1 Flip out the LCD monitor.

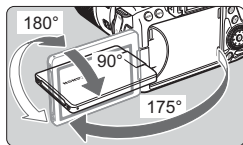

2 Rotate the LCD monitor.

- When the LCD monitor is swung out, you can rotate it up, down, or over 180° to face the subject.
- The indicated angle is only approximate.



3 Face it toward you.

- Normally, use the camera with the LCD monitor facing you.

 Be careful not to force and break the hinge when rotating the LCD monitor.

- 
- When not using the camera, close the LCD monitor with the screen facing inward. This will protect the screen.
 - During Live View shooting or movie shooting, facing the LCD monitor toward the subject will display a mirror image on the screen (right/left reversed).

Turning on the Power

If you turn on the power switch and the date/time/zone setting screen appears, see page 37 to set the date/time/zone.

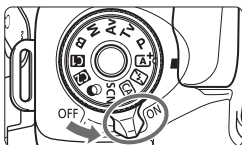

- <ON> : The camera turns on.
- <OFF> : The camera is turned off and does not function. Set to this position when not using the camera.

Automatic Sensor Cleaning

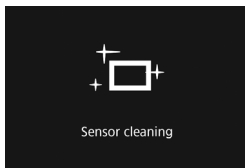

- Whenever you set the power switch to <ON> or <OFF>, sensor cleaning will be performed automatically. (A small sound may be heard.) During the sensor cleaning, the LCD monitor will display <[Sensor Cleaning Icon]>.

- You can still shoot during sensor cleaning by pressing the shutter button halfway (p.44) to stop cleaning and take a picture.
- If you repeatedly turn the power switch <ON>/<OFF> at a short interval, the <[Sensor Cleaning Icon]> icon may not be displayed. This is normal and not a malfunction.

MENU Auto Power Off

- To save battery power, the camera turns off automatically after approx. 1 minute of non-operation. To turn on the camera again, just press the shutter button halfway (p.44).
- You can change the auto power off time with [**F2: Auto power off**] (p.60).







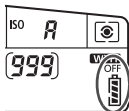

If you set the power switch to <OFF> while an image is being recorded to the card, [**Recording...**] will be displayed and the power will turn off after the recording finishes.

Battery Level Indicator

When the power switch is set to <ON>, the battery level will be indicated in one of six levels. A blinking battery icon () indicates that the battery will be exhausted soon.



| Display |  |  |  |  |  |  |
|-----------|---|---|---|---|---|---|
| Level (%) | 100 - 70 | 69 - 50 | 49 - 20 | 19 - 10 | 9 - 1 | 0 |



Number of Possible Shots

(Approx. number of shots)

| Temperature | Room Temperature (23°C / 73°F) | Low Temperatures (0°C / 32°F) |
|---------------|-----------------------------------|----------------------------------|
| No Flash | 1390 | 1250 |
| 50% Flash Use | 960 | 860 |

- The figures above are based on a fully-charged Battery Pack LP-E6N, no Live View shooting, and CIPA (Camera & Imaging Products Association) testing standards.
- Possible shots with Battery Grip BG-E14 (sold separately)
 - With LP-E6N x 2: approx. twice the shots without the battery grip.
 - With AA/LR6 alkaline batteries at room temperature (23°C / 73°F): approx. 560 shots with no flash, approx. 400 shots with 50% flash use.



- Doing any of the following will exhaust the battery sooner:
 - Pressing the shutter button halfway for a prolonged period.
 - Activating the AF frequently without taking a picture.
 - Using the lens Image Stabilizer.
 - Using the LCD monitor frequently.
- The number of possible shots may decrease depending on the actual shooting conditions.
- The lens operation is powered by the camera's battery. Depending on the lens used, the battery power may exhaust faster.
- For the number of possible shots with Live View shooting, see page 175.
- See [**43: Battery info.**] to check the battery condition in detail.
- With Battery Grip BG-E14 (sold separately) loaded with AA/R6 batteries, a four-level indicator will be displayed. (/) will not be displayed.)

MENU Setting the Date, Time, and Zone

When you turn on the power for the first time or if the date/time/zone have been reset, the date/time/zone setting screen will appear. Follow the steps below to set the time zone first. Set the camera to the time zone in which you currently live so that, when you travel, you can simply change the setting to the correct time zone for your destination, and the camera will automatically adjust the date/time.

Note that the date/time appended to recorded images will be based on this date/time setting. Be sure to set the correct date/time.

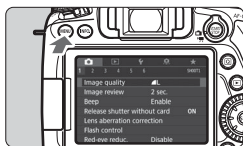

1 Display the menu screen.

- Press the <MENU> button to display the menu screen.

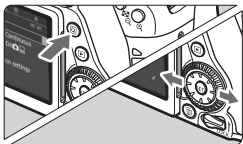

2 Under the [F2] tab, select [Date/Time/Zone].

- Press the <Q> button and select the [F2] tab.
- Press the <◀> <▶> keys to select the [F2] tab.
- Press the <▲> <▼> keys to select [Date/Time/Zone], then press <SET>.

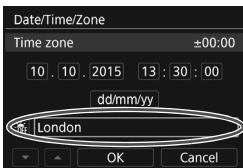
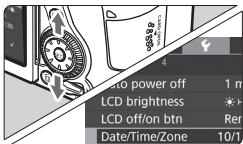

3 Set the time zone.

- [London] is set by default.
- Press the <◀> <▶> keys to select [Time zone], then press <SET>.



- The menu setting procedure is explained on page 52.
- In step 3, the time displayed in [Time zone] is the time difference compared with Coordinated Universal Time (UTC).

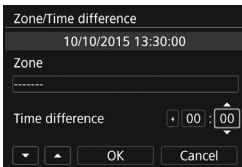
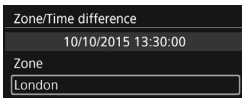

- Select the [**Zone**] box, then press $\langle \text{SET} \rangle$.
- Press the $\langle \blacktriangle \rangle$ $\langle \blacktriangledown \rangle$ keys to select the time zone, then press $\langle \text{SET} \rangle$.
- If you do not see your time zone, you can also set the time difference with UTC directly. In such a case, press the $\langle \blacktriangleleft \rangle$ $\langle \blacktriangleright \rangle$ keys to select the [**Time difference**] box, then press $\langle \text{SET} \rangle$ so $\langle \square \rangle$ is displayed.
- Press the $\langle \blacktriangle \rangle$ $\langle \blacktriangledown \rangle$ keys to set, then press $\langle \text{SET} \rangle$. (Returns to $\langle \square \rangle$.)
- After setting, press the $\langle \blacktriangleleft \rangle$ $\langle \blacktriangleright \rangle$ keys to select [**OK**], then press $\langle \text{SET} \rangle$. The previous screen will reappear.

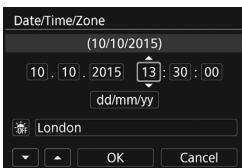

4 Set the date and time.

- Press the $\langle \blacktriangleleft \rangle$ $\langle \blacktriangleright \rangle$ keys to select the number.
- Press $\langle \text{SET} \rangle$ so $\langle \square \rangle$ is displayed.
- Press the $\langle \blacktriangle \rangle$ $\langle \blacktriangledown \rangle$ keys to set, then press $\langle \text{SET} \rangle$. (Returns to $\langle \square \rangle$.)

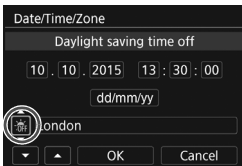

5 Set the daylight saving time.

- Set it if necessary.
- Press the $\langle \blacktriangleleft \rangle$ $\langle \blacktriangleright \rangle$ keys to select [☀].
- Press $\langle \text{SET} \rangle$ so $\langle \square \rangle$ is displayed.
- Press the $\langle \blacktriangle \rangle$ $\langle \blacktriangledown \rangle$ keys to select [☀], then press $\langle \text{SET} \rangle$.
- When the daylight saving time is set to [☀], the time set in step 4 will advance by 1 hour. If [☀] is set, the daylight saving time will be canceled and the time will go back by 1 hour.

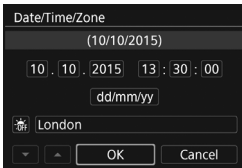

6 Exit the setting.

- Press the <◀> <▶> keys to select [OK], then press <SET>.
- ▶ The date/time/zone and daylight saving time will be set and the menu will reappear.



The date/time/zone settings may be reset in the following cases. If this happens, set the date/time/zone again.

- When the camera is stored without the battery.
- When the camera's battery becomes exhausted.
- When the camera is exposed to below freezing temperatures for a prolonged period.



- The date/time that were set will start when you select [OK] in step 6.
- After changing the time zone or time difference setting, check that the correct date and time are set.

MENU Selecting the Interface Language

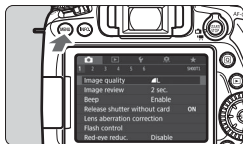

1 Display the menu screen.

- Press the <MENU> button to display the menu screen.

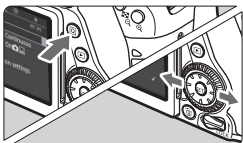

2 Under the [F2] tab, select [Language].

- Press the <Q> button and select the [F2] tab.
- Press the <◀> <▶> keys to select the [F2] tab.
- Press the <▲> <▼> keys to select the [Language], then press <SET>.

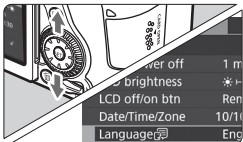

3 Set the desired language.

- Press the <▲> <▼> keys to select the language, then press <SET>.
- ▶ The interface language will change.



Attaching and Detaching a Lens

The camera is compatible with all Canon EF and EF-S lenses. **The camera cannot be used with EF-M lenses.**

Attaching a Lens

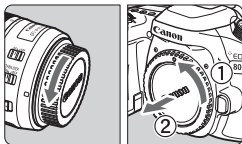

1 Remove the caps.

- Remove the rear lens cap and the body cap by turning them as shown by the arrows.

White index

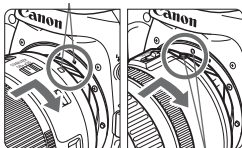

2 Attach the lens.

- Align the lens's red or white index with the camera's index matching the same color. Turn the lens as shown by the arrow until it clicks in place.

Red index

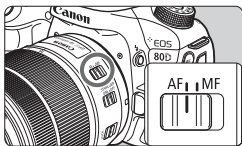

3 Set the lens's focus mode switch to <AF>.

- <AF> stands for autofocus.
- If it is set to <MF> (manual focus), autofocus will not operate.

4 Remove the front lens cap.

Minimizing Dust

- When changing lenses, do it quickly in a place with minimal dust.
- When storing the camera without a lens attached, be sure to attach the body cap to the camera.
- Remove dust on the body cap before attaching it.

Zooming

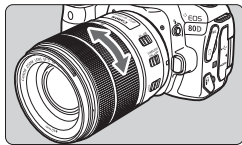

Turn the zoom ring on the lens with your fingers.

- If you want to zoom, do it before focusing. Turning the zoom ring after achieving focus may throw off the focus.

Detaching the Lens

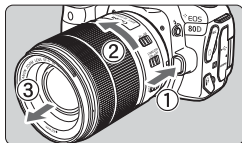

While pressing the lens release button, turn the lens as shown by the arrow.

- Turn the lens until it stops, then detach it.
- Attach the rear lens cap to the detached lens.

- Do not look at the sun directly through any lens. Doing so may cause loss of vision.
- **When attaching or detaching a lens, set the camera's power switch to <OFF>.**
- If the front part (focusing ring) of the lens rotates during autofocus, do not touch the rotating part.



Angle of View

Since the image sensor size is smaller than the 35mm film format, the effective angle of view of an attached lens will be equivalent to that of a lens with approx. 1.6x of the focal length indicated.



Image sensor size (Approx.)
(22.3 x 14.9 mm /
0.88 x 0.59 in.)
35mm film size
(36 x 24 mm /
1.42 x 0.94 in.)

Basic Operation

Adjusting the Viewfinder Clarity



Turn the dioptic adjustment knob.

- Turn the knob left or right so that the AF points in the viewfinder look the sharpest.
- If the knob is difficult to turn, remove the eyecup.



If the camera dioptic adjustment still cannot provide a sharp viewfinder image, using E-series Dioptic Adjustment Lenses (sold separately) is recommended.

Holding the Camera

To obtain sharp images, hold the camera still to minimize camera shake.

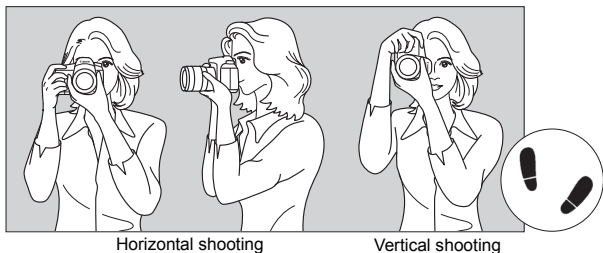

Horizontal shooting

Vertical shooting

1. Wrap your right hand around the camera grip firmly.
2. Hold the lens bottom with your left hand.
3. Rest your hand's right index finger lightly on the shutter button.
4. Press your arms and elbows lightly against the front of your body.
5. To maintain a stable stance, place one foot slightly ahead of the other.
6. Press the camera against your face and look through the viewfinder.



To shoot while looking at the LCD monitor, see pages 76 and 173.

Shutter Button

The shutter button has two steps. You can press the shutter button halfway. Then you can further press the shutter button completely.

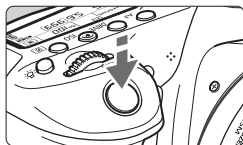

Pressing Halfway

This activates autofocus and the automatic exposure system that sets the shutter speed and aperture.

The exposure setting (shutter speed and aperture) is displayed in the viewfinder and on the LCD panel (4).

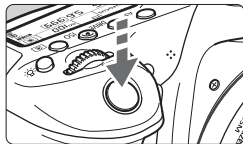

Pressing Completely

This releases the shutter and takes the picture.

Preventing Camera Shake

Hand-held camera movement during the moment of exposure is called camera shake. It can cause blurred pictures. To prevent camera shake, note the following:

- Hold and steady the camera as shown on the preceding page.
- Press the shutter button halfway to autofocus, then slowly press the shutter button completely.



- In Creative Zone modes, pressing the <AF-ON> button is the same as pressing the shutter button halfway.
- If you press the shutter button completely without pressing it halfway first, or if you press the shutter button halfway and then press it completely immediately, the camera will take a moment before it takes the picture.
- Even during menu display, image playback, or image recording, you can go back to shooting-ready by pressing the shutter button halfway.

Mode Dial

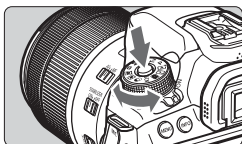



Turn the dial while holding down the lock release button at the center of the dial.



Use it to set the shooting mode.

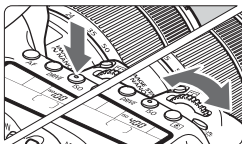

Main Dial





- (1) **After pressing a button, turn the  dial.**

When you press a button such as <AF> <DRIVE> <ISO> <>, the respective function remains selected for the duration of the timer (6). During this time, you can turn the  dial to set the desired setting.

When the function selection ends or if you press the shutter button halfway, the camera will be ready to shoot.

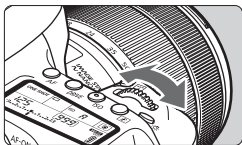
- Use this dial to select or set the AF operation, drive mode, ISO speed, metering mode, AF point selection, etc.



- (2) **Turn the  dial only.**

While looking at the viewfinder or LCD panel, turn the  dial to change the setting.

- Use this dial to set the shutter speed, aperture, etc.



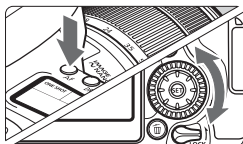

The operations in (1) are possible even when the <LOCK> switch is set upward (Multi function lock, p.48).

Quick Control Dial



(1) After pressing a button, turn the dial.

When you press a button such as <AF> <DRIVE> <ISO> <>, the respective function remains selected for the duration of the timer (6). During this time, you can turn the  dial to set the desired setting.

When the function selection ends or if you press the shutter button halfway, the camera will be ready to shoot.

- Use this dial to select or set the AF operation, drive mode, ISO speed, metering mode, AF point selection, etc.

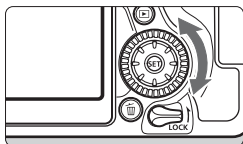

(2) Turn the dial only.

While looking at the viewfinder or LCD panel, turn the  dial to change the setting.





- Use this dial to set the exposure compensation amount, the aperture setting for manual exposures, etc.

 The operations in (1) are possible even when the <LOCK> switch is set upward (Multi function lock, p.48).

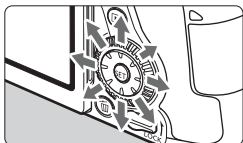
Multi-controller

The Multi-controller <> has eight keys that tilt in the directions shown by the arrows.



- Use the eight keys to select the AF point, correct the white balance, move the AF point or magnifying frame during Live View shooting or movie shooting, or scroll around magnified images during playback.
- For menus and the Quick Control, the Multi-controller works only in the vertical and horizontal directions < > < > < > < >. It does not work in diagonal directions.



AF point selection, white balance correction, and scrolling around magnified images during playback are possible even when the <**LOCK**> switch is set upward (Multi function lock, p.48).

LOCK Multi Function Lock

With [**F4**: Multi function lock] set and the <**LOCK**> switch set upward, the camera prevents you from changing settings inadvertently by moving the Main Dial, Quick Control Dial, and Multi-controller or by touching the touch panel.

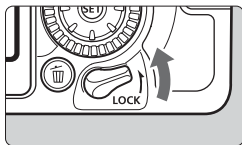

<**LOCK**> switch set downward: Lock released

<**LOCK**> switch set upward: Lock engaged

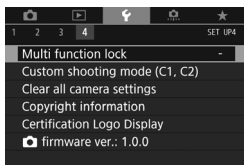

1 Select [Multi function lock].

- Under the [**F4**] tab, select [**Multi function lock**], then press <**SET**>.

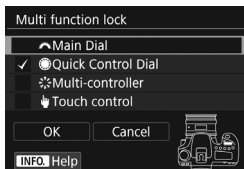





2 Add a checkmark [✓] to the camera control to be locked.

- Select a camera control and press <**SET**> to add a checkmark [✓].
- Select [**OK**].
- ▶ The selected camera controls will be locked when the multi function lock switch is in the locked position.

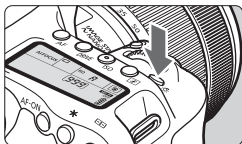
- If the <**LOCK**> switch is set upward and you try to use one of the locked camera controls (except when [**Touch control**] is set), <**L**> will be displayed in the viewfinder and on the LCD panel. On the shooting function settings display (p.49), [**LOCK**] will be displayed. During Live View shooting, [**LOCK**] will be displayed on the LCD monitor.
- By default, when locked, the <**SET**> dial will be locked.
- In Basic Zone modes, only [**Touch control**] is settable.

LCD Panel Illumination



You can illuminate the LCD panel by pressing the  button. Turn on () or off the LCD panel illumination by pressing the  button.



During a bulb exposure, pressing the shutter button completely will turn off the LCD panel illumination.

Displaying Shooting Function Settings

After you press the **<INFO.>** button a number of times, the shooting function settings will be displayed.

With the shooting function settings displayed, you can turn the Mode Dial to see the settings for each shooting mode.

Pressing the **<Q>** button enables Quick Control of the shooting function settings (p.50).

Press the **<INFO.>** button again to turn off the display.



Q Quick Control for Shooting Functions

You can directly select and set the shooting functions displayed on the LCD monitor. This is called Quick Control.

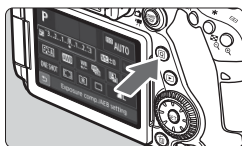

1 Press the **<Q>** button (ⓘ10).

- ▶ The Quick Control screen will appear.

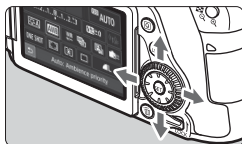

2 Set the desired function.

- Press the **<▲>** **<▼>** or **<◀>** **<▶>** keys to select a function.
- ▶ The settings of the selected function and Feature guide (p.69) will appear.
- Turn the **<☀>** or **<☺>** dial to change the setting.

Basic Zone modes

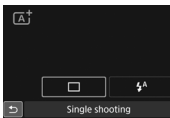
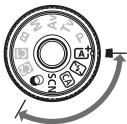

Creative Zone modes



3 Take the picture.

- Press the shutter button completely to take the picture.
- ▶ The captured image will be displayed.

- For the functions settable in Basic Zone modes and their setting procedures, see page 101.
- In steps 1 and 2, you can also use the LCD monitor's touch screen (p.55).

Sample Quick Control Screen

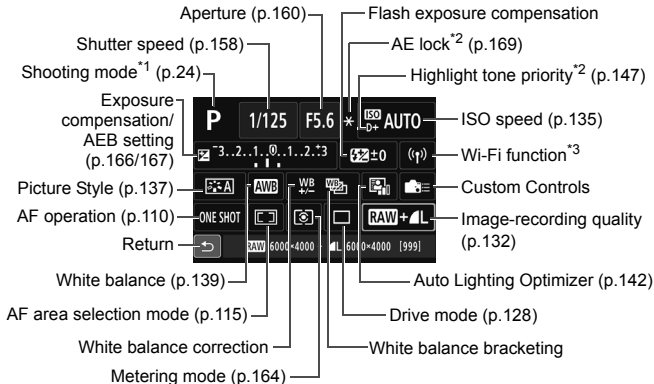

- *1 : Settable only when the Mode Dial is set to <SCN> or <Q>.
- *2 : These functions cannot be set with Quick Control.
- *3 : Refer to the Wireless Function Instruction Manual.

Quick Control

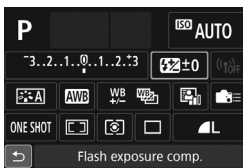

↓ <SET>

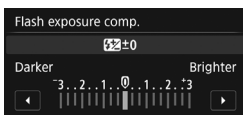

- Select the desired function and press <SET>. The function's setting screen will appear.
- Turn the <WHEEL> or <DIAL> dial or press the <LEFT> <RIGHT> keys to change the settings. There are also some functions that are set by pressing the <INFO.>, <INFO.>, or <INFO.> button.
- Press <SET> to finalize the setting and return to the Quick Control screen.
- When you select <MENU> or <MENU> (p.114) and press the <MENU> button, the previous screen will reappear.

MENU Menu Operations

You can set various settings with the menus such as the image-recording quality, date and time, etc.

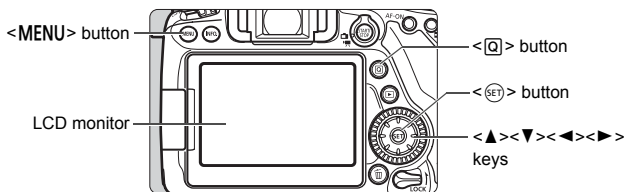

Menus in Basic Zone Modes

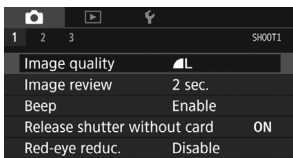
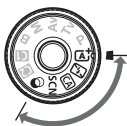

* Some menu tabs and menu items are not displayed in Basic Zone modes.

Menus in Creative Zone Modes

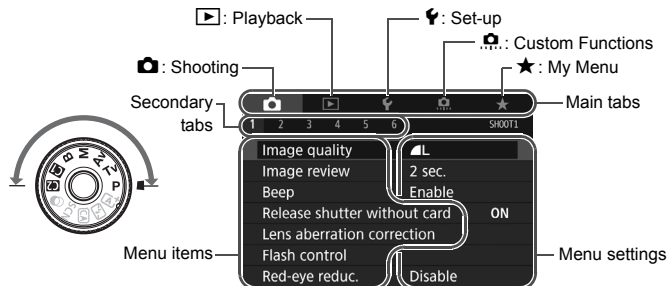

Menu Setting Procedure

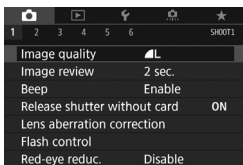

1 Display the menu screen.

- Press the <MENU> button to display the menu screen.

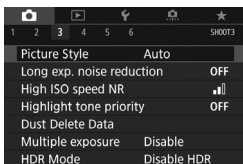

2 Select a tab.

- Each time you press the <Q> button, the main tab (group of functions) will switch.
- Press the <◀> <▶> keys to select a secondary tab.
- For example, in this manual, the [3] tab refers to the screen displayed when the (Shooting) tab's [3] is selected.

3 Select the desired item.

- Press the <▲> <▼> keys to select the item, then press <SET>.



4 Select the setting.

- Press the <▲> <▼> or <◀> <▶> keys to select the desired setting. (Some settings require you to press either the <▲> <▼> or <◀> <▶> keys to select those settings.)
- The current setting is indicated in blue.

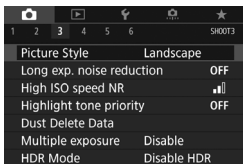

5 Set the desired setting.

- Press <SET> to set it.

6 Exit the setting.

- Press the <MENU> button to return to the shooting function settings display.

- In step 2, you can also turn the <☀> dial to select a menu tab. In step 4, you can also turn the <☉> dial to select certain settings.
- In steps 2 to 5, you can also use the LCD monitor's touch screen (p.55).
- The explanation of menu functions hereafter assumes that you have pressed the <MENU> button to display the menu screen.
- To cancel the operation, press the <MENU> button.

Dimmed Menu Items

Example: When Multi Shot Noise Reduction is set

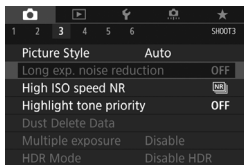

Dimmed menu items cannot be set. The menu item is dimmed if another function setting is overriding it.

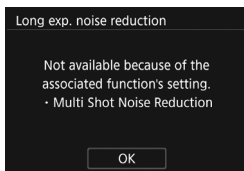

You can see the overriding function by selecting the dimmed menu item and pressing <SET>.

If you cancel the overriding function's setting, the dimmed menu item will become settable.

Some dimmed menu items will not show the overriding function.

With [**4**: **Clear all camera settings**], you can reset the menu functions to the default settings (p.62).

Using the Touch Screen

The LCD monitor is a touch-sensitive panel that you can operate with your fingers.

Tap

Sample Display (Quick Control)

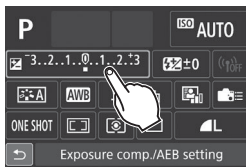
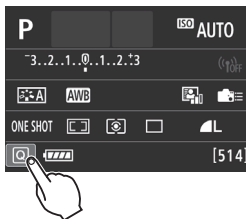

- Use your finger to tap on (touch briefly and then remove your finger from) the LCD monitor.
- By tapping, you can select menus, icons, etc., displayed on the LCD monitor.
- When touch-screen operation is possible, a frame will appear around the icon (except on menu screens). For example, when you tap on [Q], the Quick Control screen appears. By tapping on [↶], you can return to the preceding screen.

Operations possible by tapping on the screen

- Setting menu functions after pressing the <MENU> button
- Quick Control
- Setting functions after pressing the <AF>, <DRIVE>, <ISO>, <Q>, <A>, or <M> button
- Touch shutter during Live View shooting
- Setting functions during Live View shooting
- Setting functions during movie shooting
- Playback operations

Drag

Sample Display (Menu screen)

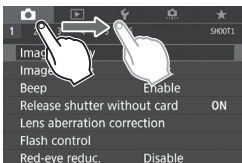

- Slide your finger while touching the LCD monitor.

Sample Display (Scale display)

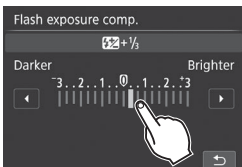

Operations possible by dragging your finger on the screen

- Selecting a menu tab or item after pressing the <MENU> button
- Setting a scale control
- Quick Control
- Selecting AF points
- Setting functions during Live View shooting
- Setting functions during movie shooting
- Playback operations

MENU Silencing the Beep during Touch Operations

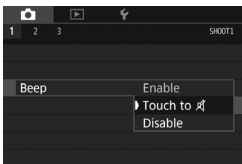

If [**1: Beep**] is set to [**Touch to [mute icon]**], the beep will not sound during touch operations.

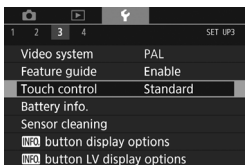
MENU Touch Control Settings**1 Select [Touch control].**

- Under the [**3**] tab, select [**Touch control**], then press <SET>.

**2 Set the touch control setting.**

- Select the desired setting, then press <SET>.
- [**Standard**] is the normal setting.
- [**Sensitive**] provides a more reactive touch response than [**Standard**]. Try using both settings and select the one you prefer.
- To disable touch-screen operations, select [**Disable**].

⚠ Cautions for Touch Screen Operations

- Since the LCD monitor is not pressure sensitive, do not use any sharp objects, such as your fingernail or a ballpoint pen, for touch operations.
- Do not use wet fingers for touch screen operations.
- If the LCD monitor has any moisture or if your fingers are wet, the touch screen may not respond or misoperation may occur. In such a case, turn off the power and wipe the LCD monitor with a cloth.
- Attaching a commercially-available protective sheet or sticker on the LCD monitor may make the touch operation response slow.
- If you quickly perform touch operation when [**Sensitive**] is set, the touch response may be slower.

Before You Start

MENU Formatting the Card

If the card is new or was previously formatted by another camera or computer, format the card with this camera.

! When the card is formatted, all images and data on the card will be erased. Even protected images will be erased, so make sure there is nothing you need to keep. If necessary, transfer the images and data to a computer, etc., before formatting the card.

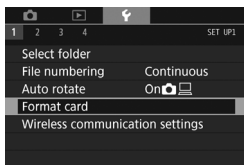

1 Select [Format card].

- Under the [**1**] tab, select [**Format card**], then press <SET>.



2 Format the card.

- Select [**OK**], then press <SET>.
- ▶ The card will be formatted.
- ▶ When the formatting is completed, the menu will reappear.
- For low-level formatting, press the <MENU> button to add a checkmark [✓] to [**Low level format**], then select [**OK**].



Format the card in the following cases:

- The card is new.
- The card was formatted by a different camera or a computer.
- The card is full of images or data.
- A card-related error is displayed.

Low-level Formatting

- Perform low-level formatting if the card's recording or reading speed seems slow or if you want to totally erase data on the card.
- Since low-level formatting will format all recordable sectors on the card, the formatting will take slightly longer than normal formatting.
- You can stop the low-level formatting by selecting **[Cancel]**. Even in this case, normal formatting will be completed and you can use the card as usual.



- When the card is formatted or data is erased, only the file management information is changed. The actual data is not completely erased. Be aware of this when selling or discarding the card. When discarding the card, perform low-level formatting or destroy the card physically to prevent the personal data from being leaked.
- **Before using a new Eye-Fi card, the software on the card must be installed on your computer. Then format the card with the camera.**



- The card capacity displayed on the card format screen may be smaller than the capacity indicated on the card.
- This device incorporates exFAT technology licensed from Microsoft.

MENU Disabling the Beeper

You can prevent the beeper from sounding when focus is achieved, during self-timer shooting, and for touch screen operations.

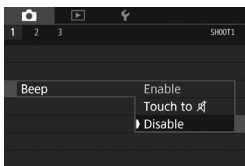
**1** Select **[Beep]**.

- Under the [**1**] tab, select **[Beep]**, then press <SET>.

2 Select **[Disable]**.

- Select **[Disable]**, then press <SET>.
- ▶ The beeper will not sound.
- If **[Touch to [speaker icon]]** is selected, the beeper will be silent for touch screen operations only.

MENU Setting the Power-off Time/Auto Power Off

To save battery power, the camera turns off automatically after a set time of idle operation elapses. The default setting is 1 min., but this setting can be changed. If you do not want the camera to turn off automatically, set this to **[Disable]**. After the power turns off, you can turn on the camera again by pressing the shutter button or other buttons.

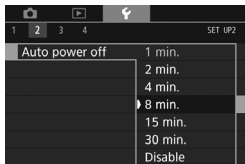
**1** Select **[Auto power off]**.

- Under the [**2**] tab, select **[Auto power off]**, then press <SET>.

2 Set the desired time.

- Select the desired setting, then press <SET>.

Even if **[Disable]** is set, the LCD monitor will turn off automatically after 30 min. to save power. (The camera's power does not turn off.)

MENU Setting the Image Review Time

You can set how long the image is displayed on the LCD monitor immediately after shooting. To keep the image displayed, set **[Hold]**. To not have the image displayed, set **[Off]**.

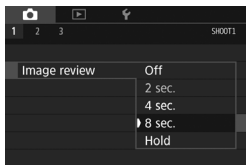

1 Select **[Image review]**.

- Under the [**1**] tab, select **[Image review]**, then press **<SET>**.

2 Set the desired time.

- Select the desired setting, then press **<SET>**.



If **[Hold]** is set, the image will be displayed until the auto power off time elapses.

MENU Turning the LCD Monitor Off/On

The shooting function settings screen (p.49) can be set to display or turn off when you press the shutter button halfway.

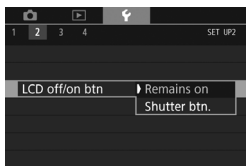

1 Select **[LCD off/on btn]**.

- Under the [**2**] tab, select **[LCD off/on btn]**, then press **<SET>**.

2 Set the desired setting.

- Select the desired setting, then press **<SET>**.

- **[Remains on]**: Display remains on even when you press the shutter button halfway. To turn off the display, press the **<INFO.>** button.
- **[Shutter btn.]**: When you press the shutter button halfway, the display will turn off. When you let go of the shutter button, the display will turn on.

MENU Reverting the Camera to the Default Settings ☆

The camera's shooting function settings and menu settings can be reverted to their defaults.

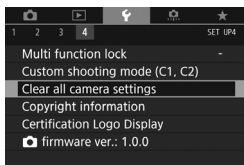
**1** Select [Clear all camera settings].

- Under the [**4**] tab, select [**Clear all camera settings**], then press < **SET** >.

**2** Select [OK].

- Select [**OK**], then press < **SET** >.
- ▶ Setting [**Clear all camera settings**] will reset the camera to the following default settings:

Shooting Function Settings

| | |
|--------------------------------|--------------------------|
| <SCN> mode | (Handheld Night Scene) |
| <Q> mode | (Miniature effect) |
| AF operation | One-Shot AF |
| AF area selection mode | Auto selection:45 pt AF |
| Metering mode | (Evaluative metering) |
| ISO speed settings | |
| ISO Speed Setting | Automatic setting (Auto) |
| Range for stills | Minimum: 100 |
| | Maximum: 16000 |
| Auto range | Minimum: 100 |
| | Maximum: 6400 |
| Minimum shutter speed for auto | Auto |
| Drive mode | (Single shooting) |
| Exposure compensation/AEB | Canceled |
| Flash exposure compensation | Canceled |
| Multiple exposure | Disable |

| | |
|-------------------------------------|---------------------------|
| HDR Mode | Disable HDR |
| Interval timer | Disable |
| Bulb timer | Disable |
| Anti-flicker shooting | Disable |
| Mirror lockup | Disable |
| Viewfinder display | |
| Electronic level | Hide |
| Grid display | Hide |
| Flicker detection | Show |
| Custom Functions | Unchanged |
| Flash control | |
| Flash firing | Enable |
| E-TTL II flash metering | Evaluative flash metering |
| Flash sync. speed in Av mode | Auto |

Image Recording Settings

| | |
|------------------------------------|------------------------------------|
| Image quality | L |
| Aspect ratio | 3:2 |
| Picture Style | Auto |
| Auto Lighting Optimizer | Standard |
| Lens aberration correction | |
| Peripheral illumination correction | Enable / Correction data retained |
| Chromatic aberration correction | Enable / Correction data retained |
| Distortion correction | Disable / Correction data retained |
| White balance | Auto (Ambience priority) |
| Custom White Balance | Canceled |
| White balance correction | Canceled |
| White balance bracketing | Canceled |
| Color space | sRGB |
| Long exposure noise reduction | Disable |
| High ISO speed noise reduction | Standard |
| Highlight tone priority | Disable |
| File numbering | Continuous |
| Auto cleaning | Enable |
| Dust Delete Data | Erased |

Camera Settings

| | |
|--|---------------------------|
| Auto power off | 1 min. |
| Beep | Enable |
| Release shutter without card | Enable |
| Image review | 2 sec. |
| Highlight alert | Disable |
| AF point display | Disable |
| Playback grid | Off |
| Histogram display | Brightness |
| Control over HDMI | Disable |
| Image jump w/ | (10 images) |
| Auto rotate | On |
| LCD brightness | |
| LCD off/on button | Remains on |
| Touch control | Standard |
| Date/Time/Zone | Unchanged |
| Language | Unchanged |
| Video system | Unchanged |
| Feature guide | Enable |
| INFO button display options | All items selected |
| Multi function lock | (Quick Control Dial) only |
| Custom shooting mode | Unchanged |
| Copyright information | Unchanged |
| Eye-Fi transmission | Disable |
| Configure: MY MENU | Unchanged |
| Menu display | Normal display |
| Wireless communication settings | |
| Wi-Fi/NFC | Disable |



Refer to the Wireless Function Instruction Manual for wireless function settings.

Live View Shooting Settings

| | |
|---------------------|------------|
| Live View shooting | Enable |
| AF method | ☺+Tracking |
| AF operation | ONE SHOT |
| Touch shutter | Disable |
| Grid display | Hide |
| Exposure simulation | Enable |
| Silent LV shooting | Mode 1 |
| Metering timer | 8 sec. |
| Creative filters | Disable |

Movie Shooting Settings

| | |
|-------------------------------------|---|
| <◁> mode | ☺ (Dream) |
| ISO speed settings | |
| Range for movies | Minimum: 100 Maximum: 12800 |
| Movie Servo AF | Enable |
| AF method | ☺+Tracking |
| Movie recording quality | |
| MOV/MP4 | MP4 |
| Movie recording size | NTSC: ☺FHD 29.97P (Standard) PAL: ☺FHD 25.00P (Standard) |
| Digital zoom | Disable |
| Sound recording | Auto |
| Wind filter | Auto |
| Attenuator | Disable |
| Movie Servo AF speed | |
| When active | Always on |
| AF speed | 0 (Standard) |
| Movie Servo AF tracking sensitivity | 0 |
| Metering timer | 8 sec. |
| Grid display | Hide |
| ☺ button function | ☺AF/- |
| Video snapshot | Disable |
| Time-lapse movie | Disable |
| Remote control shooting | Disable |
| Creative filters | Disable |

Displaying the Grid

You can display a grid in the viewfinder to help you check the camera tilt or compose the shot.

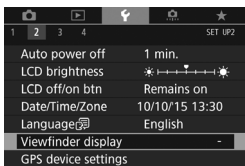

1 Select [Viewfinder display].

- Under the [**2**] tab, select [Viewfinder display], then press <SET>.

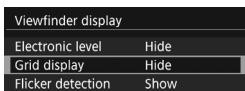

2 Select [Grid display].



3 Select [Show].

- ▶ When you exit the menu, the grid will appear in the viewfinder.

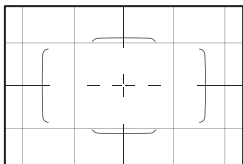

You can display a grid on the LCD monitor during Live View shooting and before you start shooting a movie.

Displaying the Electronic Level

You can display the electronic level on the LCD monitor and in the viewfinder to help you correct the camera tilt. Note that you can check only the horizontal tilt and not the forward/backward tilt.

Displaying the Electronic Level on the LCD Monitor

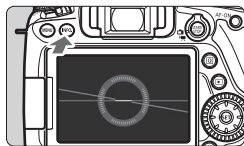

1 Press the <INFO.> button.

- Each time you press the <INFO.> button, the screen display will change.
- Display the electronic level.
- If the electronic level does not appear, set [**3**: **INFO. button display options**] so that the electronic level can be displayed.

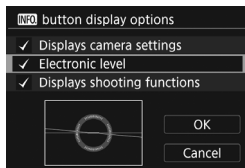

2 Check the camera's tilt.



- The horizontal tilt is displayed in 1° increments. The tilt scale is marked in 5° increments.
- When the red line turns green, it indicates that the tilt is almost corrected.



Horizontal level



- Even when the tilt is corrected, there may be a margin of error of approx. $\pm 1^\circ$.
- If the camera is very tilted, the electronic level's margin of error will be larger.

 During Live View shooting and before movie shooting (except with  +Tracking), you can also display the electronic level as described above (p.177, 204).

MENU Displaying the Electronic Level in the Viewfinder

A simple electronic level using a camera icon can be displayed in the viewfinder. Since this indicator is displayed during shooting, you can take the picture while checking the camera tilt.

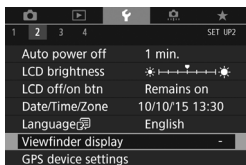

1 Select [Viewfinder display].

- Under the [**2**] tab, select [Viewfinder display], then press **<SET>**.

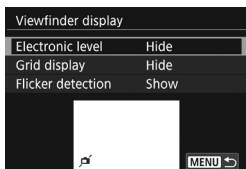

2 Select [Electronic level].



3 Select [Show].

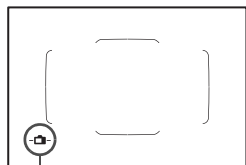

Electronic level

4 Press the shutter button halfway.

- The electronic level will appear as shown in the illustration.



- This level also works with vertical shooting.

Even when the tilt is corrected, there may be a margin of error of approx. $\pm 1^\circ$.

Displaying the Flicker Detection ☆

If you set this function, < **Flicker!** > will appear in the viewfinder when the camera detects flicker caused by the blinking of the light source. By default, flicker detection is set to **[Show]**.

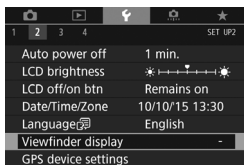

1 Select **[Viewfinder display]**.

- Under the [**2**] tab, select **[Viewfinder display]**, then press < **(SET)** >.

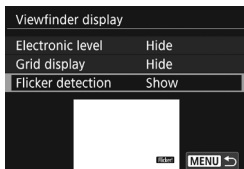

2 Select **[Flicker detection]**.

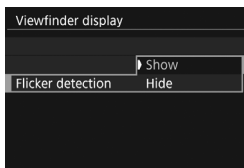

3 Select **[Show]**.

 If you set [**4: Anti-flicker shoot.**] to **[Enable]**, you can shoot with reduced unevenness of exposure caused by the flicker.

Feature Guide and Help

The Feature guide and Help display information about camera features.

Feature Guide

The Feature guide appears when you change the shooting mode or set a shooting function, Live View shooting, movie shooting, or Quick Control for playback, and displays a brief description of that mode, function or option. It also displays a description when you select a function or option with Quick Control. The Feature guide turns off when you tap on the description or proceed with the operation.

● Shooting mode (Sample)

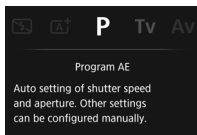
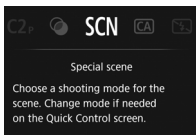

● Quick Control (Sample)

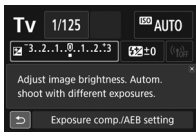

Shooting settings



Live View shooting

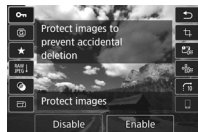

Playback

MENU Disabling the Feature Guide

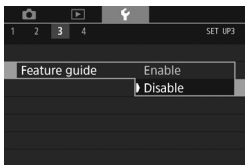

Select [Feature guide].

- Under the [**3**] tab, select [**Feature guide**], then press < (SET) >.
- Select [**Disable**], then press < (SET) >.

Help

When [**INFO Help**] is displayed at the bottom of the menu screen, pressing the <INFO.> button displays the function's description (Help). If the Help fills more than one screen, a scroll bar will appear on the right edge. You can turn the <DIAL> dial or press the <▲> <▼> keys to scroll.

● Example: [CAMERA 3: Long exp. noise reduction]

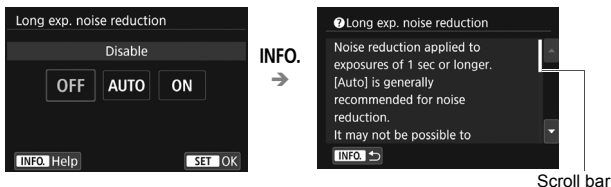

● Example: [CAMERA C.Fn I-1: Exposure level increments]

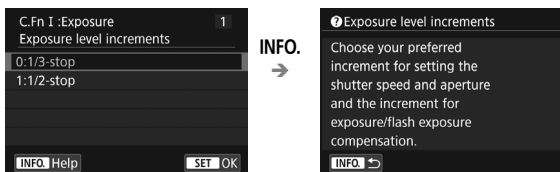

● Example: [CAMERA C.Fn II-1: Tracking sensitivity]

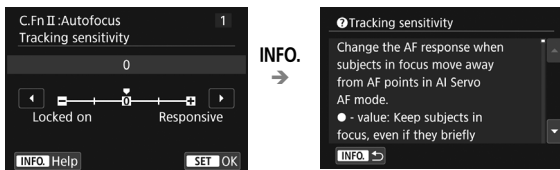

2

Basic Shooting

This chapter explains how to use the Basic Zone modes on the Mode Dial for best results.

With Basic Zone modes, all you do is point and shoot, and the camera sets everything automatically (p.101). Also, to prevent botched pictures due to misoperations, advanced shooting function settings cannot be changed.

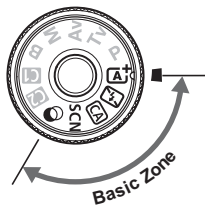

Before Shooting in the <SCN> or <A+> Mode

When the LCD monitor is turned off, press the <Q> button or <INFO.> button (p.82, 95) to check which shooting mode is set before shooting.

- * <SCN>: Special scene
- * <A+>: Creative filters

[A⁺] Fully Automatic Shooting (Scene Intelligent Auto) ■

<[A⁺]> is a fully automatic mode. The camera analyzes the scene and sets the optimum settings automatically. It also adjusts focus automatically by detecting whether the subject is still or moving (p.75).



1 Set the Mode Dial to <[A⁺]>.

- Turn the Mode Dial while holding down the lock release button at the center.

Area AF frame



2 Aim the Area AF frame over the subject.

- All the AF points will be used to focus, and the camera will focus on the closest object.
- Aiming the center of the Area AF frame over the subject will make focusing easier.

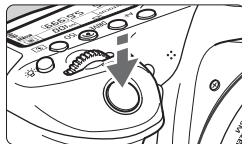

3 Focus on the subject.

- Press the shutter button halfway. The lens focusing ring will rotate to focus.
- ▶ When achieving focus, the AF point that has achieved focus will be displayed. At the same time, the beeper will sound and the focus indicator **<●>** in the viewfinder will light up.
- ▶ In low light, the AF point(s) will light up briefly in red.
- ▶ If necessary, the built-in flash will be raised automatically.



Focus indicator

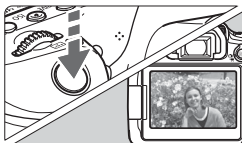

4 Take the picture.

- Press the shutter button completely to take the picture.
- ▶ The captured image will be displayed for approx. 2 sec. on the LCD monitor.
- After you finish shooting, push down the built-in flash with your fingers.



The **A⁺** mode makes the colors look more impressive in nature, outdoor, and sunset scenes. If you do not obtain the desired color tones, change the mode to a Creative Zone mode and select a Picture Style other than **A⁺**, then shoot again (p.137).

? FAQ

- **The focus indicator <●> blinks and focus is not achieved.**
Aim the Area AF frame over an area with good contrast, then press the shutter button halfway (p.44). If you are too close to the subject, move away and try again.
- **When focus is achieved, the AF points do not light up in red.**
The AF points light up in red only when focus is achieved in low-light conditions.
- **Multiple AF points light up simultaneously.**
Focus has been achieved at all those points. You can take the picture as long as an AF point covering the target subject is lighting up.

- **The beeper continues to beep softly. (The focus indicator <●> does not light up.)**



It indicates that the camera is focusing continuously on a moving subject. (The focus indicator <●> does not light up.) You can take sharp pictures of a moving subject.

Note that the focus lock (p.75) will not work in this case.

- **Pressing the shutter button halfway does not focus on the subject.**

If the focus mode switch on the lens is set to <MF> (manual focus), set it to <AF> (autofocus).

- **The flash fired even though it was daylight.**

For a backlit subject, the flash may fire to help lighten the subject's dark areas. If you do not want the flash to fire, use the Quick Control to set [Built-in flash firing] to [>] (p.100) or set the <> (Flash Off) mode and shoot (p.77).

- **The built-in flash fired and the picture came out extremely bright.**

Move further away from the subject and shoot. When shooting with flash, if the subject is too close to the camera, the picture may come out extremely bright (overexposure).

- **In low light, the built-in flash fired a series of flashes.**

Pressing the shutter button halfway may trigger the built-in flash to fire a series of flashes to assist autofocusing. This is called the AF-assist beam. Its effective range is approx. 4 meters / 13.1 feet. The built-in flash will make a sound when firing continuously. This is normal and not a malfunction.

- **When flash was used, the bottom part of the picture came out unnaturally dark.**

The shadow of the lens barrel was captured in the picture because the subject was too close to the camera. Move further away from the subject and shoot. If a hood is attached to the lens, remove it before taking the flash picture.

[A⁺] Full Auto Techniques (Scene Intelligent Auto) ■

Recomposing the Shot



Depending on the scene, position the subject toward the left or right to create a balanced background and good perspective.

In the <[A⁺]> mode, pressing the shutter button halfway to focus on a still subject will lock the focus on that subject. Recompose the shot while keeping the shutter button pressed halfway, and then press the shutter button completely to take the picture. This is called “focus lock”. Focus lock is also possible in other Basic Zone modes (except <[A] > <[S] >).

Shooting a Moving Subject



In the <[A⁺]> mode, if the subject moves (distance to camera changes) during or after focusing, AI Servo AF will take effect to focus on the subject continuously. (The beeper will continue beeping softly.) As long as you keep the Area AF frame positioned over the subject while pressing the shutter button halfway, the focusing will be continuous. When you want to take the picture, press the shutter button completely.

Live View Shooting

You can shoot while viewing the image on the LCD monitor. This is called "Live View shooting". For details, see page 173.

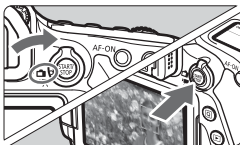

1 Set the Live View shooting/Movie shooting switch to .

2 Display the Live View image on the LCD monitor.

- Press the button.
- ▶ The Live View image will appear on the LCD monitor.



3 Focus on the subject.

- Press the shutter button halfway to focus.
- ▶ When focus is achieved, the AF point will turn green and the beeper will sound.

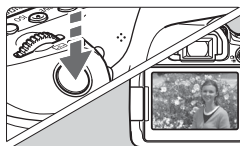

4 Take the picture.

- Press the shutter button completely.
- ▶ The picture is taken and the captured image is displayed on the LCD monitor.
- ▶ When the playback display ends, the camera will return to Live View shooting automatically.
- Press the button to exit the Live View shooting.

You can also rotate the LCD monitor for different angles (p.34).



Normal angle



Low angle



High angle

Disabling Flash

The camera analyzes the scene and sets the optimum settings automatically. In places where flash photography is prohibited such as in a museum or an aquarium, use the <> (Flash Off) mode.

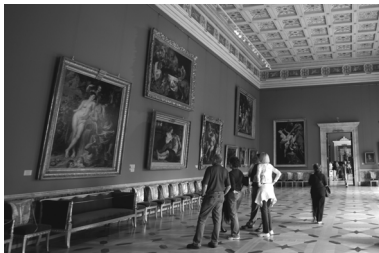
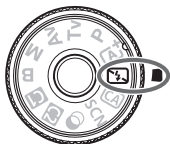

Shooting Tips

- **Prevent camera shake if the numeric display (shutter speed) in the viewfinder blinks.**
Under low light when camera shake is prone to occur, the viewfinder's shutter speed display will blink. Hold the camera steady or use a tripod. When using a zoom lens, use a wide angle to reduce blur caused by camera shake even with handheld shooting.
- **Take portraits without flash.**
In low-light conditions, tell the subject to keep still until the picture is taken. Any movement by the subject during shooting may result in the subject being blurred in the picture.

CA Creative Auto Shooting

In the <CA> mode, you can set the following functions for shooting: (1) Ambience-based shots, (2) Background blur, (3) Drive mode, and (4) Built-in flash firing. The default settings are the same as the <A+> mode.

* CA stands for Creative Auto.



1 Set the Mode Dial to <CA>.

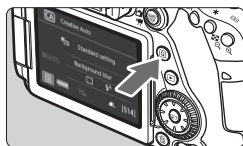

2 Press the <Q> button (10).
▶ The Quick Control screen will appear.

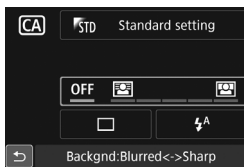

3 Set the desired function.

- Press the <▲> <▼> or <◀> <▶> keys to select a function.
- ▶ The settings of the selected function and Feature guide (p.69) will appear.
- For the setting procedure and details on each function, see pages 79-81.

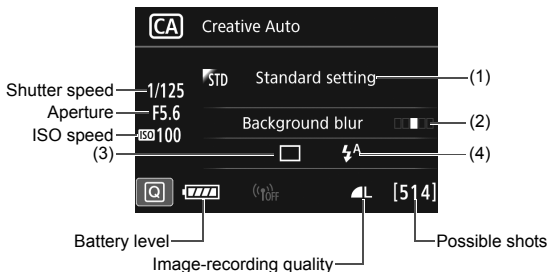

4 Take the picture.

- Press the shutter button completely to take the picture.



If you set (1) or (2) when the camera is set for Live View shooting, you can see the effect on the screen before you start shooting.

(1) Ambience-based shots



You can select and shoot with the ambience you want to convey in your images. Turn the <  > or <  > dial to select the ambience. You can also select it from a list by pressing <  >. For details, see page 102.

(2) Background blur



- If **[OFF]** is set, the degree of background blur will change depending on the brightness.
- If it is set to any setting other than **[OFF]**, you can adjust the background blur regardless of the brightness.
- If you turn the < > or < > dial to move the cursor to the right, the background will look sharper.
- Turning the < > or < > dial to move the cursor to the left will blur the subject's background. Note that depending on the lens's maximum aperture (smallest f/number), certain slider adjustments may not be selectable (indicated by •).
- If you use Live View shooting, you can see how the image is blurred in front of and behind the point of focus. When you turn the < > or < > dial, **[Simulating blur]** will be displayed on the LCD monitor.
- If you want to blur the background, see “Shooting Portraits” on page 89.
- Depending on the lens and shooting conditions, the background may not look so blurred.
- This function cannot be set if you use flash. If < > has been set and you set background blur, < > will be set automatically.

If **[Simulating blur]** is enabled during Live View shooting, the image displayed with < **Exp.SIM** > (p.176) blinking may have more noise than the actual image being recorded, or it may look dark.

(3) Drive mode: Use the <  > or <  > dial to make the selection. You can also select it from a list by pressing <  >.

<  > **Single shooting:**

Shoot one image at a time.

<  H > **High-speed continuous shooting:**

While you hold down the shutter button completely, shots will be taken continuously. You can shoot up to approx. 7.0 shots per second.

<  L > **Low-speed continuous shooting:**

While you hold down the shutter button completely, shots will be taken continuously. You can shoot up to approx. 3.0 shots per second.

<  S > **Silent single shooting:**

You can shoot one image at a time while suppressing the camera noise during viewfinder shooting.



<  S > **Silent continuous shooting:**

You can shoot up to approx. 3.0 shots per second continuously while suppressing the camera noise during viewfinder shooting.

<  10 > **Self-timer: 10 sec./remote control:**

<  2 > **Self-timer: 2 sec./remote control:**

The picture is taken 10 seconds or 2 seconds after you press the shutter button. A remote controller can also be used.



(4) Built-in flash firing: Turn the <  > or <  > dial to select the desired setting. You can also select it from a list by pressing <  >.

<  > **Auto built-in flash:** The flash fires automatically when necessary.

<  > **Built-in flash on** : The flash fires at all times.

<  > **Built-in flash off** : The flash is disabled.



- When using the self-timer, see the  notes on page 130.
- When using <  >, see “Disabling Flash” on page 77.

SCN: Special Scene Mode

The camera will automatically choose the appropriate settings when you select a shooting mode for your subject or scene.



1 Set the Mode Dial to <SCN>.

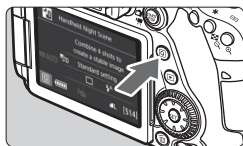

2 Press the <Q> button (ⓘ10).
▶ The Quick Control screen will appear.

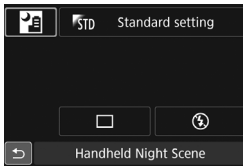

3 Select a shooting mode.

- Press the <▲> <▼> or <◀> <▶> keys to select the desired shooting mode's icon.
- Turn the <☀> or <☀> dial to select a shooting mode.
- You can also select the shooting mode icon and press <SET> to display a selection of shooting modes from which you can select one.

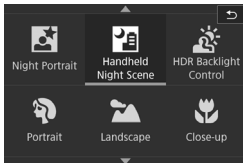

Available Shooting Modes in the <SCN> Mode

| Shooting Mode | Page |
|----------------------|------|
| Food | p.83 |
| Kids | p.84 |
| Candlelight | p.85 |
| Night Portrait | p.86 |
| Handheld Night Scene | p.87 |

| Shooting Mode | Page |
|-----------------------|------|
| HDR Backlight Control | p.88 |
| Portrait | p.89 |
| Landscape | p.90 |
| Close-up | p.91 |
| Sports | p.92 |

🍴 Shooting Food

When shooting food, use <🍴> (Food). The photo will look bright and appetizing. Also, depending on the light source, the reddish tinge will be suppressed in the pictures taken under tungsten lights, etc.

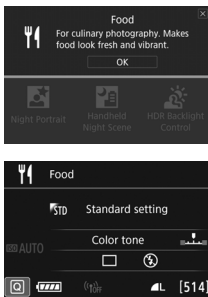

💡 Shooting Tips

- **Change the color tone.**

You can change [**Color tone**]. To increase the food's reddish tinge, set it toward [**Warm**]. Set it toward [**Cool**] if it looks too red.

- **Avoid using flash.**

If you use flash, the light may reflect off the dish or food and results in unnatural shadows. By default, <🔴> (Built-in flash off) is set. Try to prevent camera shake when shooting in low-light conditions.



- Since this mode lets you shoot the food in appetizing color tones, human subjects may be shot in an unsuitable skin tone.
- The warm color cast of subjects may fade.
- When multiple light sources are included on the screen, the warm color cast of the picture may not be lessened.
- If you use flash, the [**Color tone**] setting will switch to the standard.

Shooting Children

When you want to continuously focus on and shoot children running around, use  (Kids). Skin tones will look healthy.

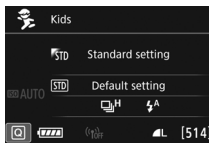

Shooting Tips

● Track the subject with the Area AF frame.

Press the shutter button halfway to start autofocusing in Area AF frame. During autofocusing, the beeper will continue beeping softly. If focus cannot be achieved, the focus indicator  will blink.

● Shoot continuously.

The default setting is  (High-speed continuous shooting*). When you want to take the picture, press the shutter button completely. If you hold down the shutter button, you can shoot continuously while maintaining autofocusing to capture changes in the subject's facial expression and movement.

* Viewfinder shooting: max. approx. 7.0 shots/sec., Live View shooting: max. approx. 5.0 shots/sec.

- While the flash is recycling, “buSY” is displayed in the viewfinder and on the LCD panel, and a picture cannot be taken. Take the picture after this display turns off. During Live View shooting, “BUSY” is displayed on the LCD monitor, and you cannot view the subject.
- See the cautions on page 93.

Shooting Candlelight Portraits

When shooting a human subject in candlelight, use  (Candlelight). The candlelight color tones will be retained in the photo.

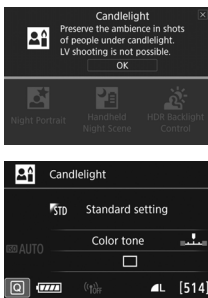

Shooting Tips

- **Use the center AF point to focus.**
Aim the center AF point in the viewfinder over the subject, then shoot.
- **Prevent camera shake if the numeric display (shutter speed) in the viewfinder blinks.**
Under low light when camera shake is prone to occur, the viewfinder's shutter speed display will blink. Hold the camera steady or use a tripod. When using a zoom lens, use the wide-angle end to reduce blur caused by camera shake even while handholding the camera.
- **Change the color tone.**
You can change [Color tone]. To increase the candlelight's reddish tint, set it toward [Warm]. Set it toward [Cool] if it looks too red.



- Live View shooting cannot be used.
- The built-in flash will not fire. In low light, the AF-assist beam may be emitted (p.113).
- If you are using an external Speedlite, the Speedlite will fire.

Shooting Night Portraits (With a Tripod) ■

To shoot people at night and obtain a natural-looking night scene in the background, use the  (Night Portrait) mode. Using a tripod is recommended.

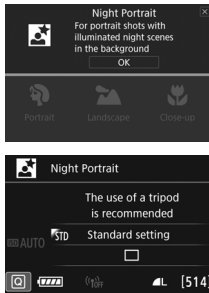

Shooting Tips

- **Use a wide-angle lens and a tripod.**



When using a zoom lens, use the wide-angle end to obtain a wide night view. Also, use a tripod to prevent camera shake.

- **Check the subject's brightness.**

Under low light, the built-in flash will fire automatically to obtain a good exposure of the subject.

It is recommended to play back the image after shooting to check the image brightness. If the subject looks dark, move nearer and shoot again.

- **Also shoot in other shooting modes.**

Since camera shake is prone to occur with night shots, shooting also with  and  is recommended.



- Tell the subject to keep still even after the flash fires.
- If you use the self-timer together with flash, the self-timer lamp will light up briefly after the picture is taken.
- See the cautions on page 93.

Shooting Night Scenes (Handheld)

Using a tripod when shooting a night scene gives the best results. However, the  (Handheld Night Scene) mode enables you to shoot night scenes even while handholding the camera. In this shooting mode, four shots are taken continuously for each picture, and the resulting one image with reduced camera shake is recorded.

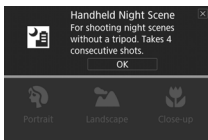



Shooting Tips

- **Hold the camera firmly.**

While shooting, hold the camera firmly and steadily. In this mode, four shots are aligned and merged into a single image. However, if there is significant misalignment in any of the four shots due to camera shake, they may not align properly in the final image.

- **For shots of people, turn on the flash.**

If you want to include people in the night scene shot, press the  button to set  (Built-in flash on). To take a nice portrait, the first shot will use flash. Tell the subject not to move until all four continuous shots are taken.



- Compared to other shooting modes, the shooting range will be smaller.
- See the cautions on page 93.

Shooting Backlit Scenes

When shooting a scene having both bright and dark areas, use the <  > (HDR Backlight Control) mode. When you take one picture in this mode, three continuous shots are taken at different exposures. This results in one image, with a wide tonal range, that has minimized the clipped shadows caused by backlighting.

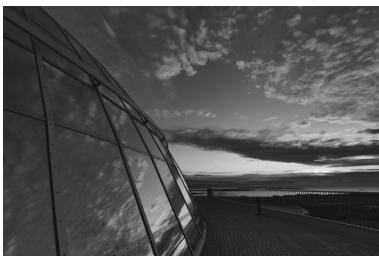
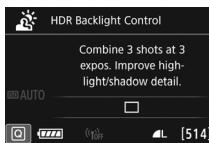
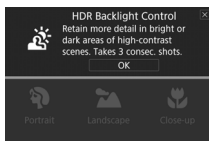

Shooting Tips

● Hold the camera firmly.

While shooting, hold the camera firmly and steadily. In this mode, three shots are aligned and merged into a single image. However, if there is significant misalignment in any of the three shots due to camera shake, they may not align properly in the final image.

- Compared to other shooting modes, the shooting range will be smaller.
- Flash shooting is not possible. In low light, the AF-assist beam may be emitted (p.113).
- See the cautions on page 93.

 HDR stands for High Dynamic Range.

Shooting Portraits

The <> (Portrait) mode blurs the background to make the human subject stand out. It also makes skin tones and hair look softer.

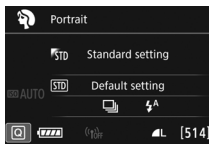
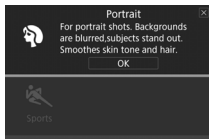

Shooting Tips

- **Select the location where the distance between the subject and the background is the farthest.**

The further the distance between the subject and background, the more blurred the background will look. The subject will also stand out better against an uncluttered dark background.

- **Use a telephoto lens.**

If you have a zoom lens, use the telephoto end to fill the frame with the subject from the waist up. Move in closer if necessary.

- **Focus on the face.**

Check that the AF point covering the face lights up. For close-ups of the face, focus on the eyes.



The default setting is <> (Low-speed continuous shooting). If you hold down the shutter button, you can shoot continuously (max. approx. 3.0 shots/sec.) to capture changes in the subject's facial expression and pose.

Shooting Landscapes

Use the <  > (Landscape) mode for wide scenery or to have everything in focus from near to far. For vivid blues and greens, and very sharp and crisp images.

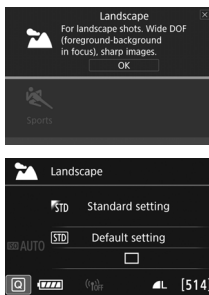

Shooting Tips

- **With a zoom lens, use the wide-angle end.**

When using the wide-angle end of a zoom lens, objects near and far will be in focus better than at the telephoto end. It also adds breadth to landscapes.

- **Shooting night scenes.**

The <  > mode is also good for night scenes because it disables the built-in flash. When shooting night scenes, use a tripod to prevent camera shake.



- The built-in flash will not fire even in backlit or low-light conditions.
- If you are using an external Speedlite, the Speedlite will fire.

Shooting Close-ups

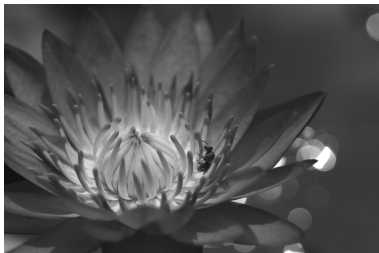
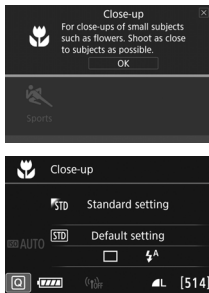
When you want to shoot flowers or small things up close, use the  (Close-up) mode. To make small things appear much larger, use a macro lens (sold separately).



Shooting Tips

- **Use a simple background.**
A simple background makes small objects such as flowers stand out better.
- **Move in as close as possible to the subject.**
Check the lens for its minimum focusing distance. Some lenses have indications such as **<MACRO 0.39m/1.3ft>** on them. The lens minimum focusing distance is measured from the  (focal plane) mark on the top of the camera to the subject. If you are too close to the subject, the focus indicator  will blink.
If you use the built-in flash and the bottom part of the picture comes out unnaturally dark, move away from the subject and try again.
- **With a zoom lens, use the telephoto end.**
If you have a zoom lens, using the telephoto end will make the subject look larger.

Shooting Moving Subjects

Use the  (Sports) mode to shoot a moving subject, such as a running person or a moving vehicle.

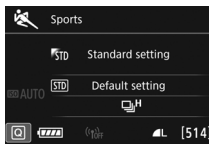
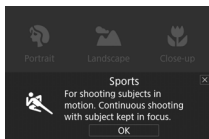



Shooting Tips

● Use a telephoto lens.

The use of a telephoto lens is recommended for shooting from a distance.

● Track the subject with the Area AF frame.

Press the shutter button halfway to start autofocus in Area AF frame. During autofocus, the beeper will continue beeping softly. If focus cannot be achieved, the focus indicator  will blink. The default setting is  (High-speed continuous shooting*). When you want to take the picture, press the shutter button completely. If you hold down the shutter button, you can shoot continuously while maintaining autofocus to capture changes in the subject's movement.

* Viewfinder shooting: max. approx. 7.0 shots/sec., Live View shooting: max. approx. 5.0 shots/sec.

- The built-in flash will not fire even in backlit or low-light conditions.
- Under low light when camera shake tends to occur, the viewfinder's shutter speed display on the bottom left will blink. Hold the camera steady and shoot.
- If you are using an external Speedlite, the Speedlite will fire.
- During Live View shooting, the image quality can be set to **RAW** or **JPEG**. If **M RAW** or **S RAW** is set, the image will be recorded in **RAW** quality.



Cautions for Kids

- During Live View shooting, the image quality can be set to **RAW** or JPEG. If **M RAW** or **S RAW** is set, the image will be recorded in **RAW** quality.
- During Live View shooting, if flash is fired in continuous shooting, the continuous shooting speed will decrease. Even if the flash is not fired for subsequent shots, shooting will be performed with the decreased continuous shooting speed.

Cautions for Night Portrait and Handheld Night Scene

- During Live View shooting, it may be difficult to focus on dots of light such as in a night scene. In such a case, set the lens's focus mode switch to **<MF>** and focus manually.
- The Live View image displayed will not look exactly the same as the actual image shot.

Cautions for Handheld Night Scene and HDR Backlight Control

- You cannot select RAW or RAW+JPEG. If RAW is set, the image will be recorded in the **L** quality. Also, if RAW+JPEG is set, the image will be recorded in the set JPEG quality.
- If you shoot a moving subject, the subject's movement may leave afterimages, or the surrounding area of the subject may become dark.
- The image alignment may not function properly with repetitive patterns (lattice, stripes, etc.), flat or single-tone images, or images significantly misaligned due to camera shake.
- It takes some time to record images to the card since they are merged after shooting. During the processing of the images, "**buSY**" will be displayed in the viewfinder and on the LCD panel, and you cannot take another picture until the processing is completed.

Cautions for Night Portrait

- During Live View shooting, it may be difficult to focus when the face of the subject looks dark. In such a case, set the lens's focus mode switch to **<MF>** and focus manually.



Cautions for Handheld Night Scene

- When shooting with flash, if the subject is too close to the camera, the picture may come out extremely bright (overexposure).
- If you use flash to shoot a night scene with few lights, the shots may not align correctly. This can result in a blurry picture.
- If you use flash and the human subject is close to the background that is also illuminated by the flash, the shots may not align correctly. This can result in a blurry picture. Unnatural shadows and unsuitable colors may also appear.
- External flash coverage:
 - When using a Speedlite with automatic flash coverage setting, the zoom position will be fixed to the wide end, regardless of the lens's zoom position.
 - When using a Speedlite requiring manual flash coverage setting, set the flash head to the wide (normal) position.

Cautions for HDR Backlight Control

- Note that the image may not be rendered with a smooth gradation and may look irregular or have significant noise.
- HDR Backlight Control may not be effective for excessively backlit scenes or extremely high-contrast scenes.
- When shooting subjects that are sufficiently bright, for example for normally lit scenes, the image may look unnatural because of the applied HDR effect.

Applying Creative Filters

In the <> (Creative filter) mode, you can apply one of ten filter effects (Grainy B/W*, Soft focus*, Fish-eye effect*, Toy camera effect*, Miniature effect*, Water painting effect*, HDR art standard, HDR art vivid, HDR art bold, and HDR art embossed) for shooting. When the camera is set for Live View shooting, you can see the effect on the screen before you start shooting. The camera saves only the image with the Creative filter applied.

For the effects marked with an asterisk, you can also take a picture without a Creative filter, then apply the effect afterward and save it as a new image.



1 Set the Mode Dial to <>.

2 Set the Live View shooting/Movie shooting switch to <>.









3 Display the Live View image.

- Press the <> button to display the Live View image.



4 Select [Creative filters] with Quick Control.

- Press the <> button ().
- Press the < > < > keys to select [] on the upper left of the screen, then press the < > button.

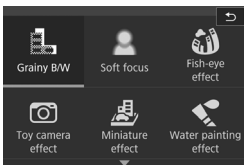

5 Select a shooting mode.

- Press the <▲> <▼> or <◀> <▶> keys to select a shooting mode, then press <SET> and select [OK].
- ▶ The image will be displayed with the effects of the filter applied.
- For the Miniature effect, press the <▲> <▼> keys to move the white frame to where you want the image to look sharp.

Available Shooting Modes in the Mode

| Shooting Mode | | Page |
|---------------|-------------------|------|
| | Grainy B/W | p.97 |
| | Soft focus | p.97 |
| | Fish-eye effect | p.98 |
| | Toy camera effect | p.98 |
| | Miniature effect | p.98 |

| Shooting Mode | | Page |
|---------------|-----------------------|------|
| | Water painting effect | p.98 |
| | HDR art standard | p.98 |
| | HDR art vivid | p.99 |
| | HDR art bold | p.99 |
| | HDR art embossed | p.99 |



6 Adjust the effect.

- Press the <[Q]> button and select the icon below [Creative filters] (except for , , , , and).
- Press the <◀> <▶> keys to adjust the filter effect, then press <SET>.

7 Take the picture.

- Press the shutter button completely to take the picture.
- To return to viewfinder shooting, press the <START/STOP> button to exit Live View shooting. Then press the shutter button completely to take the picture.

If you do not want the Live View image to be displayed when setting functions, press the <[Q]> button after step 1 and set [Creative filters].



- You cannot select RAW or RAW+JPEG. If RAW is set, the image will be recorded in the **L** quality. Also, if RAW+JPEG is set, the image will be recorded in the set JPEG quality.
- When , , , , , or is set, continuous shooting cannot be set.
- Dust Delete Data will not be appended to images shot with Fish-eye effect applied.
- is set to (Flash Off) by default. Try to prevent camera shake when shooting in low-light conditions.



During Live View Shooting

- With Grainy B/W, the grainy effect displayed on the LCD monitor will look different from the grainy effect recorded in the picture.
- With the Soft focus and Miniature effects, the blurred effect displayed on the LCD monitor may look different from the blurred effect recorded in the picture.
- The histogram is not displayed.
- Magnified view is not possible.
- In Creative Zone modes, you can set some Creative filters with Quick Control.

Creative Filter Characteristics

- **Grainy B/W**
Creates a grainy black-and-white photo. You can change the black-and-white effect by adjusting the contrast.
- **Soft focus**
Gives the image a soft look. You can change the degree of softness by adjusting the blur.

●  **Fish-eye effect**

Gives the effect of a fish-eye lens. The image will have a barrel-type distortion.



Depending on the level of this filter effect, the area trimmed along the periphery of the image changes. Also, since this filter expands the center part of the image, the resolution at the center may decrease depending on the number of recorded pixels. Check the image on the screen when setting this filter. The AF point will be fixed at center.

●  **Toy camera effect**

Darkens the photo's corners and applies a color tone that makes it look as if it was shot by a toy camera. You can change the color cast by adjusting the color tone.

●  **Miniature effect**

Creates a diorama effect.

During Live View shooting, you can change where the image looks sharp. In step 5, if you press the  button (or tap  on the bottom right of the screen), you can switch between the white frame's vertical and horizontal orientations. The camera focuses on the center of the white frame.





During viewfinder shooting, aim the center AF point over the subject and shoot.

●  **Water painting effect**



Makes the photo look like a watercolor painting with soft colors. You can control the color density by adjusting the filter effect. Note that night scenes or dark scenes may not be rendered with a smooth gradation and may look irregular or have significant noise.

●  **HDR art standard**

Clipped highlights and shadows will be reduced. The contrast will be lower, and the gradation flatter to have the picture look like a painting. The subject outlines will have bright (or dark) edges.

 For  >  >  > , clipped highlights and shadows will be reduced for a high dynamic range of tones even with high-contrast scenes.

Three images of different exposures are captured continuously for each shot and merged into a single image. See the cautions on page 99.

-  **HDR art vivid**
The colors are more saturated than with [**HDR art standard**], and the low contrast and flat gradation create a graphic art effect.
-  **HDR art bold**
The colors are the most saturated, making the subject pop out, and the picture look like an oil painting.
-  **HDR art embossed**
The color saturation, brightness, contrast and gradation are decreased to make the picture look flat. The picture looks faded and old. The subject outlines will have bolder bright (or dark) edges.



Cautions for < > HDR Art Standard, < > HDR Art Vivid, < > HDR Art Bold, and < > HDR Art Embossed

- Compared to other shooting modes, the shooting range will be smaller.
- The Live View image displayed with the filter applied will not look exactly the same as the actual image.
- If you shoot a moving subject, the subject's movement may leave afterimages, or the surrounding area of the subject may become dark.
- The image alignment may not function properly with repetitive patterns (lattice, stripes, etc.), flat or single-tone images, or images significantly misaligned due to camera shake.
- If you are handholding the camera, try to prevent camera shake when shooting.
- The color gradation of the sky or white walls may not be reproduced correctly. Irregular exposure, irregular colors, or noise may appear.
- Shooting under fluorescent or LED lighting may result in unnatural color reproduction of the illuminated areas.
- It takes some time to record images to the card since they are merged after shooting. During the processing of the images, “**buSY**” will be displayed in the viewfinder and on the LCD panel, and you cannot take another picture until the processing is completed.
- Flash shooting is not possible. In low light, the AF-assist beam may be emitted (p.113).

Quick Control

In Basic Zone modes, when the shooting function settings are displayed, you can press the  button to display the Quick Control screen. The tables on the next page show the functions that can be set with the Quick Control screen in each Basic Zone mode.

Example: Portrait mode

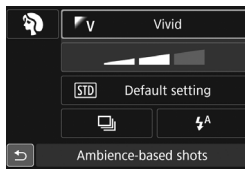
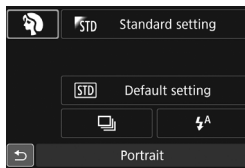







1 Set the Mode Dial to a Basic Zone mode.

2 Press the  button ().

▶ The Quick Control screen will appear.

3 Set the desired function.

- Press the   or   keys to select a function.
- ▶ The settings of the selected function and Feature guide (p.69) will appear.
- Turn the  or  dial to change the setting.
- You can also select from a list by selecting a function and pressing .

Settable Functions in Basic Zone Modes

●: Default setting*¹ ○: User selectable □: Not selectable

| Function | | | | CA | SCN | | | | |
|---------------------------------|---|---|---|----|-----|---|---|---|---|
| | | | | | | | | | |
| Drive mode (p.128) | : Single shooting | ● | ● | ● | ● | ○ | ● | ● | ● |
| | H: High-speed continuous shooting | ○ | ○ | ○ | ○ | ● | ○ | ○ | ○ |
| | L: Low-speed continuous shooting | ○ | ○ | ○ | ○ | ○ | ○ | ○ | ○ |
| | S: Silent single shooting* ² | ○ | ○ | ○ | ○ | ○ | ○ | ○ | ○ |
| | S: Silent continuous shooting* ² | ○ | ○ | ○ | ○ | ○ | ○ | ○ | ○ |
| | Self-timer (p.130) | 1 | ○ | ○ | ○ | ○ | ○ | ○ | ○ |
| 2 | | ○ | ○ | ○ | ○ | ○ | ○ | ○ | ○ |
| Built-in flash firing | A: Automatic firing | ● | □ | ● | □ | ● | □ | ● | □ |
| | : Flash on (Fires at all times) | ○ | □ | ○ | ○ | ○ | □ | ○ | ○ |
| | : Flash off | ○ | ● | ○ | ● | ○ | ● | □ | ● |
| Ambience-based shots (p.102) | | □ | □ | ○ | ○ | ○ | ○ | ○ | ○ |
| Light/scene-based shots (p.106) | | □ | □ | □ | □ | ○ | □ | □ | □ |
| Background blur (p.80) | | □ | □ | ○ | □ | □ | □ | □ | □ |
| Color tone (p.83, 85) | | □ | □ | □ | ○ | □ | ○ | □ | □ |

| Function | | SCN | | | | | | | |
|---------------------------------|---|-----|---|---|---|---|----|----|---|
| | | | | | | | *3 | *4 | |
| Drive mode (p.128) | : Single shooting | ● | ○ | ● | ● | ○ | ● | ● | ● |
| | H: High-speed continuous shooting | ○ | ○ | ○ | ○ | ● | □ | □ | ○ |
| | L: Low-speed continuous shooting | ○ | ● | ○ | ○ | ○ | □ | □ | ○ |
| | S: Silent single shooting* ² | ○ | ○ | ○ | ○ | ○ | ○ | ○ | ○ |
| | S: Silent continuous shooting* ² | ○ | ○ | ○ | ○ | ○ | □ | □ | ○ |
| | Self-timer (p.130) | 1 | ○ | ○ | ○ | ○ | ○ | ○ | ○ |
| 2 | | ○ | ○ | ○ | ○ | ○ | ○ | ○ | ○ |
| Built-in flash firing | A: Automatic firing | □ | ● | □ | ● | □ | ○ | ● | □ |
| | : Flash on (Fires at all times) | □ | ○ | □ | ○ | □ | ○ | ○ | □ |
| | : Flash off | ● | ○ | ● | ○ | ● | ● | ○ | ● |
| Ambience-based shots (p.102) | | □ | ○ | ○ | ○ | ○ | □ | □ | □ |
| Light/scene-based shots (p.106) | | □ | ○ | ○ | ○ | ○ | □ | □ | □ |
| Adjustment of effects (p.95) | | □ | □ | □ | □ | □ | ○ | □ | □ |

*1: If you change the shooting mode or set the power switch to <OFF>, all the functions will revert to the default settings (except the self-timer).

*2: Settable only with viewfinder shooting.

*3:

*4:

Shooting with Ambience Selection

In Basic Zone modes, when a mode other than $\langle \text{A}^+ \rangle$, $\langle \text{A}^- \rangle$, $\langle \text{SCN: } \text{☼} \rangle$, and $\langle \text{☾} \rangle$ is set, you can select the ambience for shooting.

| Ambience | [CA] | SCN | | Ambience Effect |
|------------------------|------|-----|-----------------|-------------------------|
| | | ☼/☽ | ☼/☽/☼/☽/☼/☽/☼/☽ | |
| [STD] Standard setting | ○ | ○ | ○ | No setting |
| [V] Vivid | ○ | | ○ | Low / Standard / Strong |
| [S] Soft | ○ | | ○ | Low / Standard / Strong |
| [W] Warm | ○ | | ○ | Low / Standard / Strong |
| [I] Intense | ○ | | ○ | Low / Standard / Strong |
| [C] Cool | ○ | | ○ | Low / Standard / Strong |
| [B] Brighter | ○ | ○ | ○ | Low / Medium / High |
| [D] Darker | ○ | ○ | ○ | Low / Medium / High |
| [M] Monochrome | ○ | ○ | ○ | Blue / B/W / Sepia |

1 Set the Mode Dial to $\langle \text{CA} \rangle$ or $\langle \text{SCN} \rangle$.

- For $\langle \text{SCN} \rangle$, set a shooting mode other than $\langle \text{☼} \rangle$.

2 Set the Live View shooting/Movie shooting switch to $\langle \text{☑} \rangle$.

3 Display the Live View image.

- Press the $\langle \text{START/STOP} \rangle$ button to display the Live View image (except $\langle \text{☑} \rangle$).

4 With Quick Control, select the desired ambience.

- Press the $\langle \text{Q} \rangle$ button ($\text{☉}10$).
- Press the $\langle \blacktriangle \rangle$ $\langle \blacktriangledown \rangle$ keys to select $[\text{STD}]$ **Standard setting**. [**Ambience-based shots**] will appear on the screen.
- Press the $\langle \blacktriangleleft \rangle$ $\langle \blacktriangleright \rangle$ keys to select the desired ambience.
- ▶ The LCD monitor will display how the image will look with the selected ambience.

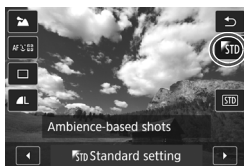



5 Set the ambience effect.

- Press the <▲> <▼> keys to select the effect so that **[Effect]** appears at the bottom of the screen.
- Press the <◀> <▶> keys to select the desired effect.

6 Take the picture.

- Press the shutter button completely to take the picture.
- To return to viewfinder shooting, press the <START/STOP> button to exit Live View shooting. Then press the shutter button completely to take the picture.
- If you change the shooting mode or set the power switch to <OFF>, the setting will revert back to **[STD Standard setting]**.





- The Live View image shown with the ambience setting applied will not look exactly the same as the actual image.
- Using flash may reduce the ambience effect.
- In bright outdoors, the Live View image you see on the LCD monitor may not have exactly the same brightness or ambience as the actual image. Set [**Y2: LCD brightness**] to 4, and look at the Live View image so that the LCD monitor is unaffected by outside light.



If you do not want the Live View image to be displayed when setting functions, press the <Q> button after step 1 and set **[Ambience-based shots]** and **[Effect]**.

Ambience Settings

Standard setting

Standard image characteristics for the respective shooting mode. Note that  has image characteristics geared for portraits and  is geared for landscapes. Each ambience is a modification of the respective shooting mode's image characteristics.

Vivid

The subject will look sharp and vivid. It makes the photo look more impressive than with [ **Standard setting**].

Soft

The subject will look softer and more dainty. Good for portraits, pets, flowers, etc.

Warm

The subject will look softer with warmer colors. Good for portraits, pets, and other subjects to which you want to give a warm look.

Intense

While the overall brightness is slightly lowered, the subject is emphasized for a more intense feeling. Makes the human or living subject stand out more.

Cool

The overall brightness is slightly lowered with a cooler color cast. A subject in the shade will look more calm and impressive.

B Brighter

The picture will look brighter.





D Darker

The picture will look darker.











M Monochrome

The picture will be monochrome. You can select the monochrome color to be blue, black and white, or sepia. When **[Monochrome]** is selected, <  > will appear in the viewfinder.



Shooting by Lighting or Scene Type

In the <SCN:      > Basic Zone modes, you can shoot with the settings matching the lighting or scene type. Normally, [STD] **Default setting**] is adequate, but if the settings match the lighting condition or scene, the picture will look more accurate to your eyes.

For Live View shooting, if you set both [**Light/scene-based shots**] and [**Ambience-based shots**] (p.102), you should first set [**Light/scene-based shots**]. This will make it easier to see the resulting effect on the LCD monitor.

| Lighting or Scene | SCN | | | | |
|---|---|---|---|---|---|
| |  |  |  |  |  |
| [STD] Default setting | <input type="radio"/> | <input type="radio"/> | <input type="radio"/> | <input type="radio"/> | <input type="radio"/> |
|  Daylight | <input type="radio"/> | <input type="radio"/> | <input type="radio"/> | <input type="radio"/> | <input type="radio"/> |
|  Shade | <input type="radio"/> | <input type="radio"/> | <input type="radio"/> | <input type="radio"/> | <input type="radio"/> |
|  Cloudy | <input type="radio"/> | <input type="radio"/> | <input type="radio"/> | <input type="radio"/> | <input type="radio"/> |
|  Tungsten light | <input type="radio"/> | <input type="radio"/> | <input checked="" type="radio"/> | <input type="radio"/> | <input type="radio"/> |
|  Fluorescent light | <input type="radio"/> | <input type="radio"/> | <input checked="" type="radio"/> | <input type="radio"/> | <input type="radio"/> |
|  Sunset | <input type="radio"/> | <input type="radio"/> | <input type="radio"/> | <input type="radio"/> | <input type="radio"/> |

1 Set the Mode Dial to <SCN>.

- Set one of the following: < >, < >, < >, < >, or < >.

2 Set the Live View shooting/Movie shooting switch to < >.

3 Display the Live View image.

- Press the <START/STOP> button to display the Live View image.



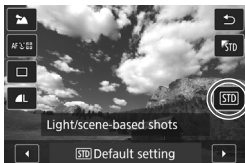

4 With Quick Control, select the lighting or scene type.

- Press the <Q> button (10).
- Press the <▲> <▼> keys to select [**STD Default setting**]. [**Light/scene-based shots**] will appear on the screen.
- Press the <◀> <▶> keys to select the lighting or scene type.
- ▶ The resulting image with the selected lighting or scene type will be displayed.

5 Take the picture.

- Press the shutter button completely to take the picture.
- To return to viewfinder shooting, press the <START/STOP> button to exit Live View shooting. Then press the shutter button completely to take the picture.
- If you change the shooting mode or set the power switch to <OFF>, the setting will revert back to [**STD Default setting**].



- If you use flash, the setting will switch to [**STD Default setting**]. (However, the shooting information will display the lighting or scene type that is set.)
- If you want to set this together with [**Ambience-based shots**], set the lighting or scene type that best matches the ambience you have set. In the case of [**Sunset**], for example, warm colors will become prominent so the ambience you set may not work well.



If you do not want the Live View image to be displayed when setting functions, press the <Q> button after step 1 and set [**Light/scene-based shots**].

Lighting or Scene Type Settings

Default setting

Default setting suited for most subjects.

Daylight

For subjects under sunlight. Gives more natural-looking blue skies and greenery and reproduces light-colored flowers better.

Shade

For subjects in the shade. Suitable for skin tones, which may look too bluish, and for light-colored flowers.

Cloudy

For subjects under overcast skies. Makes skin tones and landscapes, which may otherwise look dull on a cloudy day, look warmer. Also effective for light-colored flowers.

Tungsten light

For subjects lit under tungsten lighting. Reduces the reddish-orange color cast caused by tungsten lighting.

Fluorescent light

For subjects under fluorescent lighting. Suited for all types of fluorescent lighting.

Sunset

Suitable when you want to capture the sunset's impressive colors.

3

Setting the AF and Drive Modes

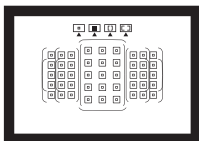

The AF points in the viewfinder are arranged to make AF shooting suitable for a wide variety of subjects and scenes.

You can also select the AF operation and drive mode that best match the shooting conditions and subject.

- The ☆ icon at the upper right of the page title indicates that the function is available only in Creative Zone modes (**P/Tv/Av/M/B**).
- In Basic Zone modes, the AF operation and AF point (AF area selection mode) are set automatically.



<AF> stands for autofocus. <MF> stands for manual focus.

AF: Selecting the AF Operation ☆

You can select the AF operation characteristics to suit the shooting conditions or subject. In Basic Zone modes, the optimum AF operation is set automatically for the respective shooting mode.

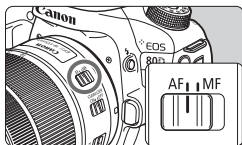

1 Set the lens's focus mode switch to <AF>.

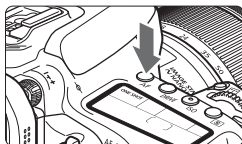

2 Turn the Mode Dial to a Creative Zone mode.

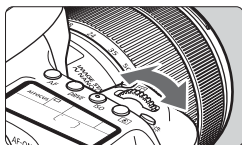

3 Press the <AF> button (⦿6).

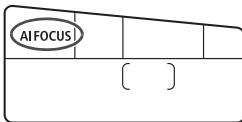

4 Select the AF operation.

- While looking at the LCD panel, turn the <⦿> or <⦿> dial.

ONE SHOT : One-Shot AF

AI FOCUS : AI Focus AF

AI SERVO : AI Servo AF

 In Creative Zone modes, you can also press the <AF-ON> button to autofocus.

One-Shot AF for Still Subjects



AF point

Focus indicator

Suited for still subjects. When you press the shutter button halfway, the camera will focus only once.

- When focus is achieved, the AF point that achieved focus will be displayed, and the focus indicator <●> in the viewfinder will also light up.
 - With evaluative metering, the exposure setting will be set at the same time focus is achieved.
- While you hold down the shutter button halfway, the focus will be locked. You can then recompose the shot if desired.



- If focus cannot be achieved, the focus indicator <●> in the viewfinder will blink. If this occurs, the picture cannot be taken even if the shutter button is pressed completely. Recompose the shot and try to focus again.
- If [**1: Beep**] is set to [**Disable**], the beeper will not sound when focus is achieved.
- After achieving focus with One-Shot AF, you can lock the focus on a subject and recompose the shot. This is called “focus lock”. This is useful when you want to focus on a peripheral subject not covered by the Area AF frame.
- When a lens equipped with electronic manual focusing function is used, after achieving focus, you can focus manually by turning the lens focusing ring while pressing the shutter button halfway.

AI Servo AF for Moving Subjects

This AF operation is suited for moving subjects when the focusing distance keeps changing. While you hold down the shutter button halfway, the camera will keep focusing on the subject continuously.

- The exposure is set at the moment the picture is taken.
- When the AF area selection mode (p.114) is set to 45-point automatic selection AF, focus tracking will continue as long as the Area AF frame covers the subject.

 With AI Servo AF, the beeper will not sound even when focus is achieved. Also, the focus indicator <●> in the viewfinder will not light up.

AI Focus AF for Switching the AF Operation Automatically

AI Focus AF switches the AF operation from One-Shot AF to AI Servo AF automatically if a still subject starts moving.

- After the subject is focused in One-Shot AF, if the subject starts moving, the camera will detect the movement, change the AF operation automatically to AI Servo AF, and start tracking the moving subject.





 When focus is achieved with AI Focus AF with the Servo operation active, the beeper will continue beeping softly. However, the focus indicator <●> in the viewfinder will not light up. Note that focus will not be locked in this case.

AF Points Lighting Up in Red

By default, the AF points light up in red when focus is achieved in low-light conditions. In Creative Zone modes, you can set whether to have the AF points light up in red when focus is achieved.

AF-Assist Beam with the Built-in Flash

Under low-light conditions, when you press the shutter button halfway, the built-in flash may fire a brief burst of flashes. This illuminates the subject to help autofocusing.

- 
 ● AF-assist beam will not be emitted from the built-in flash in or <SCN:  > modes, or when [Built-in flash firing] is set to in , , <SCN:  >, or :  > modes.
- The AF-assist beam will not be emitted with AI Servo AF operation.
- The built-in flash makes a sound when firing continuously. This is normal and not a malfunction.

- 
 ● The effective range of the AF-assist beam emitted by the built-in flash is approx. 4 meters / 13.1 feet.
- In Creative Zone modes, when you raise the built-in flash with the button, the AF-assist beam will fire when necessary. Note that depending on the setting for [..C.Fn II-6: AF-assist beam firing], the AF-assist beam may not be emitted.

Selecting the AF Area and AF Point ☆

The camera has 45 AF points for autofocusing. You can select the AF area selection mode and AF point(s) suiting the scene or subject.

 Depending on the lens attached to the camera, the number of usable AF points, AF point patterns, the shape of Area AF frame, etc. will differ. For details, see “Lenses and Usable AF Points” on page 119.

AF Area Selection Mode

You can select one of four AF area selection modes. See the next page for the selection procedure.

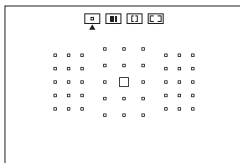

Single-point AF (Manual selection)

Select one AF point to focus.

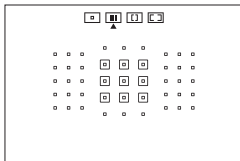

Zone AF (Manual selection of zone)

The AF area is divided into nine focusing zones for focusing.

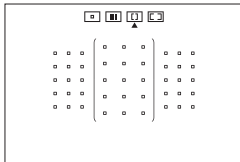

Large Zone AF (Manual selection of zone)

The AF area is divided into three focusing zones (left, center, and right) for focusing.

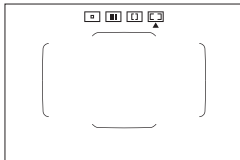



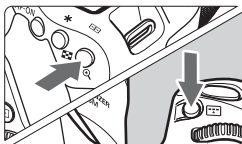

45-point automatic selection AF

The Area AF frame (entire AF area) is used to focus.

Selecting the AF Area Selection Mode



1 Press the  or  button (ⓘ6).

- Look through the viewfinder and press the  or  button.

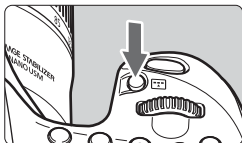



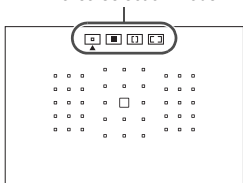

2 Press the  button.

- Each time you press the  button, the AF area selection mode changes.
- The AF area selection mode currently set is indicated on the top of the viewfinder.

AF area selection mode



- With [**C.Fn II-8: Select AF area selec. mode**], you can limit the selectable AF area selection modes.
- If you set [**C.Fn II-9: AF area selection method**] to [1:  → **Main Dial**], you can select the AF area selection mode by pressing the  or  button, then turning the  dial.

Selecting the AF Point Manually

You can manually select the AF point or zone.

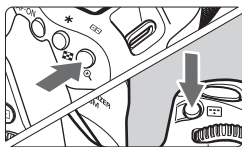

1 Press the or button ().

- ▶ The AF points will be displayed in the viewfinder.
- In the Zone AF mode or Large Zone AF mode, the selected zone will be displayed.

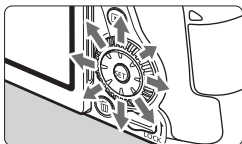

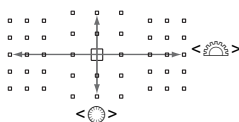

2 Select an AF point.

- The AF point selection will change in the direction you tilt . If you press , the center AF point (or center zone) will be selected.
- You can also select an AF point by shifting horizontally with the dial or vertically with the dial.
- In the Zone AF mode, turning the or dial will change the zone in a looping sequence.



- When you hold down the and turn the dial, you can select an AF point by shifting vertically.
- When [**C.Fn II-11: Initial AFpt**, **AI Servo AF**] is set to [**1: Initial** **AF pt selected**], you can use this method to manually select the AI Servo's AF initial position.
- When you press the or button, the LCD panel displays the following:
 - Zone AF, Large Zone AF, and 45-point automatic selection AF: [] **AF**
 - 1 pt AF: **SEL** [] (Center)/**SEL AF** (Off-center)

AF Point Display Indications

Pressing the  or  button lights up the AF points that are cross-type AF points for high-precision autofocusing. The blinking AF points are horizontal-line or vertical-line sensitive. For details, see pages 118-122.

AF Sensor

The camera's AF sensor has 45 AF points. The illustration below shows the AF sensor pattern corresponding to each AF point. When using lenses with a maximum aperture of $f/2.8$ or faster, high-precision AF is possible with the center AF point in the viewfinder.

Depending on the lens attached to the camera, the number of usable AF points, AF point patterns, the shape of Area AF frame, etc. vary. For details, see "Lenses and Usable AF Points" on page 119.

Diagram

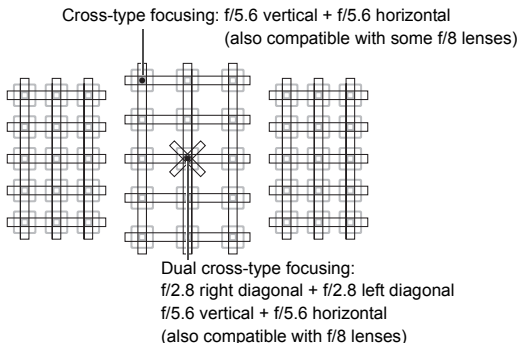

| | |
|--|---|
| | <p>The focusing sensor is geared to obtain higher precision focusing for lenses with a maximum aperture of $f/2.8$ or faster. A diagonal cross pattern makes it easier to focus on subjects difficult for AF. It is provided at the center AF point.</p> |
| | <p>The focusing sensor is geared for lenses with a maximum aperture of $f/5.6$ or faster (and some $f/8$ lenses). Since it has a horizontal pattern, it can detect vertical lines. It covers all 45 AF points.</p> |
| | <p>The focusing sensor is geared for lenses with a maximum aperture of $f/5.6$ or faster (and some $f/8$ lenses). Since it has a vertical pattern, it can detect horizontal lines. It covers all 45 AF points.</p> |

Lenses and Usable AF Points



- Although the camera has 45 AF points, **the number of usable AF points and focusing patterns vary depending on the lens. The lenses are thereby classified into eight groups from A to H.**
- **When using a lens in Groups E to H, fewer AF points will be usable.**
- **See which group each lens belongs to on pages 123-126. Check which group the lens in use belongs to.**
- **The number of available AF points varies depending on aspect ratio settings.**



- When you press the or button, the AF points indicated by the mark will blink. (The / AF points will stay lit.) Regarding lighting up or blinking of the AF points, see page 117.
- For the latest “Lens Group Designations” information, check the Canon website.
- Some lenses may not be available in certain countries or regions.

Group A

Autofocusing with 45 points is possible. All the AF area selection modes are selectable.



- : Dual cross-type AF point. Subject tracking is superior and the focusing precision is higher than with other AF points.
- : Cross-type AF point. Subject tracking is superior and high-precision focusing is achieved.

Group B

Autofocusing with 45 points is possible. All the AF area selection modes are selectable.



- : Cross-type AF point. Subject tracking is superior and high-precision focusing is achieved.

Group C

Autofocusing with 45 points is possible. All the AF area selection modes are selectable.



- : Cross-type AF point. Subject tracking is superior and high-precision focusing is achieved.
- : AF points sensitive to horizontal lines.

Group D

Autofocusing with 45 points is possible. All the AF area selection modes are selectable.



- : Cross-type AF point. Subject tracking is superior and high-precision focusing is achieved.
- : AF points sensitive to horizontal lines.

Group E

Autofocusing with only 35 points is possible. (Not possible with all 45 AF points.) All the AF area selection modes are selectable. During automatic AF point selection, the outer frame marking the AF area (Area AF frame) will be different from 45-point automatic selection AF.

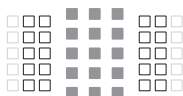

- : Cross-type AF point. Subject tracking is superior and high-precision focusing is achieved.
- : AF points sensitive to horizontal lines.
- : Disabled AF points (not displayed).

Group F

Autofocusing with only 35 points is possible. (Not possible with all 45 AF points.) All the AF area selection modes are selectable. During automatic AF point selection, the outer frame marking the AF area (Area AF frame) will be different from 45-point automatic selection AF.

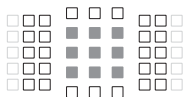

- : Cross-type AF point. Subject tracking is superior and high-precision focusing is achieved.
- : AF points sensitive to vertical lines (AF points in the horizontal array at the top and bottom) or horizontal lines (AF points in a vertical array on the left and right).
- : Disabled AF points (not displayed).

Group G

Autofocusing with only 27 points is possible. (Not possible with all 45 AF points.) Large Zone AF (manual selection of zone) cannot be selected for AF area selection mode. During automatic AF point selection, the outer frame marking the AF area (Area AF frame) will be different from 45-point automatic selection AF.



- : Cross-type AF point. Subject tracking is superior and high-precision focusing is achieved.
- : AF points sensitive to horizontal lines.
- : Disabled AF points (not displayed).

Group H

Autofocusing is possible only with the center AF point.



- : Cross-type AF point. Subject tracking is superior and high-precision focusing is achieved.
- : Disabled AF points (not displayed).

- If the maximum aperture is slower than $f/5.6$ (greater than $f/5.6$ but not exceeding $f/8$), focus may not be achieved with AF when shooting low-contrast or low-light subjects.
- If the maximum aperture is slower than $f/8$ (greater than $f/8$), AF is not possible during viewfinder shooting.

Lens Group Designations (as of the release of EOS 80D (W))

| | | | |
|-------------------------------|---|--|----|
| EF-S24mm f/2.8 STM | A | EF50mm f/1.0L USM | A |
| EF-S60mm f/2.8 Macro USM | B | EF50mm f/1.2L USM | A |
| EF-S10-18mm f/4.5-5.6 IS STM | D | EF50mm f/1.4 USM | A |
| EF-S10-22mm f/3.5-4.5 USM | B | EF50mm f/1.8 | A |
| EF-S15-85mm f/3.5-5.6 IS USM | B | EF50mm f/1.8 II | A |
| EF-S17-55mm f/2.8 IS USM | A | EF50mm f/1.8 STM | A |
| EF-S17-85mm f/4-5.6 IS USM | B | EF50mm f/2.5 Compact Macro | B |
| EF-S18-55mm f/3.5-5.6 | C | EF50mm f/2.5 Compact Macro + LIFE SIZE Converter | B |
| EF-S18-55mm f/3.5-5.6 USM | C | EF85mm f/1.2L USM | A |
| EF-S18-55mm f/3.5-5.6 II | C | EF85mm f/1.2L II USM | A |
| EF-S18-55mm f/3.5-5.6 II USM | C | EF85mm f/1.8 USM | A |
| EF-S18-55mm f/3.5-5.6 III | B | EF100mm f/2 USM | A |
| EF-S18-55mm f/3.5-5.6 IS | C | EF100mm f/2.8 Macro | B |
| EF-S18-55mm f/3.5-5.6 IS II | B | EF100mm f/2.8 Macro USM | E |
| EF-S18-55mm f/3.5-5.6 IS STM | B | EF100mm f/2.8L Macro IS USM | B |
| EF-S18-135mm f/3.5-5.6 IS | B | EF135mm f/2L USM | A |
| EF-S18-135mm f/3.5-5.6 IS USM | B | EF135mm f/2L USM + Extender EF1.4x I/II/III | A |
| EF-S18-135mm f/3.5-5.6 IS STM | B | EF135mm f/2L USM + Extender EF2x I/II/III | B |
| EF-S18-200mm f/3.5-5.6 IS | B | EF135mm f/2.8 (Softfocus) | A |
| EF-S55-250mm f/4-5.6 IS | B | EF180mm f/3.5L Macro USM | B |
| EF-S55-250mm f/4-5.6 IS II | B | EF180mm f/3.5L Macro USM + Extender EF1.4x I/II/III | F |
| EF-S55-250mm f/4-5.6 IS STM | B | EF200mm f/1.8L USM | A |
| EF14mm f/2.8L USM | A | EF200mm f/1.8L USM + Extender EF1.4x I/II/III | A* |
| EF14mm f/2.8L II USM | A | EF200mm f/1.8L USM + Extender EF2x I/II/III | B* |
| EF15mm f/2.8 Fisheye | A | EF200mm f/2L IS USM | A |
| EF20mm f/2.8 USM | A | EF200mm f/2L IS USM + Extender EF1.4x I/II/III | A |
| EF24mm f/1.4L USM | A | EF200mm f/2L IS USM + Extender EF2x I/II/III | B |
| EF24mm f/1.4L II USM | A | EF200mm f/2.8L USM | A |
| EF24mm f/2.8 | A | EF200mm f/2.8L USM + Extender EF1.4x I/II/III | B |
| EF24mm f/2.8 IS USM | A | EF200mm f/2.8L USM + Extender EF2x I/II/III | B |
| EF28mm f/1.8 USM | A | EF200mm f/2.8L USM | A |
| EF28mm f/2.8 | A | EF200mm f/2.8L USM + Extender EF1.4x I/II/III | B |
| EF28mm f/2.8 IS USM | A | EF200mm f/2.8L USM + Extender EF2x I/II/III | B |
| EF35mm f/1.4L USM | A | EF200mm f/2.8L USM | A |
| EF35mm f/1.4L II USM | A | EF200mm f/2.8L USM + Extender EF1.4x I/II/III | B |
| EF35mm f/2 | A | EF200mm f/2.8L USM + Extender EF2x I/II/III | B |
| EF35mm f/2 IS USM | A | EF200mm f/2.8L USM | A |
| EF40mm f/2.8 STM | A | EF200mm f/2.8L II USM | A |

Lenses and Usable AF Points

| | | | |
|--|---------|--|----------|
| EF200mm f/2.8L II USM + Extender EF1.4x I/II/III | B | EF400mm f/2.8L IS II USM + Extender EF1.4x I/II/III | B |
| EF200mm f/2.8L II USM + Extender EF2x I/II/III | B | EF400mm f/2.8L IS II USM + Extender EF2x I/II/III | B |
| EF300mm f/2.8L USM | A | EF400mm f/4 DO IS USM | B |
| EF300mm f/2.8L USM + Extender EF1.4x I/II/III | B* | EF400mm f/4 DO IS USM + Extender EF1.4x I/II/III | B |
| EF300mm f/2.8L USM + Extender EF2x I/II/III | B* | EF400mm f/4 DO IS USM + Extender EF2x I/II/III | H (f/8) |
| EF300mm f/2.8L IS USM | A | EF400mm f/4 DO IS II USM | B |
| EF300mm f/2.8L IS USM + Extender EF1.4x I/II/III | B | EF400mm f/4 DO IS II USM + Extender EF1.4x I/II/III | B |
| EF300mm f/2.8L IS USM + Extender EF2x I/II/III | B | EF400mm f/4 DO IS II USM + Extender EF2x I/II/III | H (f/8) |
| EF300mm f/2.8L IS II USM | A | EF400mm f/5.6L USM | B |
| EF300mm f/2.8L IS II USM + Extender EF1.4x I/II/III | B | EF400mm f/5.6L USM + Extender EF1.4x I/II/III | H (f/8) |
| EF300mm f/2.8L IS II USM + Extender EF2x I/II/III | B | EF500mm f/4L IS USM | B |
| EF300mm f/4L USM | B | EF500mm f/4L IS USM + Extender EF1.4x I/II/III | B |
| EF300mm f/4L USM + Extender EF1.4x I/II/III | B | EF500mm f/4L IS USM + Extender EF2x I/II/III | H (f/8) |
| EF300mm f/4L USM + Extender EF2x I/II/III | H (f/8) | EF500mm f/4L IS II USM | B |
| EF300mm f/4L IS USM | B | EF500mm f/4L IS II USM + Extender EF1.4x I/II/III | B |
| EF300mm f/4L IS USM + Extender EF1.4x I/II/III | B | EF500mm f/4L IS II USM + Extender EF2x I/II/III | H (f/8) |
| EF300mm f/4L IS USM + Extender EF2x I/II/III | H (f/8) | EF500mm f/4.5L USM | B |
| EF400mm f/2.8L USM | A | EF500mm f/4.5L USM + Extender EF1.4x I/II/III | H (f/8)* |
| EF400mm f/2.8L USM + Extender EF1.4x I/II/III | B* | EF600mm f/4L USM | B |
| EF400mm f/2.8L USM + Extender EF2x I/II/III | B* | EF600mm f/4L USM + Extender EF1.4x I/II/III | B* |
| EF400mm f/2.8L II USM | A | EF600mm f/4L USM + Extender EF2x I/II/III | H (f/8)* |
| EF400mm f/2.8L II USM + Extender EF1.4x I/II/III | B* | EF600mm f/4L IS USM | B |
| EF400mm f/2.8L II USM + Extender EF2x I/II/III | B* | EF600mm f/4L IS USM + Extender EF1.4x I/II/III | B |
| EF400mm f/2.8L IS USM | A | EF600mm f/4L IS USM + Extender EF2x I/II/III | H (f/8) |
| EF400mm f/2.8L IS USM + Extender EF1.4x I/II/III | B | EF600mm f/4L IS II USM | B |
| EF400mm f/2.8L IS USM + Extender EF2x I/II/III | B | EF600mm f/4L IS II USM + Extender EF1.4x I/II/III | B |
| EF400mm f/2.8L IS II USM | A | EF600mm f/4L IS II USM + Extender EF2x I/II/III | H (f/8) |
| | | EF800mm f/5.6L IS USM | E |

| | | | |
|---|----------|---|---------|
| EF800mm f/5.6L IS USM + Extender EF1.4x I/II/III | H (f/8) | EF28-135mm f/3.5-5.6 IS USM | B |
| EF1200mm f/5.6L USM | E | EF28-200mm f/3.5-5.6 | B |
| EF1200mm f/5.6L USM + Extender EF1.4x I/II/III | H (f/8)* | EF28-200mm f/3.5-5.6 USM | B |
| EF8-15mm f/4L Fisheye USM | B | EF28-300mm f/3.5-5.6L IS USM | B |
| EF11-24mm f/4L USM | C | EF35-70mm f/3.5-4.5 | E |
| EF16-35mm f/2.8L USM | A | EF35-70mm f/3.5-4.5A | E |
| EF16-35mm f/2.8L II USM | A | EF35-80mm f/4-5.6 | F |
| EF16-35mm f/4L IS USM | B | EF35-80mm f/4-5.6 PZ | E |
| EF17-35mm f/2.8L USM | A | EF35-80mm f/4-5.6 USM | F |
| EF17-40mm f/4L USM | B | EF35-80mm f/4-5.6 II | E |
| EF20-35mm f/2.8L | A | EF35-80mm f/4-5.6 III | F |
| EF20-35mm f/3.5-4.5 USM | C | EF35-105mm f/3.5-4.5 | B |
| EF22-55mm f/4-5.6 USM | F | EF35-105mm f/4.5-5.6 | H |
| EF24-70mm f/2.8L USM | A | EF35-105mm f/4.5-5.6 USM | H |
| EF24-70mm f/2.8L II USM | A | EF35-135mm f/3.5-4.5 | B |
| EF24-70mm f/4L IS USM | B | EF35-135mm f/4-5.6 USM | C |
| EF24-85mm f/3.5-4.5 USM | D | EF35-350mm f/3.5-5.6L USM | D |
| EF24-105mm f/3.5-5.6 IS STM | B | EF38-76mm f/4.5-5.6 | E |
| EF24-105mm f/4L IS USM | B | EF50-200mm f/3.5-4.5 | B |
| EF28-70mm f/2.8L USM | A | EF50-200mm f/3.5-4.5L | B |
| EF28-70mm f/3.5-4.5 | E | EF55-200mm f/4.5-5.6 USM | D |
| EF28-70mm f/3.5-4.5 II | E | EF55-200mm f/4.5-5.6 II USM | D |
| EF28-80mm f/2.8-4L USM | B | EF70-200mm f/2.8L USM | A |
| EF28-80mm f/3.5-5.6 | E | EF70-200mm f/2.8L USM + Extender EF1.4x I/II/III | B** |
| EF28-80mm f/3.5-5.6 USM | E | EF70-200mm f/2.8L USM + Extender EF2x I/II/III | B** |
| EF28-80mm f/3.5-5.6 II | E | EF70-200mm f/2.8L IS USM | A |
| EF28-80mm f/3.5-5.6 II USM | E | EF70-200mm f/2.8L IS USM + Extender EF1.4x I/II/III | B |
| EF28-80mm f/3.5-5.6 III USM | E | EF70-200mm f/2.8L IS USM + Extender EF2x I/II/III | B |
| EF28-80mm f/3.5-5.6 IV USM | E | EF70-200mm f/2.8L IS II USM | A |
| EF28-80mm f/3.5-5.6 V USM | E | EF70-200mm f/2.8L IS II USM + Extender EF1.4x I/II/III | B |
| EF28-90mm f/4-5.6 | B | EF70-200mm f/2.8L IS II USM + Extender EF2x I/II/III | B |
| EF28-90mm f/4-5.6 USM | B | EF70-200mm f/4L USM | B |
| EF28-90mm f/4-5.6 II | B | EF70-200mm f/4L USM + Extender EF1.4x I/II/III | B |
| EF28-90mm f/4-5.6 II USM | B | EF70-200mm f/4L USM + Extender EF2x I/II/III | H (f/8) |
| EF28-90mm f/4-5.6 III | B | | |
| EF28-105mm f/3.5-4.5 USM | B | | |
| EF28-105mm f/3.5-4.5 II USM | B | | |
| EF28-105mm f/4-5.6 | F | | |
| EF28-105mm f/4-5.6 USM | F | | |

| | | | |
|--|---------|---|---------|
| EF70-200mm f/4L IS USM | B | EF100-300mm f/5.6L | B |
| EF70-200mm f/4L IS USM + Extender EF1.4x I/II/III | B | EF100-400mm f/4.5-5.6L IS USM | B |
| EF70-200mm f/4L IS USM + Extender EF2x I/II/III | H (f/8) | EF100-400mm f/4.5-5.6L IS USM + Extender EF1.4x I/II/III | H (f/8) |
| EF70-210mm f/3.5-4.5 USM | B | EF100-400mm f/4.5-5.6L IS II USM | B |
| EF70-210mm f/4 | B | EF100-400mm f/4.5-5.6L IS II USM + Extender EF1.4x I/II | H (f/8) |
| EF70-300mm f/4-5.6 IS USM | B | EF100-400mm f/4.5-5.6L IS II USM + Extender EF1.4x III | G (f/8) |
| EF70-300mm f/4.5-5.6L IS USM | B | EF200-400mm f/4L IS USM Extender 1.4x | B |
| EF70-300mm f/4.5-5.6 DO IS USM | B | EF200-400mm f/4L IS USM Extender 1.4x: With built-in Ext. 1.4x | B |
| EF75-300mm f/4-5.6 | B | EF200-400mm f/4L IS USM Extender 1.4x + Extender EF1.4x I/II/III | B |
| EF75-300mm f/4-5.6 USM | C | EF200-400mm f/4L IS USM Extender 1.4x: With built-in Ext. 1.4x + Extender EF1.4x I/II/III | H (f/8) |
| EF75-300mm f/4-5.6 II | B | EF200-400mm f/4L IS USM Extender 1.4x + Extender EF2x I/II | H (f/8) |
| EF75-300mm f/4-5.6 II USM | B | EF200-400mm f/4L IS USM Extender 1.4x + Extender EF2x III | G (f/8) |
| EF75-300mm f/4-5.6 III | B | TS-E17mm f/4L | B |
| EF75-300mm f/4-5.6 III USM | B | TS-E24mm f/3.5L | B |
| EF75-300mm f/4-5.6 IS USM | B | TS-E24mm f/3.5L II | B |
| EF80-200mm f/2.8L | A | TS-E45mm f/2.8 | A |
| EF80-200mm f/4.5-5.6 | D | TS-E90mm f/2.8 | A |
| EF80-200mm f/4.5-5.6 USM | E | | |
| EF80-200mm f/4.5-5.6 II | E | | |
| EF90-300mm f/4.5-5.6 | D | | |
| EF90-300mm f/4.5-5.6 USM | D | | |
| EF100-200mm f/4.5A | B | | |
| EF100-300mm f/4.5-5.6 USM | C | | |
| EF100-300mm f/5.6 | B | | |



- If Extender EF2x (I/II/III) is attached to the EF180mm f/3.5L Macro USM lens, AF is not possible.
- When using a lens and Extender EF1.4x III/EF2x III in a combination marked with an asterisk (*) or when using a lens and extender in a combination marked with two asterisks (**), precise focus may not be achieved with AF. In such a case, refer to the Instruction Manual of the lens or extender used.



If you use a TS-E lens, manual focusing will be required. The lens group designation of TS-E lenses applies only when you do not use tilt or shift function.

MF: Manual Focus

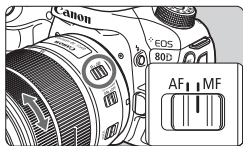

Focusing ring

1 Set the lens's focus mode switch to <MF>.

- ▶ <M FOCUS> will be displayed on the LCD panel.

2 Focus on the subject.

- Focus by turning the lens's focusing ring until the subject looks sharp in the viewfinder.

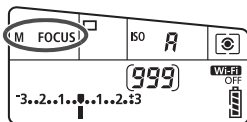

- If you press the shutter button halfway during manual focusing, the AF point that achieved focus and the focus indicator <●> will light up in the viewfinder.
- With 45-point automatic selection AF, when the center AF point achieves focus, the focus indicator <●> will light up.

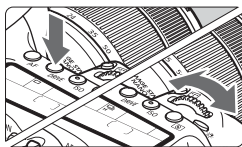

Selecting the Drive Mode

Single and continuous drive modes are provided.



1 Press the <DRIVE> button (ⓘ6).

2 Select the drive mode.

- While looking at the LCD panel, turn the < > or < > dial.

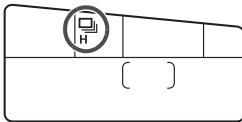

: **Single shooting**

When you press the shutter button completely, only one shot will be taken.

H: **High-speed continuous shooting** (Max. approx. 7.0 shots/sec.*)

While you hold down the shutter button completely, the camera will shoot continuously.

* During Live View shooting or when [Servo AF] is set, the maximum speed will be max. approx. 5.0 shots/sec.

: **Low-speed continuous shooting** (Max. approx. 3.0 shots/sec.)

While you hold down the shutter button completely, the camera will shoot continuously.

S: **Silent single shooting**

You can shoot one image at a time while suppressing the camera noise during viewfinder shooting.

S: **Silent continuous shooting** (Max. approx. 3.0 shots/sec.)

You can shoot continuously while suppressing the camera noise during viewfinder shooting.

: **10-sec. self-timer/remote control**





2: **2-sec. self-timer/remote control**

For self-timer shooting, see page 130.



- H: The maximum continuous shooting speed of approx. 7.0 shots/sec. is attained under the following conditions*: 1/500 sec. or faster shutter speed, maximum aperture (varies depending on the lens), Anti-flicker shooting set to Disable, with a fully-charged Battery Pack LP-E6N, and at room temperature (23°C/73°F). The continuous shooting speed may become slower depending on the shutter speed, aperture, subject conditions, brightness, lens, flash use, temperature, battery type, remaining battery level, etc.

* With the AF mode set to One-Shot AF and the Image Stabilizer turned off when using the following lenses: EF300mm f/4L IS USM, EF28-135mm f/3.5-5.6 IS USM, EF75-300mm f/4-5.6 IS USM, EF100-400mm f/4.5-5.6L IS USM.

- If <S> or <S> is set, the time lag from when you press the shutter button completely until the picture is taken will be slightly longer than normal.
- With Live View shooting, <S> and <S> cannot be set.
- The continuous shooting speed may become slower if the remaining battery level is low or if you shoot under low-light conditions.
- In AI Servo AF operation, the continuous shooting speed may become slightly slower depending on the subject and the lens used.
- If you use Battery Grip BG-E14 (sold separately) with AA/R6 batteries, the high-speed continuous shooting speed may be slower.
- If you set [4: **Anti-flicker shoot.**] to [**Enable**] (p.152) and shoot under a flickering light source, the continuous shooting speed may decrease slightly, the shooting interval may become irregular, or the release time lag may become longer.
- When internal memory becomes full during continuous shooting, the continuous shooting speed may drop since shooting will be temporarily disabled.

ⓘ Using the Self-timer

Use the self-timer when you want to be in the picture.

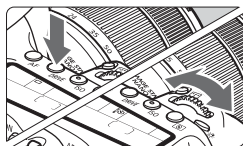

1 Press the <DRIVE> button (ⓘ6).

2 Select the self-timer.

- While looking at the LCD panel, turn the <ⓘ6> or <ⓘ7> dial to select the self-timer delay.

ⓘ6 : **Shoot in approx. 10 sec.**

ⓘ7 : **Shoot in approx. 2 sec.**

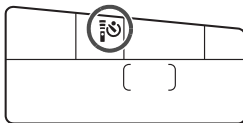

3 Take the picture.

- Look through the viewfinder, focus on the subject, then press the shutter button completely.
- ▶ You can check the self-timer operation with the self-timer lamp, beeper, and countdown display (in seconds) on the LCD panel.
- ▶ 2 sec. before the picture is taken, the self-timer lamp will light up and the beeper will sound faster.

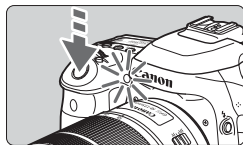

ⓘ If you do not look through the viewfinder when you press the shutter button, attach the eyepiece cover. If stray light enters the viewfinder when the picture is taken, it may throw off the exposure.

- The <ⓘ7> enables you to shoot while not touching the camera mounted on a tripod. This prevents camera vibration blur when you shoot still lifes or long exposures.
- After taking self-timer shots, playing back the image (p.216) to check focus and exposure is recommended.
- When using the self-timer to shoot yourself, use focus lock (p.75) on an object at the same distance as where you will stand.
- To cancel the self-timer after it starts, either touch the LCD monitor or press the <DRIVE> button.

4

Image Settings

This chapter explains image-related function settings: Image-recording quality, ISO speed, Picture Style, white balance, Auto Lighting Optimizer, noise reduction, lens aberration correction, anti-flicker shooting, and other functions.

- The ☆ icon at the upper right of the page title indicates that the function is available only in Creative Zone modes (**P/Tv/Av/M/B**).

MENU Setting the Image-Recording Quality

You can select the pixel count and the image quality. There are eight JPEG image-recording quality settings: **L**, **L**, **M**, **M**, **S1**, **S1**, **S2**, **S3**. There are three RAW image quality settings: **RAW**, **M RAW**, **S RAW** (p.134).



1 Select [Image quality].

- Under the [**1**] tab, select [Image quality], then press <SET>.

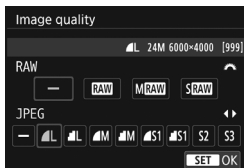

2 Set the image-recording quality.

- To select a RAW setting, turn the <DIAL> dial. To select a JPEG setting, press the <LEFT> <RIGHT> keys.
- On the upper right of the screen, “***M (megapixels) ***x***” indicates the recorded pixel count, and [***] is the number of possible shots (displayed up to 999).
- Press <SET> to set it.

Image-recording Quality Setting Examples

L only

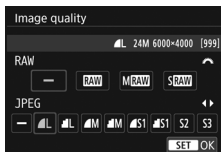

RAW + **L**

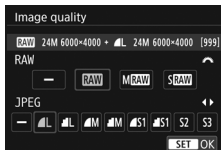

RAW only

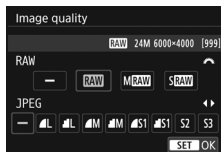

S RAW + **M**



! The image size [***x***] and number of possible shots [***] for the [3:2] aspect ratio will always be displayed on the image-recording quality setting screen regardless of the [4: Aspect ratio] setting.

If [-] is set for both RAW and JPEG, **L** will be set.

Guide to Image-Recording Quality Settings (Approx.)

| Image Quality | | Pixels Recorded | Printing Size | File Size (MB) | Possible Shots | Maximum Burst |
|---------------|------------------|-----------------|---------------|----------------|----------------|---------------|
| JPEG | L | 24M | A2 | 7.6 | 940 | 77 (110) |
| | L | | | 3.9 | 1800 | 120 (120) |
| | M | 11M | A3 | 4.1 | 1730 | 140 (140) |
| | M | | | 2.0 | 3430 | 140 (140) |
| | S1 | 5.9M | A4 | 2.6 | 2700 | 140 (140) |
| | S1 | | | 1.3 | 5260 | 150 (150) |
| | S2 ^{*1} | 2.5M | 9x13 cm | 1.3 | 5260 | 150 (150) |
| | S3 ^{*2} | 0.3M | - | 0.3 | 20180 | 150 (150) |
| RAW | RAW | 24M | A2 | 28.9 | 240 | 20 (25) |
| | M RAW | 14M | A3 | 22.8 | 300 | 21 (26) |
| | S RAW | 6.0M | A4 | 15.9 | 440 | 27 (28) |
| RAW + JPEG | RAW | 24M | A2 | 28.9+7.6 | 190 | 20 (22) |
| | L | 24M | A2 | | | |
| | M RAW | 14M | A3 | 22.8+7.6 | 220 | 20 (22) |
| | L | 24M | A2 | | | |
| S RAW | 6.0M | A4 | 15.9+7.6 | 300 | 22 (22) | |
| L | 24M | A2 | | | | |



*1 : S2 is suitable for playing the images on a digital photo frame.

*2 : S3 is suitable for emailing the image or using it on a website.

- S2 and S3 will be in (Fine) quality.
- The file size, possible shots, and maximum burst during continuous shooting are based on Canon's testing standards (3:2 aspect ratio, ISO 100 and Standard Picture Style) using an 8 GB card. **These figures will vary depending on the subject, card brand, aspect ratio, ISO speed, Picture Style, Custom Functions, and other settings.**
- The maximum burst applies to high-speed continuous shooting. Figures in parentheses apply to an UHS-I class 16 GB card based on Canon's testing standards.



Even if you use a UHS-I class card, the maximum burst indicator will not change. The maximum burst in parentheses in the table will apply instead.

- If you select both RAW and JPEG, the same image will be recorded simultaneously to the card in both RAW and JPEG at the image-recording qualities that were set. The two images will be recorded with the same file numbers (file extension: .JPG for JPEG and .CR2 for RAW).
- The image-recording quality icons are as follows: **RAW** (RAW), **M RAW** (Middle RAW), **S RAW** (Small RAW), JPEG,  (Fine),  (Normal), **L** (Large), **M** (Middle), **S** (Small).

RAW Images

A RAW image is raw data output by the image sensor converted to digital data. It is recorded to the card as is, and you can select the quality as follows: **RAW**, **M RAW**, or **S RAW**.

A **RAW** image can be processed with [] **1: RAW image processing** and saved as a JPEG image. (**M RAW** and **S RAW** images cannot be processed with the camera.) As the RAW image itself does not change, you can process the RAW image to create any number of JPEG images with various processing conditions.

You can use Digital Photo Professional (EOS software, p.232) to process RAW images. You can make various adjustments to images depending upon how they will be used and generate JPEG, TIFF, or other types of images reflecting the effects of those adjustments.

RAW Image Processing Software

- To display RAW images on a computer, using Digital Photo Professional (DPP, EOS software) is recommended.
- Previous versions of DPP Ver.4.x cannot process RAW images taken with this camera. If a previous version of DPP Ver.4.x is installed on your computer, obtain and install the latest version of DPP from the Canon website to update it (p.232). (The previous version will be overwritten.) Note that DPP Ver.3.x or earlier cannot process RAW images taken with this camera.
- Commercially-available software may not be able to display RAW images taken with this camera. For compatibility information, contact the software manufacturer.

ISO: Setting the ISO Speed for Still Photos [☆]

Set the ISO speed (image sensor's sensitivity to light) to suit the ambient light level. In Basic Zone modes, the ISO speed is set automatically.

Regarding the ISO speed during movie shooting, see pages 200 and 202.

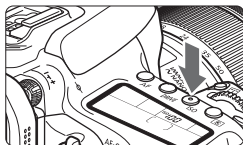

1 Press the <ISO> button (⚙️6).

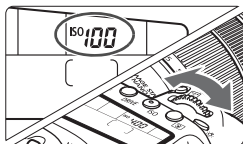

2 Set the ISO speed.

- While looking at the LCD panel or in the viewfinder, turn the <⚙️> or <⚙️> dial.
- ISO speed can be set within ISO 100 - ISO 16000 in 1/3-stop increments.
- “A” indicates ISO Auto. The ISO speed will be set automatically.
- When the screen shown on the left is displayed, you can press the <INFO.> button to set it to “AUTO”.

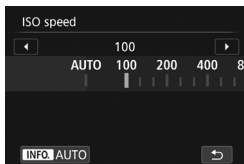

ISO Speed Guide



| ISO Speed | Shooting Situation (No flash) | Flash Range |
|-------------------------|--------------------------------|--|
| ISO 100 - ISO 400 | Sunny outdoors | The higher the ISO speed, the farther the effective flash range will extend. |
| ISO 400 - ISO 1600 | Overcast skies or evening time | |
| ISO 1600 - ISO 16000, H | Dark indoors or night | |

* High ISO speeds will result in grainier images.

- As “H” (equivalent to ISO 25600) is an expanded ISO speed setting, noise (dots of light, banding, etc.) and irregular colors will be more noticeable, and the resolution will be lower compared with the standard setting.
- If [ 3: **Highlight tone priority**] is set to [**Enable**], ISO 100/125/160 and “H” (equivalent to ISO 25600) cannot be selected (p.147).
- Shooting in high temperatures may result in images that look grainier. Long exposures can also cause irregular colors in the image.
- When you shoot at high ISO speeds, noise (such as dots of light and banding) may become noticeable.
- When shooting in conditions that produce an extreme amount of noise, such as a combination of high ISO speed, high temperature, and long exposure, images may not be recorded properly.
- If you use a high ISO speed and flash to shoot a close subject, overexposure may result.



Selecting a Picture Style ☆

By selecting a Picture Style, you can obtain image characteristics matching your photographic expression or the subject.

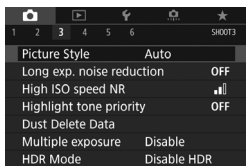
In Basic Zone modes, [] (Auto) is set automatically. (In < > modes, [] (Standard) is set.)



1 Select [] Picture Style].

- Under the [ 3] tab, select [ Picture Style], then press < >.



2 Select a Picture Style.

- Select a Picture Style, then press < >.
- ▶ The Picture Style will be set.

Picture Style Characteristics

Auto

The color tone will be adjusted automatically to suit the scene. The colors will look vivid for blue skies, greenery and sunsets, particularly in nature, outdoor and sunset scenes.



If the desired color tone is not obtained with [**Auto**], use another Picture Style.

Standard

The image looks vivid, sharp, and crisp. This is a general-purpose Picture Style suitable for most scenes.

Portrait

For nice skin tones. The image looks softer. Suited for close-up portraits.

By changing the [**Color tone**], you can adjust the skin tone.

Landscape

For vivid blues and greens, and very sharp and crisp images.
Effective for impressive landscapes.

Fine Detail

Suited for detailed outline and fine texture description of the subject.
The colors will be slightly vivid.

Neutral

This Picture Style is for users who prefer to process images with their computer. For natural colors and subdued images with modest brightness and color saturation.



Faithful

Suited for processing the image with a computer. The color of a subject that is captured in sunlight at a color temperature of 5200K will be adjusted to match the subject's colorimetric color. For subdued images with modest brightness and color saturation.

Monochrome

Creates black-and-white images.

 Black-and-white images shot in JPEG cannot be turned into color. Be careful not to leave the **[Monochrome]** setting on when you want to shoot photos in color again.

 You can display  in the viewfinder when **[Monochrome]** is set.

User Def. 1-3

You can register a basic style such as **[Portrait]**, **[Landscape]**, a Picture Style file, etc., and adjust it as desired. Any User Defined Picture Style that has not been set will have the same default settings as the **[Auto]** Picture Style.

MENU Setting the White Balance ☆

White balance (WB) is for making the white areas look white. Normally, the Auto [AWB] (Ambience priority) or [AWB w] (White priority) setting will obtain the correct white balance. If natural-looking colors cannot be obtained with Auto, you can select the white balance to match the light source or set it manually by shooting a white object.

In Basic Zone modes, [AWB] (Ambience priority) is set automatically. (In the <P> mode, [AWB w] (White priority) is set.)

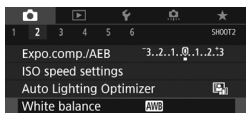

1 Select [White balance].

- Under the [2] tab, select [White balance], then press <SET>.

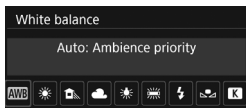

2 Select a white balance setting.

- Select the desired setting, then press <SET>.

(Approx.)

| Display | Mode | Color Temperature (K: Kelvin) |
|---------|---------------------------------|-------------------------------|
| [AWB] | Auto (Ambience priority, p.140) | 3000-7000 |
| [AWB w] | Auto (White priority, p.140) | |
| ☀ | Daylight | 5200 |
| 🏠 | Shade | 7000 |
| ☁ | Cloudy, twilight, sunset | 6000 |
| 💡 | Tungsten light | 3200 |
| 💡 | White fluorescent light | 4000 |
| ⚡ | Flash use | Automatically set* |
| 📷 | Custom | 2000-10000 |
| [K] | Color temperature | 2500-10000 |

* Applicable with Speedlites having a color temperature transmission function. Otherwise, it will be fixed to approx. 6000 K.

White Balance

To the human eye, a white object looks white regardless of the type of lighting. With a digital camera, the white for color correction basis is decided depending on the color temperature of the illumination, and then the color is adjusted with software to make the white areas look white. With this function, pictures with natural color tones can be taken.

AWB Setting the Auto White Balance

With [**AWB**] (Ambience priority), you can increase the intensity of the image's warm color cast when shooting a tungsten-light scene. If you select [**AWB w**] (White priority), you can reduce the intensity of the image's warm color cast.

If you want to match the Auto white balance of previous EOS camera models, select [**AWB**] (Ambience priority).

1 Select [White balance].

- Under the [**2**] tab, select [White balance], then press <SET>.

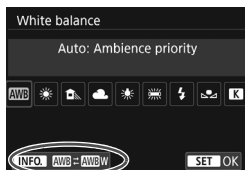

2 Select [**AWB**].

- Select [**AWB**], then press the <INFO.> button.

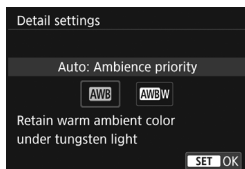

3 Select the desired item.

- Select [**Auto: Ambience priority**] or [**Auto: White priority**], then press <SET>.

AWB : Auto: Ambience priority

AWB w : Auto: White priority

**Cautions for Setting [AWB w] (White priority)**

- The warm color cast of subjects may fade.
- When multiple light sources are included on the screen, the warm color cast of the picture may not be lessened.
- When using flash, the color tone will be the same as [AWB] (Ambience priority).

MENU Auto Correction of Brightness and Contrast ☆

If the image comes out dark or the contrast is low, the brightness and contrast can be corrected automatically. This function is called Auto Lighting Optimizer. The default setting is [**Standard**]. With JPEG images, the correction is applied when the image is captured.

In Basic Zone modes, [**Standard**] is set automatically.

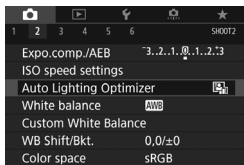

1 Select [**Auto Lighting Optimizer**].

- Under the [**2**] tab, select [**Auto Lighting Optimizer**], then press < **SET** >.

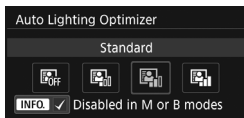

2 Select the setting.

- Select the desired setting, then press < **SET** >.

3 Take the picture.

- The image will be recorded with the brightness and contrast corrected if necessary.

- Depending on the shooting conditions, noise may increase.
- If a setting other than [**Disable**] is set and you use exposure compensation or flash exposure compensation to darken the exposure, the image may still come out bright. If you want a darker exposure, set this function to [**Disable**].
- If HDR mode, highlight tone priority (p.147), or multiple-exposure shooting is set, the Auto Lighting Optimizer will be set automatically to [**Disable**].

In step 2, if you press the <**INFO.**> button and uncheck [**✓**] the [**Disabled in M or B modes**] setting, the [**Auto Lighting Optimizer**] can also be set in the <**M**> and <**B**> modes.

MENU Setting Noise Reduction ☆

High ISO Speed Noise Reduction

This function reduces the noise generated in the image. Although noise reduction is applied at all ISO speeds, it is particularly effective at high ISO speeds. When shooting at low ISO speeds, the noise in the darker parts of the image (shadow areas) can further be reduced.

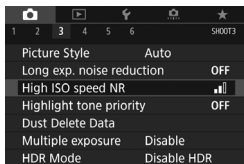

1 Select [High ISO speed NR].

- Under the [CAMERA] tab, select [High ISO speed NR], then press <SET>.

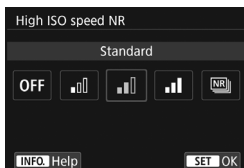

2 Set the level.

- Select the desired noise reduction level, then press <SET>.

- **NR**: Multi Shot Noise Reduction

This applies noise reduction with higher image quality than [High]. For a single photo, four shots are taken continuously and aligned and merged automatically into a single JPEG image. If the image-recording quality is set to RAW or RAW+JPEG, you cannot set [Multi Shot Noise Reduction].

3 Take the picture.

- The image will be recorded with noise reduction applied.



When Multi Shot Noise Reduction is set, you can display <NR> in the viewfinder.



Cautions for Setting Multi Shot Noise Reduction

- If there is significant misalignment in the image due to camera shake, the noise reduction effect may become smaller.
- If you are handholding the camera, keep it steady to prevent camera shake. Using a tripod is recommended.
- If you shoot a moving subject, the moving subject may leave afterimages.
- The image alignment may not function properly with repetitive patterns (lattice, stripes, etc.) or flat, single-tone images.
- If the subject's brightness changes as the four consecutive shots are taken, irregular exposure in the image may result.
- After shooting, it may take some time to record an image to the card for noise reduction and merging the images. During the processing of the images, "buSY" will be displayed in the viewfinder and on the LCD panel, and you cannot take another picture until the processing is completed.
- You cannot use AEB and WB bracketing.
- If [3: Long exp. noise reduction], [3: Multiple exposure], [3: HDR Mode], AEB, or WB bracketing is set, [**Multi Shot Noise Reduction**] cannot be set.
- You cannot set [**Multi Shot Noise Reduction**] for bulb exposures or movie shooting.
- Flash shooting is not possible. The AF-assist beam will be emitted according to the [C.Fn II -6: AF-assist beam firing] setting.
- If you turn off the power, change the shooting mode to a Basic Zone mode or , or switch to movie shooting, the setting will automatically switch to [**Standard**].

Long Exposure Noise Reduction

Noise reduction is possible with images exposed for 1 sec. or longer.

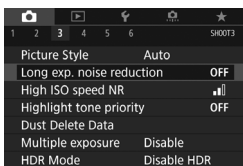

1 Select [Long exp. noise reduction].

- Under the [**3**] tab, select [**Long exp. noise reduction**], then press <SET>.

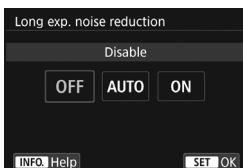

2 Set the desired setting.

- Select the desired setting, then press <SET>.

● Auto

For exposures of 1 sec. or longer, noise reduction is performed automatically if noise typical of long exposures is detected. This [**Auto**] setting is effective in most cases.

● Enable

Noise reduction is performed for all exposures of 1 sec. or longer. The [**Enable**] setting may reduce noise that cannot be detected with the [**Auto**] setting.

3 Take the picture.

- The image will be recorded with noise reduction applied.

-  With **[Auto]** and **[Enable]**, the noise reduction process after the picture is taken may take the same amount of time as that for the exposure. You cannot take another picture until the noise reduction process is completed.
- Images taken at ISO 1600 or higher may look grainier with the **[Enable]** setting than with the **[Disable]** or **[Auto]** setting.
- With **[Enable]**, if a long exposure is shot with the Live View image displayed, **"BUSY"** will be displayed during the noise reduction process. The Live View display will not appear until the noise reduction is completed. (You cannot take another picture.)

MENU Highlight Tone Priority ☆

You can reduce overexposed, clipped highlights.

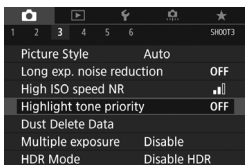

- 1 Select [Highlight tone priority].**
 - Under the [**3**] tab, select **[Highlight tone priority]**, then press **<SET>**.

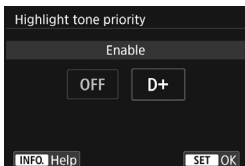

- 2 Select [Enable].**
 - Highlight details are improved. The dynamic range is expanded from the standard 18% gray to bright highlights. The gradation between the grays and highlights becomes smoother.
- 3 Take the picture.**
 - The image will be recorded with highlight tone priority applied.

- When **[Enable]** is set, noise may increase slightly.
- With **[Enable]**, the settable ISO speed range will be ISO 200 or higher. Expanded ISO speed cannot be set.

 If highlight tone priority is set, **<D+>** is displayed in the viewfinder and on the LCD panel.

MENU Correction of Lens Peripheral Illumination and Aberrations ☆

Peripheral light fall-off is a phenomenon that makes the image corners look darker due to the lens characteristics. Color fringing along subject outlines is called chromatic aberration. And image distortion due to lens characteristics is called distortion. These lens aberrations and light falloff can be corrected. By default, Peripheral illumination and Chromatic aberration correction are set to **[Enable]**, and Distortion correction is set to **[Disable]**.

If **[Correction data not available]** is displayed, see “Lens Correction Data” on page 150.

Peripheral Illumination Correction

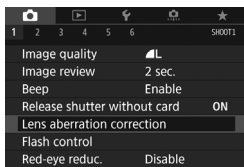

1 Select [Lens aberration correction].

- Under the [**1**] tab, select **[Lens aberration correction]**, then press **<SET>**.

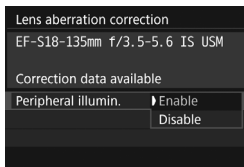

2 Select the setting.

- Check that **[Correction data available]** is displayed for the attached lens.
- Select **[Peripheral illumin.]**, then press **<SET>**.
- Select **[Enable]**, then press **<SET>**.

3 Take the picture.

- The image will be recorded with the peripheral illumination corrected.

Depending on shooting conditions, noise may appear on the image periphery.

- The correction amount applied will be lower than the maximum correction amount that can be applied with Digital Photo Professional (EOS software, p.232).
- The higher the ISO speed, the lower the correction amount will be.
- In Basic Zone modes, the peripheral illumination correction and chromatic aberration correction will be applied automatically. Distortion correction will not be applied.

Chromatic Aberration Correction

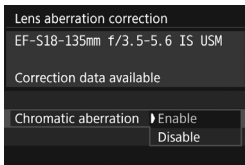

1 Select the setting.

- Check that [**Correction data available**] is displayed for the attached lens.
- Select [**Chromatic aberration**], then press <SET>.
- Select [**Enable**], then press <SET>.

2 Take the picture.

- The image will be recorded with the chromatic aberration corrected.

Distortion Correction

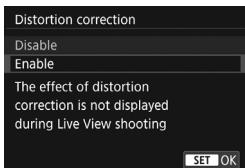

1 Select the setting.

- Check that [**Correction data available**] is displayed for the attached lens.
- Select [**Distortion correction**], then press <SET>.
- Select [**Enable**], then press <SET>.

2 Take the picture.

- The image will be recorded with the distortion corrected.

- When distortion correction is enabled, the camera records an image range narrower than the one seen through the viewfinder. (Image periphery will be slightly trimmed and resolution slightly lowered.)
- Distortion correction will be reflected in the captured image, but not in the viewfinder or Live View image during shooting.
- If you set [**Distortion correction**] to [**Enable**], the maximum burst during continuous shooting will decrease.
- Distortion will not be corrected if you shoot a movie or set the HDR mode, multiple exposures, or Multi Shot Noise Reduction.
- Using distortion correction during Live View shooting will slightly affect the angle of view.
- AF point display information and Dust Delete Data will not be appended to images recorded with distortion correction applied.

Lens Correction Data

The camera already contains data for lens peripheral illumination correction, chromatic aberration correction, and distortion correction for approx. 30 lenses. If you select [**Enable**], the peripheral illumination correction, chromatic aberration correction, and distortion correction will be applied automatically for any lens whose correction data is registered in the camera.

With EOS Utility (EOS software), you can check which lenses have their correction data registered in the camera. You can also register the correction data for unregistered lenses. For details, refer to the EOS Utility Instruction Manual.

For lenses incorporating the correction data, it is not necessary to register the correction data to the camera.



Cautions for Lens Correction

- Peripheral illumination correction, chromatic aberration correction, and distortion correction cannot be applied to JPEG images already taken.
- When using a non-Canon lens, setting the corrections to **[Disable]** is recommended, even if **[Correction data available]** is displayed.
- If you use the magnified view during Live View shooting, the peripheral illumination correction will not be reflected in the image displayed on the screen.
- The correction amount will be less if the lens used does not have distance information.



Notes for Lens Correction

- If the effect of the correction is not visible, magnify the image after shooting and check it again.
- Corrections can be applied even when an Extender or Life-size Converter is attached.
- If the correction data for the attached lens is not registered to the camera, the result will be the same as when the correction is set to **[Disable]**.

MENU Reducing Flicker ☆

If you shoot an image with a fast shutter speed under a light source such as fluorescent light, the blinking of the light source causes flicker and the image may be vertically unevenly exposed. If continuous shooting is used under these conditions, uneven exposures or colors across the images may result. When you use this feature during viewfinder shooting, the camera detects the frequency of the light source's blinking and takes the picture when the flicker causes less effect on exposure or color tone.

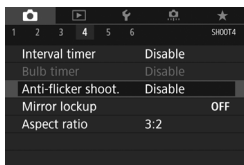

1 Select [Anti-flicker shoot.].

- Under the [**4**] tab, select [**Anti-flicker shoot.**], then press <SET>.

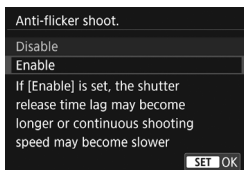

2 Select [Enable].

3 Take the picture.

- The image will be taken with reduced unevenness of exposure or color tone caused by the flicker.

- When [**Enable**] is set and you shoot under a flickering light source, the shutter-release time lag may become longer. Also, the continuous shooting speed may become slower, and the shooting interval may become irregular.
- This function does not work with Live View shooting or movie shooting.
- In the <P> or <Av> mode, if the shutter speed changes during continuous shooting or if you shoot multiple shots of the same scene at different shutter speeds, the color tone may be inconsistent. To avoid inconsistent color tones, use the <Tv> or <M> mode at a fixed shutter speed.
- The color tone of images shot when [**Anti-flicker shoot.**] is set to [**Enable**] may look different from when [**Disable**] is set.
- Flicker at a frequency other than 100 Hz or 120 Hz cannot be detected. Also, if the flickering frequency of the light source changes during continuous shooting, effects of the flicker cannot be reduced.



- If the subject is against a dark background or if there is a bright light in the image, flicker may not be properly detected.
- Under certain special types of lighting, the camera may not be able to reduce the effects of the flicker even when < **Flicker!** > is displayed in the viewfinder.
- Depending on the light source, flicker may not be detected properly.
- If you recompose a shot, < **Flicker!** > may appear and disappear intermittently.
- Depending on the light sources or shooting conditions, expected result may not be obtained even if you use this function.



- Taking test shots in advance is recommended.
- If < **Flicker!** > is not displayed in the viewfinder, under [**F2: Viewfinder display**], set [**Flicker detection**] to [**Show**] (p.68). When the camera reduces the effects of the flicker when you shoot, < **Flicker!** > will light up. Under a light source which does not flicker, or if no flicker is detected, < **Flicker!** > will not be displayed.
- If [**Flicker detection**] is set to [**Show**] and [**Anti-flicker shoot.**] is set to [**Disable**], metering under a flickering light source will cause < **Flicker!** > to blink in the viewfinder as a warning. Setting [**Enable**] before shooting is recommended.
- In Basic Zone modes, < **Flicker!** > will not be displayed, but the effects of flicker will be reduced when you shoot.
- Anti-flicker shooting also works with flash. However, the expected result may not be obtained during wireless flash shooting.



5

Advanced Operations

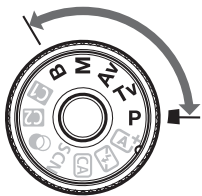

In Creative Zone modes, you can change various settings of the camera as you desire to obtain a wide variety of shooting results, by selecting the shutter speed and/or aperture, adjusting the exposure as you prefer, etc.

- The ☆ icon at the upper right of the page title indicates that the function is available only in Creative Zone modes (**P/Tv/Av/M/B**).
- After you press the shutter button halfway and let go, the exposure settings will remain displayed in the viewfinder and on the LCD panel for approx. 4 sec. (4) by the metering timer function.



Set the <LOCK> switch downward.

P: Program AE

The camera automatically sets the shutter speed and aperture to suit the subject's brightness. This is called Program AE.

* <P> stands for Program.

* AE stands for Auto Exposure.



1 Set the Mode Dial to <P>.

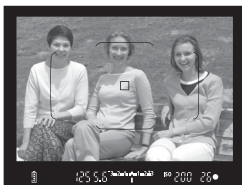

2 Focus on the subject.

- Look through the viewfinder and aim the AF point over the subject. Then press the shutter button halfway.
- ▶ When focus is achieved, the focus indicator <●> on the viewfinder's bottom right will light up (when in One-Shot AF mode).
- ▶ The shutter speed and aperture will be set automatically and displayed in the viewfinder and on the LCD panel.



3 Check the display.

- The standard exposure will be obtained as long as the shutter speed and aperture display do not blink.

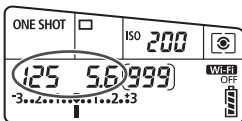

4 Take the picture.

- Compose the shot and press the shutter button completely.





- If the “30” shutter speed and the lowest f/number blink, it indicates underexposure. Increase the ISO speed or use flash.
- If the “8000” shutter speed and the highest f/number blink, it indicates overexposure. Lower the ISO speed or use an ND filter (sold separately) to reduce the amount of light entering the lens.



Differences Between <P> and <A+> Modes

In the <A+> mode, many functions, such as the AF operation and metering mode, are set automatically to prevent spoiled shots. The functions you can set are limited. With <P> mode, only the shutter speed and aperture are set automatically. You can freely set the AF operation, metering mode, and other functions.

Program Shift

- In the Program AE mode, you can freely change the shutter speed and aperture combination (Program) set automatically by the camera while maintaining the same exposure. This is called Program shift.
- To shift the program, press the shutter button halfway, then turn the  dial until the desired shutter speed or aperture is displayed.
- Program shift will be canceled automatically when the metering timer () ends (exposure setting display turns off).
- Program shift cannot be used with flash.

Tv: Shutter-Priority AE

In this mode, you set the shutter speed and the camera automatically sets the aperture to obtain the standard exposure matching the brightness of the subject. This is called shutter-priority AE. A faster shutter speed can freeze the action of a moving subject. A slower shutter speed can create a blurred effect, giving the impression of motion.

* <Tv> stands for Time value.



Blurred motion
(Slow shutter speed: 1/30 sec.)



Frozen motion
(Fast shutter speed: 1/2000 sec.)



1 Set the Mode Dial to <Tv>.

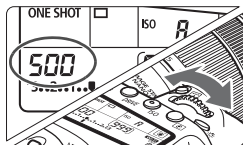

2 Set the desired shutter speed.

- While looking at the LCD panel, turn the  dial.

3 Focus on the subject.

- Press the shutter button halfway.
- ▶ The aperture is set automatically.



4 Check the viewfinder display and shoot.

- As long as the aperture is not blinking, the standard exposure will be obtained.



- If the lowest f/number blinks, it indicates underexposure. Turn the  dial to set a slower shutter speed until the aperture stops blinking or set a higher ISO speed.



- If the highest f/number blinks, it indicates overexposure. Turn the  dial to set a faster shutter speed until the aperture stops blinking or set a lower ISO speed.



Shutter Speed Display

The shutter speeds from “8000” to “4” indicate the denominator of the fractional shutter speed. For example, “125” indicates 1/125 sec., “0”5” indicates 0.5 sec. and “15” is 15 sec.

Av : Aperture-Priority AE

In this mode, you set the desired aperture and the camera sets the shutter speed automatically to obtain the standard exposure matching the subject brightness. This is called aperture-priority AE. A higher f/number (smaller aperture hole) will make more of the foreground and background fall within acceptable focus. On the other hand, a lower f/number (larger aperture hole) will make less of the foreground and background fall within acceptable focus.

* <Av> stands for Aperture value (aperture opening).



Blurred background
(With a low aperture f/number: f/5.6)



Sharp foreground and background
(With a high aperture f/number: f/32)



1 Set the Mode Dial to <Av>.

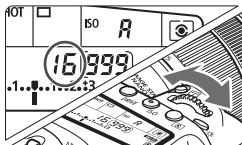

2 Set the desired aperture.

- While looking at the LCD panel, turn the <APERTURE> dial.

3 Focus on the subject.

- Press the shutter button halfway.
- ▶ The shutter speed is set automatically.



4 Check the viewfinder display and shoot.

- As long as the shutter speed is not blinking, the standard exposure will be obtained.



- If the “30” shutter speed blinks, it indicates underexposure. Turn the dial to set a faster aperture (lower f/number) until the shutter speed blinking stops or set a higher ISO speed.



- If the “8000” shutter speed blinks, it indicates overexposure. Turn the dial to set a slower aperture (higher f/number) until the shutter speed blinking stops or set a lower ISO speed.



Aperture Value Display

The higher the f/number, the smaller the aperture opening will be. The f/number displayed will differ depending on the lens. If no lens is attached to the camera, “00” will be displayed for the aperture.

Depth-of-Field Preview [☆]

The aperture opening (diaphragm) changes only at the moment when the picture is taken. Otherwise, the aperture remains fully open. Therefore, when you look at the scene through the viewfinder or on the LCD monitor, the depth of field will look narrow.

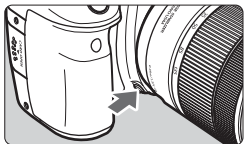

Press the depth-of-field preview button to stop down the lens to the current aperture setting, and check the depth of field (range of acceptable focus).



- A higher f/number will make more of the foreground and background fall within acceptable focus. However, the viewfinder will look darker.
- The depth-of-field effect can be clearly seen on the Live View image as you change the aperture and press the depth-of-field preview button (p.174).
- The exposure will be locked (AE lock) while the depth-of-field preview button is being pressed.

M: Manual Exposure

In this mode, you set both the shutter speed and aperture as desired. To determine the exposure, refer to the exposure level indicator in the viewfinder or use a commercially-available exposure meter. This method is called manual exposure.

* <M> stands for Manual.



1 Set the Mode Dial to <M>.

2 Set the ISO speed (p.135).

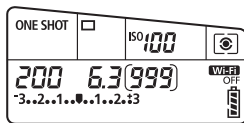

3 Set the shutter speed and aperture.

- To set the shutter speed, turn the <☀> dial.
- To set the aperture, turn the <⊙> dial.
- If it cannot be set, set the <LOCK> switch downward, then turn the <☀> or <⊙> dial.



Exposure level mark

4 Focus on the subject.

- Press the shutter button halfway.
- ▶ The exposure setting will be displayed in the viewfinder and on the LCD panel.
- Check the exposure level mark <|> to see how far the current exposure level is from the standard exposure level.

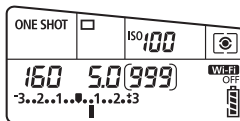

5 Set the exposure and take the picture.

- Check the exposure level indicator and set the desired shutter speed and aperture.
- If the exposure level exceeds ± 3 stops from the standard exposure, the end of the exposure level indicator will display <◀> or <▶>.

Exposure Compensation with ISO Auto

If the ISO speed is set to **A** (AUTO) for manual exposure shooting, you can set exposure compensation (p.166) as follows:

- [2: Expo.comp./AEB]
- Under [C.Fn III-4: Custom Controls] with [**SET**: Expo comp (hold btn, turn)].
- Quick Control (p.50)





- If ISO Auto is set, the ISO speed setting will change to suit the shutter speed and aperture in order to obtain a standard exposure. Therefore, you may not obtain the desired exposure effect. In such a case, set the exposure compensation.
- If flash is used when ISO Auto is set, exposure compensation will not be applied even if an exposure compensation amount is set.



- Under [2: Auto Lighting Optimizer], if the checkmark [] for [**Disabled in M or B modes**] is removed, Auto Lighting Optimizer can be set even in the <M> mode (p.142).
- When ISO Auto is set, you can press the <✳> button to lock the ISO speed.
- If you press the <✳> button and recompose the shot, you can see the exposure level difference on the exposure level indicator compared with when the <✳> button was pressed.
- If exposure compensation (p.166) was applied in <P>, <Tv>, or <Av> mode, and then the shooting mode is switched to <M> with ISO Auto set, the exposure compensation amount already set will still be maintained.
- With ISO Auto set and [C.Fn I-1: Exposure level increments] set to [**1: 1/2-stop**], 1/2-stop exposure compensation will be applied with the ISO speed (1/3 stop) and shutter speed. However, the shutter speed displayed will not change.



Selecting the Metering Mode ☆

You can select one of four methods to measure the subject brightness. In Basic Zone modes, evaluative metering is set automatically. (In the <SCN: > and <C: > modes, center-weighted average metering is set.)



1 Press the <> button (⓪6).

2 Select the metering mode.

- While looking at the LCD panel, turn the <> or <> dial.

: Evaluative metering

: Partial metering

: Spot metering

: Center-weighted average metering

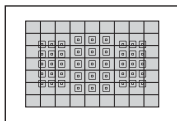
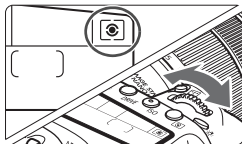

Evaluative metering

General-purpose metering mode suited even for backlit subjects. The camera adjusts the exposure automatically to suit the scene.

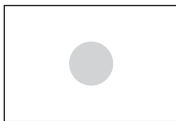

Partial metering

Effective where there are much brighter lights around the subject due to backlight, etc. Partial metering covers approx. 6.0% of the viewfinder area at the center.



Spot metering





Effective when metering a specific part of the subject or scene. Spot metering covers approx. 3.8% of the viewfinder area at the center.



 **Center-weighted average metering**

The metering is averaged for the entire scene with the viewfinder center weighted more heavily.



With  (Evaluative metering), the exposure setting will be locked when you press the shutter button halfway and focus is achieved. In the  (Partial metering),  (Spot metering), and  (Center-weighted average metering) modes, the exposure is set at the moment the picture is taken. (Pressing the shutter button halfway does not lock the exposure.)

☑ Setting Exposure Compensation ☆

Exposure compensation can brighten (increased exposure) or darken (decreased exposure) the standard exposure set by the camera.

Exposure compensation can be set in the <P>, <Tv>, and <Av> shooting modes. Although you can set the exposure compensation up to ± 5 stops* in 1/3-stop increments, the exposure compensation indicator in the viewfinder and on the LCD panel can only display the setting up to ± 3 stops. If you want to set the exposure compensation setting beyond ± 3 stops, use the Quick Control (p.50) or follow the instructions for [☑2: Expo.comp./AEB] on the next page. If the <M> mode and the ISO Auto are both set, see page 163 to set the exposure compensation.

* During Live View shooting, exposure compensation can be set up to ± 3 stops.

1 Check the exposure.

- Press the shutter button halfway (☺) and check the exposure level indicator.

Increased exposure
for a brighter image



2 Set the exposure compensation amount.

- While looking in the viewfinder or at the LCD panel, turn the <☺> dial.
- If it cannot be set, set the <LOCK> switch downward, then turn the <☺> dial.
- ▶ If you set exposure compensation, <☑> will be displayed in the viewfinder and on the LCD panel.

Decreased exposure
for a darker image



3 Take the picture.

- To cancel the exposure compensation, set the exposure compensation amount back to <☺>.

⚠ If [☑2: Auto Lighting Optimizer] (p.142) is set to any setting other than [Disable], the image may still look bright even if a decreased exposure compensation for a darker image is set.

- The exposure compensation amount will remain in effect even after you set the power switch to <OFF>.
- After setting the exposure compensation amount, you can prevent the exposure compensation amount from changing accidentally by setting the <LOCK> switch upward.
- If the exposure compensation amount exceeds ± 3 stops, the end of the exposure level indicator will display <◀> or <▶>.

Auto Exposure Bracketing (AEB) ☆

By changing the shutter speed or aperture automatically, the camera brackets the exposure up to ± 3 stops in $1/3$ -stop increments for three successive shots. This is called AEB.

* AEB stands for Auto Exposure Bracketing.

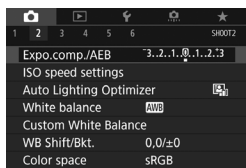

1 Select [Expo.comp./AEB].

- Under the [CAMERA] tab, select [Expo.comp./AEB], then press <SET>.

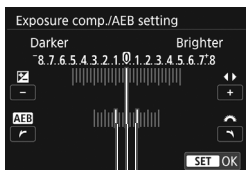

2 Set the AEB range.

- Turn the <DIAL> dial to set the AEB range. Press the <◀> <▶> keys to set the exposure compensation amount.
- Press <SET> to set it.
- ▶ When you exit the menu, the AEB range will be displayed on the LCD panel.

AEB range

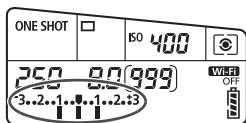

3 Take the picture.

- Three bracketed shots will be taken according to the drive mode set in this sequence: Standard exposure, decreased exposure, and increased exposure.
- AEB will not be automatically canceled. To cancel AEB, follow step 2 to turn off the AEB range display.



- During AEB, <★> in the viewfinder and AEB range will blink.
- If the drive mode is set to <□> or <□S>, press the shutter button three times for each shot. When <□H>, <□>, or <□S> is set and you hold down the shutter button completely, the three bracketed shots will be taken continuously and the camera will automatically stop shooting. When <☺> or <☺2> is set, the three bracketed shots will be taken continuously after a 10-sec. or 2-sec. delay.
- You can set AEB in combination with exposure compensation.
- If the AEB range exceeds ±3 stops, the end of the exposure level indicator will display <◀> or <▶>.
- AEB cannot be used with flash, bulb exposures, or when [Multi Shot Noise Reduction], [HDR Mode], or a Creative filter is set.
- AEB will be canceled automatically when you set the power switch to <OFF> or when the flash is ready to fire.

* AE Lock ☆

You can lock the exposure when the area of focus is to be different from the exposure metering area or when you want to take multiple shots at the same exposure setting. Press the < * > button to lock the exposure, then recompose and take the picture. This is called AE lock. It is effective for shooting backlit subjects, etc.

1 Focus on the subject.

- Press the shutter button halfway.
- ▶ The exposure setting will be displayed.

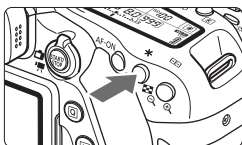

2 Press the < * > button (ⓘ4).



- ▶ The < * > icon lights up in the viewfinder to indicate that the exposure setting is locked (AE lock).
- Each time you press the < * > button, the current exposure setting is locked.



3 Recompose and take the picture.

- If you want to take more pictures while maintaining the AE lock, keep holding down the < * > button and press the shutter button to take another picture.

AE Lock Effects

| Metering Mode (p.164) | AF Point Selection (p.114-116) | |
|---|---|--|
| | Automatic Selection | Manual Selection |
|  | AE lock is applied at the AF point that achieved focus. | AE lock is applied at the selected AF point. |
|  | AE lock is applied to the center AF point. | |

* When the lens's focus mode switch is set to <MF>, AE lock is applied to the center AF point.



AE lock is not possible with bulb exposures.

⚡ Using the Built-in Flash

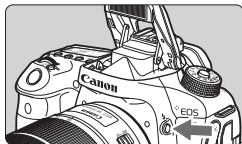

In Creative Zone modes, just press the <⚡> button to raise the built-in flash for flash photography.

Before shooting, check that [⚡] is displayed in the viewfinder. After shooting, push the built-in flash back down with your fingers until it clicks into place.

In Basic Zone modes, depending on the shooting mode, you can set the built-in flash with Quick Control (p.101).

The table below shows the shutter speed and aperture settings that will be used with flash.

| Shooting Mode | Shutter Speed | Aperture |
|---------------|---|-------------------|
| P | Automatically set (1/250 sec. - 1/60 sec.) | Automatically set |
| Tv | Manually set (1/250 sec. - 30 sec.) | Automatically set |
| Av | Automatically set (1/250 sec. - 30 sec.) | Manually set |
| M | Manually set (1/250 sec. - 30 sec.) | Manually set |
| B | Exposure continues while you hold down the shutter button or while the bulb timer is operating. | Manually set |



Flash Photography in the <Av> Mode

To obtain a correct flash exposure, the flash output will be set automatically (autoflash exposure) to match the manually-set aperture. The shutter speed will be set automatically between 1/250 sec. - 30 sec. to suit the scene's brightness.

In low light, the main subject is exposed with the auto flash metering, and the background is exposed with a slow shutter speed set automatically. Both the subject and background look properly exposed with a touch of atmosphere (automatic slow-speed flash sync). If you are handholding the camera, keep it steady to prevent camera shake. Using a tripod is recommended.

To prevent a slow shutter speed, under [📷1: Flash control], set [Flash sync. speed in Av mode] to [1/250-1/60sec. auto] or [1/250 sec. (fixed)].

Effective Range of Built-in Flash (Approx. in meters / feet)

| ISO Speed (p.135) | EF-S18-135mm f/3.5-5.6 IS USM | |
|----------------------|-------------------------------|-------------------------|
| | Wide Angle | Telephoto |
| | f/3.5 | f/5.6 |
| ISO 100 | 1 - 3.4 / 3.3 - 11.2 | 1 - 2.1 / 3.3 - 6.9 |
| ISO 400 | 1 - 6.9 / 3.3 - 22.6 | 1 - 4.3 / 3.3 - 14.1 |
| ISO 1600 | 1.7 - 13.7 / 5.6 - 44.9 | 1.1 - 8.6 / 3.6 - 28.2 |
| ISO 6400 | 3.4 - 27.4 / 11.2 - 89.9 | 2.1 - 17.1 / 6.9 - 56.1 |

* When a high ISO speed is set and focusing distance is long, appropriate exposure may not be obtained depending on the subject conditions, etc.



- Flash cannot be used with movie shooting. It will not fire.
- AEB cannot be used with flash.
- Detach any lens hood when shooting with the built-in flash.
- If a lens hood is attached or if the subject is too close, the built-in flash will be obstructed and the bottom of the captured image may look dark.
- Do not perform flash photography when the built-in flash is held down with your finger or not fully raised for some other reason.



If you use a super telephoto lens or large-aperture lens and the bottom of the picture looks dark, using an external Speedlite (sold separately) is recommended.



6

Shooting with the LCD Monitor (Live View Shooting)

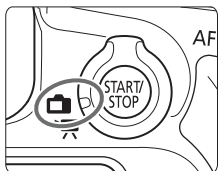

You can shoot while viewing the image on the camera's LCD monitor. This is called "Live View shooting".

Live View shooting is enabled by setting the Live View shooting/ Movie shooting switch to .

- If you handhold the camera and shoot while viewing the LCD monitor, camera shake may cause blurred images. Using a tripod is recommended.



Remote Live View Shooting

With EOS Utility (EOS software, p.232) installed on your computer, you can connect the camera to the computer and shoot remotely while viewing the computer screen. For details, refer to the EOS Utility Instruction Manual.

Shooting with the LCD Monitor

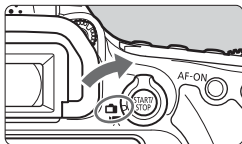

- 1** Set the Live View shooting/Movie shooting switch to .

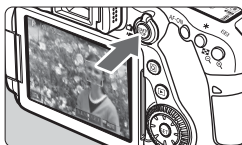

- 2** Display the Live View image.

- Press the  button.
- ▶ The Live View image will appear on the LCD monitor.
- The Live View image will be displayed in the brightness level closely matching that of the actual image to be captured.



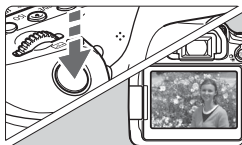

- 3** Focus on the subject.

- When you press the shutter button halfway, the camera will focus with the current AF method (p.180).
- You can also tap on the screen to select the face or subject (p.190).



- 4** Take the picture.

- Press the shutter button completely.
- ▶ The picture is taken and the captured image is displayed on the LCD monitor.
- ▶ When the playback display ends, the camera will return to Live View shooting automatically.
- Press the  button to exit the Live View shooting.

-  ● The image's field of view is approx. 100% (with the image-recording quality set to JPEG ).
- In Creative Zone modes, you can check the depth of field by pressing the depth-of-field preview button.
- You can also use a remote controller (sold separately) for Live View shooting.

Enabling Live View Shooting

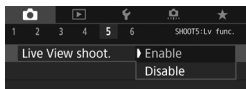

Set [**5**: Live View shoot.] (the [**5**] tab in Basic Zone modes) to [**Enable**].

Number of Possible Shots with Live View Shooting (Approx. number of shots)

| Temperature | Room Temperature (23°C / 73°F) | Low Temperatures (0°C / 32°F) |
|---------------|-----------------------------------|----------------------------------|
| No Flash | 340 | 310 |
| 50% Flash Use | 300 | 270 |

- The figures above are based on a fully-charged Battery Pack LP-E6N and CIPA (Camera & Imaging Products Association) testing standards.
- With a fully-charged Battery Pack LP-E6N, continuous Live View shooting is possible for approx. 2 hr. 30 min. at room temperature (23°C / 73°F).



- In the <SCN: > mode, Live View shooting is not possible.
- In the <SCN: > modes and < > modes, the shooting range will be smaller.
- When the flash is recycling, “BUSY” is displayed on the LCD monitor, and you cannot view the subject. Also, the continuous shooting speed will decrease.
- Do not point the camera toward an intense light source, such as the sun or an intense artificial light source. Doing so may damage the image sensor or the camera’s internal components.
- **General Live View Shooting Cautions are on pages 194-195.**







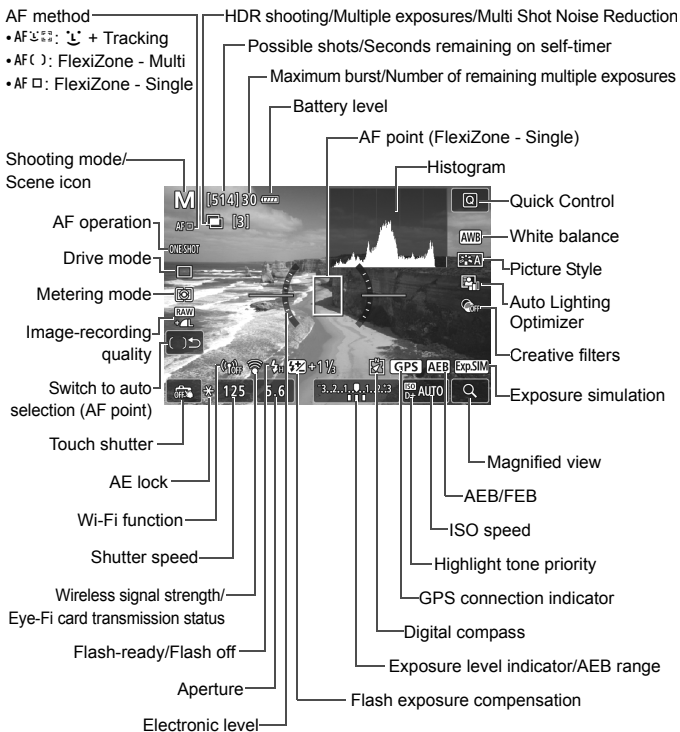

- You can also focus by pressing the <AF-ON> button.
- When flash is used, there will be two shutter sounds, but only one shot will be taken. Also, the time it takes to capture an image after you press the shutter button completely will be slightly longer than with viewfinder shooting.
- If the camera is not operated for a prolonged period, the power will turn off automatically after the time set in [**2**: Auto power off] (p.60). If [**2**: Auto power off] is set to [**Disable**], Live View shooting will end automatically after approx. 30 min. (camera power remains on).
- With the HDMI cable HTC-100, you can display the Live View image on a TV set. Note that no sound will be output. If the picture does not appear on the TV screen, check if the [**3**: Video system] is correctly set to [**For NTSC**] or [**For PAL**] (depending on the video system of your TV set).

Information Display

- Each time you press the <INFO.> button, the information display will change.





- The histogram can be displayed by pressing the <INFO.> button when [**📷 5: Expo. simulation: Enable**] is set. However, the histogram is not displayed while pressing the shutter button completely.
- You can display the electronic level by pressing the <INFO.> button (p.66). Note that if the AF method is set to [**Ⓛ +Tracking**] or the camera is connected to a TV set with an HDMI cable, the electronic level cannot be displayed.
- When <Exp.SIM> is displayed in white, it indicates that the Live View image is displayed at the brightness level closely matching that of the actual image captured.
- If <Exp.SIM> is blinking, it indicates that the Live View image is displayed at a brightness that differs from the actual shooting result because of low-or bright-light conditions. However, the actual image recorded will reflect the exposure setting. Note that noise may be more noticeable than the actual image recorded.
- When the <SCN:  Expo. simulation: Enable] in Creative Zone modes is set and Multi Shot Noise Reduction, HDR mode, bulb exposure, or flash is used, exposure simulation will not be performed. <Exp.SIM> icon and histogram will be displayed in gray. The image will be displayed on the LCD monitor at the standard brightness. The histogram may not be properly displayed in low- or bright-light conditions.
- Exposure simulation is not performed in <📷:    



Do not hold the camera in the same position for long periods of time.

Even if the camera does not feel too hot, prolonged contact with the same body part may cause skin redness or blistering due to low-temperature contact burns. Using a tripod is recommended for people with circulation problems or very sensitive skin, or when using the camera in very hot places.

Selecting the AF Operation [☆]

You can select the AF operation characteristics to suit the shooting conditions or subject. In Basic Zone modes, the optimum AF operation is set automatically for the respective shooting mode.

1 Press the <AF> button.



2 Select the AF operation.

- Press the <◀> <▶> keys to select the desired AF operation, then press <SET>.

ONE SHOT: One-Shot AF

SERVO: Servo AF

 If focus cannot be achieved, the AF point will turn orange. If this occurs, the picture cannot be taken even if the shutter button is pressed completely. Recompose the shot and try to focus again. Or see “Shooting Conditions that Make Focusing Difficult” (p.188).

One-Shot AF for Still Subjects

Suited for still subjects. When you press the shutter button halfway, the camera will focus only once.

- When focus is achieved, the AF point will turn green and the beeper will sound.
- While you hold down the shutter button halfway, the focus will be locked. You can then recompose the shot if desired.

 If [📷 1: Beep] is set to [Disable], the beeper will not sound when focus is achieved.

Servo AF for Moving Subjects

This AF operation is suited for moving subjects. While you hold down the shutter button halfway, the camera will keep focusing on the subject continuously.

- If the drive mode is set to high-speed continuous shooting, the maximum speed will be approx. 5.0 fps. The pictures will be taken with priority given to the continuous shooting speed.
- If the drive mode is set to low-speed continuous shooting, the maximum speed will be approx. 3.0 fps. The pictures will be taken with priority given to subject tracking.
- For flash photography, the continuous shooting speed will become slower.
- When focus is achieved, the AF point will turn blue. The beeper will not sound in this case.
- The exposure is set at the moment the picture is taken.
- Depending on the lens used, the distance to the subject, and the subject's speed, the camera may not be able to achieve correct focus.
- If you operate the zoom during continuous shooting, the focus may be lost. Shoot after using the zoom to obtain the desired composition.



- With [**Servo AF**], the image quality can be set to **RAW** or JPEG. If **M RAW** or **S RAW** is set, the image will be recorded in **RAW** quality.
- When [**Servo AF**] is set and Multi Shot Noise Reduction is set, [**High ISO speed NR**] will automatically switch to [**Standard**].

Focusing with AF (AF Method)

Selecting the AF Method

You can select an AF method to suit the shooting conditions and your subject. The following AF methods are provided: [**AF**] (**face**)+Tracking] (p.181), [**FlexiZone - Multi**] (p.183), and [**FlexiZone - Single**] (p.185). If you want to achieve precise focus, set the lens's focus mode switch to <MF>, magnify the image, and focus manually (p.192).



1 Press the <AF> button.

2 Select the AF method.

- Turn the <[Gears]> dial to select the AF method, then press <[SET]>.

- You can also set the AF method with [**5: AF method**] (the [**3**] tab in Basic Zone modes).
- The procedures on pages 181-186 assume that One-Shot AF is set. If Servo AF is set, the AF point will turn blue when focus is achieved. The beeper will not sound in this case (p.178).
- In the <SCN: []> modes, Servo AF is set automatically and when focus is achieved, the AF point will turn blue and the beeper will sound.

☺ (face)+Tracking: AF

The camera detects and focuses on human faces. If a face moves, the AF point <☺> also moves to track the face.

1 Display the Live View image.

- Press the <START/STOP> button.
- ▶ The Live View image will appear on the LCD monitor.



Area frame

2 Check the AF point.

- When a face is detected, the area frame and the <☺> frame will appear on the face for focusing.
- If multiple faces are detected, <☺> will be displayed. Use the <☺> to move the <☺> frame over the face you want to focus on.
- You can also tap on the LCD monitor screen to select the face or subject. If the subject is not a face, <☺> will be displayed.

3 Focus on the subject.

- Press the shutter button halfway to focus.
- ▶ If no faces can be detected or if you do not tap on the LCD monitor, the camera will switch to FlexiZone - Multi with automatic selection (p.183).
- ▶ When focus is achieved, the AF point will turn green and the beeper will sound.
- ▶ If focus is not achieved, the AF point will turn orange.

**4 Take the picture.**

- Check the focus and exposure, then press the shutter button completely to take the picture (p.174).



● **Focusing on a subject other than a human face**

Press <SET> or <AF-ON> and the AF frame <AF-ON> will appear at the screen's center. Then use <AF-ON> to move the AF frame over the desired subject. Once the AF frame <AF-ON> achieves focus, it will track the subject even if the subject moves or if you change the composition.

- ⓘ
- If the subject's face is significantly out of focus, face detection will not be possible. Adjust the focus manually (p.192) so that the face can be detected, then perform AF.
 - An object other than a human face may be detected as a face.
 - Face detection will not work if the face is very small or large in the picture, too bright or too dark, or partially hidden.
 - The <AF-ON> may cover only a part of the face.

- 📄
- Use the area frame as a guide, and focus within the area frame.
 - The size of the AF frame changes depending on the subject.

FlexiZone - Multi: AF ()

You can use up to 35 AF points for wide-area focusing (automatic selection). This wide area can also be divided into 9 zones for focusing (zone selection).



Area frame

1 Display the Live View image.

- Press the $\langle \text{START/STOP} \rangle$ button.
- ▶ The Live View image will appear on the LCD monitor.



2 Select the AF point. ☆

- Pressing $\langle \text{SET} \rangle$ or the $\langle \text{trash} \rangle$ button will toggle between automatic selection and zone selection. In Basic Zone modes, automatic selection is set automatically.
- Use $\langle \text{zone} \rangle$ to select the zone. To return to the center zone, press $\langle \text{SET} \rangle$ or the $\langle \text{trash} \rangle$ button again.
- You can also tap on the LCD monitor screen to select a zone. When a zone is selected, tap $[\text{zone}] \rightarrow$ on the screen to switch to automatic selection.

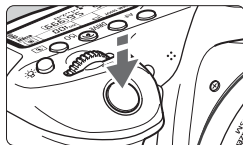

3 Focus on the subject.

- Aim the AF point over the subject and press the shutter button halfway.
- ▶ When focus is achieved, the AF point will turn green and the beeper will sound.
- ▶ If focus is not achieved, the area frame will turn orange.



4 Take the picture.

- Check the focus and exposure, then press the shutter button completely to take the picture (p.174).

- If the camera does not focus on the desired target subject with automatic AF point selection, select a zone or switch the AF method to **[FlexiZone - Single]** and refocus.
- The number of AF points varies, depending on the **[4: Aspect ratio]** setting. At **[3:2]**, there are 35 AF points. At **[4:3]** and **[1:1]**, there are 25 AF points. And at **[16:9]**, 21 AF points. Also, at **[16:9]**, there are three zones.
- For movie shooting, there are 21 AF points and three zones.



FlexiZone - Single: AF □

The camera focuses with a single AF point. This is effective when you want to focus on a particular subject.





AF point

1 Display the Live View image.

- Press the <  > button.
- ▶ The Live View image will appear on the LCD monitor.
- ▶ The AF point <  > will appear.
- During movie shooting, if [Movie Servo AF] is set to [Enable], the AF point will be displayed in a larger size.



2 Move the AF point.

- Use <  > to move the AF point to where you want to focus. (It cannot be moved to the edge of the screen.)
- Pressing <  > or the <  > button will return the AF point to the screen's center.
- You can also tap on the LCD monitor screen to move the AF point.

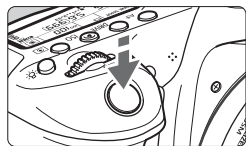

3 Focus on the subject.

- Aim the AF point over the subject and press the shutter button halfway.
- ▶ When focus is achieved, the AF point will turn green and the beeper will sound.
- ▶ If focus is not achieved, the AF point will turn orange.



4 Take the picture.

- Check the focus and exposure, then press the shutter button completely to take the picture (p.174).

Notes for AF

AF Operation

- Even when focus is achieved, pressing the shutter button halfway will focus again.
- The image brightness may change during and after the AF operation.
- Depending on the subject or shooting conditions, etc., focusing may take longer or the continuous shooting speed may become slower.
- If the light source changes while the Live View image is displayed, the screen may flicker and focusing may be difficult. If this happens, exit Live View shooting and perform AF under the actual light source under which you are shooting.

Magnified View

- If [**L**+Tracking] is set, magnified view is not possible.
- When [**FlexiZone - Multi**] is set and you press the <Q> button (or tap <Q> on the screen), the center of the selected zone (or image center with automatic selection) will be magnified. If you press the shutter button halfway, the display will return to normal and the camera will focus.
- When [**FlexiZone - Single**] is set and you press the <Q> button (or tap <Q> on the screen), the area covered by the AF point will be magnified. Press the shutter button halfway to focus in the magnified view. This is effective when the camera is attached to a tripod and you need to attain very precise focus. If focusing is difficult in magnified view, return to the normal display and use AF. Note that the AF speed differs between the normal and magnified views.
- If you magnify the view after focusing with [**FlexiZone - Multi**] or [**FlexiZone - Single**] in the normal view, precise focus may not be achieved.
- In Servo AF mode, when you press the shutter button halfway in the magnified view, the display will return to normal and the camera will focus.

Shooting Conditions that Make Focusing Difficult

- Low-contrast subjects such as the blue sky, solid-color flat surfaces or when highlight or shadow details are lost.
- Subjects in low light.
- Stripes and other patterns where there is contrast only in the horizontal direction.
- Subjects with repetitive patterns (Example: Skyscraper windows, computer keyboards, etc.).
- Fine lines and subject outlines.
- Under a light source whose brightness, color, or pattern keeps changing.
- Night scenes or points of light.
- The image flickers under fluorescent or LED lighting.
- Extremely small subjects.
- Subjects at the edge of the picture.
- Strongly backlit or reflective subjects (Example: Cars with highly reflective bodies, etc.).
- The AF point covers both near and distant subjects (Example: Animal in a cage, etc.).
- Subjects that keep moving within the AF point and cannot keep still due to camera shake or subject blur.
- Performing AF when the subject is very far out of focus.
- Soft focus effect is applied with a soft focus lens.
- A special effect filter is used.
- Noise (dots of light, banding, etc.) appears on the screen during AF.



- If focus is not achieved with the shooting conditions listed on the preceding page, set the lens's focus mode switch to **<MF>** and focus manually.
- Depending on the lens used, focusing may take longer or correct focus may not be achieved. For details, refer to the Canon website.



- If you shoot a peripheral subject and it is slightly out of focus, aim the center AF point or zone over the subject to focus, focus again and then take the picture.
- The AF-assist beam will not be emitted. However, if an EX-series Speedlite (sold separately) equipped with an LED light is used, the LED light will turn on for AF-assist when necessary.
- In magnified view, achieving focus becomes more difficult due to camera shake. Using a tripod is recommended.

Shooting with the Touch Shutter

Just by tapping on the LCD monitor screen, you can focus and take the picture automatically. This works in all shooting modes.

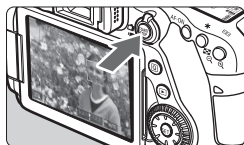



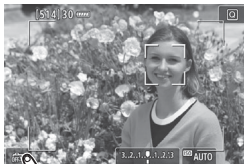

1 Display the Live View image.

- Press the <START/STOP> button.
- ▶ The Live View image will appear on the LCD monitor.



2 Enable the touch shutter.





- Tap [>] on the screen's bottom left. Each time you tap on the icon, it will toggle between [>] and [>].
- [>] (Touch shutter: Enable)
You can tap on the spot to focus and shoot.
- [>] (Touch shutter: Disable)
You can tap on a spot to perform focusing on where you want to focus. Press the shutter button completely to take the picture.





3 Tap on the screen to shoot.

- Tap on the face or subject on the screen.
- ▶ On the point you tap, the camera will focus with the AF method that was set (p.180-186).
- ▶ When focus is achieved, the AF point turns green and the picture is taken automatically.
- If focus is not achieved, the AF point turns orange and the picture cannot be taken. Tap on the face or subject on the screen again.



- Even if you set the drive mode to or , the camera will still shoot in single shooting mode.
- When you tap on the screen, focusing will be performed with One-Shot AF regardless of the [: **Touch Shutter**] or [**AF operation**] settings.
- The touch shutter does not work with the magnified view.
- If the Fish-eye effect Creative filter is set, the camera will focus using the AF point at the center of the screen regardless of the point you tap on.
- If the Miniature effect Creative filter is set, the touch shutter does not work.
- If [**FlexiZone - Multi**] and [ **Touch shutter: Disable**] are set with a Basic Zone mode, focusing cannot be performed by tapping on the screen.
- When [ **Shutter butt. half-press**] is set to [**Metering start**] or [**AE lock (while button pressed)**] under [ **C.Fn III-4: Custom Controls**], autofocusing does not take effect.



- You can also set the touch shutter with [ **5: Touch Shutter**] (the [ **3**] tab in Basic Zone modes).
- To shoot with bulb exposure, tap on the screen twice. The first tap on the screen will start the bulb exposure. Tapping it again will stop the exposure. Be careful not to shake the camera when tapping on the screen.

MF: Focusing Manually

You can magnify the image and focus precisely with manual focus.

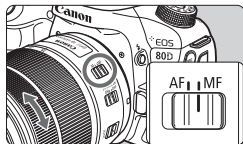

1 Set the lens's focus mode switch to <MF>.

- Turn the lens focusing ring to focus roughly.

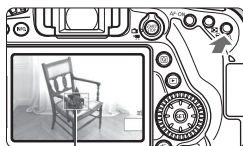

Magnifying frame

2 Display the magnifying frame.

- Press the <Q> button.
- ▶ The magnifying frame will appear.
- You can also tap [Q] on the screen to magnify the image.

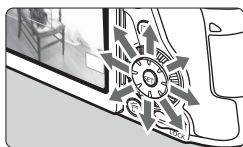

3 Move the magnifying frame.

- Use <⬤> to move the magnifying frame to the position where you want to focus. You can also tap it to move it.
- Pressing <SET> or <⏏> button will return the magnifying frame to the screen's center.



AE lock
Magnified area position
Magnification (Approx.)

4 Magnify the image.

- Each time you press the <Q> button, the magnification of the image will change in the following sequence:

→ Normal view → 1x → 5x → 10x →

- While in magnified view, you can use <⬤> or tap the directional wedges displayed on the top, bottom, left, and right of the screen to scroll around the magnified image.

5 Focus manually.

- While looking at the magnified image, turn the lens focusing ring to focus.
- After achieving focus, press the <Q> button to return to the normal view.

6 Take the picture.

- Check the exposure, then press the shutter button completely to take the picture (p.174).









In magnified view, the exposure is locked. (Shutter speed and aperture will be displayed in red.)

General Live View Shooting Cautions

Image Quality

- When you shoot at high ISO speeds, noise (such as dots of light and banding) may become noticeable.
- Shooting in high temperatures may cause noise and irregular colors in the image.
- If Live View shooting is used continuously for a prolonged period, the camera's internal temperature may rise, and image quality may deteriorate. Always exit Live View shooting when you are not shooting.
- If you shoot a long exposure while the camera's internal temperature is high, image quality may deteriorate. Exit Live View shooting and wait a few minutes before shooting again.

White and Red Internal Temperature Warning Icons

- If the camera's internal temperature increases due to prolonged Live View shooting or under a high ambient temperature, a white  or red  icon will appear.
- The white  icon indicates that the image quality of still photos will deteriorate. It is recommended that you temporarily exit Live View shooting and allow the camera to cool down before shooting again.
- The red  icon indicates that the Live View shooting will soon stop automatically. If this happens, you will not be able to shoot again until the camera's internal temperature decreases. Exit the Live View shooting or turn off the power and let the camera rest for a while.
- Using Live View shooting at a high temperature for a prolonged period will cause the  or  icon to appear earlier. When you are not shooting, always turn off the camera.
- If the camera's internal temperature is high, the quality of images shot with high ISO speed or long exposure may deteriorate even before the white  icon is displayed.

Shooting Results

- In magnified view, the shutter speed and aperture will be displayed in red. If you take the picture in magnified view, the exposure may not come out as desired. Return to the normal view before taking the picture.
- Even if you take the picture in magnified view, the image area for the normal view will be captured.



General Live View Shooting Cautions

Live View Image

- Under low- or bright-light conditions, the Live View image may not reflect the brightness of the captured image.
- Even if a low ISO speed is set, noise may be noticeable in the displayed Live View image under low light. However, when you shoot, the image recorded will have less noise. (The image quality of the Live View image is different from that of the recorded image.)
- If the light source (illumination) within the image changes, the screen may flicker. If this happens, exit Live View shooting and resume Live View shooting under the actual light source.
- If you point the camera in a different direction, it may throw off the Live View image's correct brightness momentarily. Wait until the brightness level stabilizes before shooting.
- If there is a very bright light source in the image, the bright area may appear black on the LCD monitor. However, the actual captured image will correctly show the bright area.
- In low light, if you set the [**F2: LCD brightness**] to a bright setting, noise or irregular colors may appear in the Live View image. However, the noise or irregular colors will not be recorded in the captured image.
- When you magnify the image, the image sharpness may look more pronounced than in the actual image.

Custom Functions

- During Live View shooting, certain Custom Function settings will not take effect.

Lens and Flash

- If the attached lens has an Image Stabilizer and you set the Image Stabilizer (IS) switch to <ON>, the Image Stabilizer will operate at all times even if you do not press the shutter button halfway. The Image Stabilizer consumes battery power and may decrease the number of possible shots depending on the shooting conditions. When the Image Stabilizer is not necessary, such as when using a tripod, it is recommended to set the IS switch to <OFF>.
- The focus preset function is possible for Live View shooting only when using a (super) telephoto lens equipped with the focus preset mode released in and after the second half of 2011.
- FE lock will not work if the built-in flash is used. FE lock and modeling flash will not work if an external Speedlite is used.



7

Shooting Movies

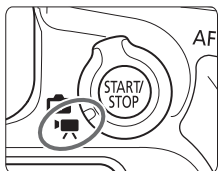

Movie shooting is enabled by setting the Live View shooting/Movie shooting switch to <  >.

- For cards that can record movies, see page 5.
- If you handhold the camera and shoot movies, camera shake can cause blurred movies. Using a tripod is recommended in such cases.



Full HD 1080

Full HD 1080 indicates compatibility with High-Definition featuring 1080 vertical pixels (scanning lines).



Shooting Movies

Autoexposure Shooting

Autoexposure control will take effect to suit the scene's current brightness.

- 1 **Set the Mode Dial to a mode other than $\langle \text{M} \rangle$ and $\langle \text{M} \rangle$.**

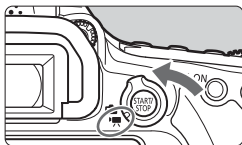

- 2 **Set the Live View shooting/Movie shooting switch to $\langle \text{Movie} \rangle$.**

- ▶ The reflex mirror will make a sound, then the image will appear on the LCD monitor.

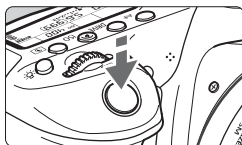

- 3 **Focus on the subject.**

- Before shooting a movie, focus with AF or manual focus (p.180-189, 192).
- When you press the shutter button halfway, the camera will focus with the current AF method.



- 4 **Shoot the movie.**

- Press the $\langle \text{START/STOP} \rangle$ button to start shooting a movie.
- ▶ While the movie is being shot, the [●] mark will be displayed on the upper right of the screen.
- ▶ Sound will be recorded by the built-in microphones.
- To stop shooting the movie, press the $\langle \text{START/STOP} \rangle$ button again.

Recording movie

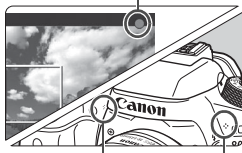

Microphones



- In Basic Zone modes, the shooting result will be the same as with **<A+>**. Also, the scene icon for the scene detected by the camera is displayed on the upper left.
- In the **<Tv>**, **<Av>**, and **** shooting modes, the settings will be the same as when shooting in the **<P>** mode.
- Settable menu functions differ between Basic Zone modes and Creative Zone modes.
- In Creative Zone modes, you can press the **<*>** button (p.169) to lock the exposure (AE lock). After applying AE lock during movie shooting, you can cancel it by pressing the **<E>** button. (AE lock setting is retained until you press the **<E>** button.)
- In Creative Zone modes, you can set the **<LOCK>** switch downward and turn the **<DIAL>** dial to set the exposure compensation.
- If you shoot a movie with autoexposure, the ISO speed, shutter speed, and aperture will not be recorded in the movie's Exif information.
- With autoexposure (modes other than **M**) movie shooting, the camera will automatically turn on the Speedlite's LED light under low-light conditions. For details, refer to the instruction manual of an EX-series Speedlite equipped with an LED light.

ISO Speed in Basic Zone Modes

- The ISO speed will be set automatically within ISO 100 - ISO 12800.

ISO Speed in the P, Tv, Av, and B Modes

- The ISO speed will be set automatically within ISO 100 - ISO 12800.
- In [Range for movies] under [**2: ISO speed settings**], if you set [Maximum] to [H(25600)], the automatic setting range will be expanded to H (equivalent to ISO 25600). Even if you set [Minimum] to ISO 200 or higher and [Maximum] to ISO 3200 or lower, the range will be set within ISO 100 - ISO 6400 automatically.
- If [**3: Highlight tone priority**] is set to [Enable] (p.147), the ISO speed will be ISO 200 - ISO 12800.
- Under [**2: ISO speed settings**], [Auto range] and [Min. shutter spd.] cannot be set for movie shooting.

- Since shooting a movie at ISO 16000 may result in much noise, it is designated as an expanded ISO speed (displayed as "H").
- When switching from still photo shooting to movie shooting, check the ISO speed settings before shooting movies.

Manual Exposure Shooting

You can manually set the shutter speed, aperture, and ISO speed for movie shooting. Using manual exposure to shoot movies is for advanced users.



1 Set the Mode Dial to <M>.

2 Set the Live View shooting/Movie shooting switch to <[Movie icon]>.

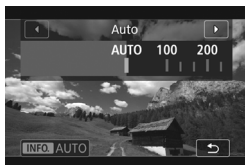

3 Set the ISO speed.

- Press the <ISO> button.
- ▶ The ISO speed setting screen will appear on the LCD monitor.
- Turn the <[ISO dial]> dial to set the ISO speed.
- For details on the ISO speed, see the next page.

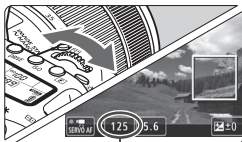

Shutter speed

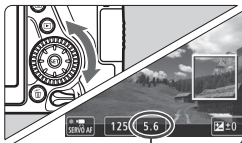

Aperture





4 Set the shutter speed and aperture.

- Press the shutter button halfway and check the exposure level indicator.
- To set the shutter speed, turn the <[Shutter speed dial]> dial. The settable shutter speeds vary depending on the frame rate.
 - **25.00P** **23.98P** : 1/4000 sec. - 1/25 sec.
 - **29.97P** : 1/4000 sec. - 1/30 sec.
 - **50.00P** : 1/4000 sec. - 1/50 sec.
 - **59.94P** : 1/4000 sec. - 1/60 sec.
- To set the aperture, turn the <[Aperture dial]> dial.
- If it cannot be set, set the <LOCK> switch downward, then turn the <[Aperture dial]> or <[Aperture dial]> dial.



5 Focus and shoot the movie.

- The procedure is the same as steps 3 and 4 for "Autoexposure Shooting" (p.198).

ISO Speed During Manual Exposure Shooting

- With **[Auto] (A)**, the ISO speed will be set automatically within ISO 100 - ISO 12800. In **[Range for movies]** under **[2: ISO speed settings]**, if you set **[Maximum]** to **[H(25600)]**, the automatic setting range will be expanded to H (equivalent to ISO 25600). Even if you set **[Minimum]** to ISO 200 or higher and **[Maximum]** to ISO 3200 or lower, the range will be set within ISO 100 - ISO 6400 automatically.
- You can set the ISO speed manually within ISO 100 - ISO 12800 in 1/3-stop increments. In **[Range for movies]** under **[2: ISO speed settings]**, if you set **[Maximum]** to **[H(25600)]**, the automatic setting range will be expanded to H (equivalent to ISO 25600).
- If **[3: Highlight tone priority]** is set to **[Enable]** (p.147), the ISO speed will be ISO 200 - ISO 12800.
- Under **[2: ISO speed settings]**, **[Auto range]** and **[Min. shutter spd.]** cannot be set for movie shooting.

- Since shooting a movie at ISO 16000 may result in much noise, it is designated as an expanded ISO speed (displayed as "H").
- When switching from still photo shooting to movie shooting, check the ISO speed settings before shooting movies.
- Changing the shutter speed or aperture during movie shooting is not recommended since the changes in the exposure will be recorded.
- When shooting a movie of a moving subject, a shutter speed within approx. 1/30 sec. to 1/125 sec. is recommended. The faster the shutter speed, the less smooth the subject's movement will look.
- If you change the shutter speed while shooting under fluorescent or LED lighting, image flicker may be recorded.

- Under **[C.FnIII-4: Custom Controls]**, if **[SET: Expo comp (hold btn, turn )]** is set, you can set exposure compensation while ISO Auto is set.
- When ISO Auto is set, you can press the **< * >** button to lock the ISO speed.
- If you press the **< * >** button and recompose the shot, you can see the exposure level difference on the exposure level indicator (p.203) compared to when the **< * >** button is pressed.
- By pressing the **< INFO.>** button, you can display the histogram.

Information Display

- Each time you press the <INFO.> button, the information display will change.

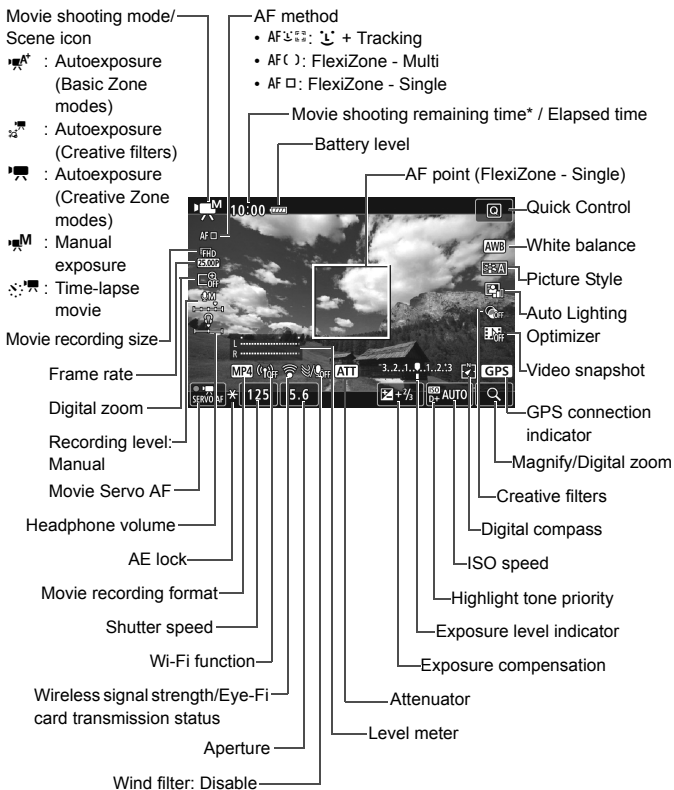

* Applies to a single movie clip.



- You can display the electronic level by pressing the **<INFO.>** button (p.66).
- Note that if the AF method is set to [**☺** **+Tracking**] or the camera is connected to a TV set with an HDMI cable, the electronic level cannot be displayed.
- The electronic level, grid lines, or histogram cannot be displayed during movie shooting. (The display will disappear when you start shooting a movie.)
- When movie shooting starts, the movie shooting remaining time will change to the elapsed time.

Still Photo Shooting

Still photo shooting is not possible during movie shooting. To shoot still photos, stop shooting the movie and perform viewfinder shooting or Live View shooting.

Cautions for Movie Shooting

- Do not point the camera toward an intense light source, such as the sun or an intense artificial light source. Doing so may damage the image sensor or the camera's internal components.
- When you press the shutter button halfway to autofocus during movie shooting, the following phenomena may occur.
 - Focus may become far off momentarily.
 - The brightness of the recorded movie may change.
 - The recorded movie may be momentarily still.
 - The movie may record the lens mechanical sound.
- If **<AWB>** or **<AWB w>** is set and the ISO speed or aperture changes during movie shooting, the white balance may also change.
- If you shoot a movie under fluorescent or LED lighting, the movie may flicker.
- Shooting a few test movies is recommended where you will perform zooming during movie shooting. Zooming during movie shooting may result in recording of changes in exposure or mechanical sound of the lens, or images may be out of focus.
- During movie shooting, you cannot magnify the image even if you press the **<Q>** button.
- Be careful not to cover the built-in microphones (p.198) with your finger, etc.
- If you connect or disconnect the HDMI cable during movie shooting, the movie shooting will end.
- **General Movie Shooting Cautions are on pages 212-213.**
- **If necessary, also read General Live View Shooting Cautions on pages 194-195.**

 **Do not hold the camera in the same position for long periods of time.** Even if the camera does not feel too hot, prolonged contact with the same body part may cause skin redness or blistering due to low-temperature contact burns. Using a tripod is recommended for people with circulation problems or very sensitive skin, or when using the camera in very hot places.



Notes for Movie Shooting

- Movie-related settings are under the [CAMERA 4] and [CAMERA 5] tabs. (In Basic Zone modes, they are under the [CAMERA 2] and [CAMERA 3] tabs.)
- A movie file is recorded each time you shoot a movie. If the file size exceeds 4 GB, a new file will be created for every subsequent 4 GB (p.210).
- The movie image's field of view is approx. 100% (with movie recording size set to [1920x1080]).
- You can also focus on the image by pressing the <AF-ON> button.
- Stereo sound is recorded by the camera's built-in microphones.
- Most external stereo microphones equipped with a 3.5 mm diameter mini plug can be used.
- With a fully-charged Battery Pack LP-E6N, the total movie shooting time will be as follows: approx. 1 hr. 50 min. at room temperature (23°C / 73°F) and approx. 1 hr. 40 min. at low temperatures (0°C / 32°F) (with [CAMERA 4: Movie Servo AF: Disable] set).
- The focus preset function is possible for movie shooting when using a (super) telephoto lens equipped with the focus preset mode, released in and after the second half of 2011.

MENU Setting the Movie Recording Size

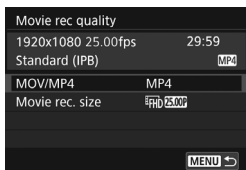

With [**4**: **Movie rec quality**] (the [**2**] tab in Basic Zone modes), you can set the movie recording format, movie recording size (image size, frame rate, and compression method), and other functions.

MOV/MP4

You can select the movie's recording format.

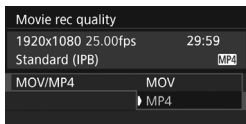

MOV MOV

The movie is recorded in the MOV format (file extension: “.MOV”).

Convenient for editing with a computer.

MP4 MP4

The movie is recorded in the MP4 format (file extension: “.MP4”). This format is compatible with a larger range of playback systems than the MOV format.

Movie Recording Size

You can select the movie's size, frame rate, and compression method.



- **Image Size**

- **FHD 1920x1080**

Full High-Definition (Full HD) recording quality. The aspect ratio is 16:9.

- **HD 1280x720**

High-Definition (HD) recording quality. The aspect ratio is 16:9.

- **Frame Rate** (fps: frames per second)

29.97P **29.97 fps** / **59.94P** **59.94 fps**

For areas where the TV system is NTSC (North America, Japan, South Korea, Mexico, etc.).

25.00P **25.00 fps** / **50.00P** **50.00 fps**

For areas where the TV system is PAL (Europe, Russia, China, Australia, etc.).

23.98P **23.98 fps**

Mainly for motion pictures.

 The frame rate displayed on the movie recording size screen switches depending on whether [**3: Video system**] is set to [**For NTSC**] or [**For PAL**]. **23.98P** (23.98 fps) can be selected only when [**For NTSC**] is set.

- **Compression Method**

Fixed at **[ALL-I]** if the recording format is MOV. For the MP4 format, **[IPB]** or **[IPB]**  can be selected.

- **In MOV Format**

[ALL-I] **ALL-I** (For editing/I-only)

Compresses one frame at a time for recording. Although the file size is larger than with IPB (Standard) and IPB (Light), the movie is better suited for editing.

- **In MP4 Format**

[IPB] **IPB** (Standard)

Compresses multiple frames at a time efficiently for recording.

[IPB]  **IPB** (Light)

Records a movie at a bit rate lower than with IPB (Standard), resulting in a smaller file size and compatibility with a larger range of playback systems.



If you change the [**3: Video system**] setting, set the movie recording size again.

Total Movie Recording Time and File Size Per Minute

● In MOV Format (Approx.)

| Movie Recording Quality | | Total Recording Time on Card | | | File Size | |
|-------------------------|----------------------|------------------------------|--------|---------|---------------|-------------|
| | | 4 GB | 16 GB | 64 GB | | |
| FHD | 29.97P 25.00P 23.98P | [ALL-I] | 5 min. | 23 min. | 1 hr. 33 min. | 654 MB/min. |

● In MP4 Format (Approx.)

| Movie Recording Quality | | Total Recording Time on Card | | | File Size | |
|-------------------------|----------------------|------------------------------|--------------|---------------|----------------|-------------|
| | | 4 GB | 16 GB | 64 GB | | |
| FHD | 59.94P 50.00P | [IPB] | 8 min. | 35 min. | 2 hr. 21 min. | 431 MB/min. |
| | 29.97P 25.00P 23.98P | [IPB] | 17 min. | 1 hr. 10 min. | 4 hr. 41 min. | 216 MB/min. |
| | 29.97P 25.00P | [IPB] [★] | 43 min. | 2 hr. 53 min. | 11 hr. 35 min. | 87 MB/min. |
| HD | 59.94P 50.00P | [IPB] | 20 min. | 1 hr. 21 min. | 5 hr. 24 min. | 184 MB/min. |
| | 29.97P 25.00P | [IPB] [★] | 2 hr. 5 min. | 8 hr. 20 min. | 33 hr. 22 min. | 30 MB/min. |
| HDR Movie Shooting | | | 17 min. | 1 hr. 10 min. | 4 hr. 41 min. | 216 MB/min. |

● **Movie Files Exceeding 4 GB**

Even if you shoot a movie exceeding 4 GB, you can keep shooting without interruption.

During movie shooting, if the file size exceeds 4 GB, a new movie file will be created automatically.

When you play back the movie, you will have to play each movie file individually. Movie files cannot be played back automatically in consecutive order. After the movie playback ends, select the next movie to be played back.



- An increase of the camera's internal temperature may cause movie shooting to stop before the maximum recording time shown in the table (p.212).
- If the file size exceeds 4 GB during movie shooting, "buSY" may be displayed on the LCD panel for a while.

- **Movie Shooting Time Limit**

The maximum recording time of one movie clip is 29 min. 59 sec. If the movie shooting time reaches 29 min. 59 sec., the movie shooting will stop automatically. You can start shooting a movie again by pressing the < $\begin{matrix} \text{START} \\ \text{STOP} \end{matrix}$ > button. (The movie will be recorded as a new movie file.)

General Movie Shooting Cautions

Red Internal Temperature Warning Icon

- If the camera's internal temperature increases due to prolonged movie shooting or under a high ambient temperature, a red  icon will appear.
- The red  icon indicates that movie shooting will soon be terminated automatically. If this happens, you will not be able to shoot again until the camera's internal temperature decreases. Turn off the power and let the camera rest for a while.
- Shooting a movie at a high temperature for a prolonged period will cause the  icon to appear earlier. When you are not shooting, always turn off the camera.

Recording and Image Quality

- If the attached lens has an Image Stabilizer and you set the Image Stabilizer (IS) switch to **<ON>**, the Image Stabilizer will operate at all times even if you do not press the shutter button halfway. The Image Stabilizer consumes battery power and may shorten the total movie shooting time depending on the shooting conditions. If you use a tripod or if the Image Stabilizer is not necessary, it is recommended to set the IS switch to **<OFF>**.
- The camera's built-in microphones will also pick up the operation sound during shooting and mechanical sound of the camera. Use a commercially-available external microphone to reduce these sounds in the movie.
- Do not connect anything other than an external microphone to the camera's external microphone IN terminal.
- If the brightness changes during autoexposure movie shooting, the movie may freeze temporarily. In such a case, shoot movies with manual exposure.
- If there is a very bright light source in the image, the bright area may appear black on the LCD monitor. The movie will be recorded almost exactly as it appears on the LCD monitor.
- In low light, noise or irregular colors may appear in the image. The movie will be recorded almost exactly as it appears on the LCD monitor.
- If you play back a movie with other devices, image or sound quality may deteriorate or playback may not be possible (even if the devices support MOV/MP4 format).

General Movie Shooting Cautions

Recording and Image Quality

- If you use a card with a slow writing speed, a five-level indicator may appear on the right of the screen during movie shooting. It indicates how much data has not yet been written to the card (remaining capacity of the internal buffer memory). The slower the card, the faster the indicator will climb upward. If the indicator becomes full, movie shooting will stop automatically.

If the card has a fast writing speed, the indicator will either not appear or the level (if displayed) will hardly go upward. First, shoot a few test movies to see if the card can write fast enough.



Playback and TV Connection

- If you connect the camera to a TV set and shoot a movie, the TV set will not output any sound during the shooting. However, the sound will be properly recorded.

Restrictions on MP4-format Movies

Note that generally the following restrictions apply to MP4-format movies.

- Sound will not be recorded on approx. the last two frames.
- When you play back movies on Windows, images and sound may become slightly out of synchronization.



8

Image Playback

This chapter explains basic procedures to play back images and movies.

Images shot and saved with another device

The camera may not be able to properly display images captured with a different camera, edited with a computer, or that have had their file names changed.

▶ Image Playback

Single-Image Display



1 Play back the image.

- Press the <▶> button.
- ▶ The last image captured or played back will appear.



2 Select an image.

- To play back images starting with the last image captured, turn the <◀> dial counterclockwise.
- To play back images starting with the first captured image, turn the dial clockwise.
- Each time you press the <INFO.> button, the information display will change.



No information



Basic information display

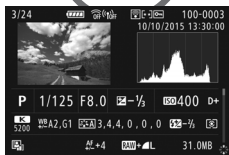

Shooting information display

3 Exit the image playback.

- Press the <▶> button to exit the image playback and return to shooting-ready state.

Shooting Information Display

With the shooting information screen displayed (p.216), you can press the <▲> <▼> keys to change the shooting information displayed at the screen's bottom as follows. For details, see pages 219-220.

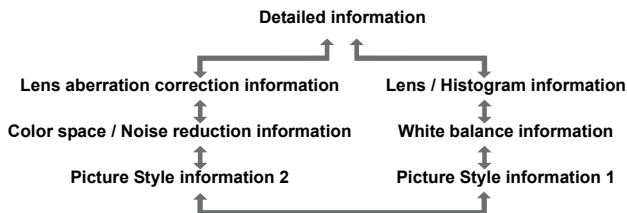

INFO.: Shooting Information Display

The information displayed varies depending on the shooting mode and settings.

Sample Information for Still Photos

● Basic information display

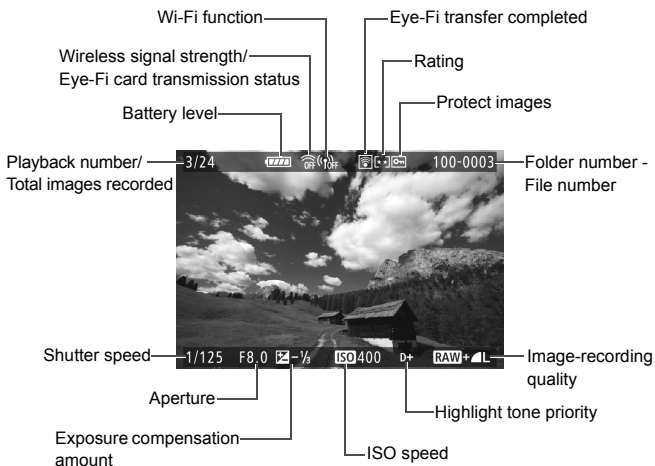

- If the image was taken by another camera, certain shooting information may not be displayed.
- It may not be possible to play back images taken with this camera on other cameras.

- **Shooting information display**
 - **Detailed information**

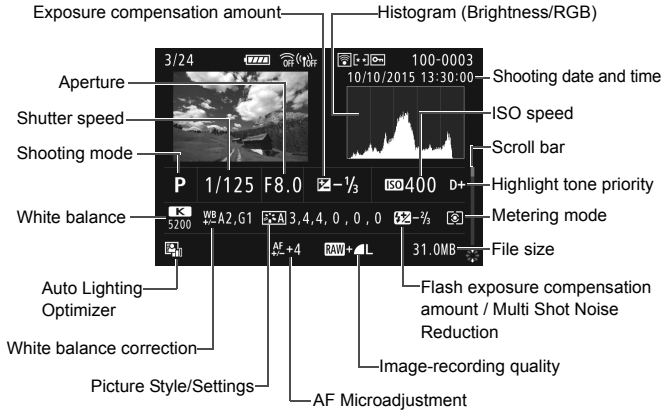

- * When you shoot in RAW+JPEG image quality, the RAW image file size will be displayed.
- * For images shot with flash not applying exposure compensation, <⚡> will be displayed.
- * <HDR> and the dynamic range adjustment amount will be displayed for images shot with HDR shooting.
- * <Ⓜ> will be displayed for images shot with multiple-exposure shooting.
- * <NR> will be displayed for images shot with Multi Shot Noise Reduction.
- * <Ⓜ> will be displayed for still photos taken as test shots for time-lapse movies.
- * <Ⓜ> will be displayed for images shot with the Creative filter function and for images that are processed (RAW image processing performed, resized, or Creative filter applied) and then saved.
- * For cropped images, <Ⓜ> and <Ⓜ> will be displayed.

• **Lens/Histogram information**

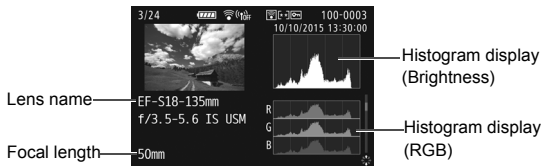

• **White balance information**

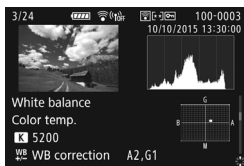

• **Picture Style information 1**

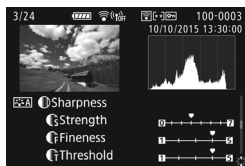

• **Picture Style information 2**

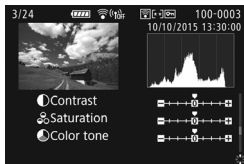

• **Color space / Noise reduction information**

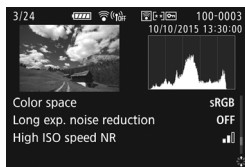

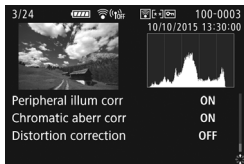

• **Lens aberration correction information**

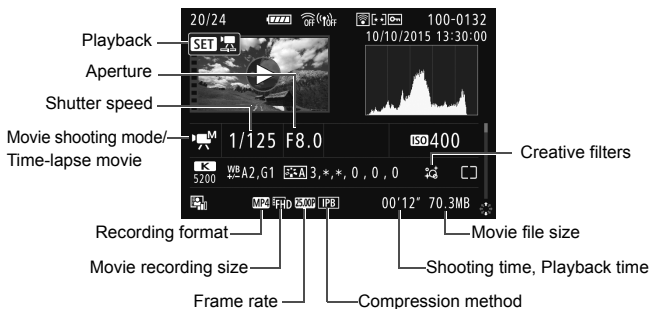

 If you used GPS Receiver GP-E2 to record GPS information for the image, the “GPS information” screen will also appear.

Sample Movie Information Display



- * If manual exposure is used, the shutter speed, aperture, and ISO speed (when set manually) will be displayed.
- * The  icon will be displayed for video snapshots.
- * The  icon will be displayed for HDR movies.



During movie playback, “* , *” will be displayed for [Fineness] and [Threshold] of [Picture Style]’s [Sharpness].

▶ Searching for Images Quickly

▣ Displaying Multiple Images on One Screen (Index Display)

Search for images quickly with the index display showing 4, 9, 36, or 100 images on one screen.

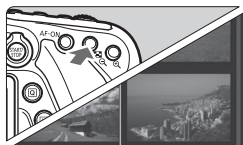

1 Switch to the index display.

- During image playback, press the <▣·Q> button.
- ▶ The 4-image index display will appear. The selected image is highlighted with an orange frame.
- Pressing the <▣·Q> button will switch the display as follows: 9 images → 36 images → 100 images. Pressing the <Q> button will switch the display as follows: 100 images → 36 images → 9 images → 4 images → 1 image.



2 Select an image.

- Turn the <☉> dial to move the orange frame and select the image. You can also press the <▲> <▼> or <◀> <▶> keys to select the image.
- Turning the <☀> dial will display image(s) on the next or previous screen.
- Press <SET> in the index display to display the selected image in the single-image display.

Playing Back with the Touch Screen

The LCD monitor is a touch-sensitive panel that you can touch with your fingers for various playback operations. **First, press the <▶> button to play back images.**

Browsing Images

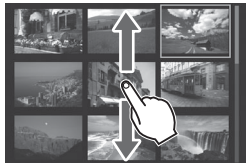

Swipe with one finger.

- With single-image display, touch the LCD monitor with **one finger**. You can browse to the next or previous image by swiping your finger to the left or right.

Swipe to the left to see the next (newer) image, or swipe to the right to see the previous (older) image.

- With index display, also touch the LCD monitor with **one finger**. You can browse to the next or previous screen by swiping your finger up or down.

Swipe up to see the next (newer) images or swipe down to see the previous (older) images.

When you select an image, the orange frame will appear. Tap on the image again to display it as a single image.

Jumping through Images (Jump Display)

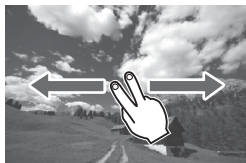

Swipe with two fingers.

Touch the LCD monitor with two fingers. When you swipe **two fingers** to the left or right, you can jump through images with the method set in **[Image jump w/ **] under the [**▶2**] tab.

Reducing Image (Index Display)



Pinch two fingers.

Touch the screen with two fingers spread apart, and pinch your fingers together on the screen.

- Each time you pinch your fingers, the single-image display will change to the index display. If you spread your fingers, the image display will change in the reverse order.
- When you select an image, the orange frame will appear. Tap on the image again to display it as a single image.

Magnifying Image

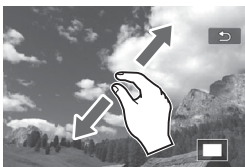

Spread two fingers apart.

Touch the screen with two fingers together, then spread your fingers apart on the screen.

- As you spread your fingers, the image will be magnified.
- The image can be magnified up to approx. 10x.
- You can scroll around the image by dragging your fingers.
- To reduce the image, pinch your fingers together on the screen.
- Tapping on the [↶] icon will return to the single-image display.



Touch screen operations on the camera's LCD monitor are also possible while playing back images on a TV set connected to your camera.

▶▶ Playing Back Movies



1 Play back the image.

- Press the <▶> button to display an image.



2 Select a movie.

- Turn the <◉> dial to select the movie to be played back.
- In the single-image display, the <SET ▶> icon displayed on the upper left of the screen indicates a movie. If the movie is a video snapshot, <SET ▶> will be displayed.
- In the index display, perforations at the left edge of a thumbnail indicate a movie. **As movies cannot be played back from the index display, press <SET> to switch to the single-image display.**



3 In the single-image display, press <SET>.

- ▶ The movie playback panel will appear at the bottom of the screen.

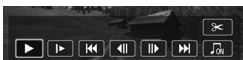





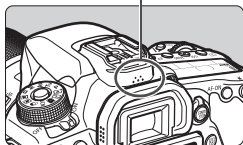













4 Play back the movie.

- Select [▶] (Play), then press <SET>.
- ▶ The movie will start playing back.
- Press <SET> during playback to pause. Press again to resume.
- You can adjust the sound volume by turning the <◉> dial even during movie playback.
- For more details on the playback procedure, see the next page.



- Before listening to a movie's sound through headphones, turn down the volume to prevent hurting your ears.
- The camera may not be able to play back movies shot with another camera.

Movie Playback Panel

| Operation | Playback Description |
|--|---|
|  Play | Pressing <  > toggles between play and stop. |
|  Slow motion | Adjust the slow motion speed by pressing the <  > <  > keys. The slow motion speed is indicated on the upper right of the screen. |
|  First frame | Displays the movie's first frame. |
|  Previous frame | Each time you press <  >, the previous frame is displayed. If you hold down <  >, it will rewind the movie. |
|  Next frame | Each time you press <  >, the movie will play frame-by-frame. If you hold down <  >, it will fast forward the movie. |
|  Last frame | Displays the movie's last frame. |
|  Background music* | Plays back a movie with the selected background music. |
|  Edit | Displays the editing screen. |
|  | Playback position |
| mm' ss" | Playback time (minutes:seconds) |
|  Volume | Turn the <  > dial to adjust the volume of the built-in speaker (p.226). |
|  | Press the < MENU > button to return to the single-image display. |

* When background music is set, the movie sound will not be played back.



- With a fully-charged Battery Pack LP-E6N, the continuous playback time at room temperature (23°C / 73°F) is approx. 3 hr. 40 min.
- By connecting commercially-available headphones equipped with a 3.5 mm diameter stereo mini plug to the camera's headphone terminal (p.20), you can listen to the movie's sound.
- If you connect the camera to a TV set to play back a movie, adjust the sound volume with the TV set. (Turning the <  > dial will not change the sound volume.) If there is audio feedback, place the camera farther away from the TV set or turn down the TV sound volume.

Playback with the Touch Screen



Tap [▶] on the center of the screen.

- ▶ The movie will start playing back.
- To display the movie playback panel, tap <SET ▶> on the upper left of the screen.
- To pause the movie while it is playing back, tap on the screen. The movie playback panel will also appear.

Erasing Images

You can either select and erase unnecessary images one by one or erase them in one batch. Protected images will not be erased.

 Once an image is erased, it cannot be recovered. Make sure you no longer need the image before erasing it. To prevent important images from being erased accidentally, protect them. Erasing an image shot in RAW+JPEG will erase both the RAW and JPEG images.

Erasing a Single Image



1 Play back the image to be erased.

2 Press the  button.

▶ The Erase menu will appear.



3 Erase the image.

- Select [**Erase**], then press . The image displayed will be erased.



To erase all images including protected images, format the card (p.58).



9

Software Start Guide / Downloading Images to a Computer

This chapter explains the following:

- Overview of the software for EOS cameras
- How to download and install the software on a computer
- How to download and view the Software Instruction Manuals (PDF files)
- How to download images from the camera to a computer

Software Start Guide

Software Overview

This section explains an overview of various software applications for EOS cameras. Internet connection is required to download and install the software. Download and installation are not possible in environments with no Internet connection.

EOS Utility

With the camera connected to a computer, EOS Utility enables you to transfer still photos and movies shot with the camera to the computer. You can also use this software to set various camera settings and shoot remotely from the computer connected to the camera. Also, you can copy background music tracks, such as EOS Sample Music*, to the card.

* You can use the background music as the soundtrack for a video snapshot album, movie, or slide show played back with your camera.

Digital Photo Professional

This software is recommended for users who shoot RAW images. You can view, edit, and print RAW and JPEG images.

* Some functions differ between the version to be installed on a 64-bit computer and that to be installed on a 32-bit computer.

Picture Style Editor

You can edit Picture Styles, and create and save original Picture Style files. This software is aimed at advanced users who are experienced in processing images.

Downloading and Installing the Software



- **Do not connect the camera to your computer before you install the software. Otherwise, the software will not be installed properly.**
- Even if a previous version of the software is installed on your computer, follow the procedure below to install the latest version. (The previous version will be overwritten.)

1 Download the software.

- Connect to the Internet from a computer and access the following Canon website.

www.canon.com/icpd

- Select your country or region of residence and download the software.
- Decompress it on the computer.

For Windows: Click the displayed installer file to start the installer.

For Macintosh: A dmg file will be created and displayed. Follow the steps below to start the installer.

(1) Double-click the dmg file.

- ▶ A drive icon and installer file will appear on the desktop. If the installer file does not appear, double-click the drive icon to display it.

(2) Double-click the installer file.

- ▶ The installer starts.

2 Click **[Easy Installation]** and follow the on-screen instructions to install.

- For Macintosh, click **[Install]**.

Downloading and Viewing the Software Instruction Manuals (PDF Files)

Internet connection is required to download the Software Instruction Manuals (PDF files). Download is not possible in environments with no Internet connection.

1 Download the Software Instruction Manuals (PDF files).

- Connect to the Internet and access the following Canon website.

www.canon.com/icpd

- Select your country or region of residence and download the Instruction Manuals.

2 View the Software Instruction Manuals (PDF files).

- Double-click a downloaded Instruction Manual (PDF file) to open it.
- To view the Instruction Manuals (PDF files), Adobe Acrobat Reader DC or other Adobe PDF viewer (most recent version recommended) is required.
- Adobe Acrobat Reader DC can be downloaded free from the Internet.
- To learn how to use a PDF viewer, refer to its Help section.

Downloading Images to a Computer

You can use EOS software to download the images in the camera to a computer. There are two ways to do this.

Downloading by Connecting the Camera to the Computer

1 Install the software (p.233).

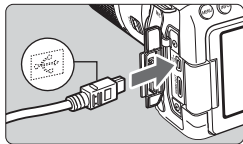

2 Use an interface cable to connect the camera to the computer.

- Connect the cable to the camera's digital terminal with the cable plug's $\left\langle \leftrightarrow \right\rangle$ icon facing the front of the camera.
- Connect the plug to the computer's USB terminal.

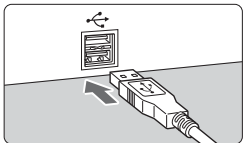

3 Use EOS Utility to download the images.

- Refer to the EOS Utility Instruction Manual.



During a wireless connection, the camera cannot be connected to a computer via an interface cable.

Downloading Images with a Card Reader

You can use a card reader to download images to a computer.

1 Install the software (p.233).

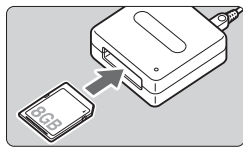

2 Insert the card into the card reader.

3 Use Digital Photo Professional to download the images.

- Refer to the Digital Photo Professional Instruction Manual.

 When downloading images from the camera to a computer with a card reader without using EOS software, copy the DCIM folder on the card to the computer.

Trademarks

- Adobe is a trademark of Adobe Systems Incorporated.
- Microsoft and Windows are trademarks or registered trademarks of Microsoft Corporation in the United States and/or other countries.
- Macintosh and Mac OS are trademarks of Apple Inc., registered in the U.S. and other countries.
- SDXC logo is a trademark of SD-3C, LLC.
- HDMI, HDMI logo, and High-Definition Multimedia Interface are trademarks or registered trademarks of HDMI Licensing LLC.
- All other trademarks are the property of their respective owners.

About MPEG-4 Licensing

“This product is licensed under AT&T patents for the MPEG-4 standard and may be used for encoding MPEG-4 compliant video and/or decoding MPEG-4 compliant video that was encoded only (1) for a personal and non-commercial purpose or (2) by a video provider licensed under the AT&T patents to provide MPEG-4 compliant video. No license is granted or implied for any other use for MPEG-4 standard.”

* Notice displayed in English as required.

Use of genuine Canon accessories is recommended

This product is designed to achieve excellent performance when used with genuine Canon accessories.

Canon shall not be liable for any damage to this product and/or accidents such as fire, etc., caused by the malfunction of non-genuine Canon accessories (e.g., a leakage and/or explosion of a battery pack). Please note that this warranty does not apply to repairs arising out of the malfunction of non-genuine Canon accessories, although you may request such repairs on a chargeable basis.

 Battery Pack LP-E6N/LP-E6 is dedicated to Canon products only. Using it with an incompatible battery charger or product may result in malfunction or accidents for which Canon cannot be held liable.

Only for European Union and EEA (Norway, Iceland and Liechtenstein)



These symbols indicate that this product is not to be disposed of with your household waste, according to the WEEE Directive (2012/19/EU), the Battery Directive (2006/66/EC) and/or national legislation implementing those Directives.

■
If a chemical symbol is printed beneath the symbol shown above, in accordance with the Battery Directive, this indicates that a heavy metal (Hg = Mercury, Cd = Cadmium, Pb = Lead) is present in this battery or accumulator at a concentration above an applicable threshold specified in the Battery Directive.

This product should be handed over to a designated collection point, e.g., on an authorized one-for-one basis when you buy a new similar product or to an authorized collection site for recycling waste electrical and electronic equipment (EEE) and batteries and accumulators. Improper handling of this type of waste could have a possible impact on the environment and human health due to potentially hazardous substances that are generally associated with EEE. Your cooperation in the correct disposal of this product will contribute to the effective usage of natural resources.

For more information about the recycling of this product, please contact your local city office, waste authority, approved scheme or your household waste disposal service or visit www.canon-europe.com/weee, or www.canon-europe.com/battery.

CAUTION

RISK OF EXPLOSION IF BATTERY IS REPLACED BY AN INCORRECT TYPE.
DISPOSE OF USED BATTERIES ACCORDING TO LOCAL REGULATION.

Index

Numerics

| | |
|----------------------------------|-----|
| 10- or 2-sec. self-timer | 130 |
| 1280x720 (movie) | 208 |
| 1920x1080 (movie) | 208 |
| 45-point AF auto selection | 114 |

A

| | |
|--|----------|
|  (Scene Intelligent Auto) | 72 |
| Access lamp | 32 |
| Accessories | 3 |
| AE lock | 169 |
| AEB (Auto Exposure Bracketing) ... | 167 |
| AF | |
| AF area selection mode | 114, 115 |
| AF-assist beam | 113 |
| AF groups | 119 |
| AF method | 180 |
| AF-ON (AF start) button | 44 |
| AF operation | 110, 178 |
| AF point | 114 |
| AF point selection | 116 |
| AF points light up in red | 113 |
| AF sensor | 118 |
| Area AF frame | 114 |
| Beep (Beeper) | 60 |
| Cross-type focusing | 118 |
| Difficult subjects for AF | 188 |
| Dual cross-type focusing | 118 |
| Manual focusing (MF) | 127, 192 |
| Out of focus | 43, 188 |
| Recomposing | 75 |
| AI FOCUS (AI Focus AF) | 112 |
| AI SERVO (AI Servo AF) | 75, 112 |
| ALL-I (For editing/I-only) | 209 |
| Ambience-based shots | 102 |
| Angle of view | 42 |
| Anti-flicker shooting | 152 |
| Aperture-priority AE | 160 |
| Area AF frame | 114 |
| Auto Lighting Optimizer | 142 |

| | |
|--------------------------------------|--------|
| Auto power off | 35, 60 |
| Autofocus → AF | |
| Automatic selection (AF point) | 114 |
| Av (Aperture-priority AE) | 160 |

B

| | |
|------------------------------|------------|
| Background blur | 80 |
| Basic Zone modes | 24 |
| Battery | 28, 30, 36 |
| Battery Grip | 36 |
| Beep (Beeper) | 60 |
| Black-and-white images | 102, 138 |
| Bracketing | 167 |
| Built-in flash | 170 |

C

| | |
|---|---------------|
|  (Creative Auto) | 78 |
| Camera | |
| Clearing the camera settings | 62 |
| Holding the camera | 43 |
| Candlelight | 85 |
| Cards | 5, 19, 31, 58 |
| Card reminder | 32 |
| Formatting | 58 |
| Low-level formatting | 59 |
| Troubleshooting | 33, 59 |
| Write protection | 31 |
| Center-weighted average metering | 165 |
| Charger | 26, 28 |
| Chromatic aberration correction ... | 149 |
| Clearing the camera settings | 62 |
| Close-ups | 91 |
| Color temperature | 139 |
| Color tone | 83, 85 |
| Continuous shooting | 128 |
| Creative Auto | 78 |
| Creative filters | 95 |

- ☆ (Creative Zone) icon..... 8
- Creative Zone modes 25
- Cross-type focusing 118
- Custom Controls 51
- D**
- Date/time 37
- Daylight saving time..... 38
- Default settings 62
- Depth-of-field preview 161, 174
- Dials
 - Main Dial 45
 - Mode Dial 45
 - Quick Control Dial 46
- Digital terminal 20, 235
- Dioptic adjustment 43
- Dragging 56
- Drive mode 128
- Dual cross-type focusing 118
- E**
- Electronic level..... 66
- Erasing images 229
- Evaluative metering 164
- exFAT..... 59
- Exposure compensation 166
- Exposure level indicator..... 23
- Eyepiece cover 27
- F**
- Feature guide..... 69
- File size..... 133, 210, 219
- Fine (image-recording quality) 133, 134
- Fish-eye effect 98
- Flash (Speedlite)
 - Built-in flash..... 170
 - Effective range 171
 - Flash off..... 77, 101
 - Flash sync contacts..... 20
- Focus indicator..... 72
- Focus lock..... 75
- Focus mode switch 41, 127, 192
- Focusing → AF
- Focusing point (AF point)..... 114
- Food 83
- Formatting..... 58
- Frame rate..... 208
- Full High-Definition (Full HD)..... 197, 208
- G**
- Grainy B/W..... 97
- H**
- Handheld Night Scene 87
- HD (movie)..... 208
- HDR art bold 99
- HDR art embossed..... 99
- HDR art standard 98
- HDR art vivid 99
- HDR Backlight Control 88
- Help..... 70
- High-Definition (HD) movies..... 208
- High ISO speed noise reduction ... 143
- Highlight tone priority 147
- High-speed continuous shooting ... 128
- Hot shoe 20
- I**
- Illumination (LCD panel)..... 49
- Image review time 61
- Image-recording quality..... 132, 207
- Images
 - Erasing..... 229
 - Index display..... 222
 - Magnification..... 223
 - Playback 215
 - Review time 61
 - Shooting information..... 218

- Index display 222
- INFO. button 176, 203, 216
- Initializing the card (formatting)..... 58
- IPB (Light)..... 209
- IPB (Standard) 209
- ISO speed 135, 200, 202
- J**
- JPEG..... 132
- K**
- Kids 84
- L**
- Landscape 90
- Language 40
- Large (image-recording quality) 133
- Large Zone AF 114
- LCD monitor..... 18, 34
- Electronic level 66
- Image playback 215
- Menu display 52
- Shooting function settings 49
- Vari-Angle 34, 76
- LCD panel 22
- Lens 19, 41
- Chromatic aberration
 correction..... 149
- Distortion correction..... 149
- Lock release 42
- Peripheral illumination
 correction..... 148
- Lighting/scene-based shots 106
- Live View shooting 76, 173
- AF operation 110, 178
- Face+Tracking 181
- FlexiZone - Multi 183
- FlexiZone - Single..... 185
- Information display 176
- Manual focusing (MF)..... 192
- Possible shots 175
- LOCK..... 48
- Long exposure noise reduction 145
- Low-speed continuous shooting... 128
- M**
- M (Manual exposure) 162, 201
- Macro photography 91
- Magnified view..... 192, 223
- Main Dial 45
- Manual exposure 162, 201
- Manual focusing (MF)..... 127, 192
- Manual selection (AF point)..... 116
- Maximum burst..... 133
- Medium
(image-recording quality)..... 133
- Memory cards → Cards
- Menu 52
- Setting procedure..... 53
- MENU** icon..... 8
- Metering mode 164
- MF (manual focusing)..... 127, 192
- Microphone..... 198
- Miniature effect..... 98
- Mode Dial 24, 45
- Monochrome images..... 102, 138
- MOV 207
- Movies 197
- AE lock..... 199
- Autoexposure Shooting..... 198
- Compression method 209
- File size 210
- Frame rate 208
- Information display 203
- Manual exposure shooting 201
- Microphone 198
- Movie recording size 207
- Playback 226
- Recording time 210
- MP4 207

| | |
|----------------------------------|----------|
| M-RAW (Medium RAW)..... | 133, 134 |
| Multi function lock | 48 |
| Multi Shot Noise Reduction | 143 |
| Multi-controller | 47 |

N

| | |
|--------------------------------|----------|
| Night Portrait..... | 86 |
| Night scenes | 86, 87 |
| Noise reduction | |
| High ISO speed | 143 |
| Long exposures | 145 |
| Nomenclature | 20 |
| Normal | |
| (image-recording quality)..... | 133, 134 |
| NTSC | 208 |

O

| | |
|---------------------------|----------|
| ONE SHOT (One-Shot AF)... | 111, 178 |
|---------------------------|----------|

P

| | |
|---------------------------------------|--------------|
| P (Program AE) | 156 |
| PAL | 208 |
| Partial metering..... | 164 |
| Peripheral illumination correction... | 148 |
| Picture Style..... | 137 |
| Pixel count | 132 |
| Playback | 215 |
| Portrait | 89 |
| Possible shots..... | 36, 133, 175 |
| Power | |
| Auto power off | 60 |
| Battery level..... | 36 |
| Possible shots | 36, 175 |
| Recharge..... | 28 |
| Pressing completely..... | 44 |
| Pressing halfway..... | 44 |
| Program AE | 156 |
| Program shift | 157 |













Q













| | |
|---|---------|
|  (Quick Control) | 50, 100 |
| Quick Control Dial | 46 |

R

| | |
|-----------------------------------|---------------|
| RAW | 132, 133, 134 |
| RAW+JPEG | 132 |
| Recharging..... | 28 |
| Reduced display..... | 222 |
| Release shutter without card..... | 32 |

S

| | |
|--|-----|
| Safety precautions | 14 |
| Scene Intelligent Auto | 72 |
| SD, SDHC, SDXC cards → Cards | |
| Self-timer | 130 |
| Sensitivity → ISO speed | |
| Sepia (Monochrome)..... | 102 |
| Servo AF | 179 |
| Shooting function settings | 49 |
| Shooting information display | 218 |
| Shooting modes | 24 |
| Av (Aperture-priority AE)..... | 160 |
| M (Manual exposure)..... | 162 |
| P (Program AE) | 156 |
| Tv (Shutter-priority AE)..... | 158 |
|  (Scene Intelligent Auto)..... | 72 |
|  (Creative Auto) | 78 |
|  (Flash Off)..... | 77 |
| SCN (Special scene) | |
|  (Food)..... | 83 |
|  (Kids) | 84 |
|  (Candlelight) | 85 |
|  (Night Portrait) | 86 |
|  (Handheld Night Scene) | 87 |
|  (HDR Backlight Control) | 88 |
|  (Portrait)..... | 89 |
|  (Landscape)..... | 90 |
|  (Close-up)..... | 91 |
|  (Sports) | 92 |

-  (Creative filters) 95
 -  (Grainy B/W)..... 97
 -  (Soft focus) 97
 -  (Fish-eye effect)..... 98
 -  (Toy camera effect) 98
 -  (Miniature effect)..... 98
 -  (Water painting effect) 98
 -  (HDR art standard) 98
 -  (HDR art vivid) 99
 -  (HDR art bold) 99
 -  (HDR art embossed)..... 99
 - Shutter button 44
 - Shutter-priority AE..... 158
 - Silent shooting
 - Silent continuous shooting..... 128
 - Silent single shooting..... 128
 - Single-image display 216
 - Single-point AF 114
 - Small (image-recording quality) ... 133
 - Soft focus 97
 - Software 232
 - Speaker..... 226
 - Special scene mode (SCN)..... 82
 - Sports..... 92
 - Spot metering..... 164
 - S-RAW (Small RAW) 133, 134
 - Stop down aperture..... 161, 174
 - Strap 27
- T**
- Tapping 55
 - Temperature warning 194, 212
 - Time zone 37
 - Tone priority 147
 - Touch beeping..... 56
 - Touch screen..... 55, 224
 - Touch shutter 190
 - Toy camera effect..... 98
 - Tripod socket 21
 - Tv (Shutter-priority AE)..... 158
- U**
- USB (digital) terminal 235
- V**
- Vari-Angle LCD monitor..... 34, 76
 - Video system..... 208
 - Viewfinder..... 23
 - Dioptic adjustment 43
 - Electronic level..... 66
 - Flicker detection..... 68
 - Grid display 65
 - Volume (movie playback) 227
- W**
- Water painting effect..... 98
 - White balance (WB) 139
 - Ambience priority ()..... 140
 - White priority ()..... 140
- Z**
- Zone AF..... 114



Canon

EOS 80D
EOS 80D (W)

Wireless Function Basic Instruction Manual

In the Wireless Function Basic Instruction Manual, basic operation procedures for easy-to-use “Connect to a smartphone”, “Transfer images between cameras”, and “Save images to Connect Station” are explained.

Introduction

What You Can Do Using the Wireless Functions

This camera's wireless functions let you perform a range of tasks wirelessly, from sending images to Web services and other cameras to controlling the camera remotely, simply by connecting to a Wi-Fi® network or other device supporting this camera's wireless functions.

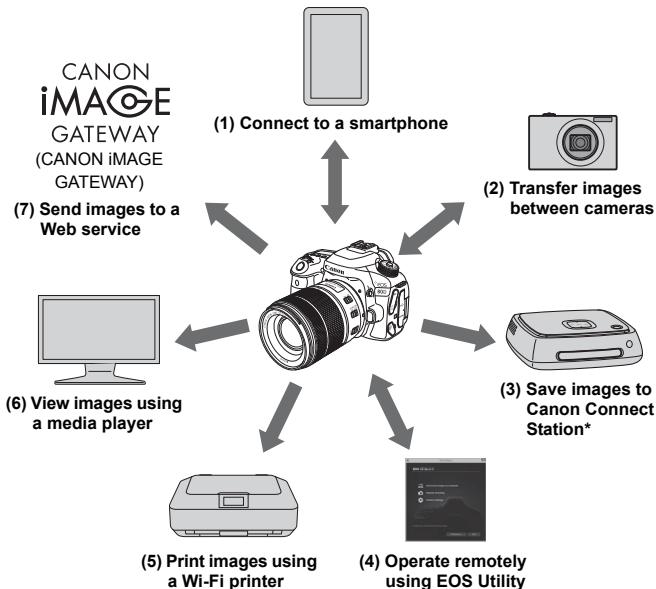

* Use the latest firmware.

 CANON iMAGE GATEWAY web services are not supported in certain countries and areas. For information on supported countries and areas, refer to the Canon website (www.canon.com/cig).

(1)  Connect to a smartphone (p.W-19)

Connect the camera to a smartphone or tablet wirelessly and use the dedicated application “Camera Connect” to operate the camera remotely or view images stored in the camera.

In this manual and on the camera’s LCD monitor, “smartphone” refers to smartphones and tablets.

(2)  Transfer images between cameras (p.W-39)

Wirelessly connect this camera and other Canon cameras with built-in wireless functions and transfer images between them.

(3) Save images to Connect Station (p.W-47)

Connect the camera to Connect Station (sold separately) wirelessly to save images.

(4)  Operate remotely using EOS Utility

Connect the camera to a computer wirelessly and operate the camera remotely using EOS Utility (EOS software).

(5)  Print images using a Wi-Fi printer

Wirelessly connect the camera to a printer supporting PictBridge (Wireless LAN) to print images.

(6)  View images using a media player

Wirelessly connect the camera to a media player supporting DLNA* to view images on the camera’s memory card on your TV set.

* Digital Living Network Alliance

(7)  Send images to a Web service

Share images with family and friends or share images using a range of Web services via CANON iMAGE GATEWAY, an online photo service for Canon users (free registration required).

Easy Connection Using the NFC Function

This camera supports NFC* which enables you to set up a connection between the camera and a smartphone or Connect Station (sold separately) easily. For details, see page W-16.

* Near Field Communication

Instruction Manual

For how to use **[Remote control (EOS Utility)]**, **[Print from Wi-Fi printer]**, **[View images on DLNA devices]**, and **[Upload to Web service]** and for more detailed procedures, refer to the “Wireless Function Instruction Manual” PDF file. The “Wireless Function Instruction Manual” PDF file can be downloaded from the Canon website (p.4).

- Note that Canon cannot be held liable for any loss or damage from erroneous wireless communication settings for using the camera. In addition, Canon cannot be held liable for any other loss or damage caused by use of the camera.
- When using wireless functions, establish appropriate security at your own risk and discretion. Canon cannot be held liable for any loss or damage caused by unauthorized access or other security breaches.

Contents

Introduction W-2

What You Can Do Using the Wireless Functions W-2

Conventions Used in this Manual W-6

1 Preparation and Basic Operation W-7

Registering a Nickname W-8

Basic Operation and Settings W-11

NFC Function W-16

Preparation for Smartphones W-18

2 Easy Connection to a Smartphone W-19

Connection Method W-20

Connecting Automatically with the NFC Function W-21

Connecting with Easy Connection W-24

Operating the Camera Using a Smartphone W-28

Reconnecting W-31

Sending Images to a Smartphone W-33

3 Easy Connection Between Cameras W-39

Connecting to a Camera W-40

Sending Images to a Camera W-42

Reconnecting W-45

4 Easy Connection to Connect Station W-47

Saving Images W-48

Wi-Fi (Wireless LAN) Precautions W-50

Index W-52



For Troubleshooting guide and Specifications, refer to the Instruction Manual downloadable from the Canon website. For how to download the Instruction Manual, see page 4.

Conventions Used in this Manual

- In this manual, the terms “wireless” and “wireless LAN” are used as general terms for Wi-Fi and Canon’s original wireless functions.
- The camera does not come with an interface cable.

Icons in this Manual



: Indicates the Main Dial.



: Indicates the Quick Control Dial.

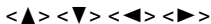

: Indicates the direction to push the Multi-controller.



: Indicates the Setting button.

* In addition to the above, the icons and symbols used on the camera’s buttons and displayed on the LCD monitor are also used in this manual when discussing relevant operations and functionality.

(p.**): Reference page numbers for more information.

: Warnings to prevent potential problems during operation.

: Supplemental information.

1

Preparation and Basic Operation

This chapter describes how to register a nickname (for identification) necessary for using the camera's wireless functions and the basic operations.

Registering a Nickname

First, set the camera's nickname (for identification).

When the camera is connected to another device wirelessly, the nickname will be displayed on the device. **Be sure to set a nickname as otherwise you cannot set the wireless functions.**

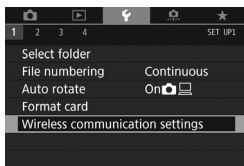

1 Select [Wireless communication settings].

- Under the [1] tab, select [**Wireless communication settings**], then press <SET>.

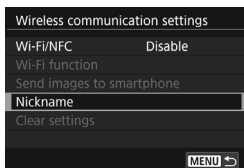

2 Select [Nickname].

- ▶ When this setting is selected for the first time, a screen to register a nickname is displayed. Press <SET> and proceed to step 3.

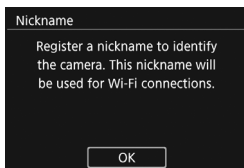



3 Enter a nickname.

- For instructions on entering characters, see the next page.
- Enter any characters between 1 to 10 characters in length.

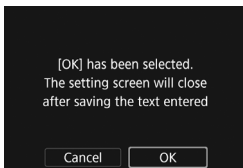

4 Exit the setting.

- When you are finished, press the <MENU> button.
- Select [OK] on the confirmation dialog and press <SET> to return to the menu screen.



Since the nickname is mandatory information, you cannot delete all the characters.



By default, the camera name will be displayed for the nickname.

Virtual Keyboard Operation



- **Changing the entry area**
Press the <[Q]> button to toggle between the top and bottom entry areas.
- **Moving the cursor**
Press the <◀> <▶> keys in the top area to move the cursor.

- **Entering text**

In the bottom area, press the <▲> <▼> or <◀> <▶> keys to select a character, then press <[SET]> to enter it.

You can check how many characters you have entered, and how many more can be entered, by referring to [*/*] on the upper right of the screen.

- **Changing the entry mode***

Select [Aa=1@] at the bottom right of the bottom entry area. Each time you press <[SET]>, the entry mode will change as follows: Lower case → Numerals / Symbols 1 → Numerals / Symbols 2 → Upper case.

* When [Touch control: Disable] is set, you can enter all characters on one screen.

- **Deleting a character**

Press the <[trash]> button to delete one character.

- **Finishing the text entry**

Press the <[MENU]> button to confirm what you have entered and exit. If a confirmation dialog is displayed, select [OK] to exit.

- **Canceling the text entry**

Press the <[INFO.]> button to cancel text entry and exit. If a confirmation dialog is displayed, select [OK] to exit.

Basic Operation and Settings

The basic operation for using the camera's wireless functions is explained here. Follow the procedures below.

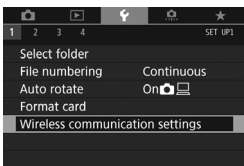

1 Select [Wireless communication settings].

- Under the [**1**] tab, select [**Wireless communication settings**], then press < **SET** >.

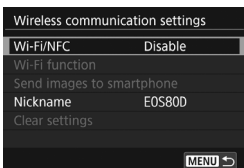

2 Select [Wi-Fi/NFC].

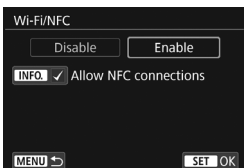

3 Select [Enable].

- **When a nickname (for identification) is not registered, a registration screen is displayed.** See page W-8 to register a nickname.
▶ [**Wi-Fi function**] is now selectable.

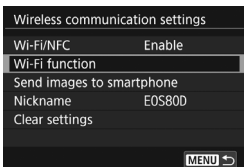

4 Select [Wi-Fi function].



You can operate wireless functions by touching the camera's screen as well.

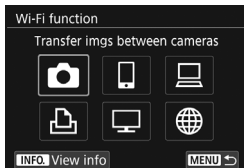

5 Select the Wi-Fi function to connect to.

- Press the <▲> <▼> or <◀> <▶> keys to select an item.
 - ▶ When the connection settings are not registered, the setting screen is displayed.
 - ▶ When the connection settings are already registered, the reconnection screen is displayed.
- When using the NFC function, see page W-16.

[Wireless communication settings] Screen

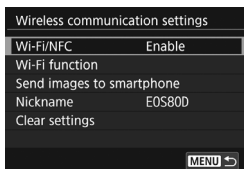

The **[Wireless communication settings]** screen displayed in step 4 on page W-11 is the portal screen for setting the wireless functions.

- Select an item and press <SET> to display the setting screen, then specify the settings.
- On the **[Wireless communication settings]** screen, you can set the following items:

[Wi-Fi/NFC]

Set whether to **[Enable]** or **[Disable]** the wireless functions. You can also set whether to enable or disable the NFC function.

- Set to **[Enable]** to enable the selection of **[Wi-Fi function]**, **[Send images to smartphone]**, and **[Clear settings]**.
- When the use of electronic devices and wireless devices is prohibited, such as on board airplanes or in hospitals, set it to **[Disable]**.

[Wi-Fi function]

The following Wi-Fi functions are available:

- Transfer images between cameras
- Connect to smartphone
- Remote control (EOS Utility)
- Print from Wi-Fi printer
- View images on DLNA devices
- Upload to Web service

[Send images to smartphone]

While the camera is connected to a smartphone, use this function to send images stored in the camera to the smartphone.

[Nickname]

Register or change the nickname.

[Clear settings]







Clear all wireless communication settings.

- When multiple exposures, video snapshot, or time-lapse movie is set, you cannot select [**1**: **Wireless communication settings**].

Interface Cable Connection Cautions

- During a wireless LAN connection, you cannot use the camera by connecting it to Connect Station, a computer, a GPS receiver, or another device with a cable. Terminate the connection before connecting a cable.
- When the camera is connected to Connect Station, a computer, a GPS receiver, or another device with a cable, you cannot select [**1**: **Wireless communication settings**]. Disconnect the cable before changing any settings.

Cards

- For [, [, [, and [, the camera cannot be connected wirelessly if there is no card in the camera. Additionally, for [, [, and [, the camera cannot be connected wirelessly if there are no images saved on the card.

Using the Camera During Wireless Connection

- When you want to prioritize the wireless connection, do not operate the power switch, card slot cover, battery compartment cover, or other parts. Otherwise, the wireless connection may be terminated.

Using an Eye-Fi Card

- When [**Wi-Fi/NFC**] is set to [**Enable**], image transfer using an Eye-Fi card is disabled.

Wireless Connection Status

Wireless connection status can be checked on the camera's LCD monitor and LCD panel.

LCD panel

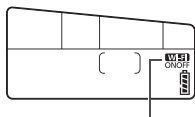

Wi-Fi function

| Connection status | Wi-Fi function |
|-------------------|---------------------|
| Not connected | Wi-Fi OFF |
| Connected | Wi-Fi ON |
| Connection error | Wi-Fi ON (Blinking) |

LCD monitor

Creative Zone modes



Basic Zone modes



Wi-Fi function

Wireless signal strength

| Connection status | | Wi-Fi function | Wireless signal strength |
|--------------------------|--------------------|----------------|--------------------------|
| Not connected | Wi-Fi/NFC: Disable | (OFF) | (Off) |
| | Wi-Fi/NFC: Enable | (OFF) | |
| Connected | | () | ▬▬▬ |
| Sending data | | () (←→) | ▬▬▬ |
| Waiting for reconnection | | () (Blinking) | ▬ |
| Connection error | | () (Blinking) | ▬ |

* ▬▬▬ is also displayed in the screen for sending or receiving images.

* ▬▬▬ is not displayed when the camera is connected with [Easy connection].

NFC Function

Using an NFC-enabled smartphone or Connect Station enables you to do the following:

- Touch a smartphone to the camera to easily connect them wirelessly (p.W-21).
- While playing back images on the camera, touch a smartphone to the camera to send a captured image to the smartphone (p.W-33).
- Hold the camera close to Connect Station (sold separately) to easily connect them wirelessly (p.W-48).

When using the NFC function, follow the steps below to set the camera's NFC setting.

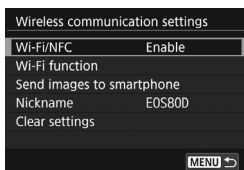

1 Select [Wi-Fi/NFC].

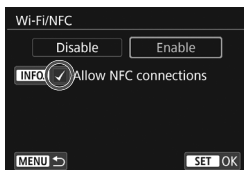

2 Add [✓] to [Allow NFC connections].

- Displayed when [Wi-Fi/NFC] is set to [Enable].
- Press the <INFO.> button to add or remove [✓]. Add [✓], then press <SET>.
- When a nickname (for identification) is not registered, a registration screen is displayed (p.W-8).



What is NFC?

NFC (Near Field Communication) is a function that can exchange information by simply bringing two NFC-enabled devices close together. This camera uses the NFC function to exchange information regarding wireless connections.

When establishing wireless communications using the NFC function, see the following pages.

Connecting to a smartphone wirelessly: page W-21*

Sending images to a smartphone: page W-33*

Connecting to Connect Station: page W-48

* When connecting to a smartphone, see pages W-18 and W-20 as well.



NFC Function Cautions

- This camera cannot be connected to other NFC-enabled cameras or printers using the NFC function.
- A connection cannot be established using the NFC function while shooting with the camera, when there is no card, when the LCD monitor is closed with the screen facing inward, or while the camera is connected to another device with an interface cable.
- To connect the camera to a smartphone using the NFC function, the smartphone's Wi-Fi and NFC functions must be enabled.



A connection can be established even when the camera's power is in the auto power off state. However, if a connection cannot be established, cancel auto power off, then establish a connection.

Preparation for Smartphones

To use [] (Connect to smartphone), a smartphone on which iOS or Android is installed is necessary. In addition, the dedicated application Camera Connect (free of charge) must be installed on the smartphone.

- Camera Connect can be downloaded from the App Store or Google Play.
- For the operating system versions supported by Camera Connect, refer to the download site of Camera Connect.
- When an NFC-enabled smartphone is touched to the camera before installing Camera Connect, the download screen of Camera Connect will be displayed on the smartphone.
- Interface or functions of the camera and Camera Connect are subject to change for firmware update of the camera or application update of Camera Connect, iOS, Android, etc. In such a case, features of the camera or Camera Connect may differ from sample screens or operation instructions in this manual.



Easy Connection to a Smartphone

Connecting the camera to a smartphone enables you to do the following:



- View images stored in the camera on a smartphone or save viewed images to a smartphone.
- Operate the camera to take a picture or change camera settings using a smartphone.
- Send images to a smartphone from the camera.

This section explains how to connect the camera directly to a smartphone.

- Install Camera Connect on the smartphone before setting up a connection (p.W-18).
- For procedures to send images to an NFC-enabled smartphone, see page W-33.

Connection Method

- **When the smartphone is NFC-enabled: See page W-21.**
You can easily set up a connection using the NFC function.
- **When the smartphone is not NFC-enabled: See page W-24.**
Set up a connection by selecting [**Easy connection**].

Smartphones labeled with the  mark are NFC-enabled. Some smartphones are not labeled with the  mark even if they are NFC-enabled; if you do not know whether your smartphone is NFC-enabled, contact the manufacturer of the smartphone.

 A connection may not be established with the NFC function even if the smartphone is NFC-enabled.

Connecting Automatically with the NFC Function ■

Connect the camera and a smartphone using the NFC function.
The operation flow for connecting via NFC is as follows.

(1) Turn on the camera and smartphone.

(2) Enable the NFC function on the camera and smartphone.

(3) Touch the smartphone to the camera so that they come into contact with each other.

- For the camera's NFC setting, see page W-16.
- For the smartphone's Wi-Fi setting, NFC setting, and NFC antenna position, refer to the smartphone's instruction manual.

1 Enable the NFC function on the camera and smartphone (p.W-16).

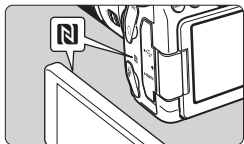

2 Touch a smartphone to the camera.

- If an image is being played back on the camera, press the <▶> button to end the playback.
- Touch the **N** mark on the smartphone to that on the camera.
- **When a message indicating the connection is displayed on the camera's LCD monitor,** move the smartphone away from the camera.
- ▶ Camera Connect starts on the smartphone and establishes a connection.



The device name set on Camera Connect

3 Connect to the camera.

- When a connection is established, the screen on the left will appear on the camera's LCD monitor. When connecting to the same smartphone, this screen will not appear again.
- Select **[OK]** and press **<SET>**. After a message is displayed, the **[Wi-Fi on]** screen will appear.

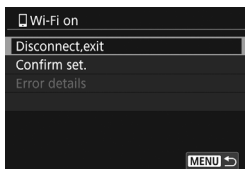

- ▶ The main window of Camera Connect will be displayed on the smartphone.
- To return to the menu, press the **<MENU>** button.

The settings for connecting to a smartphone are now complete.
For operations after setting up a connection, see page W-28.

 You can check or change the device name on the setting screen of Camera Connect.



- **If necessary, also read “NFC Function Cautions” (p.W-17).**
- When touching the smartphone to the camera, be careful not to drop the camera or smartphone.
- Do not touch the smartphone to the camera with too much force. Doing so can scratch the camera or smartphone.
- Just holding the smartphone close to the mark may not establish a connection. Be sure to touch the mark with the smartphone so that they come into contact with each other.
- Recognition may be difficult depending on the smartphone. Touch slowly while changing the position or rotating horizontally.
- Another application on the smartphone may start depending on how you touch. Check the position of the **N** mark, then touch again.
- When touching the smartphone to the camera, do not leave anything between the camera and smartphone. In addition, when a case is attached to the camera or smartphone, communication may not be possible via NFC function.



- The camera cannot be connected to two or more smartphones at the same time.
- By default, the connection settings via the NFC function are saved as the fourth setting (a setting dedicated to NFC connection) under the name **[SET4(NFC)]**. When you connect the camera to another smartphone via NFC, **[SET4(NFC)]** will be overwritten.
- While connected, the camera's auto power off does not function.

Connecting with Easy Connection

The camera and a smartphone can be directly connected wirelessly. No access point is necessary, so you can establish a wireless connection easily.

To establish connection, operations on the smartphone are required. For details, refer to the smartphone's instruction manual.

Operation on the Camera-1

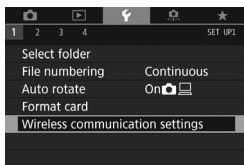

1 Select [Wireless communication settings].

- Under the [**1**] tab, select [**Wireless communication settings**], then press < **SET** >.

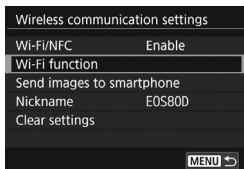

2 Select [Wi-Fi function].

- Set [**Wi-Fi/NFC**] to [**Enable**], then select [**Wi-Fi function**].



3 Select [**☑**] (Connect to smartphone).



4 Select [Easy connection].

- Select [**OK**] and press < **SET** > to go to the next screen.

Operation on the Smartphone

Smartphone's screen (sample)

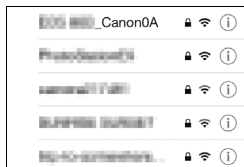

5 Operate the smartphone and connect it to the camera.

- Activate the smartphone's Wi-Fi function, then select the SSID (network name) displayed on the camera's LCD monitor.
- For the password, enter the encryption key displayed on the camera's LCD monitor.

Camera's screen

SSID (network name)

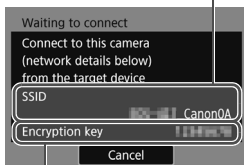

Encryption key (password)



When connecting by selecting [Easy connection], “_Canon0A” is displayed at the end of the SSID.



6 Start Camera Connect on the smartphone.

- When the [Waiting to connect] screen is displayed on the camera's LCD monitor, start Camera Connect on the smartphone.

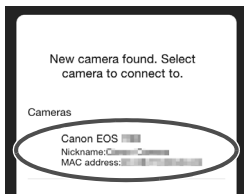

7 Select the camera to connect to on the smartphone.

- Select and touch the camera to connect to from [Cameras] on Camera Connect.

Operation on the Camera-2

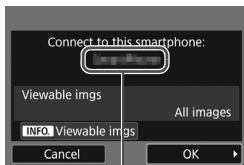

The device name set on Camera Connect

8 Connect to the camera.

- When a connection is established, the screen on the left will appear on the camera's LCD monitor.
- Select **[OK]** and press **<SET>**. After a message is displayed, the **[Wi-Fi on]** screen will appear.



- ▶ The main window of Camera Connect will be displayed on the smartphone.
- To return to the menu, press the **<MENU>** button.

The settings for connecting to a smartphone are now complete. For operations after setting up a connection, see page W-28.



- You can check or change the device name on the setting screen of Camera Connect.
- While connected, the camera's auto power off does not function.

Operating the Camera Using a Smartphone

You can use a smartphone with Camera Connect installed to view images stored in the camera and shoot remotely.

Camera Connect Main Window

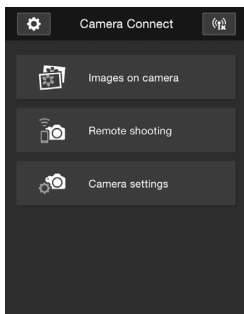

The main functions of Camera Connect are described below. Touch the screen to learn the operation procedures.

[Images on camera]

- Images stored in the camera can be viewed.
- Images stored in the camera can be saved on a smartphone.
- Operations such as deletion can be performed on images stored in the camera.

[Remote shooting]

- The camera's Live View image can be viewed using a smartphone.
- You can shoot using remote operation.

[Camera settings]

- Camera settings can be changed.

⚙️ (Settings button)

- Use this button to access various settings for Camera Connect.

Terminating the Connection

To terminate the connection, perform either of the following operations.

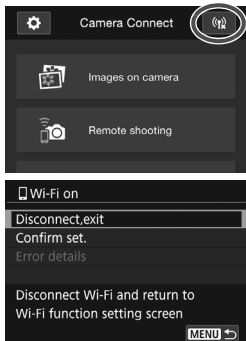

On the smartphone's Camera Connect screen, tap [Camera Connect icon].

On the camera's [Wi-Fi on] screen, select [Disconnect,exit].

- If the [Wi-Fi on] screen is not displayed, select the [1] tab → [Wireless communication settings] → [Wi-Fi function].
- Select [Disconnect,exit], then select [OK] on the confirmation dialog to terminate the connection.



- When the wireless connection is terminated while recording a movie with remote shooting, the camera responds as follows:
 - When the Live View shooting/Movie shooting switch is set to <📷>, movie shooting continues.
 - When the Live View shooting/Movie shooting switch is set to <📹>, movie shooting stops.
- When the Live View shooting/Movie shooting switch is set to <📹> and the movie mode is set by operating Camera Connect, you cannot shoot by operating the camera.
- When the camera is connected to a smartphone, the following operations cannot be performed:
 - Multiple exposures, video snapshot, time-lapse movie, Creative filters, RAW image processing, cropping, resize
- In remote shooting, the AF speed may become slower.
- Depending on the connection status, image display or shutter release may be delayed.
- While saving images to a smartphone, you cannot take a picture even if you press the camera's shutter button. Also, the camera's LCD monitor may turn off.
- Even if MOV-format movies are displayed in the list, they cannot be saved to a smartphone.



- The wireless connection will stop if you set the camera's power to <OFF> or open the card slot cover or battery compartment cover.
- When saving RAW images to a smartphone, they are saved as JPEG images.
- While connected, the camera's auto power off does not function.
- While connected, disabling the smartphone's power saving function is recommended.

Reconnecting

The camera can reconnect to a Wi-Fi function for which connection settings have been registered.

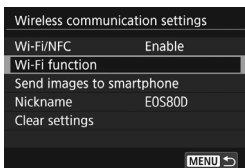

1 Select [Wi-Fi function].

- Set [Wi-Fi/NFC] to [Enable], then select [Wi-Fi function].

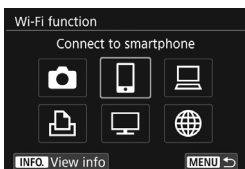

2 Select the Wi-Fi function to connect to.

- Press the <▲> <▼> or <◀> <▶> keys to select an item, then press <SET>.

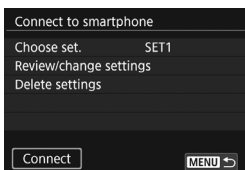

3 Select [Connect].

- When settings for multiple connection destinations are registered, select [Choose set.], select the connection destination, then connect to the destination.
- Select [OK] on the confirmation dialog.

4 Operate the target device.

- Activate the smartphone's Wi-Fi function, then start Camera Connect.
- If the smartphone's connection destination has been changed, restore the setting to connect to the camera or the same access point as the camera.



- If you do not know the SSID of the destination when reconnecting, select **[Review/change settings]** → **[Confirm set.]** in the screen for step 3 to check it.
- With NFC connection or when connecting by selecting **[Easy connection]**, “_Canon0A” is displayed at the end of the SSID.

Sending Images to a Smartphone

Operate the camera to send images to a smartphone. The following three send methods are available:

- (1) While playing back an image, connect to a smartphone using the NFC function (p.W-33).
- (2) During a wireless connection, select [**Send images to smartphone**] from the camera menu (p.W-34).
- (3) During a wireless connection, send images from the Quick Control screen during playback (p.W-35).

(1) Connecting with the NFC Function

While playing back an image on the camera, touch an NFC-enabled smartphone to the camera to send the image.

- If a connection has already been established wirelessly, terminate the connection and then play back an image on the camera.
- Set up the camera to allow use of its NFC function in advance (p.W-16).
- For the smartphone's Wi-Fi setting, NFC setting, and NFC antenna position, refer to the smartphone's instruction manual.

1 Enable the NFC function on the camera and smartphone (p.W-16).

2 Play back the image.

- Press the <▶> button to play back images.



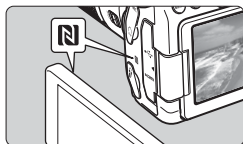

3 Touch a smartphone to the camera.

- Touch the **N** mark on the smartphone to that on the camera.
- When a message indicating the connection is displayed on the camera's LCD monitor, move the smartphone away.



4 Select the images to send.

- ▶ Select and send image(s). For information on how to send images, see page W-36.
- When the index display is selected in step 2, the multiple image selection screen will appear. See step 3 on page W-37.

(2) Selecting [Send images to smartphone]

While the camera is connected to a smartphone wirelessly, select **[Send images to smartphone]** in **[Wireless communication settings]** under the **[1]** tab and send.

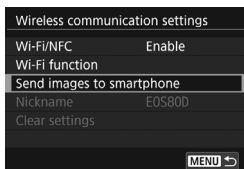

1 Connect the camera to a smartphone wirelessly.

2 Select [Send images to smartphone].

- Select **[Send images to smartphone]** on the **[Wireless communication settings]** screen, then press **<SET>**.



3 Select the images to send.

- ▶ Select and send image(s). For information on how to send images, see page W-36.

(3) Quick Control During Playback

While the camera is wirelessly connected to a smartphone, send images from the Quick Control screen during playback.



- 1 **Connect the camera to a smartphone wirelessly.**
- 2 **Play back the image and press the <Q> button.**



- 3 **Select [📱].**



- 4 **Select the images to send.**
 - ▶ Select and send image(s). For information on how to send images, see page W-36.

Sending Images Individually

Select and send images individually.



1 Select an image to send.

- Turn the  dial to select an image to send, then press **<SET>**.
- By pressing the **<[img icon] [img icon]>** button, you can switch to the index display and select an image.



2 Select [Send img shown].

- To select a size at which to send the image, select **[Resize image]** and press **<SET>**.
- Select **[Send img shown]** and press **<SET>** to send the image displayed.
- ▶ When the transfer is complete, the screen for step 1 will reappear.
- To send another image, repeat steps 1 and 2.

Sending Multiple Images

Select multiple images and send them at once.

If the multiple image selection screen is already displayed, start the operation from step 3.



1 Press **<SET>**.

2 Select [Send selected].

- To select a size at which to send the images, select **[Resize image]** and press **<SET>**.



3 Select the images to send.

- Turn the <ⓘ> dial to select an image to send, then add [✓]. Press <SET> to add or remove [✓].
- By pressing the <☒·Q> button, you can select images from a three-image display.
- After selecting the images to send, press the <Q> button.



4 Select [Resize image].

- Set it if necessary.
- On the displayed screen, select an image size, then press <SET>.

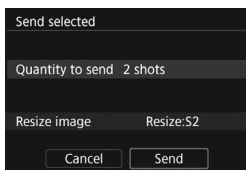
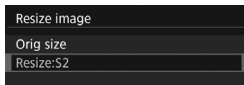
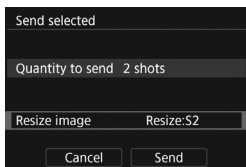

5 Select [Send].

- ▶ The selected images will be sent. When the transfer is complete, the screen for step 1 will reappear.
- To send other images, repeat steps 1 to 5.

Ending Image Transfer

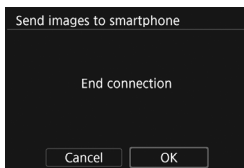

To end the image transfer, press the <MENU> button on the image transfer screen.

- If you have established the connection with the NFC function while playing back an image, the connection termination screen will appear. Select [OK] to terminate the connection.
- If you have sent images from the menu or Quick Control, the previous screen will reappear. The connection will not be terminated.



- **If necessary, also read “NFC Function Cautions” (p.W-17).**
- During the image transfer operation, a picture cannot be taken even if the camera's shutter button is pressed.
- Images cannot be sent using the NFC function while the camera is connected to another device wirelessly. In addition, the camera cannot be connected to multiple smartphones at the same time.
- Even if MOV-format movies are displayed in the list, they cannot be saved to a smartphone.



- You can cancel the image transfer by selecting [Cancel] during the transfer.
- You can select up to 50 files at a time.
- While connected, disabling the smartphone's power saving function is recommended.
- Settings for image transfer using the NFC function are not saved on the camera.
- When you reduce the image size, all images to be sent at the same time are resized. Movies, as well as still photos that are smaller than S2 size, are not reduced.
- When you use a battery to power the camera, make sure it is fully charged.
- While connected, the camera's auto power off does not function.

3

Easy Connection Between Cameras

This section explains how to connect this camera and other Canon cameras with built-in wireless functions easily.

- Wireless connection is possible for Canon cameras with built-in wireless functions released in and after 2012 supporting image transfer between cameras. Note that the camera cannot be connected to Canon camcorders, even if they have built-in wireless functions.
- The camera cannot be connected to Canon cameras without built-in wireless functions, even if they support Eye-Fi cards.
- Still photos can be transferred only if their file format is JPEG.
- For movies, a send error may occur or the sent movies may not be played back depending on the target camera's functionality and file format of the movies. (MP4-format movies cannot be sent to cameras that are not compatible with playback of MP4-format movies.)

Connecting to a Camera

Register the target camera to connect to wirelessly. The camera can be connected to only one camera at a time.

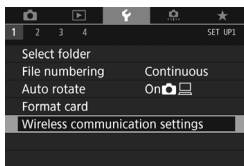

1 Select [Wireless communication settings].

- Under the [1] tab, select [Wireless communication settings], then press <SET>.

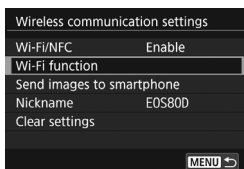

2 Select [Wi-Fi function].

- Set [Wi-Fi/NFC] to [Enable], then select [Wi-Fi function].

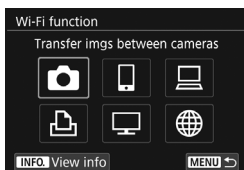

3 Select [📷] (Transfer imgs between cameras).

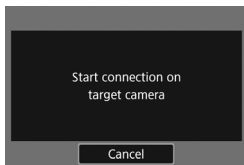

4 Start the connection on the target camera.

- When the screen on the left is displayed on the camera, start the connection on the target camera as well. For the operation procedure, refer to the instruction manual of the target camera.
- ▶ When a connection is established, an image on the card is displayed.



5 Select the images to send.

- Select images on the camera sending the images (p.W-42).
- Do not operate the camera receiving the images.

The settings for connecting to a camera are now complete.
For operations after setting up a connection, see page W-42.

 Note that GPS information is not displayed on the camera's playback screen even if GPS information is appended to the received image. Shooting locations can be viewed on a virtual map, using Map Utility (EOS software).

- 
- The connection settings are saved/registered with the nickname of the camera to which a connection was established.
 - While connected, the camera's auto power off does not function.

Sending Images to a Camera

Sending Images Individually

Select and send images individually.



1 Select an image to send.

- Turn the \odot dial to select an image to send, then press $\langle \text{SET} \rangle$.
- By pressing the $\langle \text{Q} \rangle$ button, you can switch to the index display and select an image.



2 Select [Send img shown].

- To select a size at which to send the image, select **[Resize image]** and press $\langle \text{SET} \rangle$.
- Select **[Send img shown]** and press $\langle \text{SET} \rangle$ to send the image displayed.
- ▶ When the transfer is complete, the screen for step 1 will reappear.
- To send another image, repeat steps 1 and 2.



3 Terminate the connection.

- Press the $\langle \text{MENU} \rangle$ button to display the confirmation dialog. Select **[OK]**, then press $\langle \text{SET} \rangle$ to terminate the connection.
- ▶ The **[Wi-Fi function]** screen will reappear.

Sending Multiple Images

Select multiple images and send them at once.



1 Press **<SET>**.

2 Select **[Send selected]**.

- To select a size at which to send the images, select **[Resize image]** and press **<SET>**.



3 Select the images to send.

- Turn the **<DISP>** dial to select an image to send, then add **[✓]**. Press **<SET>** to add or remove **[✓]**.
- By pressing the **<DISP>** button, you can select images from a three-image display.
- After selecting the images to send, press the **<Q>** button.

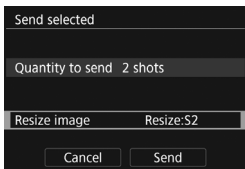

4 Select **[Resize image]**.

- Set it if necessary.
- On the displayed screen, select an image size, then press **<SET>**.

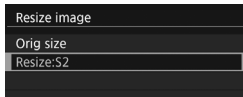

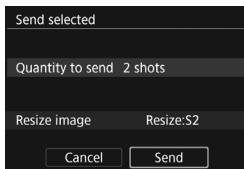

5 Select [Send].

- ▶ The selected images will be sent. When the transfer is complete, the screen for step 1 will reappear.
- To send other images, repeat steps 1 to 5.



6 Terminate the connection.

- Press the <MENU> button to display the confirmation dialog. Select [OK], then press <SET> to terminate the connection.
- ▶ The [Wi-Fi function] screen will reappear.

- While connected, a picture cannot be taken even if the camera's shutter button is pressed. When you want to terminate the connection to shoot or perform other operations, press the <MENU> button, then terminate the connection on the displayed screen. To terminate the connection during image transfer, select [Cancel] on the camera, then terminate the connection.
- When sending a large number of images or large files (total size), make sure that the battery is adequately charged so it does not run out during the process.
- Depending on the functionality of the target camera, the movie files will be converted when they are sent. Therefore, transfer may take longer than usual.
- RAW images cannot be sent.

- You can select up to 50 files at a time.
- When you reduce the image size, all images to be sent at the same time are resized. Movies, as well as still photos that are smaller than S2 size, are not reduced.
- [Resize:S2] is enabled only for still photos shot with cameras of the same model as this camera. Still photos shot with other models are sent without resizing.
- You can cancel the image transfer by selecting [Cancel] during the transfer. When [Cancel] is selected on the camera sending the images, the image selection screen will reappear. When [Cancel] is selected on the camera receiving the images, the connection will be terminated.
- While connected, the camera's auto power off does not function.

Reconnecting

The camera can reconnect to a Wi-Fi function for which connection settings have been registered.

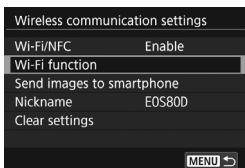

1 Select [Wi-Fi function].

- Set [Wi-Fi/NFC] to [Enable], then select [Wi-Fi function].

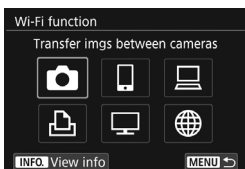

2 Select the Wi-Fi function to connect to.

- Press the <▲> <▼> or <◀> <▶> keys to select an item, then press <SET>.

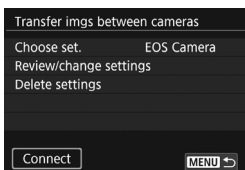

3 Select [Connect].

- When settings for multiple connection destinations are registered, select [Choose set.], select the connection destination, then connect to the destination.
- Select [OK] on the confirmation dialog.

4 Operate the target device.

- Perform the reconnection procedure on the target camera as well.
- By default, settings are named after the nickname of the camera that was connected to.

4

Easy Connection to Connect Station

Connect Station (sold separately) is a device that allows you to import captured still photos and movies for viewing on your TV set, smartphone, etc., or sharing them over a network.

You can easily save still photos and movies to Connect Station by holding this camera close to Connect Station.

Saving Images

This section explains how to connect the camera and Connect Station (sold separately) wirelessly. To save images in other ways, refer to the Connect Station Instruction Manual.

- Set up the camera to allow use of its NFC function in advance (p.W-16).

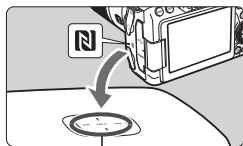

NFC connect point

1 Enable the NFC function on the camera (p.W-16).

2 Hold the camera close to Connect Station.

- Turn on the camera and Connect Station, then hold the camera's **N** mark close to the Connect Station's NFC connect point.
- ▶ When a message indicating the connection is displayed on the camera's LCD monitor and Connect Station responds, move the camera away from Connect Station.
- When a connection is established, Connect Station checks the images on the memory card, then saves only the unsaved images.

3 Terminate the connection.

- After images are saved, the screen on the left will appear on the camera's LCD monitor. Press **<SET>** to terminate the connection.

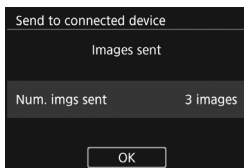



- **If necessary, also read “NFC Function Cautions” (p.W-17).**
- While saving images, a picture cannot be taken even if the camera's shutter button is pressed.
- Do not drop the camera on Connect Station or touch the camera to it with too much force. Doing so may damage Connect Station's internal hard disk.
- If the camera is not recognized right away, try holding it close to Connect Station and slowly moving it or rotating it horizontally.
- Just holding the camera close to Connect Station may not establish a connection. In such a case, gently touch Connect Station with the camera.
- When holding the camera close to Connect Station, do not leave anything between the camera and Connect Station. In addition, when a case is attached to the camera, communication may not be possible via NFC function.
- If the camera and Connect Station are moved too far away from each other while saving images, saving may take time or the connection may be terminated.
- If the camera's battery runs out while saving images, saving will stop. Charge the battery, then try again.



- When all images are already saved, saving will not be performed. In such a case, select **[OK]** to terminate the connection.
- When there are a large number of images on the memory card, it may take time to check and save the images.
- While saving images, the camera's auto power off does not function.

Wi-Fi (Wireless LAN) Precautions

■ Countries and Regions Permitting Wireless LAN Use

Use of wireless LAN is restricted in some countries and regions, and illegal use may be punishable under national or local regulations. To avoid violating wireless LAN regulations, visit the Canon website to check where use is allowed.

Note that Canon cannot be held liable for any problems arising from wireless LAN use in other countries and regions.

■ Model Number

EOS 80D (W): DS126591 (including WLAN module model: ES200)

Complies with
IDA Standards
DB00671

Hereby, Canon Inc., declares that this DS126591 is in compliance with the essential requirements and other relevant provisions of Directive 1999/5/EC.

Please contact the following address for the original Declaration of Conformity:

CANON EUROPA N.V.

Bovenkerkerweg 59, 1185 XB Amstelveen, The Netherlands

CANON INC.

30-2, Shimomaruko 3-chome, Ohta-ku, Tokyo 146-8501, Japan



Trademarks

- Microsoft and Windows are trademarks or registered trademarks of Microsoft Corporation in the United States and/or other countries.
- Macintosh and Mac OS are trademarks of Apple Inc., registered in the U.S. and other countries.
- The Wi-Fi CERTIFIED logo and the Wi-Fi Protected Setup mark are trademarks of the Wi-Fi Alliance.
- WPS used on camera settings screens and in this manual stands for Wi-Fi Protected Setup.
- UPnP is a trademark of the UPnP Implementers Corporation.
- The N-Mark is a trademark or registered trademark of NFC Forum, Inc. in the United States and in other countries.
- All other trademarks are the property of their respective owners.

Index

A
Android W-18

C
Cable W-14
Camera Connect..... W-18, W-28
Connect Station W-47
Connecting to a smartphone..... W-19

E
Eye-Fi Card..... W-14

I
iOS..... W-18

K
Keyboard W-10

N
NFC W-16, W-20, W-21, W-48
 Sending images..... W-33
Nickname..... W-8

Q
Quick Control..... W-35

R
Reconnecting..... W-31, W-45
Reducing the image size ...W-37, W-43
Remote operation W-28

S
Sending images W-33, W-42

T
Touch Control..... W-11

Transferring images
between cameras..... W-39

V
Viewing images W-28















CANON INC.

30-2 Shimomaruko 3-chome, Ohta-ku, Tokyo 146-8501, Japan

Europe, Africa & Middle East

CANON EUROPA N.V.

PO Box 2262, 1180 EG Amstelveen, The Netherlands

For your local Canon office, please refer to your warranty card or to www.canon-europe.com/Support

The product and associated warranty are provided in European countries by Canon Europa N.V.

The descriptions in this Instruction Manual are current as of February 2016. For information on the compatibility with any products introduced after this date, contact any Canon Service Center. For the latest version Instruction Manual, refer to the Canon website.