

# PowerLite® 822+/83+

## Quick Setup



**EPSON**<sup>®</sup>  
EXCEED YOUR VISION



# 1 *Unpack the projector*

You should have the following items:

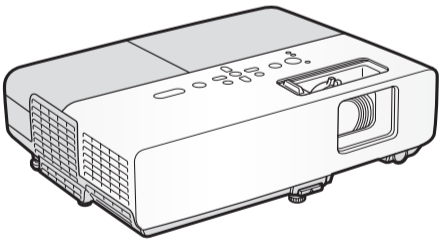

Projector

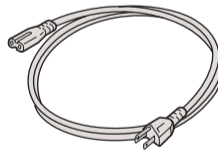

Power cord

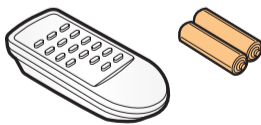

Remote control  
and batteries

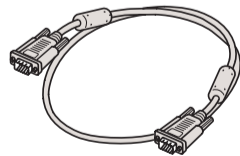

Computer cable



User's Guide  
CD-ROM



Password Protected  
sticker



\*411363600\*

## 2 Connect your video source

Connect the projector to a computer or video source using any of the available connections shown below.

- Check the connectors on your video equipment. If more than one connection is available, choose the one that provides the best quality. The projector connectors from highest to lowest quality are Computer (Component Video), S-Video, and Video.
- A computer cable is included. You can purchase optional video and audio cables through Epson or an electronics store.
- You can connect up to 4 video devices and use the remote control to switch between them.

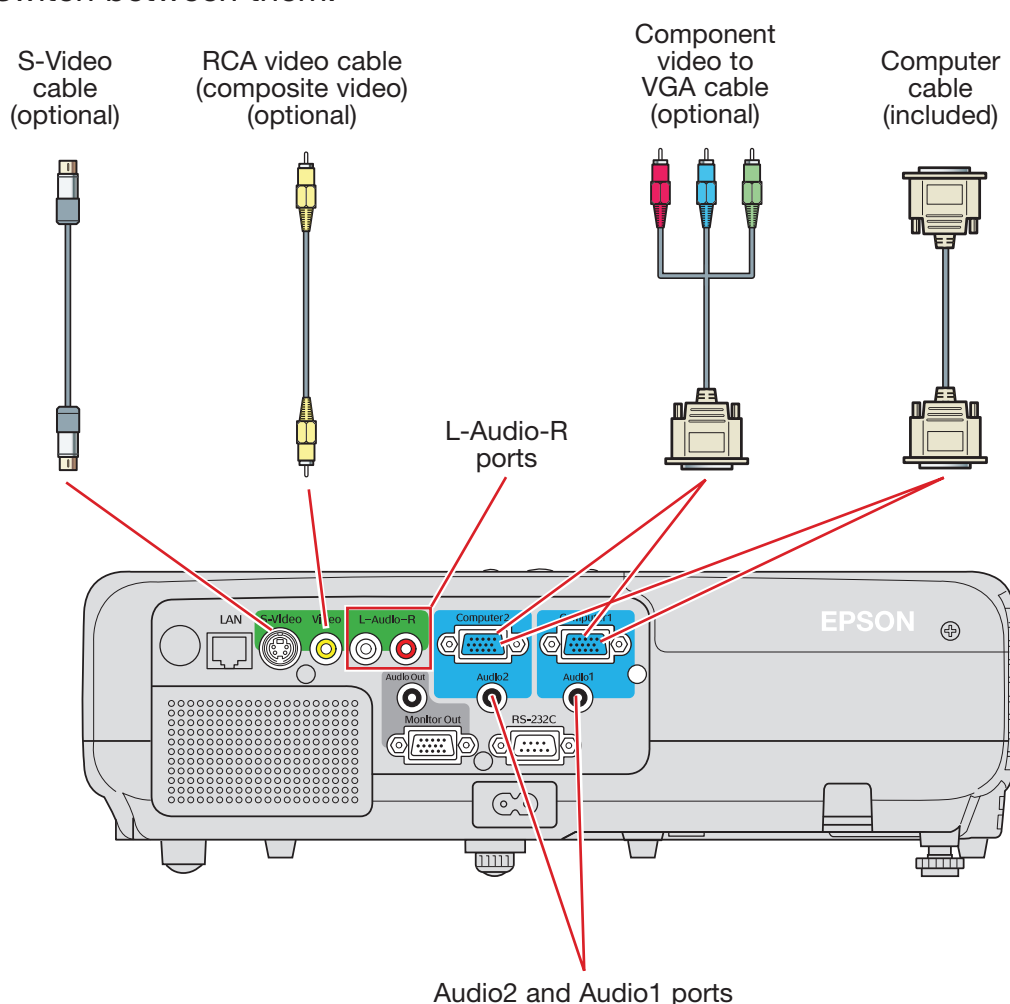

### NOTE

You can also connect an external monitor to watch the display on your computer monitor while watching the projection screen (when the computer cable is connected to the Computer1 port). To enhance the sound in your presentation, you can connect external speakers. See the *User's Guide* on your CD-ROM for instructions.

## 3 Set up the remote control

- 1 Remove the battery cover.
- 2 Insert the batteries.
- 3 Replace the battery cover.

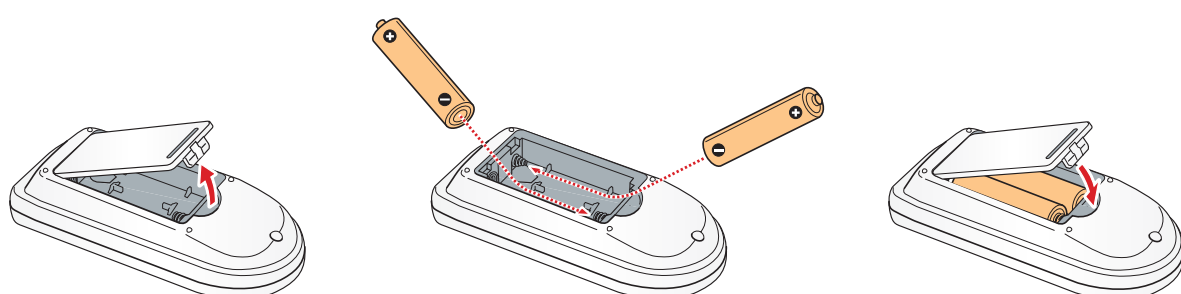

The remote control is ready for use.

# Choose a location

The projector supports 4 viewing setups. Choose the best one for your environment. If you install the projector in a rear or overhead position, you'll need to choose the correct projection option, identified below, from the **Extended** menu. See the *User's Guide* on your CD-ROM for instructions.

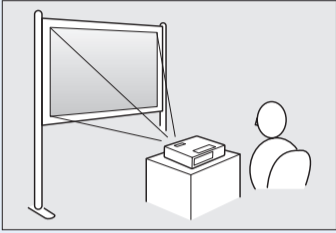

## Table

Convenient for temporary front projection. Choose **Front** from the menu.

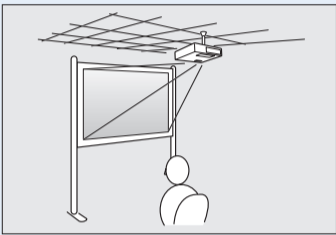

## Ceiling

Professional installation recommended. Choose **Front/Ceiling** from the menu.

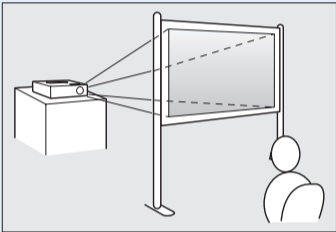

## Rear

For installation behind a translucent screen. Choose **Rear** from the menu.

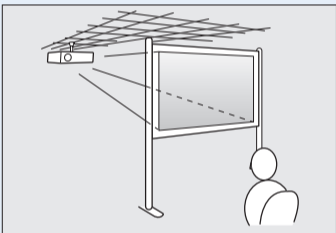

## Rear/Ceiling

Professional installation recommended. Choose **Rear/Ceiling** from the menu.

The distance between the projector and the screen determines the size of the image. The diagram below shows approximately how big your image will be (diagonally), based on where you set up the projector. (For more help determining the size of your image, try the Image Size Calculator on the Multimedia Projectors page on Epson's website.)

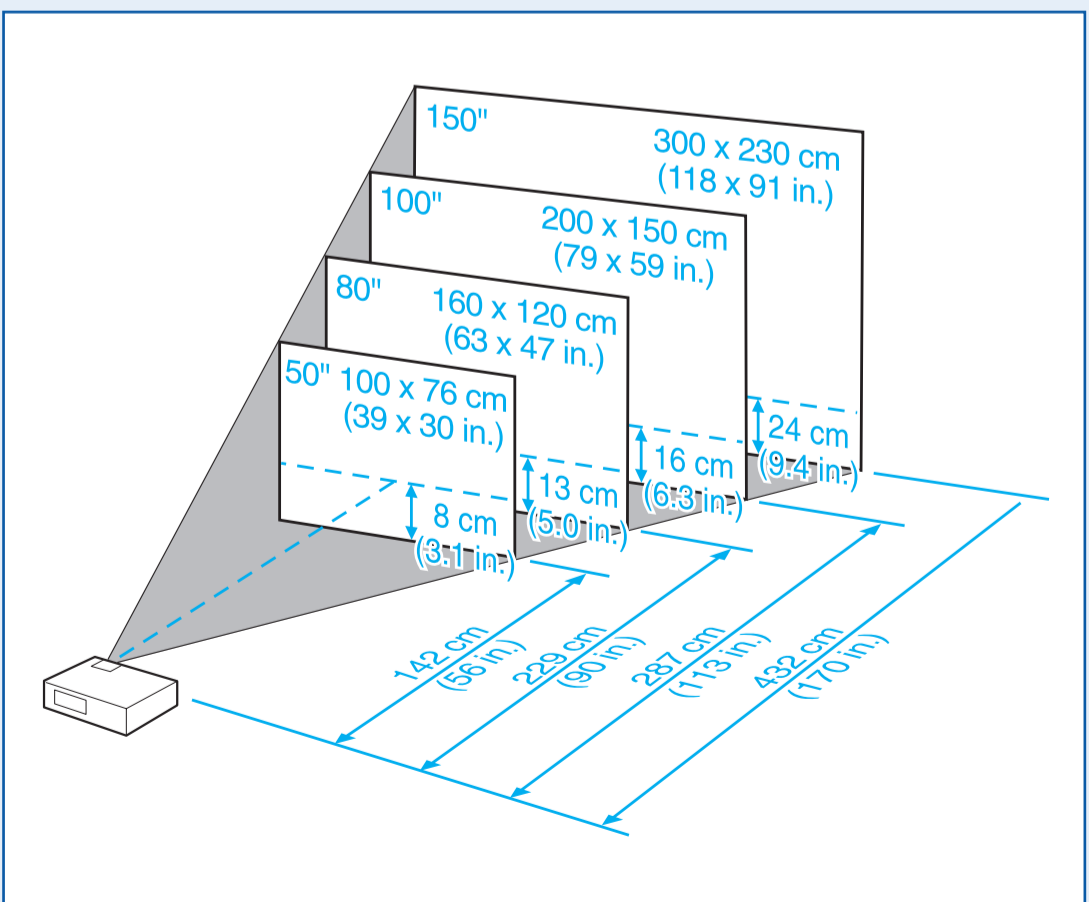

Turn over



# 4 Plug in and turn on

- 1 Open the **AV Mute** slide (lens cover).

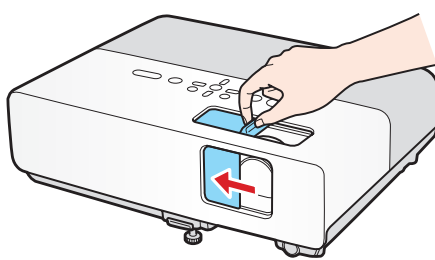

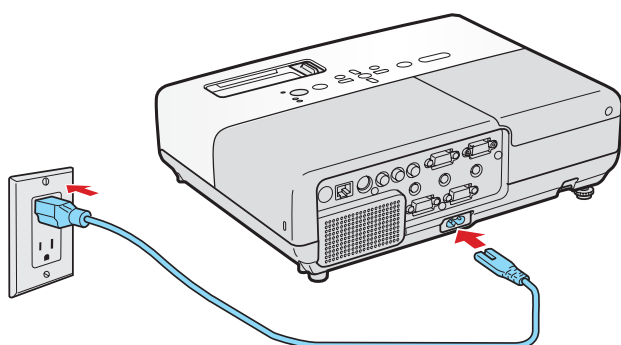

- 2 Connect the power cord to the projector and plug the other end into an electrical outlet.

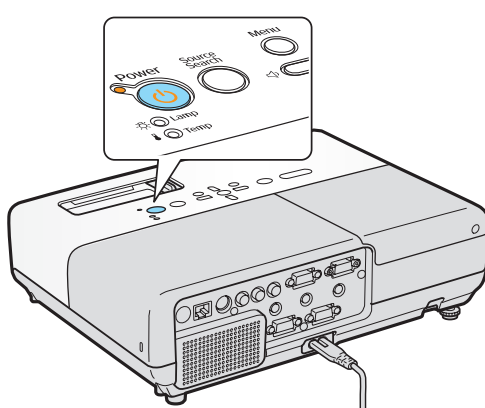

The  **Power** light on the projector turns orange.



- 3 Turn on your computer or video source.

- 4 Press the  **Power** button on the projector or remote control. The projector beeps, the  **Power** light flashes green, and the projector lamp comes on in about 5 seconds. The  **Power** light stays green.

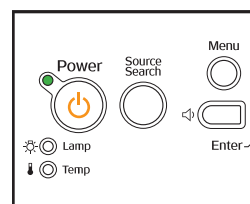

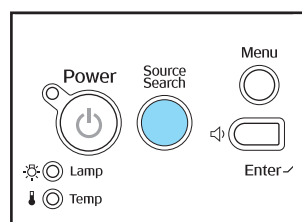
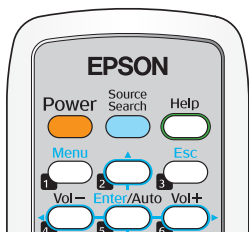

- 5 Start your video or presentation. If you have connected more than one video source, use the **Source Search** button on the projector or remote control to select the one you want to watch.



**If your image does not appear on the screen, see the [Troubleshooting](#) section for help.**

## Turning off the projector

- 1 If you're using a computer, shut it down first, while you can still see the display.
- 2 Press the  **Power** button on the projector or remote control.
- 3 When you see the confirmation message, press the  **Power** button again. The projector beeps twice and the  **Power** light turns orange.

With Epson's Instant Off<sup>®</sup> technology, there's no cool-down period. When you're done, just unplug the projector and it's ready to travel.



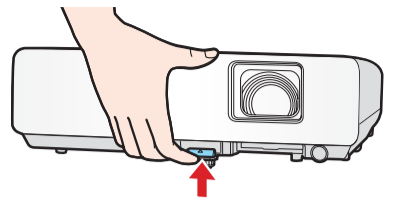

# 5 Adjust the image

- 1 To raise the image, stand behind the projector, then press the foot release lever and lift the front of the projector. Release the lever to lock the foot in the position you want.

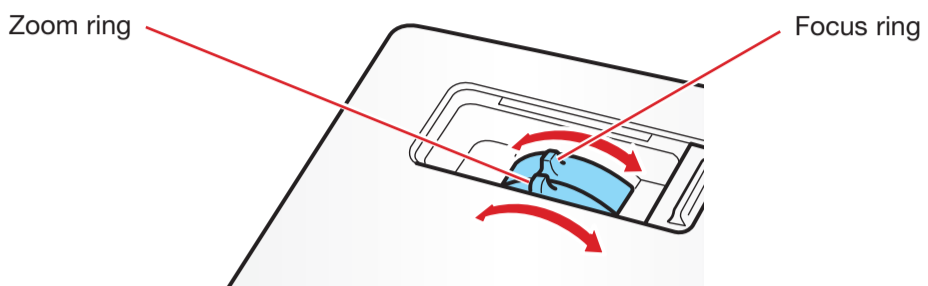

- 2 Rotate the focus ring to sharpen the image, and the zoom ring to enlarge or reduce it.



- 3 If your image looks like  or , first make sure the projector is facing the screen squarely. Then, if necessary, press the  or  buttons on the projector's control panel until the image is corrected.
- 4 To select the best color mode, press the **Color Mode** button on the remote control repeatedly to move through the options.

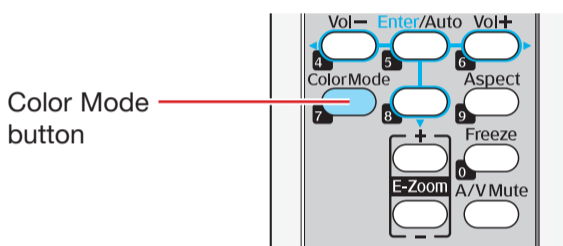

See your *User's Guide* on the CD-ROM for more information about image adjustments.

# 6 Install your User's Guide and register your projector

- 1 Insert the PowerLite Projector CD-ROM in your drive. If the installer doesn't open automatically, double-click the **Epson** CD-ROM icon, then double-click the **Epson** installer icon.
- 2 Choose your projector, then follow the instructions on the screen to register.



You can also register at [www.epson.com/webreg](http://www.epson.com/webreg).

- 3 After you register the projector, click **User's Guide** to install it. (If you don't already have Adobe® Reader®, click **Adobe Reader** and follow the on-screen instructions to install it.)
- 4 When you're done, click **Exit**.

To open your *User's Guide*, double-click the **PL 822+ 83+ User's Guide** icon on your desktop.

# Where to get help

## Internet support

Visit Epson's support website at [epson.com/support](http://epson.com/support) and select your product for solutions to common problems. You can download utilities and documentation, get FAQs and troubleshooting advice, or e-mail Epson with your questions.

Visit <http://www.presentersonline.com> to access tips, templates, and training for developing successful presentations.

## Speak to a support representative

To use the Epson PrivateLine® Support service, call (800) 637-7661 and enter the PIN on the included Epson PrivateLine Support card. This service is available 6 AM to 6 PM, Pacific Time, Monday through Friday, for the duration of your warranty period. You may also speak with a projector support specialist by dialing one of the following numbers. (Days and hours of support are subject to change without notice. Toll or long distance charges may apply.)

**U.S.:** (562) 276-4394, 6 AM to 6 PM, Pacific Time, Monday-Friday

**Canada:** (905) 709-3839, 6 AM to 6 PM, Pacific Time, Monday-Friday

## Purchase supplies and accessories

You can purchase screens, carrying cases, and other accessories from an Epson authorized reseller. To find the nearest reseller, call 800-GO-EPSON (800-463-7766). Or you can purchase online at [www.epsonstore.com](http://www.epsonstore.com) (U.S. sales) or [www.epson.ca](http://www.epson.ca) (Canadian sales).

# Troubleshooting



## If you see a blank screen

If you see a blank screen or the **No signal** message after turning on your computer or video source, check the following:

- Make sure the **Power** light on the projector is green and not flashing and the **AV Mute** slide (lens cover) is open.
- Make sure the cables are connected correctly. (See the *User's Guide* for more information.)
- If you've connected more than one video source, you may need to press the **Source Search** button on the projector or the remote control to select the one you want to watch. (Allow a few seconds for the projector to sync up after pressing it.)

## If the projector and the notebook don't display the same image

### If you're using a Windows® notebook:

- Hold down the **Fn** key and press the function key (such as  or **CRT/LCD**) that lets you display on an external monitor. On most systems, the  or **CRT/LCD** key lets you toggle between the LCD screen and the projector, or display on both at the same time.
- Check your monitor settings to make sure both the LCD screen and the external monitor port are enabled. From the Control Panel, open the **Display** utility. Click the **Settings** tab, then click **Advanced**. The method for adjusting the settings varies by brand; you may need to click a Monitor tab, then make sure the external Monitor port is set as your primary display and/or enabled. See your computer's documentation or online help for details.

### If you're using a Macintosh® notebook with OS X:

- 1 From the Apple® menu, select **System Preferences**, then click **Display** or **Displays**.
- 2 Select **VGA Display** or **Color LCD**, click **Arrangement** or **Arrange**, and make sure **Mirror Displays** is checked.

