

RICOH



PJ WX5140/PJ WX5150

User's Manual

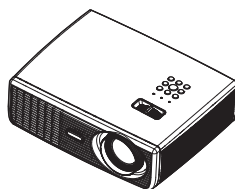

Table of Contents

Table of Contents	1	<i>Default Settings 2</i>	39
Usage Notice	2	<i>Default Settings 2 3D Projection</i>	42
<i>Precautions</i>	2	<i>Default Settings 2 Network Setting</i>	43
<i>Safety Labels of This Machine</i>	6	<i>Display Status</i>	44
<i>Regulation & Safety Notices</i>	7	Controls via Network	45
<i>Other Information</i>	13	Troubleshooting	47
Introduction	14	Replacing the lamp	52
<i>Product Features</i>	14	Appendices	53
<i>Package Overview</i>	15	<i>List of Compatible Signals</i>	53
<i>Product Overview</i>	16	<i>Configurations of Terminals</i>	56
<i>Connection Ports</i>	17	<i>Terminal: Computer in 1/2</i>	
<i>Control Panel</i>	18	<i>(Mini D-sub 15 pin)</i>	56
<i>Remote Control</i>	19	<i>Terminal: PC Control (D-sub 9 pin)</i>	56
<i>Remote Control Battery Installation</i>	21	Specifications	57
<i>Remote Control Operating Range</i>	21	Trademarks	58
Basic Operations	22		
<i>Connecting the Projector</i>	22		
<i>Connect to Computer/Notebook</i>	22		
<i>Connect to AV Equipment</i>	23		
<i>Powering On/Off the Projector</i>	24		
<i>Powering On the Projector</i>	24		
<i>Powering Off the Projector</i>	25		
<i>Warning Indicator</i>	26		
<i>Adjusting the Projected Image</i>	27		
<i>Adjusting the Position of Projector</i>			
<i>Image</i>	27		
<i>Adjusting the Projector Zoom and</i>			
<i>Focus</i>	28		
<i>Adjusting Projection Image Size</i>	28		
User Settings	30		
<i>Using the On Screen Display (OSD)</i> 30			
<i>How to operate</i>	30		
<i>Image Adjustment</i>	31		
<i>Image Adjustment Position</i>	33		
<i>Display Settings</i>	34		
<i>Default Settings 1</i>	37		

Usage Notice

Precautions



Follow all warnings, precautions and maintenance as recommended in this user's guide to maximize the life of your unit.

- Warning- This apparatus must be earthed.
- Warning- Do not look into the projector's lens when the lamp is on. The bright light may hurt your eyes.
- Warning- To reduce the risk of fire or electric shock, do not expose this projector to rain or moisture.
- Warning- Please do not open or disassemble the projector as this may cause electric shock.
- Warning- When replacing the lamp, please allow unit to cool down, and follow all replacement instructions..
- Warning- When the lamp reaches the end of its life, it will burn out and may make a loud popping sound. If this happens, the projector will not turn back on until the lamp module has been replaced. To replace the lamp, follow the procedures listed under "Replacing the Lamp".
- Warning- Do not remove the cabinet cover, or you may be exposed to dangerous voltage. Refer servicing to qualified service personnel only.
- Warning- This product should be operated only from the type of power source which does not exceed the voltage range specified on the rating label and the power cord. If you are not sure of the type of power supply to your home, consult your sales representative or local power company.
- Warning- Do not use the polarized plug with an extension cord , receptacle, or other outlet unless the blades can be inserted completely with three wire grounding type to prevent blade exposure. Failure to follow these instructions may result in fire or electric shock.

Usage Notice

- Caution- Never operate this unit on AC power during a thunderstorm. If you see lightning or hear thunder, never touch the unit, cables and/or peripherals. An electric surge caused by the storm, may result in an electrical shock or damage to the unit.
- Caution- Never push objects of any kind into this product through openings as they may touch dangerous voltage points or short-out parts that could result in a fire or electric shock. Never spill liquid of any kind on the product.
- Caution- Do not place or keep the projector within the reach of the children. It may fall or tip over, possibly causing serious injury.
- Caution- Do not stack other equipment on this product and do not place this product on other equipment. The top and bottom surface of this product increase in temperature during normal use and may damage the other unit.
- Caution- Do not use attachments not recommended by the product manufacturer. Use of an incompatible attachments could cause hazards or damage to the product.
- Caution- Do not place this product on an unstable cart, stand, tripod, bracket, or table. The product may fall, causing serious injury to a child or adult, and serious damage to the product.
- Caution- Unplug this product from the wall outlet and take the product to qualified service personnel if you encounter any of the following conditions:
 - a) The power supply cord or plug is damaged.
 - b) Liquid has been spilled, or objects have fallen into the product.
 - c) The product has been exposed to rain or water.
 - d) The product does not operate normally when following the operating instructions. Adjust only those controls that are covered by the operating instructions.
 - e) The product has been dropped or damaged in any way. (If the cabinet should break, please handle with care to avoid injury.)

Usage Notice

- Caution- This product incorporates glass components, including a lens and a lamp. If these should break, please handle with care to avoid injury and contact your sales representative for repair service. Avoid any broken pieces of glass since they may cause injury. In the unlikely event that the lamp ruptures, thoroughly clean the area around the projector and discard any edible items placed in that area since they may be contaminated.
- Caution- Do not place anything in front of the lens while the projector is operating. Things placed in front of the lens may overheat and burn or start a fire.
- Caution- Do not use lens cap when projector is powered on.
- Caution- Unauthorized substitutions may result in fire, electric shock, or other hazards. (Only the replacement of the lamp should be made by users.)
- Caution- Upon completion of any service or repairs to this product, ask the service technician to perform safety checks to verify that the product is in proper operating condition.
- Caution- Do not leave thermal paper documents or easily deformed items on top of the unit or near the air exhaust for long periods of time.
- Caution- The heat from the unit could erase the information on the thermal paper, or cause deformation or warping.
- Caution- This projector will detect the life of the lamp itself. Please be sure to change the lamp when it shows warning messages.
- Caution- Do not use the product in a closed installation location. Do not place the product in a box or in any other closed installation location. Otherwise it may overheat, which could result in a risk of fire.

Usage Notice

Do:

- After unpacking this product, read the manual carefully, and follow all the operating and other instructions.
- Turn off the product before cleaning.
- Use a soft cloth moistened with mild detergent to clean the display housing.
- Disconnect the power plug from AC outlet if the product is not being used for a long period of time.

Do not:

- Block the slots and openings on the unit provided for ventilation.
- Use abrasive cleaners, waxes or solvents to clean the unit.
- Use under the following conditions:
 - Extremely heat, cold or humidity.
 - In areas susceptible to excessive dust and dirt.
 - Near any appliance generating a strong magnetic field.
 - In direct sunlight.

Important:

Contents of this manual are subject to change without prior notice. In no event will the company be liable for direct, indirect, special, incidental, or consequential damages as a result of handling or operating this product.

Usage Notice

Safety Labels of This Machine

- 1 Do not block the air intake or exhaust. Doing so could cause a fire due to internal overheating. Do not place your hands, face, or other objects near the air exhaust, the lamp cover or the bottom of the unit. Doing so could result in injury and/or damage the object.
- 2 Do not look into the lens while the lamp is on. The strong light from the lamp may cause damage to your eyesight.
- 3 Do not place anything in front of the lens while the projector is operating. Things placed in front of the lens may overheat and burn or start a fire. If you want to temporarily stop the projected image, use the AV mute on the remote control or the keypad.
- 4 To replace the lamp, first unplug the power cord then wait for more than 1 hour. The lamp might be broken. Be careful of pieces of broken glass.
- 5 Do not remove any screws except the lamp cover screws. Do not block or cover the vents.

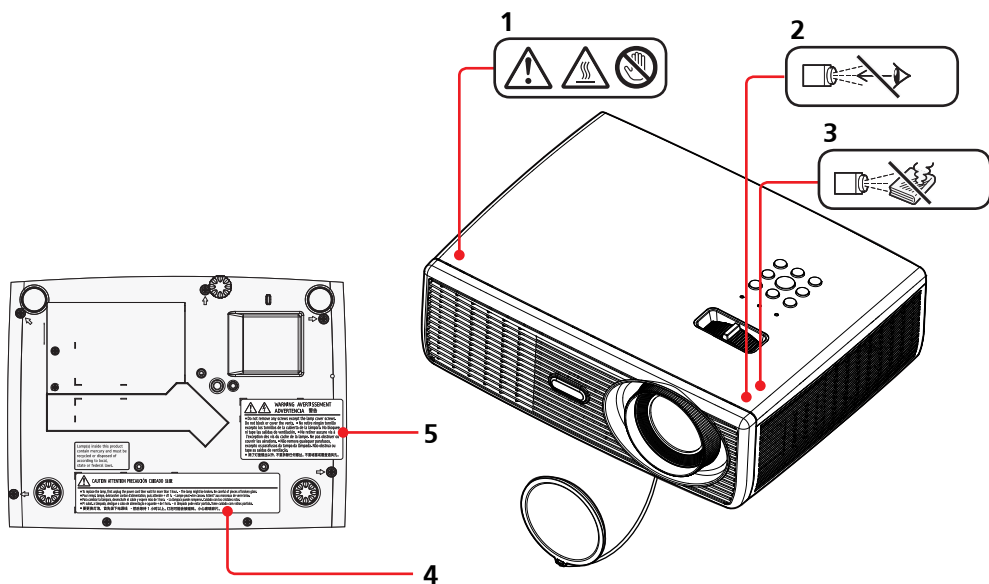

Usage Notice

Regulation & Safety Notices

This appendix lists the general notices of your Projector.

Notice: Users in the United States of America

FCC notice

MODEL NAME: PJ WX5140 / PJ WX5150

TRADE NAME: PROJECTOR
MODEL NAME: PJ WX5140 / PJ WX5150
FC Tested To Comply
With FCC Standards
FOR HOME OR OFFICE USE

This device complies with Part 15 of the FCC Rules. Operation is subject to the following two conditions:

1. This device may not cause harmful interference and
2. This device must accept any interference received, including interference that may cause undesired operation.

This device has been tested and found to comply with the limits for a Class B digital device pursuant to Part 15 of the FCC rules. These limits are designed to provide reasonable protection against harmful interference in a residential installation. This device generates, uses and can radiate radio frequency energy and, if not installed and used in accordance with the instructions, may cause harmful interference to radio communications.



Warning: this product contains a chemical known to the state of California to cause cancer, birth defects or other reproductive harm.

However, there is no guarantee that interference will not occur in a particular installation. If this device does cause harmful interference to radio or television reception, which can be determined by turning the device off and on, the user is encouraged to try to correct the interference by one or more of the following measures:

- Reorient or relocate the receiving antenna.
- Increase the separation between the device and receiver.
- Connect the device into an outlet on a circuit different from that to which the receiver is connected.
- Consult the dealer or an experienced radio/television technician for help.

Usage Notice

RESPONSIBLE PARTY: Ricoh Americas Corporation
5 Dedrick Place, West Caldwell, NJ 07006
Phone: 973-882-2000

Notice: Shielded cables

All connections to other computing devices must be made using shielded cables to maintain compliance with FCC regulations.

Caution

Changes or modifications not expressly approved by the manufacturer could void the user's authority, which is granted by the Federal Communications Commission, to operate this projector.

LAMP(S) INSIDE THIS PRODUCT CONTAIN MERCURY AND MUST BE RECYCLED OR DISPOSED OF ACCORDING TO LOCAL, STATE OR FEDERAL LAWS.

Notice: Canadian users

This Class B digital apparatus complies with Canadian ICES-003.

Remarque à l'intention des utilisateurs canadiens

Cet appareil numérique de la classe B est conforme à la norme NMB-003 du Canada.

Declaration of Conformity for EU countries

- EMC Directive 2004/108/EC (including amendments)
- Low Voltage Directive 2006/95/EC

Usage Notice

CE Marking Traceability Information (For EU Countries Only)

Manufacturer:

Ricoh Co., Ltd.

3-6 Nakamagome 1-chome, Ohta-ku, Tokyo. 143-8555, Japan

Authorized representative:

Ricoh Europe PLC

20 Triton Street, London. NW1 3BF, United Kingdom

Overseas Affiliates and Noise Emission Information

In accordance with TUV "GS Symbol" requirements, details of the EU office or representative company are given below.

Overseas Affiliates

Ricoh Europe PLC

20 Triton Street, London. NW1 3BF, United Kingdom

Noise Emission

Maschinenlärminformations-Verordnung 3. GPSGV:

Der höchste Schalldruckpegel beträgt 70 dB(A) oder weniger gemäss EN ISO 7779

User Information on Electrical and Electronic Equipment

Users in the countries where this symbol shown in this section has been specified in national law on collection and treatment of E-waste.

Our Products contain high quality components and are designed to facilitate recycling. Our products or product packaging are marked with the symbol below.



This product contains substances which are harmful to humans and the environment.

- The lamp contains mercury.

Please dispose of this product or used lamps in accordance with local regulations.

The symbol indicates that the product must not be treated as municipal waste. It must be disposed of separately via the appropriate return and collection systems available. By following these instructions you ensure that this product is treated correctly and help to

Usage Notice

reduce potential impacts on the environment and human health, which could otherwise result from inappropriate handling. Recycling of products helps to conserve natural resources and protect the environment.

For more detailed information on collection and recycling systems for this product, please contact the shop where you purchased it, your local dealer or sales/service representatives.

All Other Users

If you wish to discard this product, please contact your local authorities, the shop where you bought this product, your local dealer or sales/service representatives.

Notice: Users in Turkey

EEE Yönetmeliğine Uygundur.

Bu sistem sarf malzemeleri ve yedek parçaları da dahil olmak üzere EEE Yönetmeliğine Uygundur.

REMOTE CONTROL BATTERIES

Warning

- Never throw batteries into a fire.

Using the batteries improperly may cause them to explode or leak and may result in serious injury. If battery-leaking fluid contacts skin, wash the fluid off immediately with clean water and consult a doctor. If the fluid spills on an instrument, avoid contact and wipe it off using tissue paper. Then dispose of the used tissue paper as flammable garbage after moistening the tissue with water.

Notes

- Be sure to use AAA (R03) size batteries.
- Dispose of batteries in a designated disposal area.
- Attention should be drawn to the environmental aspects of battery disposal.
- Do not mix different battery types or combine used batteries with new ones.
- If the remote control does not operate correctly, or if the operating range becomes reduced, replace both batteries with new ones.
- If the batteries are dead or if you will not be using the remote control for a long time, remove the batteries to prevent battery acid from leaking into the battery compartment.

Usage Notice

Following information is only for EU-member states:

[Disposal of batteries and/or accumulators]

The crossed out wheeled dust bin symbol indicates that batteries and/or accumulators must be collected and disposed of separately from household waste.

If the battery or accumulator contains more than the specified values of lead (Pb), mercury (Hg), and/or cadmium (Cd) defined in the Battery Directive (2006/66/EC), then the chemical symbols for lead (Pb), mercury (Hg) and/or cadmium (Cd) will appear below the crossed out wheeled dust bin symbol.

By participating in separate collection of batteries, you will help to assure the proper disposal of products and batteries and thus help to prevent potential negative consequences for the environment and human health.

For more detailed information about the collection and recycling programmes available in your country, please contact your local city office or the shop where you purchased the product.



Other Information

Copyrights to Images

When projecting images using the projector, be careful not to infringe the copyright of protected materials.

The following are examples that may infringe the copyright of protected materials.

- Broadcasting images or movies for commercial purposes
- Modifying images or movies using functions such as freeze, magnify, or zoom to broadcast images for commercial purposes or public viewing
- Varying the aspect ratio of images or movies using a function that changes the screen size to broadcast images for commercial purposes or public viewing

Note to Users Viewing 3D Images

Pay attention to the following points when viewing images using 3D glasses with projector:

- How 3D images are viewed may vary according to the individual.
- Do not use 3D glasses for viewing any material other than 3D images.
- Before viewing 3D images, make sure to read the manuals provided with your 3D glasses and 3D compatible content.
- Avoid viewing 3D images for a long period of time. Take a break of 15 minutes or longer after every hour of viewing.
- If you feel sick while viewing 3D images, stop viewing them. If you continue to feel sick, consult a doctor.
- When viewing 3D image in a room where on LED lighting system or fluorescent lights are used, you may feel that the light in the room flickers. If this is the case, dim the lights until you do not notice any flickers, or turn off the lights.
- If you or any member of your family has a history of light-sensitive seizures, consult a doctor before viewing 3D images.

Product Features

Outstanding features include:

- True PJ WX5140 / PJ WX5150 - WXGA(1280×800) addressable pixels
- Single chip DLP® technology
- NTSC3.58/NTSC4.43/PAL(B/D/G/H/I/M/N)/SECAM (B/D/G/K/K1/L) and SDTV(480i/576i), EDTV(480p/576p), HDTV(720p/1080i/1080p) compatible
- Multi-Auto functions: Auto detection, Auto image and Auto saving the adjustments
- Full function remote control
- User friendly multilingual on screen display
- Advanced digital keystone correction and high quality full screen image re-scaling
- Built-in mono 5-Watt speaker.

Introduction

Package Overview

This projector comes with all the items shown below. Check to make sure your unit is complete. Contact your dealer immediately if anything is missing.

Note

❖ Due to the difference in applications for each country, some regions may have different accessories.

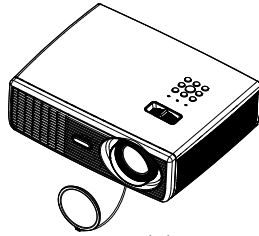

Projector with lens cap



Wireless Remote Control

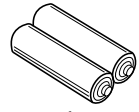

Batteries for Remote Control (AAA/R03)

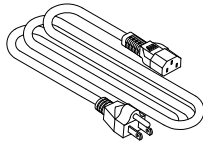

Power Cord

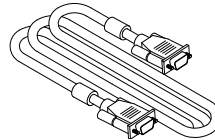

RGB Cable



Carrying Bag

Note

❖ (*) This supplied CD-ROM contains an user's manual in PDF format and Projector Management Utility.

Documentation:

- CD-ROM User's Manual(*)
- User's Manual

Introduction

Product Overview

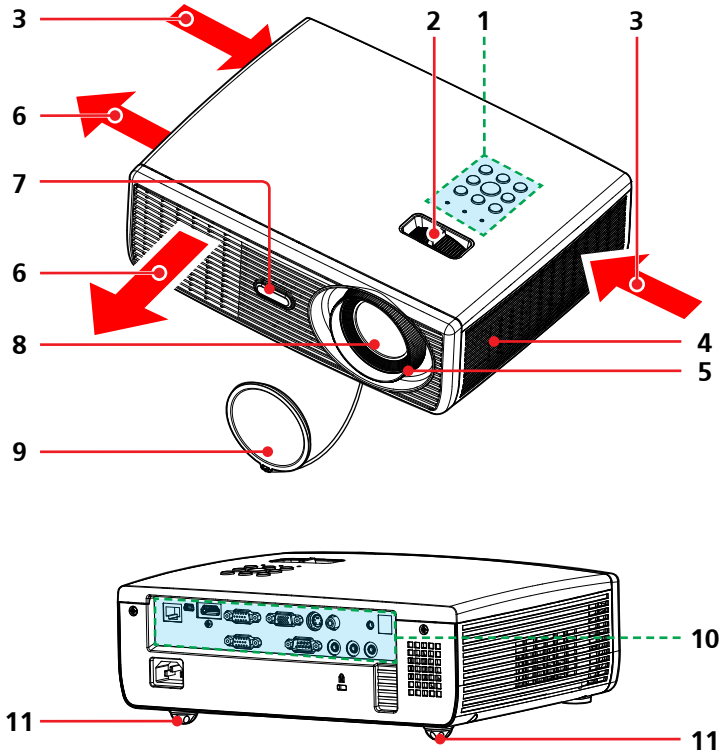

1. Control panel
2. Zoom lever
3. Ventilation (inlet)
4. Speaker
5. Focus ring
6. Ventilation (outlet)
7. Remote sensor
8. Lens
9. Lens cap
10. Connection ports
11. Adjustable feet

Introduction

Connection Ports

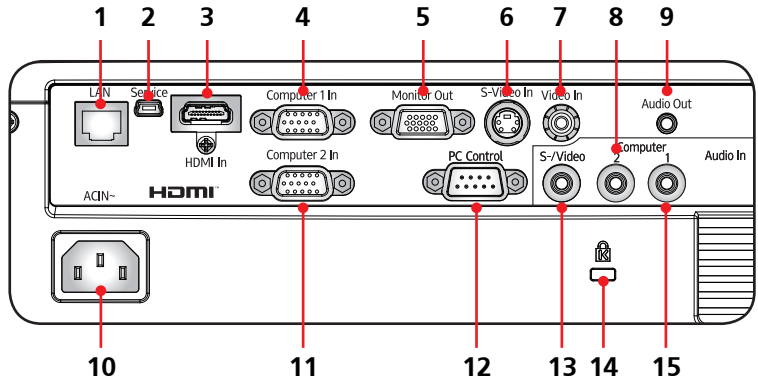

1. LAN terminal
2. Service Port
3. HDMI In terminal
4. Computer 1 In terminal
5. Monitor Out terminal
6. S-Video In terminal
7. Video In terminal
8. Audio 2 In terminal (For Computer 2 In)
9. Audio Out terminal
10. AC In socket
11. Computer 2 In terminal
12. PC Control terminal (RS232 Compliant)
13. Audio In terminal (For Video and S-Video)
14. Anti-theft lock hole (Kensington™ Lock)
15. Audio 1 In terminal (For Computer 1 In)

Introduction

Control Panel

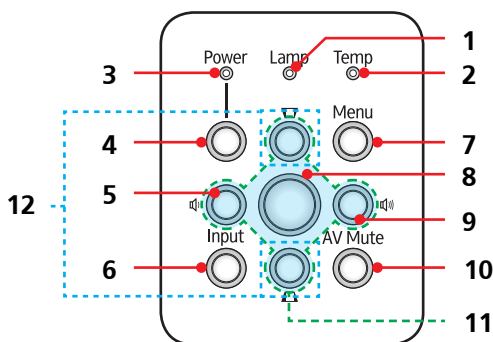

1	Lamp indicator	Indicate the projector's lamp status.
2	Temp indicator	Indicate the inside of the projector's temperature status.
3	Power indicator	Indicate the projector's power status.
4	Power	Refer to the "Power On/Off the Projector" section. (See pages 24~25)
5	Volume -	Decrease speaker volume.
6	Input	Switch among Computer1 (Component1), Computer2 (Component2), Video, S-Video and HDMI.
7	Menu	Press "Menu" to launch the Onscreen display (OSD), or go back to the previous menu. (See pages 30)
8	Enter	Select or confirm settings.
9	Volume +	Increase speaker volume.
10	AV Mute	Momentarily turn off/on the audio and video.
11	Four Directional Select Keys	Use or or or to select items or make adjustments to your selection.
12	Keystone	Use or to adjust the image to compensate for distortion caused by tilting the projector.

Introduction

Remote Control

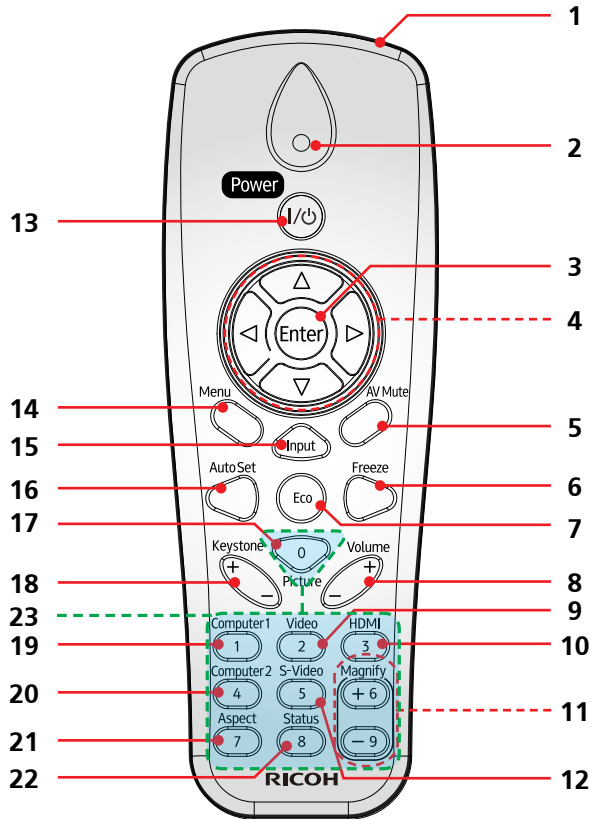

1	Infrared transmitter	Sends signals to the projector.
2	Indicator	
3	Enter	Select or confirm settings.
4	Four Directional Select Keys	Use ▲ or ▼ or ◀ or ▶ to select items or make adjustments to your selection.
5	AV Mute	Momentarily turn off/on the audio and video.
6	Freeze	Pause the screen image. Press again to resume the screen image.

Introduction

7	Eco	Dim the projector lamp which will lower power consumption and extend the lamp life.
8	Volume +/-	Increase/decrease speaker volume.
9	Video	Press "Video" to choose Video in terminal.
10	HDMI	Press "HDMI" to choose HDMI in terminal.
11	Magnify	Enlarge part of the screen image. You cannot use this function when "Native" is selected in "Aspect" setting.
12	S-Video	Press "S-Video" to choose S-Video in terminal.
13	Power	Refer to the "Power On/Off the Projector" section. (See pages 24~25)
14	Menu	Press "Menu" to launch the Onscreen display (OSD), or go back to the previous menu. (See page 30)
15	Input	Switch among Computer1 (Component1), Computer2 (Component2), Video, S-Video and HDMI.
16	Auto Set	Automatically adjust the RGB signal from the computer.
17	Picture	Switch the Image mode.
18	Keystone +/-	Adjust the image to compensate for distortion caused by tilting the projector.
19	Computer1	Press "Computer1" to choose Computer 1 In (Component 1) terminal.
20	Computer2	Press "Computer2" to choose Computer 2 In (Component 2) terminal.
21	Aspect	Use this function to choose your desired aspect ratio for the screen.
22	Status	Shows the projector's current status. (See page 44)
23	Number Key	

Remote Control Battery Installation

- 1 Press firmly and slide the battery cover off.
- 2 Install new batteries (AAA/R03). Ensure that you have the batteries' polarity (+/-) aligned correctly.
- 3 Slip the cover back over the batteries until it snaps into place. Do not mix different types of batteries or new and old batteries.

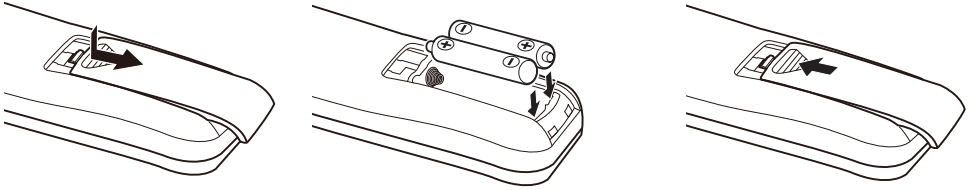

To ensure safe operation, please observe the following precautions :

- Use AAA/R03 type battery.
- Avoid contact with water or liquid.
- Do not expose the remote control to moisture or heat.
- Do not drop the remote control.
- If the battery has leaked in the remote control, carefully wipe the case clean and install new battery.
- Do not mix and use batteries that are different types or that are new and old. Batteries may leak.
- Dispose of used battery according to the instructions.
- Remove batteries from remote control when not using for extended periods.
- The remote control may fail to operate if the infrared remote sensor is exposed to bright sunlight or fluorescent lighting.

Remote Control Operating Range

Point the remote control toward the projector (Infrared Remote Receiver) when pressing any button. Maximum operating range for the remote control is about 23.0' (7m) and $\pm 15^\circ$ in front of the projector.

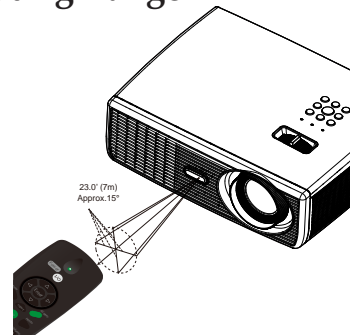

Basic Operations

Connecting the Projector

Connect to Computer/Notebook

Note

- ❖ Make sure that the power plug is fully inserted into both the projector AC inlet and the wall outlet.
- ❖ The AC outlet must be near this equipment and must be easily accessible.

Note

- ❖ Due to the difference in applications for each country, some regions may have different accessories.

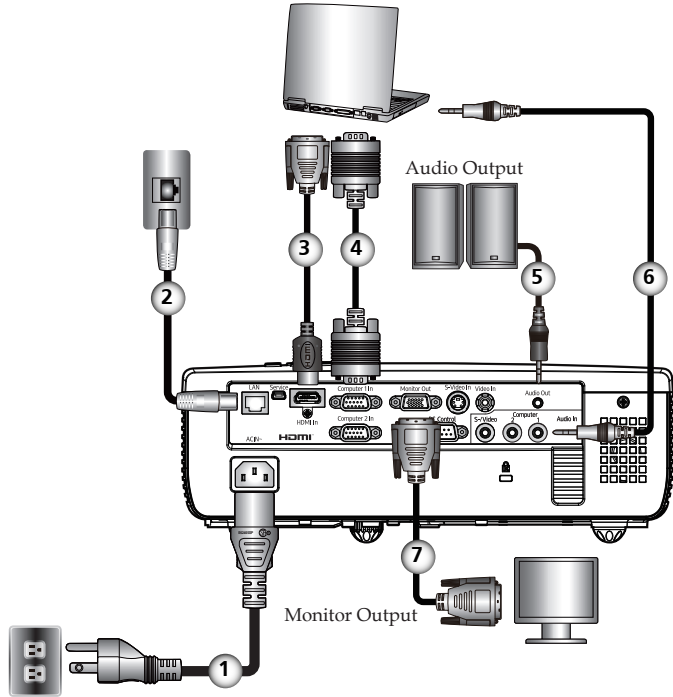

- | | |
|--------|-----------------------|
| 1..... | Power cord (supplied) |
| 2..... | LAN cable |
| 3..... | HDMI/DVI cable |
| 4..... | RGB cable (supplied) |
| 5..... | Audio out cable |
| 6..... | Audio in cable |
| 7..... | Monitor out cable |

- ❖ To ensure the projector works well with your computer, please make sure the timing of the display mode is compatible with your projector. (See pages 53-55)
- ❖ Use the cables that come with the projector.

Basic Operations

Note

❖ Make sure that the power plug is fully inserted into both the projector AC inlet and the wall outlet.

❖ The AC outlet must be near this equipment and must be easily accessible.

Note

❖ Due to the difference in applications for each country, some regions may have different accessories.

Connect to AV Equipment

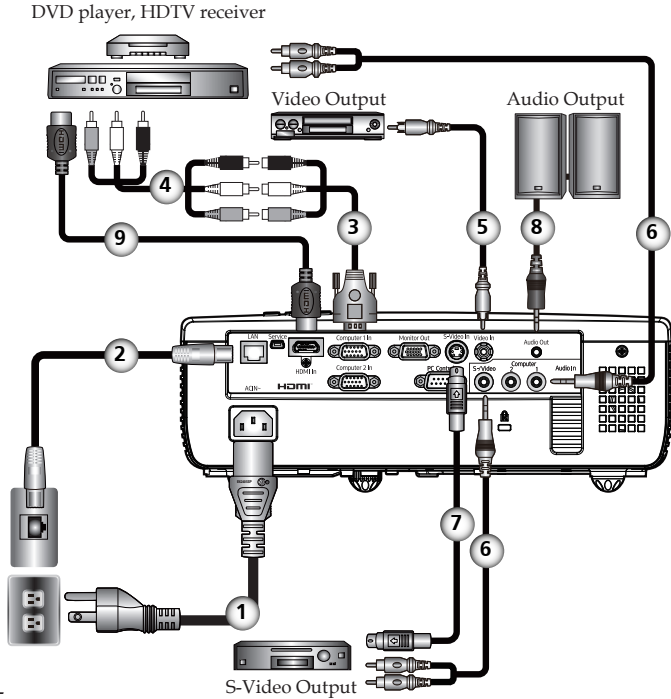

- | | |
|--------|-----------------------|
| 1..... | Power cord (supplied) |
| 2..... | LAN cable |
| 3..... | Component-RGB Cable |
| 4..... | Component Cable |
| 5..... | Video cable |
| 6..... | Audio in cable |
| 7..... | S-Video cable |
| 8..... | Audio out cable |
| 9..... | HDMI cable |

Basic Operations

Powering On/Off the Projector

Powering On the Projector

1. Ensure that the power cord and signal cable are securely connected. The Power indicator will turn red.
2. Remove the lens cap. ❶
3. Turn on the lamp by pressing "Power" on the control panel or the remote control. ❷ The Power indicator will flash blue. The startup screen will display in approximately 5 seconds. After the screen disappears, the Power indicator will turn blue.
The first time you use the projector after purchase, the language menu is displayed after the startup screen. (See pages 35~36)
4. Turn on your source (computer, notebook, video player, etc.) The projector will detect your source automatically.

CAUTION:

- Do not look into the lens while the lamp is on. The strong light from the lamp may cause damage to your eyesight.
- Do not block the air intake or exhaust. Doing so could cause a fire due to internal overheating.
- Do not place your hands, face, or other objects near the air exhaust, the lamp cover or the bottom of the unit. Doing so could result in injury and/or damage the object.

Note

❖ If you connect multiple sources at the same time, press "Input" or use "Computer1", "Computer2", "S-Video", "Video", "HDMI" on the remote control to switch inputs.

Note

❖ Turn on the projector first and then the signal sources.

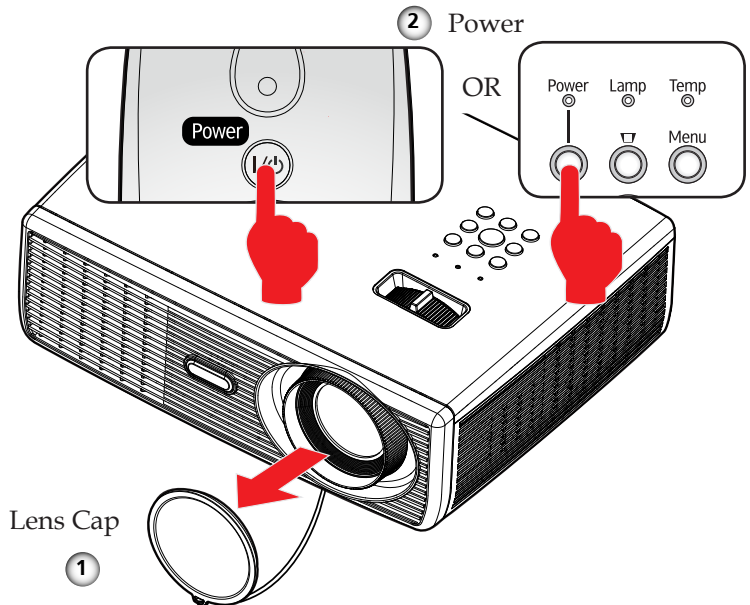

Powering Off the Projector

1. Press the “Power” and you will see a message as below on the on-screen display.

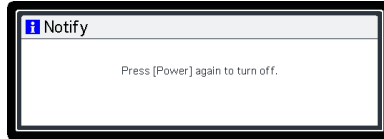

2. Press the “Power” again to turn off the projector lamp.
3. The cooling fan continues to operate for about 60 seconds for cooling cycle and the Power indicator will flash red. After cooling down, the light stops flashing, and then the projector will enter the standby mode.

If you wish to turn the projector back on, you must wait until the projector has completed the cooling cycle and has entered standby mode. Once in standby mode, simply press “Power” to restart the projector.

4. Disconnect the power cord from the electrical outlet and the projector.

Warning Indicator

- ❖ When the “Temp” indicator lights red, it indicates the projector has overheated. The projector will automatically shut itself down.



- ❖ When the “Lamp” indicator lights red, and you see the message below displays on-screen, the projector has detected that the lamp is approaching its end of life. Please change the lamp as soon as possible or contact your local dealer or our service center.

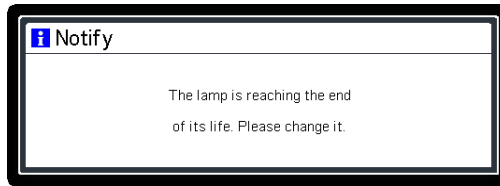

- ❖ When the “Temp” indicator flashes red (0.5 sec on, 0.5 secs off) and the message below displays, it indicates the cooling fan failed. Stop using the projector and disconnect the power cord from the electrical outlet, then contact your local dealer or our service center.



Adjusting the Projected Image

Adjusting the Position of Projector Image

The projector is equipped with adjustable feet to raise and lower the image to fill the screen.

1. Use ❶ to fine-tune the display angle.

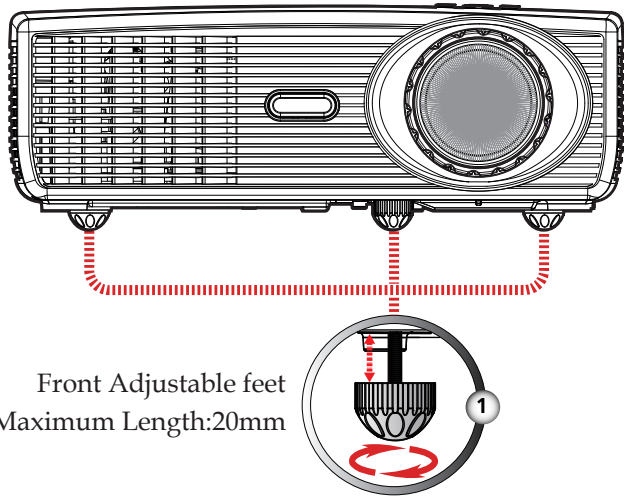

Note

❖ You can raise the projector front up to 6.5 degrees by rotating the adjustable feet.

Front Adjustable feet
Maximum Length:20mm

Basic Operations

Adjusting the Projector Zoom and Focus

You may turn the zoom lever to zoom in or out. To focus the image, rotate the focus ring until the image is clear.

- ▶ Focus at distances from 3.28 to 32.8 feet (1.0 to 10.0 meters).

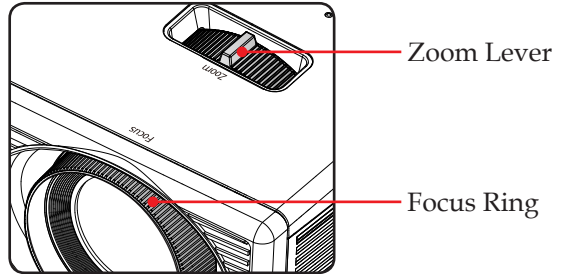

Adjusting Projection Image Size

- ▶ Projection Image Size from 30" to 300" (0.76 to 7.62 meters)

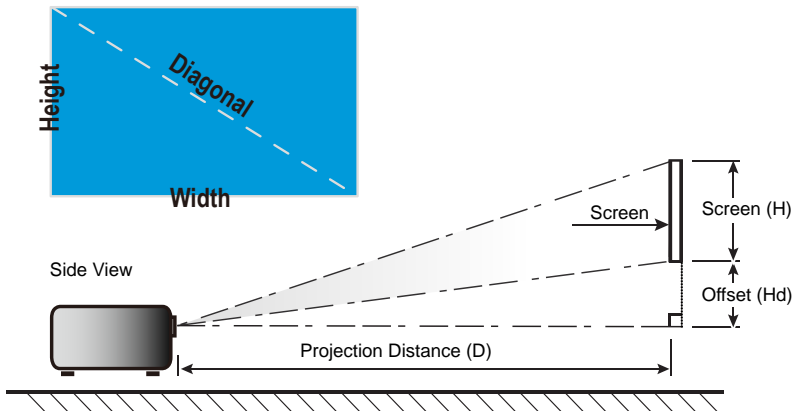

Basic Operations

PJ WX5140 / PJ WX5150

Diagonal length (inch) size of 16:10 Screen	Screen Size W x H				Projection Distance (D)				Offset (Hd)	
	(m)		(inch)		(m)		(feet)		(m)	(feet)
	Width	Height	Width	Height	wide	tele	wide	tele		
30	0.65	0.40	25.4	15.9	---	1.0	2.9	3.3	0.05	0.2
40	0.86	0.54	33.9	21.2	1.2	1.3	3.9	4.4	0.07	0.2
60	1.29	0.81	50.9	31.8	1.8	2.0	5.9	6.5	0.10	0.3
70	1.51	0.94	59.3	37.1	2.1	2.3	6.9	7.6	0.12	0.4
80	1.72	1.08	67.8	42.4	2.4	2.7	7.9	8.7	0.13	0.4
90	1.94	1.21	76.3	47.7	2.7	3.0	9.0	9.8	0.15	0.5
100	2.15	1.35	84.8	53.0	3.0	3.3	9.8	10.9	0.17	0.6
120	2.58	1.62	101.7	63.6	3.6	4.0	11.8	13.1	0.20	0.7
150	3.23	2.02	127.2	79.5	4.5	5.0	14.9	16.3	0.25	0.8
180	3.88	2.42	152.6	95.4	5.4	6.0	17.7	19.6	0.30	1.0
250	5.38	3.37	212.0	132.5	7.5	8.3	24.6	27.2	0.42	1.4
300	6.46	4.04	254.3	159.0	9.0	10.0	29.4	32.6	0.50	1.6

❖ This table is for user's reference only.

User Settings

Using the On Screen Display (OSD)

The Projector has a multilingual On Screen Display that allows you to make image adjustments and change a variety of settings.

How to operate

1. To open the OSD, press “Menu” on the Control Panel or Remote Control.
2. When OSD is displayed, use ▲ ▼ keys to select any item in the main menu. While making a selection on a particular page, press ► key to enter sub menu.
3. Use ▲ ▼ keys to select the desired item in the sub menu and press “Enter” to adjust the settings by ◀▶ key or ▲ ▼ key. To exit from adjusting the item, press “Enter” again.
4. If “to setting” word is shown in the setting, you can press “Enter” to enter another sub menu. Press “Menu” to close the sub menu after adjustment.
5. After adjusting the settings, press “Menu” to go back to the main menu.
6. To exit, press “Menu” again. The OSD will be closed.

Note

❖ If no button operation is made for 10 seconds, the OSD will be closed automatically.

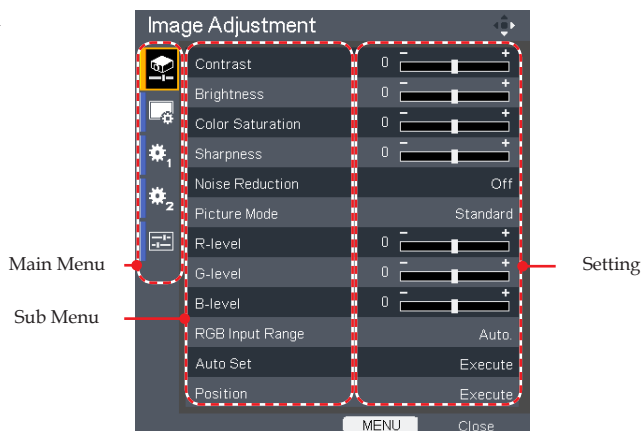

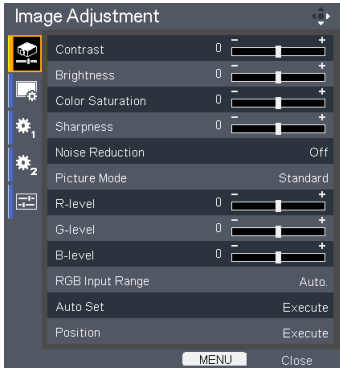

Image Adjustment

Contrast

The contrast controls the degree of difference between the lightest and darkest parts of the picture. Adjusting the contrast changes the amount of black and white in the image.

- ▶ Press the ◀ to decrease the contrast.
- ▶ Press the ▶ to increase the contrast.

Brightness

Adjust the brightness of the image.

- ▶ Press the ◀ to darken image.
- ▶ Press the ▶ to lighten the image.

Color Saturation

Adjust the color saturation of the image.

- ▶ Press the ◀ to decrease the amount of color in the image.
- ▶ Press the ▶ to increase the amount of color in the image.

Sharpness

Adjust the sharpness of the image.

- ▶ Press the ◀ to decrease the sharpness.
- ▶ Press the ▶ to increase the sharpness.

Noise Reduction

Adjust the screen noise reduction level.

Note

❖ “Sharpness”, “Noise Reduction” and “Color Saturation” functions are only supported under Video/S-Video/Component Signal sources.

User Settings

Picture Mode

There are many factory presets optimized for various types of images. Use the ▲ or ▼ to select the item.

- ▶ Bright: Mode for emphasizing brightness.
- ▶ Standard: Mode for optimizing the balance between brightness and color reproduction.
- ▶ Natural: Mode for emphasizing color reproduction.

R-level

Use the ◀ or ▶ to adjust the red signal level.

G-level

Use the ◀ or ▶ to adjust the green signal level.

B-level

Use the ◀ or ▶ to adjust the blue signal level.

RGB Input Range

Adjust the color range of the HDMI image data.

- ▶ Auto: Automatically detect RGB range.
- ▶ Standard: Process the input image as standard color range data.
- ▶ Full: Select this mode when computer signal or full range signal from AV equipment is input.

Auto Set

Automatically synchronize the computer signal.

Position

Refer to next page.

Note

❖ “RGB Input Range” is only supported under HDMI source.

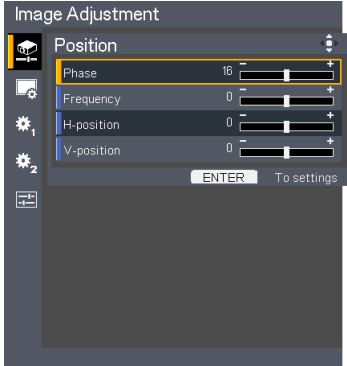

Image Adjustment | Position

Phase

Eliminate flicker from the image displayed. Use the ◀ or ▶ to adjust the value.

Frequency

Adjust the number of total dots in one horizontal period. Use the ◀ or ▶ to adjust number to match your PC image.

H-position (Horizontal Position)

- ▶ Press the ◀ to move the image left.
- ▶ Press the ▶ to move the image right.

V-position (Vertical Position)

- ▶ Press the ◀ to move the image down.
- ▶ Press the ▶ to move the image up.

Note

❖ "Position" is only supported in Analog signal.

User Settings

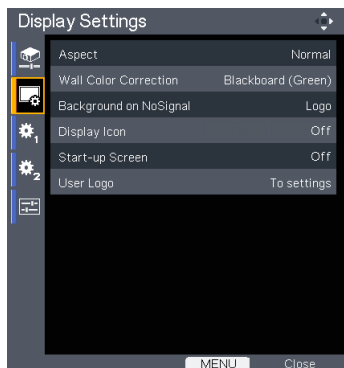

Display Settings

Aspect

Use this function to choose your desired aspect ratio.

- ▶ Normal: Enlarge an input image to fit the screen by detecting the input signal aspect ratio. The image may not be displayed correctly depends on the aspect ratio. If so, select other aspect ratio.
- ▶ Full: Displays an input image by enlarging it to fill the entire screen.
- ▶ 16:9: Displays an input image in the center of the screen with a 16:9 aspect ratio.
- ▶ Zoom: Display 16:9 center area of 4:3 signal. (for letter box signal. If input signal is 16:9 signal, displayed picture is stretched vertically.)
- ▶ Native: Displays an input image in the native resolution of the video signals. Native display is not available for Y/PB/PR, Video and S-Video input images.

Wall Color Correction

Use this function to obtain an optimized screen image according to the wall color. You can select from "Off", "Whiteboard", "Beige", "Blackboard (Green)" and "Gray".

Background on NoSignal

Use this feature to display a "Logo", "Blue" or "None", screen when no signal is available.

Display Icon

Choose "On" to display icons when switching the input signals and settings. Choose "Off" to hide icons.

User Settings

Start-up Screen

Use this function to set the desired startup screen when the projector is turned on. If changes are made they will take effect the next time the projector is powered on.

- ▶ On: Display the startup screen.
- ▶ Off: No startup screen is displayed.

User Logo

User logos can be displayed in the start-up screen or as the background when there are no input signals.

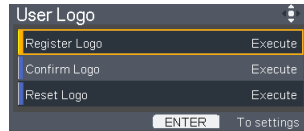

Note

❖ It takes up to 120 seconds to capture the picture. This may vary by resolution of the input signal.

- ▶ Register Logo: Project the image to be registered as a user logo, and then execute this function.

How to capture the image:

1. Find the image from input source.
2. Project the image.
3. Choose [Register Logo --> Execute], and select [OK]

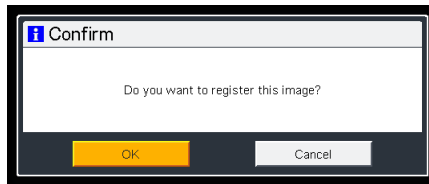

4. Start capturing the screen.

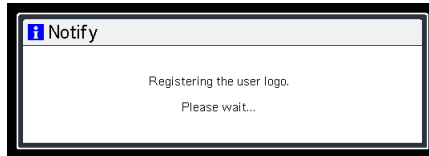

5. When finished, it will show the message below,

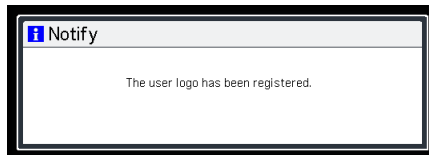

User Settings

- ▶ Confirm Logo: Display the registered user logo.
- ▶ Reset Logo: Return to the default logo.

Image format:

- Only capture of external source is supported.
- Capture of background color is not supported.
- If the source image resolution is bigger than 2368512 bytes (24-bit WXGA image resolution) image size, the splash image will be captured after center-cropping the source image to a maximum of 2368512 bytes by retaining the source aspect ratio.
- If user had been captured image, the image data captured will be overwritten by the new one.
- 3D image is not supported.

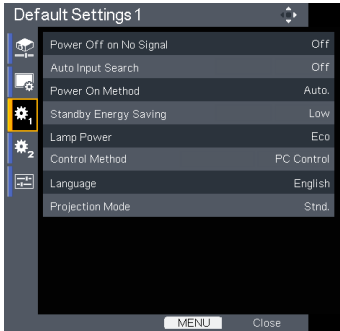

Default Settings 1

Power Off on No Signal

Sets the countdown timer interval. The countdown timer will start, when there is no signal being sent to the projector. The projector will automatically power off when the countdown has finished.

Auto Input Search

When this function is turned “On”, the projector will search for other signals if the current input signal is lost. When this function is turned “Off”, it will only search a specified connection port.

Power On Method

Sets whether to turn on the power when the ON/STANDBY button is pressed (Manual), or when the main power switch is turned on (Auto).

Standby Energy Saving

- ▶ High: Choose “High” to save standby power (less than 0.5W). Monitor Out port and LAN control function will be disabled in standby mode.
- ▶ Low: Choose “Low” to return to normal standby mode.

Lamp Power

- ▶ Eco: Choose “Eco” to lower lamp power consumption and extend the lamp life.
- ▶ Std: Standard mode.

Control Method

- ▶ PC Control: Allow PC control using PC control terminal. (Default setting)
- ▶ LAN: Allow projector control via web browser (Internet Explorer) or Projector Management Utility (PJ Link).

Note

❖ If “Power on Method” is set to “Auto”, then if the power is supplied when restored after a power outage, the projector will come on.

User Settings

Language

Choose the multilingual OSD. Press “ENTER” to open the sub menu and then use the ▲ or ▼ or ◀ or ▶ key to select your preferred language. Press “ENTER” to finalize the selection.

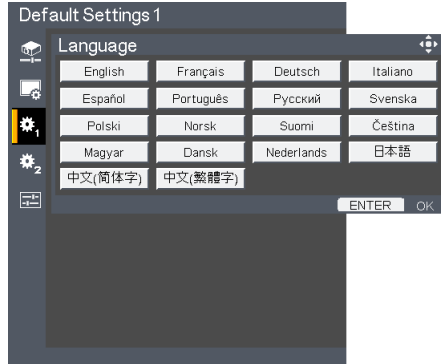

Projection Mode

▶ Stnd. (Standard)

The factory default setting. The image is projected straight on the screen.

▶ Rear

The projector reverses the image from left to right when you project behind a translucent screen.

▶ Ceiling

The projector turns the image upside down when using the ceiling-mounted projection.

▶ Rr-Ceil. (Rear Ceiling)

The projector reverses the image from left to right and turns the image upside down at the same time. You can project from behind a translucent screen with ceiling mounted projection.

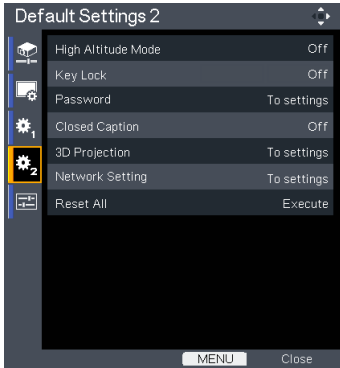

Default Settings 2

High Altitude Mode

When “On” is selected, the fans will spin faster. Set High Altitude mode to “On” when the projector is used over 2500ft (750m) elevation.

Key Lock

When the keypad lock function is “On”, the control panel will be locked. However, the projector can be operated by the remote control. By selecting “Off”, you will be able to reuse the control panel.

Password

Note

- ❖ Password default value is “000000” (first time).

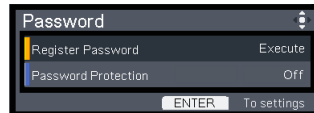

▶ Register Password:

■ First time

1. Choose [Register Password--> Execute], and press “ENTER” to set the password.
2. Enter default password “000000” and press “ENTER” to confirm.

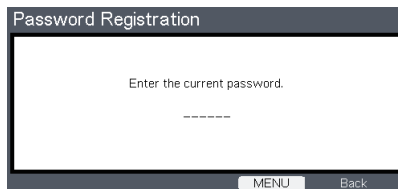

User Settings

3. Enter the new password and press “ENTER” to confirm.

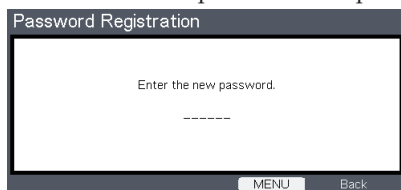

4. Enter new password again and press “ENTER” to confirm.

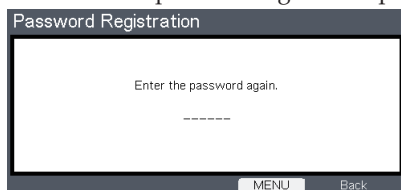

Note

- ❖ The password has to be 6 digits.
- ❖ Use number button on the remote to enter your new password and then press “Enter” key to confirm your password.

■ Change Password

1. Press “ENTER” to input old password.
2. Use number button to enter current password and then press “ENTER” to confirm.
3. Enter new password (6 digits in length) using the number buttons on the remote, then press “ENTER” to confirm.
4. Enter new password again and press “ENTER” to confirm.

- If the incorrect password is entered 5 times, the projector will automatically shut down.
- If you have forgotten your password, please contact your local office for support.

- ▶ Register Protection: Choose “On” to use security verification when the turning on the projector. Choose “Off” to be able to switch on the projector without password verification.

Closed Caption

This projector supports a special feature called closed captioning which allows subtitles to be displayed at the bottom of the picture.

This is pursuant to the Regulations set forth by the US Federal Communications Commission (FCC).

- ▶ Off: Select “Off” to turn off the closed captioning feature.
- ▶ CC-1: CC-1 language including American English.
- ▶ CC-2: CC-2 language including Spanish, French, Portuguese, German and Danish. (depending on the TV channel of the user)

User Settings

Due to the different broadcasting or signaling system, it may not operate correctly in other regions or countries where TV programs do not support closed captioning. Closed Caption may not appear correctly depending on the signal conditions or the recording conditions of videotapes.

When you switch channels of broadcasting programs or play a videotape using "trick play" functions such as rewind or fast-forward, the operations in the connected device may cause the Caption to remain on the screen for a while.

Closed Caption is available for Video and S-Video input images.

3D Projection

Refer to next page.

Network Setting

Refer page 43~44.

Reset All

Return the adjustments and settings to the factory default values.

User Settings

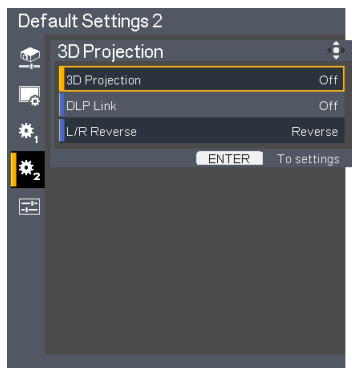

Default Settings 2 | 3D Projection

3D Projection

- ▶ Off: Choose "Off" to display normal (2D) picture.
- ▶ On: Choose "On" to display 3D format.

DLP Link

Select "On" to display 3D image viewing with DLP Link 3D glasses. Optional sold 3D glasses uses DLP link system to synchronize with the product. Set DLP Link "On" when the optional 3D glasses are used.

L/R Reverse

- ▶ Normal: Choose "Normal" for default frame contents.
- ▶ Reverse: Choose "Reverse" to invert left and right frame contents. Choose "Reverse" if viewing image is not natural or felt 3D incorrect.



❖ Compatible 3D source, 3D content and active shutter glasses are required for 3D viewing.

❖ "L/R Reverse" is only available when 3D is enabled and this mode 3D is for DLP link glass only.

❖ This setting may need to change when re-start running 3D movie.

❖ HDMI input of the projector does not support 3D image transmission in HDMI standard. 3D image can't be displayed when a 3D Blu-ray disc player is directly connected to the HDMI terminal.

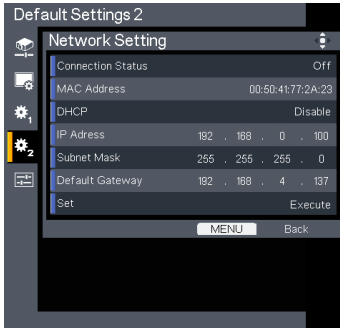

Default Settings 2 | Network Setting

Note

- ❖ Be sure to set “Control Method” to “LAN” before starting to set Network setting.

Connection Status

Display the network connection status.

MAC Address

Display MAC address.

DHCP

If you change the setting from one to another, when you exit the OSD menu, the new setting will take effect on next open.

- ▶ Enable: Assign network settings to the projector from a DHCP server automatically.
- ▶ Disable: Assign network settings such as an IP address manually.

IP Address

Set an IP address . Using number key on the remote control. Or display IP address provided from DHCP server when DHCP is set to “Enable”.

Subnet Mask

Set subnet mask number. Using number key on the remote control. Or display IP address provided from DHCP server when DHCP is set to “Enable”.

Default Gateway

Set the default gateway of the network connected to the projector. Using number key on the remote control. Or display IP address provided from DHCP server when DHCP is set to “Enable”.

Set

Select “OK” to apply the selection.

User Settings

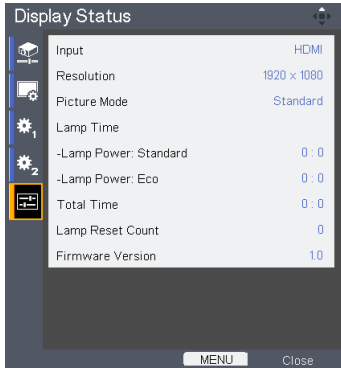

Display Status

Input

Input source name.

Resolution

Resolution (in dots).

Picture Mode

Display the setting of Picture mode.

Lamp Time

Time of lamp use.

Total Time

Total Time, including Eco mode and Standard mode.

Lamp Reset Count

Display the number of projector replacement lamps.

Firmware Version

Display Firmware version.

Controls via Network

How to use web browser to control your projector

Be sure to set “Control Method” to “LAN” before starting to set Network setting.

Note

- ❖ Set “Standby Energy Saving” to “Low” if you want to turn on the projector from web browser.

1. Check IP address in Default setting 2 > Network setting menu in OSD. (See page 43)

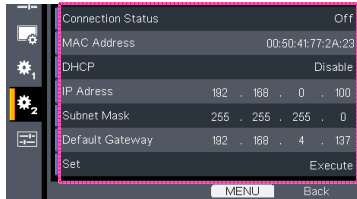

2. Open your web browser and type in the IP address you checked. For example, type “http://192.168.0.100” when IP address is displayed as the screen above. Then the web page will display as below:

Note

- ❖ -This web page is available only in English.
- The default password for “Administrator” is “admin” and the default password for “User” is “user”.

2.1 Login:



- 2.1-1 Select a user. “Administrator” is with high authority that can process more operations such as network setting and alert setting. And “User” is with normal authority.
- 2.1-2 Input your password. (See note for the default password.)
- 2.1-3 Click “Login” button to login. There will be a prompt if your password is wrong. With correct password, you can enter to control pages.

- 2.2 Home: This is a web page which shows basic information of your projector. There are 5 tabs and you can click a tab for specific controls. For more information, you can download a manual of web control function from the download page of the following URL.

<http://www.rioh.com/>



Controls via Network

Managing the Projector Using Projector Management Utility

Projector Management Utility conforms to the PJLink class 1 standards, and is compatible with all class 1 commands.

A maximum of 100 projectors connected to the network can be managed using one computer.

Projector Management Utility operating environment is described below.

- Supported operating system
 - Windows XP SP3 (32-bit version) Professional Edition, Home Edition
 - Windows Vista (32-bit version) Ultimate, Business, Home Premium, Home Basic
 - Windows 7 (32-bit version) Home Premium, Professional, Ultimate, Enterprise
- Memory size
 - Recommended memory size for the operating system of the computer you are using
- Display resolution
 - 800 × 600 pixels or more

Note

- ❖ This software is to control and monitor projectors manufactured by our company. The software may not work properly when used to control other projectors.

Installing Projector Management Utility

Projector Management Utility is included on the supplied CD-ROM.

Log in to the computer with administrator privileges to install or uninstall utilities.

1. Close all applications.
2. Insert the CD-ROM in the CD-ROM drive of your computer, and then click [Exit] on the launcher screen.
3. Open the "Projector Management Utility" folder stored on the CD-ROM.
4. Double-click "setup.exe" stored in the "Projector Management Utility" folder.
5. Install the application by following the on-screen instruction.
6. When the installation is complete, exit the installer.
 - A shortcut icon is created on the desktop.

Note

- ❖ To uninstall Projector Management Utility, use the program delete function in [Control Panel] to delete "Projector Management Utility". Settings about PJLink controls can be changed by using web pages of this projector. Default password for PJLink is "admin".

Troubleshooting

If you experience trouble with the projector, refer to the following information. If the problem persists, please contact your local dealer or service center.

Problem: No image appears on screen

- ▶ Ensure all the cables and power connections are correctly and securely connected as described in the “Installation” section.
- ▶ Ensure the pins of terminals are not crooked or broken.
- ▶ Check if the projection lamp has been securely installed. Please refer to the “Replacing the lamp” section.
- ▶ Make sure you have removed the lens cap and the projector is switched on.
- ▶ Ensure that the “AV Mute” feature is not turned on.

Problem: Partial, scrolling or incorrectly displayed image

- ▶ Press “Auto Set” on the remote control.
- ▶ Adjust the computer display settings. Verify the resolution setting is less than or equal to 1600 x 1200 resolution. See your operating system’s Help file.
- ▶ If you are using a Notebook:
 1. First, follow the steps above to adjust resolution of the computer.
 2. Press the toggle output settings. example: [Fn]+[F3]

PANASONIC, NEC => Fn+F3
HP, SHARP, TOSHIBA => Fn+F5
IBM, SONY => Fn+F7
DELL, EPSON => Fn+F8
FUJITSU => Fn+F10
APPLE =>F7

- ▶ If you experience difficulty changing resolutions or your monitor freezes, restart all equipment including the projector.

Problem: The screen of the Notebook computer is not displaying a presentation

▶ If you are using a Notebook PC:

Some Notebook PCs may deactivate their own screens when a second display device is in use. Each has a different way to be reactivated. Refer to your computer's documentation for detailed information.

Problem: Image is unstable or flickering

- ▶ Adjust the "Phase" or "Frequency" to correct it. Refer to the "Image Adjustment | Position" section for more information.
- ▶ Check and reconfigure the display mode of your graphic card to make it compatible with the product.

Problem: Image is out of focus

- ▶ Adjust the Focus Ring on the projector lens.
- ▶ Make sure the projection screen is between the required distance. (refer to pages 28~29)

Problem: The image is stretched when displaying 16:9 DVD

Change "Aspect" by pressing the key on remote control or OSD menu to show image with proper aspect ratio.

Problem: Image is too small or too large

- ▶ Adjust the Zoom lever on the top of the projector.
- ▶ Move the projector closer to or further from the screen.
- ▶ Press "Aspect" button on the remote control or press "Menu" button on the projector panel, go to "Display Settings --> Aspect" and try the different settings.

Problem: Image is reversed































- ▶ Select "Default Settings 1-->Projection Mode" from the OSD menu to adjust the image.

Problem: Lamp burns out or makes a popping sound



- ▶ When the lamp reaches its end of life, it will burn out and may make a loud popping sound. If this happens, the projector will not turn on until the lamp module has been replaced. To replace the lamp, follow the procedures in the “Replacing the Lamp”.

Troubleshooting

Problem: Indicator lighting message

Message	POWER indicator	TEMP indicator	LAMP indicator
	(Red/Blue)	(Red)	(Red)
Standby	 (Red)		
Normal (Power on)	 (Blue)		
Powering up (Warming up)	Flashing Blue (0.5 sec)		
Power off (Cooling Down)	Flashing Red (0.5 sec)		
Temperature Error (Over temp. On Event)	 (Blue)		
Temperature Error (Over temp. On Standby)	 (Red)		
Lamp Error (Lamp failed On Event)	 (Blue)		
Lamp Error (Lamp failed On Standby)	 (Red)		
Error (Fan failed On Event)	 (Blue)	Flashing	
Error (Fan failed On Standby)	 (Red)	Flashing	
Error (Color Wheel fail / Striking Lamp Fail On Event)	 (Blue)		Flashing
Error (Color Wheel fail / Striking Lamp Fail On Standby)	 (Red)		Flashing

Note

Steady light => 
 No light => 

Problem: Message Reminders

- ▶ Temperature Error - the projector is overheat inside. Check the environmental condition.



- ▶ Replacing the lamp - the lamp is about to reach its maximum life-time. Prepare to replace it soon.

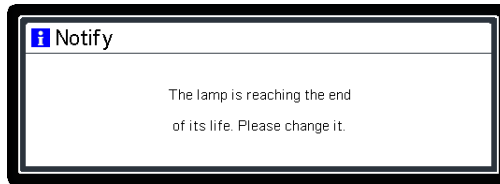

- ▶ Fan Error - the cooling system fan is not working.



Replacing the lamp

The projector will detect the lamp life itself. It will show you a warning message

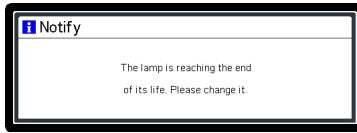

Warning: To avoid burns, allow the projector to cool for at least 60 minutes before you replace the lamp!

When you see this message, change the lamp as soon as possible. Make sure the projector has been cooled down for at least 60 minutes before changing the lamp.

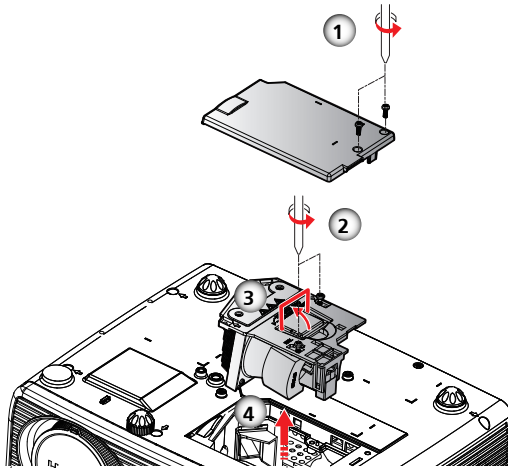

Warning: Do not drop the lamp module or touch the glass parts. The glass parts may shatter and cause injury if it is dropped.

Warning: For continued safety replace with a lamp of the same type.

Caution: If the lamp should break, handle with care to avoid injury due to broken pieces and contact your sales representative for repair service.

Lamp Replacing Procedure:

1. Switch off the power to the projector by pressing the "Power".
2. Allow the projector to cool down at least 60 minutes.
3. Disconnect the power cord.
4. Use a screwdriver to loosen the 2 screws from the cover. ①
5. Push up and remove the lamp cover.
6. Loosen the 2 screws from the lamp module ② and pull up the lamp bar. ③
7. Pull out the lamp module by force. ④
8. Install the new lamp module by reversing the previous steps. See the lamp's manual for instructions on resetting the lamp time.

Used Lamps

This projector's lamp contains trace amounts of environmentally harmful inorganic mercury. Be careful not to break used lamps, and dispose of them in accordance with local regulations or contact your sales representative.

List of Compatible Signals

A. VGA Analog				
(1) VGA Analog - PC Signal				
Modes	Resolution	V.Frequency (Hz)	H.Frequency (kHz)	Clock (MHz)
VGA	640 x 480	60	31.47	25.18
	640 x 480	72	37.86	31.50
	640 x 480	75	37.50	31.50
	640 x 480	85	43.27	36.00
	640 x 480	119.51	61.61	-
SVGA	800 x 600	56	35.20	36.00
	800 x 600	60	37.88	40.00
	800 x 600	72	48.08	50.00
	800 x 600	75	46.88	49.50
	800 x 600	85	53.67	56.25
	800 x 600	119.85	77.20	-
XGA	1024 x 768	60	48.36	65.00
	1024 x 768	70	56.48	75.00
	1024 x 768	75	60.02	78.75
	1024 x 768	85	68.67	94.50
	1024 x 768	119.804	98.80	-
SXGA	1152 x 864	70	63.80	94.50
	1152 x 864	75	67.50	108.00
	1152 x 864	85	77.10	121.50
	1280 x 1024	60	63.98	108.00
	1280 x 1024	72	77.90	134.60
QuadVGA	1280 x 1024	75	79.98	135.00
	1280 x 1024	85	91.15	157.50
	1280 x 960	60	60.00	108.00
SXGA+	1280 x 960	75	75.00	126.00
	1400 x 1050	60	65.32	121.75
UXGA	1600 x 1200	60	75.00	162.00
PowerBook G4	640 x 480	60	31.50	25.17
PowerBook G4	640 x 480	66.6(67)	35.00	30.24
PowerBook G4	800 x 600	60	37.88	40.00
PowerBook G4	1024 x 768	60	48.36	65.00
PowerBook G4	1152 x 870	75	68.68	100.00
PowerBook G4	1280 x 960	75	75.20	126.00
i Mac (G3)	1024 x 768	75	60.30	80.00

Appendices

A. VGA Analog

(2) VGA Analog - Extended Wide

Modes	Resolution	V.Frequency (Hz)	H.Frequency (kHz)	Clock (MHz)
WXGA	1280 x 768	60	47.78	79.50
	1280 x 768	75	60.29	102.25
	1280 x 768	85	68.63	117.50
	1280 x 720	60	44.80	74.25
	1280 x 800	60	49.60	83.50
	1440 x 900	60	55.90	106.50
	1680 x 1050	60	65.30	146.25
	1366 x 768	60	47.74	85.50
	1920 x 1080-RB	60	66.60	138.50
	1024 x 600	60	37.30	50.40

(3) VGA Analog - Component Signal

480i	720 x 480	59.94 (29.97)	27.00	-
480p	720 x 480	59.94	31.47	-
576i	720 x 576	50 (25)	27.00	-
576p	720 x 576	50	31.25	-
720p	1280 x 720	60	45.00	-
720p	1280 x 720	50	37.50	-
1080i	1920 x 1080	60 (30)	33.75	-
1080i	1920 x 1080	50 (25)	33.75	-
1080p	1920 x 1080	60	67.50	-
1080p	1920 x 1080	50	56.25	-

B. HDMI Digital

(1) HDMI - PC Signal (Same as DVI)

Modes	Resolution	V.Frequency (Hz)	H.Frequency (kHz)	Clock (MHz)
VGA	640 x 480	60	31.47	25.18
	640 x 480	72	37.86	31.50
	640 x 480	75	37.50	31.50
	640 x 480	85	43.27	36.00
	640 x 480	119.51	61.61	-
SVGA	800 x 600	56	35.20	36.00
	800 x 600	60	37.88	40.00
	800 x 600	72	48.08	50.00
	800 x 600	75	46.88	49.50
	800 x 600	85	53.67	56.25
	800 x 600	119.85	77.20	-
XGA	1024 x 768	60	48.36	65.00
	1024 x 768	70	56.48	75.00
	1024 x 768	75	60.02	78.75
	1024 x 768	119.804	98.80	-

Appendices

B. HDMI

(1) HDMI -PC Signal

SXGA	1152 x 864	75	67.50	108.00
	1152 x 864	85	77.10	121.50
	1280 x 1024	60	63.98	108.00
	1280 x 1024	72	77.90	134.60
	1280 x 1024	75	79.98	135.00
QuadVGA	1280 x 1024	85	91.15	157.50
	1280 x 960	75	75.00	126.00
PowerBook G4	640 x 480	60	31.50	25.17
PowerBook G4	640 x 480	66.6(67)	35.00	30.24
PowerBook G4	800 x 600	60	37.88	40.00
PowerBook G4	1024 x 768	60	48.36	65.00
PowerBook G4	1152 x 870	75	68.68	100.00
PowerBook G4	1280 x 960	75	75.20	126.00
i Mac (G3)	1024 x 768	75	60.30	80.00

B. HDMI

(2) HDMI Analog - Extended Wide

Modes	Resolution	V.Frequency (Hz)	H.Frequency (kHz)	Clock (MHz)
WXGA	1280 x 768	60	47.78	79.50
	1280 x 768	75	60.29	102.25
	1280 x 768	85	68.63	117.50
	1280 x 720	60	44.80	74.25
	1280 x 800	60	49.60	83.50
	1440 x 900	60	55.90	106.50
	1680 x 1050	60	65.30	146.25
	1366 x 768	60	47.74	85.50
	1920 x 1080-RB	60	66.60	138.50
	1920 x 1080-EIA	60	66.60	148.50
	1024 x 600	60	37.30	50.40

(3) HDMI Analog - Video Signal

480i	720 x 480 (1440 x 480)	59.94 (29.97)	27.00	-
480p	720 x 480	59.94	31.47	-
576i	720 x 576 (1440 x 576)	50 (25)	27.00	-
576p	720 x 576	50	31.25	-
720p	1280 x 720	60	45.00	-
720p	1280 x 720	50	37.50	-
1080i	1920 x 1080	60 (30)	33.75	-
1080i	1920 x 1080	50 (25)	33.75	-
1080p	1920 x 1080	60	67.50	-
1080p	1920 x 1080	50	56.25	-
1080p	1920 x 1080	24/23.98	27.00	-

Configurations of Terminals

Terminal: Computer in 1/2 (Mini D-sub 15 pin)

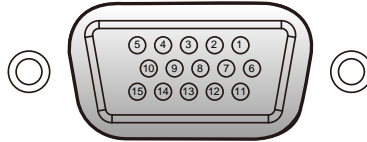

1	Red (R/Cr) Input/R Output	9	DDC 5V / NC*
2	Green (G/Y) Input/G Output	10	Ground (Ver. sync.)
3	Blue (B/Cb) Input/B Output	11	NC*
4	NC*	12	DDC Data / NC*
5	Ground (Horiz.sync.)	13	Horiz. sync. Input / Output (Composite H/V sync. Input)
6	Ground (Red)		
7	Ground (Green)	14	Vert. sync. Input / Output
8	Ground (Blue)	15	DDC CLK / NC*

* Do not connect anything.

Terminal: PC Control (D-sub 9 pin)

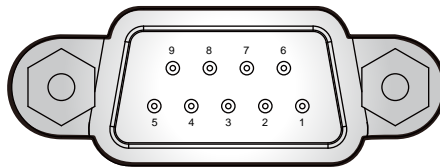

1	NC*	6	NC*
2	TXD (Sending Data)	7	NC*
3	RXD (Receiving Data)	8	NC*
4	NC*	9	NC*
5	GND	* Do not connect anything.	

Note

- ❖ Contact your dealer for control cable and commands.

Specifications

■ List of general specifications

Item	Specification	
Consumption Power	PJ WX5140: 245W (ECO mode) / 300W (Full mode) PJ WX5150: 295W (ECO mode) / 380W (Full mode)	
Weight	PJ WX5140: 6.6 lbs (3.0 Kg) PJ WX5150: 7.1 lbs (3.2 Kg)	
Dimensions (WxHxD)	306 x 113 x 239 mm (with protruding parts)	
Environmental Considerations	Operational Temperatures : 41° to 95°F (5° to 35°C), 20% to 80% humidity (non-condensing) Storage Temperatures : -4° to 140°F (-20° to 60°C), 20% to 80% humidity (non-condensing)	
Projection System	Single DLP® 0.65" chip	
Resolution	1280 × 800 pixels (WXGA)	
Lens	F# 2.51~2.66, f=19.72 mm ~ 21.77 mm, 1.1X Zoom Lens	
Lamp	PJ WX5140: High-pressure mercury lamp (230W) PJ WX5150: High-pressure mercury lamp (300W)	
Lamp Life	PJ WX5140: 2500 hours typical (Full Mode) / 4000 hours typical (ECO Mode) PJ WX5150: 2500 hours typical (Full Mode) / 3500 hours typical (ECO Mode)	
Projection screen size	30 ~ 300 inch	
Projection distance	1.0 ~ 10.0m (Focus range)	
Speaker	5W (Mono)	
Connection terminal	Computer In terminal × 2	Mini D sub 15 pin RGB / Y/P _B / P _R (dual use)
	Monitor Out terminal	Mini D sub 15 pin
	S-Video terminal	Mini DIN 4 pin
	HDMI terminal	HDMI Type-A
	Video terminal	RCA Pin Jack
	LAN terminal	RJ-45
	PC Control terminal	D sub 9 pin male (RS-232C compliant)
	Audio In terminal × 3	3.5mm diameter mini-jack (1)Computer 1 (2)Computer 2 (3)Video / S-Video (dual use)
Audio Out terminal	3.5mm diameter mini-jack	

Note

- This model complies with the above specifications.
- Designs and specifications are subject to change without notice.
- This model may not be compatible with features and/or specifications that may be added in the future.

■ Separately sold product

PJ Replacement Lamp Type 4 (for PJ WX5140)

PJ Replacement Lamp Type 5 (for PJ WX5150)

Trademarks

- DLP is trademarks of Texas Instruments.
- IBM is a trademark or registered trademark of International Business Machines Corporation.
- Macintosh, Mac OS X, iMac, and PowerBook are trademarks of Apple Inc., registered in the U.S. and other countries.
- Microsoft, Windows, Windows Vista, Internet Explorer and PowerPoint are either a registered trademark or trademark of Microsoft Corporation in the United States and/or other countries.
- HDMI, the HDMI Logo and High-Definition Multimedia Interface are trademarks or registered trademarks of HDMI Licensing LLC.
- Other product and company names mentioned in this user's manual may be the trademarks or registered trademarks of their respective holders.

PJ WX5140/PJ WX5150



User's Manual