

# IFP92UW

# IFP105 Series

## Commercial Touch Display

## User Guide

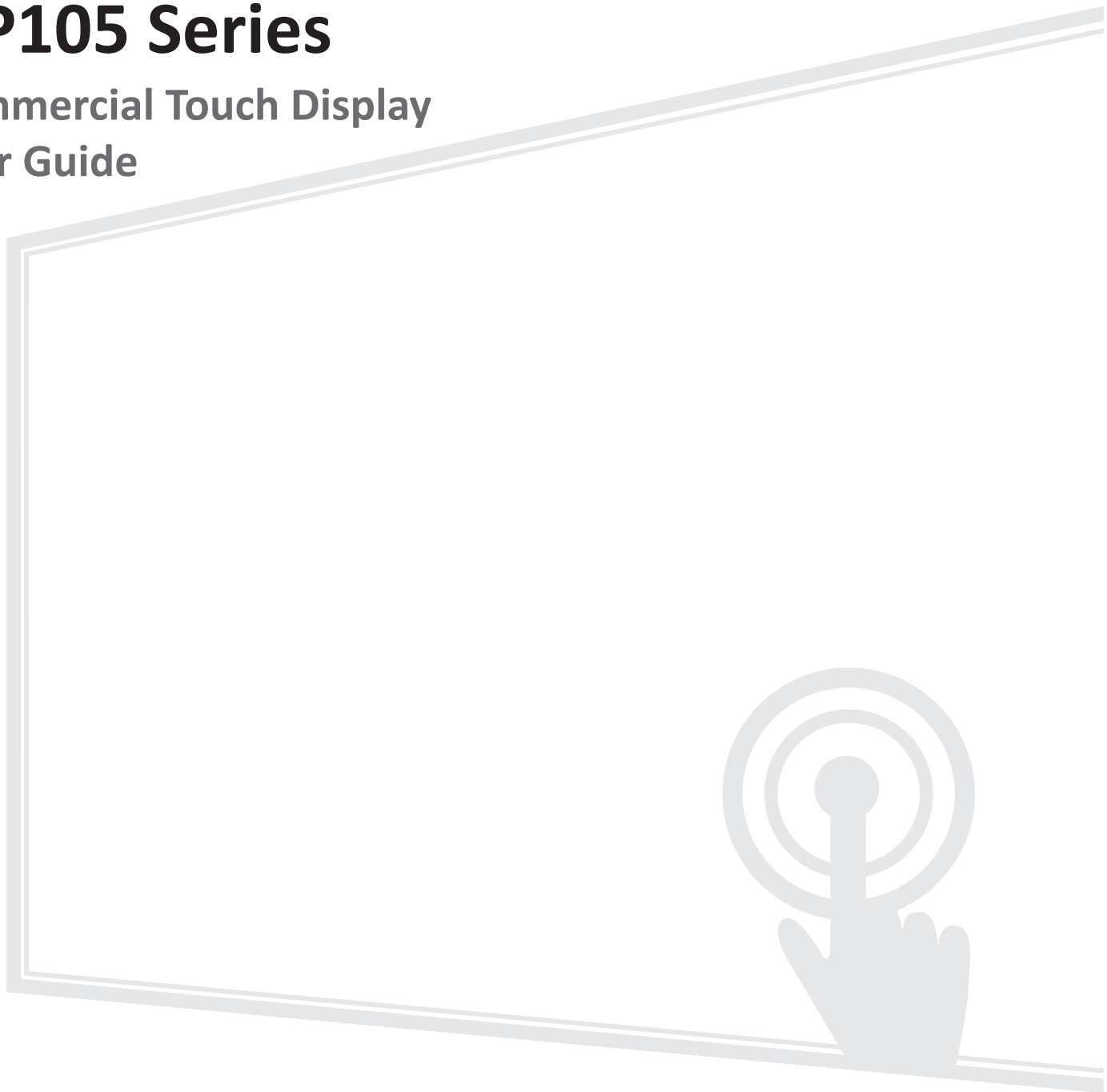

**IMPORTANT:** Please read this User Guide to obtain important information on installing and using your product in a safe manner, as well as registering your product for future service. Warranty information contained in this User Guide will describe your limited coverage from ViewSonic® Corporation, which is also found on our web site at <http://www.viewsonic.com> in English, or in specific languages using the Regional selection box of our website.

## **Thank you for choosing ViewSonic®**

As a world-leading provider of visual solutions, ViewSonic® is dedicated to exceeding the world's expectations for technological evolution, innovation, and simplicity. At ViewSonic®, we believe that our products have the potential to make a positive impact in the world, and we are confident that the ViewSonic® product you have chosen will serve you well.

Once again, thank you for choosing ViewSonic®!

# Safety Precautions

Please read the following **Safety Precautions** before you start using the device.

- Keep this user guide in a safe place for later reference.
- Read all warnings and follow all instructions.
- Do not use the device near water. To reduce the risk of fire or electric shock, do not expose the device to moisture.
- Never remove the rear cover. This display contains high-voltage parts. You may be seriously injured if you touch them.
- Avoid exposing the device to direct sunlight or other sources of sustained heat.
- Do not install near any heat sources such as radiators, heat registers, stoves, or other devices (including amplifiers) that may increase the temperature of the device to dangerous levels.
- Use a soft, dry cloth to clean the external housing. For more information, refer to the "Maintenance" section.
- When moving the device, be careful not to drop or bump the device on anything.
- Do not place the device on an uneven or unstable surface. The device may fall over resulting in an injury or a malfunction.
- Do not place any heavy objects on the device or connection cables.
- If smoke, an abnormal noise, or a strange odor is present, immediately turn the device off and call your dealer or ViewSonic®. It is dangerous to continue using the device.
- The device is a monitor with an LED backlight intended for general office use.
- Do not attempt to circumvent the safety provisions of the polarized or grounding-type plug. A polarized plug has two blades with one wider than the other. A grounding-type plug has two blades and a third grounding prong. The wide blade and the third prong are provided for your safety. If the plug does not fit into your outlet, obtain an adapter and do not attempt to force the plug into the outlet.
- When connecting to a power outlet, DO NOT remove the grounding prong. Please ensure grounding prongs are NEVER REMOVED.
- Protect the power cord from being treaded upon or pinched, particularly at the plug, and at the point where it emerges from the equipment. Ensure that the power outlet is located near the equipment so that it is easily accessible.
- Only use attachments/accessories specified by the manufacturer.
- When a cart is used, use with caution when moving the cart/equipment combination to avoid injury from tipping over.

- Disconnect the power plug from the AC outlet if the device is not being used for a long period of time.
- Place the device in a well-ventilated area. Do not place anything on the device that prevents heat dissipation.

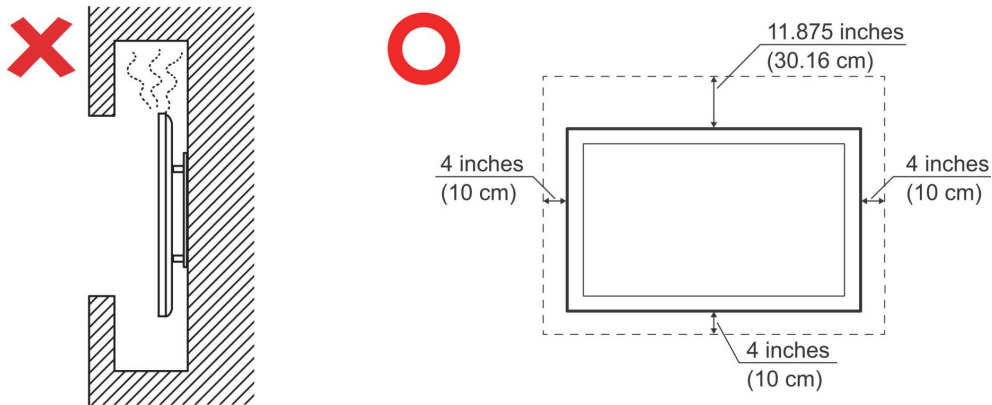

## IMPORTANT

To ensure the optimal performance and longevity of your display, it is essential to follow the recommended handling, mounting, and storage procedures. Placing the display in a horizontal position can lead to a range of potential issues, including:

- Excessive stress on the display's structural components, resulting in the formation of cracks or distortions along the edges.
- Uneven weight distribution, which can cause the screen to warp, sustain internal damage, or crack over time.
- Thermal-related damage, as the internal components may not be able to dissipate heat as intended, leading to potential failure or permanent damage.

Furthermore, altering the display's form can also compromise the integrity of its internal components, including the sensitive LCD cells, which can result in a permanent degradation of the display's quality.

To prevent such issues and maintain the display's optimal condition, it is recommended to always mount, handle, transport, and store it in a vertical position. Failure to do so may void the warranty and compromise the display's performance and lifespan.

**NOTE:** Any damage resulting from the misuse or improper handling of the display is not covered under warranty.

**Caution:**

Immediately unplug your device from the wall outlet and refer servicing to a qualified service personnel under the following conditions:

- When the power supply cord or plug is damaged.
- If liquid has been spilled onto or objects have fallen into the unit.
- If the unit has been exposed to moisture.
- If the unit does not operate normally or has been dropped.

Never place the device in an unstable location. The device may fall, causing serious personal injury or death. Many injuries, particularly to children, can be avoided by taking simple precautions such as:

- Using cabinets or stands recommended by the manufacturer of the device.
- Only using furniture that can safely support the device.
- Ensuring the device is not overhanging the edge of the supporting furniture.
- Not placing the device on tall furniture (e.g., cupboards or bookcases) without anchoring both the furniture and the device to a suitable support.
- Not placing the device on cloth or other materials that may be located between the device and supporting furniture.
- Educating children about the dangers of climbing on furniture to reach the device or its controls.

If the existing device is going to be retained and relocated, the same considerations as above should be applied.

# Contents

|  |           |
|--|-----------|
| <b>Safety Precautions.....</b>                         | <b>3</b>  |
| <b>Introduction .....</b>                              | <b>11</b> |
| Package Contents .....                                 | 11        |
| IFP92UW.....   | 11        |
| IFP105UW/IFP105UW-N .....                              | 12        |
| IFP105S/IFP105G .....                                  | 13        |
| Wall Mount Kit Specifications (VESA) .....             | 14        |
| IFP92UW.....   | 14        |
| IFP105S/IFP105G/IFP105UW/IFP105UW-N .....              | 15        |
| Product Overview .....                                 | 16        |
| Control Panel and Front I/O .....                      | 17        |
| I/O Panel.....   | 18        |
| Remote Control .....                                   | 20        |
| Using Gestures .....                                   | 24        |
| <b>Making Connections .....</b>                        | <b>26</b> |
| Connecting to Power .....                              | 26        |
| Connecting to External Devices and Enabling Touch..... | 27        |
| DisplayPort Connection.....                            | 28        |
| HDMI Connection .....                                  | 28        |
| USB Type C Connection .....                            | 28        |
| RS-232 Connection .....                                | 29        |
| USB Connection .....                                   | 30        |
| USB Type A .....                                       | 30        |
| USB Type C .....                                       | 30        |
| Network Connection.....                                | 31        |
| Media Connection .....                                 | 32        |
| Audio Connection .....                                 | 33        |
| Audio In .....   | 33        |
| Audio Out .....  | 33        |
| SPDIF Connection .....                                 | 33        |
| Video Output Connection (HDMI Out) .....               | 34        |
| Optional Connections .....                             | 35        |
| Slot-in PC (OPS Slot) Installation .....               | 35        |
| Wi-Fi Card (Wi-Fi Slot) Installation .....             | 36        |
| UMB202 Camera Plate Installation .....                 | 37        |

|   |           |
|---|-----------|
| <b>Using the ViewBoard .....</b>                      | <b>38</b> |
| Turning On/Off the ViewBoard.....                     | 38        |
| Initial Launch Setup .....                            | 39        |
| Home Screen .....                                     | 41        |
| How to Sign Up.....                                   | 41        |
| Use as Guest.....                                     | 42        |
| Sign In.....  | 42        |
| Home Screen Message .....                             | 43        |
| Toolbar .....   | 44        |
| Toolbar Icons.....                                    | 45        |
| Applications .....                                    | 46        |
| Tools .....   | 47        |
| Control Bar .....                                     | 48        |
| Control Bar Icons.....                                | 48        |
| On-Screen Display (OSD) Menu - General Settings ..... | 49        |
| Input Source .....                                    | 50        |
| Display.....  | 52        |
| Low Blue Light Filter and Eye Health.....             | 54        |

|                                     |           |
|-------------------------------------|-----------|
| <b>System Settings .....</b>        | <b>56</b> |
| Network & Internet .....            | 56        |
| Wi-Fi .....                         | 57        |
| Ethernet .....                      | 58        |
| Wireless Hotspot .....              | 59        |
| Display .....                       | 63        |
| Wallpaper .....                     | 64        |
| Protection.....                     | 65        |
| HDMI Out .....                      | 66        |
| Preferences.....                    | 67        |
| Touch.....                          | 68        |
| Language .....                      | 68        |
| Keyboard & Input Method .....       | 69        |
| Date & Time .....                   | 70        |
| Boot Mode & Advanced Settings ..... | 71        |
| Startup & Shutdown.....             | 73        |
| Toolbar Settings .....              | 75        |
| Multi-Window Mode.....              | 75        |
| Sound Setting .....                 | 75        |
| Input Source .....                  | 76        |
| Label Input Source.....             | 77        |
| Source .....                        | 78        |
| Apps.....                           | 79        |
| Apps .....                          | 80        |
| System .....                        | 82        |
| Storage .....                       | 83        |
| Clone to USB.....                   | 84        |
| Display ID.....                     | 85        |
| Security.....                       | 86        |
| System Update .....                 | 88        |
| About Device .....                  | 89        |

|  |            |
|--|------------|
| <b>Pre-installed Applications and Settings.....</b>            | <b>90</b>  |
| myViewBoard .....  | 90         |
| Screen Recorder .....  | 93         |
| vCast .....  | 94         |
| Display Group Settings .....                                   | 96         |
| Synchronized Group Screen All the Time .....                   | 98         |
| Share a Screen to the Display Group (One to Many Casting)..... | 98         |
| Moderator Mode .....   | 99         |
| Broadcast .....  | 100        |
| Multiple Screen Sharing .....                                  | 100        |
| Preview Screen.....  | 100        |
| Touch.....   | 100        |
| Casting from Windows, MacBook, and Chrome Devices .....        | 101        |
| Casting from Android Devices .....                             | 103        |
| Casting from Apple iOS Devices .....                           | 106        |
| Connecting to a ViewBoard from a Mobile Device .....           | 109        |
| Casting with Chromecast.....                                   | 110        |
| Casting with Miracast.....                                     | 112        |
| Other Default Applications .....                               | 114        |
| Browser .....  | 114        |
| Finder .....   | 115        |
| Office.....  | 116        |
| PIP (Picture-in-Picture).....                                  | 117        |
| Visualizer .....   | 119        |
| vSweeper.....  | 120        |
| <b>RS-232 Protocol.....</b>                                    | <b>121</b> |
| Description .....  | 121        |
| RS-232 Hardware Specification .....                            | 121        |
| LAN Hardware Specification.....                                | 122        |
| RS232 Communication Setting.....                               | 122        |
| LAN Communication Setting .....                                | 122        |
| Command Message Reference.....                                 | 122        |
| Protocol .....   | 123        |
| Set-Function Listing.....                                      | 123        |
| Get-Function Listing .....                                     | 129        |
| Remote Control Pass-through Mode .....                         | 137        |

|  |            |
|--|------------|
| <b>Appendix.....</b>                             | <b>140</b> |
| Display Modes .....                              | 140        |
| HDMI 1 & DisplayPort Mode .....                  | 140        |
| HDMI 2/3/4 & Type C Mode.....                    | 141        |
| Troubleshooting .....                            | 142        |
| Maintenance.....                                 | 144        |
| General Precautions .....                        | 144        |
| Cleaning the Screen.....                         | 144        |
| Cleaning the Case .....                          | 144        |
| <b>Regulatory and Service Information .....</b>  | <b>145</b> |
| Compliance Information .....                     | 145        |
| FCC Compliance Statement.....                    | 145        |
| Industry Canada Statement.....                   | 145        |
| CE Conformity for European Countries .....       | 145        |
| Declaration of RoHS2 Compliance.....             | 146        |
| ENERGY STAR Statement.....                       | 147        |
| Indian Restriction of Hazardous Substances ..... | 148        |
| Product Disposal at End of Product Life .....    | 148        |
| Copyright Information .....                      | 149        |
| Customer Service .....                           | 150        |
| Limited Warranty .....                           | 151        |
| Mexico Limited Warranty.....                     | 154        |

# Introduction

## Package Contents

IFP92UW

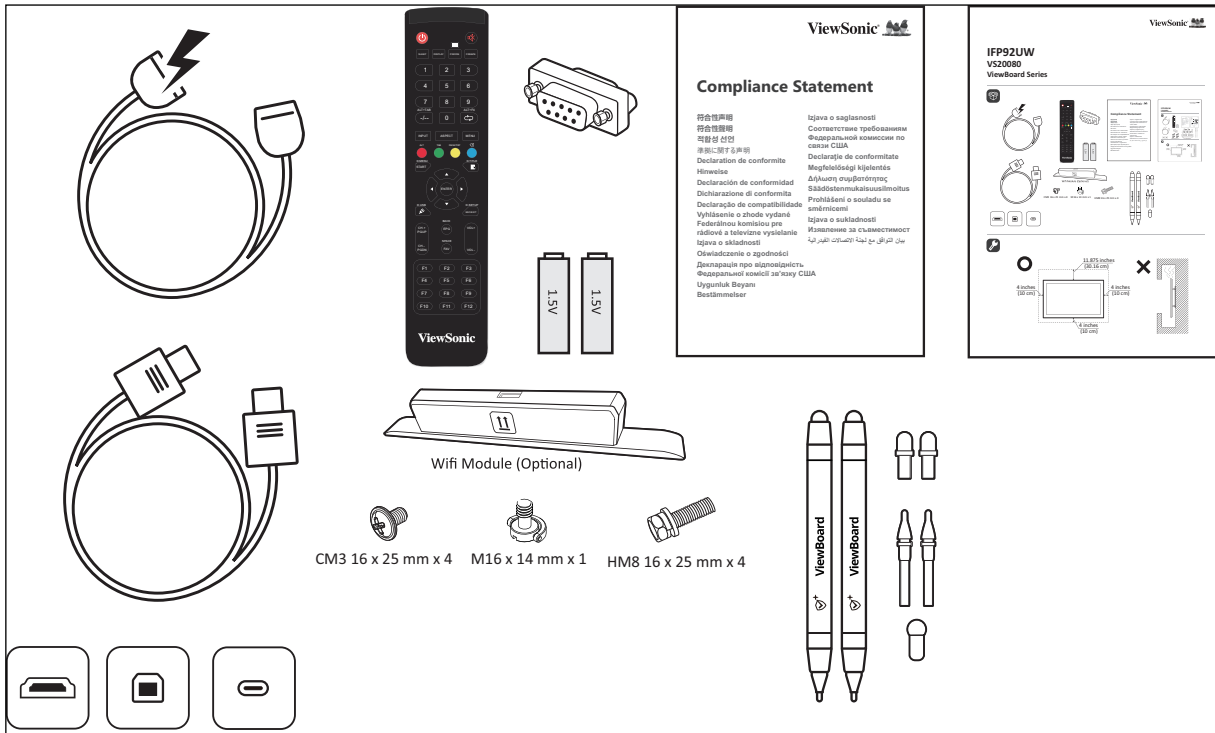

- HDMI Cable (3 m)
- Power Cable (by region)
- Remote Control
- AAA Battery
- USB Touch Cable (3 m)
- USB Type C Cable
- RS-232 Adapter
- 2 x Touch Pen
- 3 x Replacement Pen Nib
- 9 x Screw
- Quick Start Guide
- Compliance Statement

### NOTE:

- The cables included in your package may vary depending on your country. Please contact your local reseller for more information.
- If there is an installation requirement for the UMB202 or VB-CAM-201, you may purchase the VB-WMK-002 mounting accessory and use it with 3 mm flat washers. Please contact the after-sales service team to purchase the required parts and confirm the installation method.

# IFP105UW/IFP105UW-N

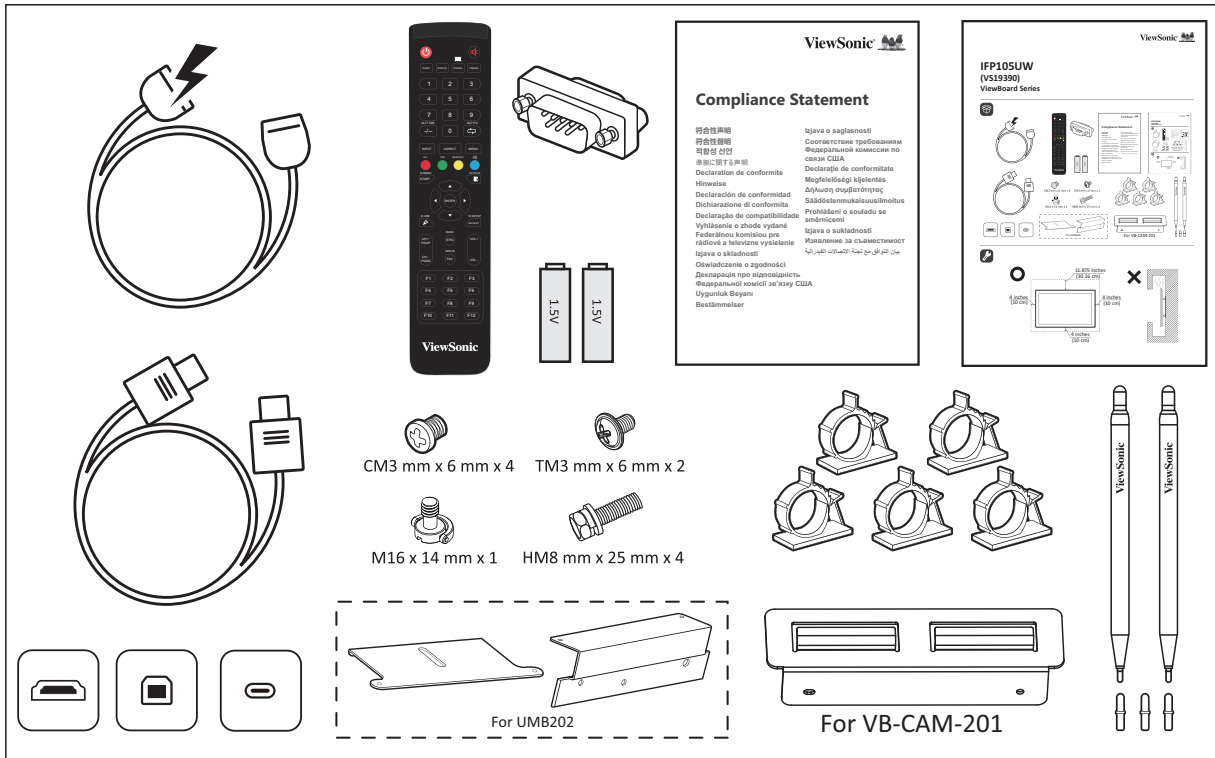

- HDMI Cable (3 m)
- Power Cable (by region)
- Remote Control
- AAA Battery
- USB Touch Cable (3 m)
- 2 x Touch Pen
- 3 x Replacement Pen Nib
- RS-232 Adapter
- 5 x Clamp
- 2 x Camera Plate
- 11 x Screw
- Quick Start Guide
- Compliance Statement
- USB Type C Cable

**NOTE:** The cables included in your package may vary depending on your country. Please contact your local reseller for more information.

# IFP105S/IFP105G

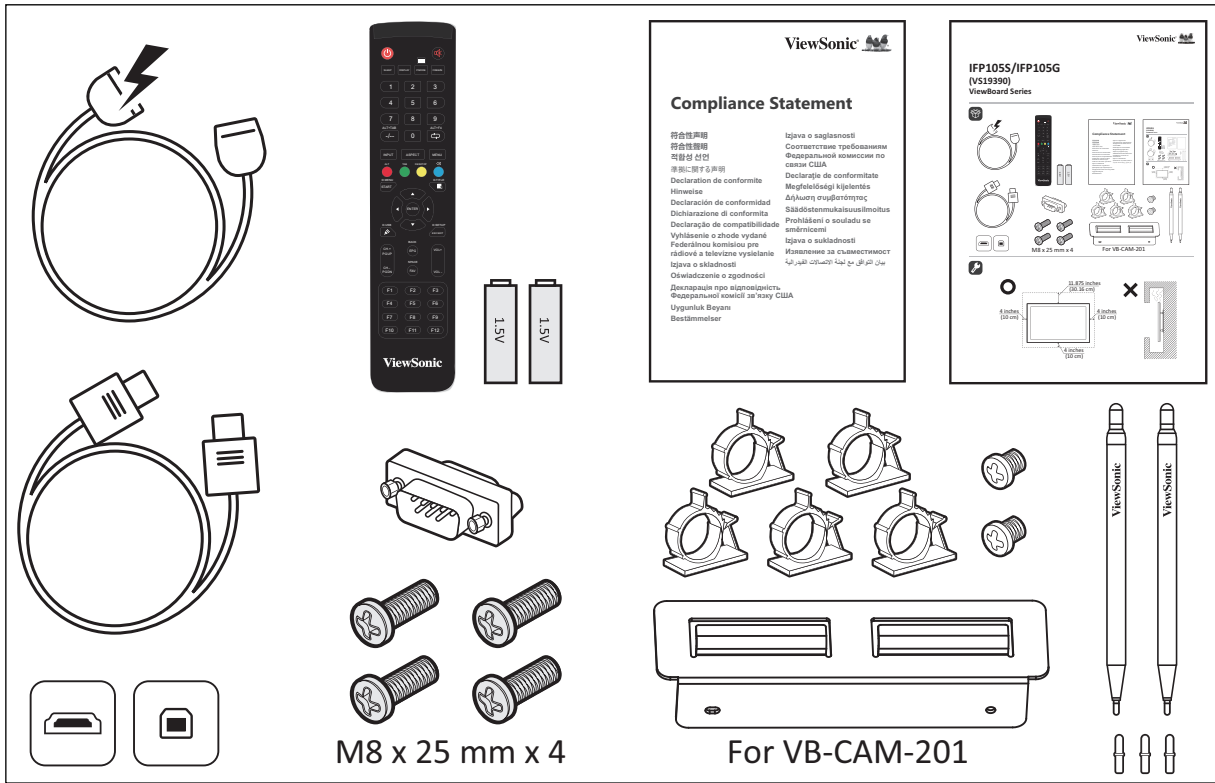

- HDMI Cable (3 m)
- Power Cable (by region)
- Remote Control
- AAA Battery
- USB Touch Cable (3 m)
- 2 x Touch Pen
- 3 x Replacement Pen Nib
- RS-232 Adapter
- 5 x Clamp
- 1 x Camera Plate
- 6 x Screw
- Quick Start Guide
- Compliance Statement

**NOTE:** The cables included in your package may vary depending on your country. Please contact your local reseller for more information.

# Wall Mount Kit Specifications (VESA)

## IFP92UW

**NOTE:** Please follow the instructions in the wall mount installation guide to install your wall mount or mobile mount bracket. If attaching to other building materials, please contact your nearest dealer.

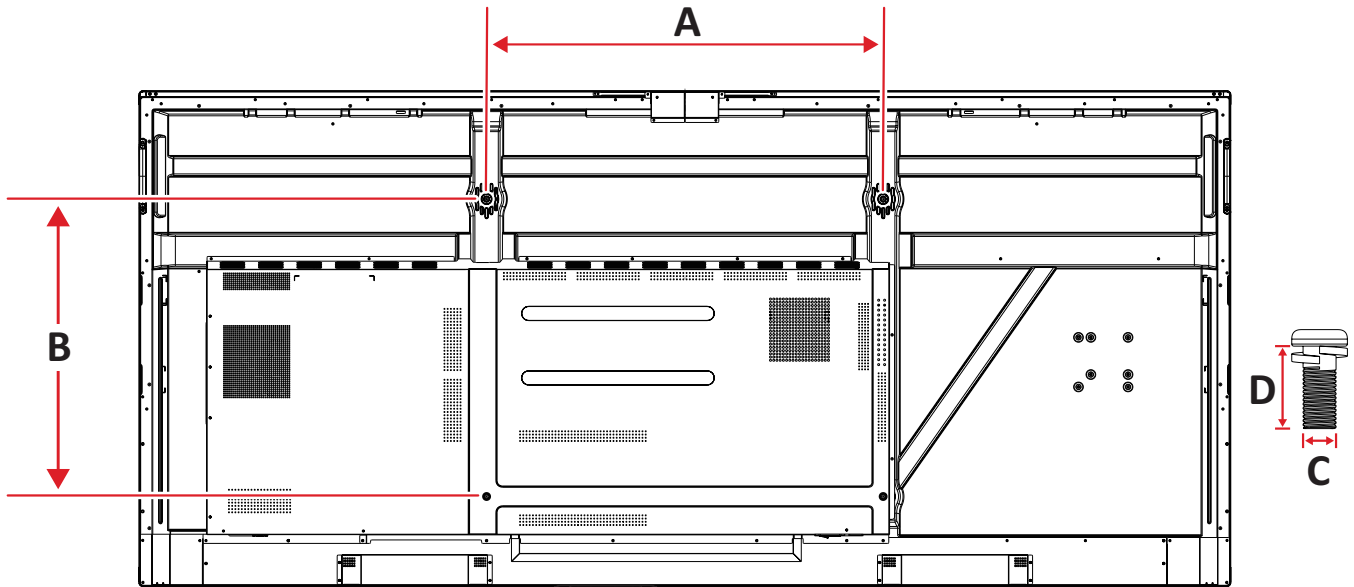

| Model   | VESA Spec. (A x B) | Standard Screw (C x D) | Quantity |
|---------|--------------------|------------------------|----------|
| IFP92UW | 800 x 600 mm       | M8 x 25 mm             | 4        |

**NOTE:**

- Do not use screws that are longer than the standard dimension, as they may cause damage to the inside of the display.
- Only mount the display in landscape orientation. Never mount in a portrait orientation.

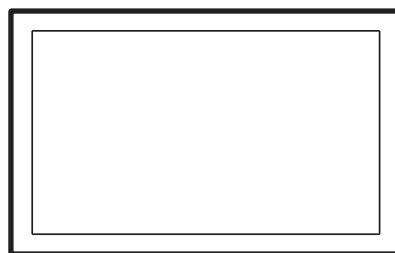
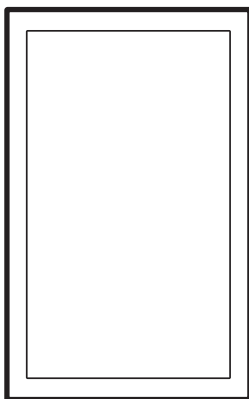

# IFP105S/IFP105G/IFP105UW/IFP105UW-N

**NOTE:** Please follow the instructions in the wall mount installation guide to install your wall mount or mobile mount bracket. If attaching to other building materials, please contact your nearest dealer.

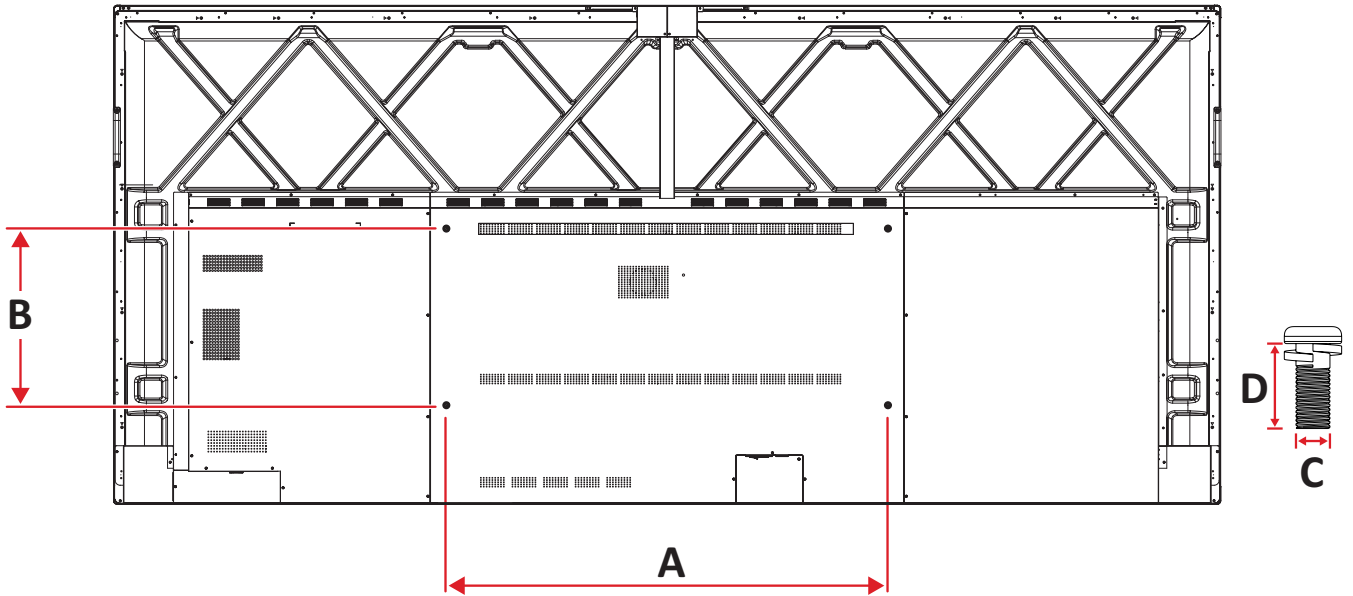

| Model  | VESA Spec. (A x B) | Standard Screw (C x D) | Quantity |
|--|--------------------|------------------------|----------|
| IFP105S<br>IFP105G<br>IFP105UW<br>IFP105UW-N | 1000 x 400 mm      | M8 x 25 mm             | 4        |

**NOTE:**

- Do not use screws that are longer than the standard dimension, as they may cause damage to the inside of the display.
- Only mount the display in landscape orientation. Never mount in a portrait orientation.

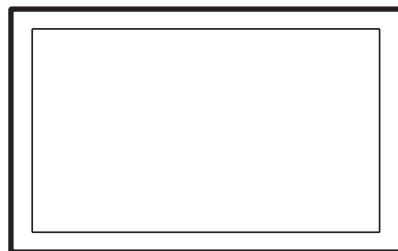
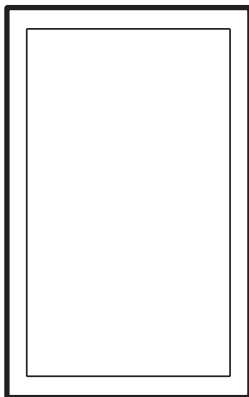

# Product Overview

## Front Panel





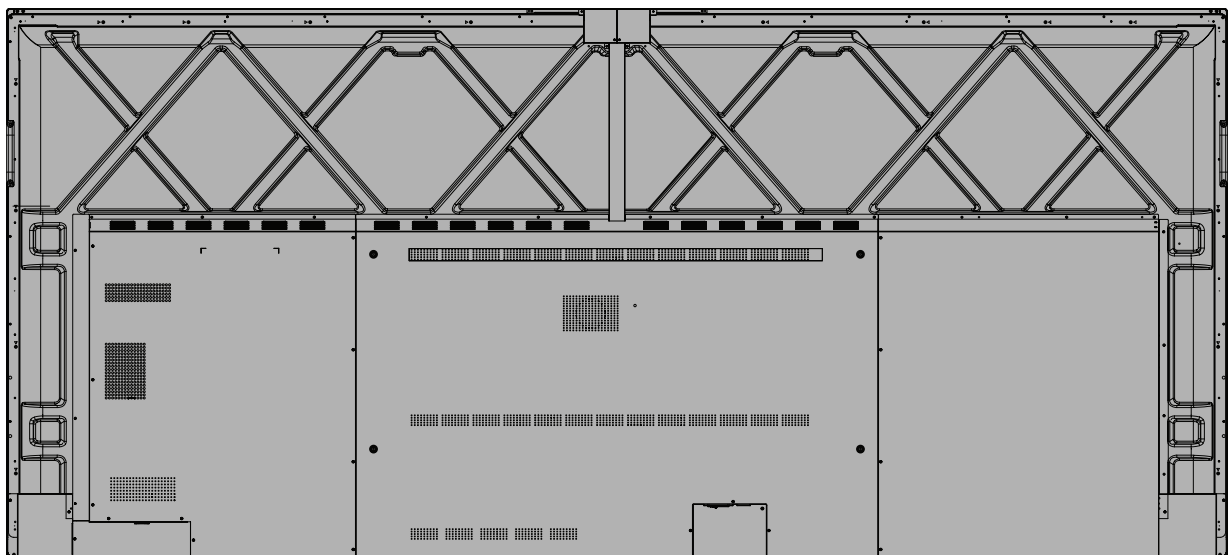

Control Panel and Front I/O

## Rear Panel

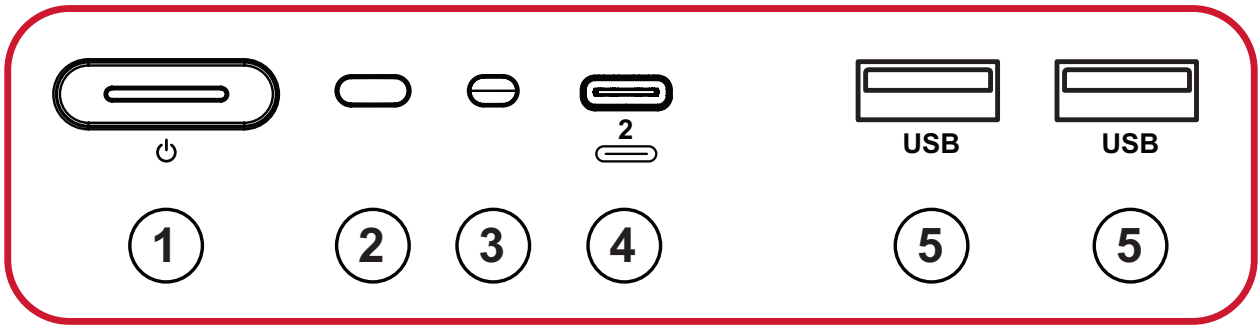

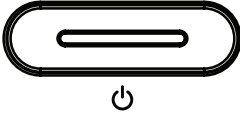
## Control Panel and Front I/O



| Number | Item  | Description  |
|--------|---|--|
| 1      |    | <ul style="list-style-type: none"> <li>• Power indicator light.</li> <li>• Press to turn ON the device.</li> <li>• Press to turn OFF/ON the display backlight only.</li> <li>• Press and hold to turn off the device.</li> </ul> |
| 2      |    | Remote Control receiver.   |
| 3      |  | Ambient Light Sensor to monitor the ambient light.   |
| 4      |  | <ul style="list-style-type: none"> <li>• USB Type C Power Delivery (15W, 5.0V~3.0A)</li> <li>• Connect to a PC with USB Type C output.</li> </ul>  |
| 5      |  | <ul style="list-style-type: none"> <li>• USB Type A input</li> <li>• Connect USB devices such as hard disks, keyboard, mouse, etc.</li> <li>• Automatically switches between PC and external PC.</li> </ul>                      |

# I/O Panel

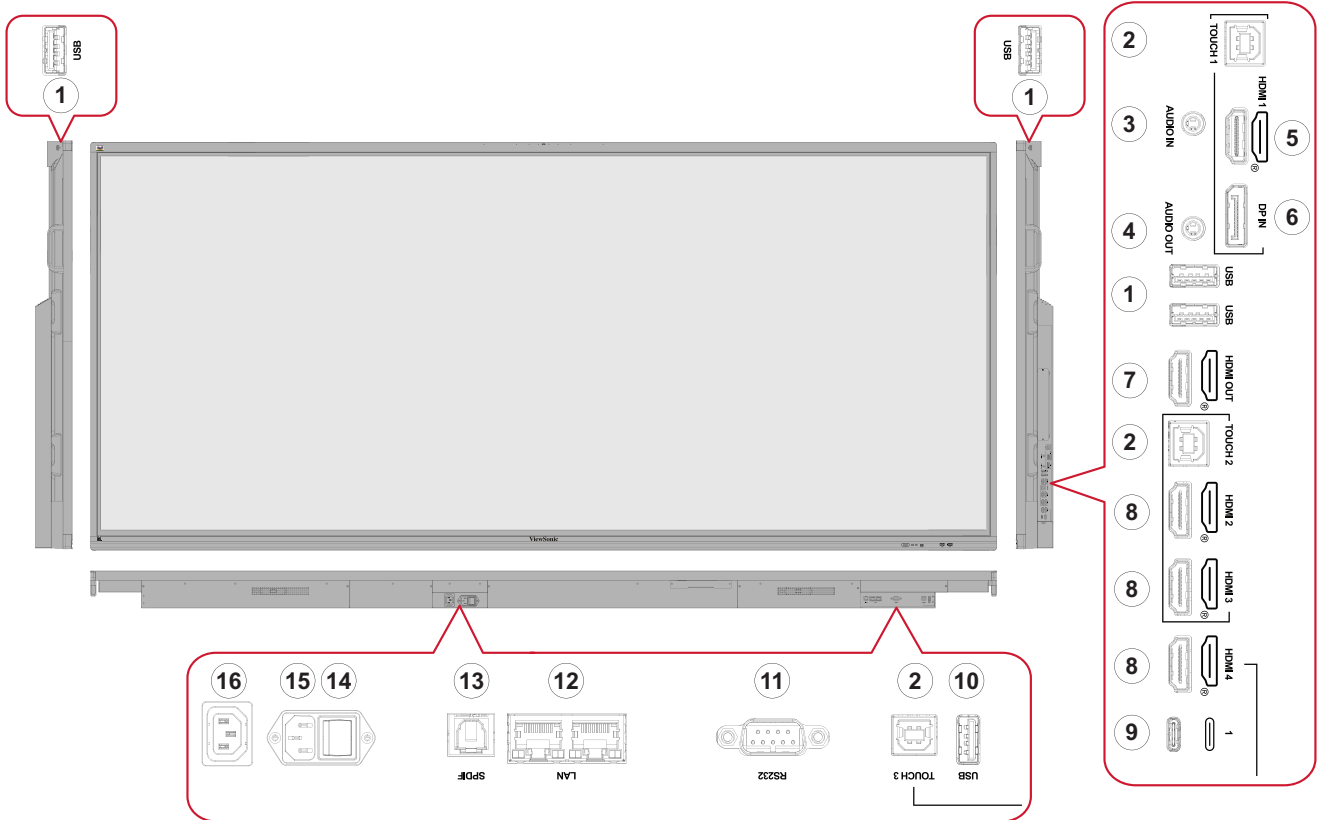

Figure 1

| Number | Item        | Description  |
|--------|-------------|--|
| 1      | USB 3.0     | <ul style="list-style-type: none"> <li>• USB Type A input</li> <li>• Connect USB devices such as hard disks, keyboard, mouse, etc.</li> <li>• Automatically switches between PC and external PC.</li> </ul>  |
| 2      | TOUCH 1/2/3 | Touch signal output to external PC<br><b>NOTE:</b> <ul style="list-style-type: none"> <li>• <b>TOUCH 1</b> supports <b>HDMI 1</b> and <b>DP IN</b>.</li> <li>• <b>TOUCH 2</b> supports <b>HDMI 2</b> and <b>HDMI 3</b>.</li> <li>• <b>TOUCH 3</b> supports <b>HDMI 4</b>.</li> </ul> |
| 3      | AUDIO IN    | External computer audio input.   |
| 4      | AUDIO OUT   | Audio out to an external speaker.  |
| 5      | HDMI 1      | <ul style="list-style-type: none"> <li>• 5K<sup>1</sup> high-definition input.</li> <li>• Connect to a PC with HDMI output, set-top box, or other video device.</li> </ul>   |
| 6      | DP IN       | <ul style="list-style-type: none"> <li>• DisplayPort Input</li> <li>• Connect to a PC or other video device with DisplayPort output.</li> </ul>  |
| 7      | HDMI OUT    | Extend content out to another display device.  |

1 - The 5K display quality will depend on the cable and signal stability.

| Number | Item         | Description   |
|--------|--------------|---|
| 8      | HDMI 2/3/4   | <ul style="list-style-type: none"> <li>High-definition input.</li> <li>Connect to a PC with HDMI output, set-top box, or other video device.</li> </ul>       |
| 9      | USB Type C   | <ul style="list-style-type: none"> <li>USB Type C Power Delivery (65W, 20.0V~3.25A)</li> <li>DP 1.2 with USB 3.0 return</li> <li>10M/100M Ethernet</li> </ul> |
| 10     | USB 2.0      | <ul style="list-style-type: none"> <li>USB Type A input</li> <li>For firmware update.</li> </ul>  |
| 11     | RS-232       | <ul style="list-style-type: none"> <li>Serial interface</li> <li>For mutual transfer of data between devices.</li> </ul>                                      |
| 12     | LAN          | <ul style="list-style-type: none"> <li>Standard RJ45 (10M/100M/1G) internet</li> <li>For ViewBoard and Slot-in PC use.</li> </ul>                             |
| 13     | SPDIF        | SPDIF output.   |
| 14     | Power Switch | Turn ON/OFF AC power supply.  |
| 15     | AC IN        | AC power input.   |
| 16     | AC OUT       | AC power output.  |

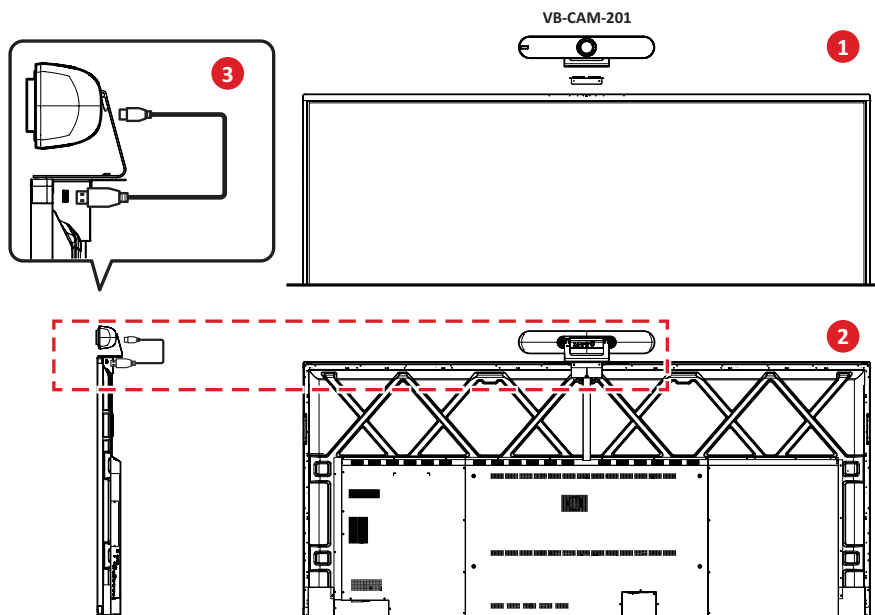
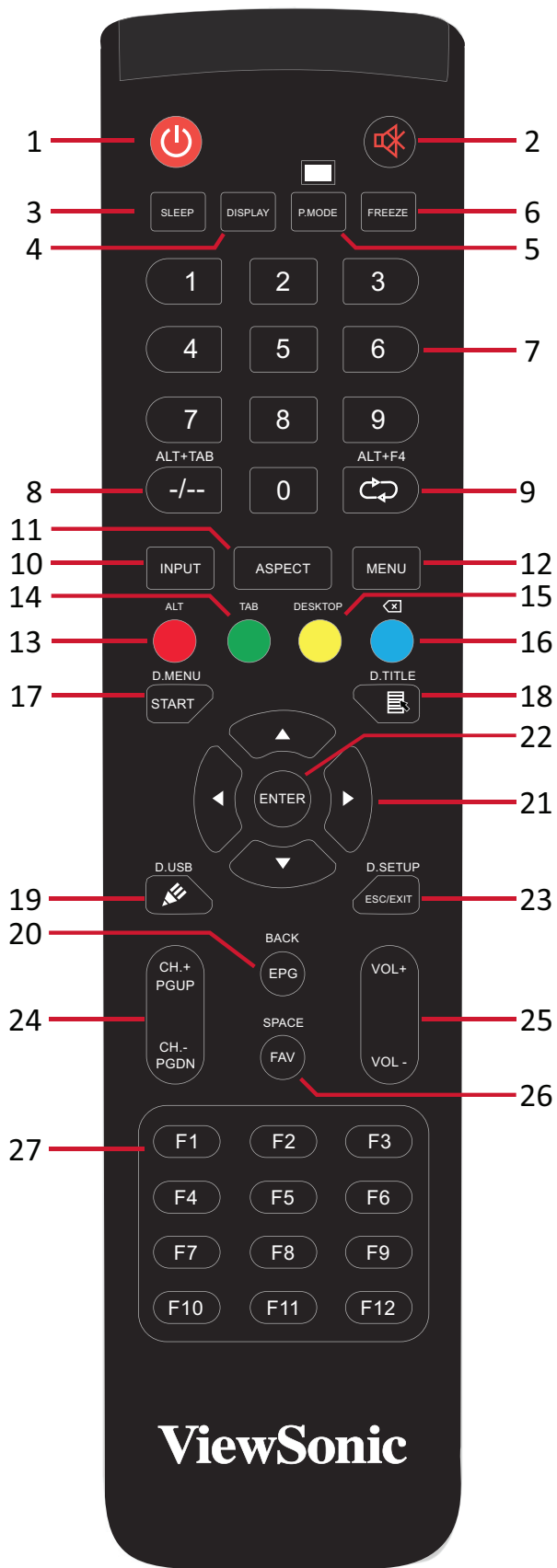











Figure 2

**NOTE:**

- **Figure 1** - There are two, a numbered (1 2) and unnumbered (≡), versions of the USB Type C port icon label on the Control Panel and I/O for this product line. Both versions' USB Type C ports function the same.
- **Figure 2** - For the best viewing angle, it is recommended to install the USB camera on top of the ViewBoard and connect the camera to the upper USB port.

# Remote Control



| Number | Item  | Description   |
|--------|---|---|
| 1      |    | Power ON/OFF  |
| 2      |    | Mute/Unmute   |
| 3      | SLEEP   | Sleep Mode  |
| 4      | DISPLAY   | For Non-Android sources; display current input source information           |
| 5      | P.MODE  | Blank Screen  |
| 6      | FREEZE  | Freeze Screen   |
| 7      |   | Numeric input buttons   |
| 8      | ALT+TAB<br>-/--   | Slot-in computer space bar Alt+Tab  |
| 9      | ALT+F4<br>   | Slot-in computer, close program window                                      |
| 10     | INPUT   | Input source selection  |
| 11     | ASPECT  | Back to slot-in system main interface                                       |
| 12     | MENU  | For Android, access Settings; for other sources, access Touch Menu settings |
| 13     | Red / ALT   | Screen capture  |
| 14     | Green / TAB   | PC <sup>1</sup> [Tab] button  |
| 15     | Yellow / DESKTOP  | Switch to slot-in PC desktop  |
| 16     | BLUE/    | PC <sup>1</sup> [Backspace] button  |
| 17     | START / D.MENU  | PC <sup>1</sup> [Windows] button  |
| 18     |  / D.TITLE   | PC <sup>1</sup> [Menu] button   |
| 19     |  / D.USB   | Writing software setup  |
| 20     | EPG/BACK  | Return button   |
| 21     |  /  /  /  | Scroll up, down, left, and right  |
| 22     | ENTER   | Confirm selection/state   |
| 23     | ESC / EXIT /<br>D.SETUP   | Shortcut button to exit dialogue boxes                                      |
| 24     | CH.+ / PGUP / CH.- /<br>PGDN  | CH+: PC previous page<br>CH-: PC next page                                  |
| 25     | VOL+ / VOL-   | Increase/Decrease volume  |
| 26     | FAV / SPACE   | PC <sup>1</sup> [Space] button  |
| 27     | F1-F12  | Built-in computer F1 - F12 function button                                  |

<sup>1</sup> All computer-related function keys are not available without a slot-in computer.

## Inserting Remote Control Batteries

To insert batteries into the remote control:

1. Remove the cover on the rear of the remote control.
2. Insert two “AAA” batteries, ensuring the “+” symbol on the battery matches the “+” on the battery post.
3. Replace the cover by aligning it with the slot on the remote control and snapping the latch shut.

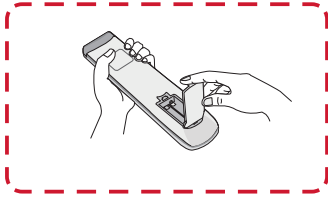

(1)

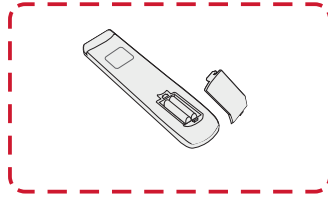

(2)

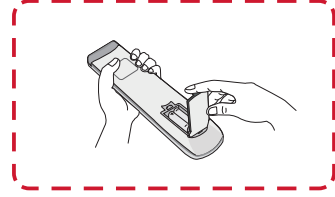

(3)

**WARNING:** There is a risk of explosion if batteries are replaced with the incorrect type.

### NOTE:

- It is recommended that you do not mix battery types.
- Always dispose of old batteries in an environmentally friendly way. Contact your local government for more information on how to dispose of batteries safely.

## Remote Control Receiver Range

The working range of the remote control is shown here. It has an effective range of 8 meters, 30° degrees left and right. Ensure there is nothing obstructing the remote control's signal to the receiver.

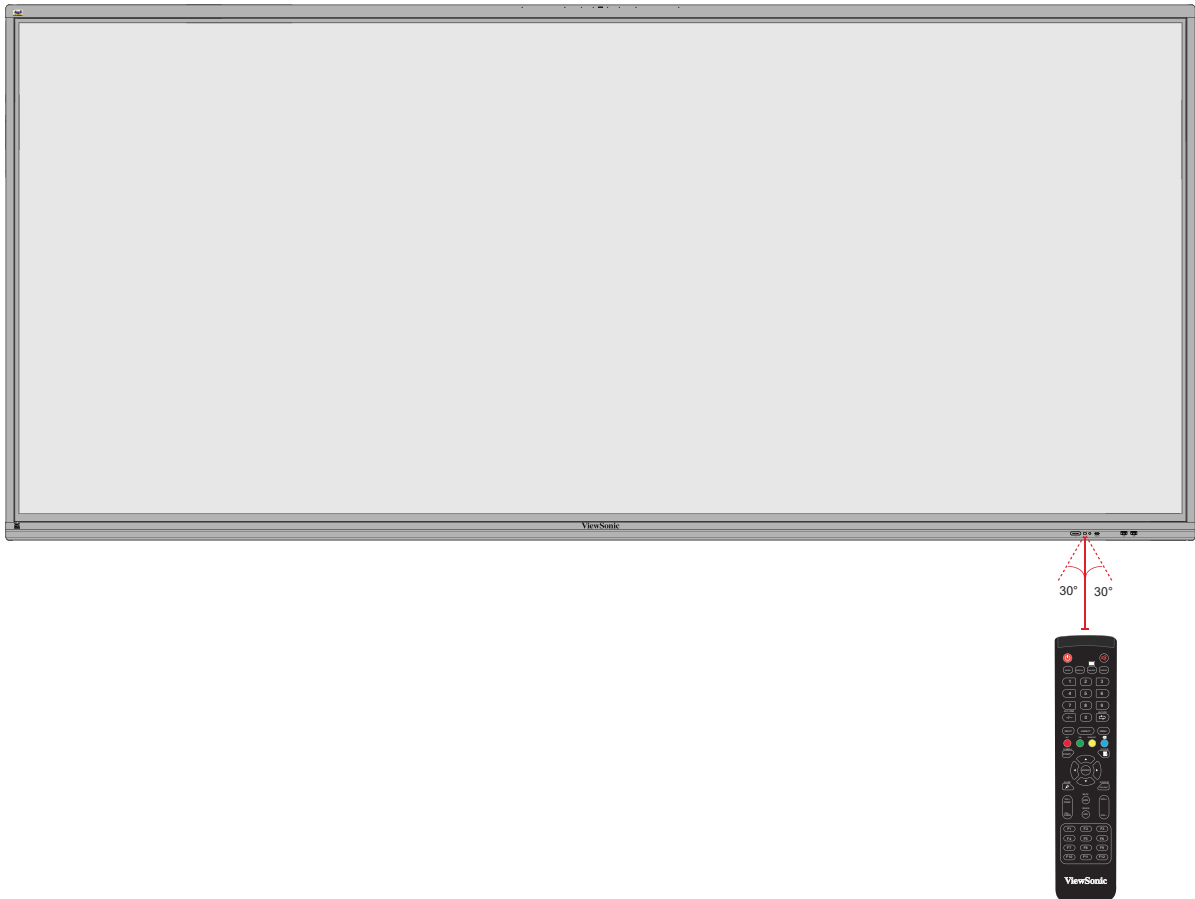

## Using Gestures

Touch gestures allow the user to use pre-determined commands without using a keyboard or mouse. Using gestures on the ViewBoard, the user can select/deselect objects, change the location of an object, access settings, erase digital ink, and much more.

### Select and Deselect an Object (Clicking)

Press and release the ViewBoard to select/deselect options or objects. This is like a single, standard left mouse click.

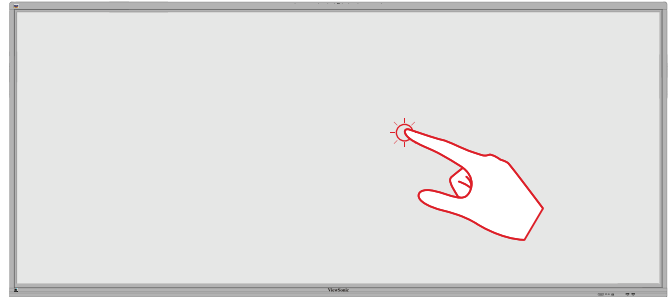

### Display Menu Options (Right-Clicking)

Press and hold the ViewBoard with your finger. This is like a single, standard right mouse click.

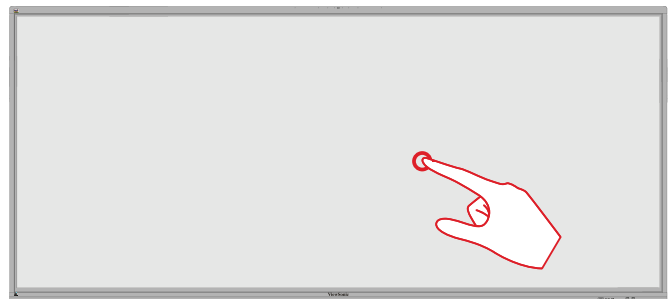

### Double-Clicking

Quickly press and release twice in the same location on the ViewBoard. This is like a double, standard left mouse click.

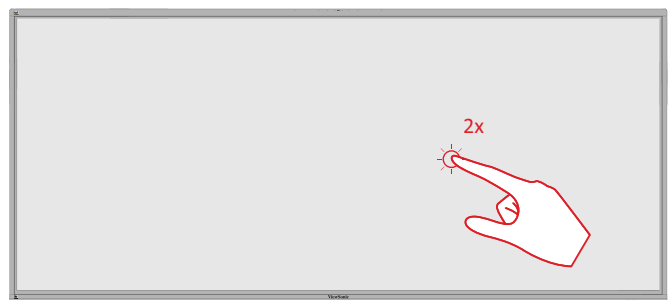

## Moving an Object

Press and hold the object on the ViewBoard and slowly drag it with your finger to your desired location.

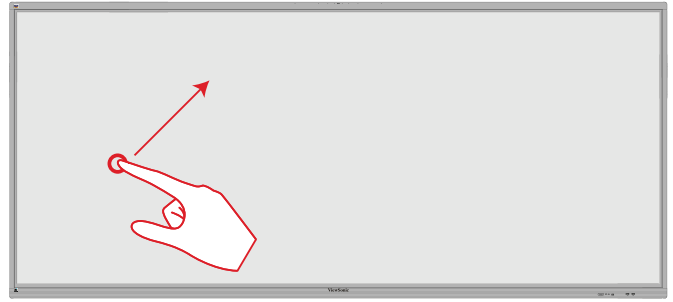

## Erasing Digital Ink

Use your flattened hand, palm, or fist on the ViewBoard and move your hand across the area which you wish to erase.

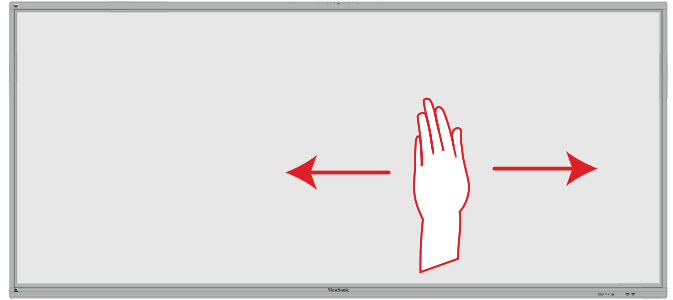

## Swipe Up for General Settings

Swipe up from the bottom of the ViewBoard to launch the General Settings.

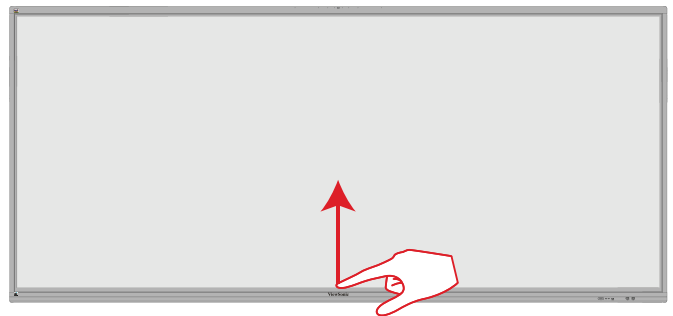

# Making Connections

## Connecting to Power

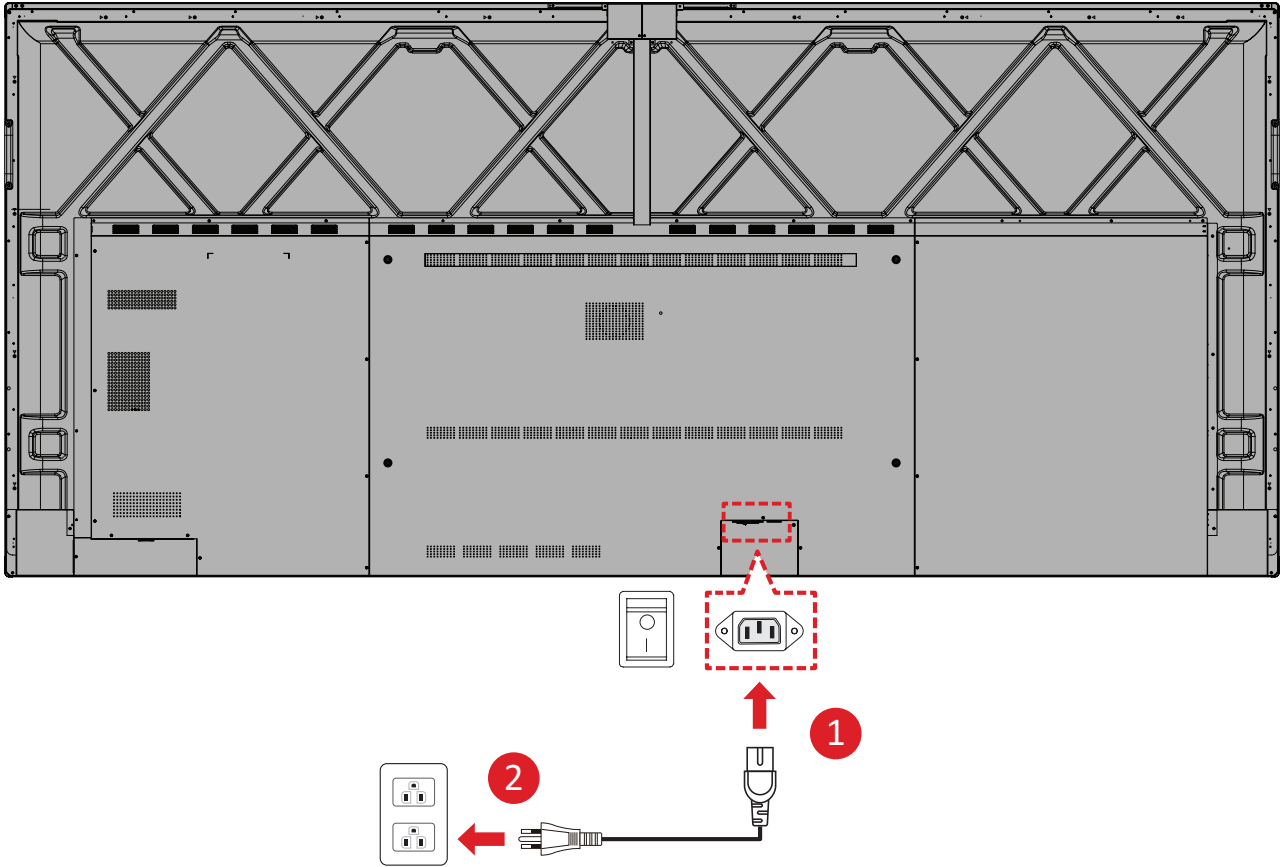

1. Connect the power cord to the AC IN jack at the rear of the display.
2. Plug the power cord plug into a power outlet.

# Connecting to External Devices and Enabling Touch

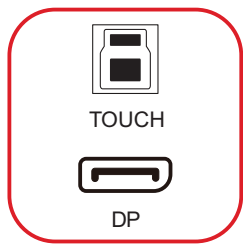

or

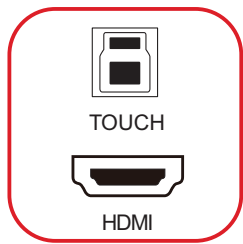

or

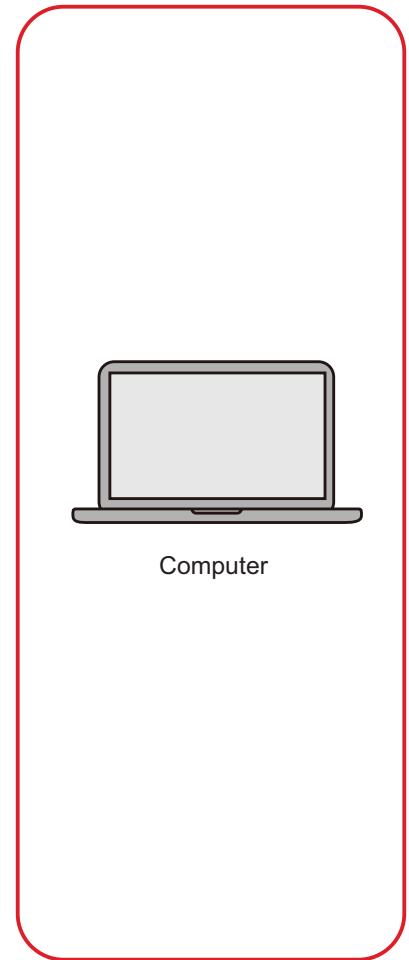
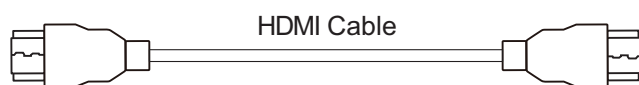
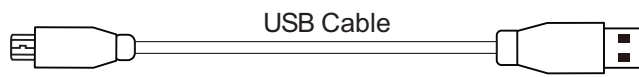
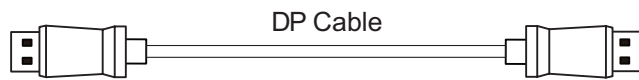
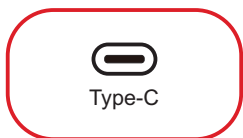

Your external device(s) can be connected in any of the following configurations:

### **DisplayPort Connection**

To connect via DisplayPort:

1. Connect a DisplayPort cable from your external device to the **DP IN** port on the ViewBoard.
2. Connect a USB Type B to A cable to the external device from the **TOUCH 1** port of the ViewBoard.

**NOTE:** The **TOUCH 1** port is for the **HDMI 1** and **DP** ports. The **TOUCH 2** port is for the **HDMI 2** and **HDMI 3** ports. The **TOUCH 3** port is for the **HDMI 4** port.

### **HDMI Connection**

To connect via HDMI:

1. Connect an HDMI cable from your external device to the **HDMI 1/HDMI 2/HDMI 3/HDMI 4** port on the ViewBoard.
2. Connect a USB Type B to A to the external device from the appropriate **TOUCH** port of the ViewBoard.

**NOTE:** The **TOUCH 1** port is for the **HDMI 1** and **DP** ports. The **TOUCH 2** port is for the **HDMI 2** and **HDMI 3** ports. The **TOUCH 3** port is for the **HDMI 4** port.

### **USB Type C Connection**

To connect via Type C:

Connect a Type C cable from your external device to a **Type C** port on the ViewBoard.

## RS-232 Connection



When you use a RS-232 serial cable to connect the display to an external computer or control system, certain functions can be controlled remotely such as: power on and off, volume adjustment, input select, brightness, and more.

## USB Connection

Just like any PC, it is easy to connect various USB devices and other peripherals to your ViewBoard.

### USB Type A

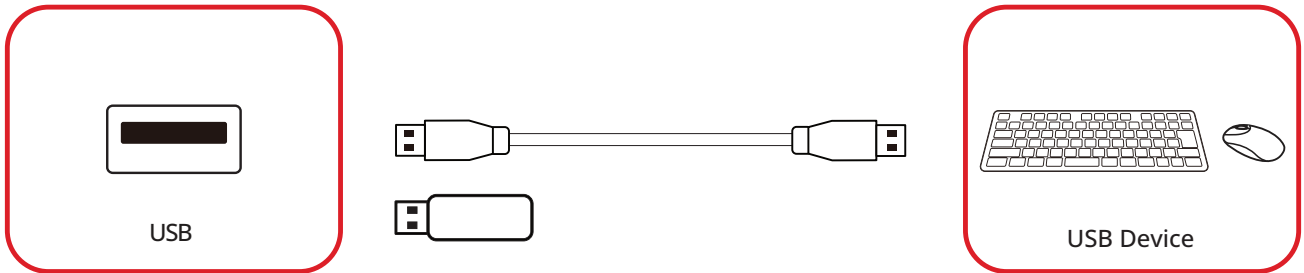

Plug the USB device or storage drive into a USB Type A port of the ViewBoard.

### USB Type C

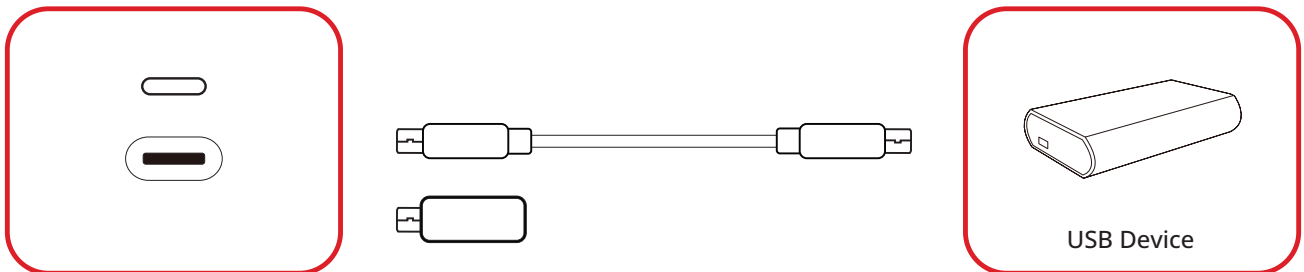

Plug the USB device or storage drive into the USB Type C port of the ViewBoard.

## Network Connection



To connect to a local network, connect an Ethernet cable to your network, then connect the other end to a **LAN** port of the ViewBoard.

## Media Connection

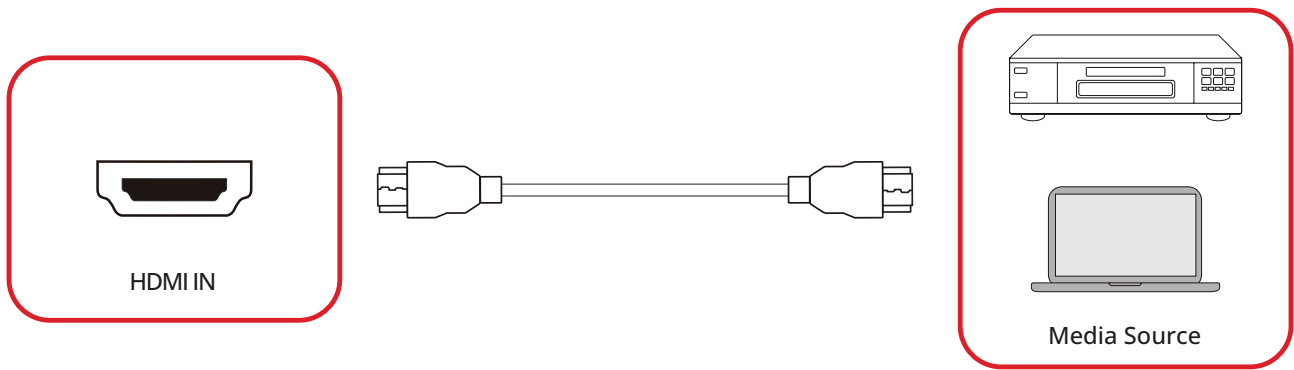

To connect to a media source:

1. Connect an HDMI cable to a **HDMI** port on your ViewBoard and peripheral device.
2. Plug in the power cord of your ViewBoard, and turn on the power supply switch.
3. Press the **Power** button on the ViewBoard to turn the screen on.
4. Press the **INPUT** button on the remote control and switch to the HDMI input source.

## Audio Connection

The ViewBoard supports **Audio In**, **Audio Out**, and **SPDIF**.

### Audio In

To play audio from your external device through the ViewBoard's speakers, connect one end of an audio cable to your external device, and the other end to the ViewBoard's **AUDIO IN** port.

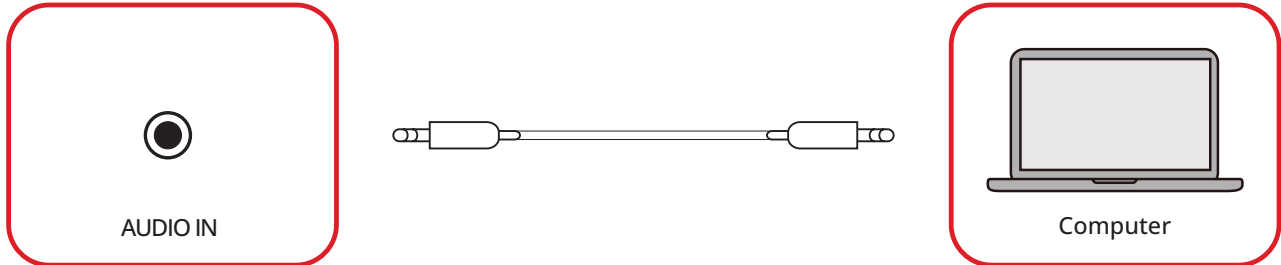

### Audio Out

To play audio from the display through an external speaker, connect one end of an audio cable to the external speaker, and the other end to the ViewBoard's **Audio Out** port.

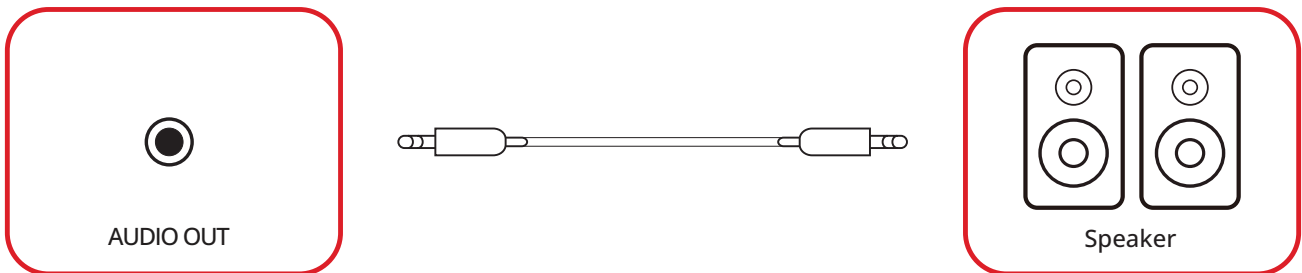

### SPDIF Connection

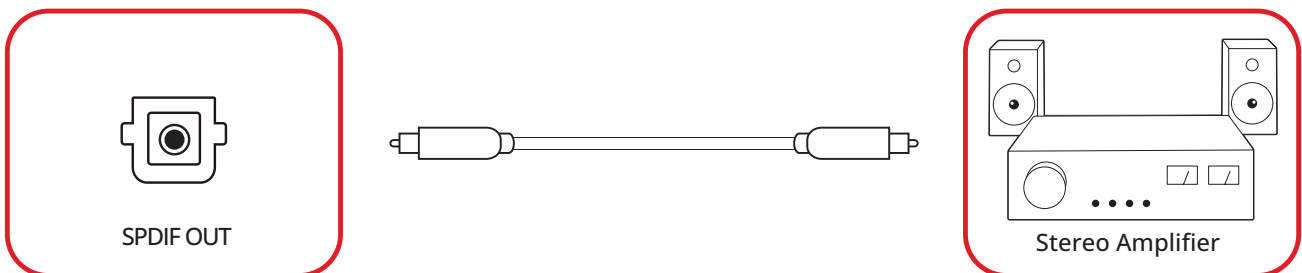

To connect to an external sound system:

1. Connect an optical cable from the **SPDIF** port to your sound system's optical connector.
2. Plug in the power cord of your ViewBoard, and turn on the power supply switch.
3. Press the **Power** button on the ViewBoard to turn the screen on.

## Video Output Connection (HDMI Out)



To output video via a display device:

1. Connect an HDMI cable to the **HDMI IN** port of your display device, and the other end to the **HDMI OUT** port of the ViewBoard.
2. Plug in the power cord of the ViewBoard, and turn on the power supply switch.
3. Press the **Power** button on the ViewBoard to turn the screen on.
4. Press the **INPUT** button on the remote control and switch to the HDMI IN input source.

## Optional Connections

The ViewBoard comes with an **OPS Slot** as well as a **Wi-Fi Slot** for optional add-ons such as a slot-in PC (e.g., VPC3X Series/VPCF5) or Wi-Fi card (e.g., VB-WIFI-004).

### Slot-in PC (OPS Slot) Installation

1. Remove the **OPS Slot** cover of the display.

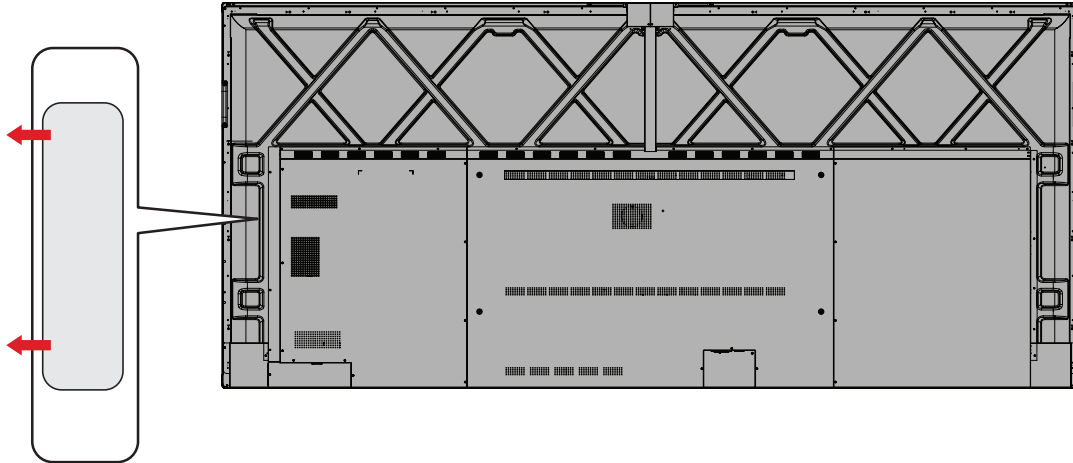

2. Carefully insert the slot-in PC into the **OPS Slot** of the display.

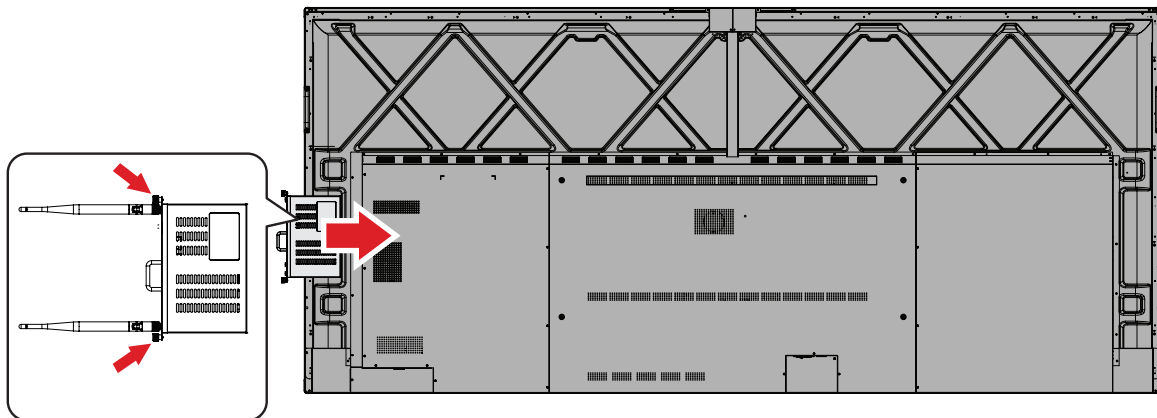

3. Secure the slot-in PC to the display.

## Wi-Fi Card (Wi-Fi Slot) Installation

1. Remove the **Wi-Fi Slot** cover of the display.

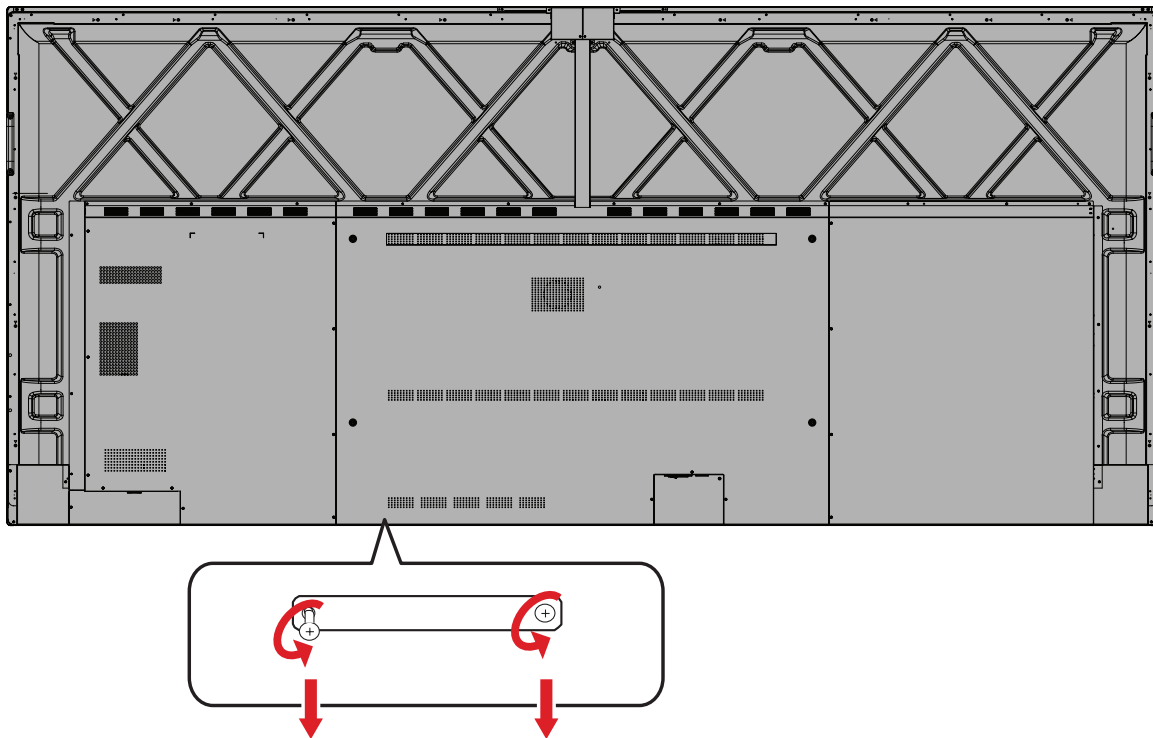

2. Carefully insert the slot-in Wi-Fi card into the **Wi-Fi Slot** of the display.

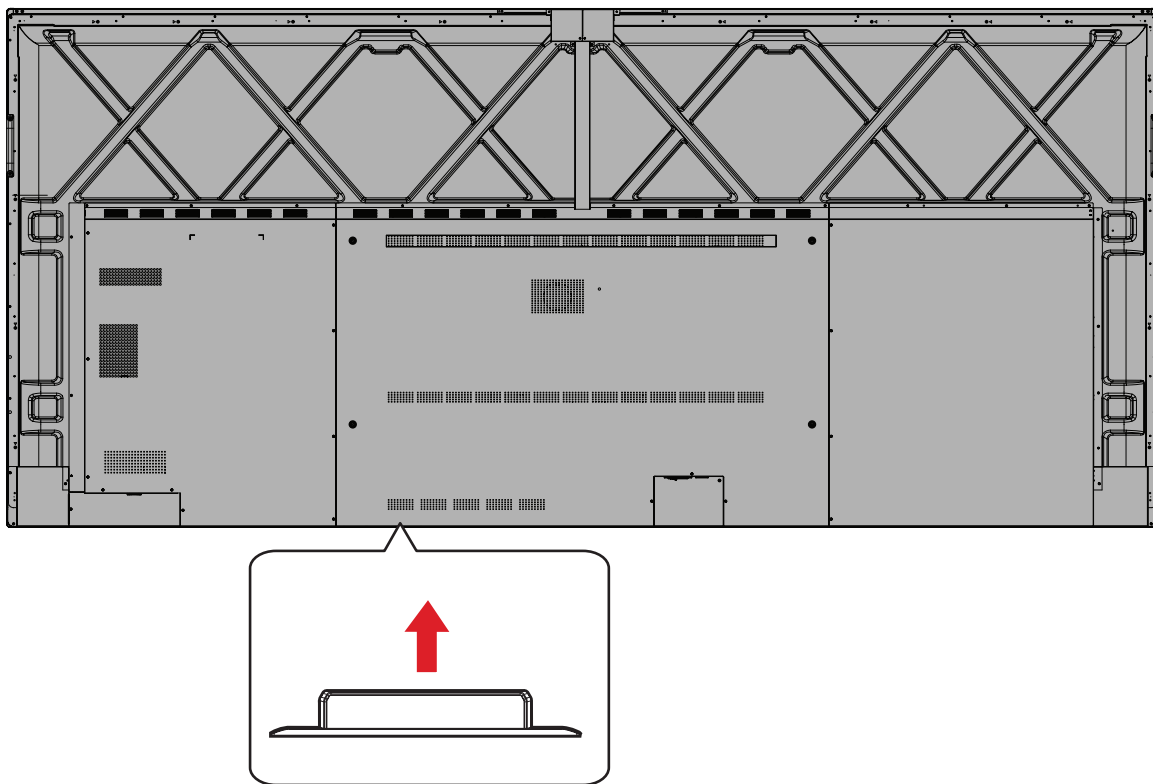

3. Secure the slot-in Wi-Fi card to the display.

## UMB202 Camera Plate Installation

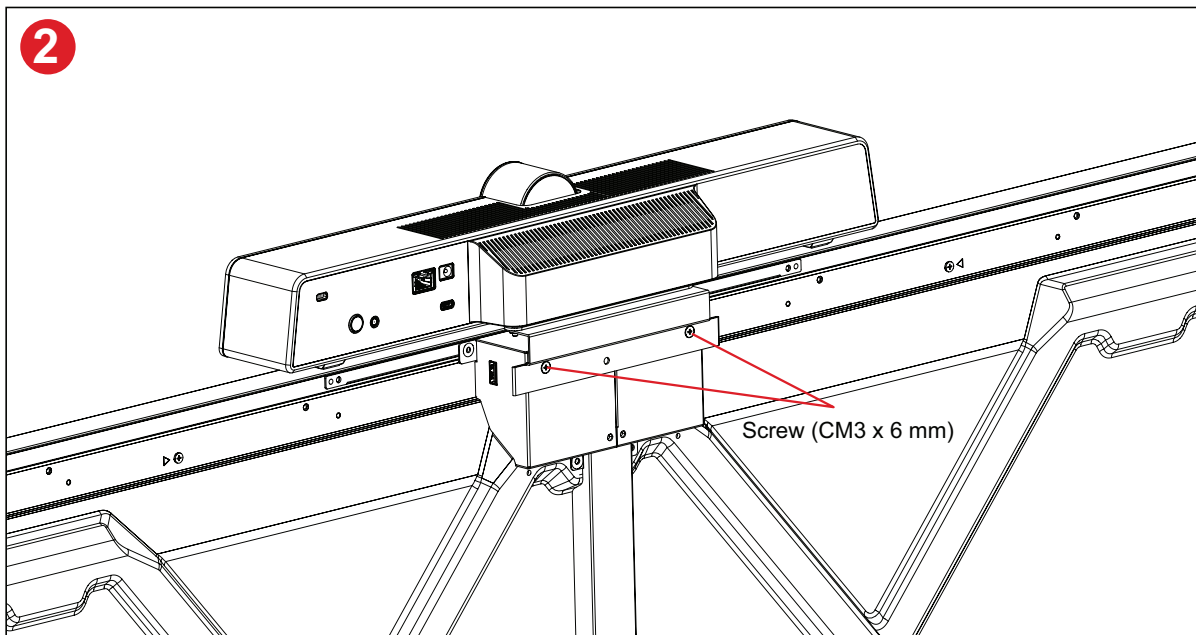
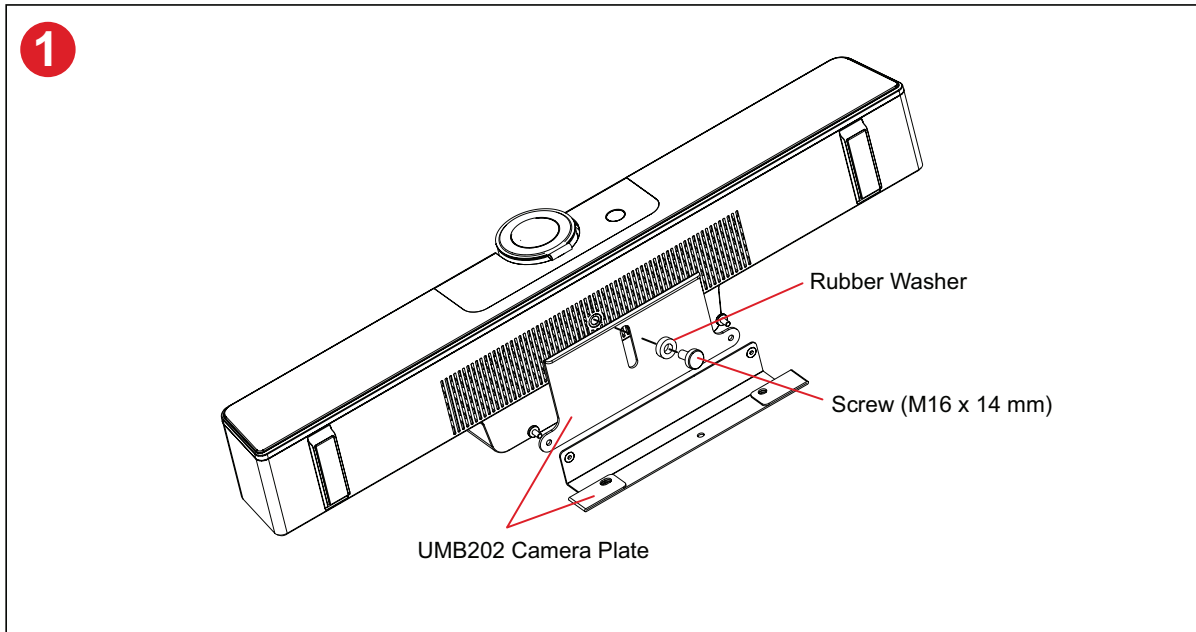

# Using the ViewBoard

## Turning On/Off the ViewBoard

1. Ensure the power cord is connected, plugged into a power outlet, and the power switch is in the “On” position.

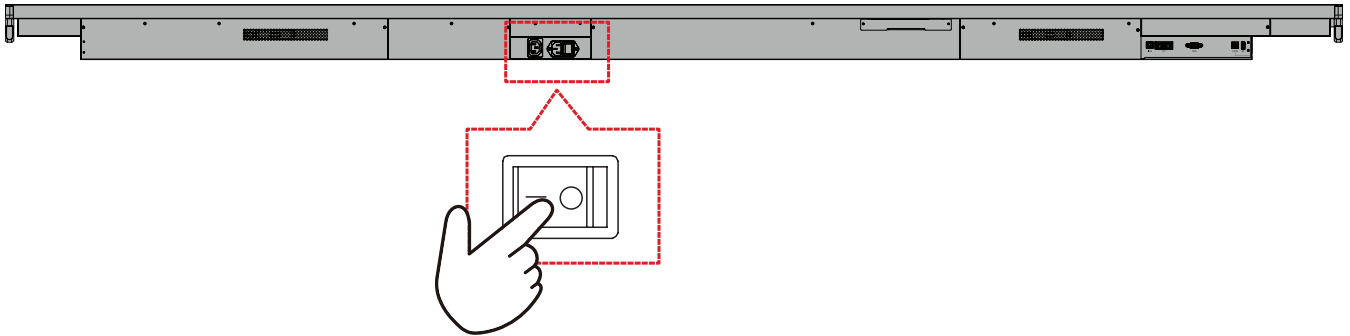

**NOTE:** The Power Switch is located at the bottom of the ViewBoard.

2. Press the **⏻ Power** button to turn on the ViewBoard.

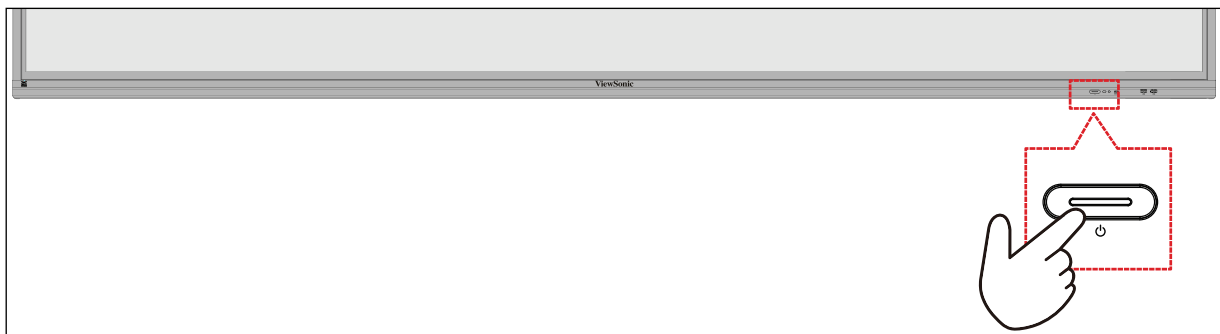

3. To turn the ViewBoard off, press and hold the **⏻ Power** button.

**NOTE:** **AC OUT** can be connected to another device. However, the output power use must be  $< 250W$ .

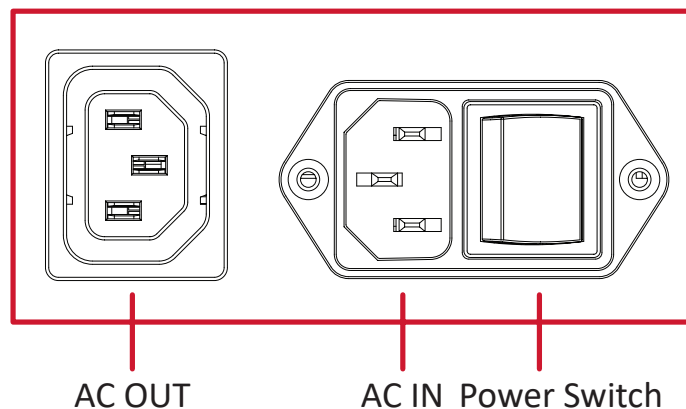

# Initial Launch Setup

When you first turn on your ViewBoard, an initial setup wizard will launch.

## 1. Choose your preferred Language.



## 2. Setup and connect to a network.

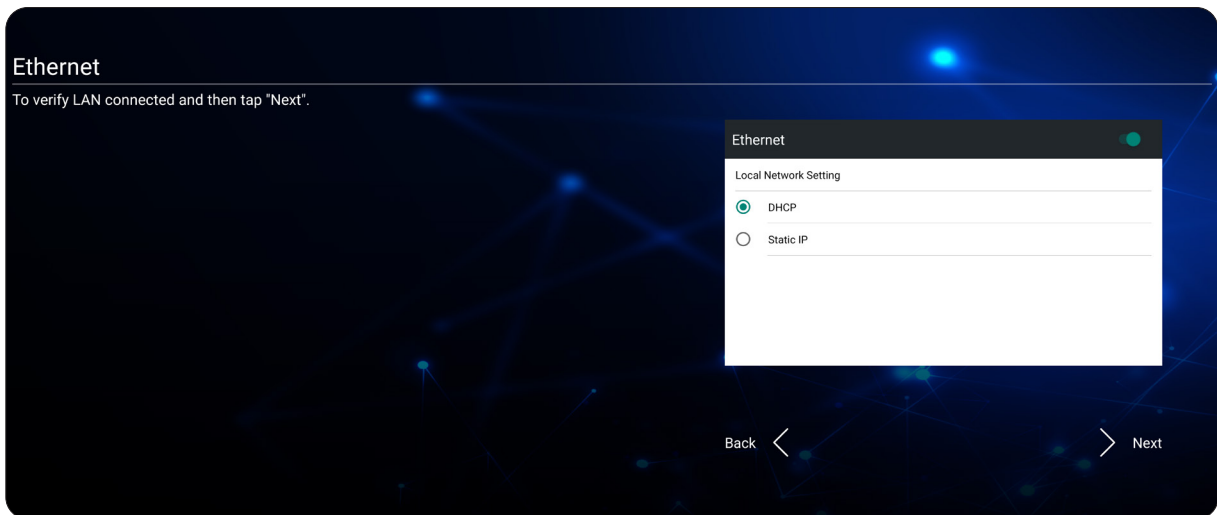

## 3. Set and adjust the Date and Time as needed.

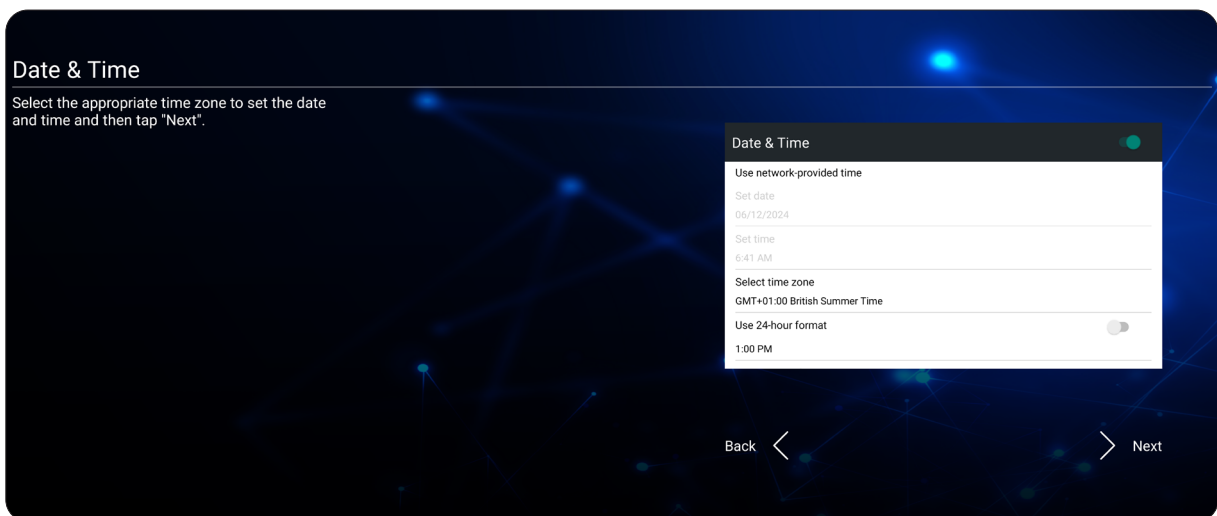

#### 4. Select your preferred System Mode.

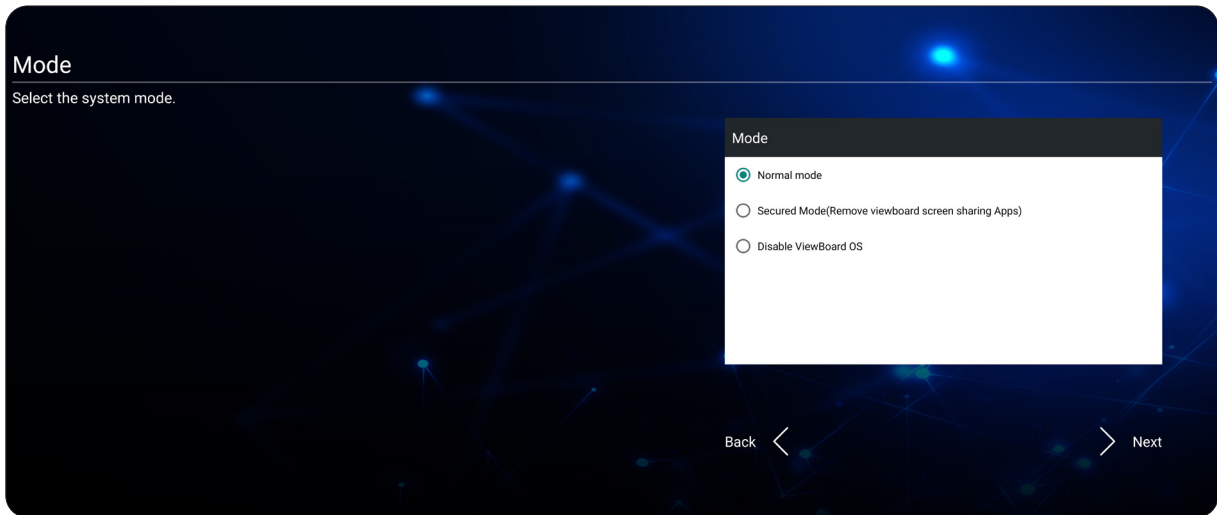

#### 5. Setup the Power Saving Plan.

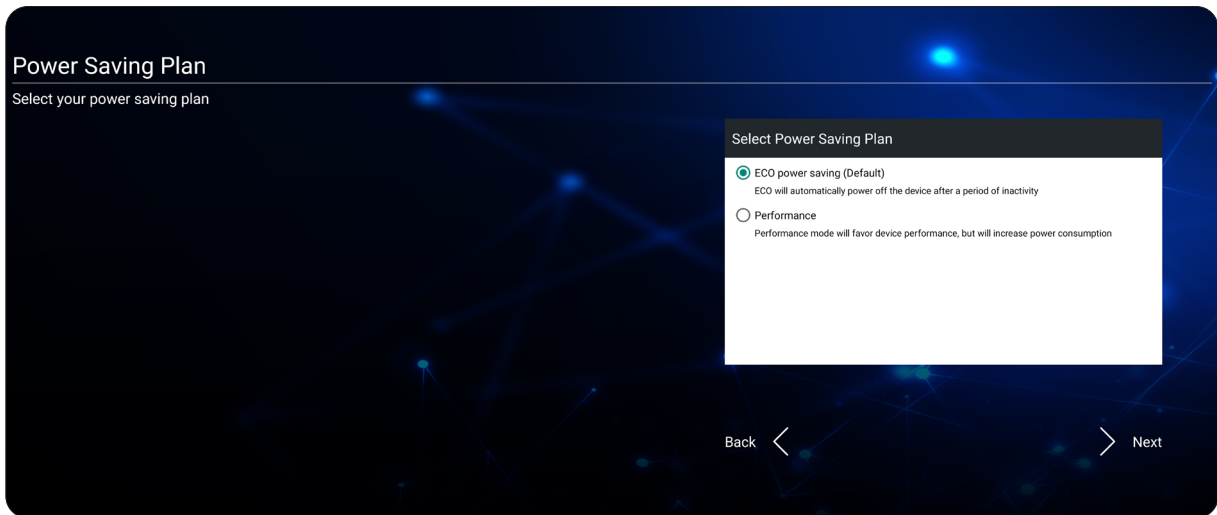

#### 6. Accept or decline the Privacy and Copyright Protection Terms.

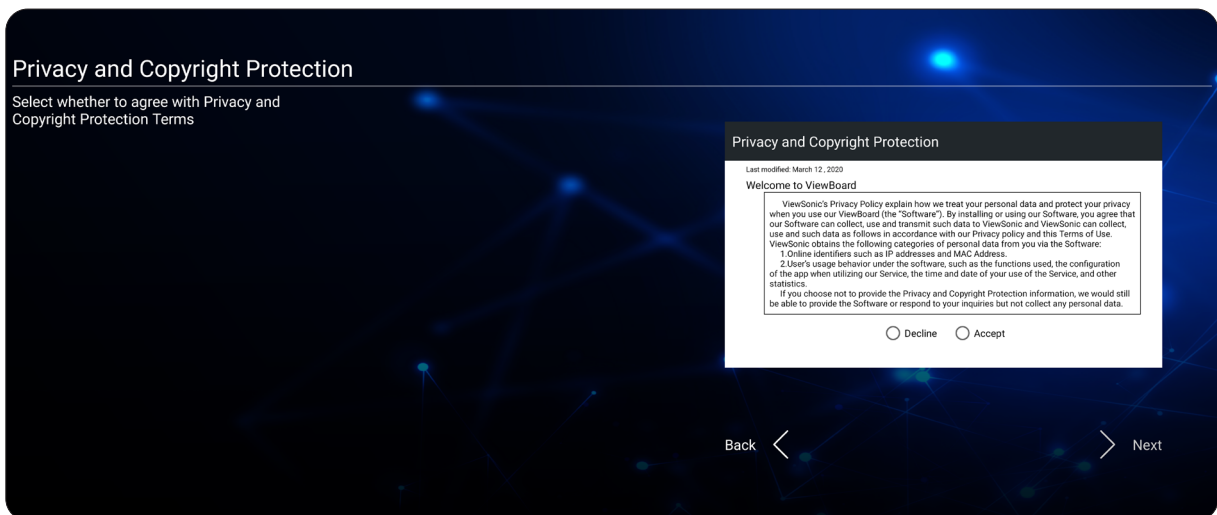

# Home Screen

On the Home Screen select from **Use as Guest** and **Sign In**.

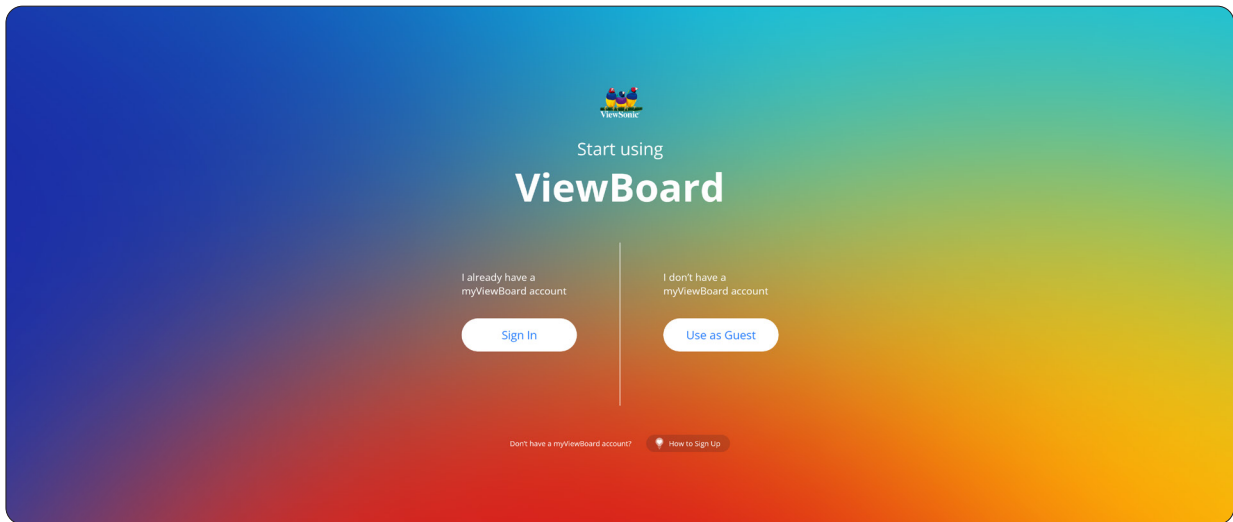

## How to Sign Up

Select the **How to Sign Up** button at the bottom of the screen, then scan the QR code and follow the directions to log in.

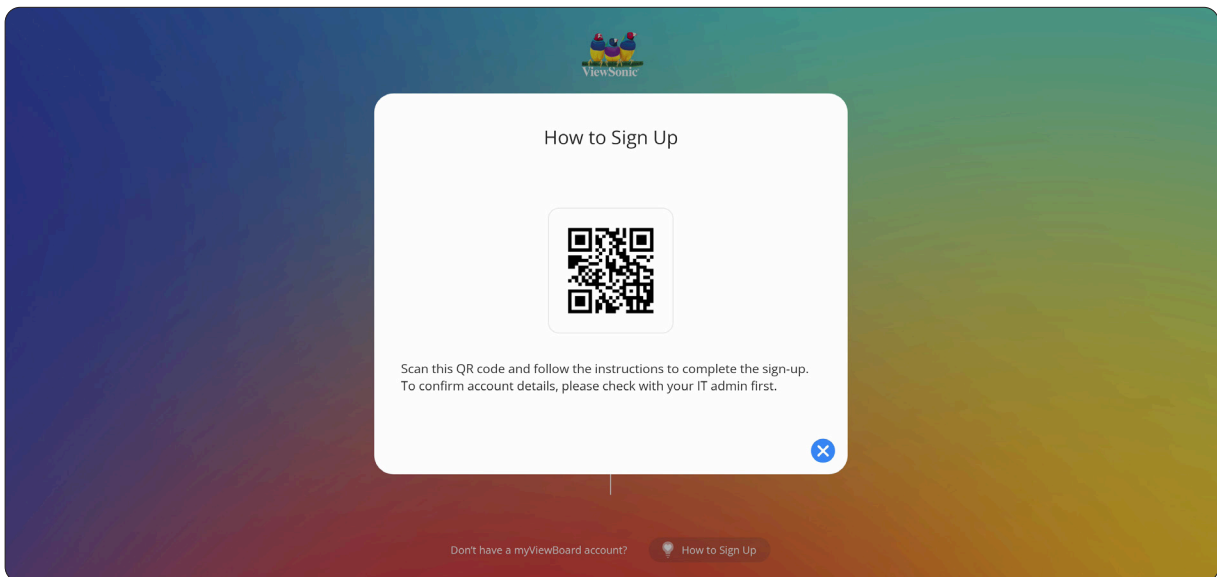

## Use as Guest

Select the **Use as Guest** button to log in with a guest account.

**NOTE:** Please note that user settings cannot be saved when logging in with a guest account.

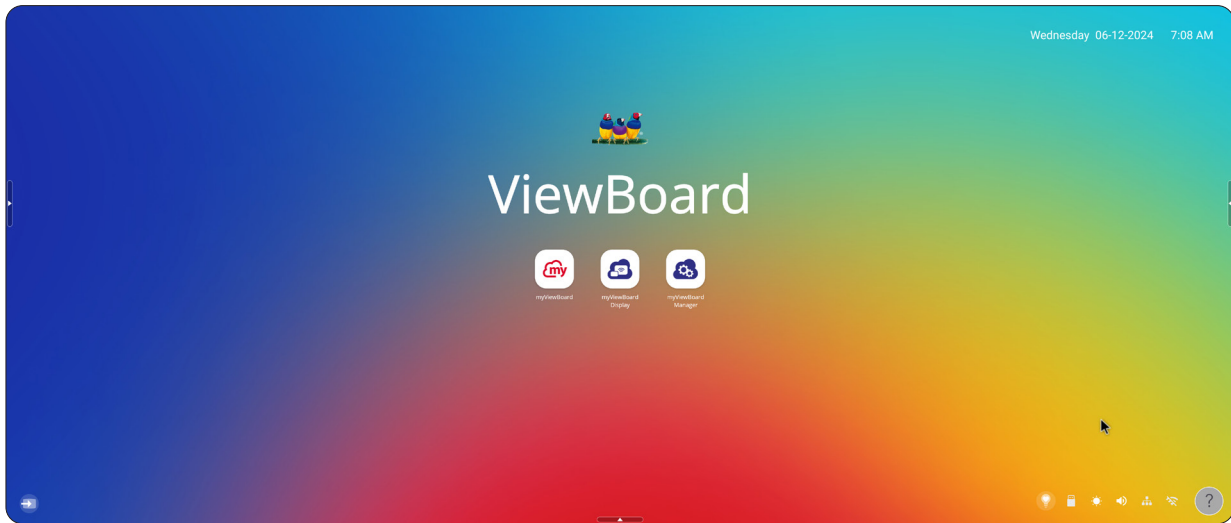

## Sign In

Select the **Sign In** button to log in with various accounts.

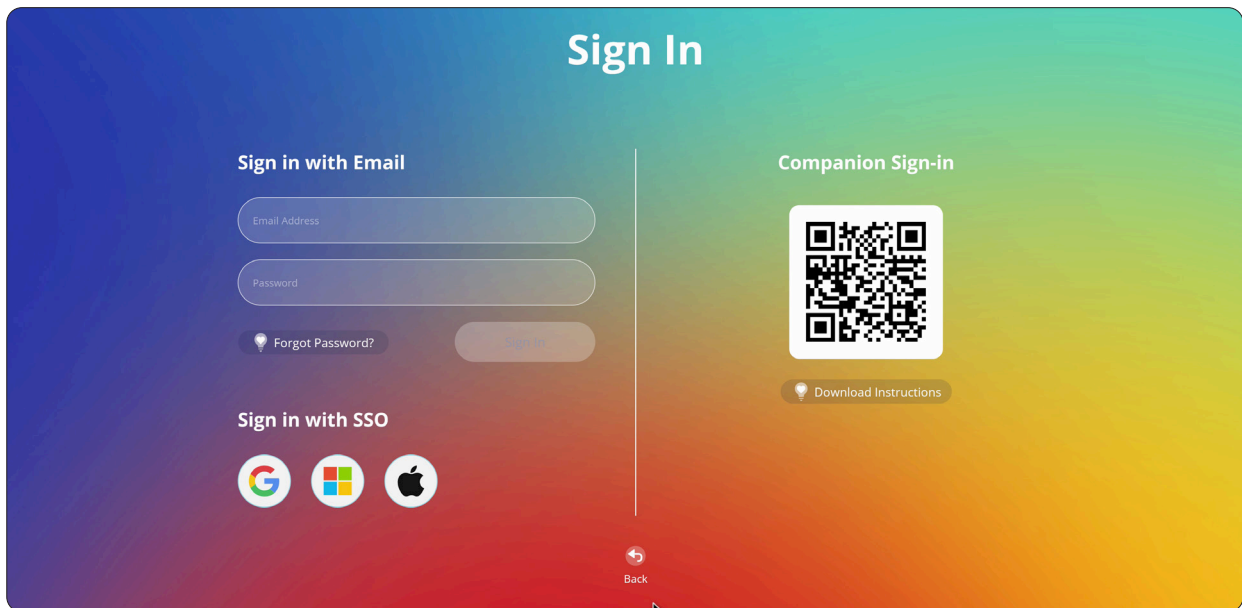

## Home Screen Message

The Home Screen message can be edited by selecting it directly on the Home Screen.

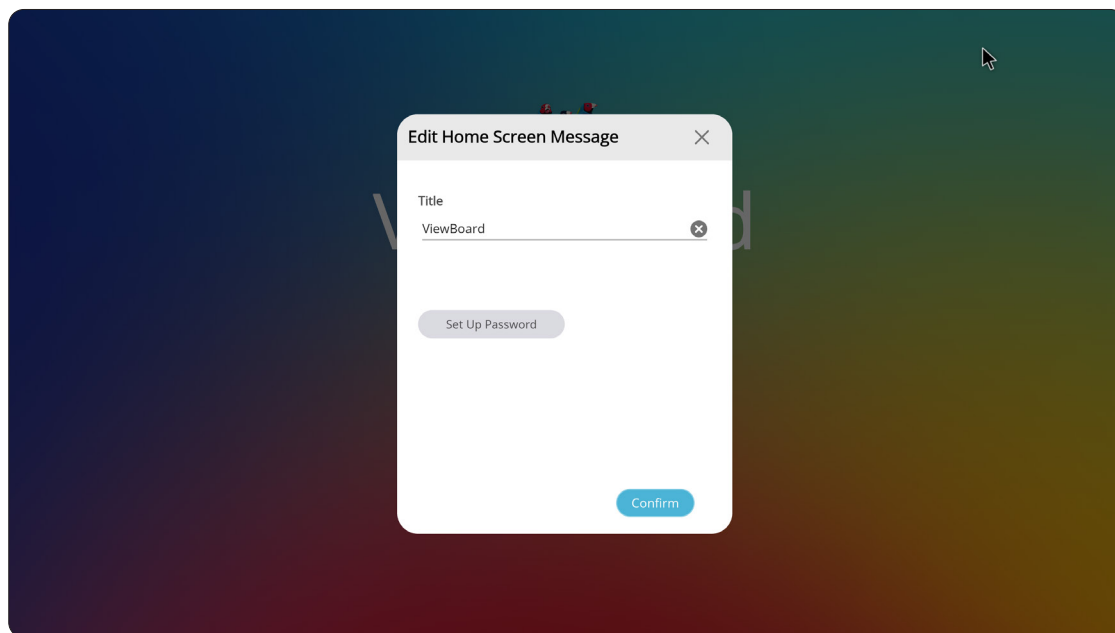

Additionally, a password can be set by selecting the **Set Up Password** button.

# Toolbar

The Toolbar is where applications and tools can be found. Trigger icons are on the right, left, and bottom edge of the screen for quick access.

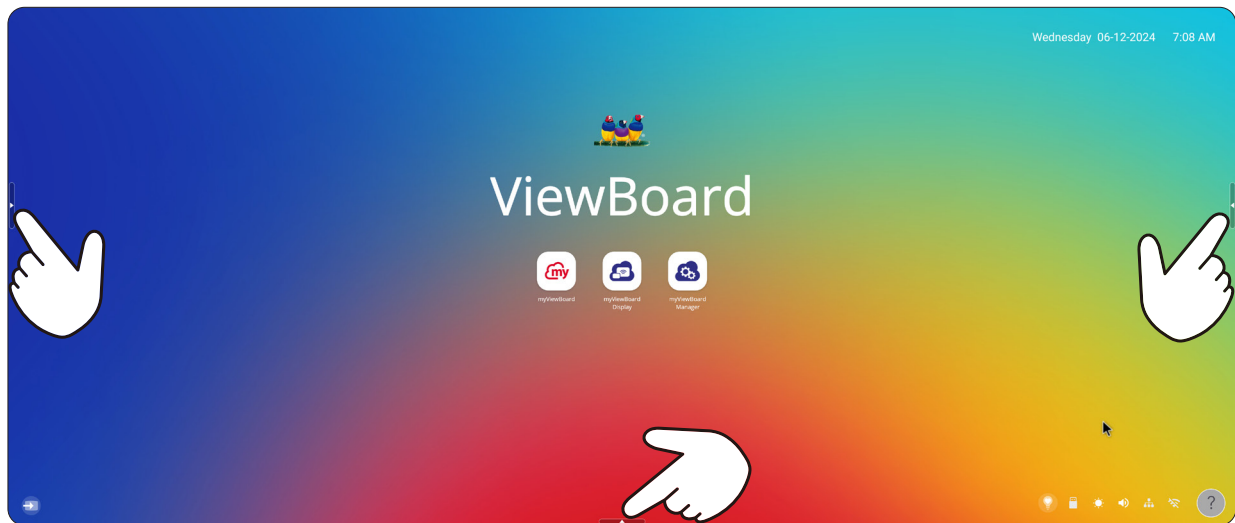







To launch an application or tool:

1. Tap a Toolbar trigger icon.
2. Tap on the application or tool.

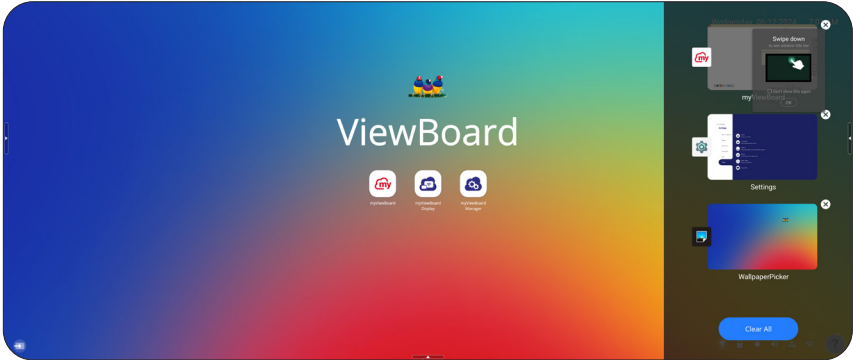

**NOTE:** The default toolbar setting is to be available for all input sources; however, users can go to: **Settings > Preference > Toolbar settings** to adjust the options: (1) Show side toolbar, (2) Hide side toolbar, (3) Disable in all input sources.

## Toolbar Icons

| Icon   | Description  |
|--|--|
| <br><b>Return</b>         | Return to the previous operation screen.<br><b>NOTE:</b> Only for the ViewBoard source.  |
| <br><b>Home</b>           | Return to the Home Screen.   |
| <br><b>Recent</b>         | Display all currently open applications.<br> |
| <br><b>Applications</b> | View all installed applications.   |
| <br><b>File Folder</b>  | Browse and open files.   |
| <br><b>Tools</b>        | Quickly view and adjust various frequently used tools.   |
| <br><b>Input Source</b> | Select and change the input source signal.   |



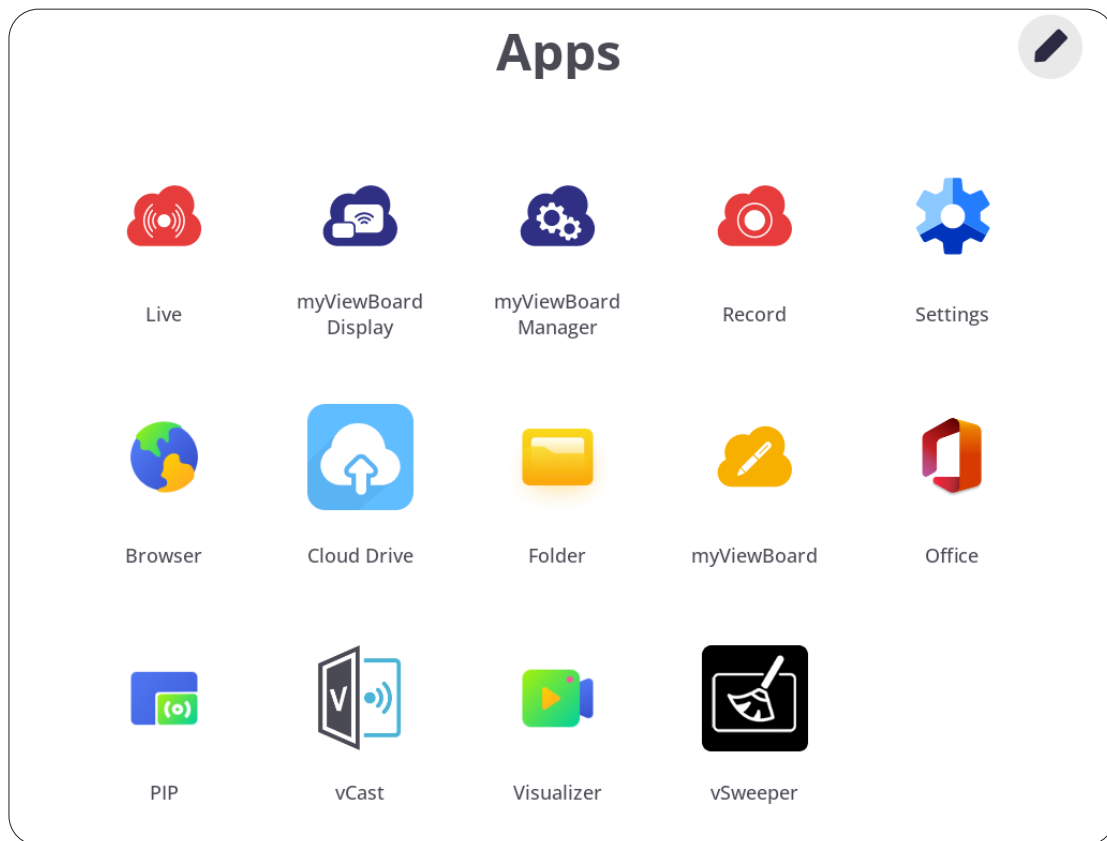

# Applications

Much like any smart phone or tablet you can install several different applications.





Applications can be accessed from the Toolbar, directly from the Home Screen via shortcuts, or by selecting the **Applications** icon (  ).





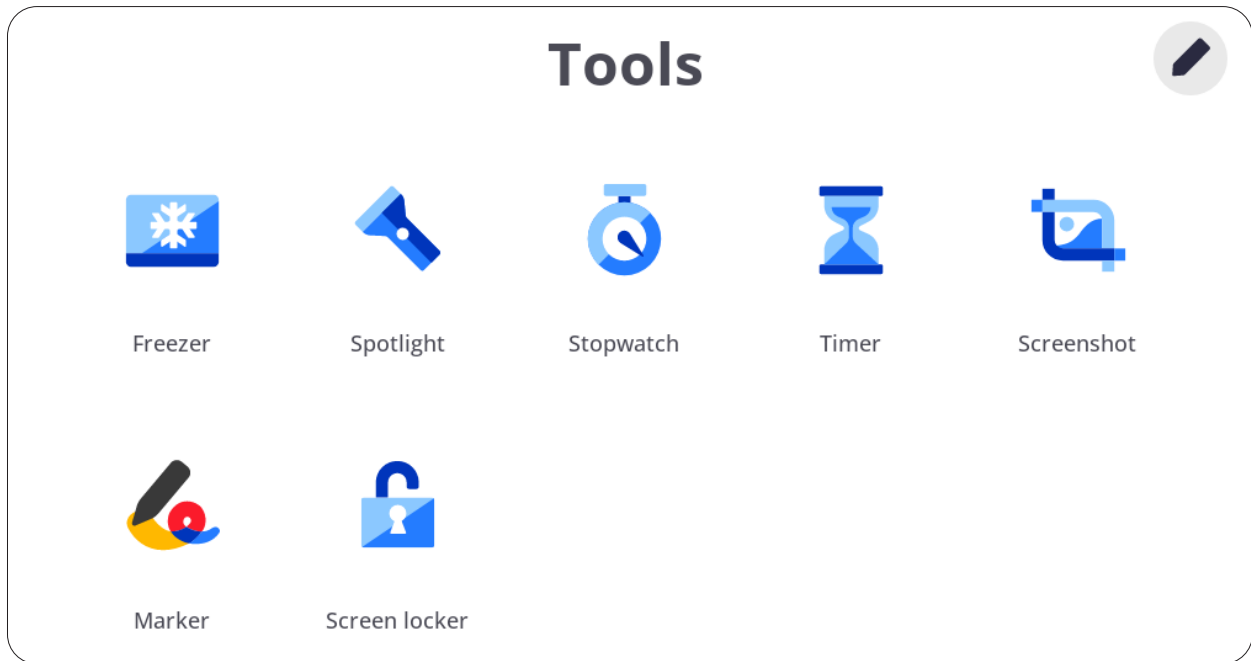

**NOTE:** The following included application descriptions are not a comprehensive list and will vary by the user.

| Icon  | Description  |
|---|--|
|  | <u>myViewBoard Display</u><br>Wirelessly mirror screens to a larger display.   |
|  | <u>myViewBoard Manager</u><br>Remotely manage multiple installations of ViewSonic devices.   |
|  | <u>myViewBoard Whiteboard</u><br>A digital whiteboarding application.  |
|  | <u>Settings</u><br>Access the System Settings.   |
|  | <u>vCast</u><br>Working with ViewBoard Cast software, receive vCastSender laptop screens (Windows/Mac/Chrome) and mobile (iOS/Android) users' screens, photos, videos, annotations, and camera(s). |

# Tools



Various tools can be accessed from the Toolbar, directly from the Home Screen via shortcuts, or by selecting the **Tools** icon (  ).





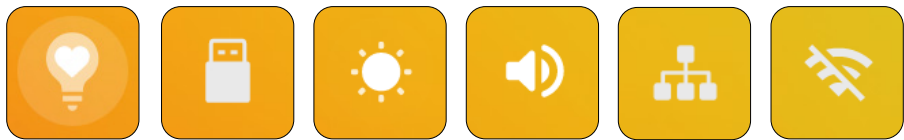
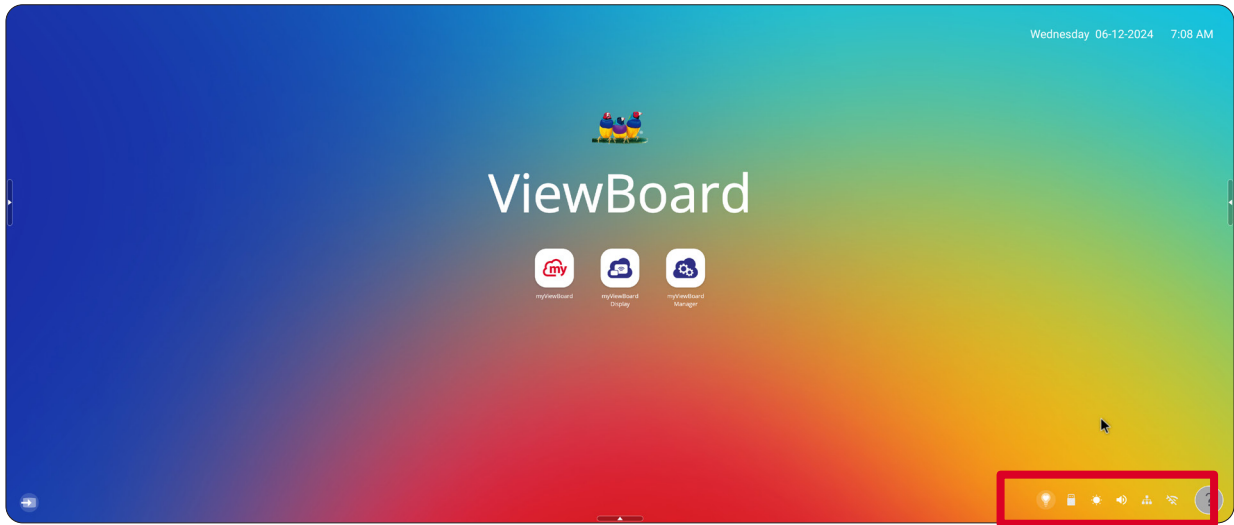

| Icon  | Description  |
|---|--|
|  | <u>Freezer</u><br>Convert the currently displayed content into a still image; then you can zoom in, zoom out, go back to full screen, and exit.  |
|  | <u>Spotlight</u><br>Highlight the focus content zone. Tap the setting icon to adjust the spotlight size and alpha blending effect.   |
|  | <u>Stopwatch</u><br>Tapping Start will initiate the stopwatch. At any time, the stopwatch can be paused, resumed, split, or reset.   |
|  | <u>Timer</u><br>A countdown timer with an optional alarm setting. Touch and swipe to adjust the numeric values, then click Start. At any time, the countdown timer can be paused, resumed, or reset. |
|  | <u>Screenshot</u><br>Take a screenshot of the current screen.  |
|  | <u>Marker</u><br>Annotate the overlay of any input source with a pen or brush.   |
|  | <u>Screen Locker</u><br>Lock the display's screen for added security.  |

# Control Bar

Frequently used settings and tools can be accessed quickly through the Control Bar.



## Control Bar Icons

| Icon   | Description   |
|--|---|
| <br><b>Online Guide</b> | Learn the basics of ViewBoard online by scanning the QR code that appears after tapping the icon.                               |
| <br><b>USB</b>          | If a USB storage device is connected, the USB icon will be visible. Tapping the icon will open the USB storage device's folder. |
| <br><b>Brightness</b>   | Adjust the brightness level of the display.   |
| <br><b>Sound</b>        | Adjust the volume level of the display.   |
| <br><b>Ethernet</b>     | Shortcut to Network & Internet Ethernet settings. Enable or disable Ethernet connection.  |
| <br><b>Wireless</b>     | Shortcut to Network & Internet Wi-Fi settings. Enable or disable Wi-Fi and connect to a wireless network.                       |

# On-Screen Display (OSD) Menu - General Settings

Access **Input Source**, **Display**, and other general settings through the OSD Menu.

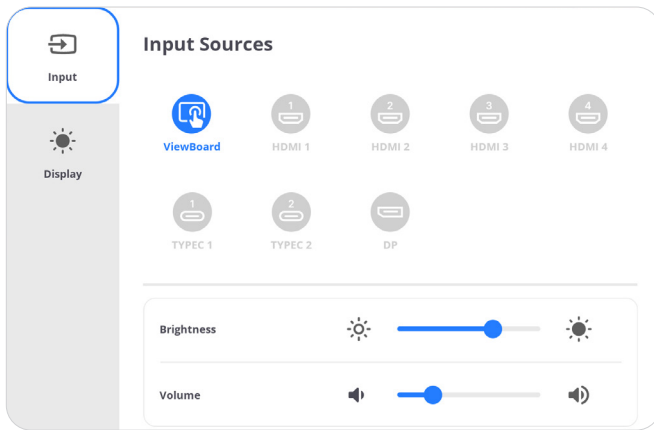

*Input Source Menu*

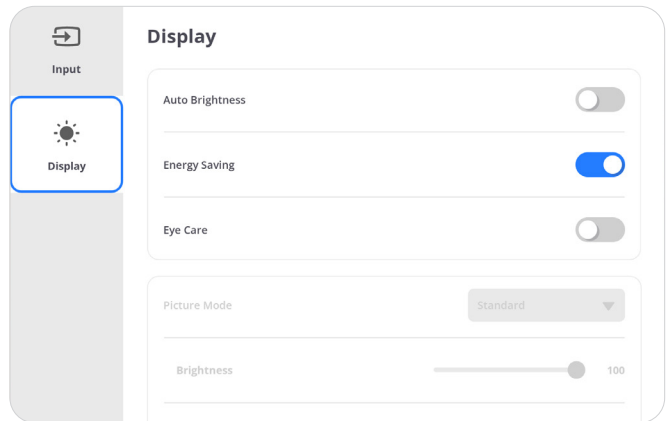

*Display Menu*

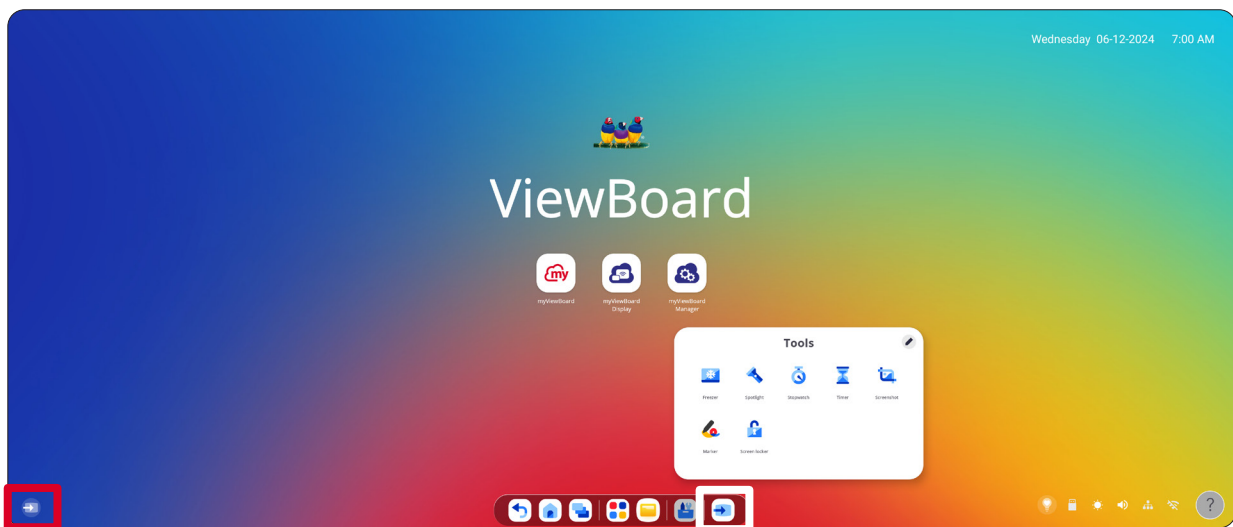

Open the OSD Menu by pressing **INPUT** on the remote control, touching the **Input Source** icon (➡️) on the Home Screen or the **Input Source** icon (➡️) in the Toolbar.

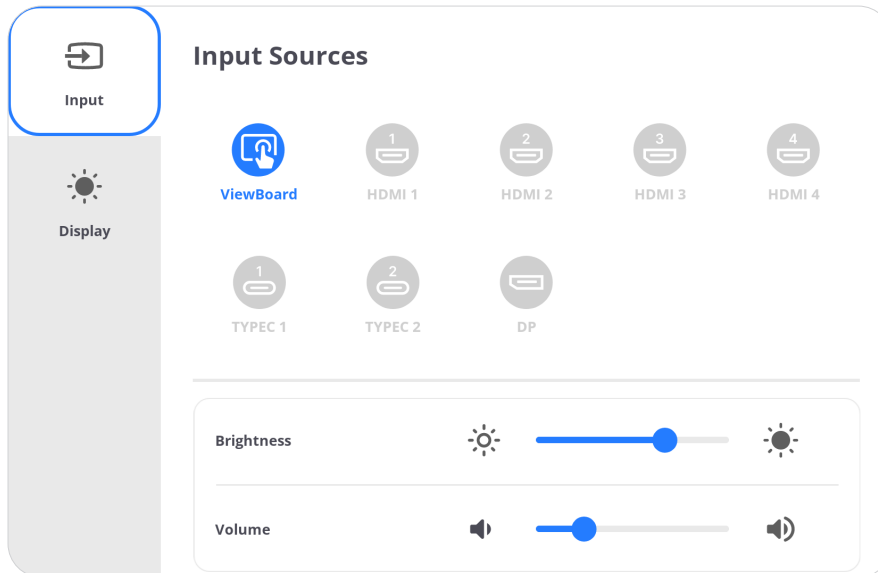

## Input Source





To select an input source:

1. Press **INPUT** on the remote control, touch the **Input Source** icon (  ) on the Home Screen or the **Input Source** icon (  ) in the Toolbar to display the Input Source menu.
2. Press **▼/▲/◀/▶** on the remote control to select the input source you want.  
**NOTE:** The PC source will only be visible when a slot-in computer is installed.
3. Press **ENTER** on the remote control, or touch the input source.
4. Press **BACK** on the remote control, or touch a blank area outside of the menu to exit.

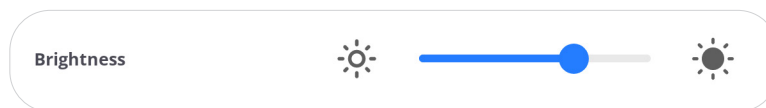

To adjust the brightness:

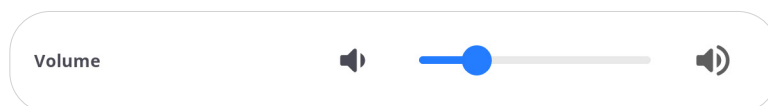

1. Press **INPUT** on the remote control, touch the **Input Source** icon (  ) on the Home Screen or the **Input Source** icon (  ) in the Toolbar to display the Input Source menu.
2. Touch and drag the brightness slider directly to adjust the backlight value.
3. Press **BACK** on the remote control, or touch a blank area outside of the menu to exit.

To adjust the volume:



1. Press **INPUT** on the remote control, touch the **Input Source** icon (  ) on the Home Screen or the **Input Source** icon (  ) in the Toolbar to display the Input Source menu.
2. Touch and drag the volume slider directly to adjust the value, or press **VOL +/VOL -** on the remote control to adjust. Additionally, pressing **Mute** (  ) on the remote control will mute/unmute the volume.
3. Press **BACK** on the remote control, or touch a blank area outside of the menu to exit.

## Display

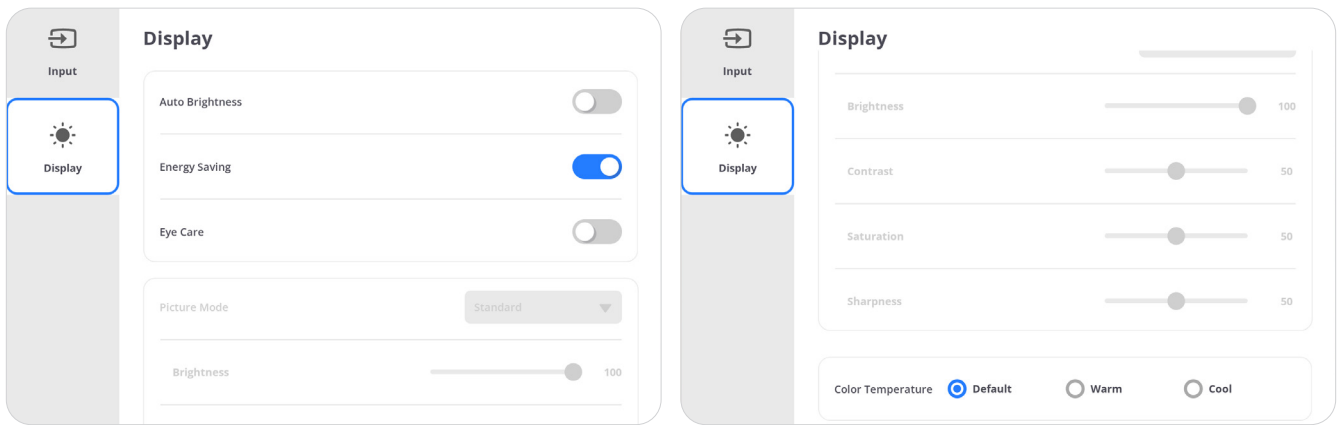

To adjust the display settings:

1. Press **INPUT** on the remote control, touch the **Input Source** icon (→) on the Home Screen or the **Input Source** icon (→) in the Toolbar to display the Input Source menu. Then select the **Display** tab.
2. Press ▼/▲/◀/▶ on the remote control to select the menu option you want.
3. Press **ENTER** on the remote control to confirm or press ◀/▶ to adjust the menu option. Additionally, touch/adjust the menu option directly.
4. Press **BACK** on the remote control, or touch a blank area outside of the menu to exit.

## Display Menu Options

| Item                     | Description  |   |             |                 |                       |               |   |             |  |               |                                 |
|--------------------------|--|---|-------------|-----------------|-----------------------|---------------|---|-------------|--|---------------|---------------------------------|
| <b>Auto Brightness</b>   | Automatic brightness adjustment. Adjusts maximum brightness according to ambient light levels.   |   |             |                 |                       |               |   |             |  |               |                                 |
| <b>Energy Saving</b>     | Enable to reduce power consumption.  |   |             |                 |                       |               |   |             |  |               |                                 |
| <b>Eye Care</b>          | Adjusts the filter that blocks high-energy blue light for a more comfortable viewing experience.   |   |             |                 |                       |               |   |             |  |               |                                 |
| <b>Picture Mode</b>      | Select a predefined picture setting.   |   |             |                 |                       |               |   |             |  |               |                                 |
|                          | <table border="1"> <thead> <tr> <th>Mode</th> <th>Description</th> </tr> </thead> <tbody> <tr> <td><b>Standard</b></td> <td>Default picture mode.</td> </tr> <tr> <td><b>Bright</b></td> <td>Maximizes the brightness of the display. This mode is suitable for environments where extra-high brightness is required (e.g., well-lit rooms).</td> </tr> <tr> <td><b>Soft</b></td> <td>A high brightness level with lower contrast level.</td> </tr> <tr> <td><b>Custom</b></td> <td>Customize the picture settings.</td> </tr> </tbody> </table> | Mode  | Description | <b>Standard</b> | Default picture mode. | <b>Bright</b> | Maximizes the brightness of the display. This mode is suitable for environments where extra-high brightness is required (e.g., well-lit rooms). | <b>Soft</b> | A high brightness level with lower contrast level. | <b>Custom</b> | Customize the picture settings. |
|                          | Mode   | Description   |             |                 |                       |               |   |             |  |               |                                 |
|                          | <b>Standard</b>  | Default picture mode.   |             |                 |                       |               |   |             |  |               |                                 |
|                          | <b>Bright</b>  | Maximizes the brightness of the display. This mode is suitable for environments where extra-high brightness is required (e.g., well-lit rooms). |             |                 |                       |               |   |             |  |               |                                 |
| <b>Soft</b>              | A high brightness level with lower contrast level.   |   |             |                 |                       |               |   |             |  |               |                                 |
| <b>Custom</b>            | Customize the picture settings.  |   |             |                 |                       |               |   |             |  |               |                                 |
|                          |  |   |             |                 |                       |               |   |             |  |               |                                 |
|                          |  |   |             |                 |                       |               |   |             |  |               |                                 |
|                          |  |   |             |                 |                       |               |   |             |  |               |                                 |
| <b>Brightness</b>        | Adjusts background black levels of the screen image. The higher the value, the brighter the image. Lower values will result in a darker image.   |   |             |                 |                       |               |   |             |  |               |                                 |
| <b>Contrast</b>          | Adjusts the difference between the image background (black level) and the foreground (white level). Use this to set the peak white level after you have previously adjusted the <b>Brightness</b> setting to suit your selected input and viewing environment.   |   |             |                 |                       |               |   |             |  |               |                                 |
| <b>Saturation</b>        | The amount of color in a picture. Lower settings produce less saturated colors; in fact, a setting of “0” removes that color from the image entirely. If the saturation is too high though, that color will be overpowering and unrealistic.   |   |             |                 |                       |               |   |             |  |               |                                 |
| <b>Sharpness</b>         | A high value results in a sharper picture; a low value softens the picture.  |   |             |                 |                       |               |   |             |  |               |                                 |
| <b>Color Temperature</b> | Adjust the color temperature value.  |   |             |                 |                       |               |   |             |  |               |                                 |

## Low Blue Light Filter and Eye Health

The Blue Light Filter blocks high-energy blue light for a more comfortable viewing experience.

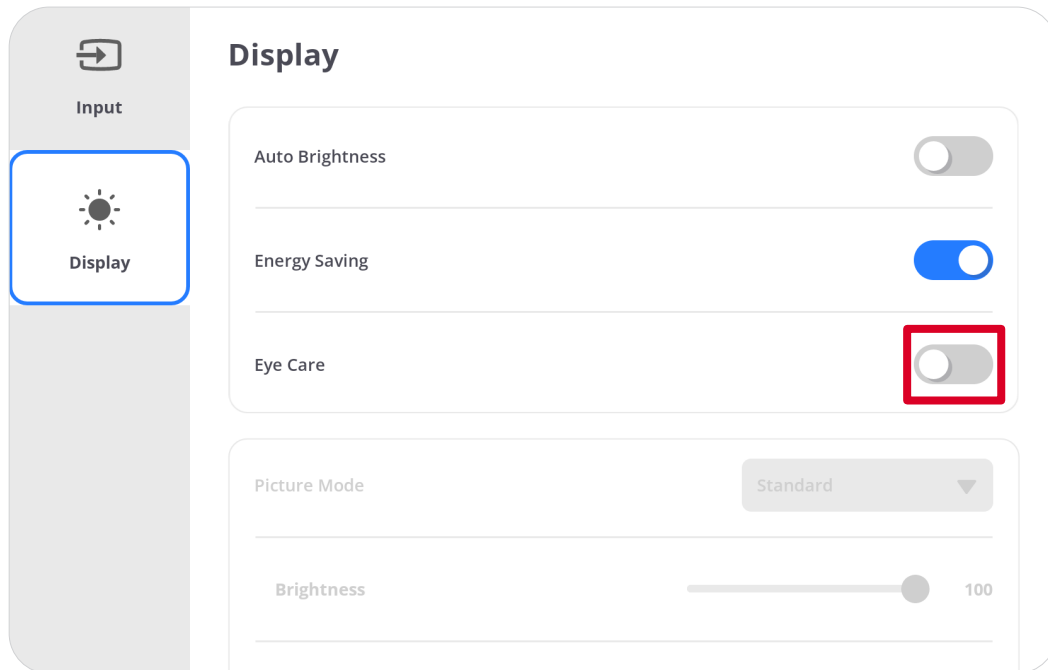

### Calculating Breaks

When viewing screens for extended periods, it is recommended to take periodic breaks from viewing. Short breaks of at least 10 minutes are recommended after one (1) hour of continuous viewing.

Taking shorter, more frequent breaks are generally more beneficial than longer, less frequent breaks.

### Focus Fatigue (20-20-20 Rule)

To reduce the risk of eye fatigue by constantly looking at the screen, look away from the screen at least every 20 minutes and gaze at a distant object (at least 20 feet away) for at least 20 seconds.

### Looking at Distant Objects

While taking breaks, users can further reduce eye strain and dryness by focusing on objects that are further away from them for 10-15 seconds, then gaze at something up close for 10-15 seconds. Repeat this up to 10 times. This exercise reduces the risk of your eyes' focusing ability to "lock up" after prolonged computer work.

## Eye and Neck Exercises

### Eye Exercises

Eye exercises can help minimize eye strain. Slowly roll your eyes to the left, right, up, and down. Repeat as many times as needed.

#### Exercises for the eyes

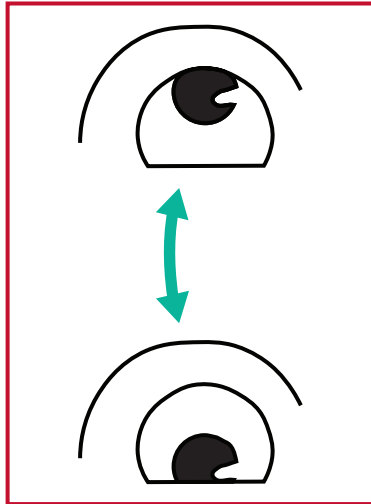

(1) Keep the body and the head upright. Move the eyes up to look at the ceiling, then turn down to look at the floor.

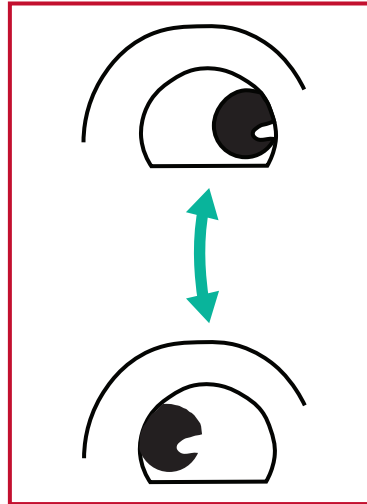

(2) Move the eyes left and right slowly to look at objects on the two sides.

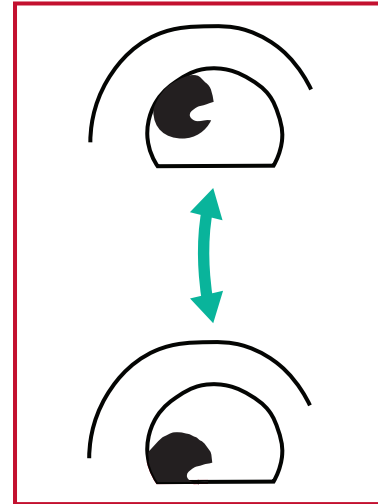

(3) Move the eyes to look at objects at the right upper direction and then right lower direction. Repeat for the left upper and left lower directions.

### Neck Exercises

Neck exercises can also help minimize eye strain. Relax your arms and let them hang at your sides, bend forward slightly to stretch the neck, turn your head to the right and to the left. Repeat as many times as needed.

# System Settings

When the display is in the ViewBoard input source, press **MENU** (☰) on the remote control or tap the setting icon (⚙️) to enter the **Settings** menu.

## Network & Internet

Check current network connection status and set up and manage Wi-Fi, Ethernet, Wireless Hotspot, Bluetooth, and VPN.



### NOTE:

- Ethernet will disable automatically when Wi-Fi is enabled. Wi-Fi will disable automatically when Ethernet is enabled. Wi-Fi will disable when Wireless hotspot is enabled.
- The device cannot connect to the Internet when Wireless Hotspot is enabled.

## Wi-Fi

Setup and manage wireless access points.

- Tap the toggle button to turn Wi-Fi **On** or **Off**.

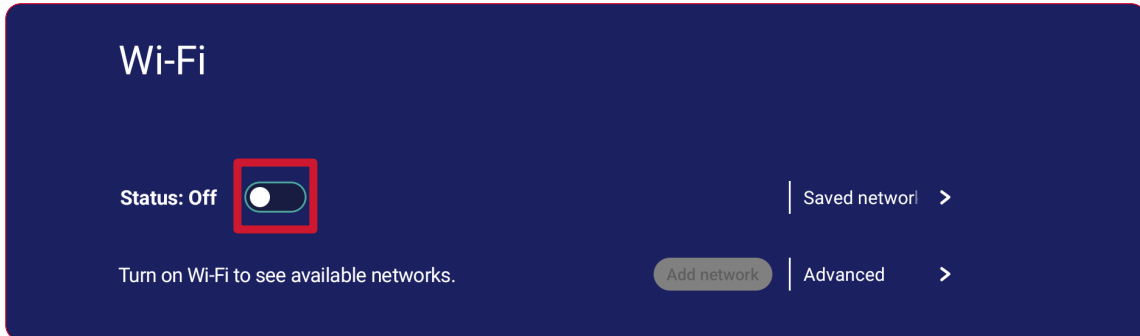

- Once **On**, you can: **Add a Network**, view **Saved Networks**, **Refresh** the network list, or view **Advanced** settings.

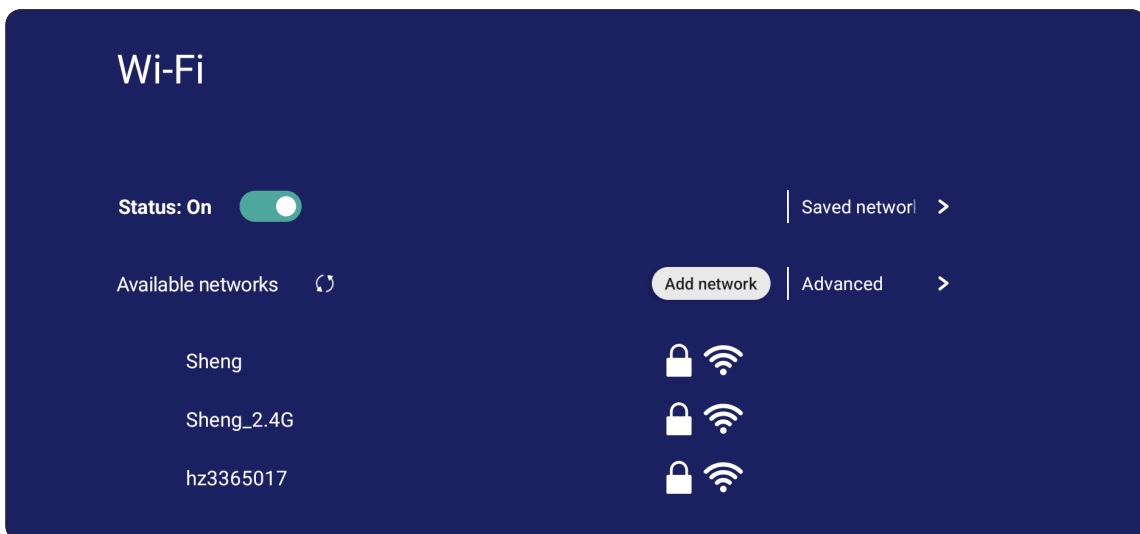

- In **Advanced** settings, you can toggle **Network notifications On** or **Off** and view **Network card info**.

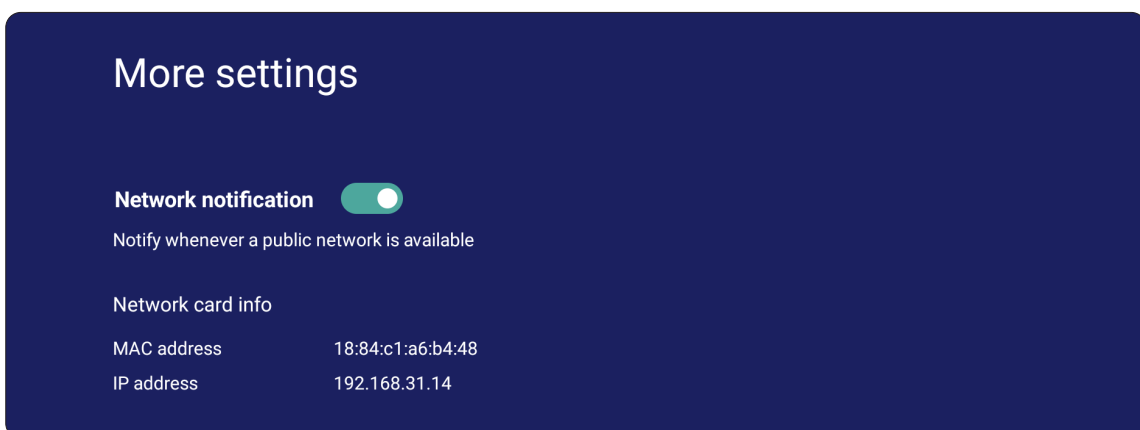

## Ethernet

Set the local network and proxy.

- Tap the drop down menu to connect/disconnect the Ethernet.

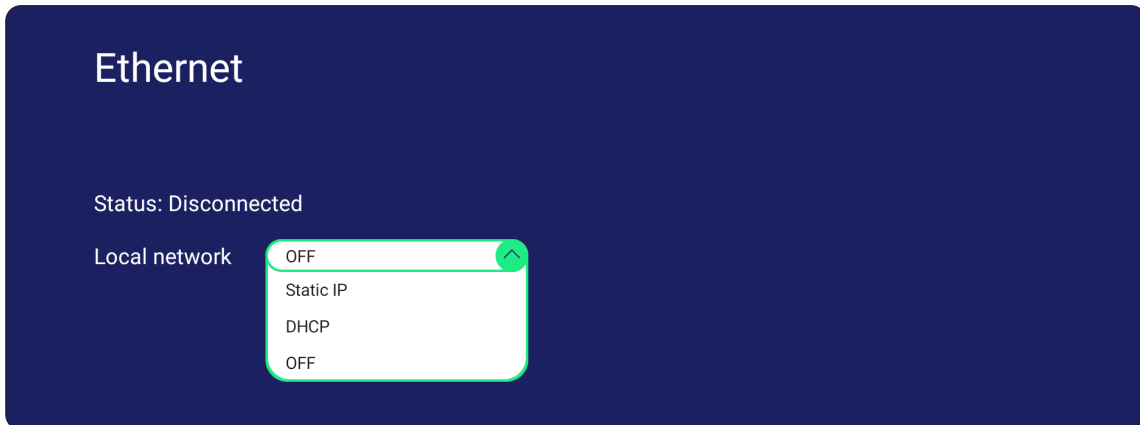

- You can adjust **Local network** and **Proxy** settings as well.

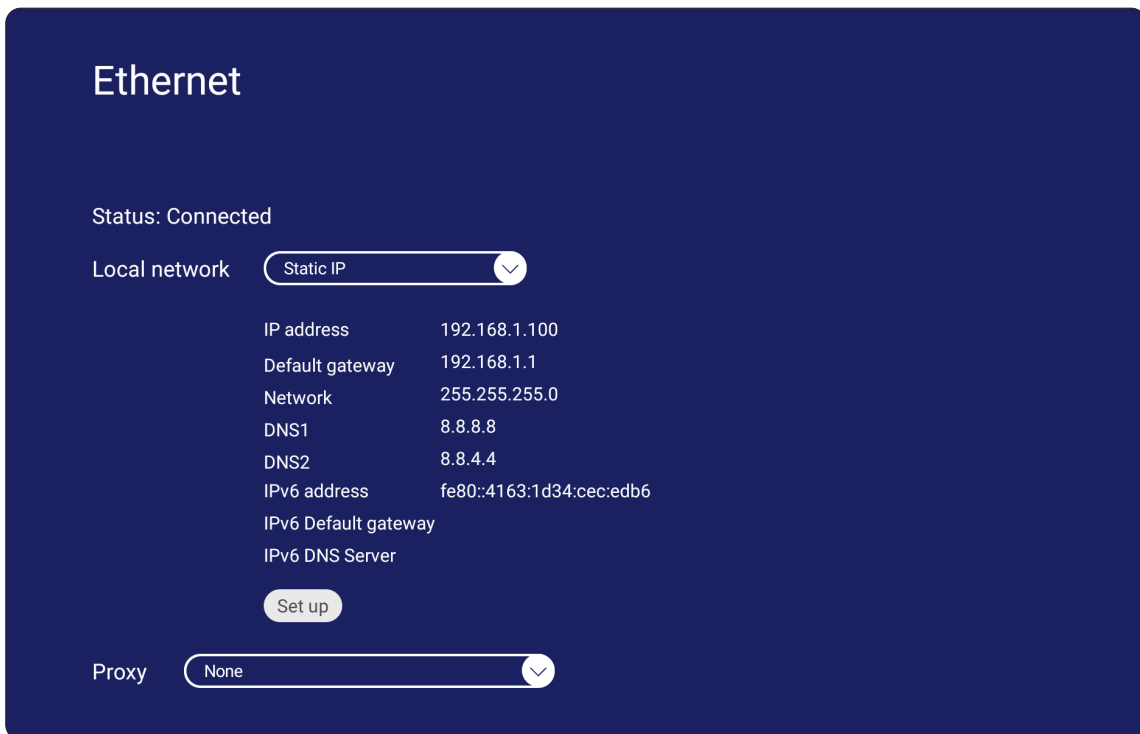

## Wireless Hotspot

Set and share your internet connection with other devices.

- Tap the toggle button to turn **Wireless hotspot On** or **Off**.

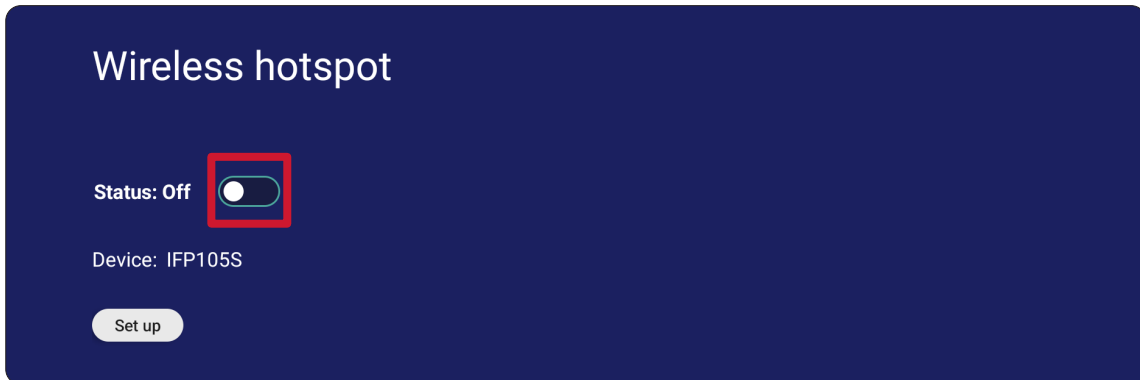

- Tap **Set up** to set the **Network name**, **Security**, and **Password**.

A screenshot of the 'Set up hotspot' dialog box. The title is 'Set up hotspot'. It contains three input fields: 'Network name' with the value 'IFP105S', 'Security' with a dropdown menu showing 'wifi\_security\_wpa2', and 'Password' with a series of dots and a visibility icon. Below the password field, there is a note: 'The password must have at least 8 characters.' At the bottom, there are 'Cancel' and 'Save' buttons.

## Bluetooth

Manage Bluetooth connections, set the device name and discoverability.

- Touch the toggle to turn **Bluetooth** on or off. Once on, users can select a listed device to pair and connect to, rename their device, remove a device, or receive files.

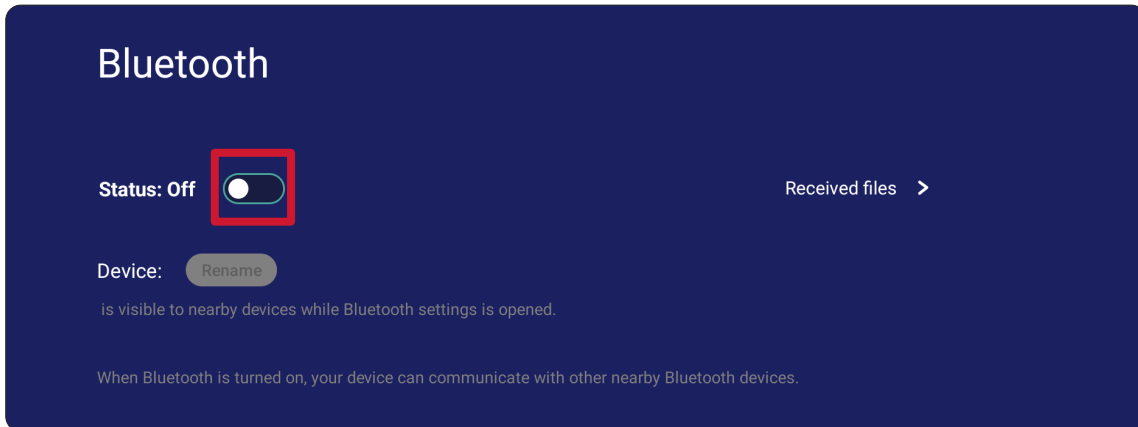

## VPN

Setup and manage Virtual Private Networks.

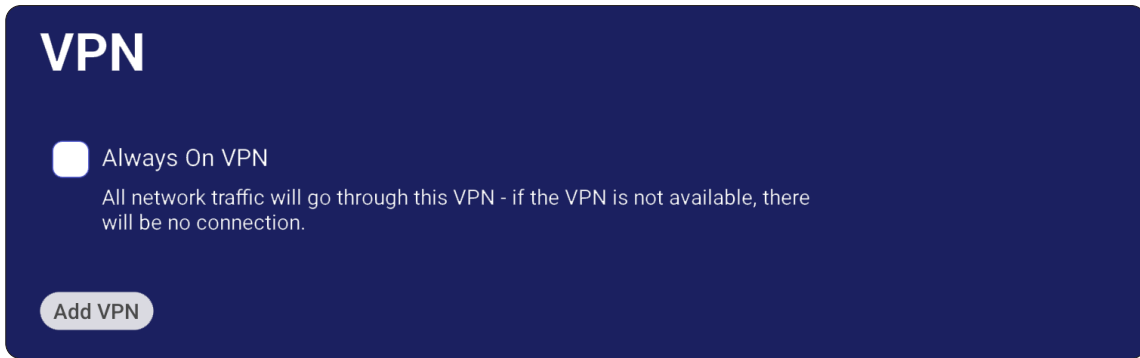

To create a VPN profile:

1. Go to: **Settings > Network & Internet > VPN** and tap **Add VPN**.

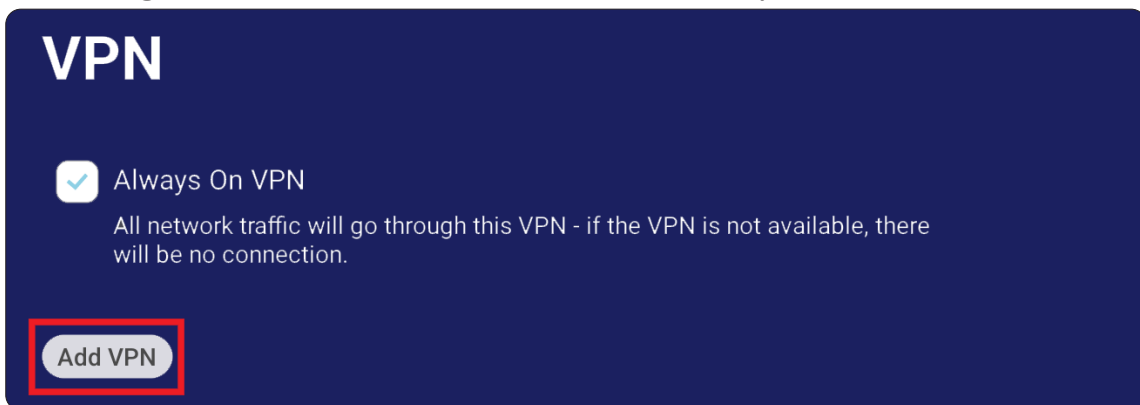

2. Key in the **Name**.

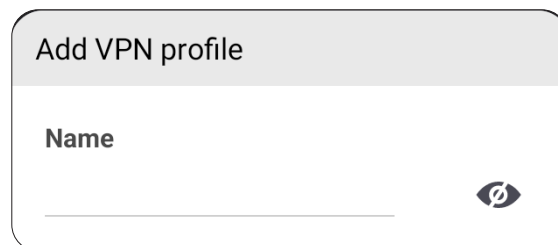
A screenshot of the 'Add VPN profile' dialog box. The title bar at the top says 'Add VPN profile'. Below the title bar, there is a label 'Name' followed by a text input field. To the right of the input field is an eye icon with a slash through it, indicating that the text is hidden.

### 3. Select the VPN Type.

The screenshot shows the 'Add VPN profile' dialog with the 'Type' dropdown menu open. The options listed are: PPTP, PPTP, L2TP/IPSec PSK, L2TP/IPSec RSA, IPSec Xauth PSK, IPSec Xauth RSA, and IPSec Hybrid RSA. A 'Save' button is visible at the bottom right.

### 4. Choose to enable/disable **PPP encryption (MPPE)** and/or show **Advanced options**.

The screenshot shows the 'Add VPN profile' dialog with the 'Type' dropdown set to 'L2TP/IPSec PSK'. The 'PPP encryption(MPPE)' checkbox is checked. The 'Advanced options' section is expanded, showing fields for 'Dns search domains', 'Dns servers', and 'Forwarding\_routes'. 'Cancel' and 'Save' buttons are at the bottom.

# Display

Adjust the Wallpaper, Protection, and HDMI Out settings.

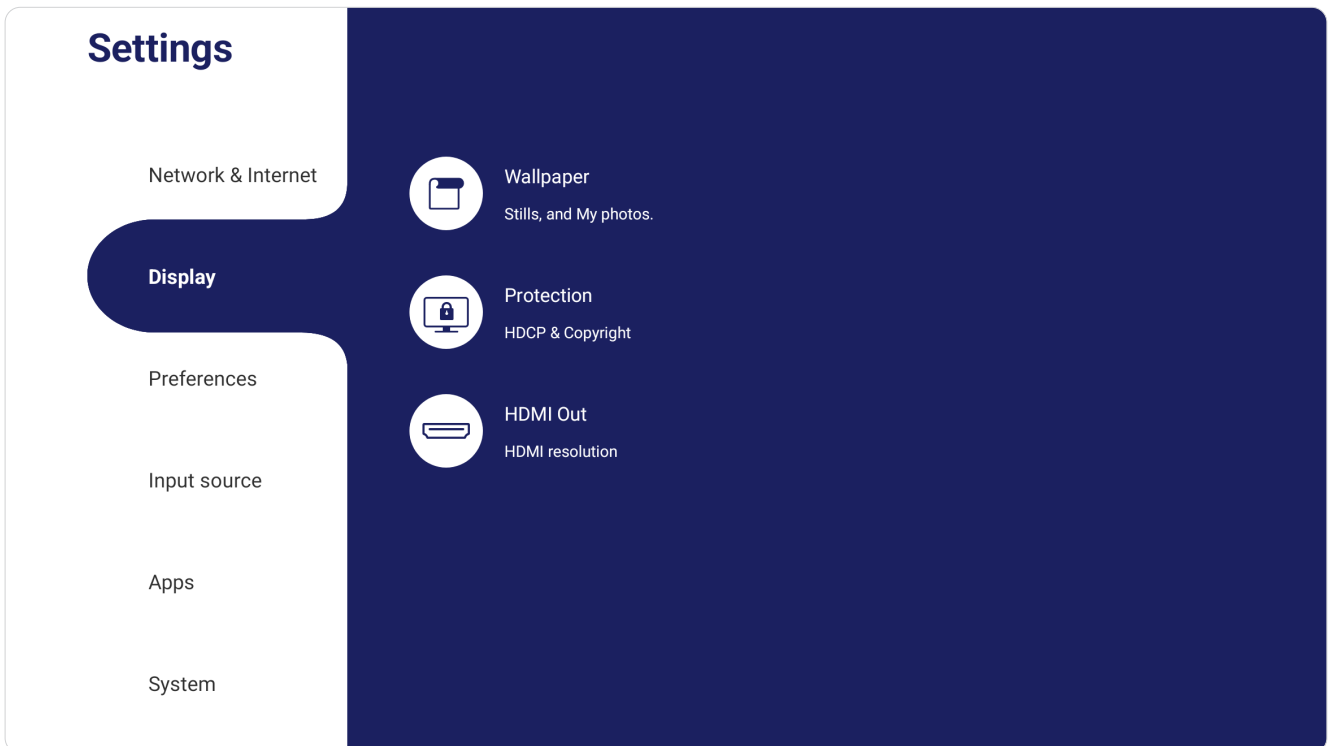

## Wallpaper

Users can change their wallpaper with default images, or use their own by tapping the add icon (+) and selecting the image file.

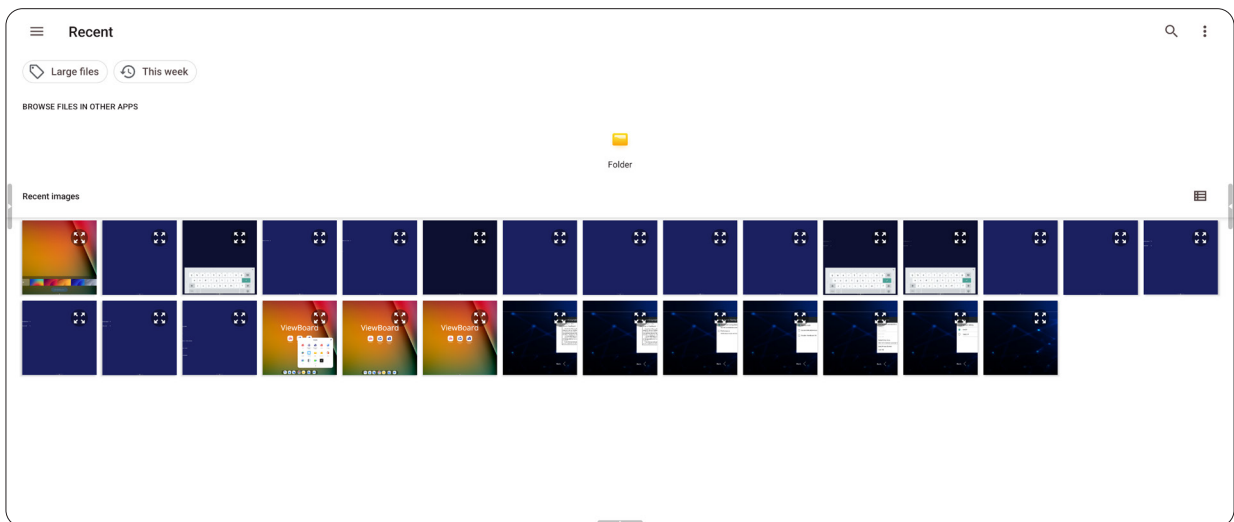
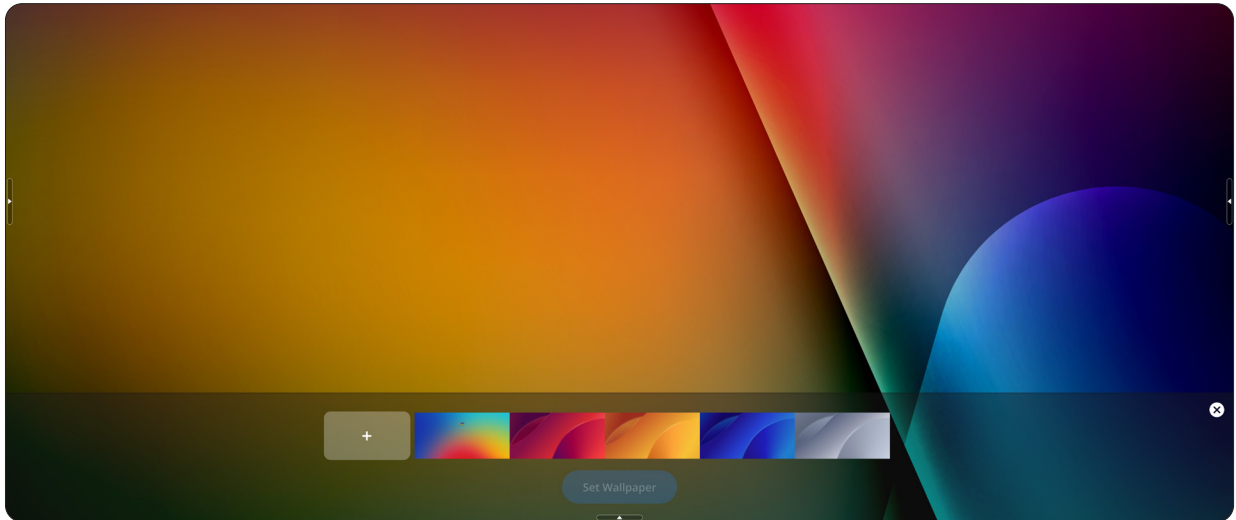

## Protection

Set **HDCP & Copyright** on or off.

### Protection

**HDCP & Copyright**

HDCP is a secure protocol for protecting transmission of audio and video signals.

## HDMI Out

Adjust the HDMI Out Resolution setting, enable video output, and mute/unmute the display speaker when connected via HDMI Out.

**NOTE:** The disable ViewBoard speakers option box is not selected by default.

### HDMI Out

**HDMI-out resolution setting**

3840X2160\_60HZ

1920X1080\_60HZ

720X480\_60HZ

AUTO

**HDMI IN OUT**

It is necessary to plug and unplug the HDMI interface once to take effect.

Disable ViewBoard speakers when using HDMI out

# Preferences

View and adjust Touch, Language, Keyboard & Input, Date & Time, Boot Mode & Advanced, Start up & Shut down, Toolbar, Multi-Window Mode, and Sound settings.

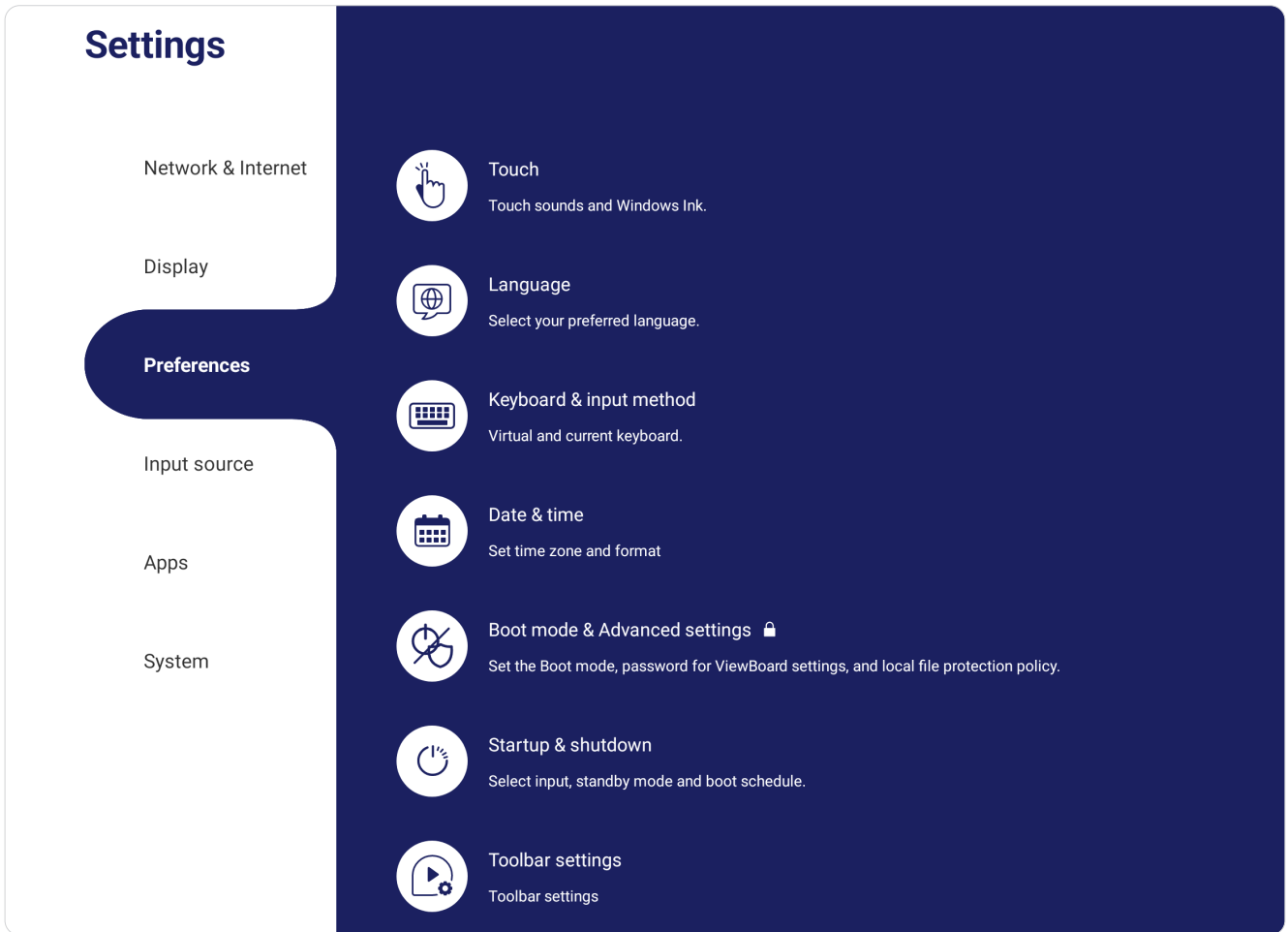

## Touch

Adjust **Touch Settings** and toggle **Touch Sounds** and **Windows Ink** On/Off.



## Language

Adjust and choose the preferred language from the available languages.

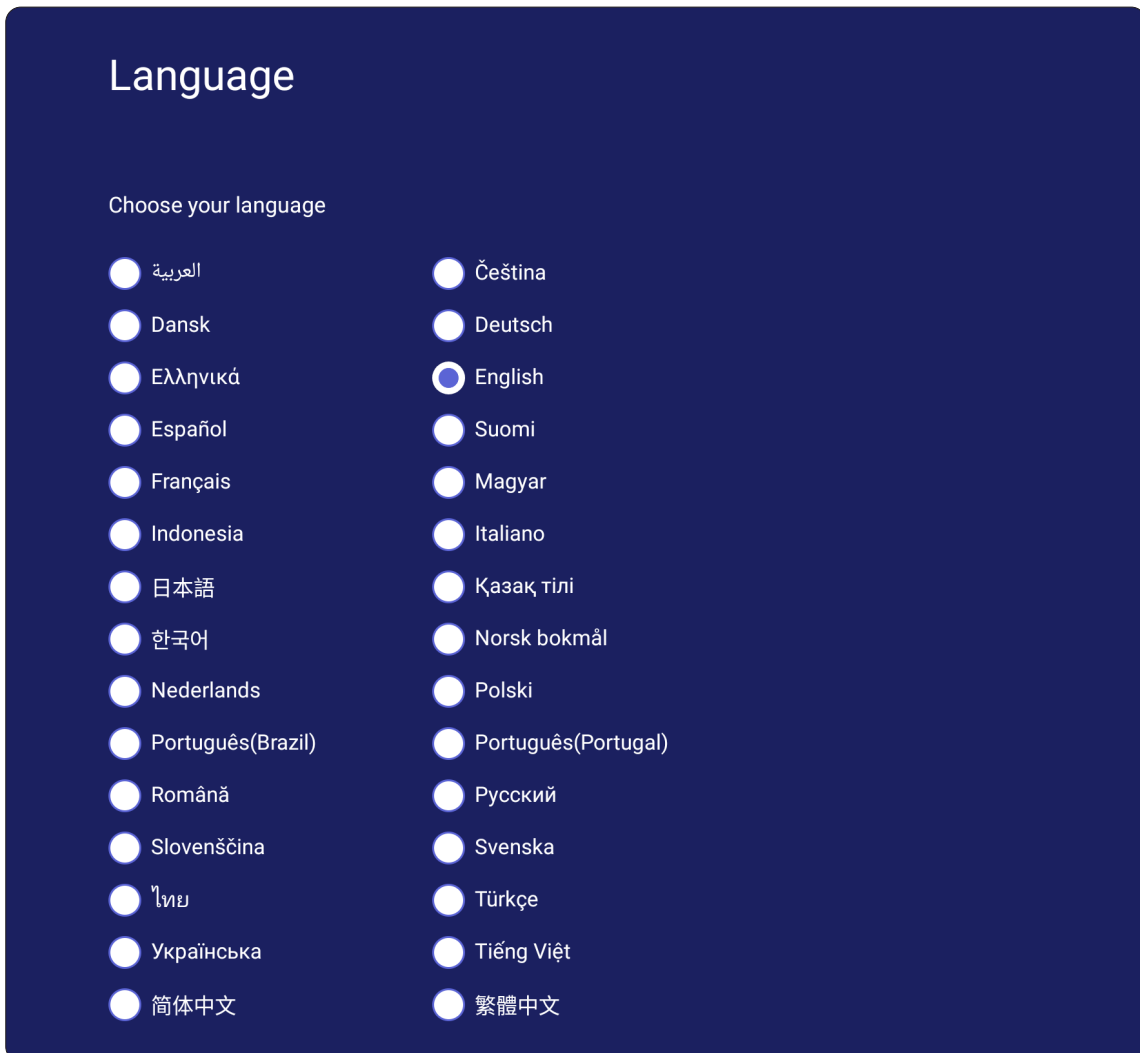

## Keyboard & Input Method

Enable/disable the visual keyboard and/or change the default input method. Tap on **Settings** to adjust the advanced keyboard settings.

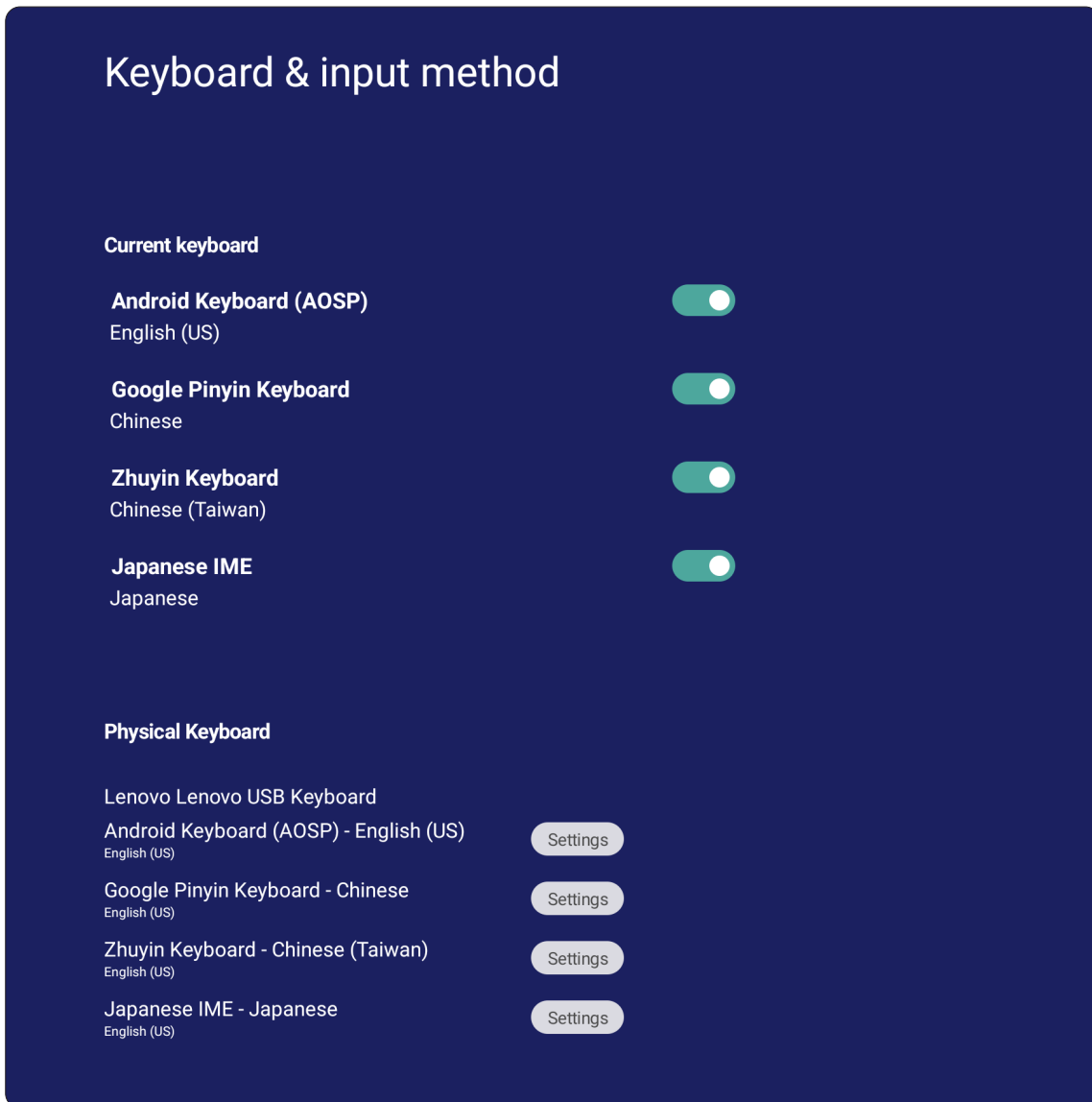

**NOTE:** When an external USB keyboard is connected, the menu will display the physical keyboard settings option.

## Date & Time

Set the system time and format.

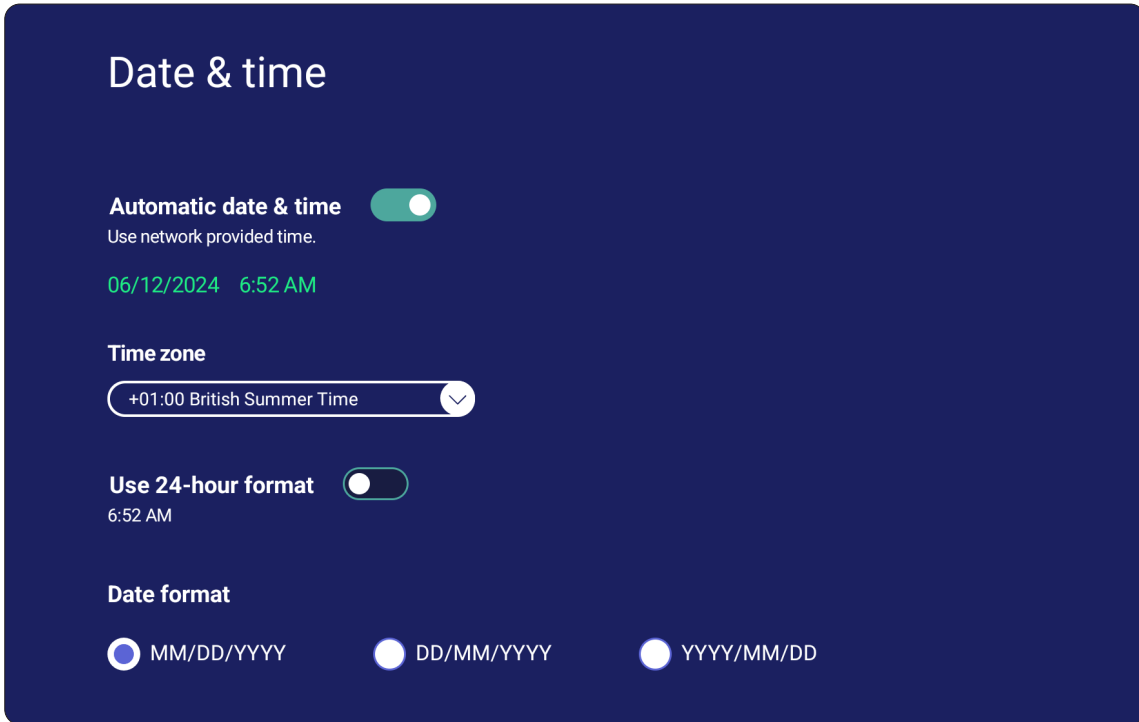

| Item                             | Description  |
|----------------------------------|--|
| <b>Automatic Date &amp; Time</b> | When enabled, the ViewBoard will automatically synchronize the date and time via the Internet. |
| <b>Time Zone</b>                 | Select the appropriate time zone.  |
| <b>Time Format</b>               | Choose from 12-hour or 24-hour time format. Simply toggle 24-hour format On/Off.               |
| <b>Date Format</b>               | Select from the available date formats.  |

## Boot Mode & Advanced Settings

Adjust the preferred boot up mode and set/reset a password.

### Boot mode & Advanced settings

- Normal mode**  
 Launch startup programs, begin all services configured to start, and loads the hardware drivers you have installed as normal.
- Secure mode**  
 Removes embedded screen sharing apps such as V-Cast, E-Airplay, and Chrome Cast.
- Disable embedded OS**  
 The embedded OS will be disabled after reboot.

**Enable password for ViewBoard settings**

If enabled users will have to enter a password to open ViewBoard settings

**Boot mode and advanced settings password**  Reset password

#### Local File Protections Policy

To protect personal files, the local storage file in Folder app will be deleted automatically at the time of your c

- Do not clear file(s)**
- Delete after 1 Day**
- Delete after 1 Hour**
- Delete immediately**

---

**Color correction**

- Monochromacy
- Deuteranomaly (red-green)
- Protanomaly (red-green)
- Tritanomaly (blue-yellow)

**Non-ViewBoard OS mode side toolbar settings**

Set side toolbar on/off for non-ViewBoard OS mode

Reset ViewBoard

| Item                       | Description   |
|----------------------------|---|
| <b>Normal Mode</b>         | The embedded screen sharing Apps will run normally.                             |
| <b>Secured Mode</b>        | The embedded screen sharing Apps will be removed.                               |
| <b>Disable Embedded OS</b> | The system will automatically reboot, and then the Embedded OS will not appear. |

| Item                                      | Description  |
|---|--|
| <b>ViewBoard Settings Access Password</b> | Toggle to lock/unlock the ViewBoard Settings.                          |
| <b>Password for Protection</b>            | Modify the Boot mode and ViewBoard Settings entry password.            |
| <b>Local File Protection Policy</b>       | Choose how long to keep local storage files in the Folder application. |
| <b>Color Correction</b>                   | Color correct the ViewBoard display screen.                            |
| <b>Reset ViewBoard</b>                    | Reset the ViewBoard to its factory default settings.                   |

## Startup & Shutdown

Set the Startup Input, Standby Mode, EnergyStar Mode, Black Screen After Startup, Power off Reminder timer and Schedule settings.

### Startup & shutdown

**Startup input**

Last shutdown input    
  Select input    
 ViewBoard ▼

**Startup application** N/A ▼

Automatically launch a specific application upon startup.

**Standby mode**

Hibernation  
 Hibernate Mode turns off the entire device including the display. To wake up, use the power button on the ViewBoard, the remote control, or use a compatible device via RS232.

Sleep  
 Sleep Mode turns off the display and major functions of the device. The operating system will remain running. Wake up the ViewBoard using the power button on the ViewBoard or the remote control, or use a compatible device connected via RS232.

**Energy Star**

After no action for one hour, device will enter standby mode as selected by the user (hibernate or sleep).

**Black screen after startup**

To conserve power, screen backlight will not turn on after startup.

**Sign-in page launched upon system startup**

Allows you to bypass the Sign-In page after the system is initiated.

---

**Time switch**

**Power off reminder**

Toggle Power off reminder

**Schedule** ADD SCHEDULE

Boot time
Off time

| Item                       | Description  |
|----------------------------|--|
| <b>Startup Input</b>       | Adjust the Startup Input preference.   |
| <b>Startup Application</b> | Automatically launch an application at startup.                                |
| <b>Standby Mode</b>        | Decide what happens when you press the Power button while the ViewBoard is On. |

| Item   | Description   |
|--|---|
| <b>Energy Star</b>                               | Enable to automatically initiate Sleep Mode when the screen is idle for one hour.       |
| <b>Black Screen After Startup</b>                | When enabled, the ViewBoard will turn off the backlight automatically after booting up. |
| <b>Sign-in Page Launched Upon System Startup</b> | Choose to skip the Sign-in page after startup.  |
| <b>Schedule</b>                                  | Schedule a Boot and Shut off time.  |

## Toolbar Settings

Adjust the Side toolbar settings.

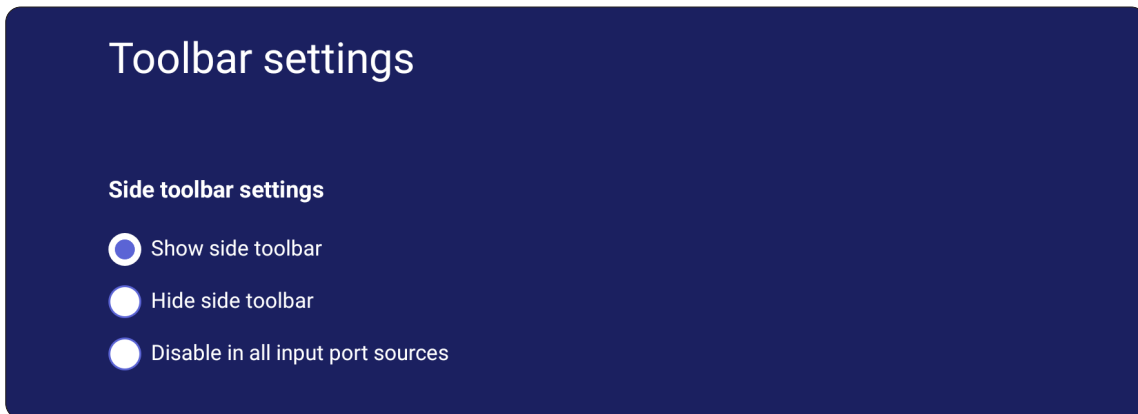

## Multi-Window Mode

Display more than one app at the same time on screen when turned on.

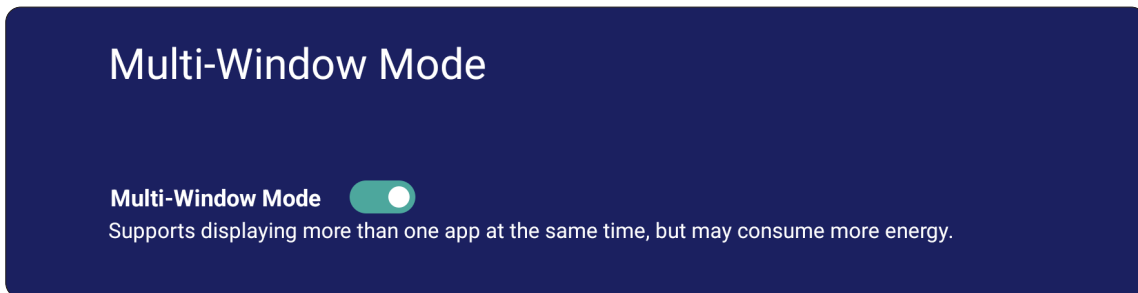

## Sound Setting

Adjust Touch Sound Output Settings.

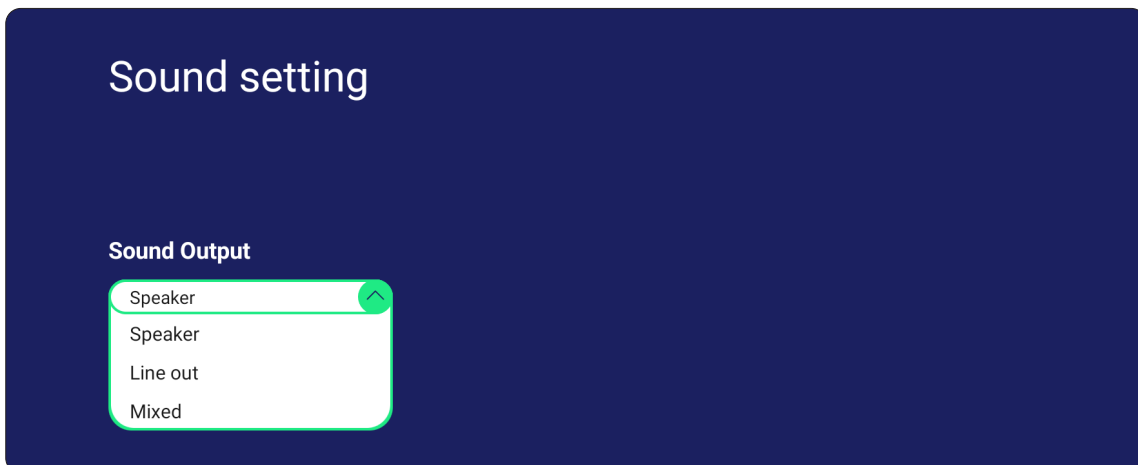

# Input Source

Adjust the input source names and settings, as well as the side toolbar settings.

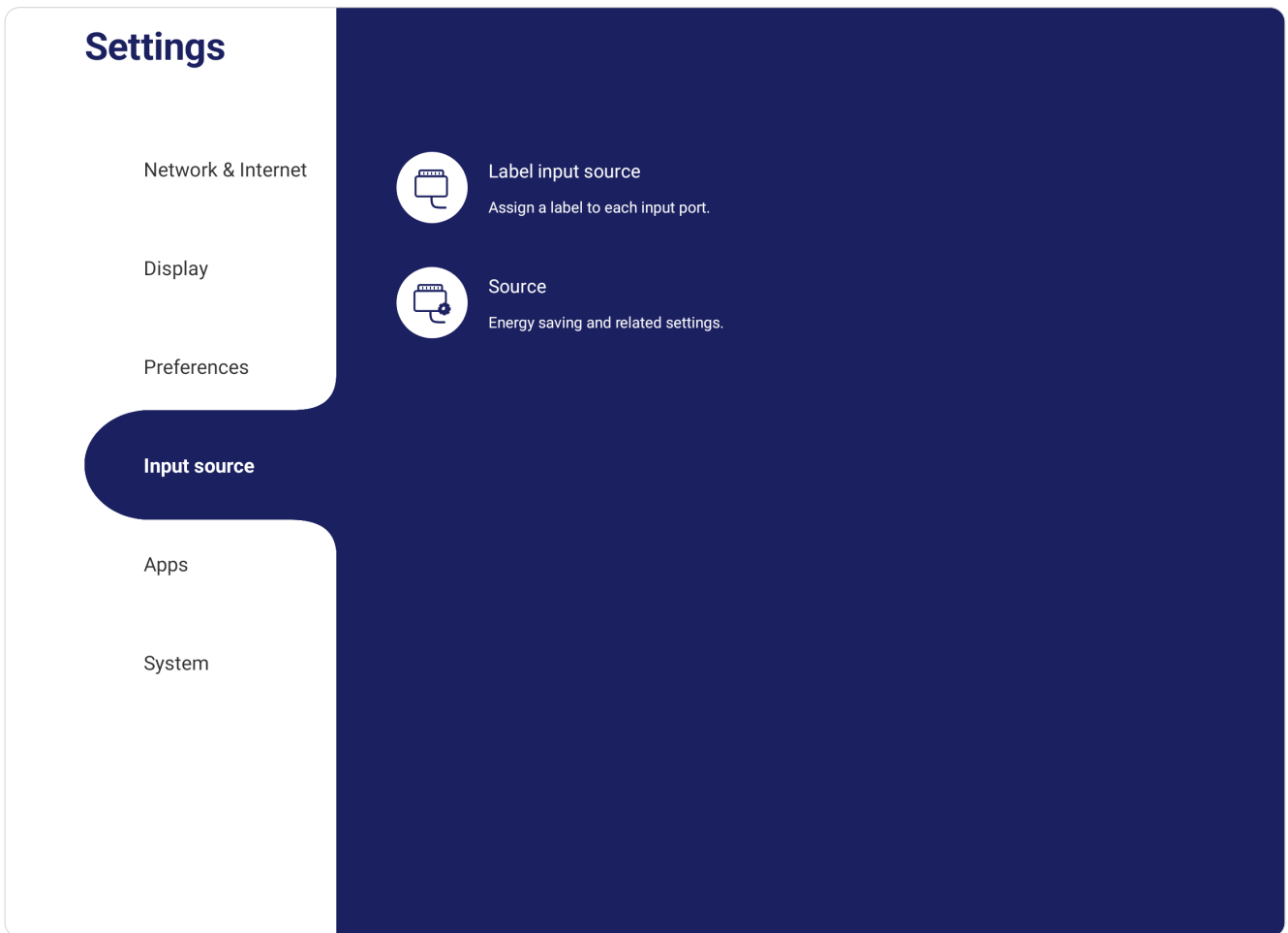

## Label Input Source

Set labels for each input source that will be easily recognized when displayed.

### Label input source

Add a label to help you recognize input ports easier.

| Source    | Label     |                                     |
|-----------|-----------|-------------------------------------|
| ViewBoard | ViewBoard |                                     |
| HDMI 1    | HDMI 1    | <input checked="" type="checkbox"/> |
| HDMI 2    | HDMI 2    | <input checked="" type="checkbox"/> |
| HDMI 3    | HDMI 3    | <input checked="" type="checkbox"/> |
| HDMI 4    | HDMI 4    | <input checked="" type="checkbox"/> |
| DP        | DP        | <input checked="" type="checkbox"/> |
| TYPEC 1   | TYPEC 1   | <input checked="" type="checkbox"/> |
| TYPEC 2   | TYPEC 2   | <input checked="" type="checkbox"/> |

## Source

Toggle Wake up by active HDMI input, Auto search signal, and HDMI CEC and select Auto switch input ports, Energy saving, and OPS 5K detect preferences.

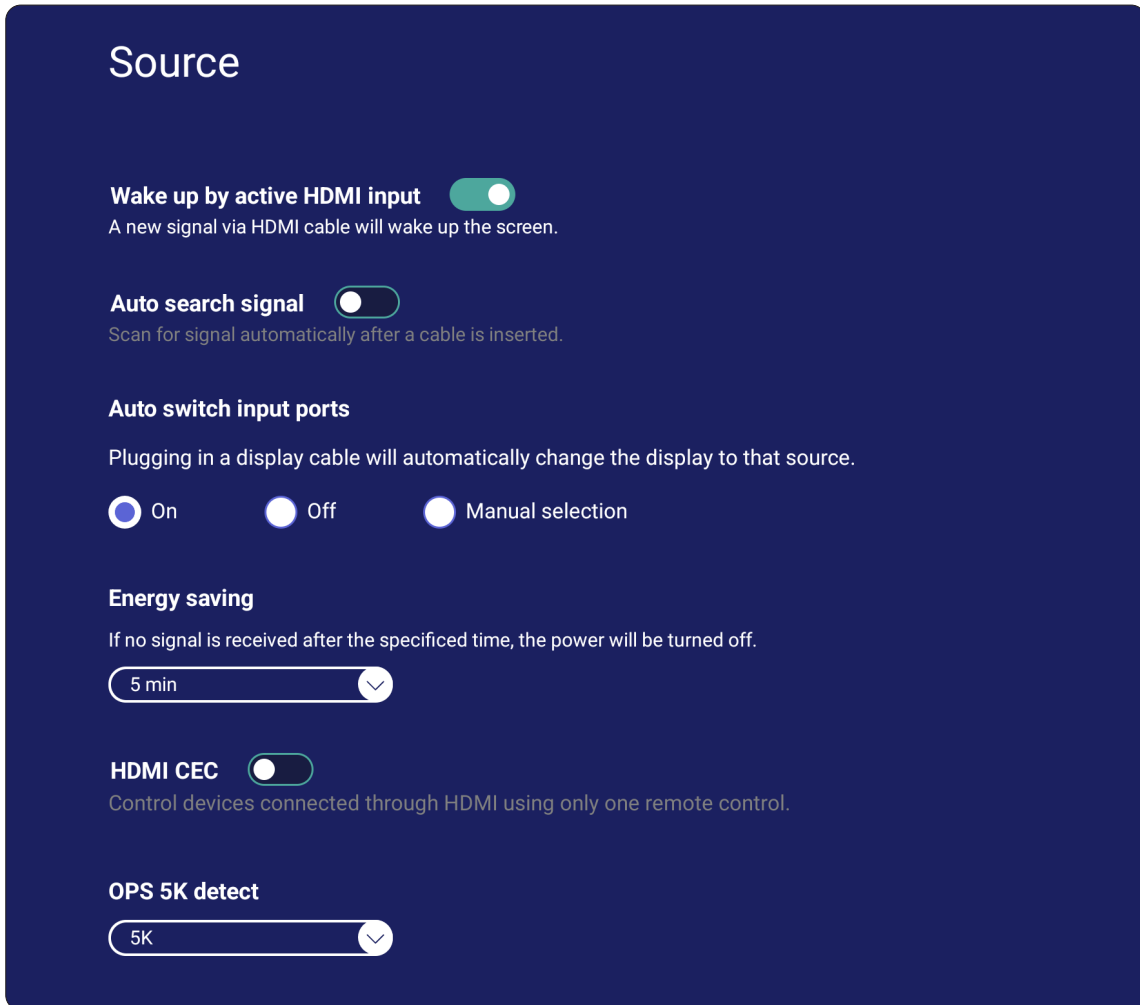

| Item                                | Description   |
|-------------------------------------|---|
| <b>Wake Up by Active HDMI Input</b> | The screen will turn on automatically after plugging in an HDMI cable when the screen is off.   |
| <b>Auto Search Signal</b>           | When enabled, if the current source does not have a signal, the ViewBoard will automatically search for an input source.  |
| <b>Auto Switch Input Ports</b>      | The original signal will automatically switch to a new cable after it's plugged in.   |
| <b>Energy Saving</b>                | Set a time period to power off if no signal is detected.  |
| <b>HDMI CEC</b>                     | Enable/disable HDMI CEC functions.  |
| <b>OPS 5K Detect</b>                | Set OPS support resolution.<br><b>NOTE:</b> Please confirm the resolution supported by OPS and select the corresponding resolution option, otherwise there may be a situation where it cannot be displayed. |

# Apps

The user can view application information and force stop, uninstall, move to USB storage, clear data, clear cache, and clear defaults.

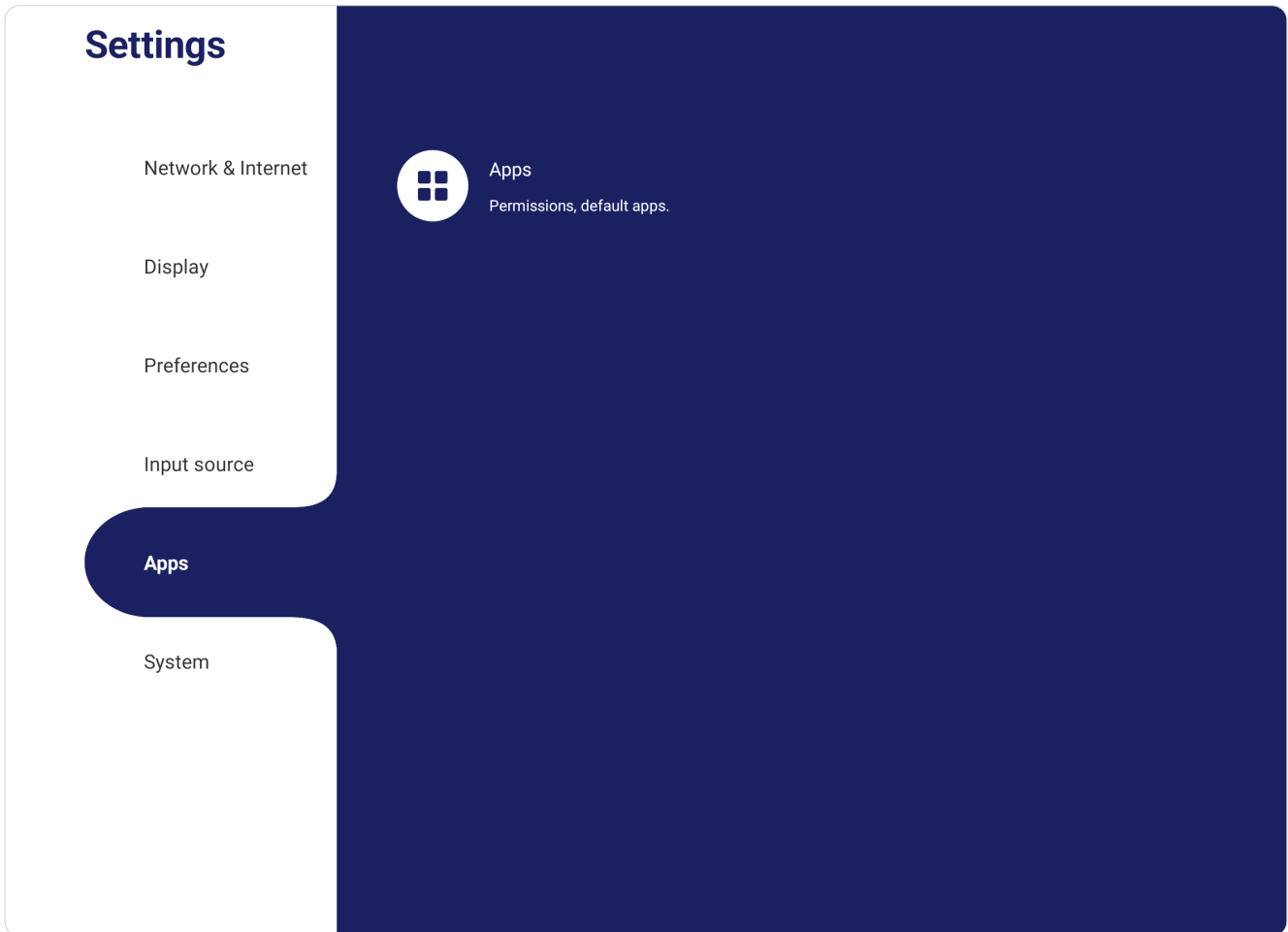

## NOTE:

- Pre-loaded apps cannot be uninstalled.
- Not all apps support the move to USB storage feature.
- Not all apps support Clear Defaults.

## Apps

View any running or installed applications. Tap on them for more detailed information and options.

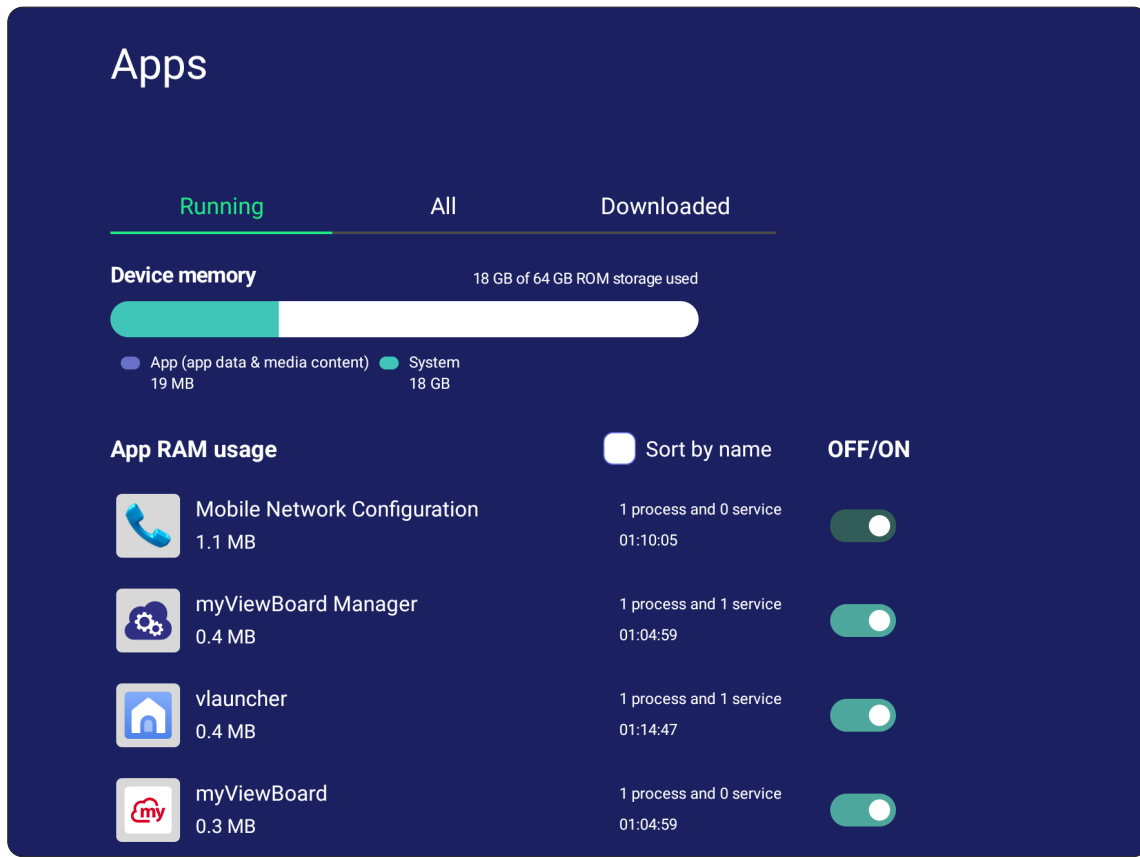

- By tapping on a running application, you can see more information, stop, or report the application.

- Selecting **All** will list all installed applications.

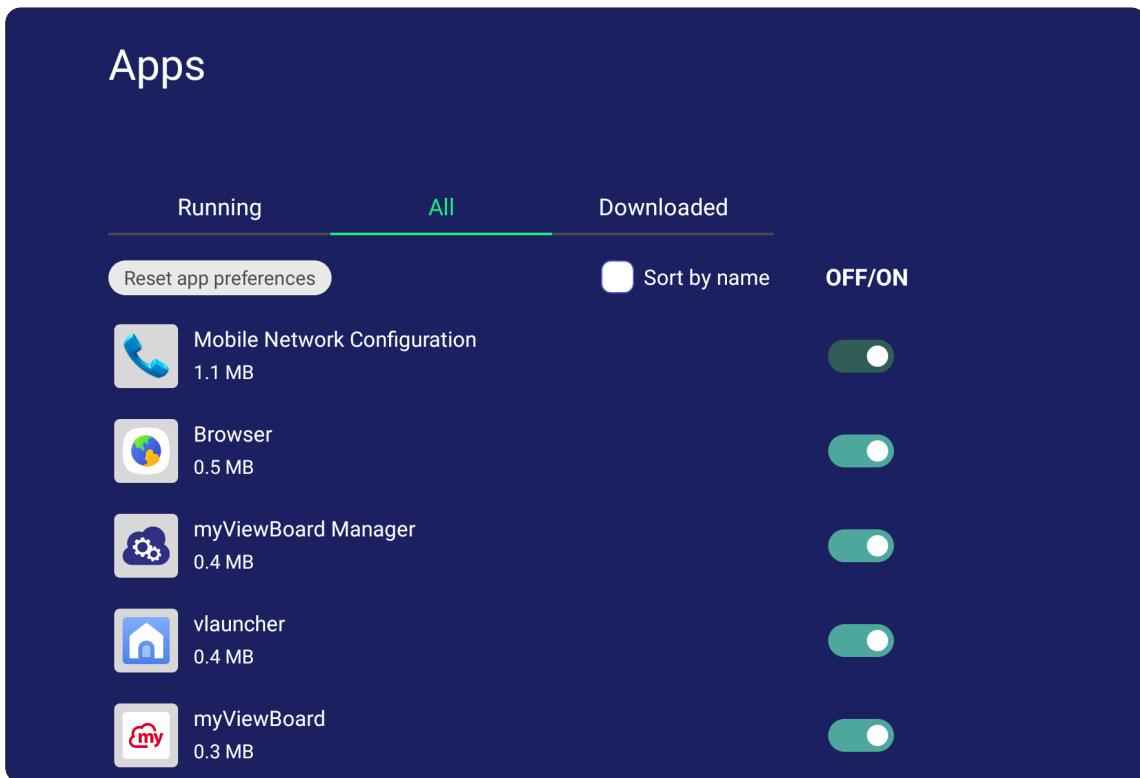

- Tapping on any application will display further information and options.
- Selecting **Download** will list all installed applications that can be uninstalled.

# System

View and adjust Storage, Clone to USB, Display ID, Security, System Update, and About device settings.

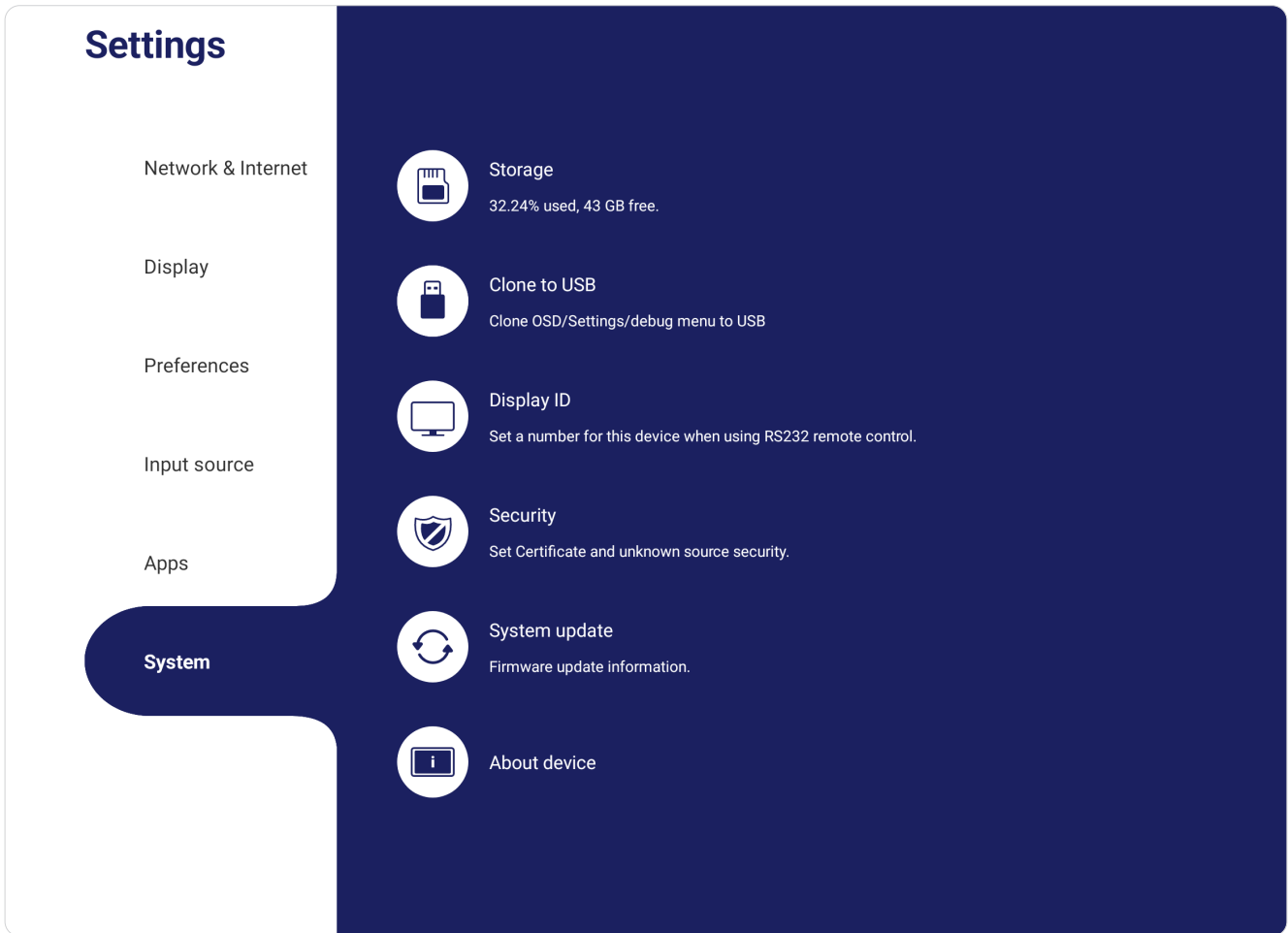

## Storage

Check the storage space status of the display (internal) and any connected external storage devices.

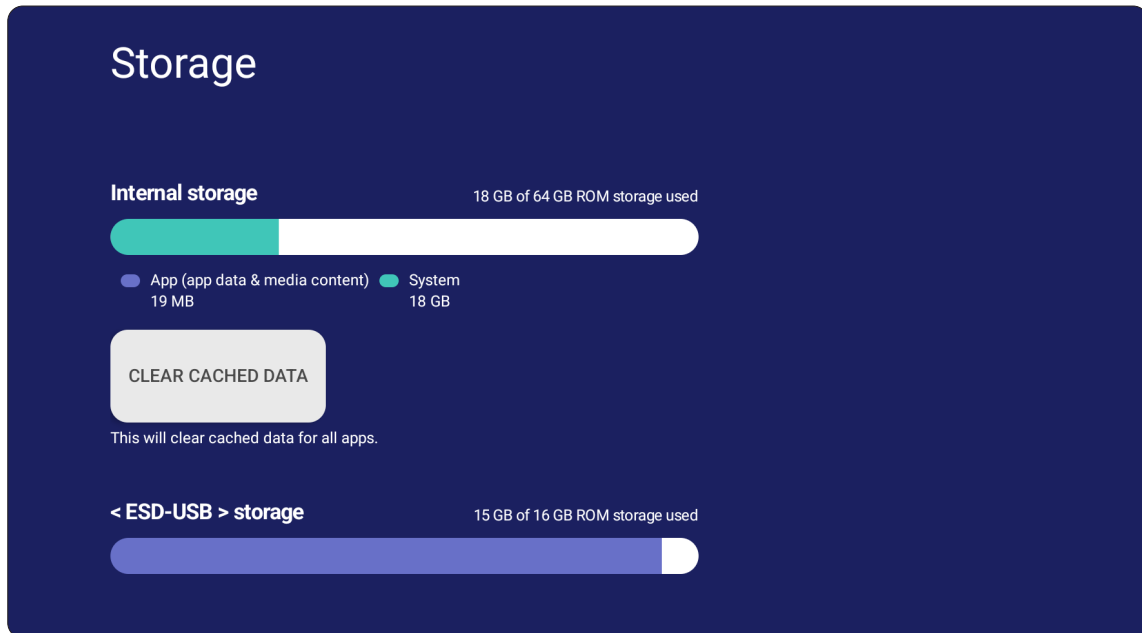

## Clone to USB

Copy settings to an external USB drive.

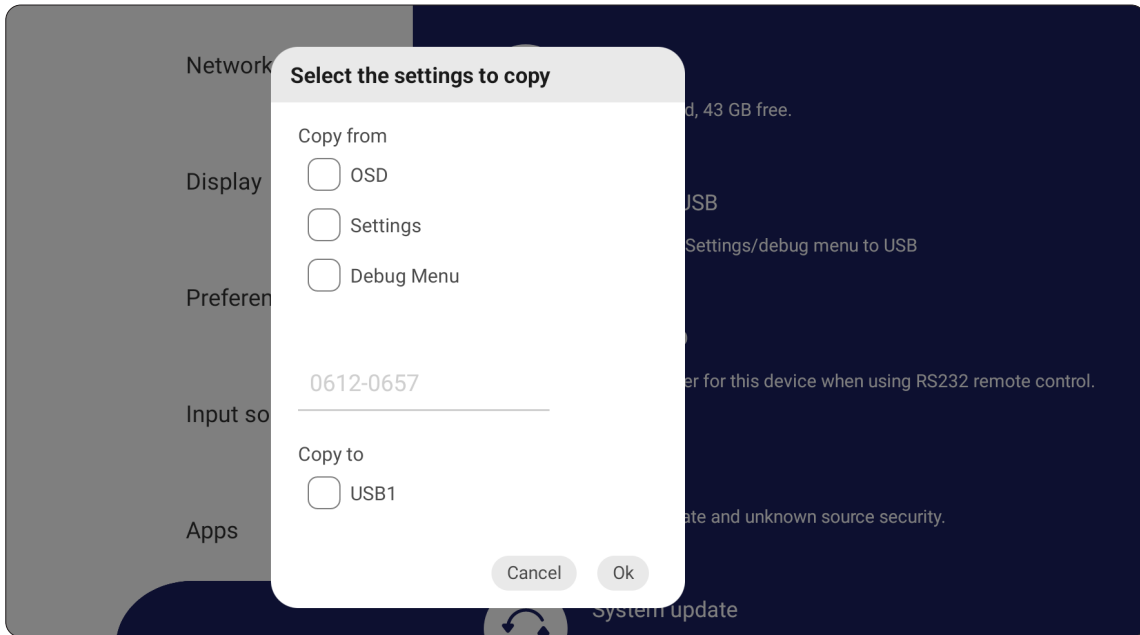

## Display ID

Assign a number to remote control the display by RS-232.

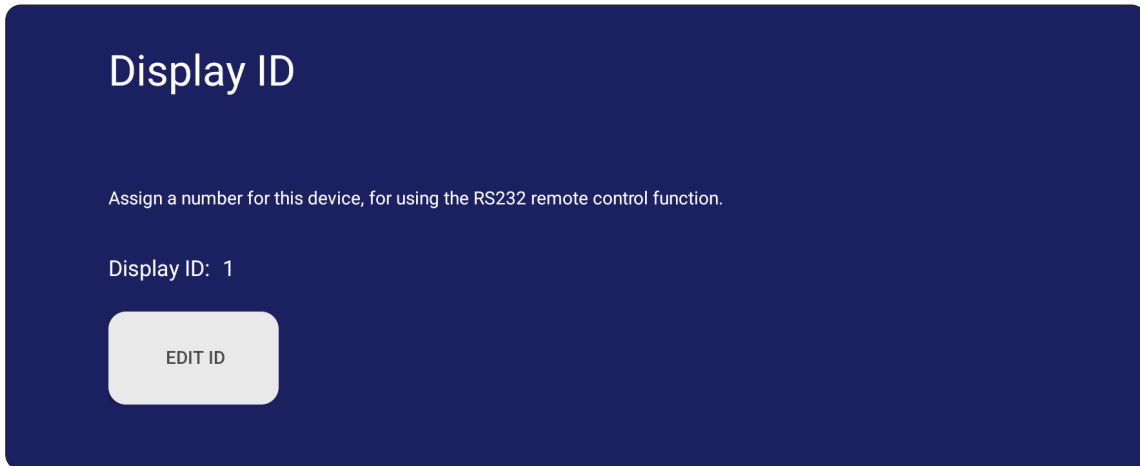

- To assign or change the Display ID, tap **Edit ID** and input a number.  
**NOTE:** The Display ID is for RS-232 users, and the range is 01~98.

## Security

Review Certificates, Trusted Credential storage, and Unknown sources install settings.

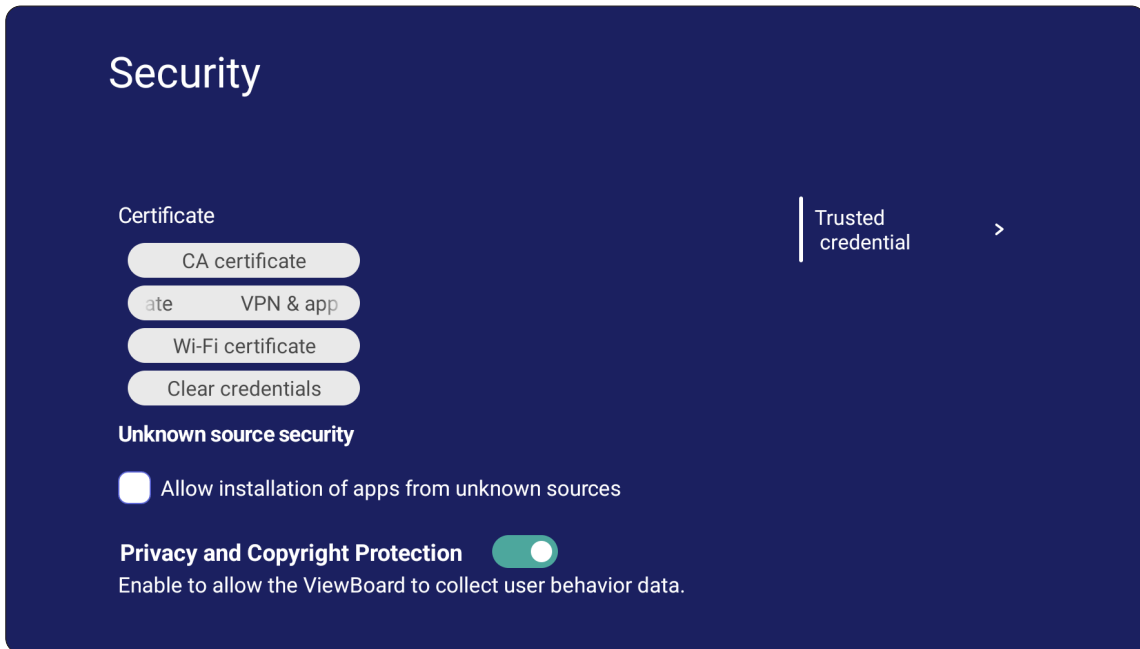

- Tap on **Install certificate from storage** to add additional certificates.
- Selecting **Clear Credentials** will remove all manually installed credentials.  
**NOTE:** Pre-loaded credentials cannot be cleared.
- Under **Trusted Credentials** view and edit all trusted and installed CA certificates.

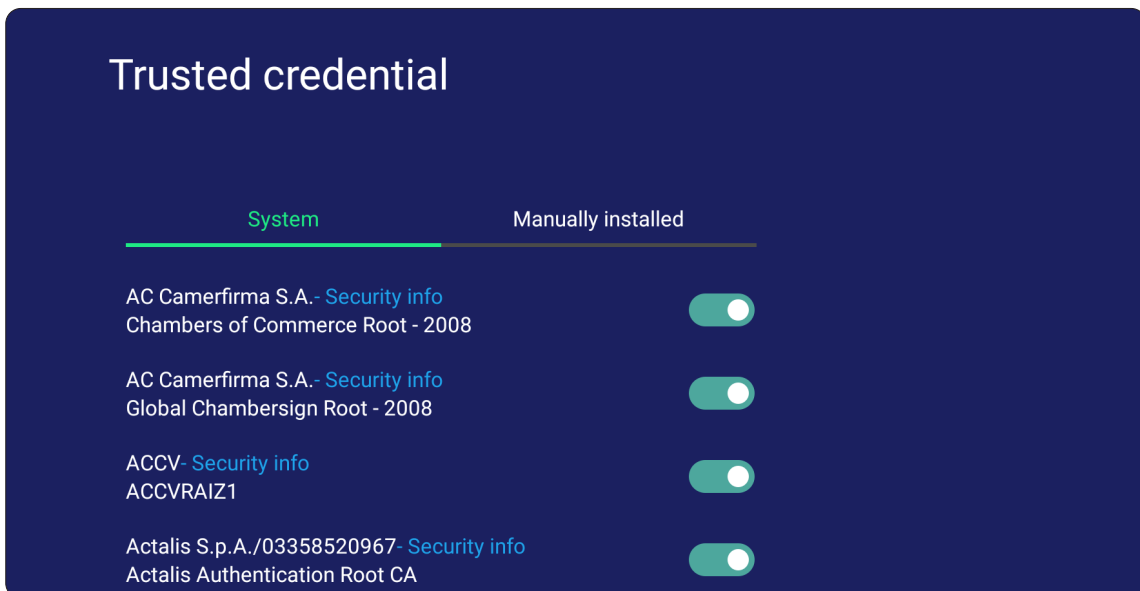

- Tapping on a credential will provide more detailed information.

- Allow the installation of applications from unknown sources by selecting the box under **Unknown source security**.



**NOTE:** Applications from unknown sources may not be compatible or work properly.

## System Update

The ViewBoard automatically searches for software updates whenever connected to the Internet (OTA). With just one click, users can update their version of ViewBoard software.

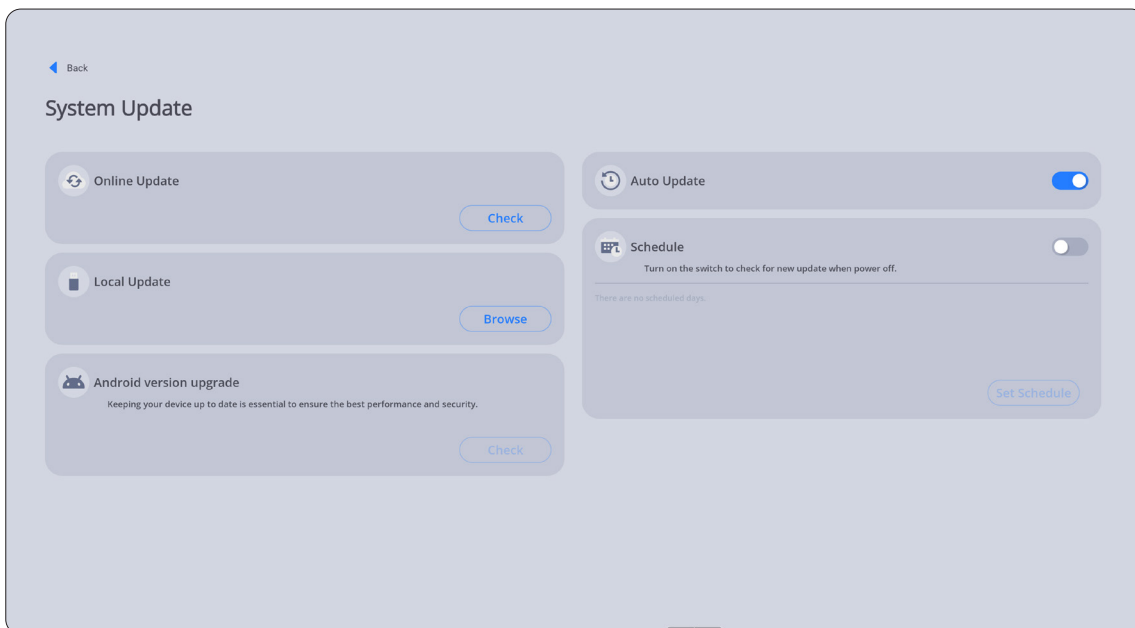

| Item                           | Description  |
|--------------------------------|--|
| <b>Online Update</b>           | Manually check online for a new software version.  |
| <b>Local Update</b>            | Update the software manually with a local file.  |
| <b>Android Version Upgrade</b> | Manually check for a new Android version.  |
| <b>Auto Update</b>             | When the display is off, the system will automatically check for a new version. If a new version is found, the system will automatically update. After the update is complete, the system will turn off. |
| <b>Schedule</b>                | Set the update time.   |

## About Device

Display Embedded Player information, Legal information, and Asset Tagging.

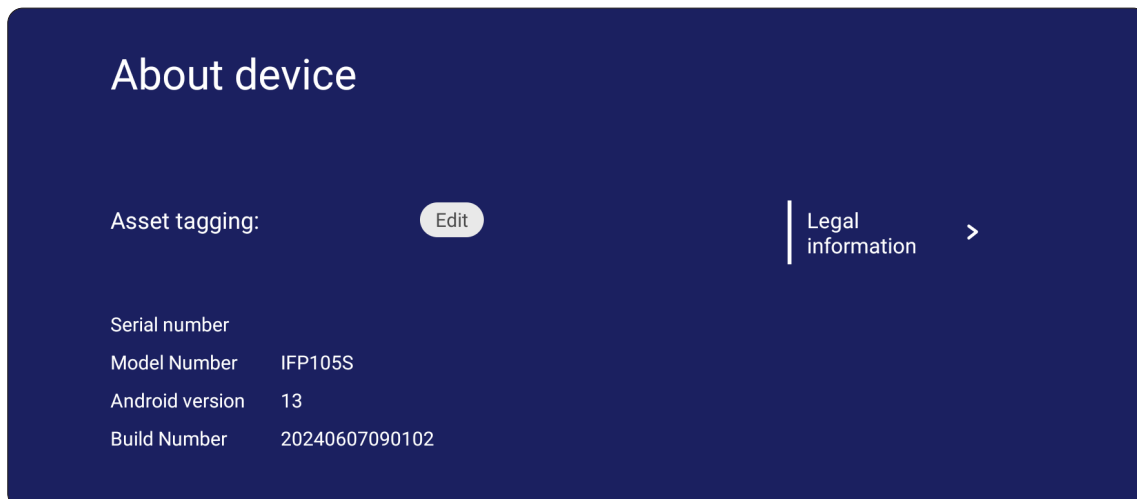

- By selecting **Edit**, the asset information can be adjusted.
- Tap on **Legal information** to check open source licenses.

# Pre-installed Applications and Settings

**NOTE:** Installed applications are subject to change (install, uninstall, update) without notice when the system is updated. Please contact your local customer service if you have any questions.

## myViewBoard

A digital whiteboarding application.

**NOTE:** To learn more about myViewBoard Whiteboard, visit:



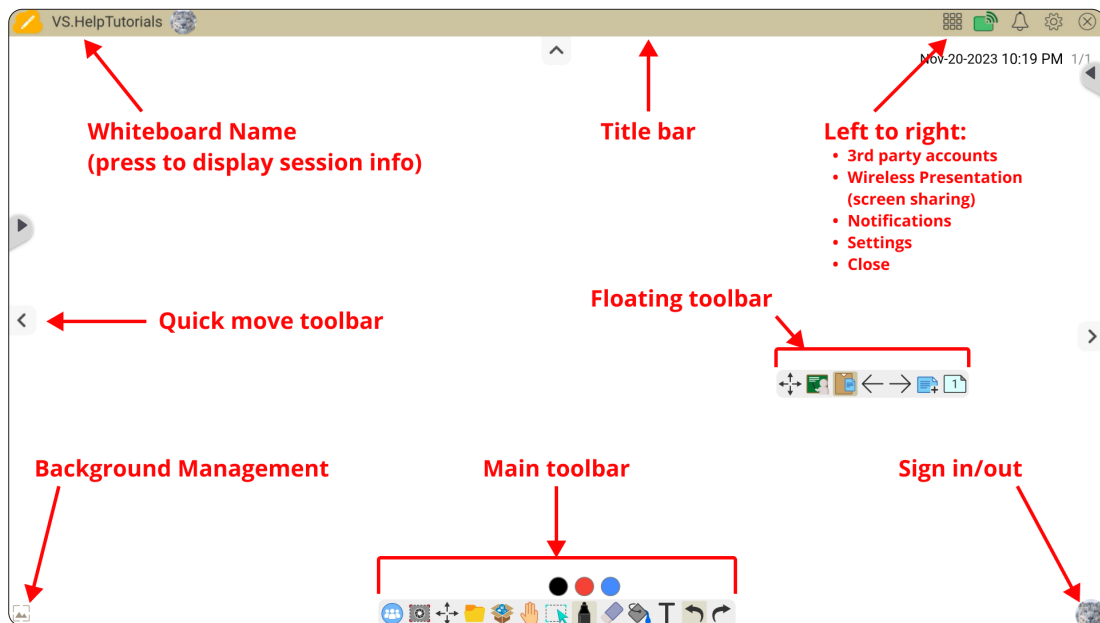











<https://myviewboard.com/kb/getting-started-whiteboard/overview-whiteboard>.









### Floating Toolbar

| Item | Description  |
|------|--|
|      | <b>Move</b><br>Move the Floating Toolbar.  |
|      | <b>Present Mode</b><br>Switch between presentation and preparation modes.            |
|      | <b>Paste from Clipboard</b><br>Insert the current clipboard content onto the canvas. |
|      | <b>Previous Page</b><br>Go to the previous page (if the canvas has multiple pages).  |
|      | <b>Next Page</b><br>Go to the next page (if the canvas has multiple pages).          |
|      | <b>New Page</b><br>Add a new canvas.   |
|      | <b>Pages in Whiteboard</b><br>Create, select, rearrange, copy and delete pages.      |

## Main Toolbar

|   | <b>Item</b>                  | <b>Description</b>  |
|---|------------------------------|---|
|    | <b>Wireless Presentation</b> | Enable and manage wireless presentations by casting your session to other devices or receiving a feed from other devices. |
|    | <b>Screen Capture</b>        | Screenshot, video, and audio recording.   |
|    | <b>Move</b>                  | Select and hold to move the toolbar to the left side, right side, or bottom of the screen.                                |
|    | <b>File Manager</b>          | Open, save, export, and print whiteboard files.   |
|    | <b>Magic Box</b>             | Import resources (image, video, audio, etc.) to the whiteboard.   |
|    | <b>Embedded Browser</b>      | Open the built-in browser to access internet resources, which can be dragged onto the canvas.                             |
|    | <b>Infinite Canvas</b>       | Drag to move the canvas. Use two hands to zoom in/zoom out. Select again for an overview.                                 |
|   | <b>Selection Tool</b>        | Select objects, text, and other elements on the canvas.   |
|  | <b>Pen</b>                   | Writing tools and customization options.  |
|  | <b>Eraser</b>                | Erase objects or clear the page.  |
|  | <b>Shapes and Lines</b>      | Draw shapes, arrows, and add tables.  |
|  | <b>Text</b>                  | Add a text box.   |
|  | <b>Undo</b>                  | Undo the previous action.   |
|  | <b>Redo</b>                  | Redo the previous action.   |

## Background Management

| Item  |                              | Description   |
|---|------------------------------|---|
|  | <b>Sign In</b>               | Sign in to a myViewBoard account.                           |
|  | <b>Background Management</b> | Change the canvas background.                               |
|  | <b>FollowMe Setting</b>      | Display custom images uploaded to a cloud storage account.  |
|  | <b>Color Palette</b>         | Choose from solid or gradient colors as the background.     |
|  | <b>Pre-installed</b>         | Choose backgrounds that come pre-installed with Whiteboard. |
|  | <b>myViewBoard Originals</b> | Display original content created by myViewBoard.            |
|  | <b>Local Hard Drive</b>      | Use images from the local hard drive.                       |

# Screen Recorder

Capture everything that is displayed on screen in a video format.



To launch the Screen Recorder application:

1. Select the Screen Recorder icon in the application drawer.
2. Tap the record icon and select the preferred recording configurations. Then tap the check mark.

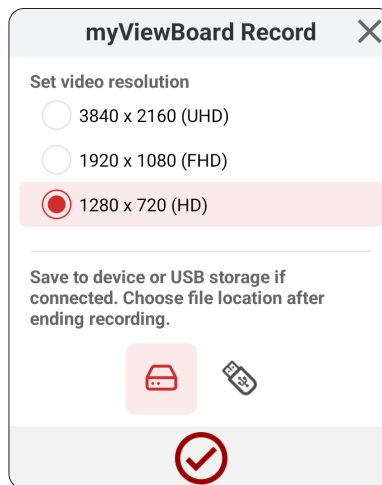

3. Select *Start Now* and a three second countdown will begin. Screen recording will begin immediately after the countdown.
4. After stopping the recording, you will be able to preview the video, save it, or discard it.

## vCast

Working with ViewBoard® Cast software (vCast, vCast Pro, and vCastSender), the vCast application will allow the ViewBoard to receive laptop screens (Windows/Mac/Chrome) and mobile (iOS/Android) users' screens, photos, videos, annotations, and camera(s) that are using the vCastSender application.

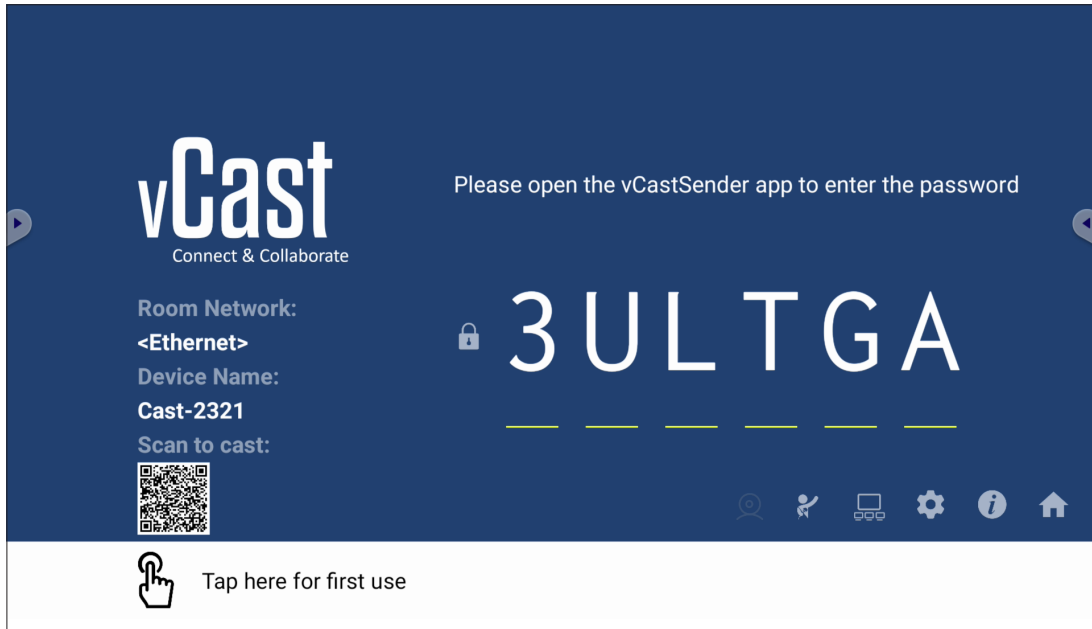

## Network Information

- ViewBoard® Cast software, laptops, and mobile devices can connect to both the same subnet and cross subnet by entering the on-screen PIN code.
- Connected devices will show up under **Device List** on the same subnet connection.
- If the device does not show up under **Device List**, users will need to key-in the on-screen PIN code.
- **Ports:**
  - » TCP 56789, 25123, 8121 & 8000 (Controlling message port & client device audio transfer)
  - » TCP 8600 (BYOM)
  - » TCP 53000 (Request share screen)
  - » TCP 52020 (Reverse control)
  - » TCP 52025 (Reverse control for ViewBoard Cast Button)
  - » TCP 52030 (Status sync)
  - » TCP 52040 (Moderator mode)
  - » UDP 48689, 25123 (Device searching and broadcast & client device audio transfer)
  - » UDP 5353 (Multicast search device protocol)
- **Port and DNS for Activation:**
  - » Port: 443
  - » DNS: <https://vcastactivate.viewsonic.com>
- **OTA Service**
  - » Server Port: TCP 443
  - » Server FQDN Name: <https://vcastupdate.viewsonic.com>

## Display Group Settings

To adjust the Display Group Settings, select the Display Group icon () located in the lower-right corner of the screen.

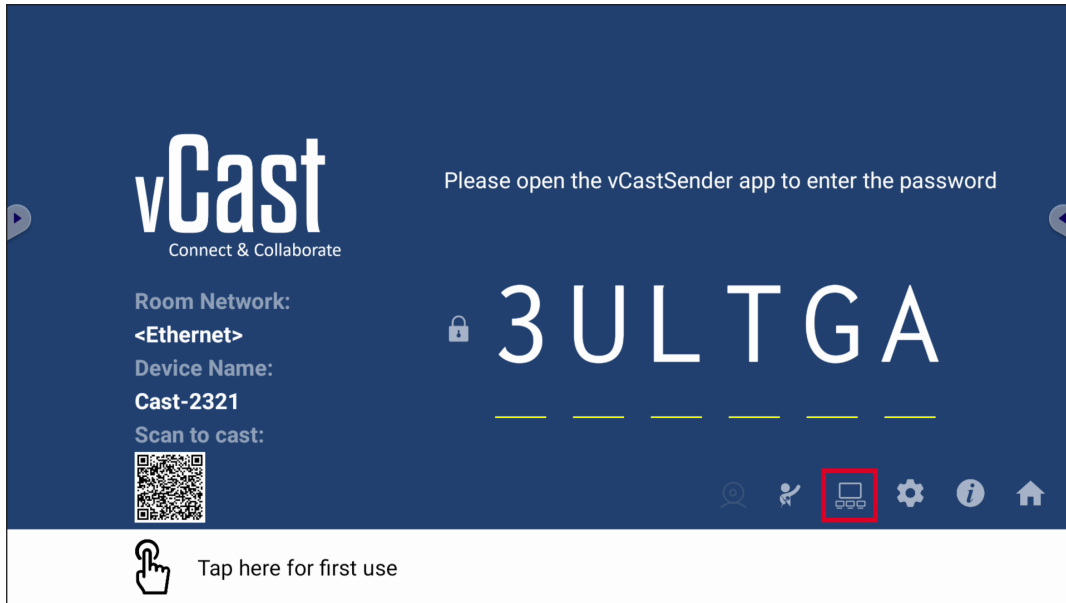

1. Toggle the “Turn On/Off Display Group” ON to enable the Display Group feature.

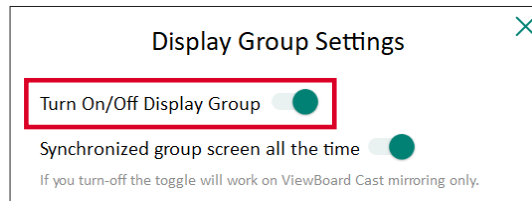

**NOTE:** Other preinstalled ViewBoard Cast devices in the same network will be listed.

2. Select the devices you want to join the display group and select **OK** to save the settings.

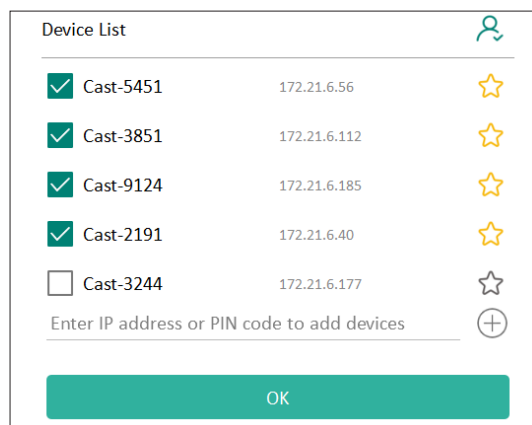

**NOTE:**

- If the devices you want to group are not listed, you can enter their respective IP address or connecting PIN code.
- The Display Group maximum device limit is six devices.

3. If you frequently connect to the same device, you can select the Star icon (★) next to the device to add it to your frequently connected devices list, “My List of Devices in Group”, for easier Display Group setup and management.

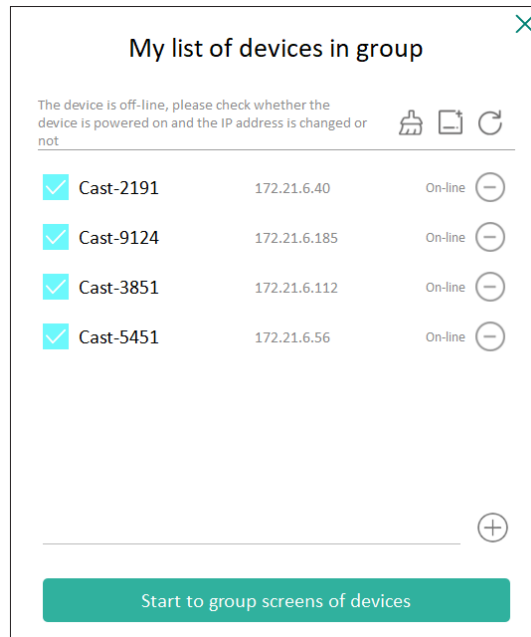

## Synchronized Group Screen All the Time

When the “Synchronized group screen all the time” function is toggled ON, it will display a synchronized group screen continuously. If it is toggled OFF, it will work on vCast mirroring only.

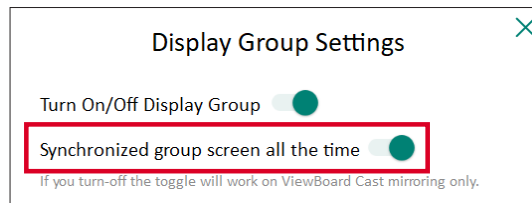

**NOTE:** Select the devices to group first, then toggle the “Synchronized group screen all the time” function ON to avoid interruption.

## Share a Screen to the Display Group (One to Many Casting)

After confirming the above settings, you can share your screen to the main display, then the grouped client devices will be synced up to your screen.



## Moderator Mode

Moderator Mode allows the moderator to take control of the devices connected to the ViewBoard or display. To enter Moderator Mode, select the Moderator Mode icon (👤) located in the lower-right corner of the screen.

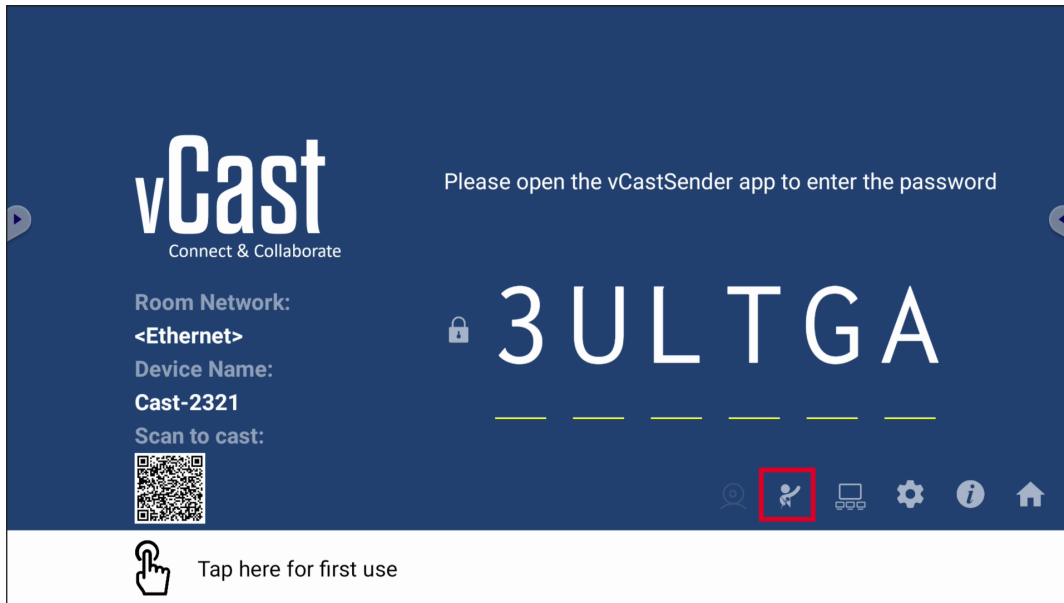

When enabled, the moderator can view a list of all connected screens in the left floating window and can preview each participant's screen and then select any of participant's screen and cast to the ViewBoard's or display's main screen for presentation. The moderator can also control each participant's screen, annotate on the ViewBoard or display, and remove unwanted participants by selecting the close icon (X).

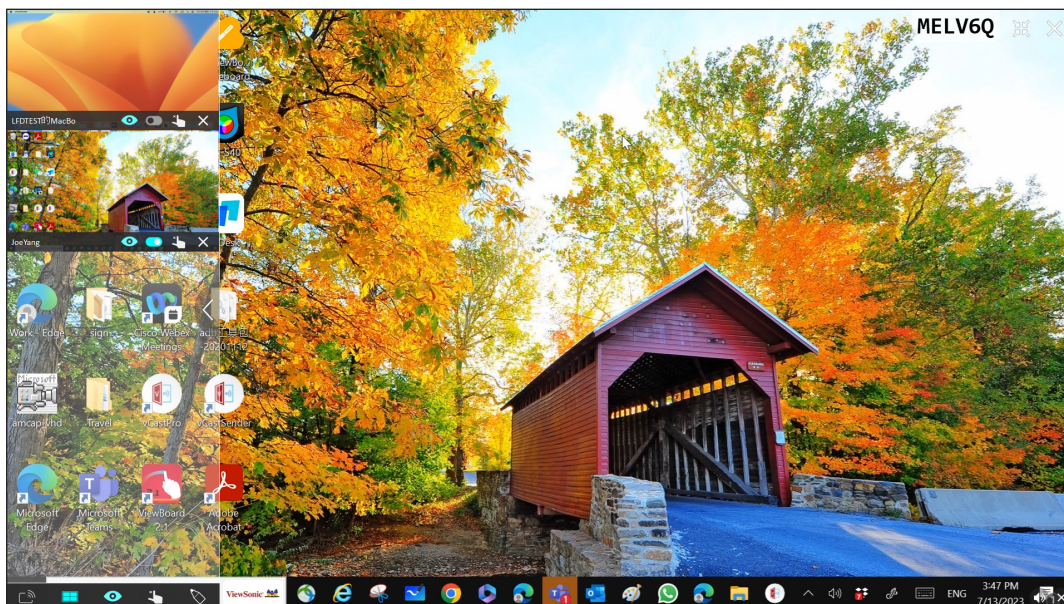

## Broadcast

When enabled, the ViewBoard's screen will be broadcasted to all of the participant's connected screens simultaneously. The participants can only view the presentation contents until the moderator disables the Broadcast function.

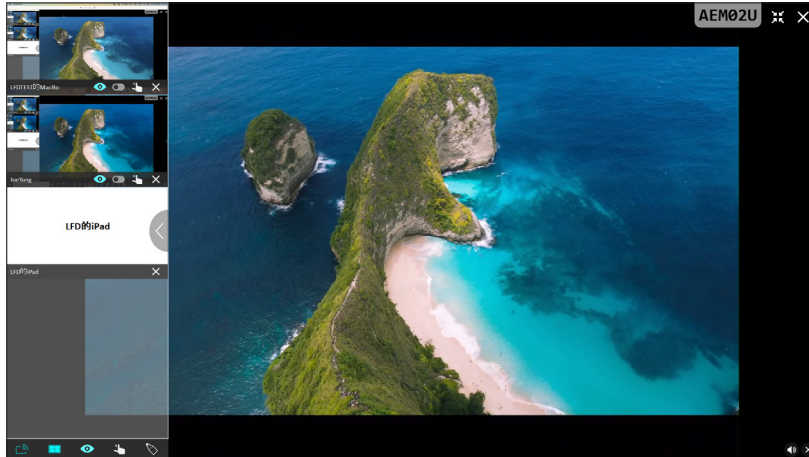

## Multiple Screen Sharing

By default, vCast is set to allow multiple screen sharing, but can also be set to single screen sharing. To do this, the moderator can select the Multiple Screen Sharing icon to switch to single screen sharing.

## Preview Screen

By default, vCast is set to let the moderator preview the participant's screen contents prior to sharing to the ViewBoard. Selecting the Preview Screen icon, the Moderator can switch to see the participant's name only.

## Touch

By default, participants can use touch for collaboration after connecting. The moderator can enable/disable the touch function of a participant by selecting the Touch icon in their window.

### NOTE:

- Moderator Mode is supported on all vCastSender and AirPlay devices, but mobile devices are limited to a “preview” function. Additionally, mobile Android devices cannot cast sound out.
- When you cast your Windows/Mac/Chrome screen to a ViewBoard or display, the selected full screen unit will not be broadcasted back to your device to avoid repetitive screen casting.
- The active presenter can touch each of the participant's screens to remotely control casting devices.
- The number of multi-screen presenters on-screen depends on your Windows CPU processor performance and router specifications.

## Casting from Windows, MacBook, and Chrome Devices

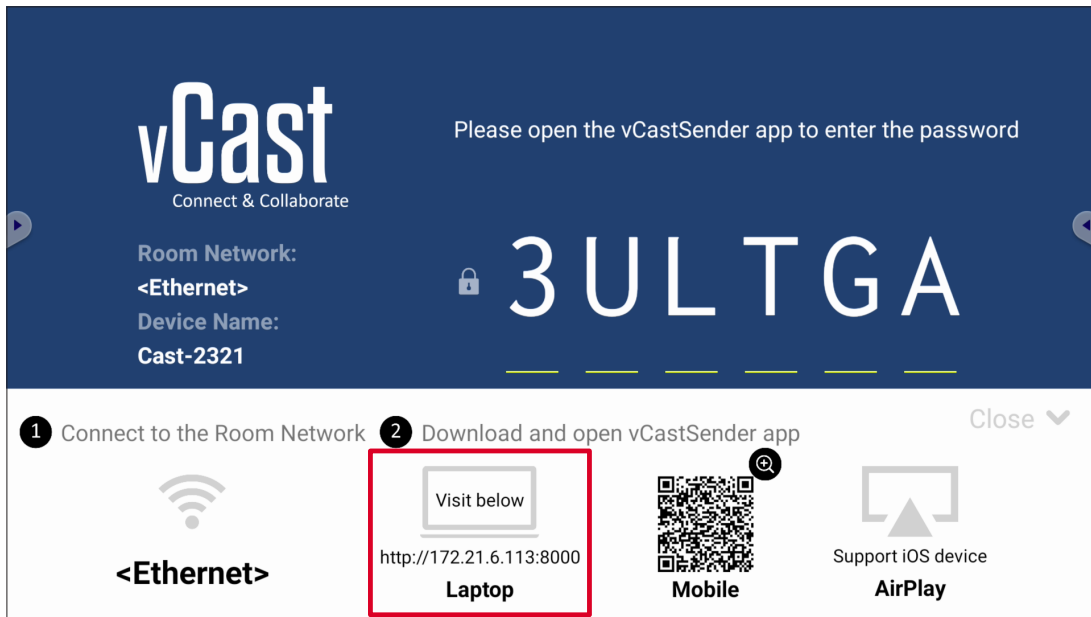

1. Ensure the client device (e.g., laptop) is connected to the same network as the ViewBoard.

**NOTE:** The network name can be found under **Room Network**.

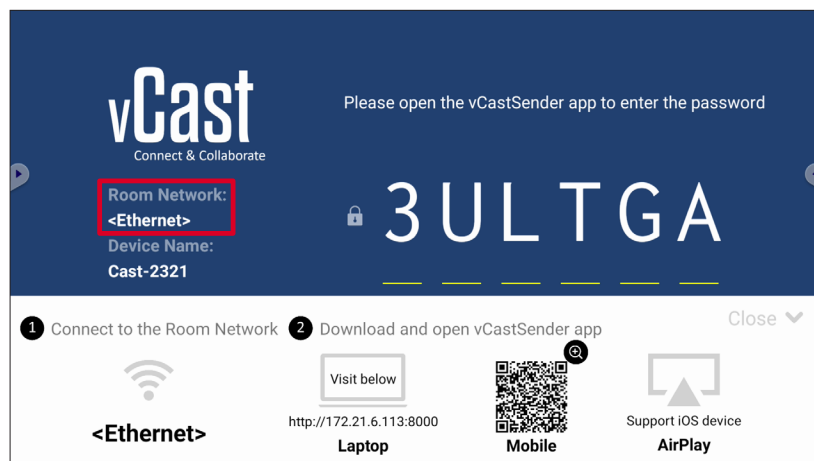

2. On the client device, visit the address that is shown on the ViewBoard to download and install the vCastSender application.
3. After installing, launch the vCastSender application.

4. To connect to the ViewBoard, input the PIN code and click OK.

**NOTE:** The PIN code can be found as highlighted below:

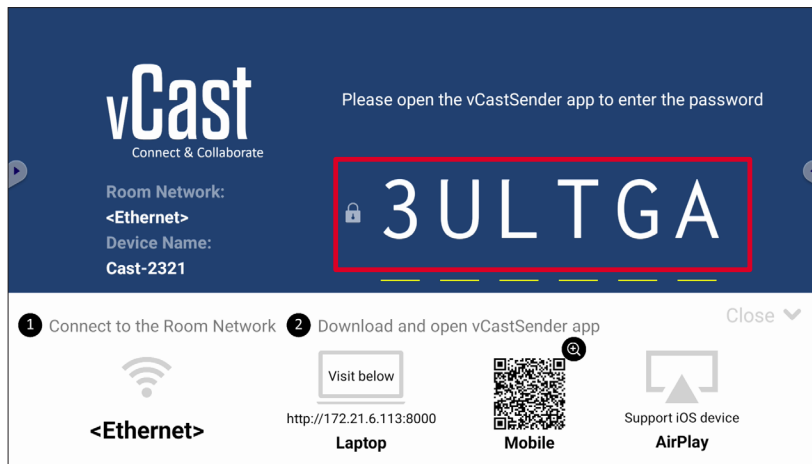

5. Additionally, you can connect to the ViewBoard by clicking **Device List** then the **Device Name** listed.

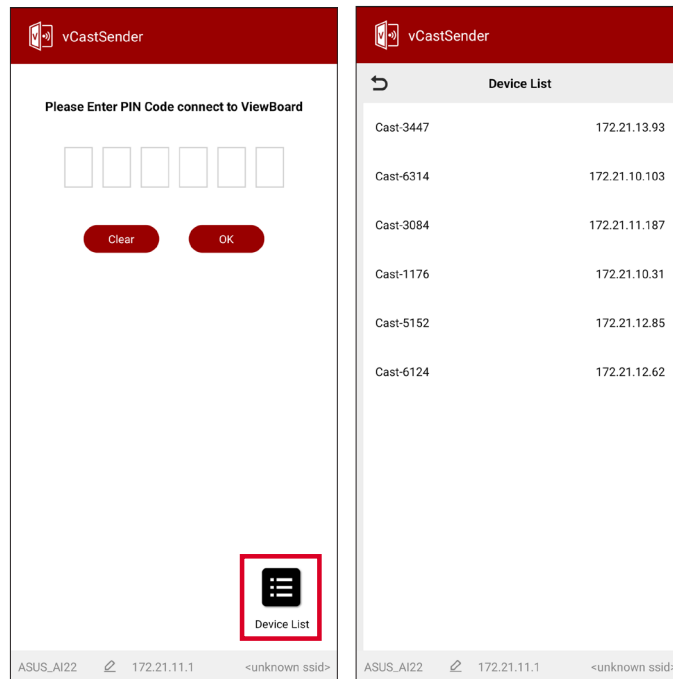

**NOTE:** The **Device Name** can be found as highlighted below:

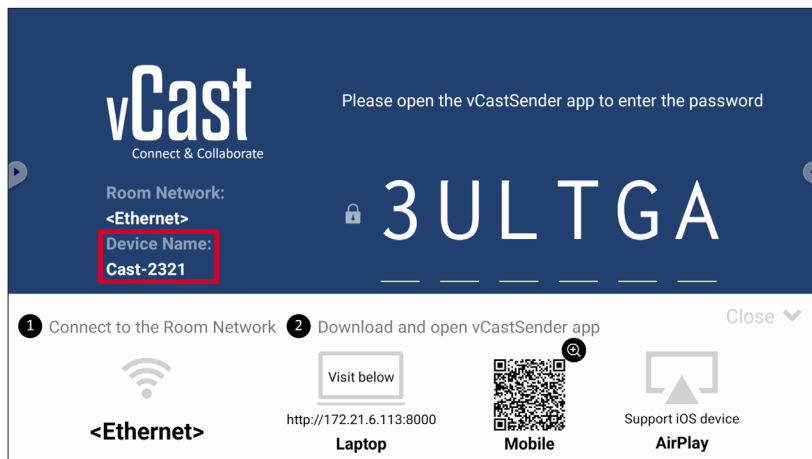

## Casting from Android Devices

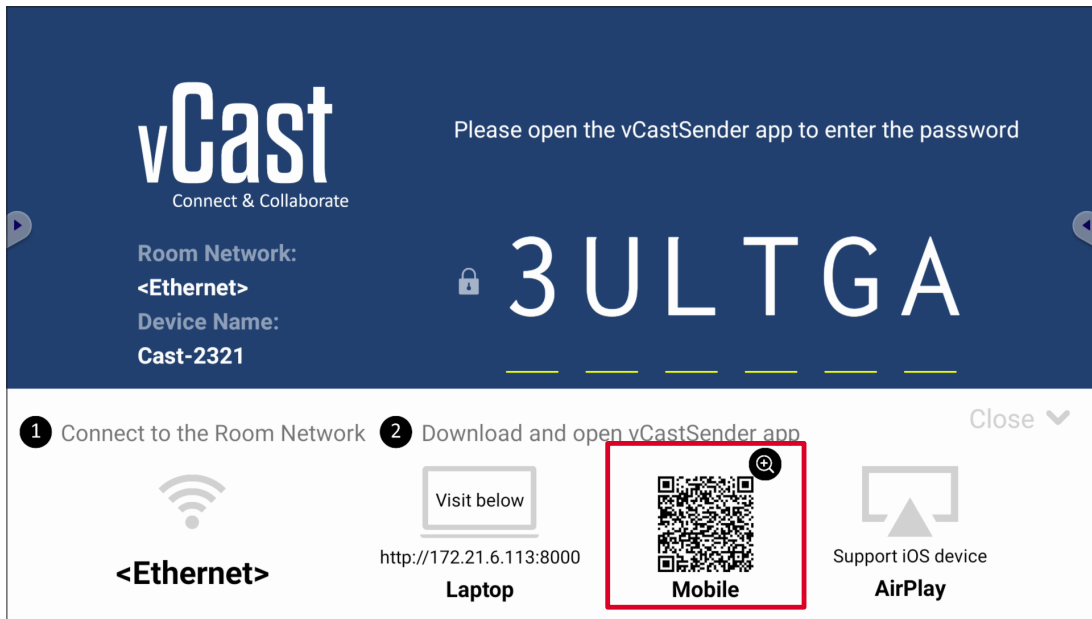

1. Ensure the client device (e.g., Android phone or tablet) is connected to the same network as the ViewBoard.

**NOTE:** The network name can be found under **Room Network**.

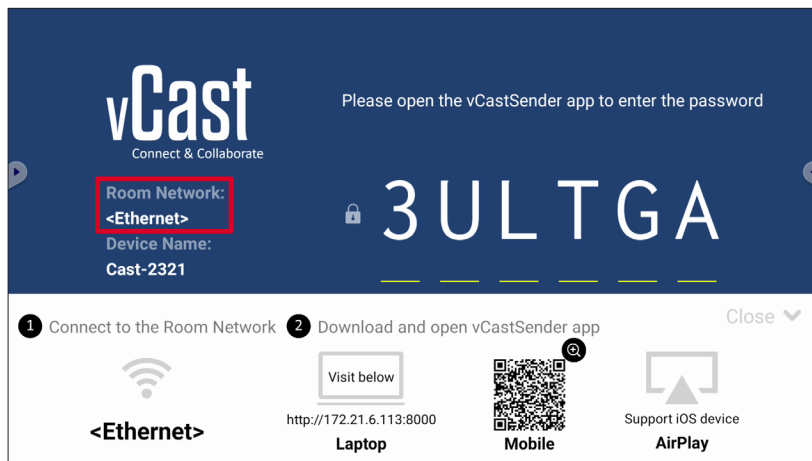

2. On the Android client device, scan the QR code shown on the ViewBoard to directly download the vCastSender application, or download the application from the Google Play Store.

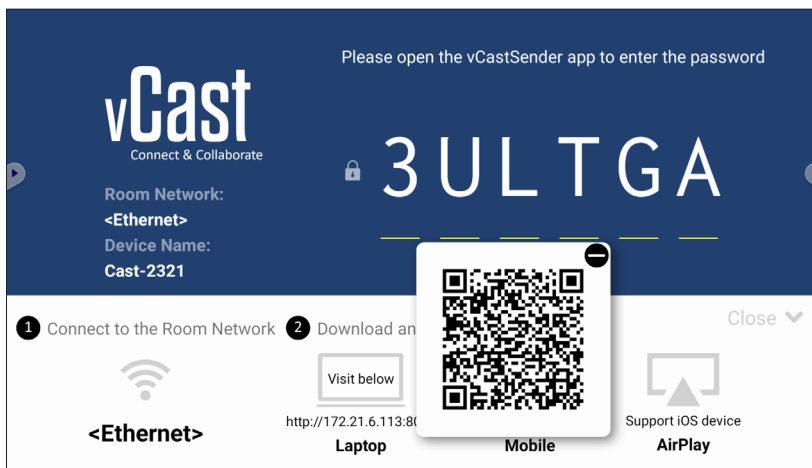

3. After installing, launch the vCastSender application.

4. To connect to the ViewBoard, input the PIN code and select **OK**.

**NOTE:** The **PIN code** can be found as highlighted below:

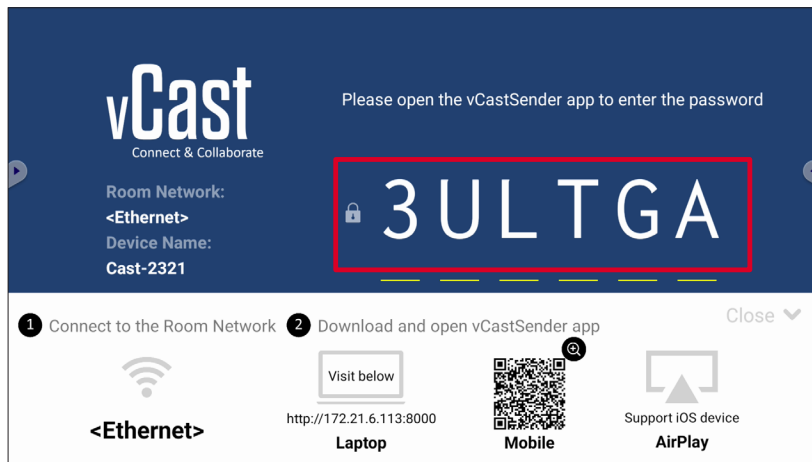

5. You can also connect to the ViewBoard by selecting **Device List** then the **Device Name** listed.

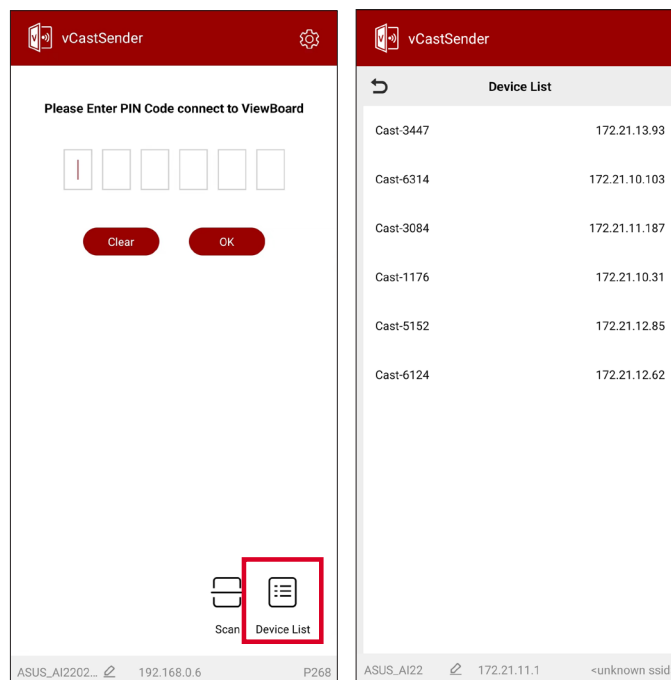

**NOTE:** The **Device Name** can be found as highlighted below:

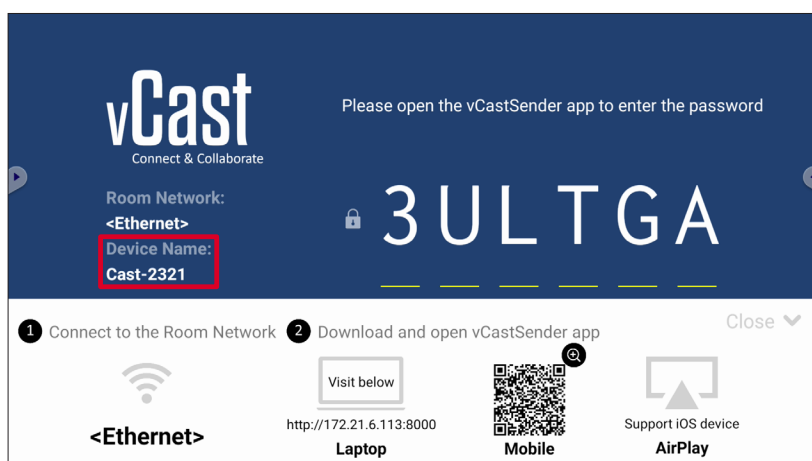

6. Additionally, you can connect to the ViewBoard or by selecting **Scan** then placing the on-screen QR code into the box to automatically connect.

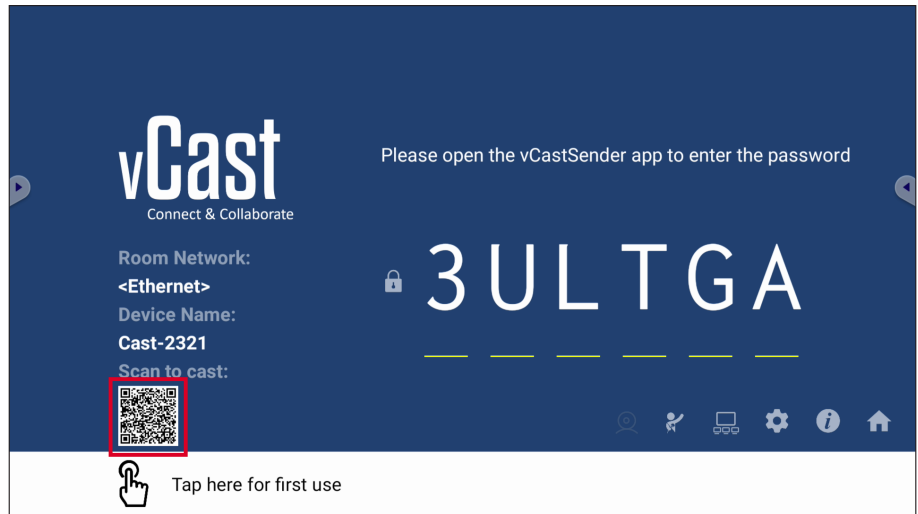
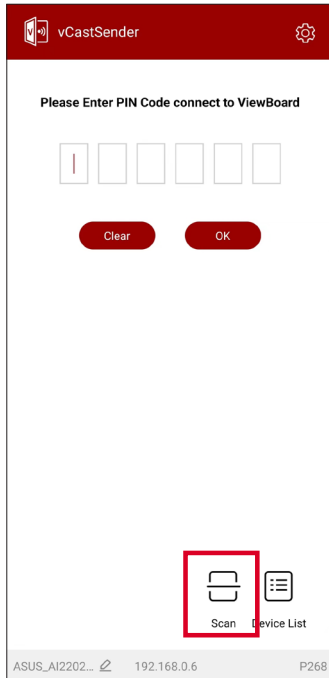

## Casting from Apple iOS Devices

Apple AirPlay® is compatible with vCast for screen mirroring and content streaming under the same subnet environment only. An “AirPlay Password” will be generated on-screen for connection when using AirPlay to cast to a ViewBoard.

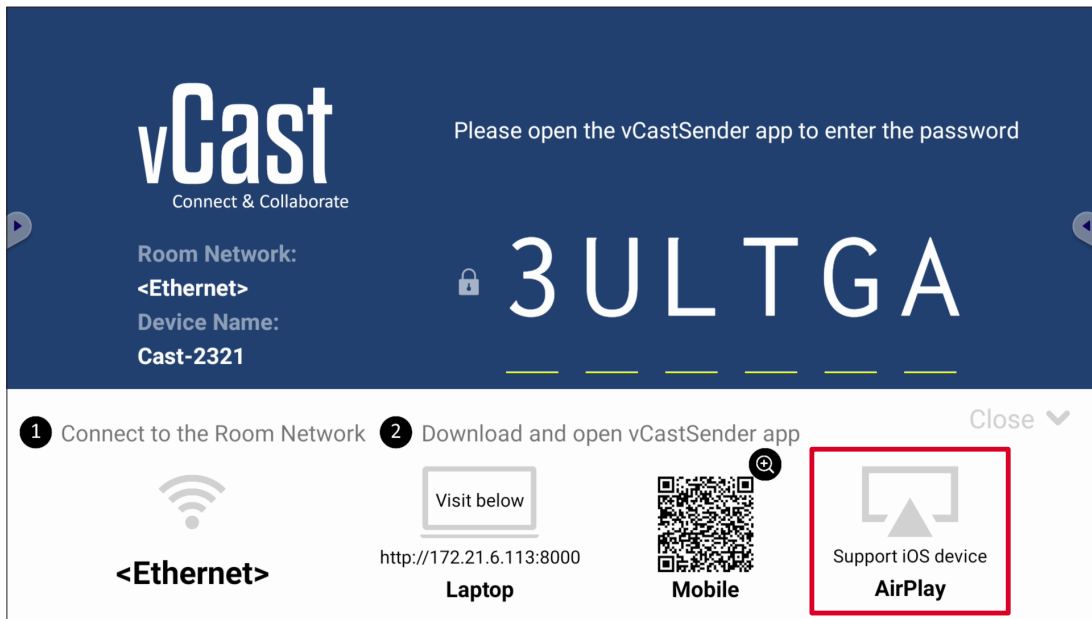

1. Ensure the client device (e.g., iPhone or iPad) is connected to the same network as the ViewBoard.

**NOTE:** The network name can be found under **Room Network**.

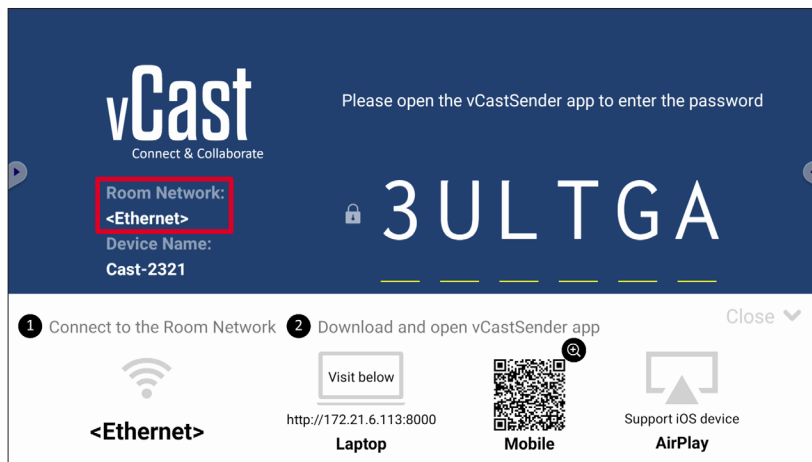

2. On the iOS client device, directly open AirPlay and select the **Device Name** of the ViewBoard to connect.

**NOTE:** The **Device Name** can be found as highlighted below:

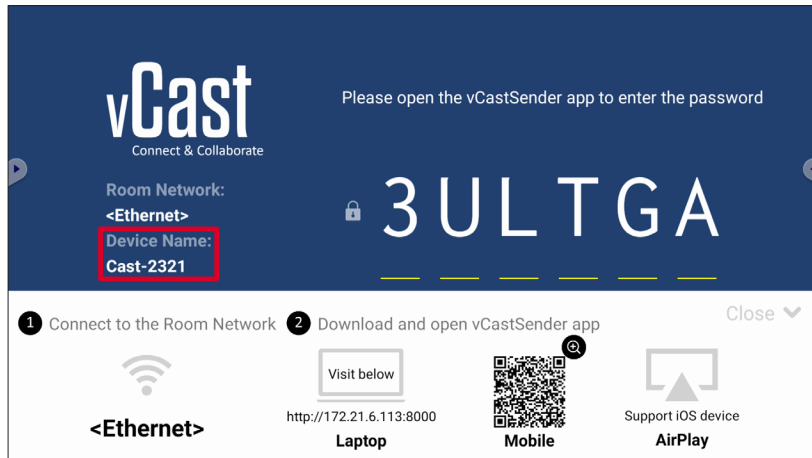

3. Input the generated on-screen **AirPlay Password** on the client device to connect.

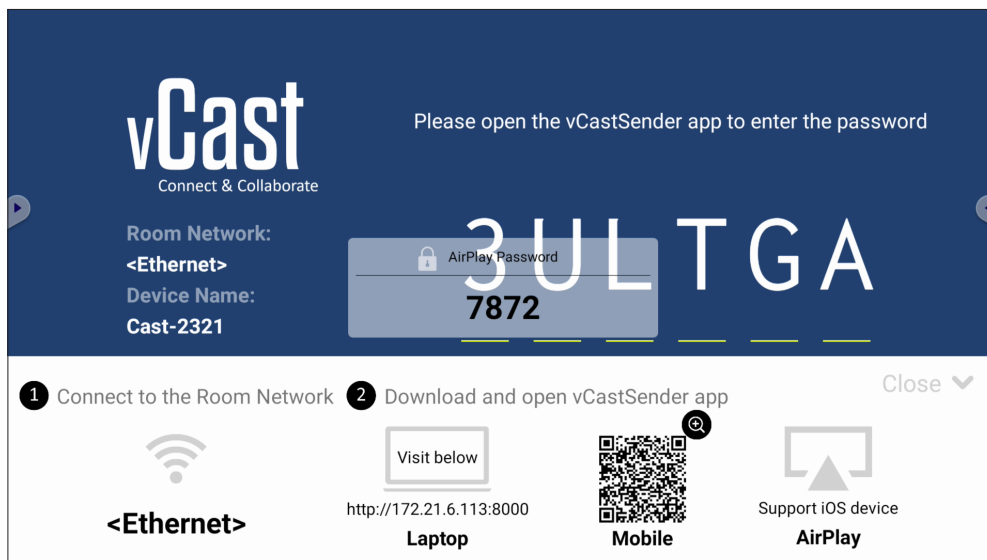

**NOTE:** In a cross subnet environment, please download and connect with the vCastSender iOS application from the Apple App Store.

4. You can also connect to the ViewBoard by selecting **Scan** then placing the on-screen QR code into the box to automatically connect.

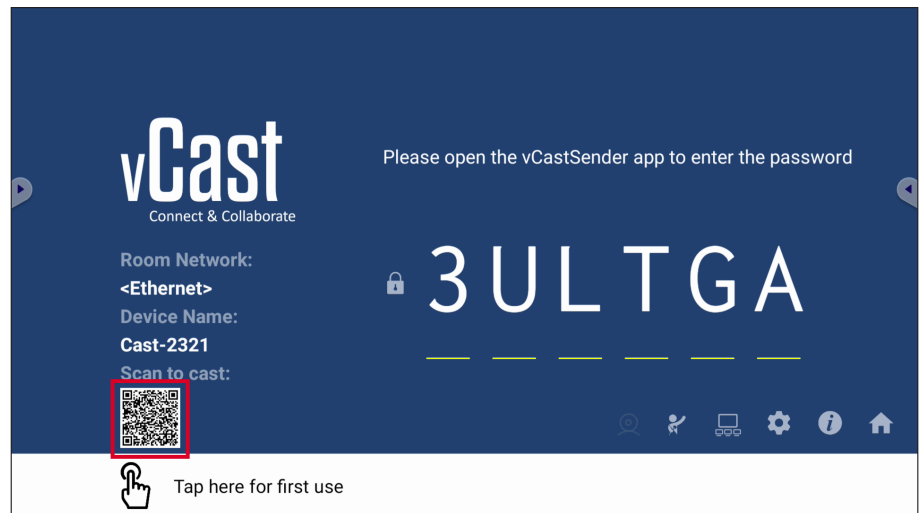
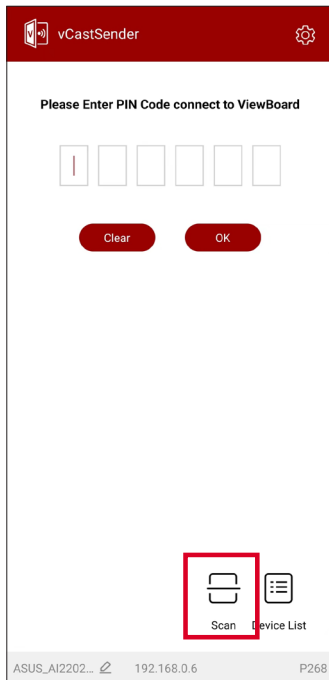

## Connecting to a ViewBoard from a Mobile Device

Once connected, select **Receive**. The ViewBoard will appear on the mobile device with an on-screen toolbar. Users can interact with the ViewBoard with annotations, file sharing, etc.

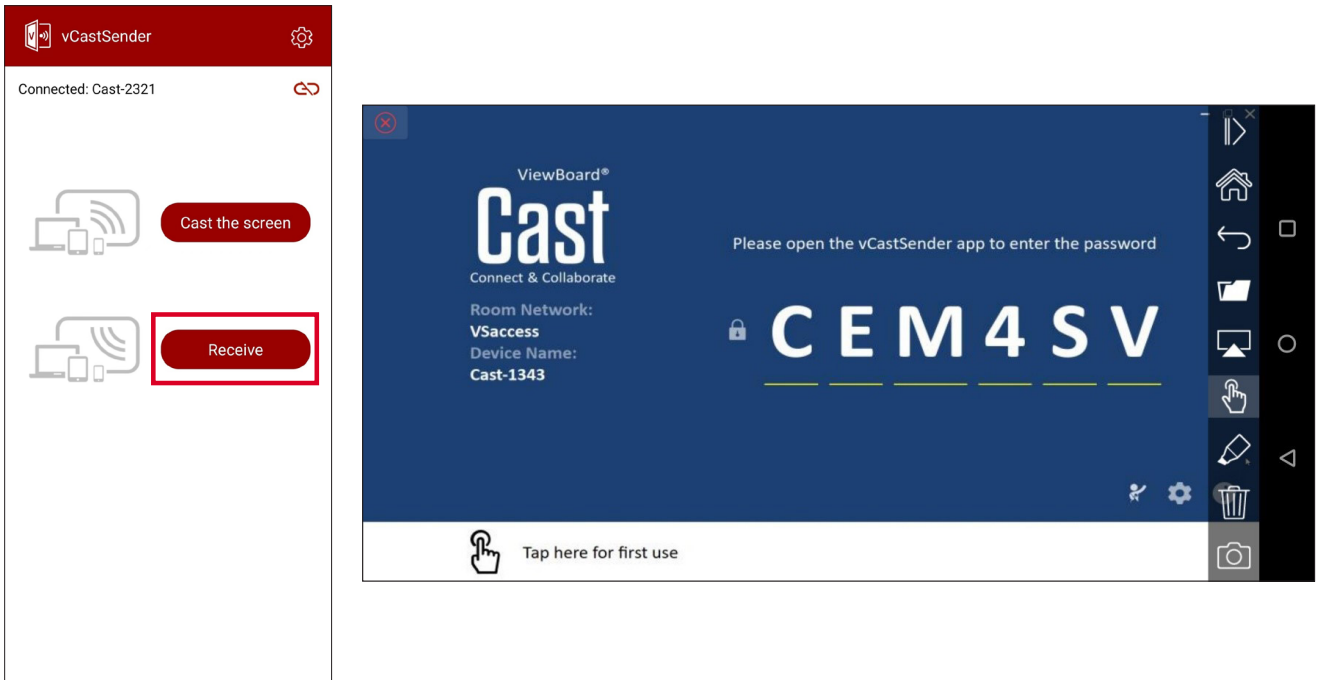

| Item | Description   |
|------|---|
|      | <b>Toggle</b> Hide or display the toolbar.  |
|      | <b>Home</b> Return to the Home interface.   |
|      | <b>Return</b> Return to the previous operation.                                     |
|      | <b>Folder</b> View or open the mobile device's files.                               |
|      | <b>Share</b> Cast the mobile device's screen to the connected ViewBoard or display. |
|      | <b>Touch</b> Remotely control the connected ViewBoard or display.                   |
|      | <b>Annotate</b> Make annotations, and adjust the pen color.                         |
|      | <b>Clear</b> Clear everything on screen.  |
|      | <b>Camera</b> Send camera images to the connected ViewBoard or display.             |

## Casting with Chromecast

vCast supports native Chromecast screen sharing via the Chrome browser casting when the Chromecast feature is enabled.

**NOTE:** Chromecast does not support password protection or multiple-screen casting.

1. Ensure the client device (e.g., laptop) is connected to the same network as the ViewBoard.

**NOTE:** The network name can be found under **Room Network**.

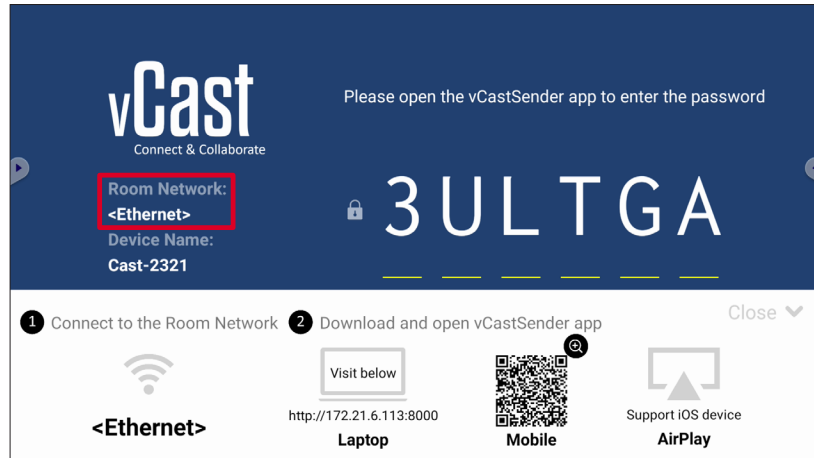

2. Ensure the **Chromecast Enable** checkbox is selected in the vCast settings.

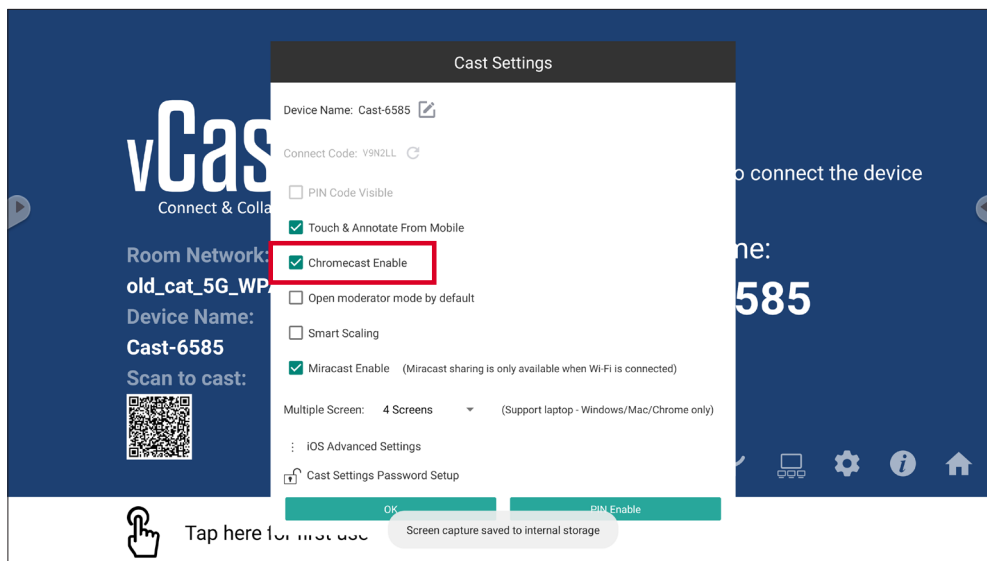

3. In the Chrome browser, go to: **Settings > Save and share > Cast...** > Select the screen to cast to.

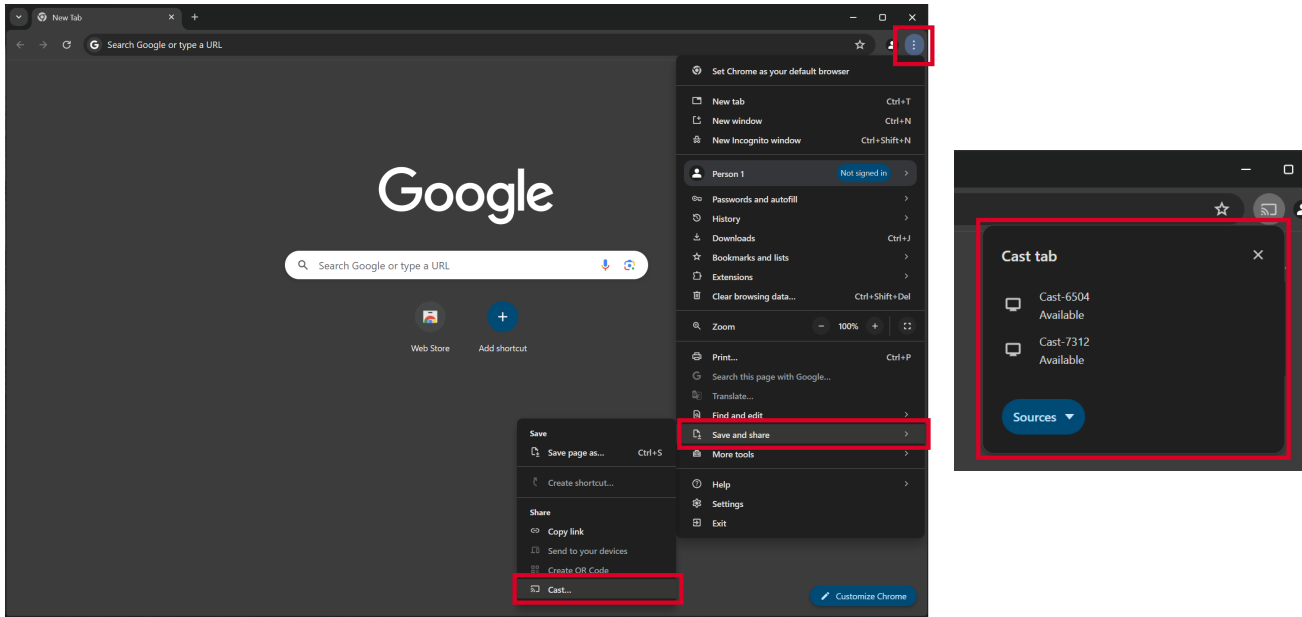

## Casting with Miracast

vCast supports native Miracast to cast content from Windows and Android devices to a ViewBoard when the Miracast feature is enabled.

### NOTE:

- Miracast does not support password protection or multiple-screen casting.
- Miracast sharing is only available over Wi-Fi.
- Miracast will automatically turn off after being idle for one hour.

1. Ensure the client device (e.g., laptop) is connected to the same network as the ViewBoard.

**NOTE:** The network name can be found under **Room Network**.

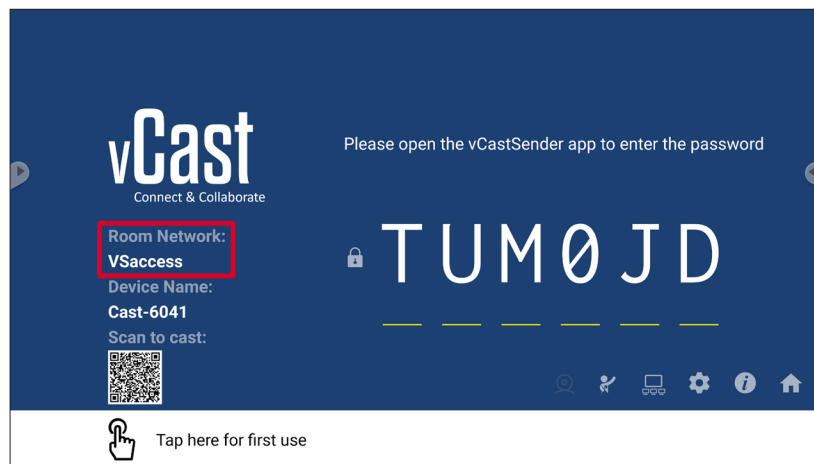

2. Ensure the **Miracast Enable** checkbox is selected in the vCast settings.

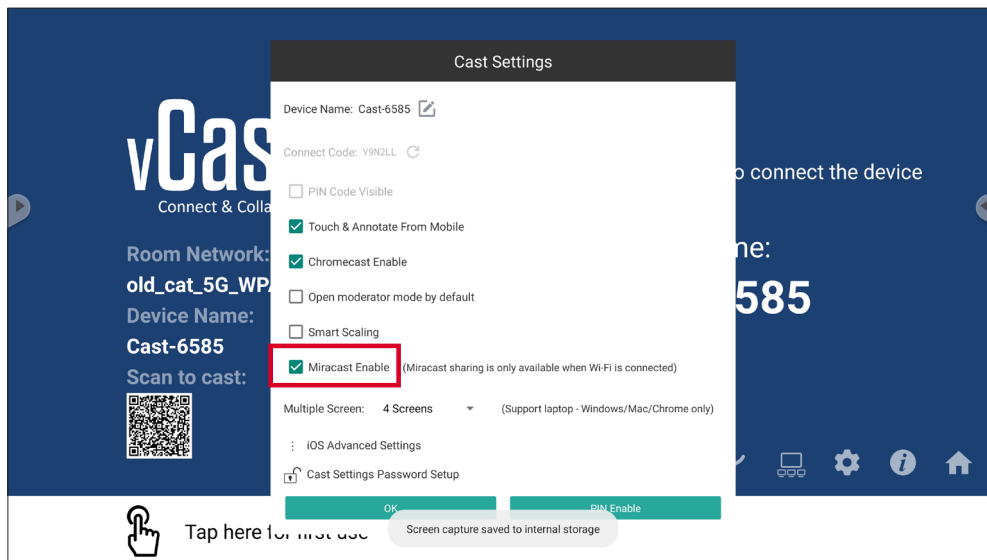

**3.** Please follow the below steps to cast:

For Windows devices:

**1.** On the Windows device, press Win + K and select the display to cast to.

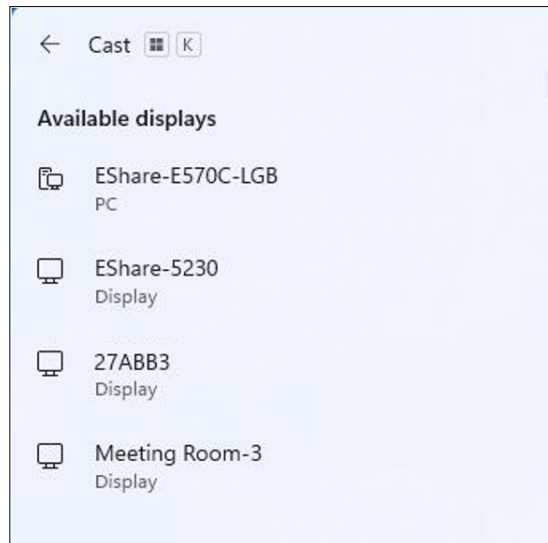

**2.** Select the checkbox “Allow mouse, keyboard, touch, and pen input from the device” to enable the touch feedback feature.

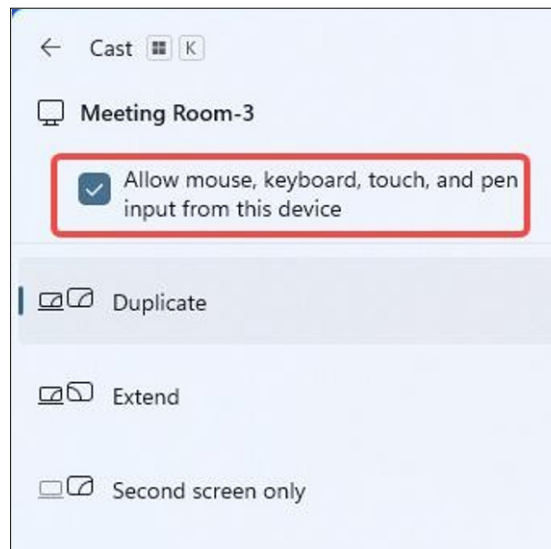

For Android devices:

On the Android device, directly select Cast/Smart View/Wireless Projection then select the display to cast to.

# Other Default Applications

## Browser

Web browser for surfing the Internet.

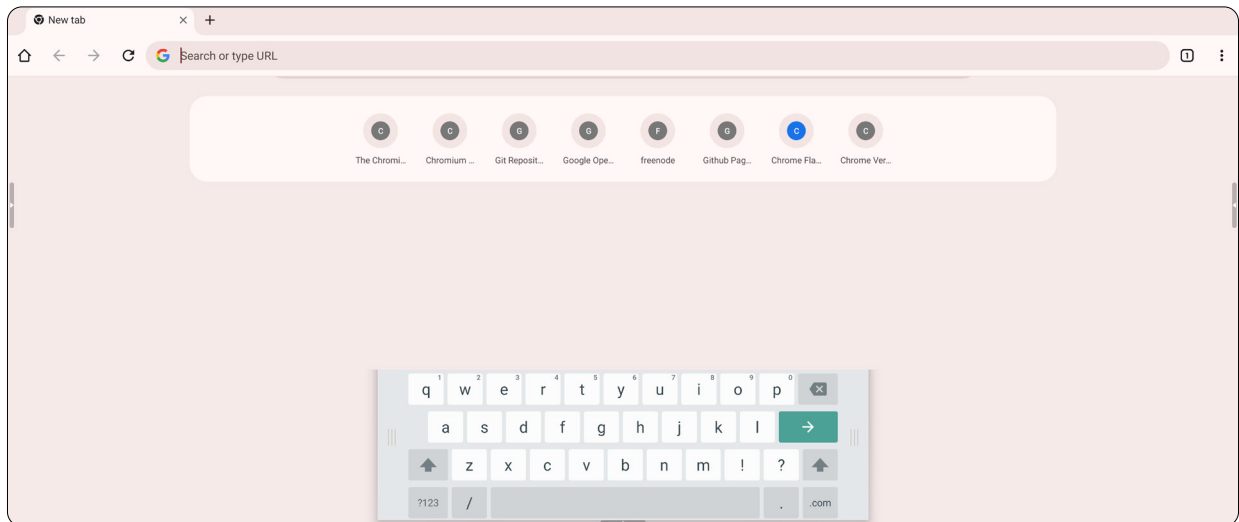

# Finder



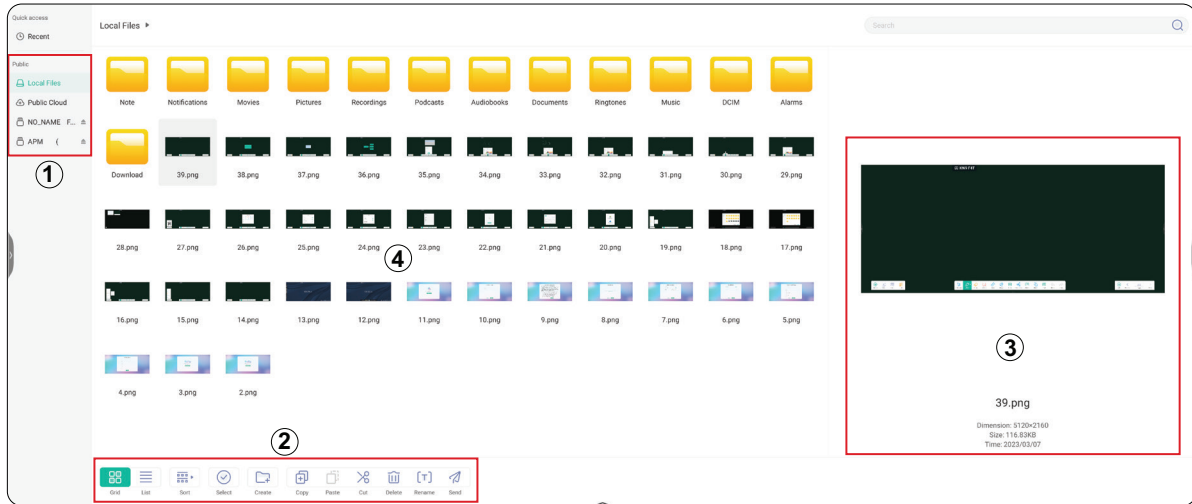







Manage files and folders.



## 1. Storage Device Display

Select the appropriate storage device.

## 2. Icons

|   | Item          | Description                |
|---|---------------|----------------------------|
|  | <b>Grid</b>   | Display files by grid      |
|  | <b>List</b>   | Display files by list      |
|  | <b>Sort</b>   | Sort the files             |
|  | <b>Select</b> | Select a file              |
|  | <b>Create</b> | Create a new folder        |
|  | <b>Copy</b>   | Copy a file                |
|  | <b>Paste</b>  | Paste a copied or cut file |
|  | <b>Cut</b>    | Cut a file                 |
|  | <b>Delete</b> | Delete a file              |
|  | <b>Rename</b> | Rename a file              |
|  | <b>Send</b>   | Share a file               |

## 3. File Information

Preview the file, show the file's name, size, resolution, and creation date.

## 4. Main Display Area

Files are displayed here.

# Office

Create, edit, and view documents, spreadsheets, presentations, and PDFs.

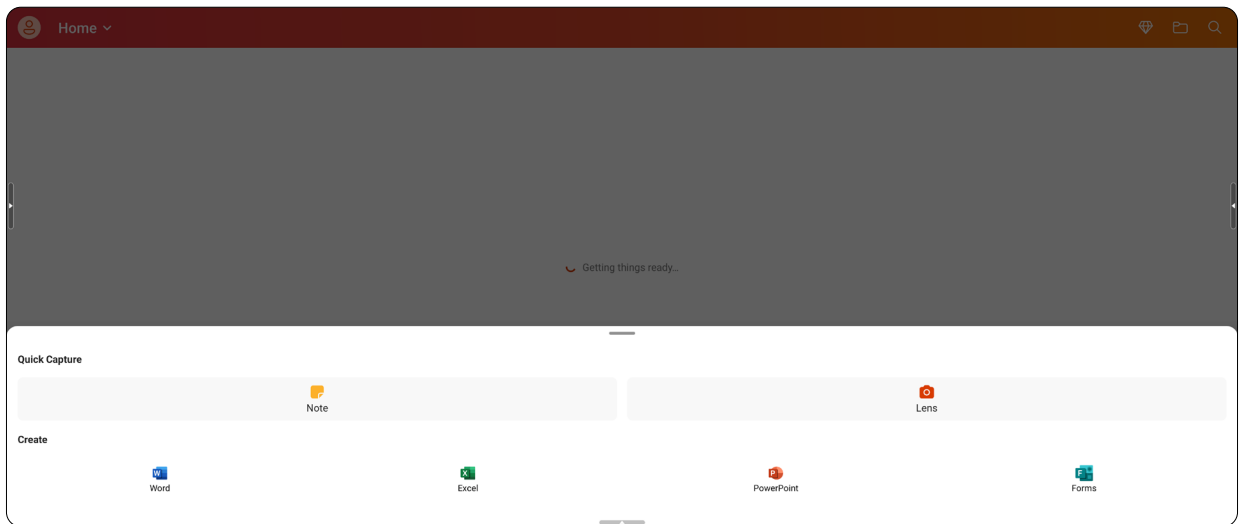
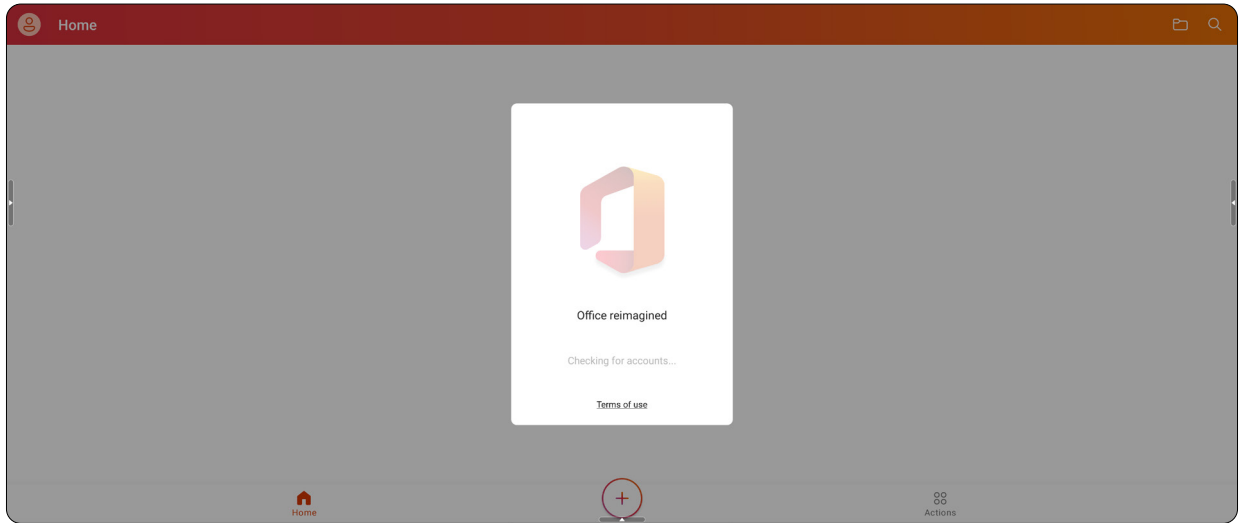

## PIP (Picture-in-Picture)

Split the screen into two parts, a main window and an inset window.

**NOTE:** PIP only works between an Android application (browser, media player, vCast) and an external source.

- To open PIP, select: **All Apps > PIP**.

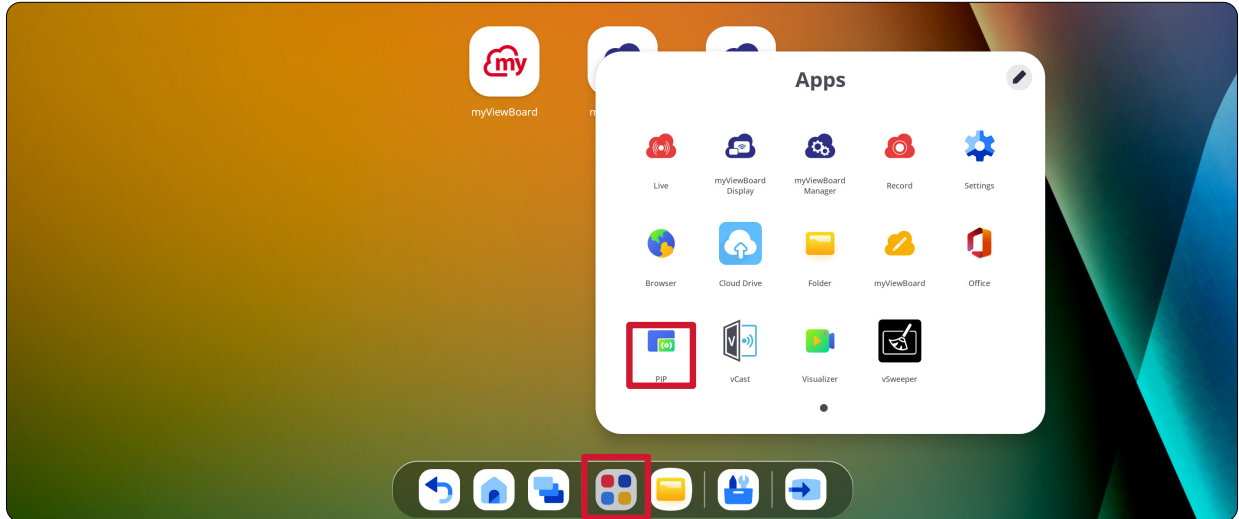

- To adjust the size of the inset window, select **Size**.

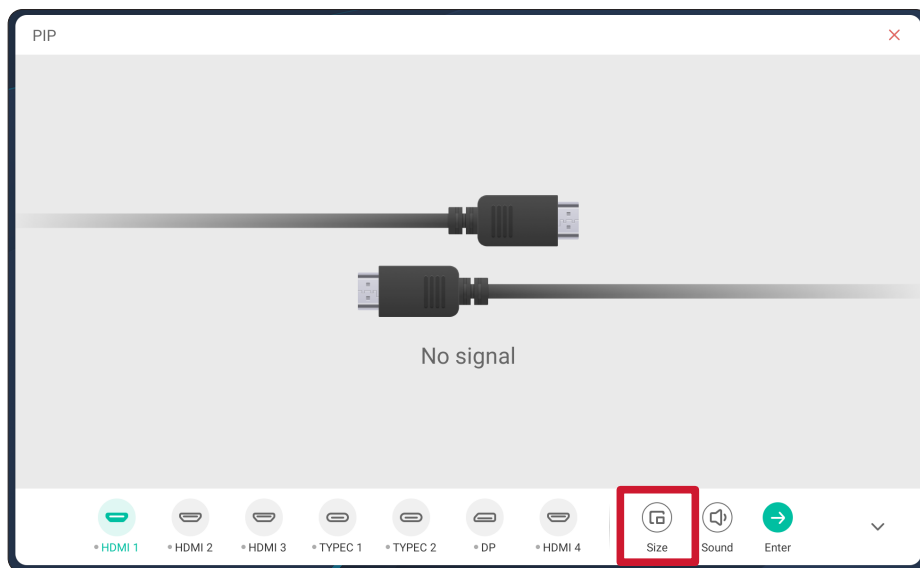

**NOTE:** The toolbar can be hidden by touching the down arrow.

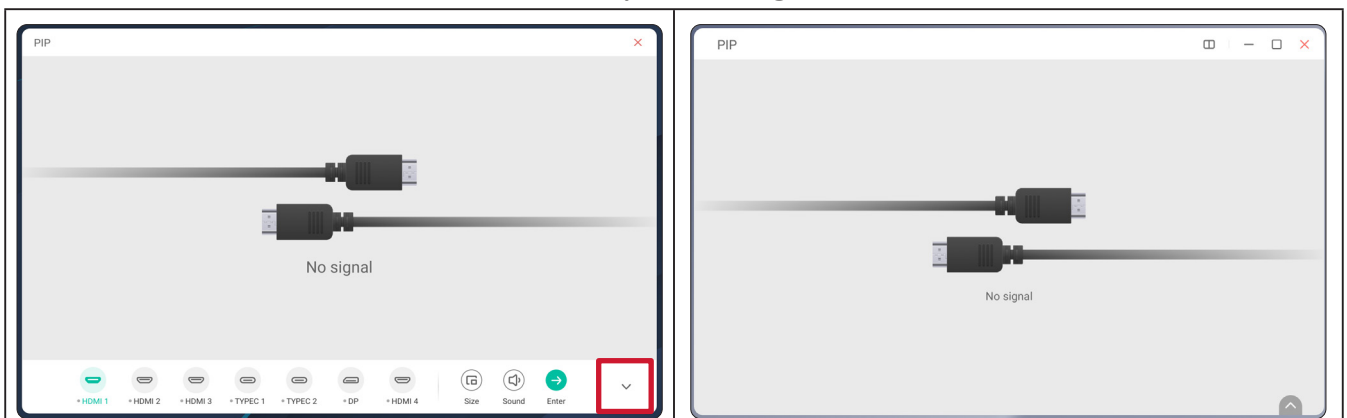

- To change PIP input source select **HDMI 1, HDMI 2, HDMI 3, HDMI 4, Type C 1, Type C 2, or DP.**

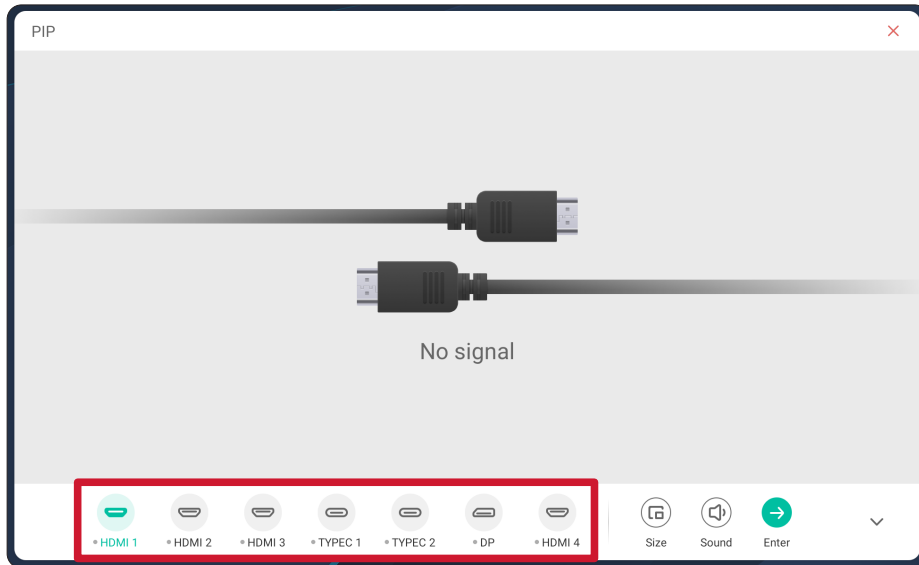

- To control the connected external device's volume, select **Sound.**

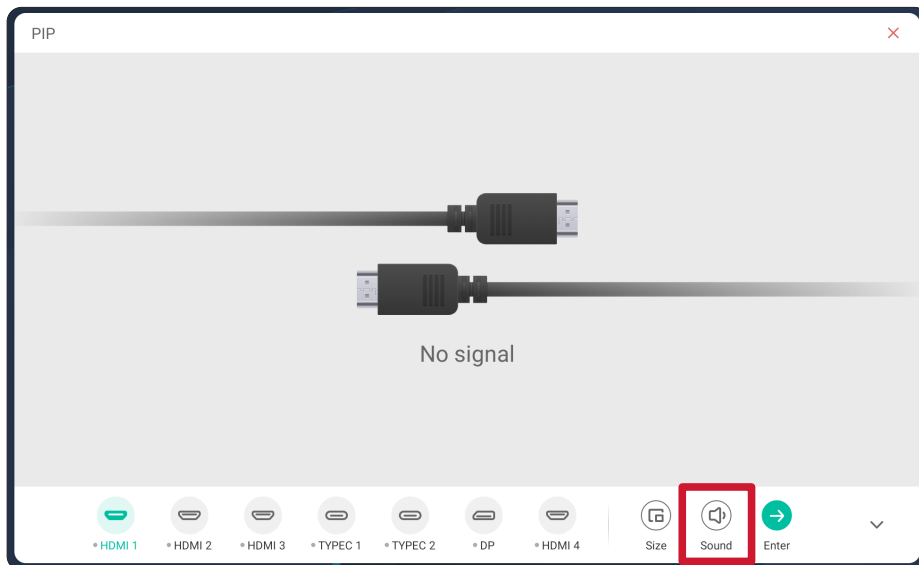

- Select **Enter** to switch to the PIP input source.

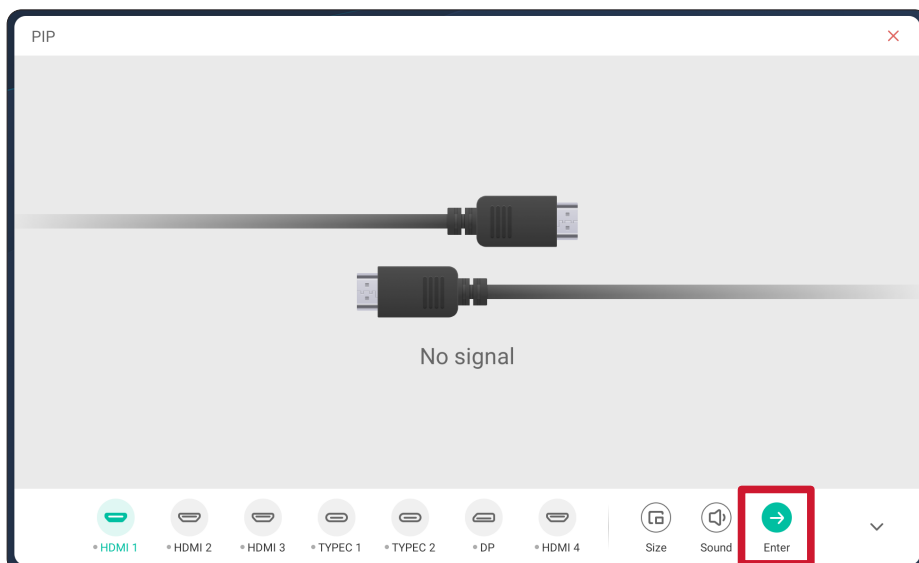

## Visualizer

Display video from a connected camera.

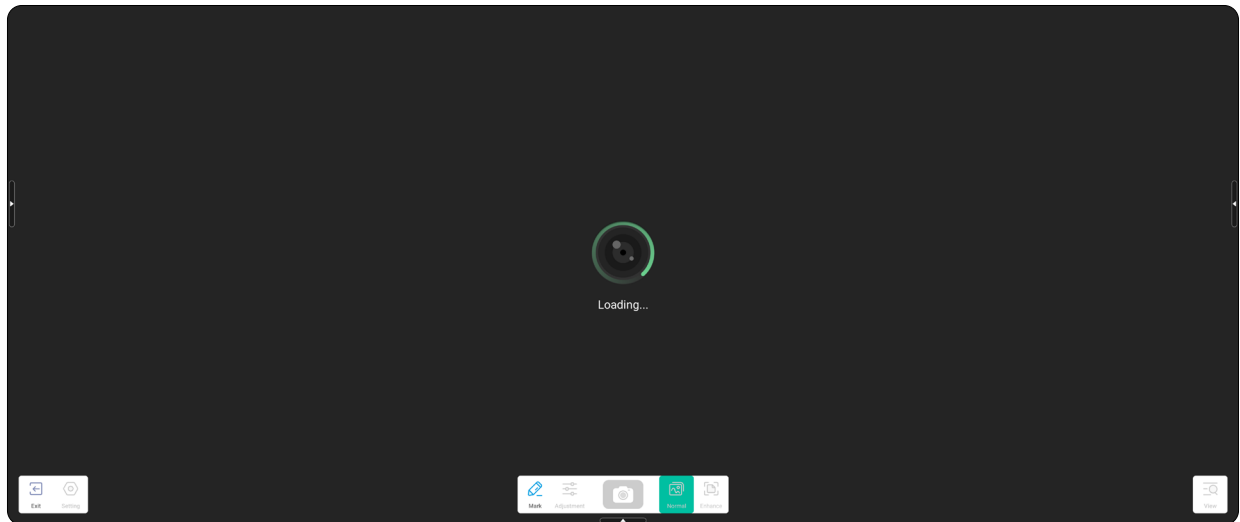

# vSweeper

Clear unnecessary data and unwanted files.

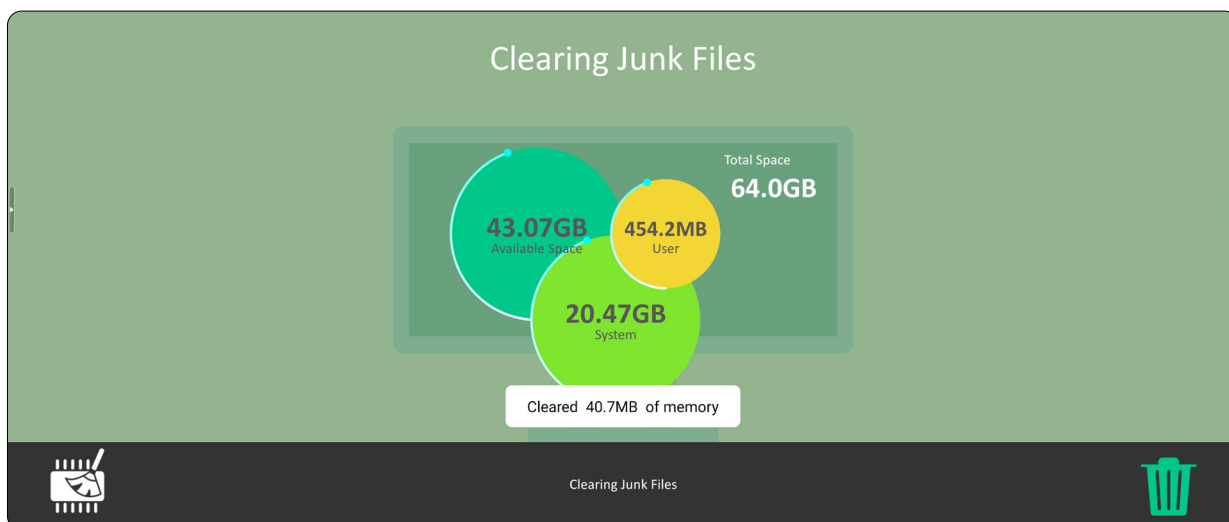
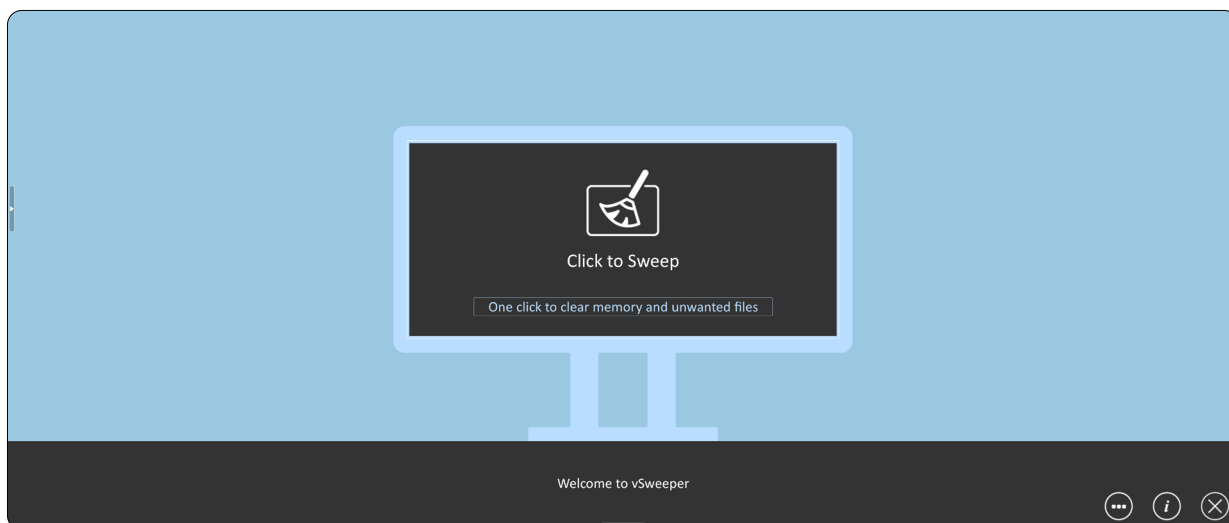

# RS-232 Protocol

This document describes the hardware interface spec and software protocols of RS-232 interface communication between ViewSonic LFD and PC or other control units with RS-232 protocol.

The protocol contains three command sections:

- Set-Function
- Get-Function
- Remote control pass-through mode

**NOTE:** Below, “PC” represents all the control units that can send or receive the RS-232 protocol command.

## Description

### RS-232 Hardware Specification

ViewSonic LFD communication port on the rear side:

1. Connector type: DSUB 9-Pin Male (or 3.5 mm barrel connector)
2. Use of crossover (null modem) cable for connection
3. Pin Assignment:

Female DSUB 9-Pin

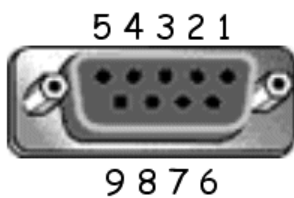

Male DSUB 9-Pin

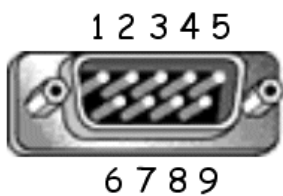

3.5 mm barrel connector (alternative for limited space)



| Pin # | Signal | Remark   |
|-------|--------|--|
| 1     | NC     |  |
| 2     | RXD    | Input to Display                                       |
| 3     | TXD    | Output from Display                                    |
| 4     | NC     |  |
| 5     | GND    |  |
| 6     | NC     |  |
| 7     | NC     |  |
| 8     | NC     |  |
| 9     | NC     | Provide +5V/2A power for external specific dongle *3.0 |
| frame | GND    |  |

| Item   | Signal | Remark              |
|--------|--------|---------------------|
| Tip    | TXD    | Output from Display |
| Ring   | RXD    | Input to Display    |
| Sleeve | GND    |                     |

## LAN Hardware Specification

ViewSonic LFD communication port on the rear side:

1. Connector type: 8P8C RJ45
2. Pin Assignment:

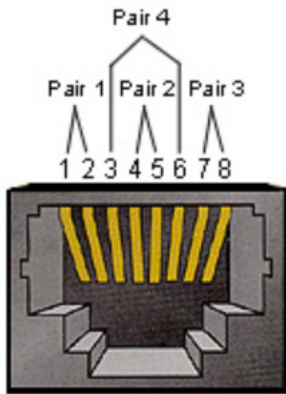

| Pin # | Signal | Remark              |
|-------|--------|---------------------|
| 1     | TX+    | Output from Display |
| 2     | TX-    | Output from Display |
| 3     | RX+    | Input to Display    |
| 4     | BI_D3+ | For 1G case         |
| 5     | BI_D3- | For 1G case         |
| 6     | RX-    | Input to Display    |
| 7     | BI_D4+ | For 1G case         |
| 8     | BI_D4- | For 1G case         |
| frame | GND    |                     |

## RS232 Communication Setting

- Baud Rate Select: 9600bps (fixed)
- Data bits: 8 bits (fixed)
- Parity: None (fixed)
- Stop Bits: 1(fixed)

## LAN Communication Setting

- Type: Ethernet
- Protocol: TCP/IP
- Port: 5000 (fixed)
- Cross subnet: No
- Logon Credentials: No

## Command Message Reference

PC sends to LFD command packet followed by “CR”. Every time PC sends control command to Display, the Display shall respond as follows:

1. If the message is received correctly it will send “+” (02Bh) followed by “CR” (00Dh)
2. If the message is received incorrectly it will send “-” (02Dh) followed by “CR” (00Dh)

# Protocol

## Set-Function Listing

The PC can control the Display for specific actions. The Set-Function command allows you to control the Display behavior at a remote site through the RS-232 port. The Set-Function packet format consists of 9 bytes.

### Set-Function Description:

- Length:** Total Byte of Message excluding "CR"
- LFD ID** Identification for each of Display (01~98; default is 01)  
ID "99" means to apply the set command for all connected displays. Under such circumstances, only ID#1 display has to reply.  
The LFD ID can be set via the OSD menu for each Display.
- Command Type** Identify command type,  
"s" (0x73h): Set Command  
"+" (0x2Bh): Valid command Reply  
"- " (0x2Dh): Invalid command Reply
- Command:** Function command code: One byte ASCII code.
- Value[1~3]:** Three bytes ASCII that defines the value.
- CR** 0x0D

### Set-Function Format

#### Send: (Command Type="s")

| Name        | Length | ID     | Command Type | Command | Value1 | Value2 | Value3 | CR     |
|-------------|--------|--------|--------------|---------|--------|--------|--------|--------|
| Byte Count  | 1 Byte | 2 Byte | 1 Byte       | 1 Byte  | 1 Byte | 1 Byte | 1 Byte | 1 Byte |
| Bytes order | 1      | 2~3    | 4            | 5       | 6      | 7      | 8      | 9      |

#### Reply: (Command Type="+" or "-")

| Name        | Length | ID     | Command Type | CR     |
|-------------|--------|--------|--------------|--------|
| Byte Count  | 1 Byte | 2 Byte | 1 Byte       | 1 Byte |
| Bytes order | 1      | 2~3    | 4            | 5      |

**NOTE:** When PC applies command to all displays (ID=99), only the #1 set needs to reply by the name of ID=1.

**Example 1: Set Brightness as 76 for Display (#02) and this command is valid**

**Send (Hex Format)**

| Name | Length | ID           | Command Type | Command | Value1 | Value2 | Value3 | CR   |
|------|--------|--------------|--------------|---------|--------|--------|--------|------|
| Hex  | 0x38   | 0x30<br>0x32 | 0x73         | 0x24    | 0x30   | 0x37   | 0x36   | 0x0D |

**Reply (Hex Format)**

| Name | Length | ID           | Command Type | CR   |
|------|--------|--------------|--------------|------|
| Hex  | 0x34   | 0x30<br>0x32 | 0x2B         | 0x0D |

**Example 2: Set Brightness as 75 for Display (#02) and this command is NOT valid**

**Send (Hex Format)**

| Name | Length | ID           | Command Type | Command | Value1 | Value2 | Value3 | CR   |
|------|--------|--------------|--------------|---------|--------|--------|--------|------|
| Hex  | 0x38   | 0x30<br>0x32 | 0x73         | 0x24    | 0x30   | 0x37   | 0x35   | 0x0D |

**Reply (Hex Format)**

| Name | Length | ID           | Command Type | CR   |
|------|--------|--------------|--------------|------|
| Hex  | 0x34   | 0x30<br>0x32 | 0x2D         | 0x0D |

## Set-Function Table

### A. Basic Function

| Set Function            | Length | ID | Command      |                            | Value Range | Comments  |   |
|-------------------------|--------|----|--------------|----------------------------|-------------|---|---|
|                         |        |    | Type (ASCII) | Code (ASCII)<br>Code (Hex) |             |   |   |
| Power on/ off (standby) | 8      |    | s            | !                          | 21          | 000: STBY<br>001: ON  | 1. The Power-on via LAN control may work only under specific mode. To see display UG for details. *3.1.1<br>2. "WOL by MAC address" may available as alternative.*3.2.1 |
| Input Select            | 8      |    | s            | "                          | 22          | 000: TV<br>001: AV<br>002: S-Video<br>003: YPbPr<br>004: HDMI1<br>014: HDMI2<br>024: HDMI3<br>034: HDMI4<br><br>005: DVI<br>006: VGA1<br>016: VGA2<br>026: VGA3<br><br>007: Slot-in PC (OPS/SDM)/HDBT<br><br>008: Internal memory<br>009: DP<br><br>00A: Embedded/ Main (Android) | 1. No need for USB<br>2. For the case of two more same sources, the 2nd digital is used to indicate the extension.<br>3. The HEX of 00A is 30 30 41.                    |
| Brightness              | 8      |    | s            | \$                         | 24          | 000 ~ 100<br>900: Bright down (-1)<br>901: Bright up (+1)<br>*3.1.1   |   |
| Backlight*3.2.0         | 8      |    | A            | B                          | 42          | 000 ~ 100   | 1. For Android platform whose main mode is controlled by backlight and the other sources are controlled by brightness.<br>2. Derived from Color calibration.<br>*3.2.0  |
| Power lock              | 8      |    | s            | 4                          | 34          | 000: Unlock<br>001: Lock  | *See note in details  |
| Volume                  | 8      |    | s            | 5                          | 35          | 000 ~ 100<br>900: Volume down(-1)<br>901:Volume up(+1)  |   |
| Mute                    | 8      |    | s            | 6                          | 36          | 000: OFF<br>001: ON (mute)  |   |

|                 |   |  |   |   |    |  |  |
|-----------------|---|--|---|---|----|--|--|
| Button lock     | 8 |  | s | 8 | 38 | 000: Unlock<br>001: Lock   | *See note in details   |
| Menu lock       | 8 |  | s | > | 3E | 000: Unlock<br>001: Lock   | *See note in details   |
| Number *3.1.1   | 8 |  | s | @ | 40 | 000~009  |  |
| Key Pad *3.1.1  | 8 |  | s | A | 41 | 000: UP<br>001: DOWN<br>002: LEFT<br>003: RIGHT<br>004: ENTER<br>005: INPUT<br>006: MENU/(EXIT)<br>007: EXIT |  |
| Remote Control  | 8 |  | s | B | 42 | 000: Disable<br>001: Enable<br>002: Pass through   | <b>Disable:</b> RCU will be no function<br><b>Enabled:</b> RCU controls normally<br><b>Pass through:</b> Display will bypass the RC code to connected device via the RS232 port, but not react itself. |
| Restore default | 8 |  | s | ~ | 7E | 000  | Recover to factory setting   |

**NOTE:**

**1. Behavior at Lock Modes**

| Lock Mode              | Behavior  |
|------------------------|---|
| Button Lock            | <ol style="list-style-type: none"> <li>1. Lock all buttons on the front panel and RCU, except for "Power"</li> <li>2. All the SET functions should be workable via RS-232, even the ones with according hot key in RCU like Mute,...etc.</li> </ol>   |
| MENU Lock              | <ol style="list-style-type: none"> <li>1. Lock "MENU" key of front panel and RCU</li> <li>2. The Factory and Hospitality modes should not be blocked for the model using MENU-combined key to enter these two modes. Alternative approach will be indicated separately if any limitation by model.</li> </ol>   |
| POWER Lock             | <ol style="list-style-type: none"> <li>1. Lock "POWER" key on the front and RCU.</li> <li>2. The SET_POWER on/off should be workable via RS-232, but does not mean the POWER lock will be released under this case.</li> <li>3. Can not be unlocked by reset in OSD setting</li> <li>4. Will auto AC power-on in power-lock</li> <li>5. Under power-lock, the set will not enter power saving when no PC signal and neither not turn off when no other video signals after 15 minutes.</li> </ol> |
| Remote control disable | Lock the RCU keys, but keep the front panel buttons workable.   |

**2. Wake-on-LAN by MAC address as alternative for SET Power on**

(Length=126 Bytes)

| 6 Bytes        | 6 Bytes (#1) | 6 Bytes (#2) | ... | 6 Bytes (#16) | 24 Bytes       |
|----------------|--------------|--------------|-----|---------------|----------------|
| 0xFF FF ... FF | MAC address  | MAC address  | ... | MAC address   | 0x00 00 ... 00 |

## B. Optional Function

| Set Function     | Length | ID | Command      |                            | Value Range<br>(Three ASCII bytes) | Comments   |   |
|------------------|--------|----|--------------|----------------------------|------------------------------------|--|---|
|                  |        |    | Type (ASCII) | Code (ASCII)<br>Code (Hex) |                                    |  |   |
| Contrast         | 8      |    | s            | #                          | 23                                 | 000 ~ 100  |   |
| Sharpness        | 8      |    | s            | %                          | 25                                 | 000 ~ 100  |   |
| Color            | 8      |    | s            | &                          | 26                                 | 000 ~ 100  |   |
| Tint             | 8      |    | s            | '                          | 27                                 | 000 ~ 100  |   |
| Backlight On_Off | 8      |    | s            | (                          | 29                                 | 000: Off<br>001: On  |   |
| Color mode       | 8      |    | s            | )                          | 29                                 | 000: Normal<br>001: Warm<br>002: Cold<br>003: Personal   |   |
| Surround sound   | 8      |    | s            | -                          | 2D                                 | 000: OFF<br>001: ON  |   |
| Bass             | 8      |    | s            | .                          | 2E                                 | 000 ~ 100  |   |
| Treble           | 8      |    | s            | /                          | 2F                                 | 000 ~ 100  |   |
| Balance          | 8      |    | s            | 0                          | 30                                 | 000 ~ 100  | 050 is central  |
| Picture Size     | 8      |    | s            | 1                          | 31                                 | 000: FULL (16:9)<br>001: NORMAL (4:3)<br>002: REAL (1:1)<br>*3.1.0   |   |
| OSD language     | 8      |    | s            | 2                          | 32                                 | 000: English<br>001: French<br>002: Spanish  | Could be extended for more supported languages by model |
| PIP-Mode         | 8      |    | s            | 9                          | 39                                 | 000: OFF<br>001: PIP(POP)<br>002: PBP  |   |
| PIP-Sound select | 8      |    | s            | :                          | 3A                                 | 000: Main<br>001: Sub  |   |
| PIP-Position     | 8      |    | s            | ;                          | 3B                                 | 000: Up<br>001: Down<br>002: Left<br>003: Right  |   |
| PIP-Input        | 8      |    | s            | 7                          | 37 *2.9                            | 000: TV<br>001: AV<br>002: S-Video<br>003: YPbPr<br>004: HDMI1<br>014: HDMI2<br>024: HDMI3<br>034: HDMI4<br><br>005: DVI<br>006: VGA1<br>016: VGA2<br>026: VGA3<br><br>007: Slot-in PC (OPS/SDM)/HDBT<br>008: Internal memory<br>009: DP<br><br>00A: Embedded/Main (Android) | Value range is same as SET-Input select                 |

|                        |   |  |   |   |    |                          |  |
|------------------------|---|--|---|---|----|--------------------------|--|
| Tiling-Mode            | 8 |  | s | P | 50 | 000: OFF<br>001: ON      | (for video wall)   |
| Tiling-Compensation    | 8 |  | s | Q | 51 | 000: OFF<br>001: ON      | (for video wall)<br>Bezel width compensation                                       |
| Tiling-H by V Monitors | 8 |  | s | R | 52 | 01x~09x: H<br>0x1~0x9: V | (for video wall)<br>1. 2nd digital for H monitors<br>2. 3rd digital for V monitors |
| Tiling-Position        | 8 |  | s | S | 53 | 001~025                  | (for Video wall)<br>Copy the screen of Position# to identified display             |
| Date: Year             | 8 |  | s | V | 56 | Y17~Y99                  | Last 2 digits<br>(20)17~(20)99   |
| Date: Month            | 8 |  | s | V | 56 | M01~M12                  | 2 digits   |
| Date: Day              | 8 |  | s | V | 56 | D01~D31                  | 2 digits   |
| Time: Hour             | 8 |  | s | W | 57 | H00~H23                  | 24-hr format. 2 digits.  |
| Time: Min              | 8 |  | s | W | 57 | M00~M59                  | 2 digits   |
| Time: Sec              | 8 |  | s | W | 57 | S00~S59                  | 2 digits   |

**NOTE:**

**1. Tiling definition of H Monitors, V Monitors, and Position**

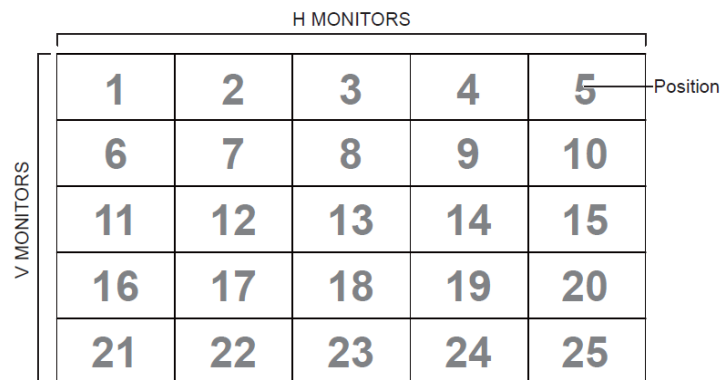

**2. Set Date example**

Date: 2017-3/15

Send: 0x 38 30 31 73 56 59 31 37 0D ("Y17")

Send: 0x 38 30 31 73 56 4D 30 33 0D ("M03")

Send: 0x 38 30 31 73 56 44 31 35 0D ("D15")

**3. Set Time example**

Time: 16:27:59

Send: 0x 38 30 31 73 57 48 31 36 0D ("H16")

Send: 0x 38 30 31 73 57 4D 32 37 0D ("M27")

Send: 0x 38 30 31 73 57 53 35 39 0D ("S59")

## Get-Function Listing

The PC can interrogate the LFD for specific information. The Get-Function packet format consists of 9 bytes which is similar to the Set-Function packet structure. Note that the “Value” byte is always = 000.

### Get-Function Description:

- Length:** Total Byte of Message excluding “CR”.
- TV/DS ID** Identification for each of TV/DS (01~98; default is 01).
- Command Type** Identify command type,  
 “g” (0x67h) : Get Command  
 “r” (0x72h) : Valid command Reply  
 “-” (0x2Dh) : Invalid command Reply
- Command:** Function command code: One byte ASCII code.
- Value[1~3]:** Three bytes ASCII that defines the value.
- CR** 0x0D

### Get-Function Format

#### Send: (Command Type=“g”)

| Name        | Length | ID     | Command Type | Command | Value1 | Value2 | Value3 | CR     |
|-------------|--------|--------|--------------|---------|--------|--------|--------|--------|
| Byte Count  | 1 Byte | 2 Byte | 1 Byte       | 1 Byte  | 1 Byte | 1 Byte | 1 Byte | 1 Byte |
| Bytes order | 1      | 2~3    | 4            | 5       | 6      | 7      | 8      | 9      |

#### Reply: (Command Type=“r” or “-”)

*If the Command is valid, Command Type = “r”*

| Name        | Length | ID     | Command Type | Command | Value1 | Value2 | Value3 | CR     |
|-------------|--------|--------|--------------|---------|--------|--------|--------|--------|
| Byte Count  | 1 Byte | 2 Byte | 1 Byte       | 1 Byte  | 1 Byte | 1 Byte | 1 Byte | 1 Byte |
| Bytes order | 1      | 2~3    | 4            | 5       | 6      | 7      | 8      | 9      |

**If the Command is NOT valid, Command Type = “-”**

| Name        | Length | ID     | Command Type | CR     |
|-------------|--------|--------|--------------|--------|
| Byte Count  | 1 Byte | 2 Byte | 1 Byte       | 1 Byte |
| Bytes order | 1      | 2~3    | 4            | 5      |

**Example 1: Get Brightness from TV-05 and this command is valid. The Brightness value is 67.**

**Send (Hex Format)**

| Name | Length | ID           | Command Type | Command | Value1 | Value2 | Value3 | CR   |
|------|--------|--------------|--------------|---------|--------|--------|--------|------|
| Hex  | 0x38   | 0x30<br>0x35 | 0x67         | 0x62    | 0x30   | 0x30   | 0x30   | 0x0D |

**Reply (Hex Format)**

| Name | Length | ID           | Command Type | Command | Value1 | Value2 | Value3 | CR   |
|------|--------|--------------|--------------|---------|--------|--------|--------|------|
| Hex  | 0x38   | 0x30<br>0x35 | 0x72         | 0x62    | 0x30   | 0x36   | 0x37   | 0x0D |

**Example 2: Get Color from Display (#05), but the Color command is not supported by this model.**

**Send (Hex Format)**

| Name | Length | ID           | Command Type | Command | Value1 | Value2 | Value3 | CR   |
|------|--------|--------------|--------------|---------|--------|--------|--------|------|
| Hex  | 0x38   | 0x30<br>0x35 | 0x67         | 0x26    | 0x30   | 0x30   | 0x30   | 0x0D |

**Reply (Hex Format)**

| Name | Length | ID           | Command Type | CR   |
|------|--------|--------------|--------------|------|
| Hex  | 0x34   | 0x30<br>0x35 | 0x2D         | 0x0D |

# Get-Function Table

## A. Basic Function

| Get Function                         | Length | ID | Command      |                            | Response Range<br>(Three ASCII bytes)                | Comments   |
|--------------------------------------|--------|----|--------------|----------------------------|--|--|
|                                      |        |    | Type (ASCII) | Code (ASCII)<br>Code (Hex) |  |  |
| Get-Brightness                       | 8      |    | g            | b<br>62                    | 000 ~ 100  |  |
| Get-Backlight <sup>*3.2.0</sup>      | 8      |    | a            | B<br>42                    | 000 ~ 100  | 1. For Android platform whose main mode is controlled by backlight and the other sources are controlled by brightness.<br>2. Derived from Color calibration.<br><sup>*3.2.0</sup>                              |
| Get-Volume                           | 8      |    | g            | f<br>66                    | 000 ~ 100  |  |
| Get-Mute                             | 8      |    | g            | g<br>67                    | 000: Off<br>001: On (muted)                          |  |
| Get-Input select                     | 8      |    | g            | j<br>6A                    | 000~<br>100~   | 1. 1st digit for signal detection: 0 means "no signal"; 1 means "signal detected"<br>2. 2nd & 3rd digit: See Set-function table  |
| Get-Power status: ON/ STBY           | 8      |    | g            | l<br>6C                    | 001: ON<br>000: STBY                                 |  |
| Get-Remote control                   | S      |    | g            | n<br>6E                    | 000: Disable<br>001: Enable<br>002: Pass through     | Get RCU mode status  |
| Get-Power lock                       | 8      |    | g            | o<br>6F                    | 000: Unlock<br>001: Lock                             |  |
| Get-Button lock                      | 8      |    | g            | p<br>70                    | 000: Unlock<br>001: Lock                             |  |
| Get-Menu lock                        | 8      |    | g            | l<br>6C                    | 000: Unlock<br>001: Lock                             |  |
| Get-ACK                              | 8      |    | g            | z<br>7A                    | 000  | This command is used to test the communication link  |
| Get-Thermal                          | 8      |    | g            | 0<br>30                    | 000~100:<br>0~+100 deg C<br>-01~-99:<br>-1~-99 deg C |  |
| Get-Operation time <sup>*3.2.0</sup> | 8      |    | g            | 1<br>31                    | 000  | 1. Accumulated hours in 6-digit integer (000,001~999,999) <sup>*3.2.0</sup><br>2. Can not be reset when FW update and Factory initiation <sup>*3.2.2</sup><br>3. Reply in new 32-byte format <sup>*3.2.0</sup> |
| Get-Device name                      | 8      |    | g            | 4<br>34                    | 000  | Reply in new 32-byte format <sup>*3.2.0</sup>  |

|                          |   |  |   |   |    |     |   |
|--------------------------|---|--|---|---|----|-----|---|
| Get-MAC address          | 8 |  | g | 5 | 35 | 000 | (for the model with LAN)<br>Reply in new 32-byte format*3.2.0 |
| Get-IP address *3.2.0    | 8 |  | g | 6 | 36 | 000 | (for the model with LAN)<br>Reply in new 32-byte format*3.2.0 |
| Get-Serial number *3.2.0 | 8 |  | g | 7 | 37 | 000 | Reply in new 32-byte format *3.2.0                            |
| Get-FW version *3.2.0    | 8 |  | g | 8 | 38 | 000 | Reply in new 32-byte format *3.2.0                            |

**NOTE:**

**1. Get Operation Hour example**

Assumed the accumulated operation hour is 123,456 hrs

Send: 0x 38 30 31 67 31 30 30 30 0D (Get Operation hour)

Reply: 0x 32 30 31 72 31 31 32 33 34 35 36 00 00 ... 00 00 0D

**2. Get Device Name example**

Assumed the device name is CDE-5500

Send: 0x 38 30 31 67 34 30 30 30 0D (Get Device Name)

Reply: 0x 32 30 31 72 34 43 44 45 2D 35 35 30 30 00 00 ... 00 00 0D

Assumed the device name is "NMP-302#1"

Send: 0x 38 30 31 67 34 30 30 30 0D (Get Device Name)

Reply: 0x 32 30 31 72 34 4E 4D 50 2D 33 30 32 23 31 00 00 ...00 00 0D

**3. Get MAC address example**

Assumed the MAC address is 00:11:22:aa:bb:cc

Send: 0x 38 30 31 67 35 30 30 30 0D (Get MAC add)

Reply: 0x 32 30 31 72 35 30 30 31 31 32 32 61 61 62 62 63 63 00 00...00 00 0D

**4. Get IP address example**

Assumed the IP address is 192.168.100.2

Send: 0x 38 30 31 67 36 30 30 30 0D (Get IP address)

Reply: 0x 32 30 31 72 36 31 39 32 2E 31 36 38 2E 31 30 30 2E 32 00 00...00 00 0D

**5. Get Serial number example**

Assumed the Serial number is ABC180212345

Send: 0x 38 30 31 67 37 30 30 30 0D (Get Serial number)

Reply: 0x 32 30 31 72 37 41 42 43 31 38 30 32 31 32 33 34 35 00 00...00 00 0D

## 6. Get FW version example

Assumed the FW version is 3.02.001

Send: 0x 38 30 31 67 38 30 30 30 0D (Get FW version)

Reply: 0x 32 30 31 72 38 33 2E 30 32 2E 30 30 31 00 00...00 00 0D

## B. Optional Function

| Get Function               | Length | ID | Command      |                           | Response Range                             | Comments   |
|----------------------------|--------|----|--------------|---------------------------|--|--|
|                            |        |    | Type (ASCII) | Code (ASCII) / Code (Hex) |  |  |
| Get-Contrast               | 8      |    | g            | a / 61                    | 000 ~ 100                                  |  |
| Get-Sharpness              | 8      |    | g            | c / 63                    | 000 ~ 100                                  |  |
| Get-Color                  | 8      |    | g            | d / 64                    | 000 ~ 100                                  |  |
| Get-Tint                   | 8      |    | g            | e / 65                    | 000 ~ 100                                  |  |
| Get-Backlight On_Off       | 8      |    | g            | h / 68                    | 000: Off<br>001: On                        |  |
| Get-PIP mode               | 8      |    | g            | t / 74                    | 000: OFF<br>001: PIP (POP)<br>002: PBP     |  |
| Get-PIP input              | 8      |    | g            | u / 75                    | 000 ~                                      | See Set-input select   |
| Get-Tiling Mode            | 8      |    | g            | v / 76                    | 000: OFF<br>001: ON                        | (for Video wall)   |
| Get-Tiling Compensation    | 8      |    | g            | w / 77                    | 000: OFF<br>001: ON                        | (for Video wall)<br>Bezel width compensation                                       |
| Get-Tiling H by V monitors | 8      |    | g            | x / 78                    | 01x~09x: H monitors<br>0x1~0x9: V monitors | (for Video wall)<br>1. 2nd digital for H monitors<br>2. 3rd digital for V monitors |
| Get-Tiling position        | 8      |    | g            | y / 79                    | 000: OFF<br>001~025                        | (for Video wall)<br>Copy the screen of Position# to identified display             |
| Get-Date: Year             | 8      |    | g            | 2 / 32                    | Y00~Y00                                    | Last 2 digits<br>(20)17~(20)99   |
| Get-Date: Month            | 8      |    | g            | 2 / 32                    | M00~M00                                    | 2 digits   |
| Get-Date: Day              | 8      |    | g            | 2 / 32                    | D00~M00                                    | 2 digits   |
| Get-Time: Hour             | 8      |    | g            | 3 / 33                    | H00~H00                                    | 24-hr format. 2 digits   |
| Get-Time: Min              | 8      |    | g            | 3 / 33                    | M00~M00                                    | 2 digits   |
| Get-Time: Sec              | 8      |    | g            | 3 / 33                    | S00~S00                                    | 2 digits   |

### NOTE:

#### 1. Get Date example

Assumed the current date of display#01 as below:

Date: 2017-3/15

Send: 0x 38 30 31 67 32 59 30 30 0D (Get Date:Year)

Reply: 0x 38 30 31 72 32 59 31 37 0D ("Y17")

Send: 0x 38 30 31 67 32 4D 30 30 0D (Get Date:Month)

Reply: 0x 38 30 31 72 32 4D 30 33 0D ("M03")

Send: 0x 38 30 31 67 32 44 30 30 0D (Get Date:Day)

Reply: 0x 38 30 31 72 32 44 31 35 0D ("D15")

## 2. Get Time example

Assumed the current time of display#01 as below:

Time: 16:27:59

Send: 0x 38 30 31 67 33 48 30 30 0D (Get Time:Hour)

Reply: 0x 38 30 31 72 33 48 31 36 0D ("H16")

Send: 0x 38 30 31 67 33 4D 30 30 0D (Get Time:Min)

Reply: 0x 38 30 31 72 33 4D 32 37 0D ("M27")

Send: 0x 38 30 31 67 33 53 30 30 0D (Get Time:Sec)

Reply: 0x 38 30 31 72 33 53 35 39 0D ("S59")

## 3. Get RS232 Version example

Assumed the version is 3.0.1

Send: 0x 38 30 31 67 36 30 30 30 0D (Get RS232 version)

Reply: 0x 38 30 31 72 36 33 30 31 0D ("301")

### **C. Auto Reply \*3.2.1**

The display will send out the updated data/status automatically without getting a query from the host whenever the following data/status is changed by the user through any of the available ways like: remote control unit, front keys, or touch screen.

- Power On/Off
- Input Select
- Brightness
- Backlight
- Volume
- Mute On/Off

## Remote Control Pass-through Mode

When the PC sets the Display to Remote Control Pass through mode, the Display shall send a 7-byte packet (followed by “CR”) in response to remote control unit (RCU) button activation. In this mode the remote control shall have no effect on the Display function. For example: “Volume+” will not change the volume of the Display, but instead only sends the “Volume+” code to the PC over the RS-232 port.

### IR Pass Through-Function format

Reply: (Command Type=“p”)

| Name        | Length | ID     | Command Type | RCU Code1 (MSB) | RCU Code2 (LSB) | CR     |
|-------------|--------|--------|--------------|-----------------|-----------------|--------|
| Byte Count  | 1 Byte | 2 Byte | 1 Byte       | 1 Byte          | 1 Byte          | 1 Byte |
| Bytes order | 1      | 2~3    | 4            | 5               | 6               | 7      |

**Example 1: Remote Control Pass-through when “VOL+” key is pressed for Display (#5)**

Send (Hex Format)

| Name | Length | ID           | Command Type | RCU Code1 (MSB) | RCU Code2 (LSB) | CR   |
|------|--------|--------------|--------------|-----------------|-----------------|------|
| Hex  | 0x36   | 0x30<br>0x35 | 0x70         | 0x31            | 0x30            | 0x0D |

| Key                 | Code (HEX) | Basic *3.1.1 | Optional *3.1.1 |
|---------------------|------------|--------------|-----------------|
| 1                   | 01         | V            |                 |
| 2                   | 02         | V            |                 |
| 3                   | 03         | V            |                 |
| 4                   | 04         | V            |                 |
| 5                   | 05         | V            |                 |
| 6                   | 06         | V            |                 |
| 7                   | 07         | V            |                 |
| 8                   | 08         | V            |                 |
| 9                   | 09         | V            |                 |
| 0                   | 0A         | V            |                 |
| -                   | 0B         |              | V               |
| RECALL (LAST)       | 0C         |              | V               |
| INFO (DISPLAY)      | 0D         |              | V               |
|                     | 0E         |              |                 |
| ASPECT (ZOOM, SIZE) | 0F         |              | V               |
| VOLUME UP (+)       | 10         | V            |                 |

|                                       |    |   |   |
|---------------------------------------|----|---|---|
| VOLUME DOWN (-)                       | 11 | V |   |
| MUTE                                  | 12 | V |   |
| CHANNEL/PAGE UP (+)/<br>BRIGHTNESS+   | 13 |   | V |
| CHANNEL/PAGE DOWN (-)/<br>BRIGHTNESS- | 14 |   | V |
| POWER                                 | 15 | V |   |
| SOURCES (INPUTS)                      | 16 | V |   |
|                                       | 17 |   |   |
|                                       | 18 |   |   |
| SLEEP                                 | 19 |   | V |
| MENU                                  | 1A | V |   |
| UP                                    | 1B | V |   |
| DOWN                                  | 1C | V |   |
| LEFT (-)                              | 1D | V |   |
| RIGHT (+)                             | 1E | V |   |
| OK (ENTER, SET)                       | 1F | V |   |
| EXIT                                  | 20 | V |   |
|                                       | 21 |   |   |
|                                       | 22 |   |   |
|                                       | 23 |   |   |
|                                       | 24 |   |   |
|                                       | 25 |   |   |
|                                       | 26 |   |   |
|                                       | 27 |   |   |
|                                       | 28 |   |   |
|                                       | 29 |   |   |
|                                       | 2A |   |   |
|                                       | 2B |   |   |
| RED ■ (F1)                            | 2C |   |   |
| GREEN ■ (F2)                          | 2D |   |   |
| YELLOW ■ (F3)                         | 2E |   |   |
| BLUE ■ (F4)                           | 2F |   |   |

**NOTE:**

1. This IR-pass-through code is different from the RCU key code.
2. Special control sequence for POWER key under IR-pass through mode.
- 2-1. When Display is OFF and receives the IR POWER code: Display will turn itself on, then forward the POWER code to the host via RS-232.

- 2-2. When Display is ON and receives the IR POWER code: Display will forward the POWER code to the host via RS-232, then turn off itself.
- 2-3. When SET-POWER LOCK is enabled, the Display will not respond to POWER key pressing.
3. The VOLUME UP and VOLUME DOWN code will repeatedly output when you press and hold the keys.

# Appendix

## Display Modes

### HDMI 1 & DisplayPort Mode

| Resolution  | Refresh Rate (@)           |
|-------------|----------------------------|
| 640 x 480   | 30 Hz, 60 Hz               |
| 720 x 480   | 30 Hz, 60 Hz               |
| 720 x 576   | 30 Hz, 50 Hz, 60 Hz        |
| 800 x 600   | 30 Hz, 60 Hz               |
| 1024 x 768  | 30 Hz, 60 Hz               |
| 1152 x 864  | 30 Hz, 60 Hz               |
| 1280 x 600  | 30 Hz, 60 Hz               |
| 1280 x 720  | 30 Hz, 50 Hz, 60 Hz        |
| 1280 x 768  | 30 Hz, 60 Hz               |
| 1280 x 800  | 30 Hz, 60 Hz               |
| 1280 x 960  | 30 Hz, 60 Hz               |
| 1280 x 1024 | 30 Hz, 60 Hz               |
| 1360 x 768  | 30 Hz, 60 Hz               |
| 1366 x 768  | 30 Hz, 60 Hz               |
| 1400 x 1050 | 30 Hz, 60 Hz               |
| 1440 x 900  | 30 Hz, 60 Hz               |
| 1600 x 900  | 30 Hz, 60 Hz               |
| 1600 x 1200 | 30 Hz, 60 Hz               |
| 1680 x 1050 | 30 Hz, 60 Hz               |
| 1792 x 1344 | 30 Hz, 60 Hz               |
| 1856 x 1392 | 30 Hz, 60 Hz               |
| 1920 x 1080 | 24 Hz, 30 Hz, 50 Hz, 60 Hz |
| 1920 x 1200 | 30 Hz, 60 Hz               |
| 1920 x 1440 | 30 Hz, 60 Hz               |
| 2048 x 1152 | 30 Hz, 60 Hz               |
| 2048 x 1536 | 30 Hz, 60 Hz               |
| 2560 x 1080 | 30 Hz, 50 Hz, 60 Hz        |
| 2560 x 1440 | 30 Hz, 60 Hz               |
| 2560 x 1600 | 30 Hz, 60 Hz               |
| 3440 x 1440 | 30 Hz, 60 Hz               |
| 3840 x 2160 | 24 Hz, 30 Hz, 50 Hz, 60 Hz |
| 5120 x 2160 | 30 Hz, 60 Hz               |

## HDMI 2/3/4 & Type C Mode

| Resolution  | Refresh Rate (@)           |
|-------------|----------------------------|
| 640 x 480   | 60 Hz                      |
| 720 x 480   | 60 Hz                      |
| 720 x 576   | 60 Hz                      |
| 800 x 600   | 60 Hz                      |
| 1024 x 768  | 60 Hz                      |
| 1152 x 864  | 60 Hz                      |
| 1280 x 600  | 60 Hz                      |
| 1280 x 720  | 50 Hz, 60 Hz               |
| 1280 x 768  | 60 Hz                      |
| 1280 x 800  | 60 Hz                      |
| 1280 x 960  | 60 Hz                      |
| 1280 x 1024 | 60 Hz                      |
| 1360 x 768  | 60 Hz                      |
| 1366 x 768  | 60 Hz                      |
| 1400 x 1050 | 60 Hz                      |
| 1440 x 900  | 60 Hz 60 Hz                |
| 1600 x 900  | 60 Hz                      |
| 1600 x 1200 | 60 Hz                      |
| 1680 x 1050 | 60 Hz                      |
| 1792 x 1344 | 60 Hz                      |
| 1856 x 1392 | 60 Hz                      |
| 1920 x 1080 | 24 Hz, 30 Hz, 50 Hz, 60 Hz |
| 1920 x 1200 | 60 Hz                      |
| 1920 x 1440 | 60 Hz                      |
| 2048 x 1152 | 60 Hz                      |
| 2560 x 1080 | 30 Hz, 50 Hz, 60 Hz        |
| 2560 x 1440 | 60 Hz                      |
| 3440 x 1440 | 60 Hz                      |
| 3840 x 2160 | 24 Hz, 30 Hz, 60 Hz        |

## Troubleshooting

This section describes some common problems that you may experience when using the ViewBoard.

| Problem or Issue                | Possible Solutions   |
|---------------------------------|--|
| Remote Control is not working   | <ol style="list-style-type: none"><li>1. Check whether something is obstructing the display's remote control receiver.</li><li>2. Check whether the batteries in the remote control are installed correctly.</li><li>3. Check whether the batteries need to be replaced.</li></ol> |
| The unit turns off unexpectedly | <ol style="list-style-type: none"><li>1. Check whether Sleep mode is enabled.</li><li>2. Check if there is a power outage in your area.</li><li>3. Turn on the display and see if the problem is with the signal and control system.</li></ol>                                     |

### PC Mode

| Problem or Issue     | Possible Solutions  |
|----------------------|---|
| No PC signal         | <ol style="list-style-type: none"><li>1. Check the display settings.</li><li>2. Check the display resolution.</li><li>3. Adjust the Hs &amp; Vs (synchronization) settings using the OSD menu.</li><li>4. Check the OPS resolution. Please make sure the <b>OPS 5K Detect</b> setting is set to the correct resolution.</li></ol> |
| Background streaking | <ol style="list-style-type: none"><li>1. Choose auto adjust.</li><li>2. Adjust clock and phase.</li></ol>   |
| Unsupported format   | <ol style="list-style-type: none"><li>1. Choose auto adjust.</li><li>2. Adjust clock and phase settings.</li></ol>  |

### Touch Function

| Problem or Issue             | Possible Solutions  |
|------------------------------|---|
| Touch function does not work | <ol style="list-style-type: none"><li>1. Check that drivers are installed correctly.</li><li>2. Reinstall driver(s).</li><li>3. Check setup and align it.</li><li>4. Check whether the touch pen is working properly.</li></ol> |

## Video Not Working Properly

| Problem or Issue                      | Possible Solutions  |
|---------------------------------------|---|
| No picture/ No sound                  | <ol style="list-style-type: none"><li>1. Check the Power status.</li><li>2. Check the signal cable.</li><li>3. Check that the internal PC is installed correctly.</li></ol> |
| Picture is unclear or cuts in and out | <ol style="list-style-type: none"><li>1. Check the signal cable.</li><li>2. Check if other electronics are interrupting the signal.</li></ol>                               |
| Poor picture                          | <ol style="list-style-type: none"><li>1. Adjust chroma, brightness, and contrast settings in the menu.</li><li>2. Check the signal cable.</li></ol>                         |

## Audio Not Working Properly

| Problem or Issue | Possible Solutions  |
|------------------|---|
| No sound         | <ol style="list-style-type: none"><li>1. Press the Mute/Unmute button.</li><li>2. Adjust the volume.</li><li>3. Check the audio cable.</li></ol>  |
| One speaker only | <ol style="list-style-type: none"><li>1. Adjust the sound balance in the menu.</li><li>2. Check the sound control panel settings of the computer.</li><li>3. Check the audio cable.</li></ol> |

# Maintenance

## General Precautions

- Make sure the device is turned off and the power cable is unplugged from the power outlet.
- Never spray or pour any liquid directly onto the screen or case.
- Handle the device with care, as a darker-colored device, if scuffed, may show marks more clearly than a lighter-colored device.
- Do not use the system continuously for long periods of time.

## Cleaning the Screen

- Wipe the screen with a clean, soft, lint-free cloth. This removes dust and other particles.
- If the screen is still not clean, apply a small amount of non-ammonia, non-alcohol based glass cleaner onto a clean, soft, lint-free cloth; then wipe the screen.

## Cleaning the Case

- Use a soft, dry cloth.
- If the case is still not clean, apply a small amount of non-ammonia, non-alcohol based, mild non-abrasive detergent onto a clean, soft, lint-free cloth, then wipe the surface.

## Disclaimer

- ViewSonic® does not recommend the use of any ammonia or alcohol-based cleaners on the display screen or case. Some chemical cleaners have been reported to damage the screen and/or case of the device.
- ViewSonic® will not be liable for damage resulting from use of any ammonia or alcohol-based cleaners.

**NOTE:** If condensation appears between the glass and the panel, keep the display turned on until the moisture disappears.

# Regulatory and Service Information

## Compliance Information

This section addresses all connected requirements and statements regarding regulations. Confirmed corresponding applications shall refer to nameplate labels and relevant markings on the unit.

### FCC Compliance Statement

This device has been tested and found to comply with the limits for a Class A digital device, pursuant to Part 15 of the FCC Rules. These limits are designed to provide reasonable protection against harmful interference when the equipment is operated in a commercial environment. This equipment generates, uses, and can radiate radio frequency energy and, if not installed and used in accordance with the instruction manual, may cause harmful interference to radio communications. Operation of this equipment in a residential area is likely to cause harmful interference, in which case the user will be required to correct the interference at their own expense.

Properly shielded and grounded cables and connectors must be used in order to meet FCC emission limits. ViewSonic is not responsible for any radio or television interference caused by using other than recommended cables and connectors or by unauthorized changes or modifications to this equipment. Unauthorized changes or modifications could void the user's authority to operate the equipment.

This device complies with Part 15 of the FCC Rules. Operation is subject to the following two conditions: (1) this device may not cause harmful interference, and (2) this device must accept any interference received, including interference that might cause undesired operation.

**Warning:** You are cautioned that changes or modifications not expressly approved by the party responsible for compliance could void your authority to operate the equipment.

### Industry Canada Statement

CAN ICES (B) / NMB (B)

### CE Conformity for European Countries



The device complies with the EMC Directive 2014/30/EU and Low Voltage Directive 2014/35/EU.

**The following information is only for EU-member states:**

The mark shown to the right is in compliance with the Waste Electrical and Electronic Equipment Directive 2012/19/EU (WEEE). The mark indicates the requirement NOT to dispose of the equipment as unsorted municipal waste, but use the return and collection systems according to local law.



**Declaration of RoHS2 Compliance**

This product has been designed and manufactured in compliance with Directive 2011/65/EU of the European Parliament and the Council on restriction of the use of certain hazardous substances in electrical and electronic equipment (RoHS2 Directive) and is deemed to comply with the maximum concentration values issued by the European Technical Adaptation Committee (TAC) as shown below:

| Substance                               | Proposed Maximum Concentration | Actual Concentration |
|---|--------------------------------|----------------------|
| Lead (Pb)                               | 0.1%                           | < 0.1%               |
| Mercury (Hg)                            | 0.1%                           | < 0.1%               |
| Cadmium (Cd)                            | 0.01%                          | < 0.01%              |
| Hexavalent Chromium (Cr6 <sup>+</sup> ) | 0.1%                           | < 0.1%               |
| Polybrominated biphenyls (PBB)          | 0.1%                           | < 0.1%               |
| Polybrominated diphenyl ethers (PBDE)   | 0.1%                           | < 0.1%               |
| Bis (2-ethylhexyl) phthalate (DEHP)     | 0.1%                           | < 0.1%               |
| Butyl benzyl phthalate (BBP)            | 0.1%                           | < 0.1%               |
| Dibutyl phthalate (DBP)                 | 0.1%                           | < 0.1%               |
| Diisobutyl phthalate (DIBP)             | 0.1%                           | < 0.1%               |

**Certain components of products as stated above are exempted under the Annex III of the RoHS2 Directives as noted below:**

- Copper alloy containing up to 4% lead by weight.
- Lead in high melting temperature type solders (i.e. lead-based alloys containing 85% by weight or more lead).
- Electrical and electronic components containing lead in a glass or ceramic other than dielectric ceramic in capacitors, e.g. piezoelectronic devices, or in a glass or ceramic matrix compound.
- Lead in dielectric ceramic in capacitors for a rated voltage of 125V AC or 250V DC or higher.

## ENERGY STAR Statement

ENERGY STAR is a U.S. Environmental Protection Agency voluntary program that helps businesses and individuals save money and protect our climate through superior energy efficiency. Products that earn the ENERGY STAR prevent greenhouse gas emissions by meeting strict energy efficiency criteria or requirements set by the U.S. Environmental Protection Agency.

As an ENERGY STAR Partner, ViewSonic is determined to meet the Energy star Guidelines and mark all certified models with the ENERGY STAR logo.

The following logo appears on all ENERGY STAR-certified models:



**NOTE:** The power management features significantly reduce energy consumption when the product is not in use. Power management allows the device to automatically enter a low power “sleep” mode after a defined period of inactivity. And the power management features also enter Sleep Mode or Off Mode within 5 minutes of being disconnected from a host computer. Please note any change in energy settings will increase energy consumption.

## Indian Restriction of Hazardous Substances

Restriction on Hazardous Substances statement (India). This product complies with the “India E-waste Rule 2011” and prohibits use of lead, mercury, hexavalent chromium, polybrominated biphenyls or polybrominated diphenyl ethers in concentrations exceeding 0.1 weight % and 0.01 weight % for cadmium, except for the exemptions set in Schedule 2 of the Rule.

## Product Disposal at End of Product Life

ViewSonic® respects the environment and is committed to working and living green. Thank you for being part of Smarter, Greener Computing. Please visit the ViewSonic® website to learn more.

### USA & Canada:

<https://www.viewsonic.com/us/go-green-with-viewsonic>

### Europe:

<https://www.viewsonic.com/eu/environmental-social-governance/recycle>

### Taiwan:

<https://recycle.moenv.gov.tw/>

**For EU users, please contact us for any safety/accident issue experienced with this product:**

ViewSonic Europe Limited



Haaksbergweg 75  
1101 BR Amsterdam  
Netherlands



+31 (0) 650608655



[EPREL@viewsoniceurope.com](mailto:EPREL@viewsoniceurope.com)



<https://www.viewsonic.com/eu/>

## Copyright Information

Copyright© ViewSonic® Corporation, 2024. All rights reserved.

Macintosh and Power Macintosh are registered trademarks of Apple Inc.

Microsoft, Windows, and the Windows logo are registered trademarks of Microsoft Corporation in the United States and other countries.

ViewSonic® and the three birds logo are registered trademarks of ViewSonic® Corporation.

VESA is a registered trademark of the Video Electronics Standards Association. DPMS, DisplayPort, and DDC are trademarks of VESA.

ENERGY STAR® is a registered trademark of the U.S. Environmental Protection Agency (EPA).

As an ENERGY STAR® partner, ViewSonic® Corporation has determined that this product meets the ENERGY STAR® guidelines for energy efficiency.

**Disclaimer:** ViewSonic® Corporation shall not be liable for technical or editorial errors or omissions contained herein; nor for incidental or consequential damages resulting from furnishing this material, or the performance or use of this product.

In the interest of continuing product improvement, ViewSonic® Corporation reserves the right to change product specifications without notice. Information in this document may change without notice.

No part of this document may be copied, reproduced, or transmitted by any means, for any purpose without prior written permission from ViewSonic® Corporation.

## Customer Service

For technical support or product service, see the table below or contact your reseller.

**NOTE:** You will need the product's serial number.

| Country/ Region                  | Website  | Country/ Region          | Website  |
|----------------------------------|--|--------------------------|--|
| <b>Asia Pacific &amp; Africa</b> |  |                          |  |
| Australia                        | <a href="http://www.viewsonic.com/au/">www.viewsonic.com/au/</a>       | Bangladesh               | <a href="http://www.viewsonic.com/bd/">www.viewsonic.com/bd/</a> |
| 中国 (China)                       | <a href="http://www.viewsonic.com.cn">www.viewsonic.com.cn</a>         | 香港 (繁體中文)                | <a href="http://www.viewsonic.com/hk/">www.viewsonic.com/hk/</a> |
| Hong Kong (English)              | <a href="http://www.viewsonic.com/hk-en/">www.viewsonic.com/hk-en/</a> | India                    | <a href="http://www.viewsonic.com/in/">www.viewsonic.com/in/</a> |
| Indonesia                        | <a href="http://www.viewsonic.com/id/">www.viewsonic.com/id/</a>       | Israel                   | <a href="http://www.viewsonic.com/il/">www.viewsonic.com/il/</a> |
| 日本 (Japan)                       | <a href="http://www.viewsonic.com/jp/">www.viewsonic.com/jp/</a>       | Korea                    | <a href="http://www.viewsonic.com/kr/">www.viewsonic.com/kr/</a> |
| Malaysia                         | <a href="http://www.viewsonic.com/my/">www.viewsonic.com/my/</a>       | Middle East              | <a href="http://www.viewsonic.com/me/">www.viewsonic.com/me/</a> |
| Myanmar                          | <a href="http://www.viewsonic.com/mm/">www.viewsonic.com/mm/</a>       | Nepal                    | <a href="http://www.viewsonic.com/np/">www.viewsonic.com/np/</a> |
| New Zealand                      | <a href="http://www.viewsonic.com/nz/">www.viewsonic.com/nz/</a>       | Pakistan                 | <a href="http://www.viewsonic.com/pk/">www.viewsonic.com/pk/</a> |
| Philippines                      | <a href="http://www.viewsonic.com/ph/">www.viewsonic.com/ph/</a>       | Singapore                | <a href="http://www.viewsonic.com/sg/">www.viewsonic.com/sg/</a> |
| 臺灣 (Taiwan)                      | <a href="http://www.viewsonic.com/tw/">www.viewsonic.com/tw/</a>       | ประเทศไทย                | <a href="http://www.viewsonic.com/th/">www.viewsonic.com/th/</a> |
| Việt Nam                         | <a href="http://www.viewsonic.com/vn/">www.viewsonic.com/vn/</a>       | South Africa & Mauritius | <a href="http://www.viewsonic.com/za/">www.viewsonic.com/za/</a> |
| <b>Americas</b>                  |  |                          |  |
| United States                    | <a href="http://www.viewsonic.com/us">www.viewsonic.com/us</a>         | Canada                   | <a href="http://www.viewsonic.com/us">www.viewsonic.com/us</a>   |
| Latin America                    | <a href="http://www.viewsonic.com/la">www.viewsonic.com/la</a>         |                          |  |
| <b>Europe</b>                    |  |                          |  |
| Europe                           | <a href="http://www.viewsonic.com/eu/">www.viewsonic.com/eu/</a>       | France                   | <a href="http://www.viewsonic.com/fr/">www.viewsonic.com/fr/</a> |
| Deutschland                      | <a href="http://www.viewsonic.com/de/">www.viewsonic.com/de/</a>       | Қазақстан                | <a href="http://www.viewsonic.com/kz/">www.viewsonic.com/kz/</a> |
| Россия                           | <a href="http://www.viewsonic.com/ru/">www.viewsonic.com/ru/</a>       | España                   | <a href="http://www.viewsonic.com/es/">www.viewsonic.com/es/</a> |
| Türkiye                          | <a href="http://www.viewsonic.com/tr/">www.viewsonic.com/tr/</a>       | Україна                  | <a href="http://www.viewsonic.com/ua/">www.viewsonic.com/ua/</a> |
| United Kingdom                   | <a href="http://www.viewsonic.com/uk/">www.viewsonic.com/uk/</a>       |                          |  |

## Limited Warranty

### ViewSonic® Smart White Board

#### What the warranty covers:

ViewSonic® warrants its products to be free from defects in material and workmanship during the warranty period. If a product proves to be defective in material or workmanship during the warranty period, ViewSonic® will, at its sole option, and as your sole remedy, repair or replace the product with a similar product. Replacement Product or parts may include remanufactured or refurbished parts or components. The repair or replacement unit or parts or components will be covered by the balance of the time remaining on the customer's original limited warranty and the warranty period will not be extended. ViewSonic® provides no warranty for any third-party software whether included with the product or installed by the customer, installation of any unauthorized hardware parts or components (e.g. Projector Lamps). (Please refer to: "What the warranty excludes and does not cover" section).

#### Who the warranty protects:

This warranty is valid only for the first consumer purchaser.

#### What the warranty excludes and does not cover:

- Any product on which the serial number has been defaced, modified, or removed.
- Damage, deterioration, or malfunction resulting from:
  - » Accident, misuse, neglect, fire, water, lightning, or other acts of nature, unauthorized product modification, or failure to follow instructions supplied with the product.
  - » Repair or attempted repair by anyone not authorized by ViewSonic®.
  - » Damage to or loss of any programs, data, or removable storage media.
  - » Normal wear and tear.
  - » Removal or installation of the product.
- Software or data loss occurring during repair or replacement.
- Any damage of the product due to shipment.
- Causes external to the product, such as electric power fluctuations or failure.
- Use of supplies or parts not meeting ViewSonic's specifications.
- Failure of owner to perform periodic product maintenance as stated in the User Guide.

- Any other cause which does not relate to a product defect.
- Damage caused by static (non-moving) images displayed for lengthy periods of time (also referred to as image burn-in).
- Software - Any third-party software included with the product or installed by the customer.
- Hardware/Accessories/Parts/Components – Installation of any unauthorized hardware, accessories, consumable parts or components (e.g. Projector Lamps).
- Damage to, or abuse of, the coating on the surface of the display through inappropriate cleaning as described in the product User Guide.
- Removal, installation, and set-up service charges, including wall-mounting of the product.

### **How to get service:**

- For information about receiving service under warranty, contact ViewSonic® Customer Support (Please refer to the “Customer Service” page). You will need to provide your product’s serial number.
- To obtain warranty service, you will be required to provide: (a) the original dated sales slip, (b) your name, (c) your address, (d) a description of the problem, and (e) the serial number of the product.
- Take or ship the product, freight prepaid, in the original container to an authorized ViewSonic® service center or ViewSonic®.
- For additional information or the name of the nearest ViewSonic® service center, contact ViewSonic®.

### **Limitation of implied warranties:**

There are no warranties, express or implied, which extend beyond the description contained herein including the implied warranty of merchantability and fitness for a particular purpose.

**Exclusion of damages:**

ViewSonic's liability is limited to the cost of repair or replacement of the product. ViewSonic® shall not be liable for:

- Damage to other property caused by any defects in the product, damages based upon inconvenience, loss of use of the product, loss of time, loss of profits, loss of business opportunity, loss of goodwill, interference with business relationships, or other commercial loss, even if advised of the possibility of such damages.
- Any other damages, whether incidental, consequential or otherwise.
- Any claim against the customer by any other party.
- Repair or attempted repair by anyone not authorized by ViewSonic®.

**Effect of state law:**

This warranty gives you specific legal rights, and you may also have other rights which vary from state to state. Some states do not allow limitations on implied warranties and/or do not allow the exclusion of incidental or consequential damages, so the above limitations and exclusions may not apply to you.

**Sales outside the U.S.A. and Canada:**

For warranty information and service on ViewSonic® products sold outside of the U.S.A. and Canada, contact ViewSonic® or your local ViewSonic® dealer.

The warranty period for this product in mainland China (Hong Kong, Macao, and Taiwan Excluded) is subject to the terms and conditions of the Maintenance Guarantee Card.

For users in Europe and Russia, full details of warranty provided can be found at: <http://www.viewsonic.com/eu/> under "Support/Warranty Information".

## **Mexico Limited Warranty**

### ViewSonic® Smart White Board

#### **What the warranty covers:**

ViewSonic® warrants its products to be free from defects in material and workmanship, under normal use, during the warranty period. If a product proves to be defective in material or workmanship during the warranty period, ViewSonic® will, at its sole option, repair or replace the product with a like product. Replacement product or parts may include remanufactured or refurbished parts or components & accessories.

#### **Who the warranty protects:**

This warranty is valid only for the first consumer purchaser.

#### **What the warranty excludes and does not cover:**

- Any product on which the serial number has been defaced, modified or removed.
- Damage, deterioration, or malfunction resulting from:
  - » Accident, misuse, neglect, fire, water, lightning, or other acts of nature, unauthorized product modification, unauthorized attempted repair, or failure to follow instructions supplied with the product.
  - » Causes external to the product, such as electrical power fluctuations or failure.
  - » Use of supplies or parts not meeting ViewSonic®'s specifications.
  - » Normal wear and tear.
  - » Any other cause which does not relate to a product defect.
- Any product exhibiting a condition commonly known as “image burn-in” which results when a static image is displayed on the product for an extended period of time.
- Removal, installation, insurance, and set-up service charges.

**How to get service:**

For information about receiving service under warranty, contact ViewSonic® Customer Support (Please refer to the attached “Customer Service” page). You will need to provide your product’s serial number, so please record the product information in the space provided below on your purchase for your future use. Please retain your receipt of proof of purchase to support your warranty claim.

**For Your Records**

Product Name: \_\_\_\_\_ Model Number: \_\_\_\_\_  
Document Number: \_\_\_\_\_ Serial Number: \_\_\_\_\_  
Purchase Date: \_\_\_\_\_ Extended Warranty Purchase? \_\_\_\_\_(Y/N)  
If so, what date does warranty expire? \_\_\_\_\_

- To obtain warranty service, you will be required to provide (a) the original dated sales slip, (b) your name, (c) your address, (d) a description of the problem, and (e) the serial number of the product.
- Take or ship the product, in the original container packaging, to an authorized ViewSonic® service center.
- Round trip transportation costs for in-warranty products will be paid by ViewSonic®.

**Limitation of implied warranties:**

There are no warranties, express or implied, which extend beyond the description contained herein including the implied warranty of merchantability and fitness for a particular purpose.

**Exclusion of damages:**

ViewSonic®’s liability is limited to the cost of repair or replacement of the product. ViewSonic® shall not be liable for:

- Damage to other property caused by any defects in the product, damages based upon inconvenience, loss of use of the product, loss of time, loss of profits, loss of business opportunity, loss of goodwill, interference with business relationships, or other commercial loss, even if advised of the possibility of such damages.
- Any other damages, whether incidental, consequential or otherwise.
- Any claim against the customer by any other party.
- Repair or attempted repair by anyone not authorized by ViewSonic®.

|   |   |
|---|---|
| Contact Information for Sales & Authorized Service (Centro Autorizado de Servicio) within Mexico:   |   |
| <b>Name, address, of manufacturer and importers:</b><br>México, Av. de la Palma #8 Piso 2 Despacho 203, Corporativo Interpalmas,<br>Col. San Fernando Huixquilucan, Estado de México<br>Tel: (55) 3605-1099 <a href="http://www.viewsonic.com/la/soporte/index.htm">http://www.viewsonic.com/la/soporte/index.htm</a> |   |
| NÚMERO GRATIS DE ASISTENCIA TÉCNICA PARA TODO MÉXICO: 001.866.823.2004  |   |
| <b>Hermosillo:</b><br>Distribuciones y Servicios Computacionales SA de CV.<br>Calle Juarez 284 local 2<br>Col. Bugambilias C.P: 83140<br>Tel: 01-66-22-14-9005<br>E-Mail: <a href="mailto:disc2@hmo.megared.net.mx">disc2@hmo.megared.net.mx</a>  | <b>Villahermosa:</b><br>Compumantenimientos Garantizados, S.A. de C.V.<br>AV. GREGORIO MENDEZ #1504<br>COL, FLORIDA C.P. 86040<br>Tel: 01 (993) 3 52 00 47 / 3522074 / 3 52 20 09<br>E-Mail: <a href="mailto:compumantenimientos@prodigy.net.mx">compumantenimientos@prodigy.net.mx</a> |
| <b>Puebla, Pue. (Matriz):</b><br>RENTA Y DATOS, S.A. DE C.V. Domicilio:<br>29 SUR 721 COL. LA PAZ<br>72160 PUEBLA, PUE.<br>Tel: 01(52).222.891.55.77 CON 10 LINEAS<br>E-Mail: <a href="mailto:datos@puebla.megared.net.mx">datos@puebla.megared.net.mx</a>  | <b>Veracruz, Ver.:</b><br>CONEXION Y DESARROLLO, S.A DE C.V. Av.<br>Americas # 419<br>ENTRE PINZÓN Y ALVARADO<br>Fracc. Reforma C.P. 91919<br>Tel: 01-22-91-00-31-67<br>E-Mail: <a href="mailto:gacosta@qplus.com.mx">gacosta@qplus.com.mx</a>  |
| <b>Chihuahua:</b><br>Soluciones Globales en Computación<br>C. Magisterio # 3321 Col. Magisterial<br>Chihuahua, Chih.<br>Tel: 4136954<br>E-Mail: <a href="mailto:Cefeo@soluglobales.com">Cefeo@soluglobales.com</a>  | <b>Cuernavaca:</b><br>Compusupport de Cuernavaca SA de CV<br>Francisco Leyva # 178 Col. Miguel Hidalgo<br>C.P. 62040, Cuernavaca Morelos<br>Tel: 01 777 3180579 / 01 777 3124014<br>E-Mail: <a href="mailto:aquevedo@compusupportcva.com">aquevedo@compusupportcva.com</a>              |
| <b>Distrito Federal:</b><br>QPLUS, S.A. de C.V.<br>Av. Coyoacán 931<br>Col. Del Valle 03100, México, D.F.<br>Tel: 01(52)55-50-00-27-35<br>E-Mail : <a href="mailto:gacosta@qplus.com.mx">gacosta@qplus.com.mx</a>   | <b>Guadalajara, Jal.:</b><br>SERVICRECE, S.A. de C.V.<br>Av. Niños Héroes # 2281<br>Col. Arcos Sur, Sector Juárez<br>44170, Guadalajara, Jalisco<br>Tel: 01(52)33-36-15-15-43<br>E-Mail: <a href="mailto:mmiranda@servicrece.com">mmiranda@servicrece.com</a>                           |
| <b>Guerrero Acapulco:</b><br>GS Computación (Grupo Sesicomp)<br>Progreso #6-A, Colo Centro<br>39300 Acapulco, Guerrero<br>Tel: 744-48-32627   | <b>Monterrey:</b><br>Global Product Services<br>Mar Caribe # 1987, Esquina con Golfo Pérsico<br>Fracc. Bernardo Reyes, CP 64280<br>Monterrey N.L. México<br>Tel: 8129-5103<br>E-Mail: <a href="mailto:aydeem@gps1.com.mx">aydeem@gps1.com.mx</a>  |
| <b>MERIDA:</b><br>ELECTROSER<br>Av Reforma No. 403Gx39 y 41<br>Mérida, Yucatán, México CP97000<br>Tel: (52) 999-925-1916<br>E-Mail: <a href="mailto:rrrb@sureste.com">rrrb@sureste.com</a>  | <b>Oaxaca, Oax.:</b><br>CENTRO DE DISTRIBUCION Y<br>SERVICIO, S.A. de C.V.<br>Murguía # 708 P.A., Col. Centro, 68000, Oaxaca<br>Tel: 01(52)95-15-15-22-22<br>Fax: 01(52)95-15-13-67-00<br>E-Mail: <a href="mailto:gpotai2001@hotmail.com">gpotai2001@hotmail.com</a>                    |
| <b>Tijuana:</b><br>STD<br>Av Ferrocarril Sonora #3780 L-C<br>Col 20 de Noviembr<br>Tijuana, Mexico  | <b>FOR USA SUPPORT:</b><br>ViewSonic® Corporation<br>381 Brea Canyon Road, Walnut, CA. 91789 USA<br>Tel: 800-688-6688<br>E-Mail: <a href="http://www.viewsonic.com">http://www.viewsonic.com</a>  |



**ViewSonic®**