

SAMSUNG

User guide

HW-S60D / HW-S61D

Thank you for purchasing this Samsung product.

To receive more complete service, please register your product at www.samsung.com









Figures and illustrations in this User Manual are provided for reference only and may differ from actual product appearance.

CONTENTS

| | | |
|-----------|---|-----------|
| 01 | Checking the Components | 4 |
| 02 | Product Overview | 5 |
| | Front Panel / Top Panel of the Soundbar | 5 |
| | Bottom Panel of the Soundbar | 7 |
| 03 | Using the Remote Control | 8 |
| | Inserting Batteries before using the Remote Control (AAA batteries X 2) | 8 |
| | How to Use the Remote Control | 8 |
| | Setting the  (Sound Control) | 11 |
| | Using the Hidden Buttons (Buttons with more than one function) | 12 |
| | Output specifications for the different sound effect modes | 13 |
| | Adjusting the Soundbar volume with a TV remote control | 14 |
| 04 | Connecting the Soundbar | 15 |
| | Connecting Electrical Power | 15 |
| | Connecting the Samsung Wireless Rear Kit and Subwoofer to your Soundbar | 15 |
| 05 | Connecting to a TV | 16 |
| | Connecting the TV that supports HDMI ARC (Audio Return Channel) | 16 |
| | Connecting using an Optical Cable | 18 |
| | Connecting via Bluetooth | 19 |
| | Connecting via Wi-Fi | 21 |
| | Connecting to a TV that supports Dolby Atmos® | 22 |
| | Using the Q-Symphony Function | 24 |
| | Using the SpaceFit Sound | 25 |

| | | |
|-----------|---|-----------|
| 06 | Connecting an External Device | 26 |
| | Connecting using an Optical Cable | 26 |
| 07 | Connecting a Mobile Device | 27 |
| | Method 1. Connecting via Bluetooth | 27 |
| | Method 2. Connecting via Wi-Fi (Wireless Network) | 30 |
| | Using Group Play | 31 |
| | Connecting via Apple AirPlay | 32 |
| | Using the Tap Sound | 33 |
| 08 | Installing the Wall Mount | 34 |
| | Installation Precautions | 34 |
| | Wallmount Components | 34 |
| 09 | Installing the Soundbar in front of TV | 36 |
| 10 | Software Update | 37 |
| | Auto Update | 37 |
| | USB Update | 37 |
| | Reset | 38 |
| | Security updates information | 38 |
| 11 | Troubleshooting | 39 |
| 12 | License | 41 |

01 CHECKING THE COMPONENTS









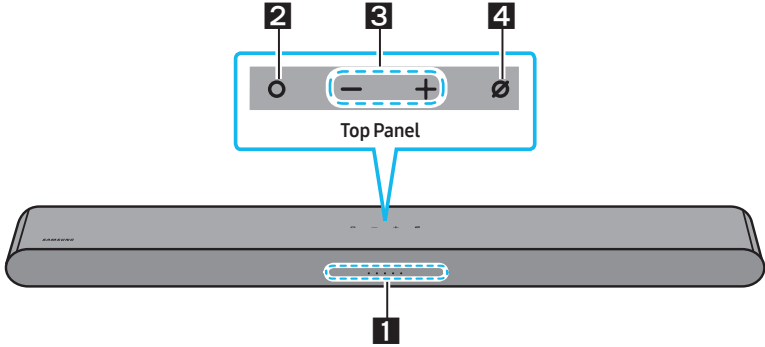

















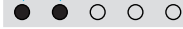



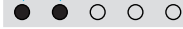

| | | | |
|---|--|---|---|
|  |  | | |
| <p>Soundbar Main Unit</p> | <p>Soundbar Remote Control (HW-S60D : AH81-15047A / HW-S61D : AH81-17332A) / Batteries</p> | | |
|  |  |  | |
| <p>HDMI Cable (BN39-02661A)</p> | <p>AC/DC Adapter (HW-S60D : AH81-17317A / HW-S61D : AH81-17317B)</p> | <p>Power Cord (HW-S60D : 3903-001117 / HW-S61D : 3903-001188)</p> | |
|  |  x 2 |  x 2 |  x 2 (M4 x L10) |
| <p>Wall Mount Guide (AH81-15186A)</p> | <p>Holder-Screw (AH61-04110A)</p> | <p>Bracket-Wall Mount (AH61-04235A)</p> | <p>Screw (6001-001202)</p> |

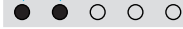

- For more information about the power supply and power consumption, refer to the label attached to the product. (Label: Bottom of the Soundbar Main Unit)
- To purchase additional components or optional cables, contact a Samsung Service Center or Samsung Customer Care.
- For more information about the wallmount see page 34.
- Design, specifications, and App screen are subject to change without prior notice.
- The appearance of the accessories may differ slightly from the illustrations above.

02 PRODUCT OVERVIEW

Front Panel / Top Panel of the Soundbar

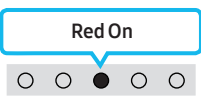

| | | | | | | | | | | | | | | |
|--|---|--|--|---|---|--|--|----------------|----------------------|---|---|---|--------------------|---------------------------|
| <p>1</p> | <p>LED indicator</p> | <p>The LED Indicator flashes, glows, or changes color depending on the Soundbar's current mode or status. The color of the LED indicator and the number of lights indicate the active mode as described below.</p> <table border="1" data-bbox="266 753 1028 834"> <tr> <td data-bbox="266 753 404 834">  White LED </td> <td data-bbox="404 753 542 834">  White LED </td> <td data-bbox="542 753 679 834">  Multicolor LED </td> <td data-bbox="679 753 817 834">  White LED </td> <td data-bbox="817 753 1028 834">  White LED </td> </tr> </table> <ul style="list-style-type: none"> The Multicolor LED changes to White, Cyan, Green, Red, and Blue depending on the mode or status. |  White LED |  White LED |  Multicolor LED |  White LED |  White LED | | | | | | | |
|  White LED |  White LED |  Multicolor LED |  White LED |  White LED | | | | | | | | | | |
| <p>2</p> | <p>Multi Function Button</p> | <ul style="list-style-type: none"> In standby mode, press the ○ (Multi Function) button to turn on the Soundbar. Press the ○ (Multi Function) button to change the mode. Each time you change the mode, the LED lights in white and then turns off. <table border="1" data-bbox="266 1026 1021 1362"> <tr> <td data-bbox="266 1026 404 1137"> <p>LED Indicator</p> </td> <td data-bbox="404 1026 712 1137"> <p>White On -> Off</p>  </td> <td data-bbox="712 1026 1021 1137"> <p>White On -> Off</p>  </td> </tr> <tr> <td data-bbox="266 1137 404 1193">  </td> <td data-bbox="404 1137 712 1193"> <p>"TV ARC" or "eARC"</p> </td> <td data-bbox="712 1137 1021 1193"> <p>"Wi-Fi"</p> </td> </tr> <tr> <td data-bbox="266 1193 404 1305"> <p>LED Indicator</p> </td> <td data-bbox="404 1193 712 1305"> <p>White On -> Off</p>  </td> <td data-bbox="712 1193 1021 1305"> <p>White On -> Off</p>  </td> </tr> <tr> <td data-bbox="266 1305 404 1362">  </td> <td data-bbox="404 1305 712 1362"> <p>"Bluetooth"</p> </td> <td data-bbox="712 1305 1021 1362"> <p>"Digital Audio In"</p> </td> </tr> </table> | <p>LED Indicator</p> | <p>White On -> Off</p>  | <p>White On -> Off</p>  |  | <p>"TV ARC" or "eARC"</p> | <p>"Wi-Fi"</p> | <p>LED Indicator</p> | <p>White On -> Off</p>  | <p>White On -> Off</p>  |  | <p>"Bluetooth"</p> | <p>"Digital Audio In"</p> |
| <p>LED Indicator</p> | <p>White On -> Off</p>  | <p>White On -> Off</p>  | | | | | | | | | | | | |
|  | <p>"TV ARC" or "eARC"</p> | <p>"Wi-Fi"</p> | | | | | | | | | | | | |
| <p>LED Indicator</p> | <p>White On -> Off</p>  | <p>White On -> Off</p>  | | | | | | | | | | | | |
|  | <p>"Bluetooth"</p> | <p>"Digital Audio In"</p> | | | | | | | | | | | | |
| <p>3</p> | <p>Volume Button</p> | <p>Press the - + (Volume) button to adjust the volume.</p> | | | | | | | | | | | | |

| | | | | |
|----------|--------------------------|---|---|---|
| 4 | Mic On/Off Button | Press the  (Mic On/Off) button to turn the microphone on or off. When the microphone is off, the LED Indicator will light red. | | |
| | | LED Indicator |  |  |
| | |  | "Mic Off" | "Mic On" |

- When you plug in the AC cord, the power button will begin working in 4 to 6 seconds.
- When you turn on this unit, there will be a 4 to 5 second delay before it produces sound.
- If you hear sounds from both the TV and Soundbar, go to the **Settings** menu for the TV audio and change the TV speaker to **External Speaker**.
- You can turn on and off audio feedback by using **SmartThings** app. To learn about using the **SmartThings** app, refer to "**Method 2. Connecting via Wi-Fi (Wireless Network)**".

Bottom Panel of the Soundbar

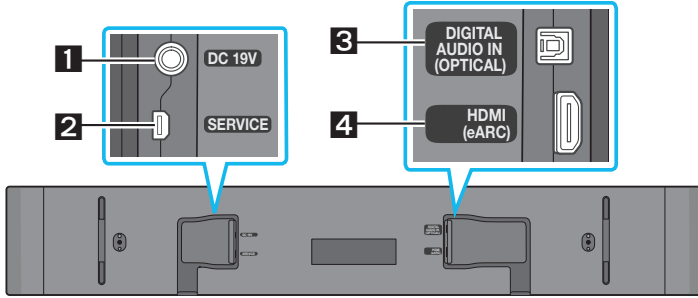

| | |
|----------|---|
| 1 | DC 19V (Power Supply In) Connect the AC/DC power adapter. (See page 15) |
| 2 | SERVICE Connect a USB storage device to upgrade the product's software. |
| 3 | DIGITAL AUDIO IN (OPTICAL) Connect to the digital (optical) output of an external device. (See page 26) |
| 4 | HDMI (eARC) Connect to the HDMI (eARC) port on a TV. (See page 16) |

- When disconnecting the power cable of the AC/DC power adapter from a wall outlet, pull the plug. Do not pull the cable.
- Do not connect this unit or other components to an AC outlet until all connections between components are complete.

03 USING THE REMOTE CONTROL

Inserting Batteries before using the Remote Control (AAA batteries X 2)

Slide the back cover in the direction of the arrow until it is completely removed.

Insert 2 AAA batteries (1.5V) oriented so that their polarity is correct. Slide the back cover back into position.

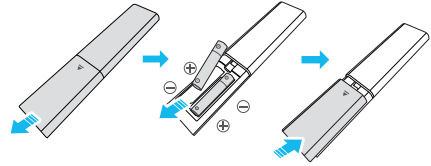

How to Use the Remote Control

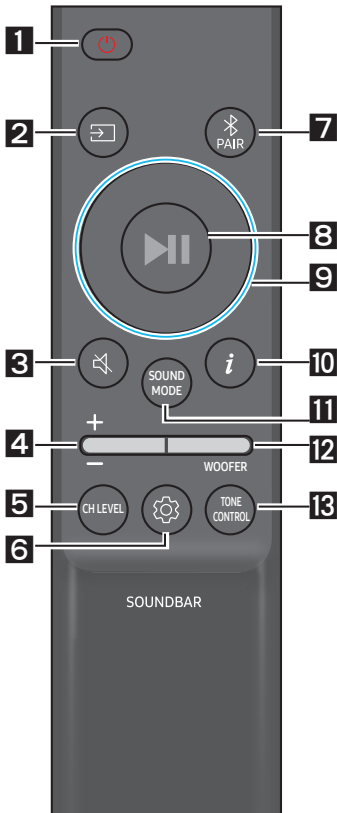

1

Power

Turns the Soundbar on and off.

| | | |
|---------------|-----------------------|----------------------|
| LED Indicator | Cyan Blinks X1 | Red Blinks X3 |
| | ○ ○ ● ○ ○ | ○ ○ ● ○ ○ |
| | On | Off |

- **Auto Power Down Function**

The unit turns off automatically in the following situations:

- In "TV ARC" or "eARC" / "Wi-Fi" / "Bluetooth" / "Digital Audio In" mode if there is no audio signal for 18 minutes.

2

Source

Press to select a source connected to the Soundbar.

- **Audio Feedback On/Off**

You can turn the Audio Feedback on or off. Press and hold the **Source** button on the remote control for 5 seconds while the Soundbar is off (Standby mode).

| | | |
|---------------|-----------------------|----------------------|
| LED Indicator | Cyan Blinks X1 | Red Blinks X1 |
| | ○ ○ ● ○ ○ | ○ ○ ● ○ ○ |
| | On | Off |

3

Press the (**Mute**) button to mute the sound.
Press it again to unmute the sound.

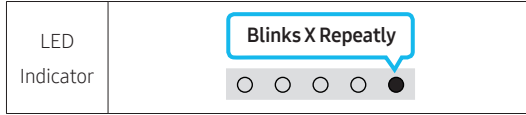
**4****Volume**

Push the button up or down to adjust the volume.

**5****CH LEVEL**

By pressing the button, you can adjust the volume of each speaker.

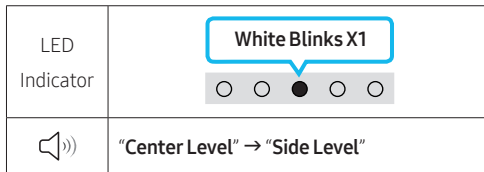

- If the Rear Speakers (sold separately) are connected, the setting "**Rear Level**" is supported. Use the **Up/Down** button to adjust the volume of the "**Rear Level**" between -6 to +6.

6 **(Sound Control)**

By pressing the button, you can set the audio function. The desired item can be adjusted using the **Up/Down** buttons. Each time the mode changes, the Multicolor LED blinks in white.

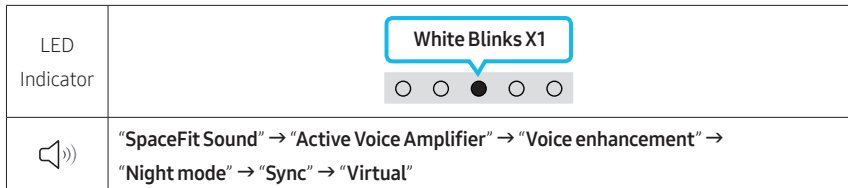



- Press and hold the (**Sound Control**) button for about 5 seconds to adjust the sound for each frequency band. 150Hz, 300Hz, 600Hz, 1.2kHz, 2.5kHz, 5kHz, and 10kHz are selectable using the **Left/Right** buttons and each can be adjusted to a setting between -6 to +6 using the **Up/Down** buttons. (Make sure the Sound mode is set to "**Standard**".)
- If the Rear Speakers (sold separately) are connected, the setting "**Sound Grouping**" and "**Private Rear Sound**" are supported.
- Refer to "**Setting the (Sound Control)**" on page 11.

7**Bluetooth PAIR**

Switch the Soundbar to Bluetooth pairing mode.

When you press the button, the LED display changes as shown below.

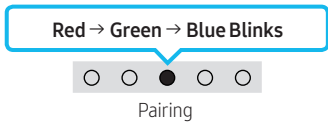
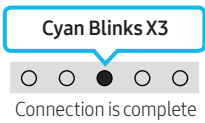
- Until pairing is complete, the Multicolor LED changes as **Red → Green → Blue** in turn.

| | | |
|---|---|---|
| LED Indicator |  |  |
|  | "Ready to connect via Bluetooth." | |

8**▶|| (Play / Pause)**

You can also play or pause music by pressing the button.

9**Up/Down/Left/Right**

Press **Up/Down/Left/Right** on the button to select or set functions.

- **Music Skip**
Press the **Right** button to select the next music file. Press the **Left** button to select the previous music file.
- **ID SET**
Press and hold the **Up** button for 5 seconds to complete **ID SET** (when connecting to a wireless subwoofer or wireless rear speakers).



10**i (Info)**

Press the button to display information about the current function. (See page 5.)





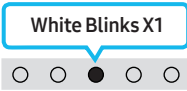

When connected to Dolby Atmos®, the LED indicator blinks cyan 3 times.

11**SOUND MODE**

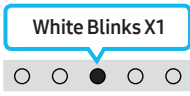
By pressing the button, you can select the desired audio mode. Each time the mode changes, the Multicolor LED blinks in white.

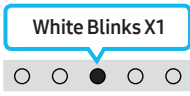
| | |
|---|--|
| LED Indicator |  |
|  | "Adaptive Sound" → "DTS Virtual:X" → "Music" → "Game" → "Standard" |

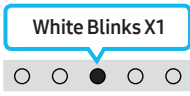
- **Adaptive Sound**
Analyzes the content in real time and automatically provides the optimal sound field based on the characteristics of the content.
- **DTS Virtual:X**
Immersive 3D sound from any content.
- **Music**
Provides more natural and room filling sound for music content.
- **Game**
Provides stereoscopic sound to immerse you in the action while gaming.
- **Standard**
Outputs the original sound.



| | | | | | |
|--|--|----------------------|---|--|--------------------------|
| <p>12</p> | <p>WOOFER (BASS) LEVEL</p> <p>Push the button up or down to adjust the level of the woofer (bass) to -12 or between -6 to +6. To set the woofer (bass) volume level to 0 (Default), press the button.</p> | | | | |
| <p>13</p> | <p>TONE CONTROL</p> <p>By pressing the button, you can adjust the volume of the treble or bass sound. The desired item can be adjusted using the Up/Down buttons. (This feature is available in all sound modes except “Standard” mode.)</p> <table border="1" data-bbox="151 311 520 478"> <tr> <td data-bbox="151 311 255 422"> <p>LED Indicator</p> </td> <td data-bbox="255 311 520 422">  </td> </tr> <tr> <td data-bbox="151 422 255 478"> <p></p> </td> <td data-bbox="255 422 520 478"> <p>“Treble” → “Bass”</p> </td> </tr> </table> | <p>LED Indicator</p> |  | <p></p> | <p>“Treble” → “Bass”</p> |
| <p>LED Indicator</p> |  | | | | |
| <p></p> | <p>“Treble” → “Bass”</p> | | | | |

Setting the (Sound Control)

- **SpaceFit Sound** : This function analyzes the user’s listening space with the Soundbar’s microphone and provides optimal sound for the space. (Refer to “**Using the SpaceFit Sound**” on page 25.)
- **Active Voice Amplifier** : Analyzes external noise in real time while Soundbar is playing so that voice audio can always be heard clearly.
 - No data is saved during the analysis.
- **Voice enhancement** makes it easier to hear spoken dialog in movies and TV.
- **Night mode** is optimized for night time viewing with the settings adjusted to bring the volume down but keep the dialog clear.
- **Sound Grouping**: The Soundbar main unit and the Surround Speakers play the entire sound instead of surround sound, making it ideal for large groups of people listening to music in a large space.
 - This menu is initially activated when the Surround Speakers are connected, and then the menu remains activated regardless of the connection of the Surround Speakers.
 - If you enable this mode, there are no differences in sounds between the Sound modes.
 - Sound does not come out from all speaker units of the Soundbar main unit and the Surround speakers, but only from certain predetermined units, which varies by model.
- **Private Rear Sound** : This mode sets the sound to come out from the Surround Speakers only, allowing you to listen without being disturbed by others.
 - If you enable this mode, sound does not come out from the Soundbar main unit and the subwoofer. Sound only comes out from the front channel of the Surround Speakers.
 - If you enable this mode, there are no differences in sounds between the Sound modes.

- The function turns off when the power turns off or the Surround Speakers connection is lost.
- The menu is activated only when the Surround Speakers are connected.
- This mode is automatically turned off and becomes unavailable when the Q-Symphony function turns on.
- If the video on the TV and audio from the Soundbar are not synchronized, select **Sync** in Sound Control, and then set the audio delay between 0~300 milliseconds by using the **Up/Down** buttons.
 - **Sync** is only supported for some functions.
- The **Virtual** function can be turned On/Off by using the **Up/Down** buttons.

Using the Hidden Buttons (Buttons with more than one function)

| Hidden Button | | Reference page |
|---|------------------------------------|----------------|
| Remote Control Button | Function | |
| WOOFER (Up) | TV remote control On/Off (Standby) | page 14 |
| Up | ID SET | page 10 |
|  (Sound Control) | 7 Band EQ | page 9 |
|  (Source) | Audio Feedback On/Off (Standby) | page 8 |

Output specifications for the different sound effect modes

| Effect | Input | Output | |
|----------------|--------------|---------------------|--|
| | | With Subwoofer Only | With Subwoofer & Wireless Rear Speaker Kit |
| Adaptive Sound | 2.0 ch | 5.1 ch | 7.1 ch |
| | 5.1 ch | 5.1 ch | 7.1 ch |
| | Dolby Atmos® | 5.1 ch | 7.1 ch |
| DTS Virtual:X | 2.0 ch | 5.1 ch | 7.1 ch |
| | 5.1 ch | 5.1 ch | 7.1 ch |
| | Dolby Atmos® | 5.1 ch | 7.1 ch |
| Music | 2.0 ch | 5.1 ch | 7.1 ch |
| | 5.1 ch | 5.1 ch | 7.1 ch |
| | Dolby Atmos® | 5.1 ch | 7.1 ch |
| Game | 2.0 ch | 5.1 ch | 7.1 ch |
| | 5.1 ch | 5.1 ch | 7.1 ch |
| | Dolby Atmos® | 5.1 ch | 7.1 ch |
| Standard | 2.0 ch | 2.1 ch | 2.1 ch |
| | 5.1 ch | 5.1 ch | 5.1ch |
| | Dolby Atmos® | 5.1 ch | 7.1 ch |

- The Samsung Wireless Rear Speaker Kit, and Subwoofer can be purchased separately. To purchase a Kit or the Subwoofer, contact the vendor you purchased the Soundbar from.
- When the input source is Dolby Atmos® the Subwoofer-only setup provides 5.1 channel audio, while the Subwoofer & Wireless Rear Speaker Kit setup provides 7.1 channel audio.

Adjusting the Soundbar volume with a TV remote control







Adjust the Soundbar volume using the TV's remote control.

- This function can be used with IR remote controls only. Bluetooth remote controls (remote controls that require pairing) are not supported.
- Set the TV speaker to **External Speaker** to use this function.
- Manufacturers supporting this function:
Samsung, VIZIO, LG, Sony, Sharp, PHILIPS, PANASONIC, TOSHIBA, Hisense, RCA

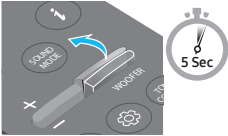
1. Turn Off the Soundbar.
2. Push up and hold the **WOOFER** button for 5 seconds.

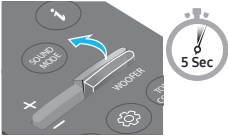
Each time you push the **WOOFER** button up and hold it for 5 seconds, the mode switches in the following order: "**Off-TV Remote**" (Default mode), "**Samsung-TV Remote**", "**All-TV Remote**".

The LED indicator status changes each time the mode is changed, as shown below.

| Remote Control Button | LED Indicator | Status |
|---|---|--|
|  | <div style="border: 1px solid cyan; padding: 2px; display: inline-block;">Red Blinks X1</div>  "Off-TV Remote" (Default mode) | Disable the TV remote control. |
|  | <div style="border: 1px solid cyan; padding: 2px; display: inline-block;">Cyan Blinks X1</div>  "Samsung-TV Remote" | Enable a Samsung TV's IR remote control. |
|  | <div style="border: 1px solid blue; padding: 2px; display: inline-block;">Blue Blinks X1</div>  "All-TV Remote" | Enable a third-party TV's IR remote control. |

04 CONNECTING THE SOUNDBAR

Connecting Electrical Power

Use the power components to connect the Soundbar to an electrical outlet in the following order:

- For more information about the required electrical power and power consumption, refer to the label attached to the product. (Label: Bottom of the Soundbar Main Unit)

1. First connect the power cable to the AC/DC adapter.
Connect the AC/DC adapter (with the power cable) to the Soundbar.
2. Connect the power cord to a wall socket.

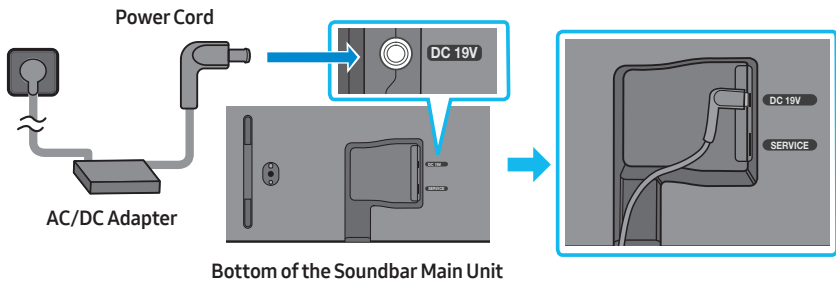

NOTES

- If you unplug and reconnect the power cord when the product is turned on, the Soundbar turns on automatically.
- Make sure to rest the AC/DC Adapter flat on a table or the floor. If you place the AC/DC Adapter so that it is hanging with the AC cord input facing upwards, water or other foreign substances could enter the Adapter and cause the Adapter to malfunction.

Connecting the Samsung Wireless Rear Kit and Subwoofer to your Soundbar

Expand to true wireless surround sound by connecting the Samsung Wireless Rear Speaker Kit (SWA-9200S, sold separately) and Wireless Subwoofer (SWA-W510, sold separately) to your Soundbar. For detailed information on connections, see the Samsung Wireless Rear Speaker Kit and Wireless Subwoofer manual.

05 CONNECTING TO A TV

Connecting the TV that supports HDMI ARC (Audio Return Channel)

⚠ CAUTION

- When both the HDMI cable and optical cable are connected, the HDMI signal is received first.
- To connect the HDMI cable between the TV and Soundbar, be sure to connect the terminals marked ARC. Otherwise, the TV sound may not be output.
- The recommended cable is an HDMI cable certified by HDMI.org.

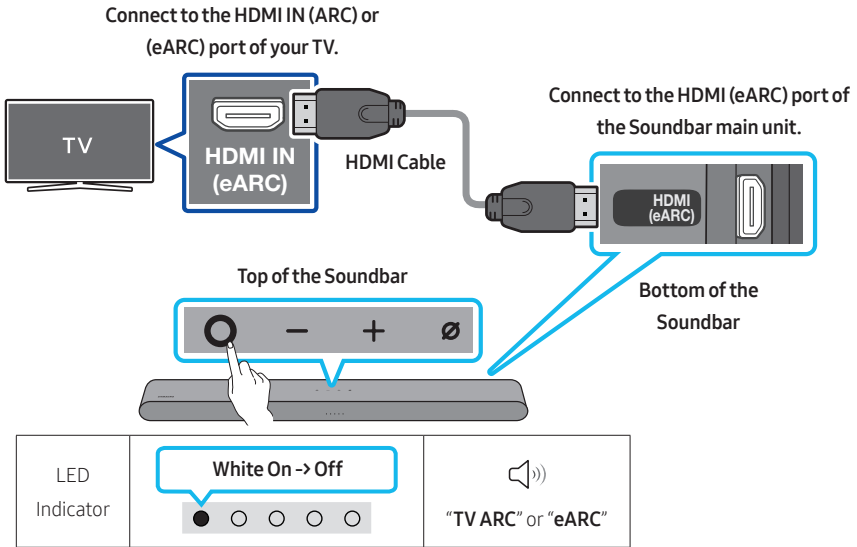

1. With the Soundbar and TV turned off, connect the HDMI cable as shown in the figure.
2. Turn on the Soundbar and TV.
3. TV sound is output from the Soundbar.
 - When the TV sound is not output, press the **○ (Multi Function)** button at the top of the Soundbar or the **☞ (Source)** button on the remote control to select the **"TV ARC"** or **"eARC"** mode.
 - To connect with eARC, the eARC function in the TV menu should be set to On. Refer to the TV user manual for details on setting. (e.g. Samsung TV : Home (🏠) → Menu → Settings (⚙) → All Settings (⚙) → Sound → Expert Settings → HDMI-eARC Mode (Auto))
 - When the sound is not output, check the HDMI Cable connection again.
 - Use the volume buttons on the TV's remote control to change the volume on the Soundbar.

NOTES

- When you connect the TV that supports the HDMI ARC (Audio Return Channel) to the Soundbar with an HDMI cable, you can transmit the digital video and audio data without connecting a separate optical cable.
- We recommend you use a coreless HDMI cable if possible. If you use a cored HDMI cable, use one whose diameter is less than 0.55 inches (14 mm).
- This function is not available if the HDMI cable does not support ARC.
- When the audio in a broadcast is encoded in Dolby Digital and the “Digital Output Audio Format” on your TV is set to PCM, we recommend that you change the setting to Dolby Digital. When the setting on the TV is changed, you will experience better sound quality. (The TV menu may use different words for Dolby Digital and PCM depending on the TV manufacturer.)

Connecting using an Optical Cable

Pre-connection Checklist

- When both the HDMI cable and optical cable are connected, the HDMI signal is received first.
- When you use an optical cable and the terminals have covers, be sure to remove the covers.

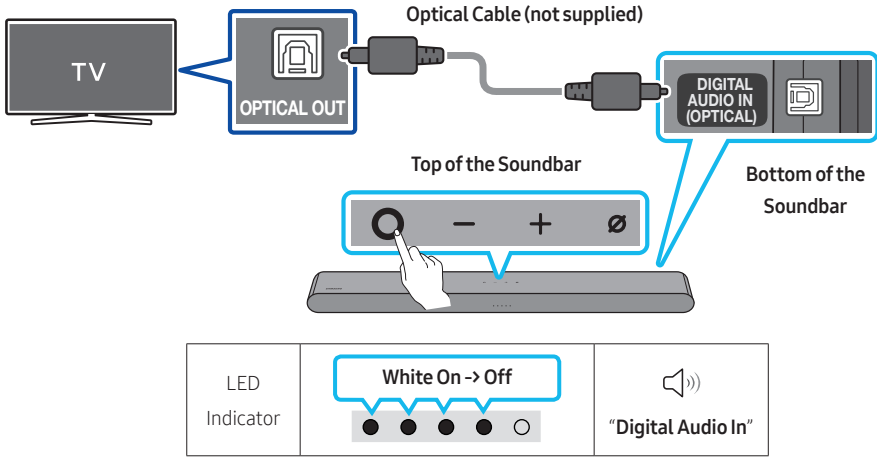

1. With the TV and Soundbar turned off, connect the **DIGITAL AUDIO IN (OPTICAL)** port on the Soundbar and the **OPTICAL** output port on the TV with the optical cable (not supplied), as shown in the figure.
2. Turn on the Soundbar and TV.
3. Press the **○ (Multi Function)** button at the top of the Soundbar or the **📡 (Source)** button on the remote control and then select the **"Digital Audio In"** mode. Then the announcement, **"Digital Audio In"** is output.
4. The TV sound is output from the Soundbar.



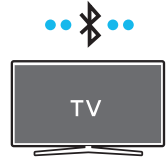

Connecting via Bluetooth

When a Samsung TV is connected using Bluetooth, you can hear stereo sound without the hassle of cable.

- Only one Samsung TV can be connected at a time.
- Samsung TV that supports Bluetooth can be connected. Check the specifications of your TV.

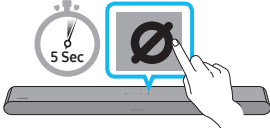

The initial connection



| | |
|--|--|
| <p>1. Bluetooth Pairing button</p>  <p>OR</p> <p>When in "Bluetooth" mode</p>  | <p>LED Indicator</p> <div data-bbox="423 483 744 603"><p>Red → Green → Blue Blinks</p><p>Pairing</p></div> <p>→</p> <div data-bbox="818 483 1021 603"><p>Cyan Blinks X3</p><p>Connection is complete</p></div> <ul style="list-style-type: none">• Until pairing is complete, the Multicolor LED changes as Red → Green → Blue in turn. <p> "Ready to connect via Bluetooth."</p> |
|--|--|

2. Select Bluetooth mode on the Samsung TV.
(e.g. Home (🏠) → Menu → Settings (⚙️) → All Settings (⚙️) → Sound → Sound Output → Bluetooth Speaker List → S-Series Soundbar (Bluetooth))
3. Select **"S-Series Soundbar"** from the list on TV's screen.
An available Soundbar is indicated with **"Need Pairing"** or **"Paired"** on the TV's Bluetooth device list. To connect the Samsung TV to the Soundbar, select the message, and then establish a connection.
4. You can now hear Samsung TV sound from the Soundbar.
 - If there is a connection log between the Soundbar and Samsung TV, the Soundbar is automatically connected by changing its mode to **"Bluetooth"**

If the device fails to connect

- If you have an existing Soundbar (e.g., **S-Series Soundbar**) on the list of speakers on the Samsung TV, delete it.
- Then repeat steps 1 through 3.

Disconnecting the Soundbar from the Samsung TV

Press the  (**Multi Function**) button at the top of the Soundbar or the  (**Source**) button on the remote control to select the mode other than “**Bluetooth**”.

- Disconnecting takes time because the Samsung TV must receive a response from the Soundbar. (The time required may differ, depending on the Samsung TV model.)

Notes on Bluetooth connection

- Locate a new device within 3.28 ft (1 m) to connect via Bluetooth communication.
- If asked for a PIN code when connecting a Bluetooth device, enter <0000>.
- The Soundbar automatically turns off after 18 minutes in the Ready state.
- The Soundbar may not perform Bluetooth search or connection correctly under the following circumstances:
 - If there is an electronic equipment or electric apparatus that can cause wireless interference around the Soundbar.
 - If several Bluetooth devices are simultaneously paired with the Soundbar.
 - If the Bluetooth device is turned off, not in place, or malfunctions.
- Electronic devices may cause radio interference. Devices that generate electromagnetic waves must be kept away from the Soundbar main unit - e.g., microwaves, wireless LAN devices, etc.
- **Precaution : The Soundbar will restart automatically if you turn on/turn off Bluetooth.**
 - Bluetooth Port deactivation method : Press the **TONE CONTROL** button on the remote control of the Soundbar for 30 seconds to turn Bluetooth On/Off.

Connecting via Wi-Fi

Pre-connection Checklist

- Wi-Fi connection is available only on Samsung TV.
- Check whether **the wireless router (Wi-Fi)** is turned on and the **TV is connected to the router**.
- The TV and Soundbar must be connected to the same wireless network (Wi-Fi).
- If your wireless router (Wi-Fi) uses a DFS channel, you will not be able to establish a Wi-Fi connection between the TV and Soundbar. Contact your Internet service provider for details.
- Because the menus may differ depending on the year of manufacture, refer to your TV manual.
- To connect the TV to the Soundbar via Wi-Fi, connect the Soundbar to the wireless router first. See page 30, for details on how to establish a Wi-Fi connection.

1. For more information about Wi-Fi connection to the Soundbar, see page 30, “**Method 2. Connecting via Wi-Fi (Wireless Network)**”.

2. Change the input source of the TV by using the Audio menu to Soundbar.

- **Samsung TVs released in 2017 or later**

Home (🏠) → Menu → Settings (⚙️) → All Settings (⚙️) → Sound → Sound Output → S-Series Soundbar (Wi-Fi)

NOTE

- **Precaution : The Soundbar will restart automatically if you turn on/turn off Wi-Fi.**
 - Wi-Fi Port deactivation method : Press the **CH LEVEL** button on the remote control of the Soundbar for 30 seconds to turn Wi-Fi On/Off.

Connecting to a TV that supports Dolby Atmos®

Pre-connection Checklist

- Dolby Atmos® is supported in "TV ARC" or "eARC" or "Wi-Fi" mode.
- Make sure that the content supports Dolby Atmos®.

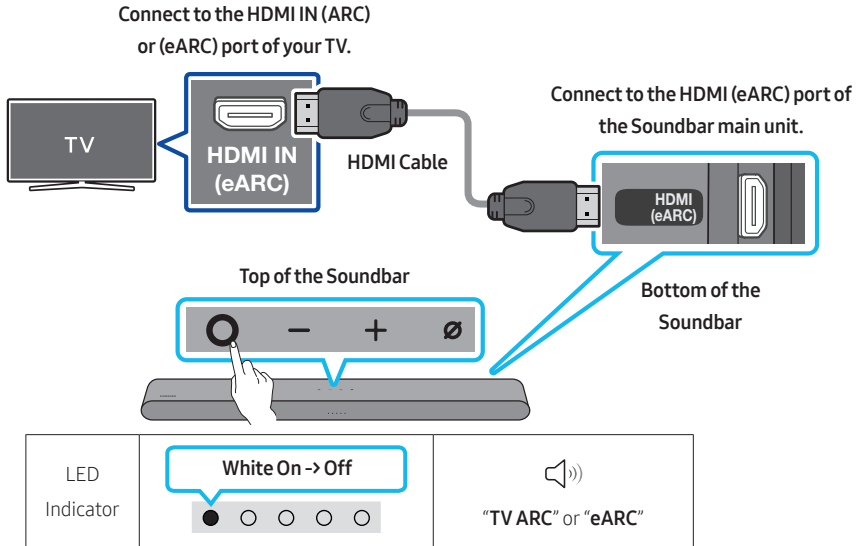

1. With the Soundbar and TV turned off, connect the HDMI cable as shown in the figure.
2. Turn on the Soundbar and TV.
3. TV sound is output from the Soundbar.

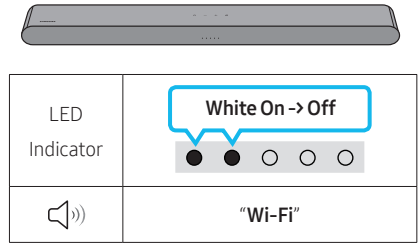
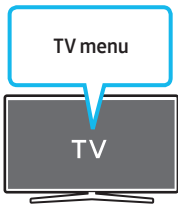

1. Connect the Soundbar and TV to the same wireless network (Wi-Fi).
2. For sound output of the TV, select Soundbar.
3. TV sound is output from the Soundbar.

NOTES

- **Configuring Dolby Atmos® on a BD player or other device connected to the TV.**

Open the audio output options on the settings menu of your BD player or other device and make sure that "No Encoding" is selected for Bitstream. For example, on a Samsung BD Player, go to Home Menu → Sound → Digital Output and then select Bitstream (unprocessed).

- **This function is available in some Samsung TVs and some Soundbar models.**

Using the Q-Symphony Function

- When the Soundbar connects to a Samsung TV that supports the Q-Symphony function, you can play the sound simultaneously through the Soundbar and the TV. If you use the Q-Symphony function, the surround sound played on the TV allows you to enjoy a richer, more three-dimensional surround sound effect.
- When the Soundbar is connected, “Q-Symphony” menu appears on the TV.
Settings (⚙️) → All Settings (⚙️) → Sound → Sound Output
- TV menu example: **Q-Symphony**

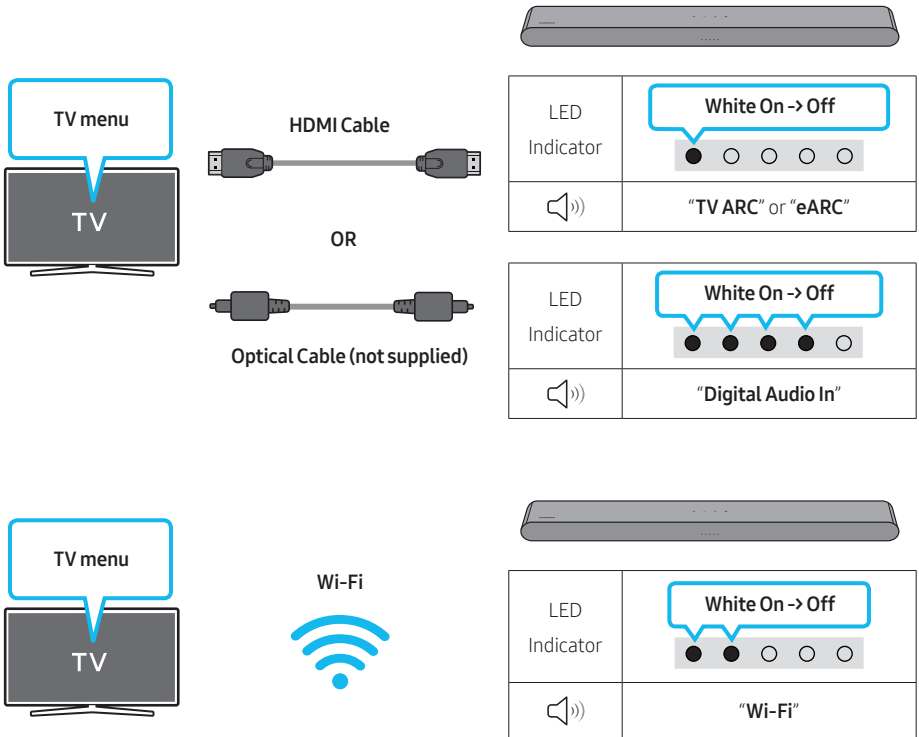

NOTES

- This function can be operated by the Codec supported by TV.
- This function is supported only when the HDMI Cable or Optical Cable (not supplied) or Wi-Fi is connected.
- The message displayed may differ with the TV model.
- Ensure that your TV and Soundbar are connected to the same wireless router/frequency.
- This function is available in some Samsung TVs and some Soundbar models.

Using the SpaceFit Sound

Provides optimized sound quality by analyzing the listening spaces.

Method 1. Connecting via Soundbar



To enable this function, turn on the SpaceFit Sound mode with the remote control of the Soundbar.

( (Sound Control) → "SpaceFit Sound Off" → ▲ (Up) → "SpaceFit Sound On")

- This is available in all Sound modes.

Method 2. Connecting via TV

To enable this function, turn on the **Adaptive Sound+** mode on your Samsung TV menu.

(Home () → Menu → Settings () → All Settings () → General → Intelligent Mode Settings → Adaptive Sound+)

- The sound mode on your Soundbar will automatically change to **Adaptive Sound+** if you enable the **Adaptive Sound+** mode on your TV.

NOTE

- This function works when the Soundbar connects to some of the Samsung TVs.

06 CONNECTING AN EXTERNAL DEVICE

Connecting using an Optical Cable

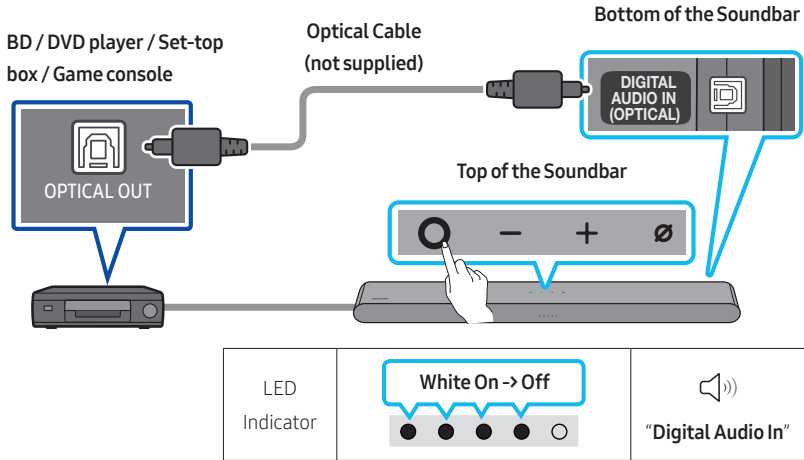

1. With the external device and Soundbar turned off, connect the **DIGITAL AUDIO IN (OPTICAL)** port on the Soundbar and the **OPTICAL** output port on the external device with the optical cable (not supplied), as shown in the figure.
2. Turn on the Soundbar and external device.
3. Press the **Multi Function** button at the top of the Soundbar or the **Source** button on the remote control and then select the **"Digital Audio In"** mode. Then the announcement, **"Digital Audio In"** is output.
4. The external device sound is output from the Soundbar.

07 CONNECTING A MOBILE DEVICE

Method 1. Connecting via Bluetooth

When a mobile device is connected using Bluetooth, you can hear stereo sound without the hassle of cable.





- When you connect a paired Bluetooth device with the Soundbar off, the Soundbar automatically turns on.



mobile device

The initial connection

- When connecting to a new Bluetooth device, make sure the device is within 3.28 ft (1 m) distance.

| 1. Bluetooth Pairing button | LED Indicator |
|---|--|
|  <p>OR</p> <p>When in "Bluetooth" mode</p>  | <div data-bbox="423 576 745 624">Red → Green → Blue Blinks</div>  <p>Pairing</p> <div data-bbox="818 576 1020 624">Cyan Blinks X3</div>  <p>Connection is complete</p> <ul style="list-style-type: none">• Until pairing is complete, the Multicolor LED changes as Red → Green → Blue in turn. <div data-bbox="474 839 514 871"></div> <p>"Ready to connect via Bluetooth."</p> |

2. On your device, select "S-Series Soundbar" from the list that appears.
3. Play music files from the device connected via Bluetooth through the Soundbar.

If the device fails to connect

- If you have an existing Soundbar (e.g., S-Series Soundbar) on the list of speakers on the Mobile device, delete it.
- Then repeat steps 1 and 2.

Notes on Bluetooth connection

- Locate a new device within 3.28 ft (1 m) to connect via Bluetooth communication.
- If asked for a PIN code when connecting a Bluetooth device, enter <0000>.
- The Soundbar automatically turns off after 18 minutes in the Ready state.
- The Soundbar may not perform Bluetooth search or connection correctly under the following circumstances:
 - If there is a strong electrical field around the Soundbar.
 - If several Bluetooth devices are simultaneously paired with the Soundbar.
 - If the Bluetooth device is turned off, not in place, or malfunctions.
- Electronic devices may cause radio interference. Devices that generate electromagnetic waves must be kept away from the Soundbar main unit - e.g., microwaves, wireless LAN devices, etc.
- The Soundbar supports SBC data (44.1kHz, 48kHz).
- Connect only to a Bluetooth device that supports the A2DP (AV) function.
- When connecting the Soundbar to a Bluetooth device, place them as close to each other as possible.
- The farther the Soundbar and Bluetooth device are from each other, the lower the sound quality will become.

The Bluetooth connection may break when the devices are out of the effective range.

- The Bluetooth connection may not function as intended in areas with poor reception.
- A Bluetooth device may experience noise or malfunction under in the following conditions:
 - When the body is in contact with the signal transceiver on the Bluetooth device or Soundbar
 - In corners or when there is an obstacle in proximity, such as a wall or partition, where electrical changes may occur.
 - When exposed to radio interferences by other products operating on the same frequency ranges, such as medical equipment, microwave ovens, and wireless LAN devices.
 - Obstacles such as doors and walls may still impact the sound quality even when the devices are within the effective range.
- Note that your Soundbar cannot be paired with other Bluetooth devices while using the Bluetooth option.
- This wireless device may cause electrical interference during operation.

Disconnecting the Bluetooth device from a Soundbar

You can disconnect a Bluetooth device from the Soundbar. For instructions, see the Bluetooth device's user manual.

- The Soundbar will be disconnected.
- If the Soundbar is disconnected from the Bluetooth device, the multicolor LED indicator on the Soundbar blinks "**Red**" three times.

Disconnecting the Soundbar from the Bluetooth device

Press the  (**Multi Function**) button at the top of the Soundbar or the  (**Source**) button on the remote control to select the mode other than "**Bluetooth**".

- Disconnecting takes time because the Bluetooth device must receive a response from the Soundbar. (Disconnection time may differ, depending on the Bluetooth device)

Method 2. Connecting via Wi-Fi (Wireless Network)

To connect a Soundbar to a mobile device via a wireless network (Wi-Fi), the **SmartThings** app is required.

The initial connection

1. Install and launch the **SmartThings** app from your mobile device (smartphone or tablet).
2. On the app, follow the screen instructions to add the Soundbar.
 - The automatic pop-up (the second screenshot below) may not show on some devices. If the pop-up window does not appear, press “+” on the **Home** screen. The Soundbar is added to the app.
 - The illustration below may differ according to the app version.

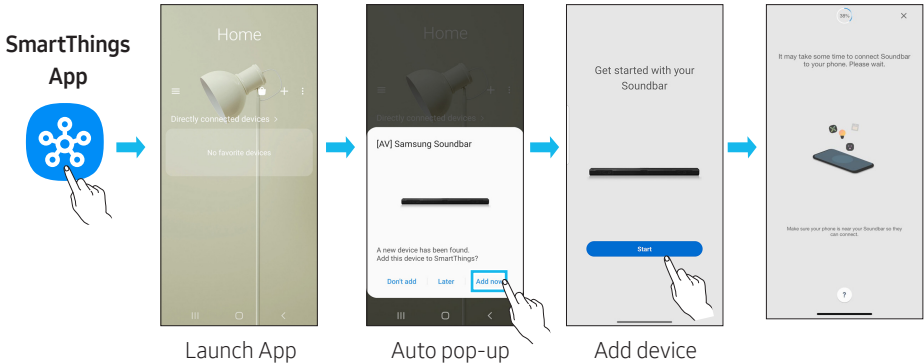

To change your Wi-Fi connection

1. Launch the **SmartThings** app from your mobile device (smartphone or tablet).
2. On the app, delete the registered Soundbar, and then add it again.

Using Group Play

- To benefit from this feature, add your Soundbar to the **SmartThings** app.
- To enable this, connect at least two audio devices to the same Wi-Fi network at 5 GHz.
- This is available on Samsung Sound devices that support Wi-Fi released year 2024 or later.
- This feature does not support TV sound.

Configuring Group Play

1. Run the **SmartThings** app on your mobile device.
2. Add the Soundbar in the **SmartThings** app according to the instructions in the “**Method 2. Connecting via Wi-Fi (Wireless Network)**” → “**Steps 2 (Device registration)**” section.
3. Tap the Soundbar’s card.
4. On your mobile device, tap **Create Group** under the audio device icon.
 - **Create Group** button appears only when Soundbar is in Wi-Fi mode.
 - If the Soundbar is playing the TV sound, the connection to the TV is disconnected when creating a group.
5. Enable **Group Play**.
6. Select a desired device in the list, and tap **Apply**.
 - You can add a maximum of 4 devices.
 - With **Group Play**, the audio will be output through the host device alone.
 - When a device connected to the host device switches to a different source, the device will be deleted from the group automatically.
 - When the host device is connected to a TV, the generated group will be deleted automatically.

Disabling Group Play

1. Tap the audio device’s card.
2. On your mobile device, tap **Edit Group** under the audio device icon.
3. Disable **Group Play**.
 - To disable an individual device, uncheck the device from the list and tap **Apply**.

Connecting via Apple AirPlay

- This feature may not be available in some countries.
- This Samsung Soundbar supports AirPlay® and requires iOS 13.4 or later.
- To enable AirPlay in your Soundbar, you must first register the device with the Samsung **SmartThings** app by agreeing with the app's terms and conditions.
- Make sure the Soundbar is powered on and connected to the same Wi-Fi network as your Apple® device.

With AirPlay, you can stream music, podcasts, and other audio from your Apple devices to the Samsung Soundbar.

- Select  from an AirPlay-supported app or Control Center on your iPhone®, iPad®, or Mac®.
- Select the Soundbar from the list of available devices to play the current audio to.

Using the Tap Sound

Tap the Soundbar with your mobile device to play audio from the mobile device through the Soundbar.

- This function may not be supported depending on the mobile device.
- This function is only compatible with Samsung mobile devices with Android 8.1 or later.

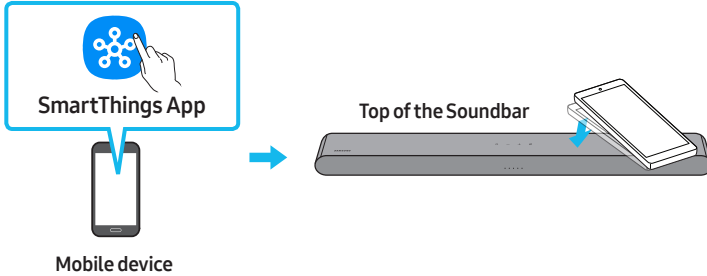

1. Turn on the **Tap Sound** function on your mobile device.
 - For details on how to turn on the function, refer to “**Enable the Tap Sound function**” below.
2. Tap the Soundbar with the mobile device. Select “**Start now**” in the displayed message window. A connection is established between the mobile device and Soundbar via Bluetooth.
3. Play audio from the mobile device through the Soundbar.
 - This function connects a mobile device to the Soundbar via Bluetooth by detecting vibration that occurs when the device touches the Soundbar.
 - Make sure the mobile device does not tap a sharp corner of the Soundbar. The Soundbar or mobile device may become scratched or damaged.
 - It is recommended that the mobile device be covered with a case. Lightly tap the wide area in the upper portion of the Soundbar, without using excessive force.
 - To use this function, update the **SmartThings** app to the latest version. The function may not be supported, depending on the app version.

Enable the Tap Sound function

Use the **SmartThings** app to turn on the **Tap View, Tap Sound** function.

1. On the mobile device, run the **SmartThings** app.
2. Select (☰ → ⚙) in the **SmartThings** app screen displayed on the mobile device.
3. Set “**Tap View, Tap Sound**” to On to allow the function to work when a mobile device moves close to the Soundbar.

NOTES

- When the mobile device is in power-saving mode, the **Tap Sound** function does not work.
- The **Tap Sound** function may not work if there are devices near the Soundbar that cause radio interference such as electric devices. Make sure devices that may cause radio interference are placed at a sufficient distance away from the Soundbar.

08 INSTALLING THE WALL MOUNT

Installation Precautions

- Install on a vertical wall only.
- Do not install in a place with high temperature or humidity.
- Verify whether the wall is strong enough to support the product's weight. If not, reinforce the wall or choose another installation point.
- Purchase and use the fixing screws or anchors appropriate for the kind of wall you have (plaster board, iron board, wood, etc.). If possible, fix the support screws into wall studs.
- Purchase wall mounting screws according to the type and thickness of the wall you want to mount the Soundbar on.
 - Diameter: M5
 - Length: 1 3/8 inches (35 mm) or longer recommended.
- Connect cables from the unit to external devices before you install the Soundbar on the wall.
- Make sure the unit is turned off and unplugged from the power source before you install it. Otherwise, it may cause an electric shock.

Wallmount Components



Wall Mount Guide (AH81-15186A)



x 2



x 2

(M4 x L10)

Holder-Screw

(AH61-04110A)

Screw

(6001-001202)



x 2

Bracket-Wall Mount (AH61-04235A)

1. Place the **Wall Mount Guide** against the wall surface.
 - The **Wall Mount Guide** must be leveled.
 - If your TV is mounted on the wall, install the Soundbar at least 2 inches (5 cm) below the TV.



TV



2 inches (5 cm) or more

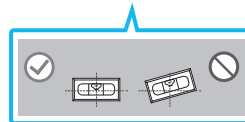

2. Align the **Wall Mount Guide's Center Line** with the center of your TV (if you are mounting the Soundbar below your TV), and then fix the **Wall Mount Guide** to the wall using tape.

- If you are not mounting below a TV, place the **Center Line** in the center of the installation area.

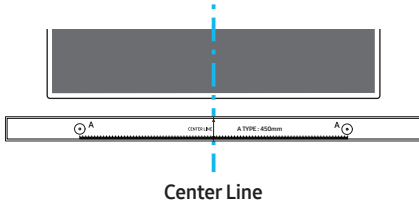

3. Use a pen to mark the positions of the holes and remove the **Wall Mount Guide**.

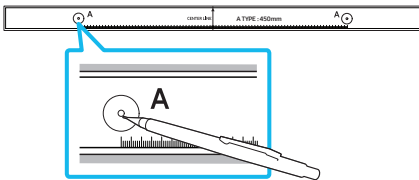

4. Using an appropriately sized drill bit, drill a hole in the wall at each marking.

- If the markings do not correspond to the positions of studs, make sure you insert appropriate anchors into the holes before you insert the support screws. If you use anchors, make sure the holes you drill are large enough for the anchors you use.

5. Push the screw (not supplied) through each **Holder-Screw**, and then screw each screw firmly into a support screw hole.

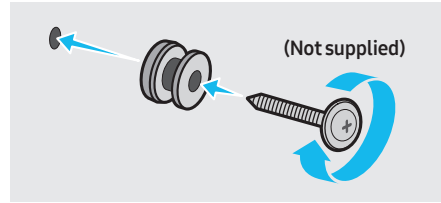

6. Install the 2 **Bracket-Wall Mounts** in the correct orientation on the bottom of the Soundbar using 2 **Screws**.

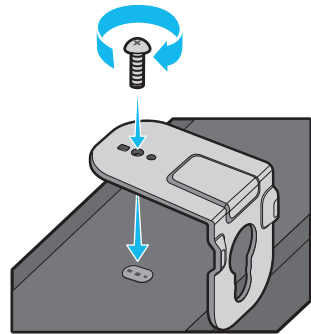

- When assembling, make sure the hanger part of the **Bracket-Wall Mounts** are located behind the rear of the Soundbar.

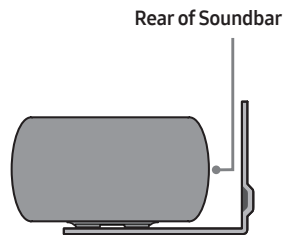

Right end of Soundbar

- The actual product may look different from the above image, depending on the model.

7. Install the Soundbar with the attached **Bracket-Wall Mounts** by hanging the **Bracket-Wall Mounts** on the **Holder-Screws** on the wall.

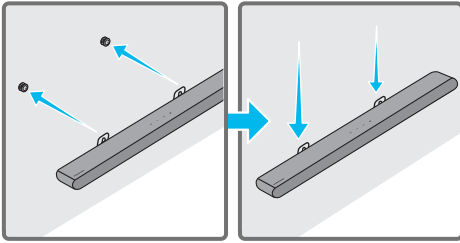

8. Slide the Soundbar down as shown below so that the **Bracket-Wall Mounts** rest securely on the **Holder-Screws**.
- Insert the **Holder-Screws** into the wide (bottom) part of the **Bracket-Wall Mounts**, and then slide the **Bracket-Wall Mounts** down so that the **Bracket-Wall Mounts** rest securely on the **Holder-Screws**.

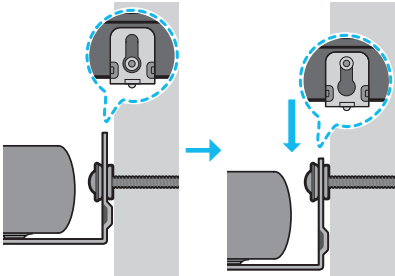

09 INSTALLING THE SOUNDBAR IN FRONT OF TV

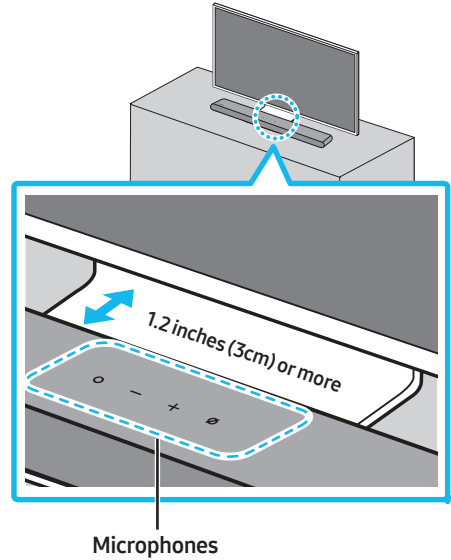

Align the center of the Soundbar to the center of the TV as illustrated in the image. At the same time, place the Soundbar at least 1.2 inches (3cm) away from the TV so that there is no interference with voice recognition.

NOTES

- Make sure the Soundbar is placed on a flat and solid surface.
- Insufficient gap between the TV and Soundbar may cause voice recognition and acoustic problems.

10 SOFTWARE UPDATE

Auto Update

When the Soundbar is connected to the Internet, software updates automatically occur even when the Soundbar is turned off.

- To use the Auto Update function, the Soundbar must be connected to the Internet. The Wi-Fi connection to the Soundbar will be terminated if the Soundbar's power cord is disconnected or the power is cut off. If the power is cut off, when the power comes back on or you reconnect the power cord, turn on the Soundbar, and then reconnect it to the Internet.

USB Update

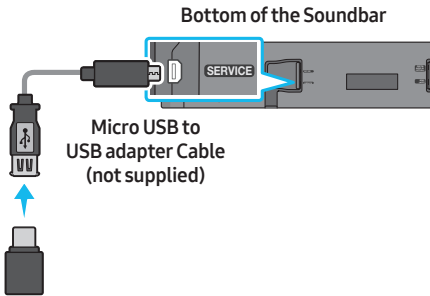

Samsung may offer updates for the Soundbar's system firmware in the future.

When an update is available, you can update the Soundbar by connecting the USB drive that contains the update firmware to the **SERVICE** port of the Soundbar.

- Go to (www.samsung.com) → search for the model name from the customer support menu option.
 - For more information about update, refer to Upgrade Guide.
- Download the upgrade file (USB type).
- Unzip the file to create a folder with the file name.
- Store the created folder in a USB and then connect it to the Soundbar.
- Turn on the Soundbar. Then the product is updated within 3 minutes.

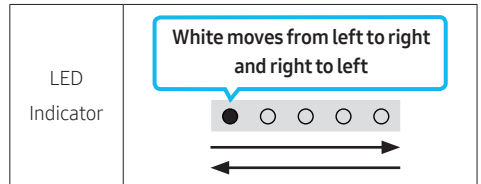

- During update, do not turn it off or remove the USB.
- If the yellow LED is on after the software update is completed, this means that an additional update is in progress. When this happens, don't turn off the power or remove the USB.
- If update does not proceed, reconnect the Soundbar power cord.
- When the latest version is installed, no update is performed.
- Depending on the USB type, update may not be supported.
- If there is no update file available

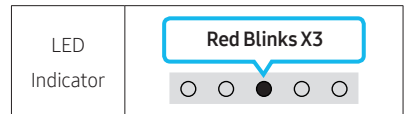

- If the update file is for the same version or lower

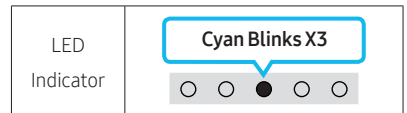

Reset

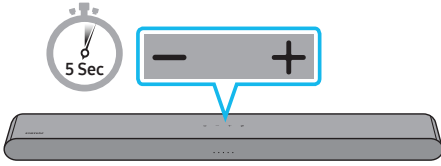

With the Soundbar on, press the **— + (Volume)** buttons on the body at the same time for at least 5 seconds. The LED display changes as shown below and then the Soundbar is reset.

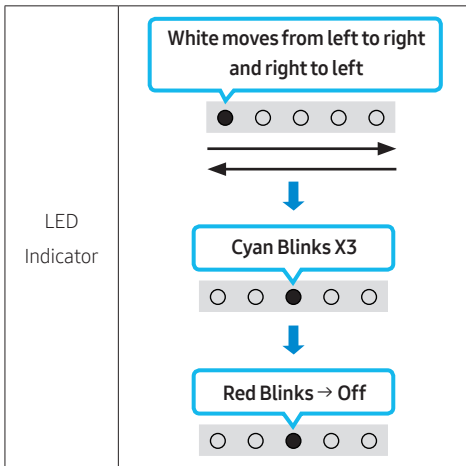

CAUTION

- All the settings of the Soundbar are reset. Be sure to perform this only when a reset is required.

Security updates information

Security updates are provided to strengthen the security of your device and protect your personal information. For more information on security updates, visit <https://security.samsungtv.com>.

- The website supports only some languages.

11 TROUBLESHOOTING

Refer to the instructions below if this product does not function properly. If the problem you are experiencing is not listed below or if the instructions below do not help, turn off the product, disconnect the power cord, and contact Samsung Electronics at 1-800-SAMSUNG (1-800-726-7864).

Soundbar does not turn on.

- Check whether the power cord of the Soundbar is correctly inserted into the outlet.

Soundbar works erratically.

- After removing the power cord, insert it again.
- Power cycle the external device and try again.
- If there is no signal, the Soundbar automatically turns off after a certain period of time. Turn on the power. (See page 8.)

Remote control does not work.

- Point the remote directly at the Soundbar.
- Replace the batteries with new ones.

The red LED indicator light on the Soundbar stays on.

- The microphone is turned off. Turn on the microphone. (See page 6.)

The Soundbar does not output any sound.

- The volume of the Soundbar is too low or muted. Adjust the volume.
- When any external device (STB, Bluetooth device, mobile device, etc.) is connected, adjust the volume of the external device.
- For sound output of the TV, select Soundbar. (Samsung TV: Home (🏠) → Menu → Settings (⚙️) → All Settings (⚙️) → Sound → Sound Output → Select Soundbar)
- The cable connection to the Soundbar may not be loose. Remove the cable and connect again.
- Remove the power cord completely, reconnect, and turn the power on.
- Reset the product and try again. (See page 38.)

If the TV is not connected via HDMI (eARC).

- Check whether the HDMI cable is correctly connected to the eARC terminal. (See page 16)
- Connection may not be possible due to the connected external device (set-top box, game console, etc.). Directly connect the Soundbar.
- HDMI-CEC may not be activated on the TV. Turn on the CEC on the TV menu. (Samsung TV: Home (🏠) → Menu → Settings (⚙️) → All Settings (⚙️) → Connection → External Device Manager → Anynet+ (HDMI-CEC) ON)

There is no sound in when connecting to the TV in HDMI (eARC) mode.

- Your device is unable to play the input signal. Change the TV's audio output to PCM or Dolby Digital.
(For a Samsung TV: Home (🏠) → Menu → Settings (⚙️) → All Settings (⚙️) → Sound → Expert Settings → Digital Output Audio Format)

The Soundbar will not connect via Bluetooth.

- When connecting a new device, switch to Bluetooth Pairing for connection. (Press the **PAIR** button on the remote control or press the **⊘ (Mic On/Off)** button on the body for at least 5 seconds.)
- If the Soundbar is connected to another device, disconnect that device first to switch the device.
- Reconnect it after removing the Bluetooth speaker list on the device to connect.
(Samsung TV: Home (🏠) → Menu → Settings (⚙️) → All Settings (⚙️) → Sound → Sound Output → Bluetooth Speaker List)
- Remove and reconnect the power plug, then try again.
- Reset the product and try again.
(See page 38.)

The sound drops out when connected via Bluetooth.

- Some devices can cause radio interference if they are located too close to the Soundbar. e. g. microwaves, wireless routers, etc.
- If your device that is connected via Bluetooth moves too far away from the Soundbar, it may cause the sound to drop out. Move the device closer to the Soundbar.
- If a part of your body is in contact with the Bluetooth transceiver or the product is installed on metal furniture, the sound may drop out. Check the installation environment and conditions for use.

Unable to connect to Wi-Fi.

- Check whether your wireless router is on.
- Turn off the router, turn it back on, and then try again.
- The Soundbar will not connect if the wireless signal is too weak. Try moving the router closer to the Soundbar, or eliminating any obstacles that are between the Soundbar and the router, if possible.
- If your wireless router is new, you will need to reconfigure the speaker's network settings.
- Soundbar does not support Wi-Fi 6.

The Soundbar does not turn on automatically with the TV.

- When you turn off the Soundbar while watching TV, power synchronization with the TV is disabled. First turn off the TV.

The AVA function is not available in the following cases.

- The AVA function will not be available using Q-Symphony function.
- The AVA function will not be available when the microphone is turned off.

After connecting the TV to the Soundbar, I switched the Soundbar mode. Then no sound is output from the TV.

- If you connect your Soundbar to a mobile device while the Soundbar is connected to the TV, the Soundbar outputs sound from the mobile device while keeping the TV connection. So the TV sound will not be delivered anywhere.
- Disconnect the mobile device, and the TV sound will be output from the Soundbar again.

The Soundbar does not appear in AirPlay.

- To enable AirPlay in your Soundbar, you must first register the device with the Samsung **SmartThings** app by agreeing with the app's terms and conditions. (See page 32.)
- AirPlay does not operate if you delete the Soundbar from the Samsung **SmartThings** app.
- Make sure that the Soundbar and the Apple device are connected to the same Wi-Fi network.
- The Soundbar is compatible with AirPlay installed on iOS 13.4 or later.

Group Play is not enabled.

- Check if the audio devices are newer models released year 2024 or later.
- Check if the host device is connected to a Wi-Fi network as source.
- Make sure that all audio devices are connected to the same Wi-Fi network (at 5 GHz).

12 LICENSE



Dolby, Dolby Atmos, and the double-D symbol are registered trademarks of Dolby Laboratories Licensing Corporation. Manufactured under license from Dolby Laboratories. Confidential unpublished works. Copyright © 2012-2021 Dolby Laboratories. All rights reserved.



For DTS patents, see <http://patents.dts.com>. Manufactured under license from DTS, Inc. or DTS Licensing Limited. DTS, Digital Surround, Virtual:X, and the DTS logo are registered trademarks or trademarks of DTS, Inc. in the United States and other countries. © 2021 DTS, Inc. ALL RIGHTS RESERVED.



The terms HDMI, HDMI High-Definition Multimedia Interface, HDMI Trade dress and the HDMI Logos are trademarks or registered trademarks of HDMI Licensing Administrator, Inc.



- Use your phone, tablet or computer as a remote control for Spotify. Go to spotify.com/connect to learn how
- The Spotify Software is subject to third party licenses found here :
<https://www.spotify.com/connect/third-party-licenses>.



Apple, AirPlay, iPad, iPhone, and Mac are trademarks of Apple Inc., registered in the U.S. and other countries and regions.

roon
TESTED

Being Roon Tested means that Samsung and Roon have collaborated to ensure you have the best experience using Roon software and Samsung equipment together, so you can just enjoy the music.

Open Source License Notice

Open Source used in this product can be found on the following webpage (<http://opensource.samsung.com>).
