



Contact SAMSUNG WORLD WIDE

If you have any questions or comments relating to Samsung products, please contact the SAMSUNG customer care centre.

Country	Customer Care Centre ☎	Web Site
EIRE	0818 717100	www.samsung.com/ie/support
U.K	0330 SAMSUNG (7267864)	www.samsung.com/uk/support



# LED TV

## user manual



Thank you for purchasing this Samsung product.

To receive more complete service, please register your product at [www.samsung.com/register](http://www.samsung.com/register)

Model \_\_\_\_\_ Serial No. \_\_\_\_\_

'This Nanum Gothic Eco font is provided by NAVER'

© 2014 Samsung Electronics Co., Ltd. All rights reserved.



BN68-06327F-00



## Warning! Important Safety Instructions

(Please read the appropriate section that corresponds to the marking on your Samsung product before attempting to install the product.)

### CAUTION

#### RISK OF ELECTRIC SHOCK DO NOT OPEN

CAUTION: TO REDUCE THE RISK OF ELECTRIC SHOCK, DO NOT REMOVE COVER (OR BACK). THERE ARE NO USER SERVICEABLE PARTS INSIDE. REFER ALL SERVICING TO QUALIFIED PERSONNEL.



This symbol indicates that high voltage is present inside. It is dangerous to make any kind of contact with any internal part of this product.



This symbol alerts you that important literature concerning operation and maintenance has been included with this product.

The slots and openings in the cabinet and in the back or bottom are provided for necessary ventilation. To ensure reliable operation of this apparatus, and to protect it from overheating, these slots and openings must never be blocked or covered.

- Do not cover this apparatus in a confined space, such as a bookcase or built-in cabinet, unless proper ventilation is provided.
- Do not place this apparatus near or over a radiator or heat resistor, or where it is exposed to direct sunlight.
- Do not place a vessel containing water (vases etc.) on this apparatus, as this can result in a risk of fire or electric shock.

Do not expose this apparatus to rain or place it near water (near a bathtub, washbowl, kitchen sink, or laundry tub, in a wet basement, or near a swimming pool etc.). If this apparatus accidentally gets wet, unplug it and contact an authorised dealer immediately. Make sure to pull out the power cord from the outlet before cleaning.

This apparatus use batteries. In your community there might be regulations that require you to dispose of these batteries properly under environmental considerations. Please contact your local authorities for disposal or recycling information.

Do not overload wall outlets, extension cords or adaptors beyond their capacity, since this can result in fire or electric shock.

Power-supply cords should be routed so that they are not likely to be walked on or pinched by items placed upon or against them, paying particular attention to cords at plug end, adaptors and the point where they exit from the appliance.

To protect this apparatus from a lightning storm, or when it is left unattended and unused for long periods of time, unplug it from the wall outlet and disconnect the antenna or cable system. This will prevent damage to the set due to lightning and power line surges.

Before connecting the AC power cord to the DC adaptor outlet, make sure the voltage designation of the DC adaptor corresponds to the local electrical supply.

Never insert anything metallic into the open parts of this apparatus. Doing so may create a danger of electric shock.

To avoid electric shock, never touch the inside of this apparatus. Only a qualified technician should open this apparatus.

Make sure to plug the power cord in until it is firmly inserted. When removing the power cord, make sure to hold the power plug when pulling the plug from the outlet. Do not touch the power cord with wet hands.

If this apparatus does not operate normally - in particular, if there are any unusual sounds or smells coming from it - unplug it immediately and contact an authorised dealer or service centre.

Be sure to pull the power plug out of the outlet if the TV is to remain unused or if you are to leave the house for an extended period of time (especially when children, elderly or disabled people will be left alone in the house).

- Accumulated dust can cause an electric shock, an electric leakage or a fire by causing the power cord to generate sparks and heat or the insulation to deteriorate.

Be sure to contact an authorised service centre, when installing your set in a location with heavy dust, high or low temperatures, high humidity, chemical substances and where it operates for 24 hours such as the airport, the train station etc. Failure to do so may cause serious damage to your set.

Use only a properly grounded plug and receptacle.

- An improper ground may cause electric shock or equipment damage. (Class I Equipment only.)

To disconnect the apparatus from the mains, the plug must be pulled out from the mains socket, therefore the mains plug shall be readily operable.

Do not allow children to hang onto the product.

Store the accessories (battery, etc.) in a location safely out of the reach of children.

Do not install the product in an unstable location such as a shaky self, a slanted floor or a location exposed to vibration.

Do not drop or impart any shock to the product. If the product is damaged, disconnect the power cord and contact a service centre.

Unplug the power cord from the power outlet and wipe the product using a soft, dry cloth. Do not use any chemicals such as wax, benzene, alcohol, thinners, insecticide, aerial freshener, lubricant or detergent. This may damage the appearance or erase the printing on the product.

Apparatus shall not be exposed to dripping or splashing.

Do not dispose of batteries in a fire.

Do not short circuit, disassemble or overheat the batteries.

Danger of explosion if battery is incorrectly replaced. Replace only with the same or equivalent type.

WARNING - TO PREVENT THE SPREAD OF FIRE, KEEP CANDLES OR OTHER OPEN FLAMES AWAY FROM THIS PRODUCT AT ALL TIMES.



# Features of your new TV

## 3D

This new feature enables you to view 3D content.

## SMART HUB

This TV features Smart Hub, a multi-purpose entertainment and family centre. With Smart Hub, users can surf the web, download applications, and stay in touch with family and friends through social networking services. In addition, you can enjoy photo, video, and music files stored on external storage devices.

Run the Smart Hub. Choose a service using the displayed panels.

**Games:** You can view all game apps provided by Smart Hub and download and play a desired game. In addition, you can manage games that you have downloaded or purchased with your Samsung Account.

**SAMSUNG APPS:** Download and install applications such as Web Browser.

**On TV:** On TV recommends TV programmes based on their popularity or your personal preferences (Depending on the country).

**FILMS AND TV SHOWS:** Purchase and watch movies and series without a separate external device (Depending on the country).

**MULTIMEDIA:** Play photo, video and music files from all compatible devices.

## Anynet+ (HDMI-CEC)

This allows you to control all connected Samsung devices that support Anynet+ with your Samsung TV's remote control.

## e-Manual

Provides a detailed, on-screen user manual built into your TV. (page 22)

\* The figures and illustrations in this User Manual are provided for reference only and may differ from the actual product appearance. The product design and specifications may change without notice. CIS languages (Russian, Ukrainian, Kazakhs) are not available for this product, since this is manufactured for customers in the EU region.

# Contents

## 01 What's in the Box?

## 02 Assembling the TV

- 7 Attaching the TV to the Stand
- 7 Mounting the TV on the Wall Using the Wall Mount Kit (Optional)
- 9 Providing Proper Ventilation for Your TV
- 10 Securing the TV to the Wall
- 10 Arrange the cables using the Cable Holder

## 03 Connections and Remote Control

- 11 Connecting devices to your TV
- 12 Connecting to a Network
- 14 Connecting to a COMMON INTERFACE slot (Your TV viewing Card Slot)
- 17 Remote Control

## 04 Performing the initial setup

- 18 Turning on the TV
- 19 Initial setup

## 05 Selecting Connected Devices

- 21 Controlling External Devices with the TV Remote (**Universal Remote Setup**)

## **06 Getting more details.**

- 22 Viewing more TV features

## **07 Troubleshooting and Maintenance**

- 24 Troubleshooting
- 25 Cautions about the Eco Sensor and Screen Brightness
- 26 What is Remote Support?
- 26 Storage and Maintenance

## **08 Specifications and other information**

- 27 TV Specifications
- 29 Licences
- 31 Warranty Card

# 01 What's in the Box?

Remote Control & Batteries (AAA x 2)  
User Manual

Regulatory Guide  
Power Cord



CI Card Adapter



IR Extender Cable



Cable Holder

- Please make sure the following items are included with your TV. If any items are missing, contact your dealer.
- The items' colours and shapes may vary depending on the models.
- Cables not included can be purchased separately.
- Check for any accessories hidden behind or in the packing materials when opening the box.

An administration fee may be charged if either

(a) an engineer is called out at your request and there is no defect with the product (i.e. where the user manual has not been read).

(b) you bring the unit to a repair centre and there is no defect with the product (i.e. where the user manual has not been read).

You will be informed of the administration fee amount before a technician visits.



**Warning:** Screens can be damaged from direct pressure when handled incorrectly. We recommend lifting the TV at the edges, as shown.



# 02 Assembling the TV

## Attaching the TV to the Stand

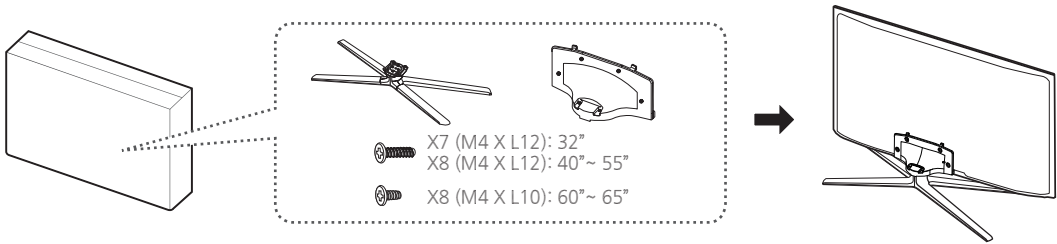

Make sure you have all the accessories shown, and that you assemble the stand following the provided assembly instructions.

## Mounting the TV on the Wall Using the Wall Mount Kit (Optional)



If you mount this product on a wall, it should be mounted only as recommended by the manufacturer. Unless it is correctly mounted, the product may slide or fall, causing serious injury to a child or adult, and serious damage to the product.

### Installing the Wall Mount Kit

The wall mount kit (sold separately) lets you mount the TV on the wall.

For detailed information about installing the wall mount, refer to the instructions provided with the wall mount. We recommend that you contact a technician for assistance when installing the wall mount bracket. We do not advise you to do it yourself. Samsung Electronics is not responsible for any damage to the product or injury to yourself or others if you select to install the wall mount on your own.

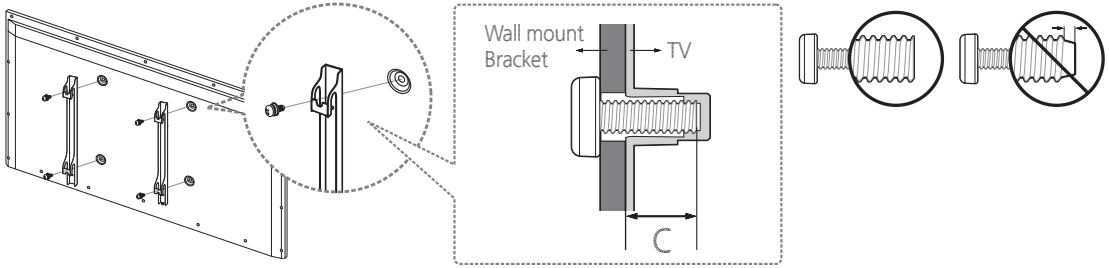

## Wall Mount Kit Specifications (VESA)

The wall mount kit is not supplied, but is sold separately. Install your wall mount on a solid wall perpendicular to the floor. When attaching the wall mount to other building materials, please contact your nearest dealer. If the product is installed on a ceiling or slanted wall, it may fall and result in severe personal injury.

- Standard dimensions for wall mount kits are shown in the table below.
- When purchasing our wall mount kit, a detailed installation manual and all parts necessary for assembly are provided.
- Do not use screws that do not comply with the VESA standard screw specifications.
- Do not use screws that are longer than the standard dimension or do not comply with the VESA standard screw specifications. Screws that are too long may cause damage to the inside of the TV set.
- For wall mounts that do not comply with the VESA standard screw specifications, the length of the screws may differ depending on the wall mount specifications.
- Do not fasten the screws that are too strongly; this may damage the product or cause the product to fall, leading to personal injury. Samsung is not liable for these kinds of accidents.
- Samsung is not liable for product damage or personal injury when a non-VESA or non-specified wall mount is used or the consumer fails to follow the product installation instructions.
- Do not mount the TV at more than a 15 degree tilt.

When using a third-party wall mount, note that the assembling screw length(C) is shown below.

Product Family	Inches	VESA Spec. (A * B)	C (mm)	Standard Screw	Quantity
LED-TV	32	200 X 200	19.8 ~ 20.8	M8	4
	40		20 ~ 21		
	48	400 X 400	20.7 ~ 21.7		
	50		20.6 ~ 21.6		
	55		20.3 ~ 21.3		
	60		21 ~ 22		

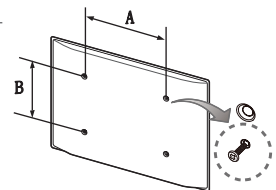

Do not install your Wall Mount Kit while your TV is turned on. It may result in personal injury due to electric shock.

# Providing Proper Ventilation for Your TV

When you install your TV, maintain a distance of at least 10 cm between the TV and other objects (walls, cabinet sides, etc.) to ensure proper ventilation. Failing to maintain proper ventilation may result in a fire or a problem with the product caused by an increase in its internal temperature.

If you use parts provided by another manufacturer, it may cause difficulties with the product or result in injury caused by the product falling.

- Whether you install your TV using a stand or a wall-mount, we strongly recommend you use parts provided by Samsung Electronics only.

Installation with a stand.

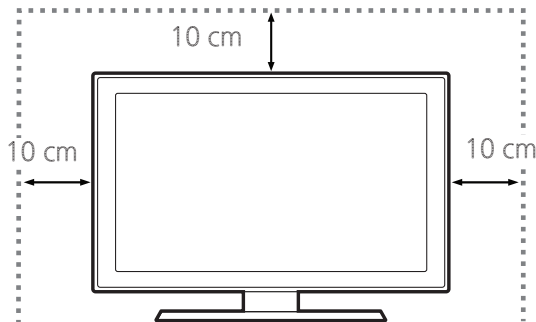

Installation with a wall-mount.

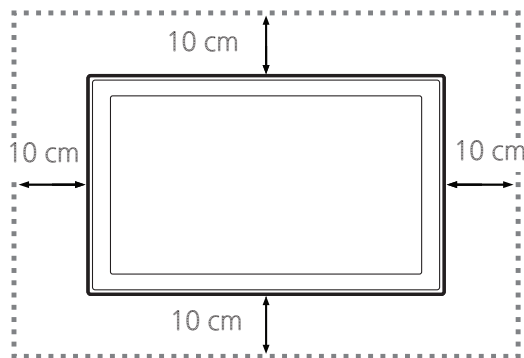

## Other Cautions

- The actual appearance of the TV may differ from the images in this manual, depending on the model.
- Be careful when you touch the TV. Some parts can be somewhat hot.

# Securing the TV to the Wall



Caution: Pulling, pushing, or climbing on the TV may cause the TV to fall. In particular, ensure that your children do not hang on to or destabilize the TV. Doing so may cause the TV to tip over, resulting in serious injuries or death. Follow all safety precautions provided in the Safety Flyer included with your TV. For added stability and safety, you can purchase and install the anti-fall device as described below.

## To Avoid the TV from Falling

- Put the screws into the clamps and firmly fasten them into the wall. Confirm that the screws have been firmly installed into the wall.
  - You may need additional material such as anchors depending on the type of wall.
  - Since the necessary clamps, screws, and string are not supplied, please purchase these additionally.
- Remove the screws from the centre back of the TV, put the screws into the clamps, and then fasten the screws into the TV again.
  - Screws may not be supplied with the product. In this case, please purchase screws of the following specifications.
  - Screw Specifications: For a 32 ~ 60 inches: M8
- Connect the clamps fixed into the TV and the clamps fixed onto the wall with a strong cable and then tie the string tightly.
  - Install the TV close to the wall so that it does not fall backwards.
  - It is safe connecting the string so that the clamps fixed onto the wall are equal to or lower than the clamps fixed on the TV.
  - Untie the string before moving the TV.
- Verify that all connections are properly secured. Periodically check connections for any sign of damage. If you have any doubt about the security of your connections, contact a professional installer.

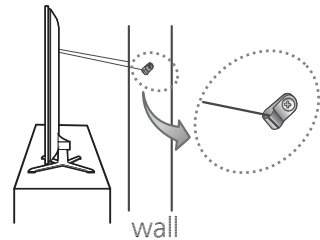
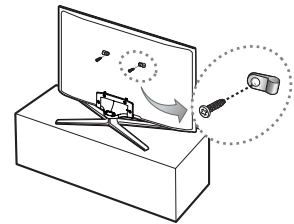

- The product colour and shape may vary depending on the model.

## Arrange the cables using the Cable Holder

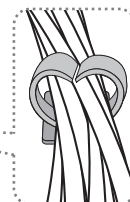
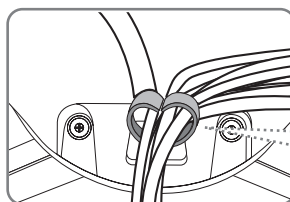
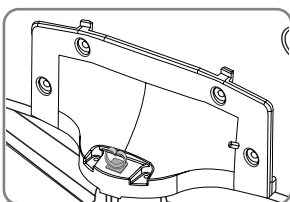

# 03 Connections and Remote Control

## Connecting devices to your TV

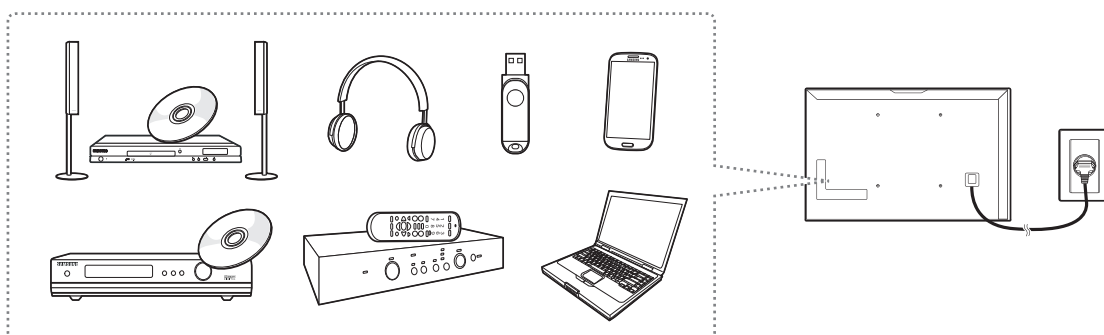

You can connect various external devices using the connectors located at the back of the product. Check the connectors and then refer to the Quick Guide for more instructions on supported external devices.

# Connecting to a Network

Connecting the TV to a network gives you access to online services such as the Smart Hub, as well as software updates.

- The shape of the rear panel differs among the models.

## Network Connection - Wireless

Connect the TV to the Internet using a standard router or modem.

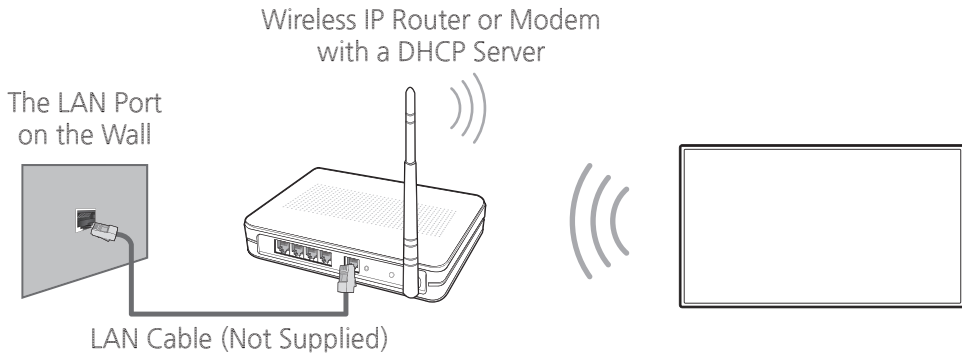

## Network Connection - Wired

There are three main ways to connect your TV to your network using cable, depending on your network setup. They are illustrated starting below:

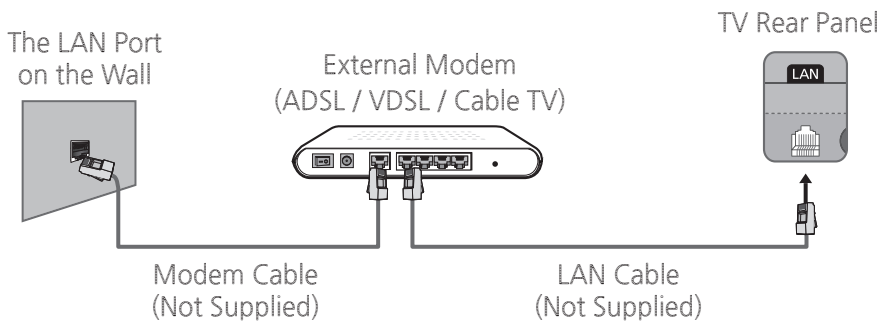

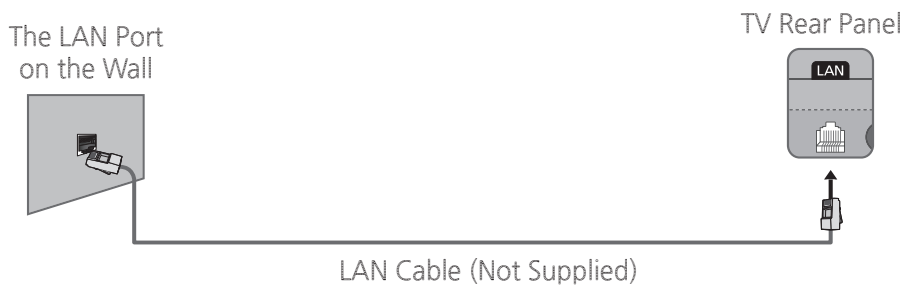
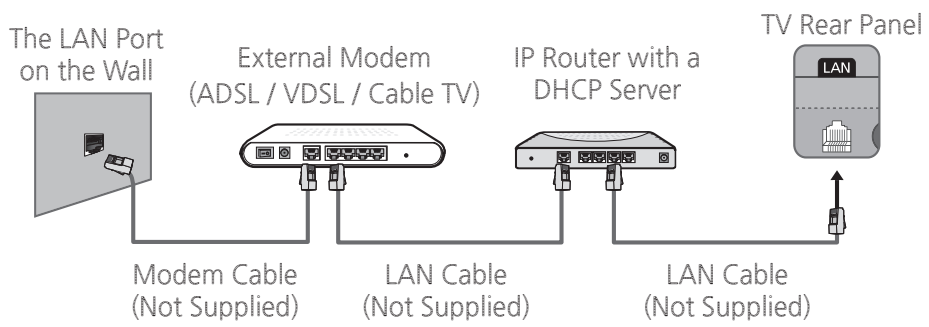

- The TV does not support network speeds less than or equal to 10Mbps.
- Use Cat 7 cable for the connection.

# Connecting to a COMMON INTERFACE slot (Your TV viewing Card Slot)

- Turn the TV off to connect or disconnect a CI card or CI card adapter.

## Attaching the CI Card Adapter

Attach the adapter as shown.

- To install the CI CARD Adapter, please remove the sticker attached to the TV.

To connect the CI CARD Adapter, follow these steps.

- We recommend attaching the adapter before installing the wall mount, or inserting the “CI or CI+ CARD”.

1. Insert the CI CARD Adapter into the two holes on the product 1.

- Please locate the two holes at the back of the TV next to the **COMMON INTERFACE** port.

2. Connect the CI CARD Adapter to the **COMMON INTERFACE** port on the product 2.

3. Insert the “CI or CI+ CARD”.

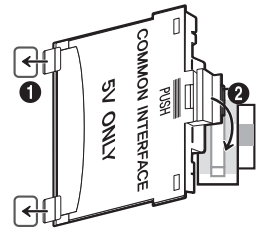

We recommend that you attach the CI Card adapter and insert the CI card (viewing card) before you mount the TV on the wall because it may be difficult and dangerous to do this when it is on the wall.

## Using the “CI or CI+ CARD”

To watch paid channels, the “CI or CI+ CARD” must be inserted.

- If you don't insert the “CI or CI+ CARD”, some channels will display the “Scrambled Signal” message.
- The pairing information containing a telephone number, the “CI or CI+ CARD” ID, the Host ID, and other information will be displayed in about 2~3 minutes. If an error message is displayed, please contact your service provider.
- When the configuration of channel information has finished, the message “Updating Completed” is displayed, indicating the channel list is updated.

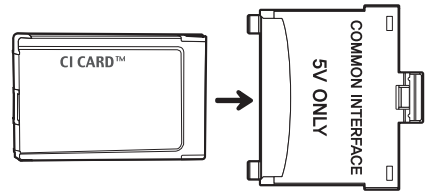

### NOTE

- You must obtain a “CI or CI+ CARD” from a local cable service provider.
- When removing the “CI or CI+ CARD”, carefully pull it out as dropping the “CI or CI+ CARD” may damage it.
- Insert the “CI or CI+ CARD” in the direction marked on the card.
- The location of the COMMON INTERFACE slot may differ depending on the model.
- A “CI or CI+ CARD” is not supported in some countries and regions, therefore, check with your authorised dealer.
- If you have any problems, please contact a service provider.
- Insert the “CI or CI+ CARD” that supports the current aerial settings. The screen will be distorted or will not be visible.

## Inserting Batteries into Remote Control (Battery size: AAA)

Match the polarities of the batteries to the symbols in the battery compartment.

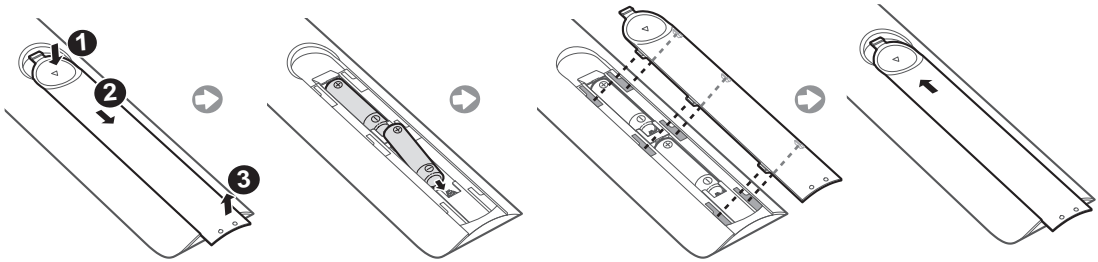

- The colour and shape may vary depending on the model.
  - Use the remote control within 7 m of the TV.
  - Bright lights may affect the performance of the remote control. Avoid using the remote control near special fluorescent lights or neon signs.
1. Gently pull on the battery cover's notch and then remove the cover completely once it comes loose.
  2. Insert 2 AAA alkaline batteries, making sure to align the positive and negative polarities correctly.
  3. Place the battery cover on the remote control and insert the cover into the remote control.
  4. Slide the battery cover in the order shown so that the cover is completely attached to the remote control.

# Remote Control

Learn where the function buttons are on your remote, such as: **SOURCE**, **MUTE**, **-**, **+**, **▲**, **▼**, **MENU**, **TOOLS**, **↔**, **INFO**, **CH LIST**, **RETURN**, **GUIDE** and **EXIT**.

- This remote control has Braille points on the **Power**, **Channel**, and **Volume** buttons and can be used by visually impaired persons.

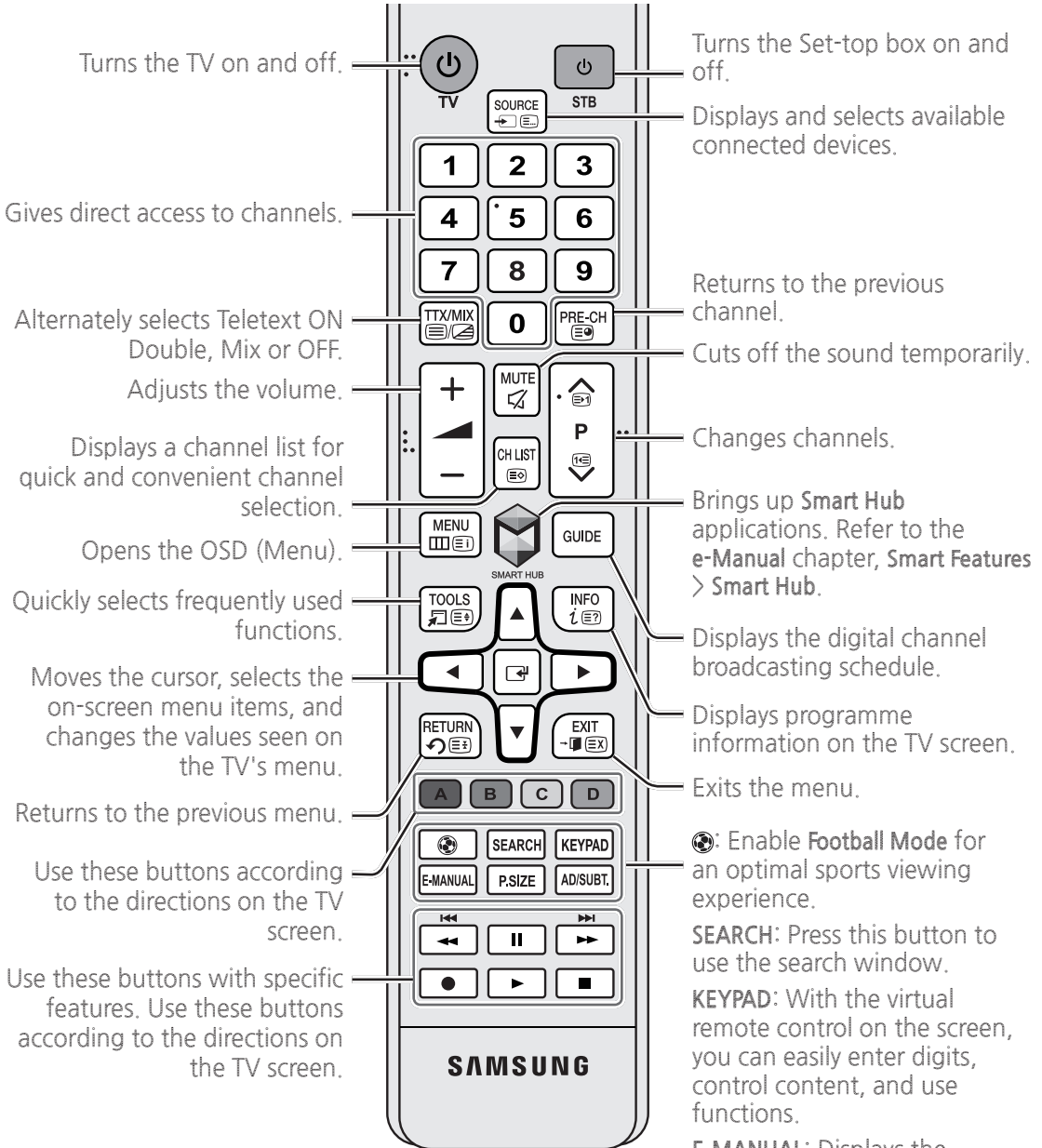

# 04 Performing the initial setup

- The initial setup differs from model to model.

## Turning on the TV

Turn on the TV using the  button on the remote control or TV panel.

- The product colour and shape may vary depending on the model.
- The TV's Controller, a small joystick-like button at the right back of the TV, lets you control the TV without the remote control.

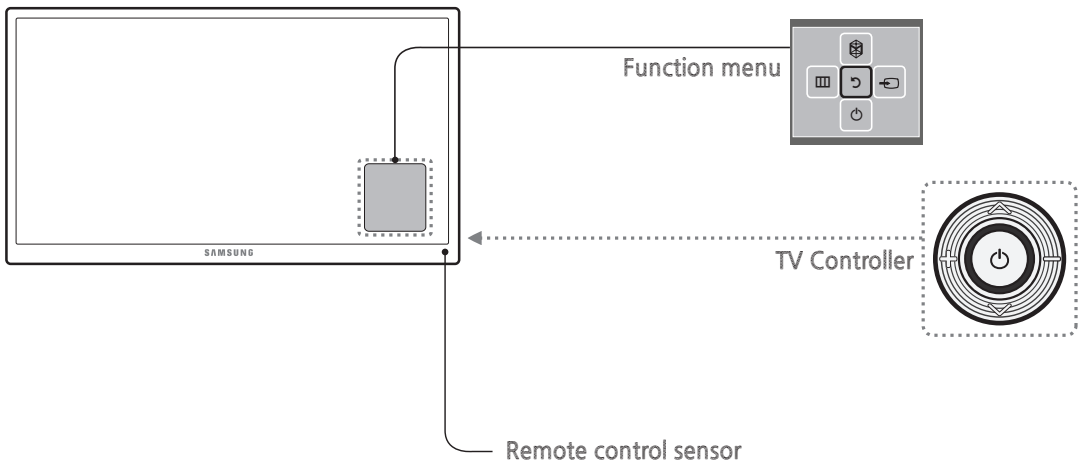

# Initial setup

The initial setup dialogue box appears when the TV is first activated. Follow the on-screen instructions to finish the initial setup process such as selecting the menu language, scanning channels, connecting to the network, and more. During each step, either make a choice or skip the step. You can manually perform this process at a later time in the **System > Setup** menu.

- If you connect any external device to **HDMI1** before starting initial setup, the source of your live TV signal is set to **STB**. After finishing with this process, you will not be able to scan all channels and stores them in the TV's memory.
- If you want to connect aerial cable to your TV, select **Aerial**. In this case, you will be able to scan all channels and stores them in the TV's memory.

## Samsung's 'On TV' Recommendations Service

The **On TV** service recommends TV programmes based on their popularity or your personal preferences. To enjoy the **On TV** service, please follow the steps below. (You must have an Internet connection.)

1. **Configure your TV:** Select the **TV** source to be used for **On TV**.  
**Aerial:** Freeview, Freesat, DVB-T/C/S  
**Set-top box:** External Cable Box, External Satellite Box
2. **Auto tuning channels:** This step only occurs if '**Aerial**' was selected in step 1.
3. **Select a Service Provider:** To select your preferred programme provider for **On TV**, enter your postcode and select your Freeview, Freesat or external satellite television provider from the displayed list.
4. **Set-top Box Control Test:** This test is to check if your TV remote is able to control your Set-top Box. This step only occurs if '**Set-top box**' was selected in step 1.

## Password Change

**System > Change PIN**

To alter the default setting of the TV, change the password.

### Changing the TV's password.

1. Run **Change PIN** and then enter the current password in the password field. The default password is "0-0-0-0".
2. Enter a new password and then enter it again to confirm it. The password change is complete.
  - If you forgot your PIN code, press the buttons in the following sequence to reset the PIN to "0-0-0-0":  
In Standby mode: **MUTE** → 8 → 2 → 4 → **POWER** (On)

# 05 Selecting Connected Devices

You can select a connected external device using the **SOURCE** button.

For example, to switch to a gaming console connected to the second HDMI connector, press **SOURCE**. From the **Source** list, select **HDMI2** to change the input signal to HDMI mode. Connector names may vary depending on the model.

- For some compatible devices connected via SCART or HDMI sockets, the TV may automatically select the correct source when this device is accessed. For this to work, the HDMI Anynet+ system must be switched on (**System > Anynet+ (HDMI-CEC)**). Anynet+ will also automatically power off compatible HDMI devices when the TV is switched off.

The following options are available in the **Source** screen:

## Additional functions

Select a port connected to an external device, and press and hold the Enter button. The following functions are available:

- Available options for each connector may vary.

### Edit Name

Rename devices connected to the TV for easier identification of external sources.

For example, you can designate a computer connected to the TV via an HDMI-DVI cable as **DVI PC**.

Alternatively, simply designate a computer connected to the TV via an HDMI cable as **PC**.

You can also designate an AV device connected to the TV via an HDMI-DVI cable as **DVI Devices**.

### Information

View detailed information about the connected devices.

### Anynet+ (HDMI-CEC)

Displays a list of Anynet+ (HDMI-CEC)-compliant devices that are connected to the TV.

- This option is only available when **Anynet+ (HDMI-CEC)** is **On**.

### Disconnect USB Device

Used to safely remove a USB device connected to the TV. This option is only available when a USB device has been selected.

# Controlling External Devices with the TV Remote (Universal Remote Setup)

## System > Universal Remote Setup

- Availability depends on the specific model and area.

The universal remote control feature lets you control cable boxes, Blu-ray players, home theatres, and other external devices connected to the TV using the TV's remote control. In order to use the TV's remote control as a universal remote, you must first connect the IR extender cable (included).

- You can also use the Anynet+ (HDMI-CEC) function to operate some external Samsung devices with your TV's remote control without any additional setup. For more information, refer to the **e-Manual**.
- Certain external devices connected to the TV may not support the universal remote feature.

## Setting Up the Universal Remote Control

Connect the IR extender cable to the TV's IR output connector as shown in the diagram. Place the transmitter end within 10 cm of the external device's receiver pointing in the direction of the remote receiver. However, there must be no obstacles between the IR extender cable and the external device. The presence of obstacles interferes with the transmission of the remote control signal.

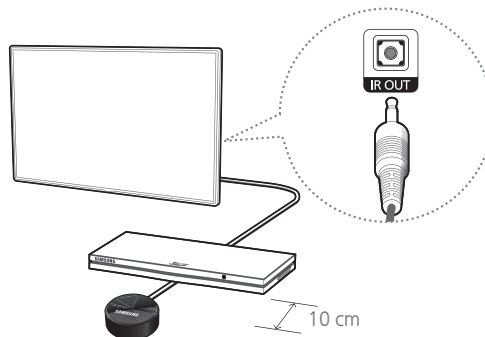

## Controlling External Devices with the TV Remote

1. Turn on the external device to set up the universal remote function for, and bring up the **Source** screen.
2. Select  **Universal remote setup** from the top of the screen. This initiates the universal remote setup process.
3. Follow the on-screen instructions and register the external device.

# 06 Getting more details.

- For more information about the Samsung TV, refer to the **e-Manual**.

## Viewing more TV features

The **e-Manual** contains more detailed information on the TV features.

How to access e-Manual : Press the **E-MANUAL** button on the Remote Control.

### Launching the e-Manual

The embedded **e-Manual** contains information.

- You can also download a copy of the **e-Manual** from Samsung's website, and read it on your computer or print it out.
- Yellow words indicate a menu item; white bold words indicate remote control buttons. Arrows are used to indicate the menu path. (Example: **Picture** > **Picture Mode**)

1. Select **e-Manual**. The e-Manual loads.
2. Select a category from the side of the screen. Once a selection has been made, the contents of the selected category appear.
3. Select an item from the list. This opens the **e-Manual** on the corresponding page.

### If a description doesn't fit on a single screen...

You can scroll pages in one of the following ways.

- Position the focus on the page to display  /  on the screen. Press ,  button.

## Additional e-Manual Features

### Loading Pages using Keywords

Select **Search** from the side of the screen to bring up the search screen. Enter a search term and then select **Done**. Select an item from the search results to load the corresponding page.

### Loading Pages from the Index Page

Select **Index** from the side of the screen to bring up the index screen. Select a keyword from the list to navigate to the relevant page.

### Using the History to Load Previously Read Pages

Select **Opened page** from the side of the screen. A list of previously read pages is shown. Select a page. The **e-Manual** jumps to the selected page.

### Accessing the Menu from the e-Manual (Try Now)

Select  (Try Now) on a feature-description to directly move to the corresponding menu and try out the feature.

### Accessing the e-Manual from the Menu

If you want to read an **e-Manual** entry on a specific screen menu feature, Press the **E-MANUAL** button.

- Certain menu options cannot be used.

### Loading Reference Pages

Select  (Link) from the side of a feature-description page to access the corresponding reference page. Press the **RETURN** button to move back to the original feature description.

## Updating the e-Manual to the Latest Version

You can update the **e-Manual** in the same way as updating apps.

1. Select the **e-Manual** item in the **SAMSUNG APPS** screen.
2. Press and hold the Enter button. The Options menu appears.
3. From the Options menu on the screen, select **Update apps**. A popup window appears.
  - **Update apps** is shown on the screen only when an update is required.
4. Select **e-Manual** in the popup window and then select **Update**. You can update the **e-Manual** to the latest version.

# 07 Troubleshooting and Maintenance

## Troubleshooting

If you have any questions about the TV, first refer to the Troubleshooting list below. If none of these troubleshooting tips apply, please visit “[www.samsung.com](http://www.samsung.com)” and click on Support, or contact the call centre listed on the back cover of this manual.

Issues	Solutions and Explanations
The TV won't turn on.	<p>Make sure the AC power cord is securely plugged into the wall outlet and the TV.</p> <p>Make sure the wall outlet is working.</p> <p>Try pressing the  button on the TV to make sure the problem is not the remote. If the TV turns on, refer to the “Remote control does not work” item below.</p>
There is no picture/video.	<p>Check the cable connections. Remove and reconnect all cables connected to the TV and external devices.</p> <p>Set the video outputs of your external devices (Cable/Sat Box, DVD, Blu-ray etc) to match the TV's input connections. For example, if the output of an external device is HDMI, it should be connected to an HDMI input on the TV.</p> <p>Make sure your connected devices are powered on.</p> <p>Be sure to select the correct input source.</p> <p>Reboot the connected device by unplugging it, and then reconnecting the device's power cable.</p>
The remote control does not work.	<p>Replace the remote control batteries. Make sure the batteries are installed with their polarities (+/-) in the correct direction.</p> <p>Clean the sensor's transmission window on the remote.</p> <p>Try pointing the remote directly at the TV from 1.5 ~ 1.8 m away.</p>
The remote control of the cable/set top box doesn't turn the TV on or off or adjust the volume.	<p>Programme the Cable/Set remote control to operate the TV. Refer to the Cable/Set-Top-Box user manual for the SAMSUNG TV code.</p>

- This TFT LED panel uses a panel consisting of sub pixels which require sophisticated technology to produce. There may, however be a few bright or dark pixels. These pixels will have no impact on the performance of the product.
- To keep your TV running optimally upgrade to the latest firmware on the Samsung website via the USB device USB (Samsung.com > Support > Downloads).
- Some of the pictures and functions above are available for specific models only.

# Cautions about the Eco Sensor and Screen Brightness

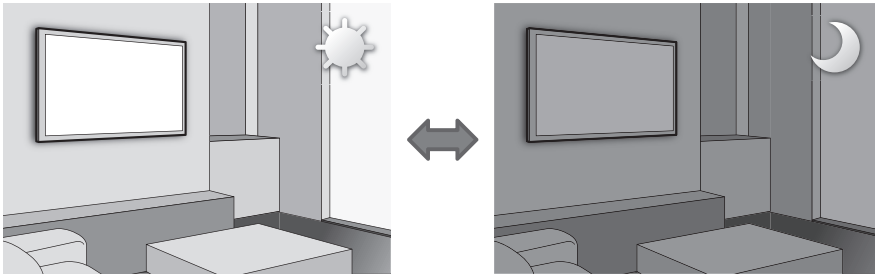

The Eco Sensor measures the light in the room and optimises the brightness of the TV automatically to reduce power consumption. This causes the TV to brighten and dim automatically. To turn this function off, go to **System > Eco Solution > Eco Sensor**.

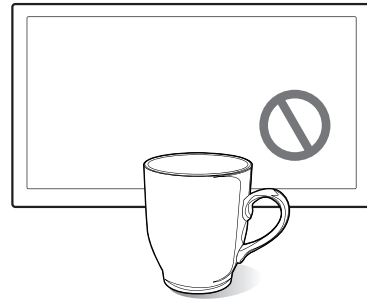
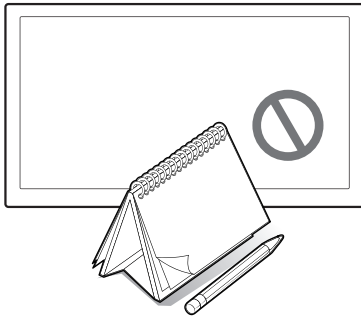

**Do not block the sensor with any material. This may decrease the picture brightness.**

1. **Eco Sensor:** This power-saving feature automatically adjusts the screen brightness of the TV according to the ambient light detected by the Light Sensor.
2. To enable or disable the **Eco Sensor**, go to **System > Eco Solution > Eco Sensor** and select **On** or **Off**.
3. Please note: If the screen is too dark while watching TV in a dark environment, this may be due to the **Eco Sensor**.

# What is Remote Support?

Samsung's Remote Support service offers you one-on-one support with a Samsung Technician who can remotely:

- Diagnose your TV
- Adjust your TV settings
- Perform a factory reset for your TV
- Install recommended firmware updates

## How Does it Work?

Having a Samsung Tech remotely service your TV is really pretty simple



1. Call the Samsung Contact Centre and ask for remote support.



2. Open the menu on your TV and go to the Support section.



3. Select Remote Management and Provide the Pin# to the agent.



4. The agent will then access your TV. That's it!

## Storage and Maintenance

- If a sticker was attached to the TV screen, some debris may remain after you remove the sticker. Please clean the debris off before watching TV.
- The exterior and screen of the product can get scratched while cleaning it. Be sure to wipe the exterior and screen carefully using a soft cloth to prevent scratches.

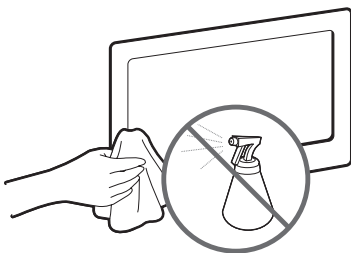

Do not spray water directly onto the product. Any liquid that enters the product may result in product failure, fire, or electric shock.

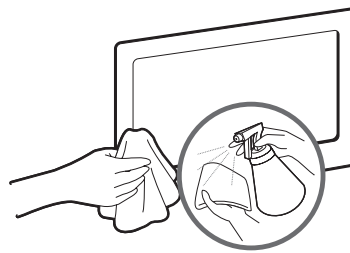

Clean the product with a soft damp cloth using a small amount of water. Do not use a flammable liquid (e.g. benzene, thinners) or a cleaning agent.

# 08 Specifications and other information

## TV Specifications

Display Resolution (pixel)	1920 x 1080	
Environmental Considerations		
Operating Temperature	50°F to 104°F (10°C to 40°C)	
Operating Humidity	10% to 80%, non-condensing	
Storage Temperature	-4°F to 113°F (-20°C to 45°C)	
Storage Humidity	5% to 95%, non-condensing	
Stand Swivel (Left / Right)	-20° ~ 20° (60 inches: -15° ~ 15°)	
Sound (Output)	10W X 2	
Model Name	UE32H6200	UE40H6200
Screen Size (Diagonal)	32 inches	40 inches
Dimensions (W x H x D)		
Body	721.4 x 431.8 x 62.9 mm	906.6 x 536.1 x 63.1 mm
With stand	721.4 x 501.6 x 264.8 mm	906.6 x 604.9 x 264.8 mm
Weight		
Without Stand	5.1 kg	8.0 kg
With Stand	6.1 kg	9.1 kg
Model Name	UE48H6200	UE50H6200
Screen Size (Diagonal)	48 inches	50 inches
Dimensions (W x H x D)		
Body	1075.1 x 630.9 x 63.5 mm	1116.8 x 654.4 x 63.7 mm
With stand	1075.1 x 711.2 x 306.9 mm	1116.8 x 733.5 x 306.9 mm
Weight		
Without Stand	11.3 kg	12.8 kg
With Stand	12.9 kg	14.4 kg

Model Name	UE55H6200	UE60H6200
Screen Size (Diagonal)	55 inches	60 inches
Dimensions (W x H x D)		
Body	1230.6 x 718.4 x 64.0 mm	1365.0 x 797.4 x 64.4 mm
With stand	1230.6 x 800.0 x 306.9 mm	1365.0 x 874.4 x 306.9 mm
Weight		
Without Stand	15.8 kg	23.5 kg
With Stand	17.4 kg	25.5 kg
Model Name	UE40H6240	UE48H6240
Screen Size (Diagonal)	40 inches	48 inches
Dimensions (W x H x D)		
Body	906.6 x 525.4 x 63.1 mm	1075.1 x 620.1 x 63.5 mm
With stand	906.6 x 593.1 x 266.9 mm	1075.1 x 697.6 x 308.2 mm
Weight		
Without Stand	7.9 kg	11.3 kg
With Stand	9.0 kg	12.9 kg
Model Name	UE55H6240	UE60H6240
Screen Size (Diagonal)	55 inches	60 inches
Dimensions (W x H x D)		
Body	1230.6 x 707.4 x 64.0 mm	1365.0 x 786.4 x 64.4 mm
With stand	1230.6 x 786.9 x 308.2 mm	1365.0 x 863.6 x 308.2 mm
Weight		
Without Stand	16.0 kg	21.3 kg
With Stand	17.6 kg	23.3 kg

- The design and specifications are subject to change without prior notice.
- For information about the power supply, and about power consumption, refer to the label attached to the product.
- Typical power consumption is measured according to IEC 62087 Ed.2

## Standby mode

To decrease power consumption, unplug the power cord when the TV will not be used for a long time.

# Licences

---

**HDMI** The terms HDMI and HDMI High-Definition Multimedia Interface, and the HDMI Logo are trademarks or registered trademarks of HDMI Licensing LLC in the United States and other countries.

---



## Still image warning

Avoid displaying still images (such as jpeg picture files), still image elements (such as TV channel logos, stock or news bars at the bottom of the screen etc.), or programmes in panorama or 4:3 image format. Constantly displaying still pictures can cause image burn-in on the LED screen, which will affect the image quality. To reduce risk of this occurring please follow the recommendations below:

- Avoid displaying the same TV channel for long periods.
- Always try to display any image in full screen. Use the TV set's picture format menu for the best possible match.
- Reduce brightness and contrast to avoid the appearance of after-images.
- Use all TV features designed to reduce image retention and screen burn. Refer to the e-Manual for more details.

## Recommendation - EU Only



Hereby, Samsung Electronics, declares that this TV is in compliance with the essential requirements and other relevant provisions of Directive 1999/5/EC.

The official Declaration of Conformity may be found at <http://www.samsung.com>, go to Support > Search Product Support and enter the model name.

This equipment may only be used indoors.

This equipment may be operated in all EU countries.



### **Correct Disposal of This Product (Waste Electrical & Electronic Equipment) (Applicable in countries with separate collection systems)**

This marking on the product, accessories or literature indicates that the product and its electronic accessories (e.g. charger, headset, USB cable) should not be disposed of with other household waste at the end of their working life. To prevent possible harm to the environment or human health from uncontrolled waste disposal, please separate these items from other types of waste and recycle them responsibly to promote the sustainable reuse of material resources.

Household users should contact either the retailer where they purchased this product, or their local government office, for details of where and how they can take these items for environmentally safe recycling.

Business users should contact their supplier and check the terms and conditions of the purchase contract. This product and its electronic accessories should not be mixed with other commercial wastes for disposal.



### **Correct disposal of the batteries in this product (Applicable in countries with separate collection systems)**

This marking on battery, manual or packaging indicates that the batteries in this product should not be disposed of with other household waste at the end of their working life. Where marked, the chemical symbols Hg, Cd or Pb indicate that the battery contains mercury, cadmium or lead above the reference levels in EC Directive 2006/66. If batteries are not properly disposed of, these substances can cause harm to human health or the environment.

To protect natural resources and to promote material reuse, please separate batteries from other types of waste and recycle them through your local, free battery return system.

- **WARNINGS:** Image retention, commonly known as screen burn-in, can occur on most types of television if the same image is displayed continuously. The most common causes of image retention are logos that remain stationary on the TV screen. These logos are common on many programmes received via a Set-top Box. To reduce this risk, avoid displaying still images for long durations and lower the brightness or contrast settings to decrease the intensity of the picture. Extended viewing of movies and programmes in aspect ratios that are different from the aspect ratio of the TV may cause image retention. Always try to avoid black borders at the top or bottom by using the zoom function. This will help eliminate the black borders and fit the picture to the entire area of the screen. Using a video game console may cause image retention and is not recommended. When using a PC input, avoid displaying still images for long durations and reduce the brightness or contrast settings to decrease the intensity of the picture.
- **IMPORTANT:** Image retention issues are not covered by your Samsung® warranty.

# Warranty Card



United Kingdom



Republic of Ireland (EIRE)

This Samsung product is warranted for a period of twelve (12) months from the original date of purchase, against defective materials and workmanship. In the event that warranty service is required, you should return the product to the retailer from whom it was purchased. However, Samsung Authorised Dealers and Authorised Service Centres in other EC Countries will comply with the warranty on the terms issued to purchasers in the country concerned. In case of difficulty, details of our Authorised Service Centres are available from:

Samsung Electronics U.K. Ltd.  
Customer Care Centre  
PO Box 479  
GATESHEAD NE9 9BJ  
United Kingdom  
Tel: 0330 SAMSUNG (7267864) / Fax: 0330 7260001 (UK & Northern Ireland)  
Tel: 0818 717100 / Fax: +44 117 915 6736 (EIRE Only)  
Web: [www.samsung.com](http://www.samsung.com)

## WARRANTY CONDITIONS

1. The warranty is only valid if, when warranty service is required, the warranty card is fully and properly completed and is presented with the original invoice or sales slip or confirmation, and the serial number on the product has not been defaced.
2. Samsung's obligations are limited to the repair or, at its discretion, replacement of the product or the defective part.
3. Warranty repairs must be carried out by Authorised Samsung Dealers or Authorised Service Centres. No re-imburement will be made for repairs carried out by non Samsung Dealers and, any such repair work and damage to the products caused by such repair work will not be covered by this warranty.
4. This product is not considered to be defective in materials nor workmanship by reason that it requires adaptation in order to conform to national or local technical or safety standards in force in any country other than the one for which the product was originally designed and manufactured.
5. This warranty covers none of the following:
  - a) Periodic check ups, maintenance and repair or replacement of parts due to normal wear and tear.
  - b) Cost relating to transport, removal or installation of the product.
  - c) Misuse, including the failure to use this product for its normal purposes or incorrect installation.
  - d) Damage caused by Lightning, Water, Fire, Acts of God, War, Public Disturbances, incorrect mains voltage, improper ventilation or any other cause beyond the control of Samsung.
  - e) Spillage of food or liquid or use of any other hazardous substances, which may effect the product.
  - f) Performance due to differences in broadcasting method between countries
6. This warranty is valid for any person who legally acquired possession of the product during the warranty period.
7. The consumers statutory rights in any applicable national legislation whether against the retailer arising from the purchase contract or otherwise are not affected by this warranty. Unless there is national legislation to the contrary, the rights under this warranty are the consumers sole rights and Samsung, its subsidiaries and distributors shall not be liable for indirect or consequential loss or any damage to records, compact discs, videos or audio taper or any other related equipment or material.
8. Some products may differ from these guidelines. Please check with your dealer or the local Samsung web-site.

# Wiring the Mains Power Supply Plug (UK Only)

## IMPORTANT NOTICE

The mains lead on this equipment is supplied with a molded plug incorporating a fuse. The value of the fuse is indicated on the pin face of the plug, and if it requires replacing, a fuse approved to BSI1362 of the same rating must be used.

Never use the plug with the fuse cover omitted if the cover is detachable. If a replacement fuse cover is required, it must be of the same colour as the pin face of the plug. Replacement covers are available from your dealer.

If the fitted plug is not suitable for the power points in your house or the cable is not long enough to reach a power point, you should obtain a suitably approved extension lead or consult your dealer for assistance. However, if there is no alternative but to cut off the plug, remove the fuse and then safely dispose of the plug.

Do NOT connect the plug to a mains socket as there is a risk of shock hazard from the bared flexible cord.

## IMPORTANT

The wires in the mains lead are coloured in accordance with the following code:

BLUE - NEUTRAL BROWN - LIVE

As these colours may not correspond to the coloured markings identifying the terminals in your plug, proceed as follows : The wire coloured BLUE must be connected to the terminal marked with the letter N or coloured BLUE or BLACK. The wire coloured BROWN must be connected to the terminal marked with the letter L or coloured BROWN or RED.

## WARNING

**DO NOT CONNECT EITHER WIRE TO THE EARTH TERMINAL, WHICH IS MARKED WITH THE LETTER E OR BY THE EARTH SYMBOL , OR COLOURED GREEN OR GREEN AND YELLOW.**

***This page is intentionally  
left blank.***