

avocor



AVE Series User Manual

E-Series User Manual Table of Contents

3. Contents of Packaging
4. Compliance Information
 - Declaration of Conformity
 - Product Disposal
- a. Important safety instructions
 - Safety Precautions
7. Installation Considerations
8. Installation Guide
9. Cleaning
 - Power Considerations
10. Exemptions
 - Warnings
11. Introduction
12. The Display at a Glance
 - Front View
 - Rear Views
14. Front Buttons
15. Display Input Sources
 - Front Ports
 - Rear Ports
17. The Remote Control
18. Inserting the batteries
 - Notes on Batteries
 - Notes on Remote Control Operation
 - Remote Control Sensor
19. Switching the display on and off
20. Selecting the source
 - Connecting to the Display
21. Connecting to an external PC using a HDMI connection
22. Connecting to an external PC using a DisplayPort connection
23. Enabling the Touch System
 - Connecting the Display to a Host Computer
24. Installing an OPS
25. Connecting to Control System
26. Using the On-Screen Display Menus (OSD)
27. Picture settings
28. Audio settings
29. OSD Menu Settings
31. RS-232 Control
33. Display Dimensions
34. FAQ - Frequently asked questions
35. Warranty Support

Contents of Packaging

1. Accessory Carton

- Quick Start Guide
- Remote Control & Batteries
- 2x Touch Stylus – 2x3mm
- Power Cable – US Cable 2m, UK Cable 2m, EU Cable, 2m
- 2x 3m HDMI Cable
- 2x 3m USB-A – USB-A Cable
- Cleaning Cloth

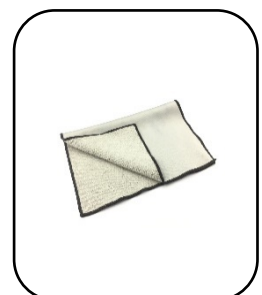
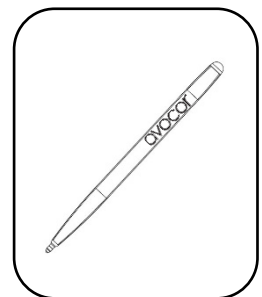
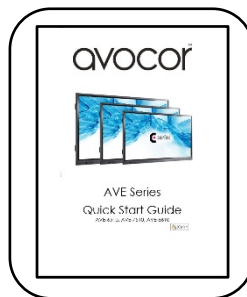
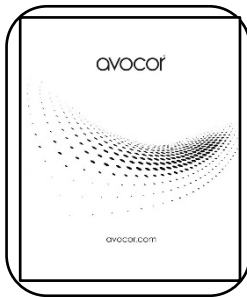

Compliance Information

DECLARATION OF CONFORMITY:

AVOCOR hereby declares that the Product Model Numbers:

AVE-6530 / AVE-7530 / AVE-8630

Conform with the provisions of:

- FCC :
 - FCC CFR Title 47 Part 15 Subpart B Class A, CISPR 22
 - ANSI C63.4
- CE :
 - EN 55032
 - EN 55024
 - EN 61000-3-2
 - EN 61000-3-3

FCC PART 15:

This equipment has been tested and found to comply with the limits for a Class B digital device, pursuant to part 15 of the FCC Rules. These limits are designed to provide reasonable protection against harmful interference when the equipment is operated in a residential / commercial environment. This equipment generates, uses, and can radiate radio frequency energy and, if not installed and used in accordance with the instruction manual, may cause harmful interference to radio communications.

However, there is no guarantee that interference will not occur in a particular installation. If this equipment does cause harmful interference to radio or television reception, which can be determined by turning the equipment off and on, the user is encouraged to try to correct the interference by one or more of the following measures:

- Reorient or relocate the receiving antenna.
- Increase the separation between the equipment and receiver.
- Connect the equipment into an outlet on a circuit different from that to which the receiver is connected.
- Consult the dealer or an experienced radio/TV technician for help.

CAUTION:

Any changes or modifications not expressly approved by the party responsible for compliance could void the user's authority to operate the equipment.

PRODUCT DISPOSAL:

The product contains small amounts of tin, lead and/or mercury. Disposal of these materials may be regulated due to environmental considerations.

DISPOSAL OF OLD ELECTRICAL AND ELECTRONIC EQUIPMENT (Applicable throughout the European Union and other European countries with separate collection programs).

This symbol found on your product or on its packaging, indicates that this product should not be treated as household waste when you wish to dispose of it. Instead, it should be handed over to an applicable collection point for the recycling of electrical and electronic equipment. By ensuring this product is disposed of correctly, you will help prevent potential negative consequences to the environment and human health, which could otherwise be caused by inappropriate disposal of this product.

The recycling of materials will help to conserve natural resources. This symbol is only valid in the European Union. If you wish to discard this product, please contact your local authorities or dealer and ask for the correct method of disposal.

Important Safety Instructions

- Before using this display, please read this user manual thoroughly to help protect against property damage and to ensure your personal safety and the safety of others.
- For your safety, be sure to observe the warnings located in this manual.
- For installation or adjustment, please follow the instructions in this manual and refer all servicing to qualified service personnel.

Safety Precautions

- If smoke or a peculiar smell comes from the display, remove the power plug from the outlet immediately and contact your dealer for inspection.
- If the display has been turned on but there isn't a picture, remove the power plug from the outlet immediately and contact your dealer for inspection.
- If water is spilled or objects are dropped inside the display, remove the power plug from the outlet immediately and contact your dealer for inspection.
- If the display is dropped or the cabinet is damaged, remove the power plug from the outlet immediately and contact your dealer for inspection.

Installation Considerations

- Don't install in a high-temperature environment.
- If the display is used in high-temperature or in direct sunlight, it may cause the case or other parts to become distorted or damaged, resulting in overheating or electrical shock.
- Don't install in a high-humidity environment. This may cause overheating or electrical shock.
- Don't install near any heat sources such as radiators, heat registers, stoves, or other apparatus that produce heat.
- Don't overload outlets or cables beyond electrical capacity.
- Don't insert the power plug into an outlet other than 100~240V AC. This may cause fire or electrical shock.
 - ◆ Don't use a damaged power plug or worn outlet.
 - ◆ Don't insert an improper power plug it may cause fire or electric shock.
- Don't place the display on an unstable shelf or surface.
- Please install on a horizontal, stable, level surface.
- Don't place objects on the display.
 - ◆ If the display is covered or the vents are blocked, the display could overheat and cause a fire.
 - ◆ If metal or liquid gets into the display, it may cause fire or electrical shock.
 - ◆ Do not put heavy objects on the display as they may fall, causing injury.
 - ◆ Please keep a 10cm minimum distance between the display and the wall for sufficient ventilation.
 - ◆ If you are mounting the display in an enclosure or recess, leave sufficient space on all sides between the display and surrounding objects. This allows heat to disperse, maintaining the proper operating temperature
- Don't install in direct sunlight or with light sources directed at the display. Images may appear washed out and less vibrant.
- Don't move the display when it is connected to the power cord and AV cables.
 - ◆ When moving the display, make sure to remove the power plug and cables from the outlet or source.
 - ◆ When unpacking and carrying the display please follow these guidelines:
 - 2 people are needed for displays up to 65".
 - 3 people are needed for displays up to 75"
 - 4 people are needed for displays up to 86"
 - ◆ Make sure the display is transported and carried upright.
 - ◆ Handle the display gently. Do not drop.

Installation Guide

When installing the displays please follow the installation manual from the manufacturer for the type of mount you have selected.

Make sure you use the upper and lower handles on the back of the display while lifting or moving the display, to avoid touching the front panel during the move.

When unpacking, and carrying the display please follow these guidelines:

- 2 people are needed for displays up to 65"
- 3 people are needed for displays up to 75"
- 3 people are needed for displays up to 86"

Before installing, please make sure the wall is strong enough to hold the necessary weight of the display and the mount.

Step 1. Keep the display facing the ground and place it on a flat object.

Step 2. Remove the 4 screws (M8*15) from the back of the display.

Step 3. Align the mounting arms with the mounting holes and attach the brackets to the display using the screws removed in Step 2.

Caution: Use max 15mm long screws, 8mm Metric - Longer screws will damage the display

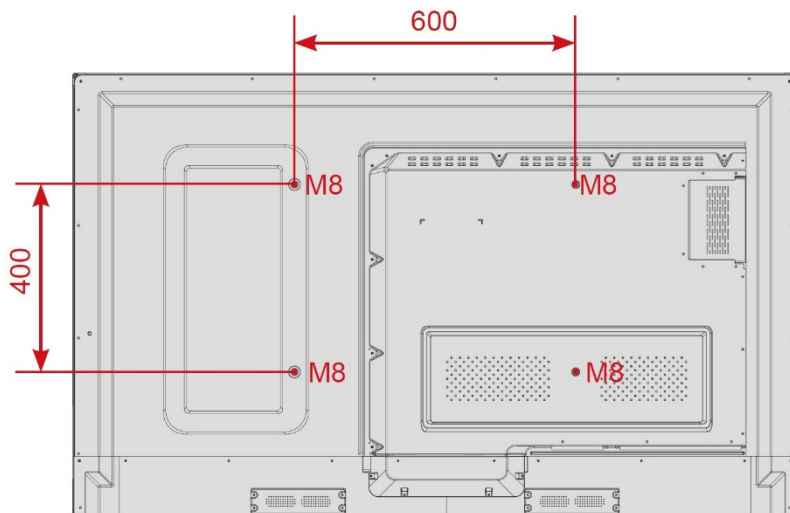

65"

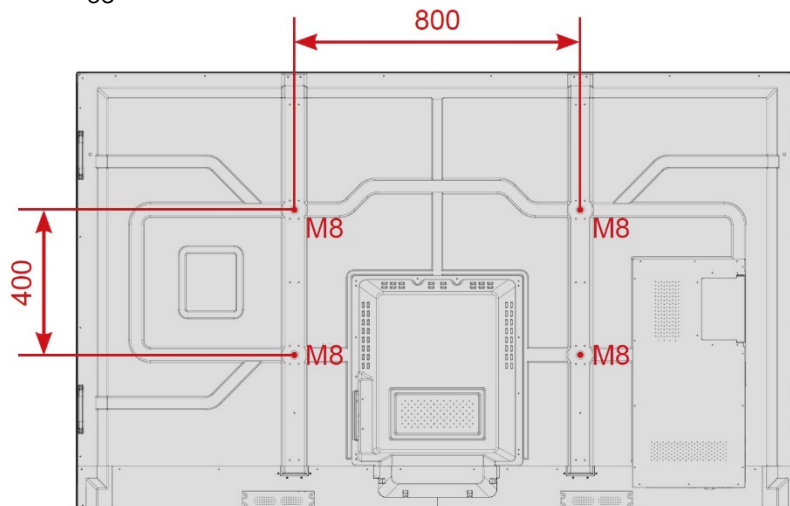

75" / 86"

Cleaning

- When the surface of the display becomes dirty, please wipe the surface lightly with a microfibre cloth.
- If the surface requires additional cleaning, lightly moisten the cloth.
- Do not let any kind of liquid enter the display as it may cause electrical shock or damage.
- Do not clean the display with alcohol, solvents or ammonia, as this could damage the display.
- Never spray a cleanser directly onto the screen.
- If liquid gets on the display's screen, please clean it with a dry and soft cloth immediately.

Power Considerations

- If the power cord or plug is damaged or becomes hot, turn off the main power switch of the display, make sure the power plug has cooled down and remove the plug from the power outlet. If the display is still used in this condition, it may cause fire or electrical shock. Please contact your dealer.
- Protect and correctly use the power cord/plug.
 - ◆ Don't pinch the power cord/plug between hard surfaces.
 - ◆ Don't step on the power cord/plug.
 - ◆ Before inserting the power plug into the wall outlet, connect the power cord to the display.
 - ◆ Don't operate the display with a damaged power cord or it may damage the display.
- If an extension cord must be used, ensure the voltage rating exceeds the max power consumption of the display. If the voltage rating is less than the display, it will cause the extension cord to overheat.
- During a lightning storm, always remove the plug from the power outlet.
- Only connect the screen to an earthed electrical socket – UK only
- Don't install or remove the power plug with wet hands.
- If the display will not be used for a long period of time, unplug the display from the power outlet.

Exemptions

- This product isn't warranted for any damage caused by natural disaster (such as earthquake, thunder, etc.), fire, acts by third parties, accidents, owner's intentional misuse and fault, or use in other improper conditions.
- This product isn't warranted for incidental damages (such as profit loss or interruption in business, modification or erasure of record data, etc.) caused by use or inability to use this product.
- This product isn't warranted for any damage caused by inappropriate operation, or from not following the user manual.
- This product isn't warranted for any damage caused by misuse or malfunction through simultaneous use of this product and the connected equipment or software.
- This product isn't warranted for any damage caused by neglect of the instructions described about installation.
- This product isn't warranted for any damage caused by improper installation.
- This product isn't warranted for any damage caused by disassembly, modification or repair by non-authorized service centre or people.

Warnings

- Do not use the display lying flat on its back.
- Transport the display upright with proper packaging. Avoid placing the display face up or down.
- Do not send a static (non-moving) image to the display, or it may cause image 'burn-in' or image retention. "Burn in" and/or image retention is not covered under warranty.
- Make sure to change the image on the display periodically. It is recommended to:
 - ◆ Turn off the display for at least 6 hours after 18 hours of usage in a 24-hour period to help avoid image retention
- Don't push or shake the display.
- Don't press heavily on the glass of the display.
 - ◆ If the glass of the display panel is broken, liquid may escape. Please don't touch the liquid.
 - ◆ If the liquid gets into your eyes or touches your skin, wash with the clean water and seek medical attention immediately.

Introduction

Your new Avocor E-Series is an ultra-high definition interactive touch display supporting full range 4K@60hz resolution, up to 20 simultaneous touch points, multiple source inputs for your computers and peripheral devices, and our new intuitive on-screen display (OSD) menu.

Our E-Series displays follow our agnostic approach to interactive displays: they are compatible with a wide range of hardware and software, making it a great addition to any interactive meeting-room solution. Whether you need a virtual meeting space for your conference room, or a powerfully adaptive whiteboard or presentation hub for your classroom, the Avocor E-Series will exceed your expectations

About This Manual

This user manual was written to help you get the most out of your display.

In addition to detailed descriptions of the display and its features, this manual will guide you through the installation and setup processes and provide tips, tricks, and best practices on how best to utilize the display.

We make every effort to ensure that this manual is accurate as of the date it was printed. However, it may require periodic updating due to ongoing product improvements and customer feedback. Find the latest version of our manuals at Avocor.com.

The Display at a Glance

Front View

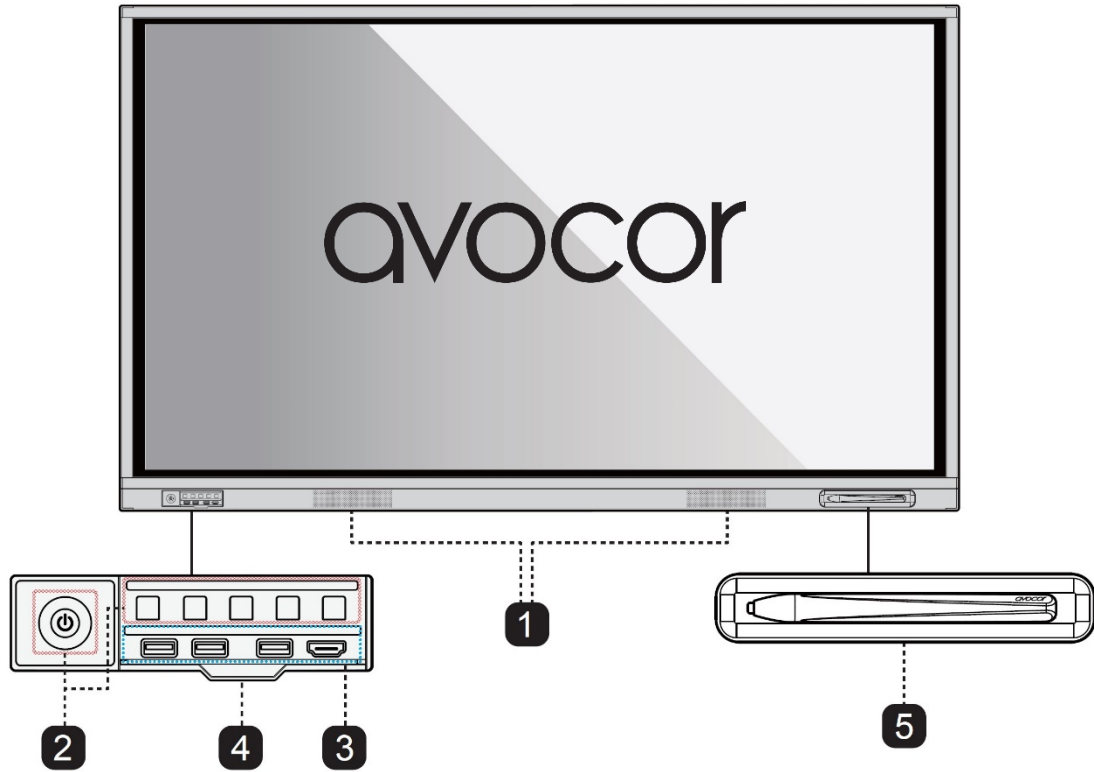

Rear Views

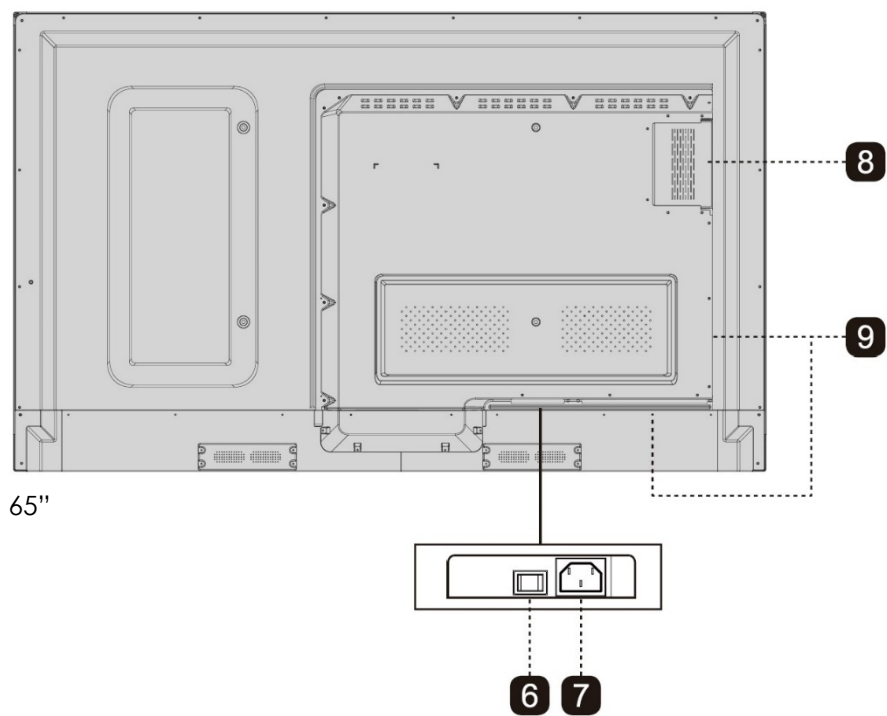

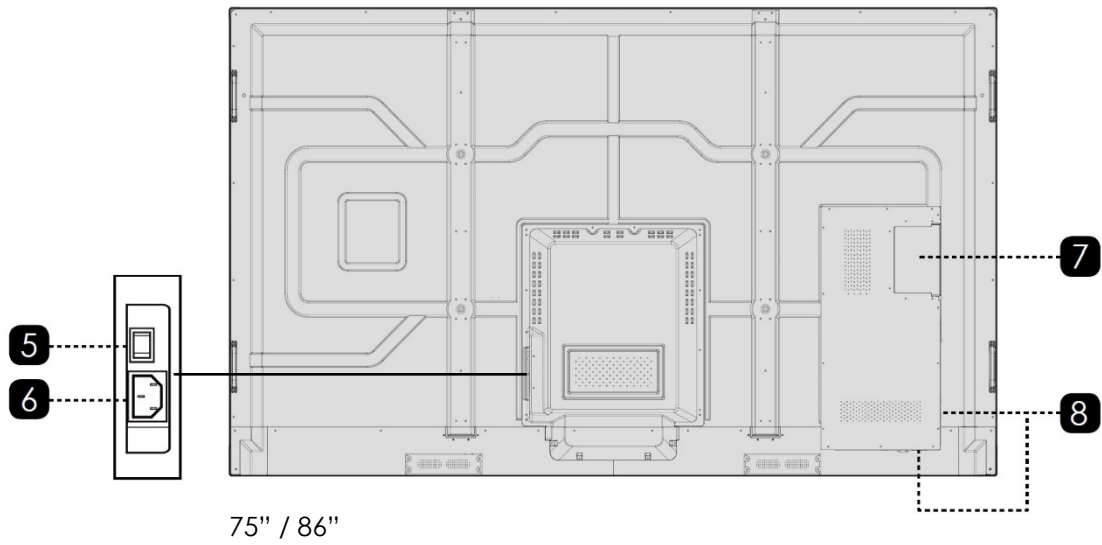

- 1 Speakers
- 3 Front Ports
- 5 Pen Tray
- 7 Power Supply
- 9 Rear Ports

- 2 Front Buttons
- 4 Front Port Cover
- 6 Power Switch
- 8 OPS PC Slot

Front Buttons

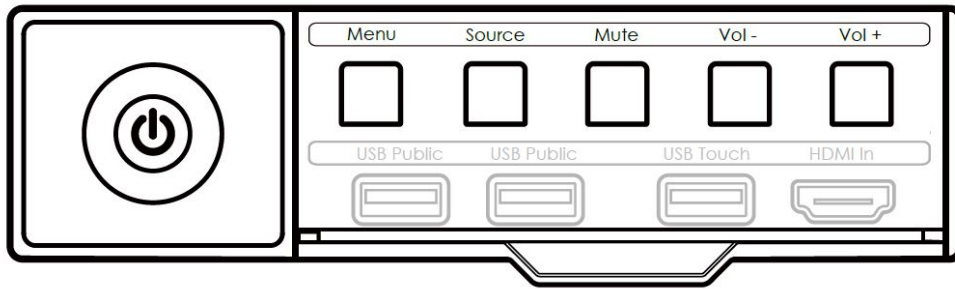

Button	Operation	Function
Power	Short Press	Power on/off Indicator LED status: <ul style="list-style-type: none"> • Solid Red: Sleep mode • Solid Blue: Working state
Menu	Short press	Open the Settings menu
Source	Short press	Open the Source menu
Mute	Short press	Mutes the audio
VOL -	Short press	Decrease the audio volume in steps
	Long press - more than 1 sec	Decrease the sound volume continuously
VOL+	Short press	Increase the audio volume in steps
	Long press - more than 1 sec	Increase the sound volume continuously

Display Inputs

Front Ports

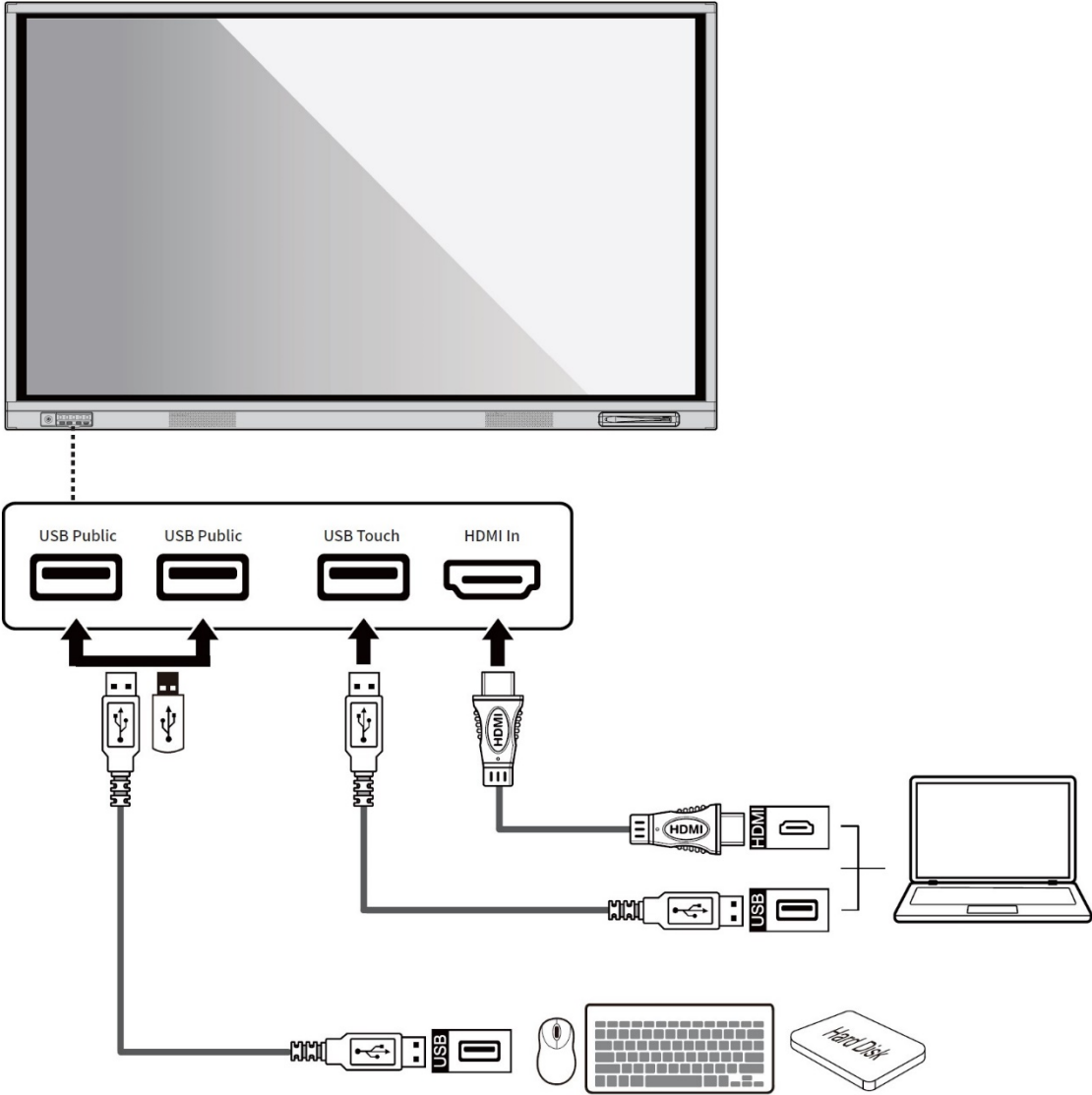

Rear Ports

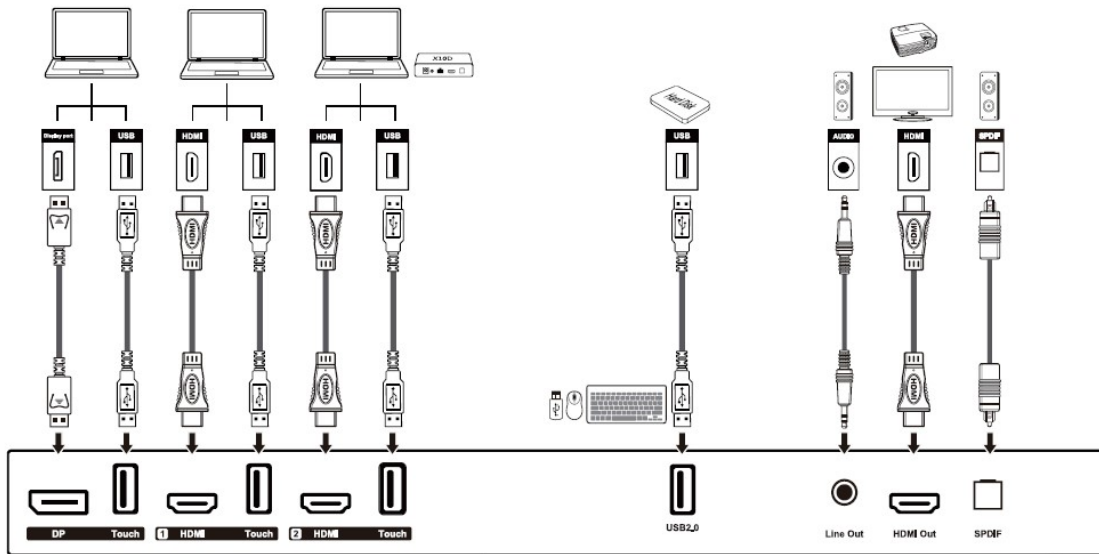

• 75" / 86"

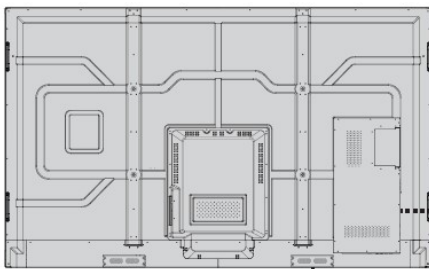

• 65"

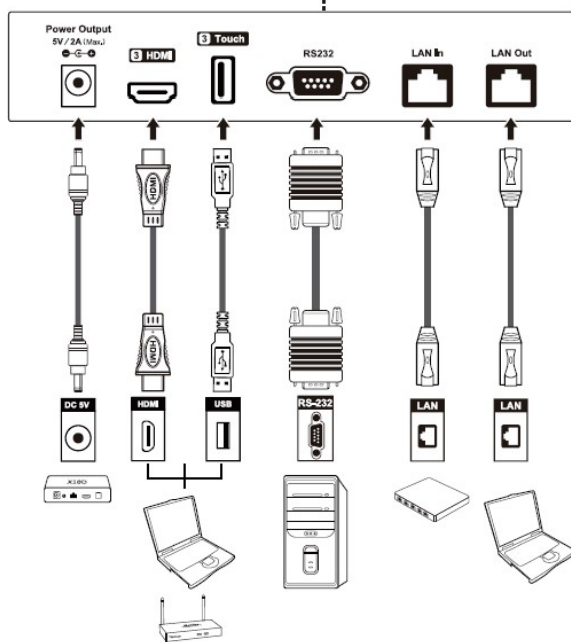
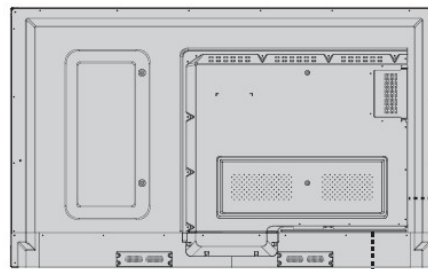

Remote Control

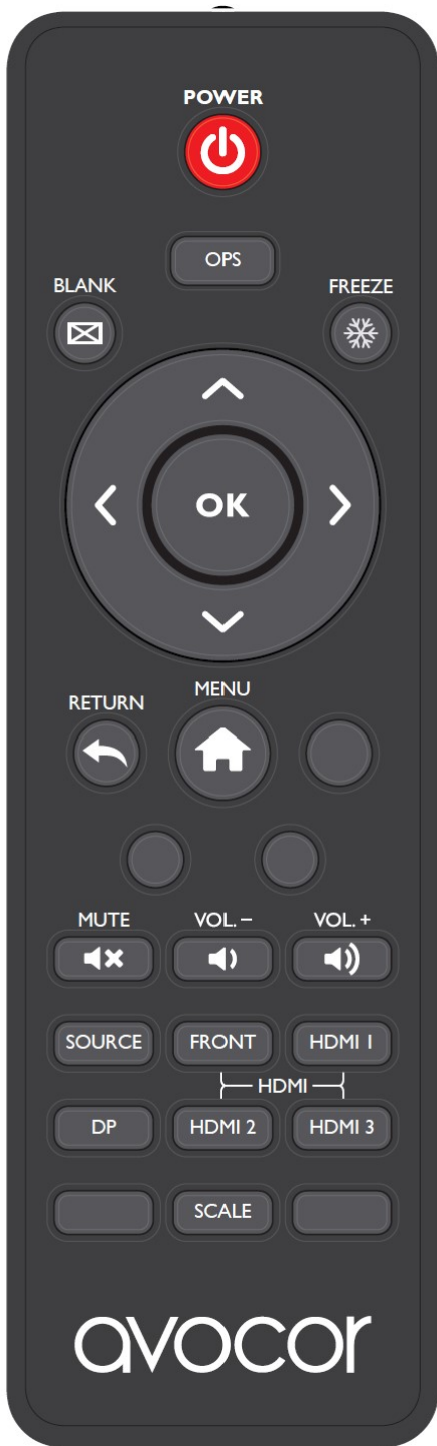

Label	Description
	Turns the display on and off.
	Select the OPS PC source.
	Blanks the display. Press again to restore.
	Freezes the display. Press again to restore.
	Navigates through menus and settings. Selects highlighted menu choice
	When the menu system is already open, pressing this button will close the on screen menu.
	Opens the display menu system.
	Mutes the audio. Pressing Mute again restores the audio
	Decreases the Volume by pressing the - key
	Increases the Volume by pressing the + key
	Opens the Source Menu.
	Selects DisplayPort
	Selects the HDMI Sources
	Selects each aspect ratio, in sequence: Full Screen, Auto, Pillar Box

Inserting the Batteries

To install batteries in the remote control:

1. Press down the tab on the cover plate and pull the cover plate up.
2. Insert the included batteries. Ensuring that the polarities correctly match the (+) and (-) markings inside the battery compartment.
3. Insert the lower tab of the cover into the opening, and press down the cover until it clicks in place.

Notes on Batteries

- Please only use approved AAA type batteries.
- Do not mix an old battery with a new one or different types of batteries.
- If you will not use the remote control for a long time, remove the batteries to avoid damage from battery leakage.
- Do not expose batteries to excessive heat such as from sunshine, fire or the like.
- Don't recharge, heat, disassemble, short or throw batteries into a fire.

Notes on Remote Control Operation

- Make sure that there is nothing obstructing the infrared beam between the remote control and the IR receiver on the display.
- If the effective range of the remote control decreases, or it stops working, replace the batteries with new ones.
- The remote control may fail to operate if the infrared remote sensor is exposed to bright sunlight or fluorescent lighting.
- Ambient conditions may possibly impede the operation of the remote control. If this happens, point the remote control at the display, and repeat the operation.

Remote Control Sensor

The effective area of the remote control includes the vertical distance within five metres in front of the display, and the area within an angle of 30 degrees from the vertical point to the left and the right.

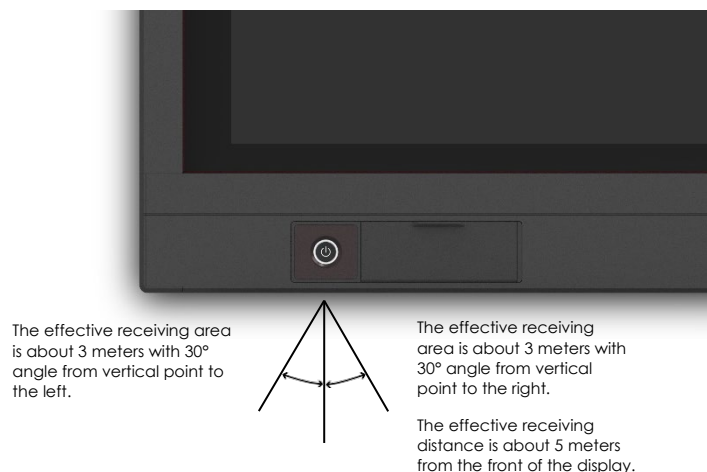

Switching the Avocor display on and off

Switching on

1. Plug the end of the supplied power cord into the display
2. Connect the other end to the power source.
3. Turn on the main power switch at the side of the display. The power LED indicator lights Red to indicate that the display is in "standby" mode.
4. Press the Power button and the power LED indicator on the left-hand side of the display will then light up in blue, which tells you that the screen is switched on.
5. After a brief warm-up period, the display will display an image

Switching off

1. Switch the display off by pressing the Power button on the display.
2. The display will then cycle and shut down.
3. The LED indicator on the display will switch from Blue to Red, which tells you that the screen is in standby mode.

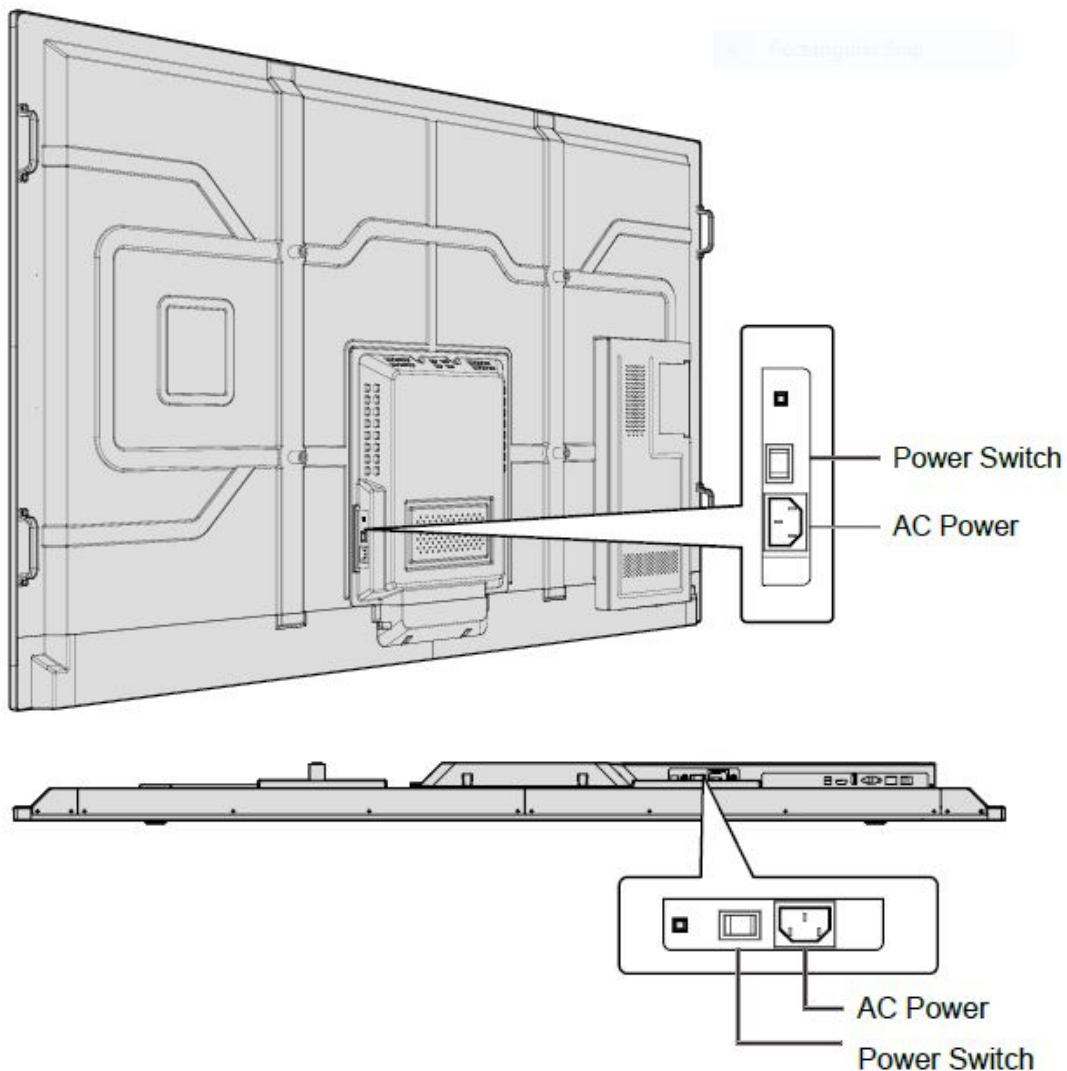

Selecting the Source

You can access a number of sources on the Avocor AVE displays including, HDMI, DisplayPort, & OPS.

The Source button is located on the Connect & Control Bar or on the Remote Control. Once the menu has been selected, you will see the option to select the source you require.

HDMI 1, HDMI 2, HDMI 3, DisplayPort, OPS, & Front HDMI

If there is no active signal from the chosen source, the screen will display the following message: "No Signal".

Connecting the Display

Proceed as follows to connect the display to your video sources, external controller.

When connecting your equipment:

1. Turn off all equipment before making any connections.
2. Use the correct signal cables for each source.
3. For best performance and to minimise cable clutter, use high-quality cables that are only as long as necessary to connect two devices. (Don't use a cable longer than 5 meters).
4. Ensure that the cables are securely connected.

Connecting to an external PC using a HDMI connection

In addition to a HDMI connection, a USB touch connection is required when connecting an external PC.

1. Connect the enclosed HDMI cable to the HDMI port of the touchscreen and to the external PC.
2. Connect the enclosed USB cable to the corresponding touch USB port (USB-A) of the touchscreen and to the USB port (USB-A) on the external PC.
3. Using the Remote Control select the HDMI source button or press the Source Button (see operating buttons) on the Front Connection bar to select HDMI.

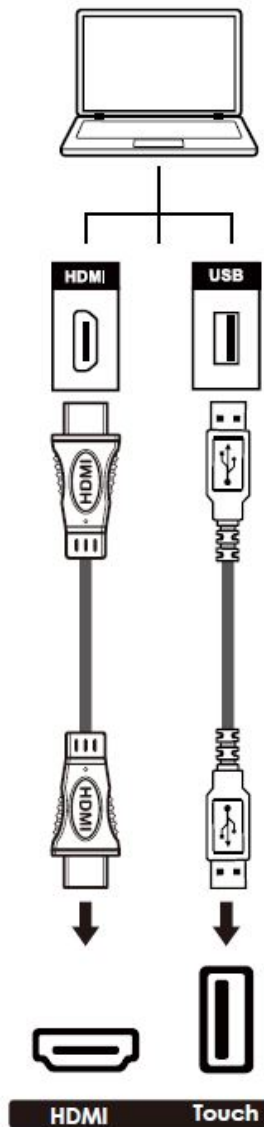

This display supports the VESA Display Data Channel (DDC) standard. This standard provides "Plug and Play" capability; the display and a VESA DDC-compatible computer communicate their setting requirements, allowing for quick and easy setup.

In order for Plug and Play to work correctly, you must turn on the display before you turn on the connected computer.

We recommend using a USB cable that is no longer than 5 metres.

Connecting to an external PC using a DisplayPort connection

In addition to a DisplayPort connection, a USB touch connection is required when connecting an external PC.

4. Connect a DisplayPort cable to the DisplayPort port of the touchscreen and to the external PC.
5. Connect the enclosed USB cable to the touch USB port (USB-A) of the touchscreen and to the USB port (USB-A) on the external PC.
6. Using the Remote Control select the DisplayPort source button or press the Source Button (see operating buttons) on the Front Connection bar to select DisplayPort.

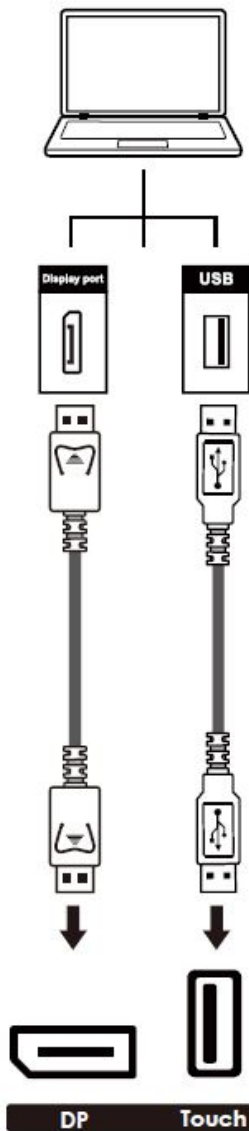

In order for Plug and Play to work correctly, you must turn on the display before you turn on the connected computer.

We recommend using a USB cable that is no longer than 5 metres.

Enabling the Touch Screen

Before setting up your display to support touch screen capability, ensure that:

- The touch screen controller host computer is turned off.
- The display is turned on.
- The video output from the computer is connected to a video input on the display.

Connecting the Display to a Host Computer

1. Connect the signal cable to the display, and then turn on the display.
2. Connect the USB Cable (USB Type-A connector) to the display.
3. Connect the other end of USB cable (USB Type-A) to the USB port on the laptop/ PC. See picture below.
4. Then turn on the computer.
5. When USB cable is fully connected, wait for 5 seconds and the touch function is ready. It can be activated by using the stylus or finger.

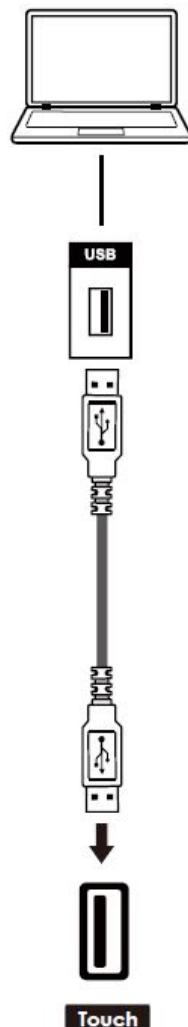

Installing an OPS Module

Follow the steps below to install an OPS module.

Step 1. Ensure that the display is turned off

Step 2. Use a screw driver to unscrew the OPS slot shield on the display input panel. Do not lose the screws that are removed.

Step 3. Install the OPS module by sliding it into the OPS slot until you hear a click, indicating the module is securely inserted. When using an Avocor OPS PC, the fan should be visible

Step 4. Secure the OPS module in position by screwing it onto the display input panel using the screws that were removed earlier.

Step 5. Ensure the installation is complete before turning on the power.

Step 6. Turn on the display. When using an Avocor OPS PC you should see a green light on the side of the OPS, this will indicate that the OPS PC is switched on and operational.

Note. When installing or de-installing an OPS PC, the display must be switched off. If the display is on when performing the installation or deinstallation of the OPS PC, this could cause damage to either the display or OPS PC *invalidating the warranty for both.*

Step 2

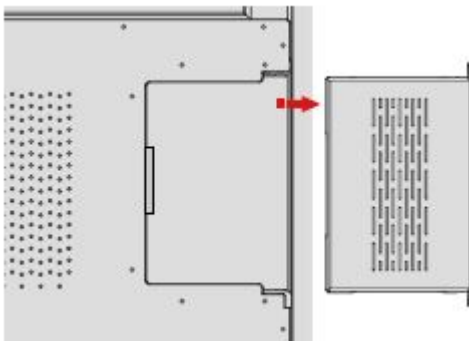

Step 3

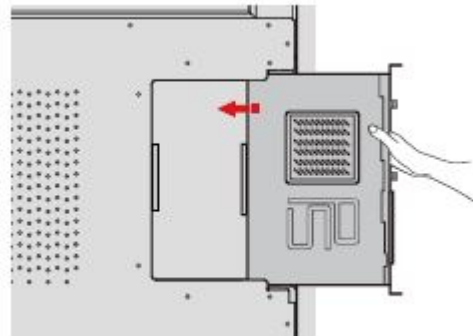

Step 4

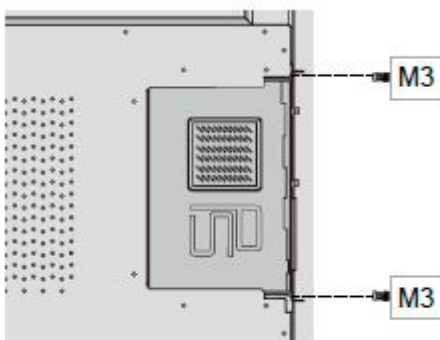

Step 5

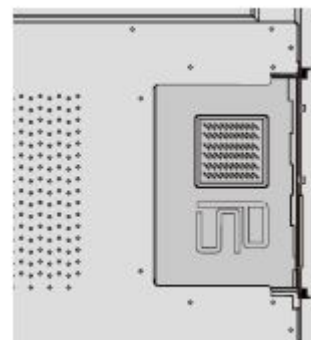

Connecting a Control System

RS232 Connection

Use a straight-through RS-232 cable with a 9-pin male connector to connect a PC or control/ automation system to the RS-232 port on the display.

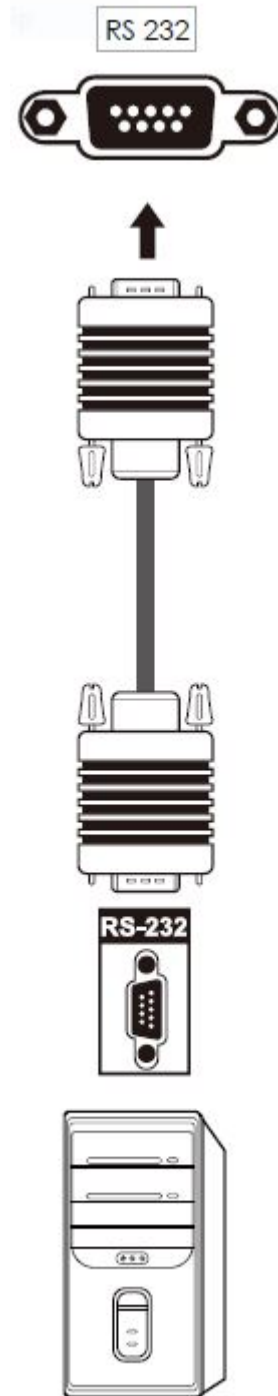

Using the On-Screen Display Menus

To display the on-screen menus, press MENU on the Connect & Control bar or on the Remote Control.

To select a menu, use the ▲ and ▼ buttons to highlight it. Then, press the ► key to enter that sub-menu

To select a menu item, use ▲ and ▼ buttons to highlight it. Then, press ▲ or ▼ to adjust that setting and press **OK**.

The on-screen menus can also be selected on the display by choosing the desired menu setting and selecting it by pressing on the display.

Picture Settings

Use the controls in the Picture Settings Menu to calibrate each display input to achieve optimum picture quality.

Picture Mode	<p>Press to select one of the following Picture Modes of the display</p> <p>Options: Standard / Soft / Bright / User</p> <p>Default: Standard</p>
Contrast	<p>Increase or decrease the picture contrast of the display</p> <p>Range: 0~100</p> <p>Default: 50</p>
Brightness	<p>Increase or decrease the picture brightness of the display</p> <p>Range: 0~100</p> <p>Default: 50</p>
Sharpness	<p>Increase or decrease the picture sharpness of the display</p> <p>Range: 0~100</p> <p>Default: 50</p>
Hue	<p>Increase or decrease the green hue of the display</p> <p>Range: 0~100</p> <p>Default: 50</p>
Saturation	<p>Adjust the brilliance and brightness of the display</p> <p>Range: 0~100</p> <p>Default: 50</p>
RGB Screen Adjustment	
Colour Temp	<p>Select a Colour Temperature, to fine tune select the RGB adjustments.</p> <p>Options: User / Cold / Natural / Warm</p> <p>Default: User</p> <p>Red: 0~2048</p> <p>Default: 1024</p> <p>Green: 0~2048</p> <p>Default: 1024</p> <p>Blue: 0~2048</p> <p>Default: 1024</p>
Image Noise Reduction	<p>Select Image Noise Reduction of the display</p> <p>Options: Off / Middle / Strong / Auto</p> <p>Default: Off</p>
MPEG Noise Reduction	<p>Select MPEG Noise function of the display</p> <p>Options: Off / Middle / Strong / Auto</p> <p>Default: Off</p>
XvYCC Colour	<p>Select the XvYCC function of the display</p> <p>Options: Off / On</p> <p>Default: Off</p>

Audio Settings

This menu is used for adjusting audio settings.

Sound Mode	<p>Press to select one of the following Sound Modes of the display.</p> <p>Options: Standard / Music / Sports / User</p> <p>Default: Standard</p>
Bass	<p>Select Bass from the Audio Settings menu to cut or boost the low audio frequencies.</p> <p>Range: 0~100</p> <p>Default: 50</p>
Treble	<p>Select Treble from the Audio Settings menu to cut or boost the high audio frequencies.</p> <p>Range: 0~100</p> <p>Default: 50</p>
Equalizer	<p>Select Equalizer and press ENTER to cut or boost individual frequencies.</p>
	<p>Select 120Hz from the Audio Settings menu to cut or boost the frequency.</p> <p>Range: 0~100</p> <p>Default: 50</p>
	<p>Select 500Hz from the Audio Settings menu to cut or boost the frequency.</p> <p>Range: 0~100</p> <p>Default: 50</p>
	<p>Select 1.5KHz from the Audio Settings menu to cut or boost the frequency.</p> <p>Range: 0~100</p> <p>Default: 50</p>
	<p>Select 5KHz from the Audio Settings menu to cut or boost the frequency.</p> <p>Range: 0~100</p> <p>Default: 50</p>
	<p>Select 10KHz from the Audio Settings menu to cut or boost the frequency.</p> <p>Range: 0~100</p> <p>Default: 50</p>
Balance	<p>Select Balance from the Audio Settings To adjust the left/right speaker balance.</p> <p>Range: 0~100</p> <p>Default: 50</p>
Surround	<p>Select Surround from the Audio Settings of the display</p> <p>Options: Off / On</p> <p>Default: Off</p>
SRS	<p>Select SRS from the Audio Settings of the display</p> <p>Options: Off / On</p> <p>Default: Off</p>
SPDIF	<p>Select SPDIF from the Audio Settings of the display</p> <p>Options: Off / PCM / RAW</p> <p>Default: Off</p>

OSD Menu Settings

This menu is used to make initial set-up adjustments to the OSD (On-Screen Display) menu and other on-screen messages.

Language Setting	Select and press ENTER to change the language of the display Options: English / French / Italian / German; Spanish / Finnish / Swedish / Norwegian / Dutch / Danish / Arabic / Russian / Slovenian / Serbian / Croatian / Hungarian / Slovakian / Polish Default: English
Menu Time	Press to select to specify how long the menus remain on screen Options: 5 / 10 / 15 / 20 seconds / Always Default: 5 Seconds
HDMI Settings	Select and press ENTER to change the Colour Range
Colour Range	Press to select the Colour Range of the display Options: Auto / 0~255 / 16~235 Default: Auto
Source Scan	Select Source Scan of the display Options: Auto / Manual / Off Default: Auto
Backlight Setting	Select and press ENTER to change the Backlight Setting of the display
Backlight Mode	Select to change the Backlight Mode of the display Range: Auto / Standard / Energy Saving Range: 0~100 Default: Auto
Backlight Level	Select to change the Backlight Level of the display Range: 0~100 Default: 20
Light Response	Select to change the Light Response Setting of the display Options: Fast / Slow Default: TBC when the description has been confirmed
Boot Setting	Select and press ENTER to change the Boot Settings of the display
Boot Source	Select to change the Boot Source of the display Options: Last / Fixed If Fixed is selected Options: OPS / HDMI / HDMI 1 / HDMI 2 / HDMI 3 / Post HDMI

OPS Start Up	Select to change the OPS Start Up of the display Options: Only OPS Source / Any Source Default: Only OPS Source
Wake on LAN	Select to enable WOL / Wake on LAN of the display Options: On / Off Default: Off
Temperature Setting	Select Temperature Settings to change the Temperature of the display Options: °C / °F Default: °C
Time	Select and press ENTER to change the Time Settings of the display
Date	Select Date to change the Date of the display
Current Time	Select Current Time to change the Time of the display
Off Time	Select Off Timer of the display Options: On / Off Default: Off
Boot Time	Select Boot Timer of the display Options: On / Off Default: Off
Sleep Timer	Select Sleep Timer of the display Options: 10 / 20 /30 / 60 / 90 / 120 / 180 / 240 Minutes Default: Off
No Signal Shutdown	Select No Signal Shutdown of the display Options: One / Off Default: Off
HDMI Output	Select HDMI Output of the display Options: 720 x 480 / 1920 x 1080 / 3840 x 2160 Default: 3840 x 2160
Network Info	Select and press ENTER to Network Info Here you will be able to review your MAC address and Network IP address
Restore to Default Settings	Select to Restore to Default Settings, please follow screen prompt if selecting Options: Yes / No

RS-232 Command Codes

Connect RS-232 port to the PC or controlling product. Enable RS-232 serial port connection and complete the following configuration.

Port: COM1 (Set according to PC or controlling product's port number)			
Baud rate	38400	Odd/even check	None
Data bits	8	Stop bit	1

Function	Controlling codes	Return codes
Power On	7F 08 99 A2 B3 C4 02 FF 01 00 CF	7F 09 99 A2 B3 C4 02 FF 01 00 01 CF
Power Off	7F 08 99 A2 B3 C4 02 FF 01 01 CF	7F 09 99 A2 B3 C4 02 FF 01 01 01 CF
Mute / Unmute	7F 08 99 A2 B3 C4 02 FF 01 02 CF	7F 09 99 A2 B3 C4 02 FF 01 02 01 CF
Display Status	7F 08 99 A2 B3 C4 02 FF 01 09 CF	7F 09 99 A2 B3 C4 02 FF 01 09 01 CF
Source	7F 08 99 A2 B3 C4 02 FF 01 06 CF	7F 09 99 A2 B3 C4 02 FF 01 06 01 CF
HDMI Front	7F 08 99 A2 B3 C4 02 FF 01 51 CF	7F 09 99 A2 B3 C4 02 FF 01 51 01 CF
HDMI 1 (Side)	7F 08 99 A2 B3 C4 02 FF 01 0A CF	7F 09 99 A2 B3 C4 02 FF 01 0A 01 CF
HDMI 2 (Side)	7F 08 99 A2 B3 C4 02 FF 01 0B CF	7F 09 99 A2 B3 C4 02 FF 01 0B 01 CF
HDMI 3 (Under)	7F 08 99 A2 B3 C4 02 FF 01 0C CF	7F 09 99 A2 B3 C4 02 FF 01 0C 01 CF
DisplayPort	7F 08 99 A2 B3 C4 02 FF 01 56 CF	7F 09 99 A2 B3 C4 02 FF 01 56 01 CF
OPS	7F 08 99 A2 B3 C4 02 FF 01 38 CF	7F 09 99 A2 B3 C4 02 FF 01 38 01 CF
Page Up	7F 08 99 A2 B3 C4 02 FF 01 13 CF	7F 09 99 A2 B3 C4 02 FF 01 13 01 CF
Page Down	7F 08 99 A2 B3 C4 02 FF 01 14 CF	7F 09 99 A2 B3 C4 02 FF 01 14 01 CF
Vol -	7F 08 99 A2 B3 C4 02 FF 01 17 CF	7F 09 99 A2 B3 C4 02 FF 01 17 01 CF
VOL +	7F 08 99 A2 B3 C4 02 FF 01 18 CF	7F 09 99 A2 B3 C4 02 FF 01 18 01 CF
Menu	7F 08 99 A2 B3 C4 02 FF 01 1B CF	7F 09 99 A2 B3 C4 02 FF 01 1B 01 CF
Home Page	7F 08 99 A2 B3 C4 02 FF 01 1C CF	7F 09 99 A2 B3 C4 02 FF 01 1C 01 CF
Return (exit)	7F 08 99 A2 B3 C4 02 FF 01 1D CF	7F 09 99 A2 B3 C4 02 FF 01 1D 01 CF
OK	7F 08 99 A2 B3 C4 02 FF 01 2B CF	7F 09 99 A2 B3 C4 02 FF 01 2B 01 CF
←	7F 08 99 A2 B3 C4 02 FF 01 2C CF	7F 09 99 A2 B3 C4 02 FF 01 2C 01 CF
→	7F 08 99 A2 B3 C4 02 FF 01 2D CF	7F 09 99 A2 B3 C4 02 FF 01 2D 01 CF
↑	7F 08 99 A2 B3 C4 02 FF 01 2E CF	7F 09 99 A2 B3 C4 02 FF 01 2E 01 CF
↓	7F 08 99 A2 B3 C4 02 FF 01 2F CF	7F 09 99 A2 B3 C4 02 FF 01 2F 01 CF
Firmware Version	7F 08 99 A2 B3 C4 02 FF 01 3D CF	7F 09 99 A2 B3 C4 02 FF 01 3D 01 CF
Set Volume	7F 08 99 A2 B3 C4 02 FF 05 XX CF	7F 09 99 A2 B3 C4 02 FF 05 XX 01 CF
	Note: XX indicates the volume value (0 to 100), corresponding to the hexadecimal 00 to 64.	
Sound Mode	7F 08 99 A2 B3 C4 02 FF 01 05 CF	7F 09 99 A2 B3 C4 02 FF 01 05 01 CF
Set Display Mode	7F 08 99 A2 B3 C4 02 FF 06 XX CF	7F 09 99 A2 B3 C4 02 FF 06 XX 01 CF
	<ul style="list-style-type: none"> • XX = 00 indicates the Standard mode. • XX = 01 indicates the Energy Star mode • XX = 02 indicates the Auto mode. 	
Increase Backlight	7F 08 99 A2 B3 C4 02 FF 01 47 CF	7F 09 99 A2 B3 C4 02 FF 01 47 01 CF
Decrease Backlight	7F 08 99 A2 B3 C4 02 FF 01 48 CF	7F 09 99 A2 B3 C4 02 FF 01 48 01 CF
Freeze	7F 08 99 A2 B3 C4 02 FF 01 3B CF	7F 09 99 A2 B3 C4 02 FF 01 3B 01 CF
Blank / Switch Backlight	7F 08 99 A2 B3 C4 02 FF 01 15 CF	7F 09 99 A2 B3 C4 02 FF 01 15 01 CF
	Note: Use Backlight Status Command to confirm status	
Set the Value of	7F 08 99 A2 B3 C4 02 FF 09 XX CF	7F 09 99 A2 B3 C4 02 FF 09 XX 01 CF

Backlight Brightness	Note: XX indicates the value of backlight brightness (0 - 100), corresponding to the hexadecimal (00 - 64).	
Settings	7F 08 99 A2 B3 C4 02 FF 01 20 CF	7F 09 99 A2 B3 C4 02 FF 01 20 01 CF
Power Supply	7F 08 99 A2 B3 C4 02 FF 01 37 CF	7F 09 99 A2 B3 C4 02 FF 01 37 XX CF
	<ul style="list-style-type: none"> • XX = 01 indicates power on state. • XX = 00 indicates power off state. 	
Audio On / Off	7F 08 99 A2 B3 C4 02 FF 01 82 CF	7F 08 99 A2 B3 C4 02 FF 01 82 XX CF
	<ul style="list-style-type: none"> • XX = 01 indicates mute on • XX = 00 indicates mute off 	
Current Signal Source	7F 08 99 A2 B3 C4 02 FF 01 50 CF	7F 09 99 A2 B3 C4 02 FF 01 50 XX CF
	<ul style="list-style-type: none"> • DP = 20 • HDMI Side 1 = 1F • HDMI Side 2 = 1E • HDMI Under 3 = 18 • HDMI Front = 19 	
Speaker Volume	7F 08 99 A2 B3 C4 02 FF 01 33 CF	7F 09 99 A2 B3 C4 02 FF 01 33 XX CF
	Note: XX indicates current volume value (XX is a hexadecimal value, range: 00~64).	
	Example: XX = 20 indicates current volume value is 32 (decimal value), XX = 00 indicates mute state.	
D.Mode	7F 08 99 A2 B3 C4 02 FF 01 35 CF	7F 09 99 A2 B3 C4 02 FF 01 35 XX CF
	Note: XX indicates the mode. 00 and 01 indicates standard and eco modes respectively.	
Backlight Brightness	7F 08 99 A2 B3 C4 02 FF 01 49 CF	7F 09 99 A2 B3 C4 02 FF 01 49 XX CF
	Note: XX indicates the value of backlight brightness (0 - 100), corresponding to the hexadecimal (00 - 64).	
Backlight Status	7F 08 99 A2 B3 C4 02 FF 01 81 CF	7F 08 99 A2 B3 C4 02 FF 01 81 XX CF
	<ul style="list-style-type: none"> • XX = 00 indicates the backlight is on. • XX = 01 indicates the backlight is off. 	

Display Dimensions

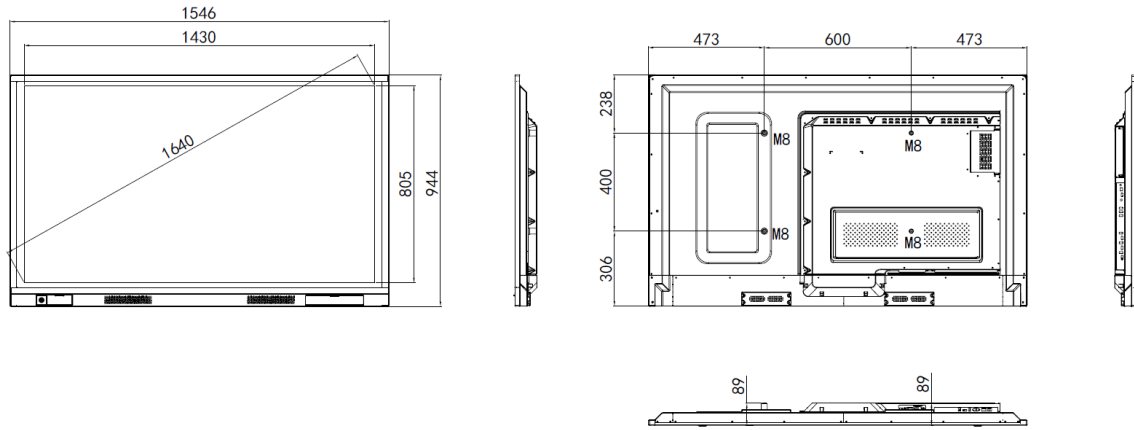

65" Dimensions

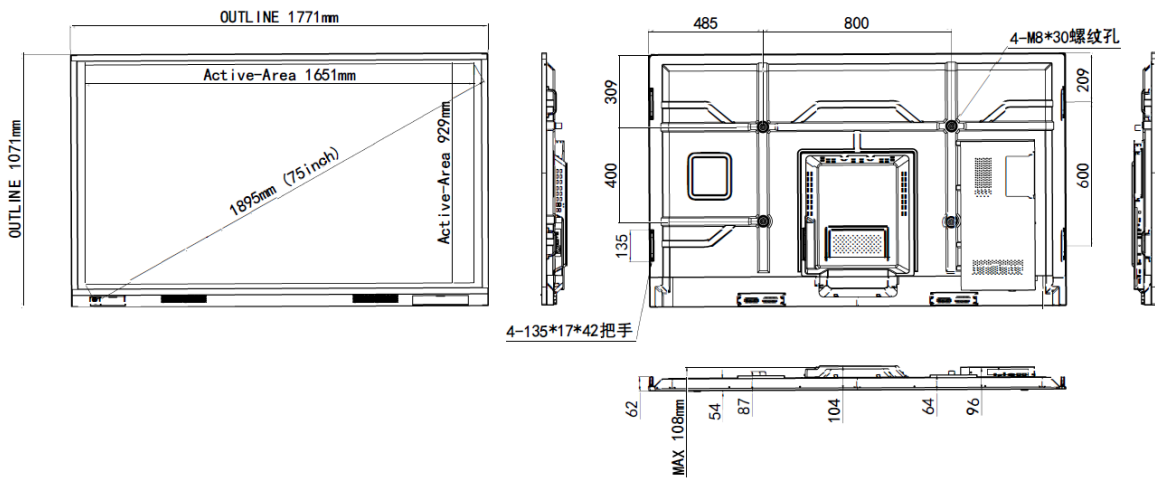

75" Dimensions

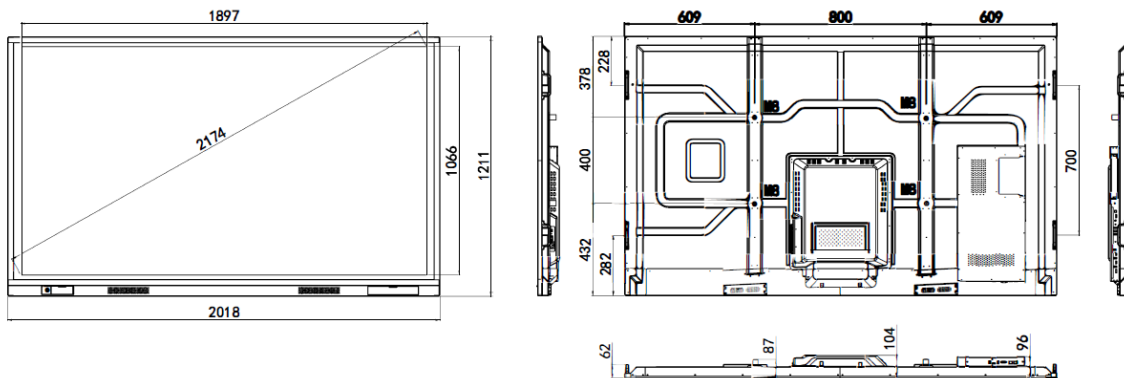

86" Dimensions

Area	Symptom	Solution
Power	The display does not turn on.	<ul style="list-style-type: none"> Ensure that the display is plugged in and that the AC outlet is active. Set the main power switch to on
Image	I have no image on the display	<ul style="list-style-type: none"> Check there is power to the display Check the power switch is in the on position Check the external PC is outputting a picture signal correctly. Check the external PC connection cables are properly seated. Check the OPS PC is correctly seated Bypass any wall plates connections for testing
Remote Control	The remote control does not work.	<ul style="list-style-type: none"> Replace the batteries. Ensure that the polarities correctly match the (+) and (-) markings inside the battery compartment. Make sure that there is nothing obstructing the infrared beam between the remote control and the IR receiver on the display The remote control may fail to operate if the infrared remote sensor is exposed to bright sunlight or fluorescent lighting.
Touch	Touch screen doesn't work.	<ul style="list-style-type: none"> Check the USB cable from source to display is connected correctly Check USB cable length is not over 5m Try a different USB cable Connect to the display from the external PC and bypass any USB wall plates connections for testing Check the drivers Check the external PC or Operating System compatibility.
Audio	The sound isn't working.	<ul style="list-style-type: none"> Is the volume level higher than 0 Is the volume level in Microsoft Windows higher than 0 Is the Mute function activated If using an external PC, is the audio / optical cables are properly seated
Freeze Frame	How do I use the screen's Freeze function?	<ul style="list-style-type: none"> The Freeze function can be activated using the Freeze button on the remote control . When activated, the image will continue to be displayed and "Freeze" will appear on the display. To deactivate press Freeze again
Blank Out	How do I use the screen's Blank Out function?	<ul style="list-style-type: none"> The Blank Out function can be activated using the Blank Out button on the remote control. To deactivate press Blank again
Image Quality	Screen Resolution	<ul style="list-style-type: none"> Check the screen resolution.
	The display is jittery or unstable.	<ul style="list-style-type: none"> Ensure that the source is properly connected and of adequate quality for detection. Correct at the source. The horizontal or vertical scan frequency of the input signal may be out of range for the display.
	Image is too bright and / or lacks definition in the bright areas of the image	<ul style="list-style-type: none"> Check the level of Contrast and adjust accordingly.
	Image appears "washed out" and / or dark areas appear too bright.	<ul style="list-style-type: none"> Check the level of brightness and decrease the brightness accordingly.
	Image is too dark.	<ul style="list-style-type: none"> Check the level of the brightness and / or backlight and change accordingly.
Cleaning	Images from an HDMI source do not display.	<ul style="list-style-type: none"> Select a compatible resolution Check the HDMI cable from source to display is connected correctly, try an alternative HDMI cable Select a compatible resolution
	Images do not display correctly.	<ul style="list-style-type: none"> Please wipe the surface lightly with a soft clean cloth If the surface requires additional cleaning, lightly moisten the cloth. Do not spray directly onto the interactive touch screen Do not let any kind of liquid enter the display as it may cause electrical shock or damage. Do not clean the display with alcohol, solvents or ammonia, as this could damage the display.

For further FAQ's please visit <http://www.avocor.com/support>

Warranty Support

Should you require assistance with any suspected hardware fault, please contact the Warranty Support team. Please provide as much information to the support team about the fault and any steps you have taken in trying to try and resolve the fault.

Remember the first instance to look for known faults and how to resolve them on the avocor Website www.avocor.com/support

Organization Name	
Contact Person	
1st Contact Number (Landline)	
2nd Contact Number (Mobile/Cell)	
Email	
Address (of on-site repair or unit exchange)	
City	
State	
Postcode/ZIP	
County/State	
Days and hours of operation	
Loading & Parking Available? (Yes or No)	

Reseller Information (If Known)	
Organization Name	
Contact Person	
Contact Number (Landline)	
Email	

Product Information	
Product / Model	
Serial Number	
Date of Purchase (If Known)	



UK Warranty Support

service@avocor.com

avocor