



3600-4600 Series User's Guide

Contents

Safety information.....	9
Introduction.....	10
Finding information about the printer.....	10
Setting up the printer.....	13
Bypassing security warnings during software installation.....	13
Setting up the printer as a copier only.....	13
Understanding the parts of the printer.....	18
Using the printer control panel buttons and menus.....	20
Using the printer control panel	20
Using the printer menus	22
Using the Copy menu.....	24
Using the Scan menu	25
Using the Photo menu.....	25
Using the PictBridge menu	26
Using the Setup menu	26
Saving settings.....	27
Using the printer software.....	29
Installing printer software	29
Installing the optional XPS driver (Windows Vista users only)	30
Using the Windows printer software.....	31
Using the Macintosh printer software.....	32
Switching between the rear USB port and the Quick Connect laptop port (selected models only).....	33
Installing the printer on a wireless network (selected models only).....	35
Wireless network compatibility.....	35
Information you will need to set up the printer on a wireless network.....	35
Installing the printer on a wireless network.....	36
Wireless installation instructions (France only).....	36
Configuring an IP address manually.....	37
Interpreting the colors of the Wi-Fi indicator light.....	37
Changing wireless settings after installation.....	38
Using the Network Setup menu.....	38
Installing the printer on other computers.....	39

Advanced wireless setup.....	40
Creating an ad hoc wireless network	40
Adding a printer to an existing ad hoc wireless network	43
Frequently asked questions.....	44
What is a network?	44
How are home networks configured?	44
Why do I need an installation cable?	46
How do I attach the installation cable?.....	47
What is the difference between infrastructure and ad hoc networks?	47
Finding the signal strength.....	48
How can I improve wireless signal strength?	49
What is an SSID?	50
How do I find out what type of security my network is using?	50
Can I use my printer on a USB and a wireless connection at the same time?.....	50
What is a MAC address?	51
How do I find the MAC address?	51
What is an IP address?	51
What is TCP/IP?	52
How do I locate IP addresses?	52
How are IP addresses assigned?	53
What is a key index?	53

Loading paper.....54

Loading paper.....	54
Loading various paper types.....	54
Loading original documents on the scanner glass.....	58
Using the automatic paper type sensor.....	59

Printing.....60

Printing basic documents.....	60
Printing a document.....	60
Printing Web pages.....	60
Printing multiple copies of a document.....	61
Collating printed copies.....	61
Printing the last page first (reverse page order).....	62
Printing multiple pages on one sheet (N-Up).....	62
Printing documents from a memory card or flash drive	63
Printing specialty documents.....	64
Choosing compatible specialty paper types	64
Printing envelopes	65
Printing labels	65
Printing on custom-size paper.....	66

Saving and deleting print settings.....	67
Managing print jobs.....	68
Pausing print jobs.....	68
Resuming print jobs.....	69
Canceling print jobs.....	70
Working with photos.....	72
Inserting a memory card.....	72
Inserting a flash drive.....	73
Retrieving and managing photos.....	74
Transferring photos from a memory device to the computer	74
Transferring photos from a memory card to a flash drive	76
Printing photos.....	76
Printing photos using the printer control panel	76
Printing photos from the computer using the printer software	77
Printing photos from a memory device using the printer software	77
Applying color effects to photos using the printer control panel	78
Printing photos from a PictBridge-enabled digital camera	79
Printing photos stored on a memory device using the proof sheet	80
Printing photos from a digital camera using DPOF	81
Copying.....	82
Making copies.....	82
Copying photos.....	82
Enlarging or reducing images.....	82
Adjusting copy quality.....	83
Making a copy lighter or darker.....	83
Collating copies using the printer control panel.....	83
Repeating an image on one page.....	84
Copying multiple pages on one sheet (N-Up).....	84
Canceling a copy job.....	85
Scanning.....	86
Scanning original documents.....	86
Scanning color or black-and-white original documents.....	88
Scanning photos for editing.....	88
Scanning to a computer over a network.....	88
Canceling scan jobs.....	89

Faxing.....	90
Sending a fax using the computer.....	90
Receiving a fax.....	91
Maintaining the printer.....	93
Maintaining print cartridges.....	93
Installing print cartridges.....	93
Removing a used print cartridge	94
Refilling print cartridges.....	95
Using genuine Lexmark print cartridges.....	95
Aligning print cartridges	96
Cleaning the print cartridge nozzles.....	96
Checking ink levels.....	97
Wiping the print cartridge nozzles and contacts	98
Preserving the print cartridges	99
Cleaning the scanner glass.....	99
Cleaning the exterior of the printer.....	99
Ordering supplies.....	100
Ordering print cartridges	100
Ordering paper and other supplies.....	101
Resetting to factory settings.....	101
Troubleshooting.....	102
Using the printer troubleshooting software (Windows only).....	102
Setup troubleshooting.....	102
Incorrect language appears on the display.....	102
Power button is not lit	103
Software did not install.....	103
Page does not print.....	104
Solving printer power problems	107
Removing and reinstalling the software	107
Enabling the USB port in Windows	108
Wireless troubleshooting.....	109
Wireless troubleshooting checklist	109
Printing a network setup page	110
Wireless configuration does not continue after the USB cable is attached	110
Cannot print over wireless network.....	111
Cannot print and there is a firewall on the computer	114
Wi-Fi indicator light is not lit.....	114
Wi-Fi indicator light is green but the printer does not print (Windows only)	114
Wi-Fi indicator light is blinking orange during installation (Windows only).....	116

Wi-Fi indicator light is blinking orange during installation (Macintosh only)	119
Wi-Fi indicator light is still orange	121
Wireless print server not installed	123
“Communication not available” message displays when printing wirelessly	123
Communication with printer lost when connected to Virtual Private Network (VPN).....	123
Resetting the internal wireless print server to factory default settings	123

Notices..... 125

Product information.....	125
Edition notice.....	125
European EC directives conformity statement for radio products.....	128
Power consumption.....	131

Networking glossary..... 136

Index..... 138

Safety information

Use only the power supply and power supply cord provided with this product or the manufacturer's authorized replacement power supply and power supply cord.

Connect the power supply cord to an electrical outlet that is near the product and easily accessible.

 **CAUTION—POTENTIAL INJURY:** Do not twist, bind, crush, or place heavy objects on the power cord. Do not subject the power cord to abrasion or stress. Do not pinch the power cord between objects such as furniture and walls. If the power cord is misused, a risk of fire or electrical shock results. Inspect the power cord regularly for signs of misuse. Remove the power cord from the electrical outlet before inspecting it.

Refer service or repairs, other than those described in the user documentation, to a professional service person.

This product is designed, tested, and approved to meet strict global safety standards with the use of specific Lexmark components. The safety features of some parts may not always be obvious. Lexmark is not responsible for the use of other replacement parts.



 **CAUTION—SHOCK HAZARD:** Do not set up this product or make any electrical or cabling connections, such as the power supply cord or telephone, during a lightning storm.

SAVE THESE INSTRUCTIONS.

Introduction

Finding information about the printer

Publications

See the	For
<i>Quick Setup</i> sheet	Initial setup instructions.
Printed <i>Networking Guide / Fax Guide</i>	Additional setup instructions. Note: Your printer may not come with these publications.
Electronic <i>User's Guide</i>	Complete instructions for using the printer. The electronic version installs automatically with the printer software.
Windows Help	Additional instructions for using the printer software on a Windows operating system. The Help installs automatically with the programs. <ol style="list-style-type: none">1 Do one of the following:<ul style="list-style-type: none">• In Windows Vista, click .• In Windows XP and earlier, click Start.2 Click All Programs or Programs, and then select the printer program folder from the list.3 From the program, click Help to view the main page of the Help. Click  to view context-sensitive information.
Mac Help Note: Your printer may not have support for Macintosh and may not have this Help.	Additional instructions for using the printer software on a Macintosh operating system. The Help installs automatically with the applications. <ol style="list-style-type: none">1 From the Finder desktop, double-click the printer folder.2 Double-click the application.3 From the application, click Help on the menu bar to view the main page of the Help. Note: If you have several applications open, then make sure that the application that you want to use is the active application. The correct menu bar does not appear if the application is not active. Click the main screen to make it the active application. Click  to view context-sensitive information.

Customer support

Description	Where to find (North America)	Where to find (rest of world)
<p>Telephone support</p>	<p>Call us at</p> <ul style="list-style-type: none"> • US: 1-800-332-4120 <ul style="list-style-type: none"> – Monday–Friday (8:00 AM–11:00 PM ET), Saturday (Noon–6:00 PM ET) • Canada: 1-800-539-6275 <ul style="list-style-type: none"> – Support in English: Monday–Friday (8:00 AM–11:00 PM ET), Saturday (Noon–6:00 PM ET) – Support in French: Monday–Friday (9:00 AM–7:00 PM ET) • Mexico: 01-800-253-9627 <ul style="list-style-type: none"> – Monday–Friday (8:00 AM–8:00 PM ET) <p>Note: Support numbers and times may change without notice. For the most recent telephone numbers available, see the printed warranty statement that came with your printer.</p>	<p>Telephone numbers and support hours vary by country or region.</p> <p>Visit our Web site at www.lexmark.com. Select a country or region, and then select the Customer Support link.</p> <p>Note: For additional information about contacting Lexmark, see the printed warranty that came with your printer.</p>
<p>E-mail support</p>	<p>For e-mail support, visit our Web site: www.lexmark.com.</p> <ol style="list-style-type: none"> 1 Click SUPPORT. 2 Click Technical Support. 3 Select your printer family. 4 Select your printer model. 5 From the Support Tools section, click e-Mail Support. 6 Complete the form, and then click Submit Request. 	<p>E-mail support varies by country or region, and may not be available in some instances.</p> <p>Visit our Web site at www.lexmark.com. Select a country or region, and then select the Customer Support link.</p> <p>Note: For additional information about contacting Lexmark, see the printed warranty that came with your printer.</p>

Limited Warranty

Description	Where to find (USA)	Where to find (rest of world)
<p>Limited Warranty Information Lexmark International, Inc. furnishes a limited warranty that this printer will be free of defects in materials and workmanship for a period of 12 months after the original date of purchase.</p>	<p>To view the limitations and conditions of this limited warranty, see the Statement of Limited Warranty included with this printer, or set forth at www.lexmark.com.</p> <ol style="list-style-type: none"> 1 Click SUPPORT. 2 Click Warranty Information. 3 Click Statement of Limited Warranty for Inkjet & All-In-One Printers. 4 Scroll through the Web page to view the warranty. 	<p>Warranty information varies by country or region. See the printed warranty that came with your printer.</p>

Record the following information (located on the store receipt and the back of the printer), and have it ready when you contact customer support so that they may serve you faster:

- Machine Type number
- Serial number
- Date purchased
- Store where purchased

Setting up the printer

Bypassing security warnings during software installation

Third-party applications, including antivirus, security, and firewall programs may alert you about the printer software being installed. For your printer to work properly, allow the printer software to be installed on your computer.

Setting up the printer as a copier only

Use the following instructions if you do not want to connect the printer to a computer.

Note: If you want to connect the printer to a computer, use the setup documentation and the printer software CD that came with the printer.

- 1 Unpack the printer.

Note: Contents, such as the number of print cartridges, may vary by model.

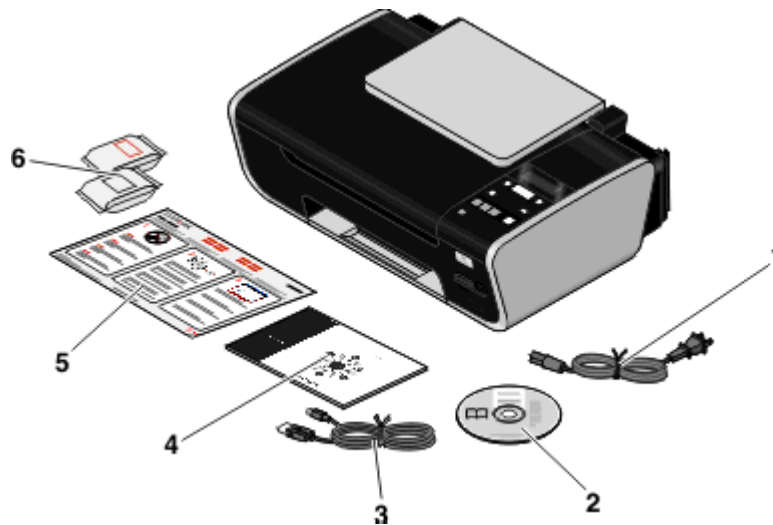

1	Power cord
2	Printer software CD
3	USB cable or installation cable Note: Your printer model may not ship with a USB cable. Purchase a USB cable separately.
4	<i>Networking Guide</i> Note: Your printer model may not come with this publication.
5	<i>Quick Setup</i> sheet
6	Print cartridges

2 Remove all tape and packing material from all areas of the printer.

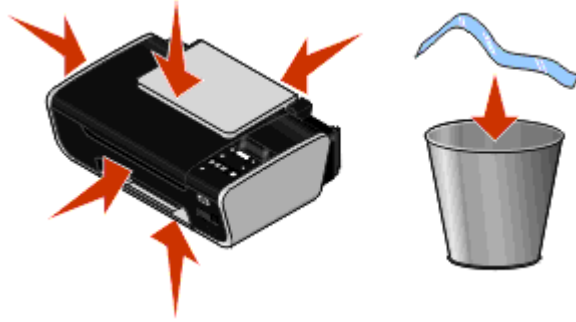

3 Raise the paper support, and then extend the paper exit tray.



4 Extend the paper guides.

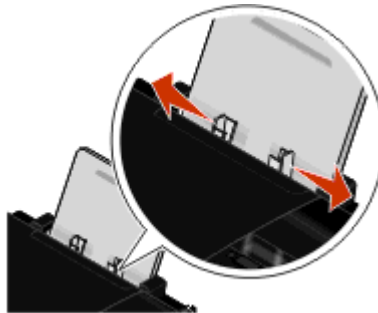

5 Connect the power cord to the printer, and then to an electrical outlet that is easily accessible and near the printer.



6 Press  to turn on the printer.

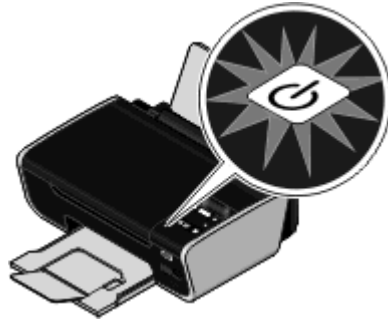

7 If prompted, set the language.

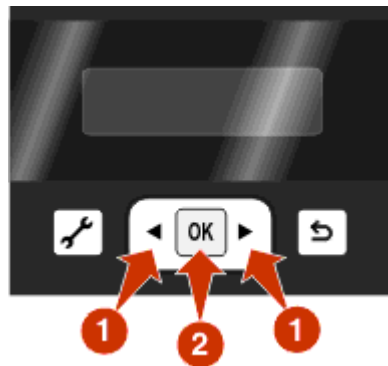

8 If prompted, set the country/region.

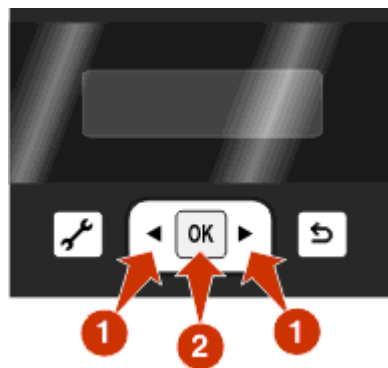

9 Open the printer, and then press down on the print cartridge carrier levers.



10 Open the color cartridge foil, and then remove the cartridge from the pack.

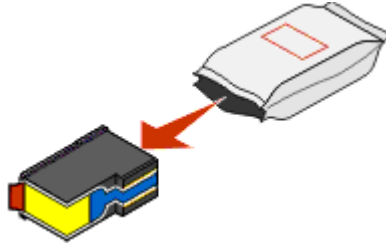

11 If a storage unit is included, remove the color cartridge from the storage unit.

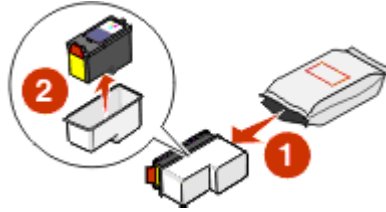

12 Remove the tape from the color print cartridge, insert the cartridge in the right carrier, and then close the color cartridge lid.

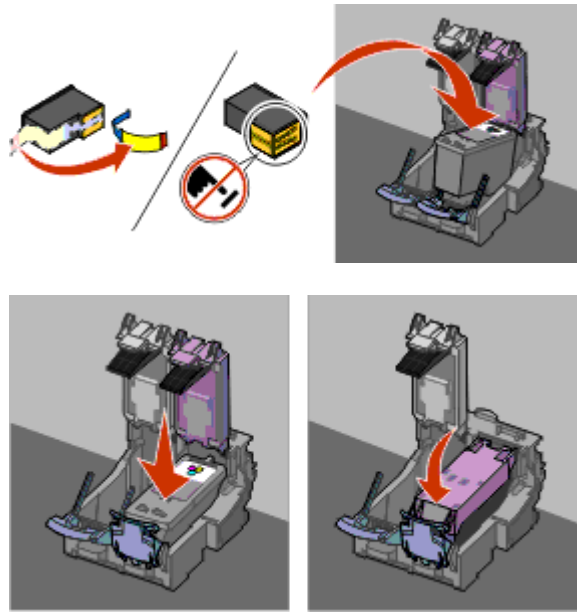

13 If a black print cartridge is included in the box contents, open the black cartridge foil, and then remove the cartridge from the pack.

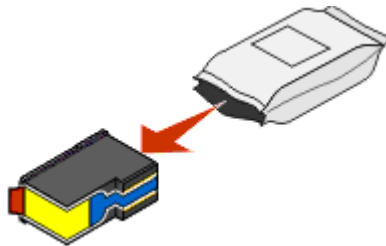

Note: You may need to purchase a black print cartridge separately.

14 Remove the tape from the black print cartridge, insert the cartridge in the left cartridge carrier, and then close the cartridge carrier lid.

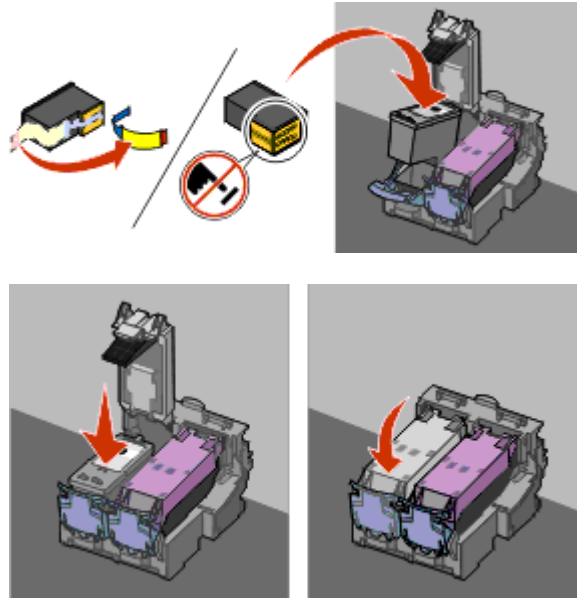

15 Close the printer, and then load plain paper.



16 From the printer control panel, press **OK**.

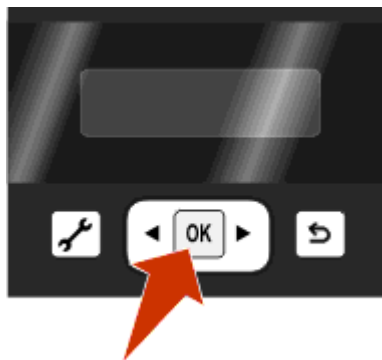

An alignment page prints.

17 Discard or recycle the alignment page.

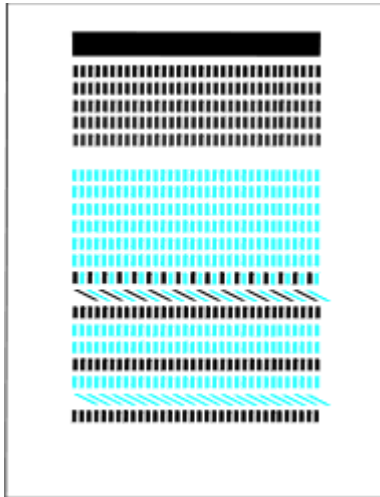

Notes:

- The alignment page may differ from the one shown.
- Streaks on the alignment page are normal and do not indicate a problem.

Understanding the parts of the printer

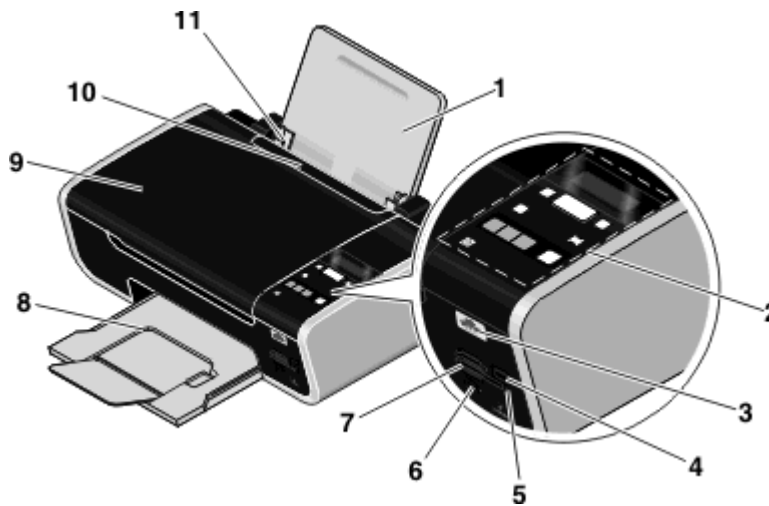

	Use the	To
1	Paper support	Load paper.
2	Printer control panel	Operate the printer.

	Use the	To
3	Wi-Fi indicator Note: Your printer model may not have wireless capability and may not have this indicator.	Check wireless status: <ul style="list-style-type: none"> • Off indicates that the printer is not turned on or that no wireless option is installed. • Orange <ul style="list-style-type: none"> – indicates that the printer is ready to be configured for wireless printing – indicates that the printer is connected for USB printing • Orange blinking indicates that the printer is configured but is unable to communicate with the wireless network. • Green indicates that the printer is connected to a wireless network.
4	PictBridge port	Connect a PictBridge-enabled digital camera or a flash drive to the printer.
5	Card reader light	Check card reader status. The light blinks to indicate that a memory card is being accessed.
6	Quick Connect laptop port Notes: <ul style="list-style-type: none"> • Your printer model may not have this port. • Do not use this port simultaneously with the rear USB port. 	Connect a laptop computer to the printer using a USB cable. Warning—Potential Damage: Do not touch the USB port except when plugging in or removing a USB cable or installation cable.
7	Memory card slots	Insert a memory card.
8	Paper exit tray	Hold paper as it exits.
9	Top cover	Access the scanner glass.
10	Paper feed guard	Prevent items from falling into the paper slot.
11	Paper guides	Keep paper straight when feeding.

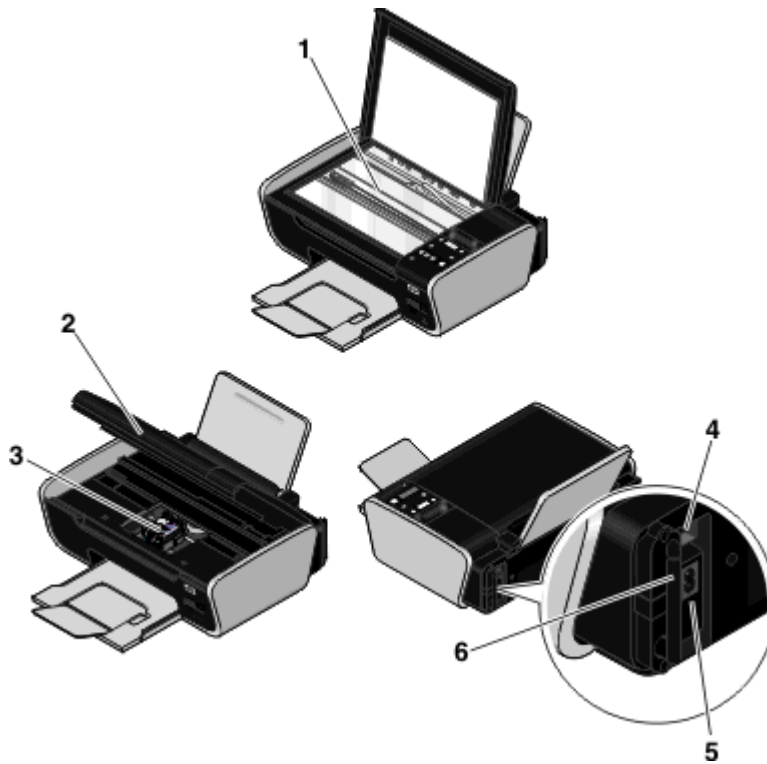

	Use the	To
1	Scanner glass	Scan and copy photos and documents.
2	Scanner unit	<ul style="list-style-type: none"> • Access the print cartridges. • Remove paper jams.
3	Print cartridge carrier	Install, replace, or remove a print cartridge.
4	Rear USB port Note: Do not use this port simultaneously with the Quick Connect laptop port.	Connect the printer to a desktop computer using a USB cable. Warning—Potential Damage: Do not touch the USB port except when plugging in or removing a USB cable or installation cable.
5	Power supply with port	Connect the printer to a power source.
6	Internal wireless print server Note: Your printer model may not have wireless capability and may not have this print server.	Connect the printer to a wireless network.

Using the printer control panel buttons and menus

Using the printer control panel



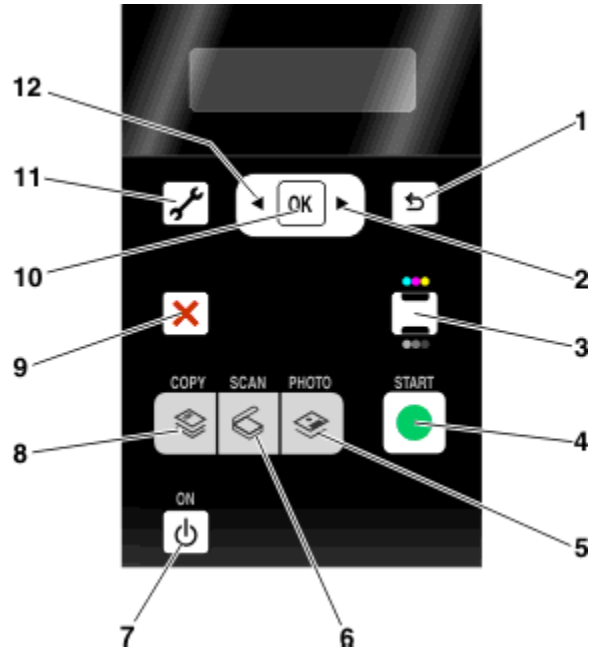

The printer control panel contains:

- Power on/off button
- Two-line display that shows the printer status, messages, and menus

- 11 buttons



	Press	To
1		<ul style="list-style-type: none"> • Return to the previous screen. • Exit from one menu level to a higher one.
2		<ul style="list-style-type: none"> • Increase a number. • Move the cursor one place to the right. • Scroll through menus or settings on the display.
3		Switch to color mode or black-and-white mode.
4		Start a print, scan, or copy job, depending on which mode is selected.
5		Access the photo menu and print photos.
6		Access the scan menu and scan documents.
7		<ul style="list-style-type: none"> • Turn the printer on and off. • Switch to Power Saver mode. <p>Note: Press to switch to Power Saver mode. Press and hold for two seconds to turn off the printer.</p>
8		Access the copy menu and make copies.
9		<ul style="list-style-type: none"> • Cancel a print, copy, or scan job in progress. • Exit from a menu level of the Copy, Scan, Photo, and File Print menus to the top level of a menu. • Exit from a menu level of the Setup menu to the top level of the previous mode. • Clear current settings or error messages, and return to default settings.

	Press	To
10		<ul style="list-style-type: none"> • Select a menu item that appears on the display. • Save settings. • Move one level deeper in a submenu. • Feed or eject paper. Press and hold  for 3 seconds to feed or eject paper from the printer.
11		<p>Access the setup menu and change printer settings.</p> <p>Note: Other button lights are off when this button is selected.</p>
12		<ul style="list-style-type: none"> • Decrease a number. • Move the cursor one place to the left. • Scroll through menus or settings on the display.

Using the printer menus

A number of menus are available to make it easy for you to change printer settings:

Menus List

Setup menu

Maintenance

- Ink Levels
- Clean Cartridges
- Align Cartridges
- Print Test Page

Device Setup

- Language
- Country
- Power Saver
- Clear Settings Timeout

Network Setup (appears only if the printer is connected to a network)

- Print Setup Page
- Wireless Information
- TCP/IP
- File Print
- Reset Network Adapter Defaults

Defaults

- Paper Size
- Paper Type
- Photo Print Size
- Set Defaults

Photo menu

Note: The Photo menu is enabled only when you insert a memory device into the printer.

Easy Photo

- Print
- Photo Size
- Paper Size

Print Photos

- Print
- Lighter/Darker
- Photo Effects
- Photo Size
- Paper Size
- Paper Type
- Layout
- Quality

Proof Sheet

- Print Last 20
- Print All
- Print Date Range
- Scan Sheet

Save Photos

- Computer (appears only if the printer is connected directly to a computer)
- Network (appears only if the printer is connected to a network)
- USB Flash Drive (does not appear if a flash drive is already inserted into the printer)
- Memory Card (does not appear if a memory card is already inserted into the printer)

Select Computer (appears only if the printer is connected to a network)

Copy menu

Copies
Quality
Lighter/Darker
Resize
Original Size
Photo Reprint
Collate
Pages per Sheet
Copies per Sheet
Content Type

Scan menu

Scan to

- Computer
- Network (appears only if the printer is connected to a network)
- USB Flash Drive
- Memory Card

Quality
Original Size

PictBridge menu

Note: The PictBridge menu is enabled only when you insert a PictBridge-enabled camera into the printer.

Photo Size
Paper Size
Paper Type
Layout
Quality

Note: The File Print menu is enabled when you insert a flash drive that contains document files into the printer. The menu is composed of the folders and files stored on the flash drive.

Using the Copy menu

To access the Copy menu, press  on the printer control panel.

From here	You can
Copies	Specify the number of copies to print. You can choose from one to 99.
Quality	Set the quality of a copy as Automatic, Draft, Normal, or Photo.
Lighter/Darker	Adjust the brightness of a copy.
Resize	Choose to resize the copy by a percentage or according to other options.
Original Size	Specify the size of the document being copied.
Photo Reprint	Make high-quality reprints of a photograph.
Collate	Copy multiple pages as a set. The last page copied is printed first.
Pages per Sheet	Choose how many pages to print on a sheet of paper. You can print one, two, or four pages per sheet.
Copies per Sheet	Choose how many copies of an image to print on a page. You can copy one, four, nine, or 16 images per page. Note: Do not use this option with the Resize option.
Content Type	Specify the type of document being copied: text and graphics, photo, or text only.

Using the Scan menu

To access the Scan menu, press  on the printer control panel.

From here	You can
Scan to	<p>Choose the destination of the scanned image.</p> <p>Select:</p> <ul style="list-style-type: none"> • Computer • Network (appears only in printers connected to a network) • USB Flash Drive • Memory Card <p>Notes:</p> <ul style="list-style-type: none"> • If you choose a computer as the destination, then a list of applications will be downloaded to the printer. Choose the application that you will use to open the scanned image on the computer. • If you choose a network computer, you may be prompted to enter a PIN if the computer requires it. • Use the arrow buttons to increase or decrease the value for each digit (the default value is 0000) in the PIN, and then press  each time you select a digit.
Quality	Choose a scan quality.
Original Size	Set the size of the original document.

Using the Photo menu

The Photo menu automatically launches when you insert a memory card or a flash drive that contains only image files into the printer.

If the flash drive you inserted into the printer contains document files and image files, press the arrow buttons until **Photo** appears, and then press .

You can also access the Photo menu when you press  on the printer control panel and then insert a memory device.

From here	You can
Easy Photo	<p>Print photos. You can print the last photo, print all photos, print photos that fall within a date range, or print photos by selecting photo numbers. You can also set the photo size and paper size.</p> <p>Note: Use this menu if you want to print photos quickly.</p>
Print Photos	<p>Print photos using the selections in the Easy Photo menu plus:</p> <ul style="list-style-type: none"> • Apply color effects to the photos. • Adjust the quality, layout, and brightness of a photo. • Print photos using Digital Print Order Format (DPOF). This option appears only when there is a valid DPOF file in the memory device. <p>Note: Use this menu if you want to customize the photos before printing them.</p>

From here	You can
Proof Sheet	Print and then scan a proof sheet: <ul style="list-style-type: none"> • For all photos • For the most recent 20 photos, if there are 20 or more photos on the memory device • By date
Save Photos	Save photos to a computer or memory device.
Select Computer (appears only in printers connected to a network)	Choose a network computer. Notes: <ul style="list-style-type: none"> • You may be prompted to enter a PIN if the computer requires it. To assign a computer name and a PIN to the network computer, see the Help for the printer software associated with your operating system. • Use the arrow buttons to increase or decrease the value for each digit (the default value is 0000) in the PIN, and then press OK each time you select a digit.

Using the PictBridge menu

The PictBridge menu automatically launches when you connect a PictBridge-enabled digital camera to the printer. The menu lets you select printer settings if no settings are selected from your digital camera.

For more information on making camera selections, see the documentation that came with your camera.

From here	You can
Photo Size	Specify the size of the photo to be printed.
Paper Size	Specify a paper size.
Paper Type	Specify a paper type.
Layout	Choose the layout of the photo or photos to be printed.
Quality	Choose the quality of the photo or photos to be printed.

Using the Setup menu

To access the Setup menu, press  on the printer control panel.

From here	You can
Maintenance	Select: <ul style="list-style-type: none"> • Ink Level to view the ink level of the black cartridge, color cartridge, or photo cartridge. • Clean Cartridges to clean the print cartridge nozzles. • Align Cartridges to align the cartridges. • Print Test Page to print a test page.







From here	You can
Device Setup	Select: <ul style="list-style-type: none"> • Language to change the language setting. • Country to set the default blank paper size and date format being used in your location. • Power Saver to set the time that it takes for the printer to switch to Power Saver mode when left idle. • Clear Settings Timeout to change the time that it takes for the printer to reset the menus to factory default settings when the printer is left idle.
Network Setup Note: Your printer model may not have wireless capability and may not have this option.	Select: <ul style="list-style-type: none"> • Print Setup Page to print a page that lists the network settings. • Wireless Information to view the network name and the signal strength of the wireless network. • TCP/IP to view the IP address, IP Netmask, and IP Gateway of the printer. • File Print to choose whether a network computer is selected automatically or manually during File Print jobs. • Reset Network Adapter Defaults to reset the wireless network settings.
Defaults	Select: <ul style="list-style-type: none"> • Paper Size to choose a paper size. • Paper Type to choose a paper type. • Photo Print Size to choose the size of photo(s) to print. • Set Defaults to choose to use the current default settings or the factory default settings.

After selecting an option, press  to save your selection. Press  until you exit Setup, or press another mode button.

Saving settings

You can set the default paper size, paper type, and photo print size for the documents and photos that you print.

Note: These default settings apply only to print, copy, and scan jobs that you initiate from the printer.

- 1 From the printer control panel, press .
- 2 Press the arrow buttons until **Defaults** appears, and then press .
Paper Size appears on the display.
- 3 Press  again.
- 4 Press the arrow buttons to select the default paper size for the printer, and then press .
- 5 Press the arrow buttons until **Paper Type** appears, and then press .
- 6 Press the arrow buttons to select the default paper type for the printer, and then press .
- 7 Press the arrow buttons until **Photo Print Size** appears, and then press .

- 8 Press the arrow buttons to select the default photo print size for the printer, and then press **OK**.
- 9 Press  until you exit Setup, or press another mode button.



Changing temporary settings into new default settings

The printer has default temporary settings for the menus. The printer reverts to these default temporary settings after two minutes of inactivity or after the printer is turned off:

Temporary settings

Copy menu	<ul style="list-style-type: none"> • Copies • Resize • Lighter/Darker • Quality • Copies per Sheet • Pages per Sheet • Original Size • Content Type
Scan menu	<ul style="list-style-type: none"> • Quality • Original Size
Photo menu	<p>The following Photo options will not time out after two minutes of inactivity or after turning off the power but will return to the default factory settings when a memory card or flash drive is removed.</p> <ul style="list-style-type: none"> • Lighter/Darker • Photo Effects • Photo Size • Layout • Quality



To change the temporary settings into new default settings

- 1 From the printer control panel, press .
- 2 Press the arrow buttons until **Default**s appears, and then press **OK**.
- 3 Press the arrow buttons until **Set Default**s appears, and then press **OK**.
Use Current appears on the display.
- 4 Press **OK** again.
- 5 Press  until you exit Setup, or press another mode button.

To disable the settings timeout feature





You can disable the settings timeout feature if you do not want the printer to revert to the default temporary settings after two minutes of inactivity or after turning off the printer.

- 1 From the printer control panel, press .
- 2 Press the arrow buttons until **Device Setup** appears, and then press **OK**.

- 3 Press the arrow buttons until **Clear Settings Timeout** appears, and then press .
- 4 Press the arrow buttons until **Never** appears, and then press .
- 5 Press  until you exit Setup, or press another mode button.

Changing the Power Saver timeout

You can customize the Power Saver timeout of the printer. The Power Saver timeout is the time it takes for the printer to switch to Power Saver mode when the printer is left idle. Change the Power Saver timeout to avoid interruptions when doing multiple jobs on your printer.

- 1 From the printer control panel, press .
- 2 Press the arrow buttons until **Device Setup** appears, and then press .
- 3 Press the arrow buttons until **Power Saver** appears, and then press .
- 4 Press the arrow buttons to select a Power Saver timeout, and then press .

Note: If you want to be efficient on power usage, then select the minimum Power Saver timeout from the options. If you do not want to turn the printer back on from Power Saver mode as often, then select the maximum Power Saver timeout.

- 5 Press  until you exit Setup, or press another mode button.

Using the printer software

Installing printer software

Using Windows

- 1 Close all open software programs.
- 2 Insert the printer software CD.
- 3 From the main installation screen, click **Install**.
- 4 Follow the instructions on the screens.

Using Macintosh

- 1 Close all open software applications.
- 2 Insert the printer software CD.
- 3 From the Finder desktop, double-click the printer CD icon that automatically appears.
- 4 Double-click the **Install** icon.
- 5 Follow the instructions on the screens.

Using the World Wide Web

- 1 Go to the Lexmark Web site at www.lexmark.com.
- 2 From the home page, navigate through the menu selection, and then click **Drivers & Downloads**.

- 3 Choose the printer and the printer driver for your operating system.
- 4 Follow the instructions on the screens to download the driver and install the printer software.

Installing the optional XPS driver (Windows Vista users only)

The XML Paper Specification (XPS) driver is an optional printer driver designed to make use of the advanced XPS color and graphics features that are available only for Windows Vista users. To use XPS features, you must install the XPS driver as an additional driver after you install the regular printer software.

Notes:

- Before installing the XPS driver, you must install the printer on your computer.
- Before installing the XPS driver, you must install the Microsoft QFE Patch and extract the driver files from the installation software CD. To install the patch, you must have administrator privileges on the computer.

To install the Microsoft QFE Patch and extract the driver:

- 1 Insert the installation software CD, and then click **Cancel** when the Setup Wizard appears.
- 2 Click  → **Computer**.
- 3 Double-click the **CD-ROM drive** icon, and then double-click **Drivers**.
- 4 Double-click **xps**, and then double-click **setupxps** file.

XPS driver files are copied to your computer, and any required Microsoft XPS files are launched. Follow the instructions on the screen to finish installing the patch.

To install the XPS driver:

- 1 Click  → **Control Panel**.
- 2 Under Hardware and Sound, click **Printer**, and then click **Add a Printer**.
- 3 From the Add Printer dialog, click **Add a local printer**.
- 4 From the "Use an existing port" drop-down menu, select **Virtual printer port for USB**, and then click **Next**.
- 5 Click **Have disk**.

The Install From Disk dialog appears.

- 6 Click **Browse**, and then navigate to the XPS driver files on your computer:
 - a Click **Computer**, and then double-click **(C:)**.
 - b Double-click the folder that ends in your printer model number, and then double-click **Drivers**.
 - c Double-click **xps**, and then click **Open**.
 - d From the Install From Disk dialog, click **OK**.
- 7 Click **Next** on the two additional dialogs that appear.

For more information on the XPS driver, see the XPS **readme** file on the installation software CD. The file is located in the **xps** folder with the setupxps batch file (D:\Drivers\xps\readme).

Using the Windows printer software

When you set up the printer using the printer software CD, all the necessary software was installed. You may have chosen to install some additional programs. The following table provides an overview of various software programs and what they can help you do.

Note: Your printer may not come with some of these programs or some of the functions of these programs, depending on the features of the printer that you purchased.

Use the	To
Lexmark™ Productivity Studio	<ul style="list-style-type: none"> • Scan, copy, fax, e-mail, or print a photo or document. • Manage and edit photos. • Transfer photos. • Scan documents to PDF format. • Create posters and photo greeting cards from your own photos. • Adjust settings for the printer.
Lexmark Fast Pics	Manage, edit, transfer, and print photos and documents. Note: This program is installed automatically with the printer software if you choose not to install the Lexmark Productivity Studio.
Lexmark Toolbar	<ul style="list-style-type: none"> • Print black or text-only Web pages to save ink. • Schedule automatic printing of Web pages. • Access Picnik and edit photos online. • Print, scan, or convert local files from Windows.
Lexmark Tools for Office	Access your favorite settings in Microsoft Office 2007.
Lexmark Fax Solutions	<ul style="list-style-type: none"> • Send a fax. • Receive a fax in three-in-one printers. • Add, edit, or delete contacts in the built-in phone book. • Access the Lexmark Fax Setup Utility in four-in-one printers. Use the Lexmark Fax Setup Utility to set the Speed Dial and Group Dial numbers, set Ringing and Answering, and print fax history and status reports.
Abbyy Sprint OCR	Scan a document and produce text that you can edit with a word-processing program.
Lexmark Wireless Setup Utility	<ul style="list-style-type: none"> • Set up the wireless printer on a wireless network. • Change the wireless settings of the printer. Note: This program is installed automatically with the printer software if the printer has wireless capability.

Use the	To
Lexmark Service Center	<ul style="list-style-type: none"> • Troubleshoot the printer. • Access the printer maintenance functions. • Contact customer support. <p>Notes:</p> <ul style="list-style-type: none"> • This program is installed automatically with the printer software. • You may be prompted to install this program from the Web, depending on your printer model.
Printing Preferences	<p>When you select File → Print with a document open and then click Properties, a Printing Preferences dialog appears. The dialog lets you select options for the print job such as the following:</p> <ul style="list-style-type: none"> • Select the number of copies to be printed. • Print two-sided copies. • Select the paper type. • Add a watermark. • Enhance images. • Save settings. <p>Note: Printing Preferences is installed automatically with the printer software.</p>

If you have not installed these additional programs during initial installation, reinsert the installation software CD, run the installation software, and then select **Install Additional Software** from the Software Already Installed screen.

Using the Macintosh printer software

Use the	To
Print dialog	Adjust the print settings and schedule print jobs.
Printer Services dialog	<ul style="list-style-type: none"> • Access the printer utility. • Troubleshoot. • Order ink or supplies. • Contact Lexmark. • Contact us. • Check the printer software version installed on the computer.

Applications are also installed with the printer software during installation. These applications are saved in the printer folder that appears on the Finder desktop after installation.

- 1 From the Finder desktop, double-click the printer folder.
- 2 Double-click the icon of the application that you want to use.

Use the	To
Lexmark All-In-One Center	<ul style="list-style-type: none"> • Scan photos and documents. • Customize settings for scan jobs.

Use the	To
Lexmark Fax Setup Utility	<ul style="list-style-type: none"> • Customize settings for fax jobs. • Create and edit the Speed Dial list.
Lexmark Network Card Reader	<ul style="list-style-type: none"> • View the contents of a memory device inserted into a network printer. • Transfer photos and documents from a memory device to the computer over a network.
Lexmark Printer Utility	<ul style="list-style-type: none"> • Get help with cartridge installation. • Print a test page. • Print an alignment page. • Clean the print cartridge nozzles. • Order ink or supplies. • Register the printer. • Contact customer support.
Lexmark Wireless Setup Assistant	Set up the printer on a wireless network.

Note: Your printer may not come with these applications, depending on the features of the printer that you purchased.

Switching between the rear USB port and the Quick Connect laptop port (selected models only)

If the printer is connected to a desktop computer through the rear USB port and you decide to connect a laptop computer to the printer through the Quick Connect laptop port, then the Quick Connect laptop port connection overrides the rear USB port connection. The active print jobs on the desktop computer may be canceled. Pause or cancel active jobs on the desktop computer before switching between ports.

Switching from a desktop computer to a laptop computer

- 1 Pause or cancel active jobs on the desktop computer.
- 2 Connect a USB cable to the laptop computer and then to the Quick Connect laptop port on the front of the printer.

Warning—Potential Damage: Do not plug in or remove the USB cable from the Quick Connect laptop port while a memory device is being accessed by the printer.

- 3 If you have not yet installed the printer software on the laptop, then install it.

Using Windows

- a Insert the installation software CD.
- b Wait for the Welcome screen to appear.

If the Welcome screen does not appear after a minute, do one of the following:

In Windows Vista

- 1 Click .
- 2 In the Start Search box, type `D:\setup.exe`, where **D** is the letter of your CD or DVD drive.

In Windows XP and earlier

- 1** Click **Start**.
 - 2** Click **Run**.
 - 3** Type **D:\setup.exe**, where **D** is the letter of your CD or DVD drive.
- c** Follow the instructions on the computer screen.

Using Macintosh

- a** Insert the installation software CD.
- b** Wait for the Welcome screen to appear.
Note: If the Welcome screen does not appear after a minute, then click the CD icon on the desktop.
- c** Double-click **Install**.
- d** Follow the instructions on the computer screen.

Installing the printer on a wireless network (selected models only)

Wireless network compatibility

Your printer contains an IEEE 802.11g wireless print server. Your printer is compatible with IEEE 802.11 b/g/n routers that are Wi-Fi certified. If you are having issues with an n router, verify with your router manufacturer that the current mode setting is compatible with g devices, as this setting varies depending on the router brand/model.

Information you will need to set up the printer on a wireless network

To set up the printer for wireless printing, you need to know:

- The name of your wireless network. This is also known as the Service Set Identifier (SSID).
- If encryption was used to secure your network.
- The security key (either a WEP key or WPA passphrase) that allows other devices to communicate on the network if encryption was used to secure your network.

If your wireless access point (wireless router) is using Wired Equivalent Privacy (WEP) security, the WEP key should be:

- Exactly 10 or 26 hexadecimal characters. Hexadecimal characters are A–F, a–f, and 0–9.
or
- Exactly 5 or 13 ASCII characters. ASCII characters are letters, numbers, punctuation, and symbols found on a keyboard.

If your wireless access point (wireless router) is using Wi-Fi Protected Access (WPA) security, the WPA passphrase should be:

- From 8 to 63 ASCII characters. ASCII characters in a WPA passphrase are case-sensitive.
or
- Exactly 64 hexadecimal characters. Hexadecimal characters are A-F, a-f, and 0-9.

If your wireless network is not using security, then you will not have a security key. Using a wireless network with no security is not recommended because it can allow intruders to use your network resources without your consent.

Note: Make sure you copy down the security key and SSID exactly, including any capital letters, and store it in a safe place for future reference. Use the table provided below to write down this information.

Item	Description
SSID (name of your wireless network)	
Security key (WEP key or WPA passphrase)	

Note: If you do not know the SSID of the network that your computer is connected to, launch the wireless utility of the computer network adapter and look for the network name. If you cannot find the SSID or the security information for your network, see the documentation that came with the wireless access point (wireless router), or contact your system support person.

Installing the printer on a wireless network

Before you install the printer on a wireless network, make sure that:

- You have completed the initial setup of the printer.
- Your wireless network is set up and working properly.
- The computer you are using is connected to the same wireless network where you want to set up the printer.

Using Windows

- 1 Insert the installation software CD.
- 2 Wait a minute for the Welcome screen to appear.

If the Welcome screen does not appear after a minute, do one of the following:

In Windows Vista

- a Click .
- b In the Start Search box, type `D:\setup.exe`, where `D` is the letter of your CD or DVD drive.

In Windows XP and earlier

- a Click **Start**.
- b Click **Run**.
- c Type `D:\setup.exe`, where `D` is the letter of your CD or DVD drive.

- 3 Follow the instructions on the Welcome screen to set up the printer.

Using Macintosh

- 1 Insert the installation software CD.
- 2 Wait a minute for the Welcome screen to appear.
Note: If the Welcome screen does not appear after a minute, click the CD icon on the desktop.
- 3 Double-click **Install**.
- 4 Follow the instructions on the Welcome screen to set up the printer.

Wireless installation instructions (France only)

The following instructions apply to customers using a LiveBox, AliceBox, N9UF Box, FreeBox, or Club Internet.

- 1 Make sure your box is wireless-enabled and activated to work on a wireless network. For more information about configuring the box to work wirelessly, see the documentation that came with your box.
- 2 Before installing the printer, make sure your box is turned on and that your computer is on and connected to your wireless network.
- 3 Set up your printer using the setup instructions provided.
- 4 If there is an associate/registration button on the back of your box, press it when you are prompted to choose a network.

Note: After pressing the associate/register button, you have five minutes to complete the printer installation.

5 Return to the computer screen, and choose the network you want to connect to. If you want to use the network shown, choose **Connect to <network name>**, and then click **Continue**.

If you do not want to use the network shown:

a Choose **Connect to another network**, and then click **Continue**.

b Choose the network you want to use from the list of available networks, and then click **Continue**.

6 Enter the Network key, and then click **Continue**.

Note: Your WEP, WPA, or WPA2 key may be obtained from the bottom of the box, the user's guide that came with the box, or from the box Web page. If you have already changed the key for your wireless network, use the key you created.

7 Follow the instructions on your screen to complete installation.

Configuring an IP address manually

The printer will be assigned an IP address automatically through DHCP on most wireless networks.

During wireless setup, you will be asked to manually assign an IP address to the printer in the following situations:

- You manually assigned IP addresses for the other network devices.
- You want to assign a specific IP address.
- You moved the printer to a remote subnet.

For more information, contact your system support person.

Interpreting the colors of the Wi-Fi indicator light

The Wi-Fi indicator light helps you determine the network status of the printer.

The following describes what the colors of the Wi-Fi indicator light mean.

- **Off** may indicate that the printer is off, the printer is in the initial power-up state, the internal print server is not installed, or the internal print server is not properly connected.

The light should be in this state:

- When the printer is turned off
- When the printer is in power saver mode
- When the printer does not have an internal print server installed and you want to connect the printer to the computer using a USB cable

- **Orange** may indicate that the printer is being configured for use on the wireless network, the internal print server is not configured in infrastructure mode, or the internal print server is waiting to be configured for ad hoc mode.

The light should be in this state:

- When you want to use the printer without a computer
- When you want to set up the printer on your wireless network
- When the printer is set up for an ad hoc network and is broadcasting its wireless network name (SSID)

- **Blinking orange** may indicate that:

- The printer is out of the range of the wireless access point (wireless router).
- The printer is trying to communicate with the wireless access point (wireless router), but the wireless access point (wireless router) may be turned off or not working properly.

- The printer is trying to establish communication with the wireless access point (wireless router).
This is true if you have already configured the printer for use on your wireless network. When the printer has been configured, any time you turn the printer off and then turn it back on, the internal print server in the printer will try to connect to your wireless access point (wireless router).
- The wireless settings of the printer may no longer be valid.
- **Green** indicates that the printer is connected to a wireless network.
The light should be in this state when you want to start using the printer that is already set up on your wireless network.
- **Blinking green** indicates that the printer internal print server is being updated.

Changing wireless settings after installation

To change wireless settings on the printer, such as the configured network, the security key, or other settings:

Using Windows



- 1 Do one of the following:
 - In Windows Vista, click .
 - In Windows XP and earlier, click **Start**.
- 2 Click **All Programs** or **Programs**, and then select the printer program folder from the list.
- 3 Click **Tools** → **Lexmark Wireless Setup Utility**.
Note: If the cable is not already connected, you may be prompted to connect the printer to the computer again using the installation cable as part of the setup process.
- 4 Follow the prompts on the computer screen to reinstall the software, and then make the changes that you want.

Using Macintosh

- 1 From the Finder desktop, double-click the printer folder.
- 2 Double-click **Lexmark Wireless Setup Assistant**.
- 3 Follow the instructions on the computer screen.

Using the Network Setup menu

The Network Setup menu is available only if your printer model has an internal wireless print server, and if the printer is connected to a network. Use this menu to view the wireless settings of the printer, print a network setup page, and reset the internal wireless print server.

- 1 From the printer control panel, press .
- 2 Press the arrow buttons until **Network Setup** appears, and then press .

From here	You can
Print Setup Page	Print a network setup page.
Wireless Information	View the network name of the current active network and the signal strength of the connection.

From here	You can
TCP/IP	View network settings.
File Print	Choose whether to select a network computer automatically or manually for File Print jobs. <ul style="list-style-type: none"> • If the setting is Auto Select, then the printer selects a network computer automatically. • If the setting is Manual, or if the setting is Auto Select but the network computers detected by the printer require a PIN, then you need to select a network computer from the File Print menu.
Reset Network Adapter Defaults	Reset the internal wireless print server to factory default settings.

Wireless Setup menu

From here	You can
Network Name	View the current Service Set Identifier (SSID).
Wireless Signal Quality	View the wireless signal strength.

TCP/IP menu

From here	You can
View IP Address	View the IP address currently assigned to the printer.
View IP Netmask	View the subnet mask currently configured for the printer.
View IP Gateway	View the currently configured gateway IP address for the network.

Installing the printer on other computers

Once the printer is configured, it can be accessed wirelessly by any other computer on the network. However, you will need to install the printer driver on every computer that will access it. You do not need to configure the printer again, although you will need to run the setup software on each computer to install the driver.

Using Windows

- 1 Insert the installation software CD.
- 2 Wait for the Welcome screen to appear.
If the Welcome screen does not appear after a minute, do one of the following:

In Windows Vista

- a Click .
- b In the Start Search box, type `D:\setup.exe`, where D is the letter of your CD or DVD drive.

In Windows XP and earlier

- a Click **Start**.
- b Click **Run**.
- c Type `D:\setup.exe`, where **D** is the letter of your CD or DVD drive.

3 Follow the on-screen instructions for installing a configured printer on a new computer.

Using Macintosh

1 Insert the installation software CD.

2 Wait for the Welcome screen to appear.

Note: If the Welcome screen does not appear after a minute, click the CD icon on the desktop.

3 Double-click **Install**.

4 Follow the on-screen instructions for installing a configured printer on a new computer.

Advanced wireless setup

Creating an ad hoc wireless network

The recommended way to set up your wireless network is to use a wireless access point (wireless router). A network set up this way is called an *infrastructure network*. If you have an infrastructure network in your home, you should configure your printer for use on that network.

If you do not have a wireless access point or would like to set up a standalone network between your printer and a computer with a wireless network adapter, then you can set up an ad hoc network.

In Windows Vista

1 Click .

2 Click **Control Panel**.

3 Click **Network and Internet**.

4 Under Network and Sharing Center, click **Connect to a Network**.

5 In the Connect to a Network dialog, click **Set up a wireless ad-hoc (computer-to-computer) network**, and then click **Next**.

6 Follow the instructions in the "Set up a wireless ad hoc network" wizard. As part of the setup:

- a Create a network name or SSID for the network between the computer and your printer.
- b Write the name of your network in the space provided so you can refer to it when running the wireless setup. Make sure you copy the exact spelling and capitalization.

SSID (name of your wireless network)	
--------------------------------------	--

- c Go to the Security Type drop-down list, choose **WEP**, and then create a security key (or password).

WEP keys must be:

- Exactly 10 or 26 hexadecimal characters. Hexadecimal characters are A–F, a–f, and 0–9.
or
- Exactly 5 or 13 ASCII characters. ASCII characters are letters, numbers, punctuation, and symbols found on a keyboard.

Note: Security is optional for ad hoc networks. The range of an ad hoc network is much less than the range of an infrastructure network, making it less likely that intruders will connect to it without your knowledge.

- d** Write the password for your network in the space provided so you can refer to it when running the wireless setup. Make sure you copy the exact spelling and capitalization.

Security key (if network is secure)	
-------------------------------------	--

Windows Vista will enable the ad hoc network for you. It will appear in the “Connect to a network” dialog under “Available networks,” indicating that the computer is configured for the ad hoc network.

- 7** Close the Control Panel and any remaining windows.
- 8** If this is the first time you will be setting up the printer for use on a wireless network, insert the installation software CD, and then follow the instructions on the Welcome screen.
Otherwise:
 - a** Click .
 - b** Click **All Programs**.
 - c** Select the printer program folder, and then click **Tools → Lexmark Wireless Setup Utility**.
- 9** When the available networks are displayed, provide the network name and the security information you created. The installer will configure the printer for use with your computer.
- 10** Store a copy of your network name and security information in a safe place for future reference.

In Windows XP and earlier

- 1** Click **Start**.
- 2** Click **Control Panel**.
- 3** Click **Network and Internet Connections**.
- 4** Click **Network Connections**.
- 5** Right-click the icon for your wireless network connection.
- 6** Click **Enable**, if it appears in the pop-up menu.
Note: If Enable does not appear, your wireless connection is already enabled.
- 7** Right-click the **Wireless Network Connection** icon.
- 8** Click **Properties**.
- 9** Click the **Wireless Networks** tab.

Note: If the Wireless Networks tab does not appear, your computer has third-party software that controls your wireless settings. You must use that software to set up the ad hoc wireless network. For more information, see the documentation for the third-party software to learn how to create an ad hoc network.

- 10 Select the **Use Windows to configure my wireless network settings** check box.
- 11 Under Preferred Networks, delete any existing networks.
 - a Select the network to be removed.
 - b Click **Remove** to delete the network from the list.
- 12 Click **Add** to create an ad hoc network.
- 13 In the Network Name (SSID) box, type the name you want to give your wireless network.
- 14 Write down the network name you chose so you can refer to it when running the wireless setup. Make sure you copy the exact spelling and capitalization.

SSID (name of your wireless network)	
--------------------------------------	--

- 15 If Network Authentication appears in the list, then select **Open**.

- 16 In the "Data encryption" list, select **WEP**.

Note: Security is optional for ad hoc networks. The range of an ad hoc network is much less than the range of an infrastructure network, making it less likely that intruders will connect to it without your knowledge.

- 17 If necessary, clear the "The key is provided for me automatically" check box.

- 18 In the Network Key box, type in a security key.

- 19 Write down the security key you chose so you can refer to it when running the wireless utility. Make sure you copy the exact spelling and capitalization.

Security key (if network is secure)	
-------------------------------------	--

Note: For more information about passwords (security keys), see "Check your security keys" in the "Wireless troubleshooting" section of the Troubleshooting chapter.

- 20 In the "Confirm network key" box, type the same security key.
- 21 Select **This is a computer-to-computer (ad hoc) network; wireless access points are not used..**
- 22 Click **OK** twice to close the two open windows.
- 23 It may take a few minutes for your computer to recognize the new settings. To check on the status of your network:
 - a Right-click the **Wireless Network Connections** icon.
 - b Select **View Available Wireless Networks**.
 - If the network is listed but the computer is not connected, select the ad hoc network and then click **Connect**.
 - If the network does not appear, wait a minute and then click **Refresh network list**.
- 24 If this is the first time you will be setting up the printer for use on a wireless network, insert the installation software CD, and then follow the instructions on the Welcome screen.

Otherwise:

- a Click **Start**.
- b Click **All Programs** or **Programs**.
- c Select the printer program folder from the list, and then click **Tools → Lexmark Wireless Setup Utility**.

- 25 When the available networks are displayed, provide the network name and the security information you created in steps 11-16. The utility will configure the printer for use with your computer.
- 26 Store a copy of your network name and security information in a safe place for future reference.

Using Macintosh

- 1 Make sure the computer is on.
- 2 Create a network name.

For Mac OS X version 10.5

- a From the Finder desktop, click  → **System Preferences**.
- b Click **Network**.
- c Click **AirPort**.
- d From the Network Name pop-up menu, click **Create Network**.
- e Create a name for your ad hoc network, and then click **OK**.

For Mac OS X version 10.4 and earlier

- a From the Finder desktop, click **Go** → **Applications**.
- b From the Applications folder, double-click **Internet Connect**.
- c From the toolbar, click **AirPort**.
- d From the Network pop-up menu, click **Create Network**.
- e Create a name for your ad hoc network, and then click **OK**.

- 3 Write down the network name you chose so you can refer to it when running the wireless utility. Make sure you copy the exact spelling and capitalization.

SSID (name of your wireless network)	
--------------------------------------	--

- 4 If this is the first time you will be setting up the printer for use on a wireless network, insert the installation software CD, double-click the installer icon for your printer on the Finder desktop, and then follow the instructions on the Welcome screen.
Otherwise, from the Finder desktop, double-click the printer folder, and then double-click **Lexmark Wireless Setup Assistant**.
- 5 When prompted, provide the network name and/or the security information you created.
The utility will configure the printer for use with your computer.
- 6 Store a copy of your network name and security information in a safe place for future reference.

Adding a printer to an existing ad hoc wireless network

Using Windows

- 1 Do one of the following:
 - In Windows Vista, click .
 - In Windows XP and earlier, click **Start**.
- 2 Click **All Programs** or **Programs**, and then select the printer program folder from the list.

- 3 Click **Lexmark Wireless Setup Utility**.
- 4 Follow the instructions on the Welcome screen.

Using Macintosh

- 1 From the Finder desktop, double-click the printer folder.
- 2 Double-click **Lexmark Wireless Setup Assistant**.
- 3 Follow the instructions on the Welcome screen.

Frequently asked questions

What is a network?

A network is a collection of devices such as computers, printers, Ethernet hubs, wireless access points, and routers connected together for communication through cables or through a wireless connection. A network can be wired, wireless, or designed to have both wired and wireless devices.

Devices on a wired network use cables to communicate with each other.

Devices on a wireless network use radio waves instead of cables to communicate with each other. For a device to be able to communicate wirelessly, it must have a wireless print server attached or installed that lets it receive and transmit radio waves.

How are home networks configured?

For desktop computers, laptops, and printers to communicate with each other over a network, they must be connected by cables and/or have wireless network adapters built in or installed in them.

There are different ways a network can be set up. Five common examples appear below.

Note: The printers in the following diagrams represent printers with internal print servers built in to them so that they can communicate over a network.

Wired network example

- A desktop computer, a laptop, and a printer are connected by Ethernet cables to a hub, router, or switch.
- The network is connected to the Internet through a DSL or a cable modem.

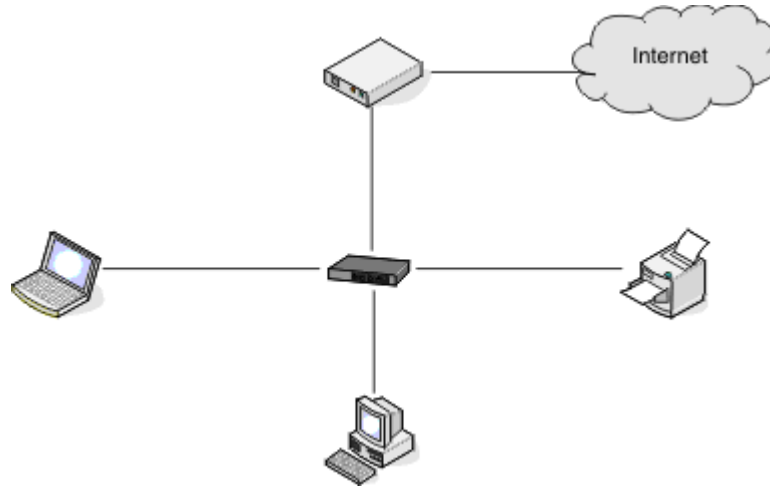

Wireless network examples

Four common wireless networks are:

- Scenario 1: Laptop and printer connected wirelessly with Internet
- Scenario 2: Desktop computer, laptop, and printer connected wirelessly with Internet
- Scenario 3: Desktop computer, laptop, and printer connected wirelessly without Internet
- Scenario 4: Laptop connected wirelessly to printer without Internet

Scenario 1: Laptop and printer connected wirelessly with Internet

- A desktop computer is connected to a wireless router by an Ethernet cable.
- A laptop and a printer are connected wirelessly to the router.
- The network is connected to the Internet through a DSL or a cable modem.

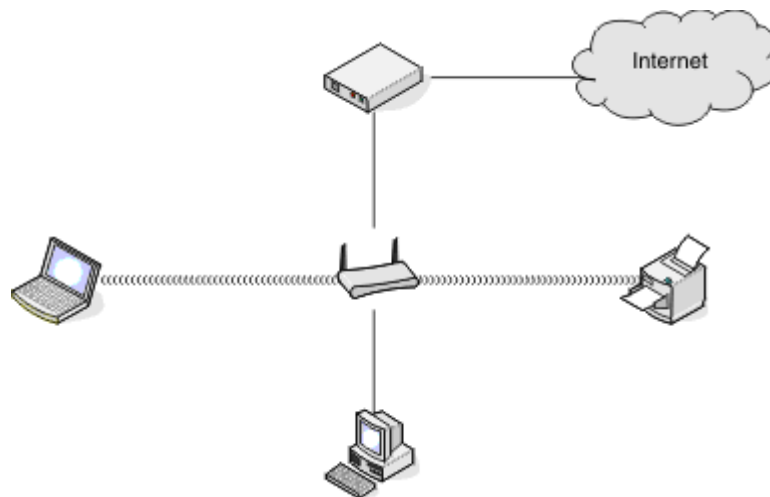

Scenario 2: Desktop computer, laptop, and printer connected wirelessly with Internet

- A desktop computer, a laptop, and a printer are connected wirelessly to a wireless router.
- The network is connected to the Internet through a DSL or a cable modem.

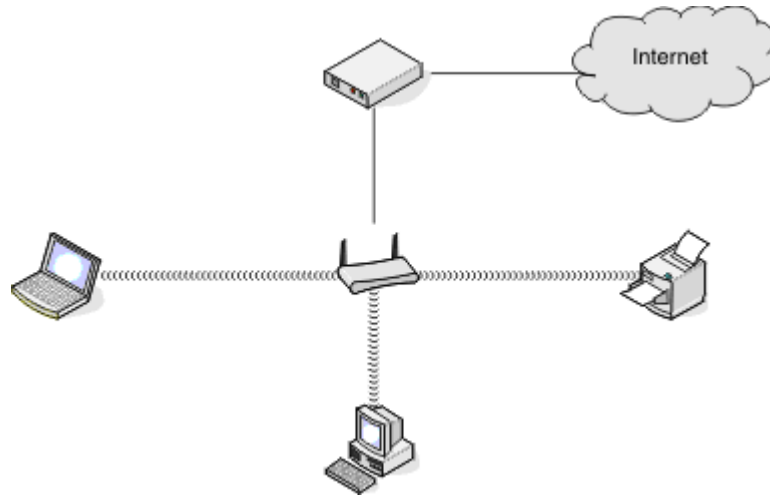

Scenario 3: Desktop computer, laptop, and printer connected wirelessly without Internet

- A desktop computer, a laptop, and a printer are connected wirelessly to a wireless access point (wireless router).
- The network has no connection to the Internet.



Scenario 4: Laptop connected wirelessly to printer without Internet

- A laptop is directly connected wirelessly to a printer without going through a wireless router.
- The network has no connection to the Internet.

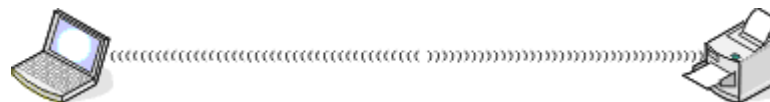

- This configuration is referred to as an ad hoc network.

Why do I need an installation cable?

When setting up the printer on your wireless network, the printer will need to temporarily connect to a computer using the installation cable. This temporary connection is used to set up the wireless settings of the printer.

The installation cable connects to a rectangular USB port on the installing computer and the square USB port on the printer.

How do I attach the installation cable?

The installation cable attaches to a USB port on the computer and to the square connector on the back of the printer. This connection allows you to configure the printer for a networked or locally attached installation.

- 1 Attach the large, rectangular connector to any USB port on your computer. USB ports may be on the front or the back of the computer, and may be horizontal or vertical.

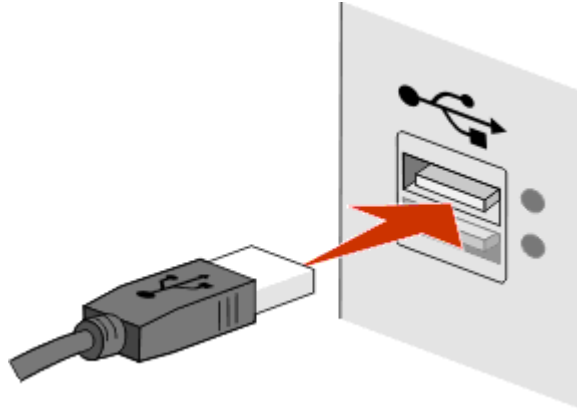

- 2 Attach the small, square connector to the printer.

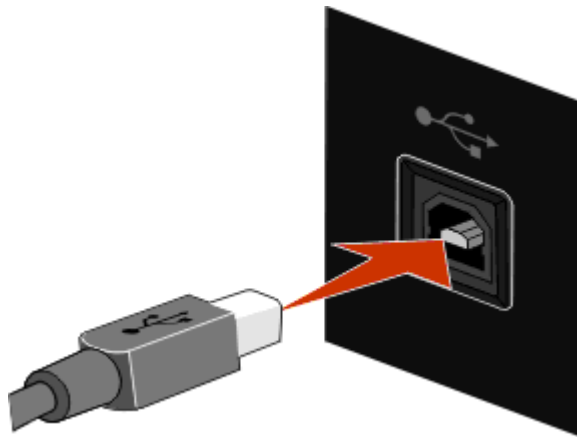

- 3 Continue following the on-screen instructions.

What is the difference between infrastructure and ad hoc networks?

Wireless networks can operate in one of two modes: infrastructure or ad hoc.

In *infrastructure* mode, all devices on a wireless network communicate with each other through a wireless router. Devices on the wireless network must have valid IP addresses for the current network and share the same SSID and channel as the wireless router (wireless access point).

In *ad hoc* mode, a computer with a wireless network adapter communicates directly with a printer equipped with a wireless print server. The computer must have a valid IP address for the current network and be set to ad hoc mode. The wireless print server must be configured to use the same SSID and channel that the computer is using.

The following table compares the characteristics and requirements of the two types of wireless networks.

	Infrastructure	Ad hoc
Characteristics		
Communication	Through wireless access point (wireless router)	Directly between devices
Security	More security options	
Range	Determined by range and number of wireless access points (wireless routers)	Restricted to range of individual devices on network
Speed	Usually faster	Usually slower
Requirements for all devices		
Unique IP address for each device	Yes	Yes
Mode set to	Infrastructure mode	Ad hoc mode
Same SSID	Yes, including the wireless access point (wireless router)	Yes
Same channel	Yes, including the wireless access point (wireless router)	Yes

Lexmark recommends setting up a network in infrastructure mode using the installation CD that came with the printer.

Infrastructure mode is the recommended setup method because it has:

- Increased network security
- Increased reliability
- Faster performance
- Easier setup

Finding the signal strength

Wireless devices have built-in antennas that transmit and receive radio signals. The signal strength listed on the printer network setup page indicates how strongly a transmitted signal is being received. Many factors can affect the signal strength. One factor is interference from other wireless devices or other devices such as microwave ovens. Another factor is distance. The farther two wireless devices are from each other, the more likely it is that the communication signal will be weaker.

The strength of the signal received by your computer can also affect the connectivity of the printer with the network during configuration. When you installed the wireless adapter in your computer, the adapter software probably placed an icon in your system tray. Try double-clicking this icon, and it will tell you how strongly the computer is receiving the wireless signal from the network.

To improve signal quality, remove sources of interference and/or move wireless devices closer to the wireless access point (wireless router).

How can I improve wireless signal strength?

A common reason wireless printers fail to communicate over a network is poor wireless signal quality. If the signal is too weak, too distorted, or blocked by an object, it cannot carry information between the access point and the printer. To determine if the printer is receiving a strong signal from the access point, print a network setup page. The Quality field indicates the relative strength of the wireless signal the printer is receiving. Drops in signal strength can be intermittent, however, and although the signal quality appears high, it may drop during certain conditions.

If you think signal strength is a problem between your access point and the printer, try one or more of the following:

Notes:

- For ad hoc networks, adjust the computer where the access point is indicated.
- Ad hoc networks have a much shorter range than infrastructure networks. Try moving the printer closer to the computer if they seem to have trouble communicating.

MOVE THE PRINTER CLOSER TO THE WIRELESS ACCESS POINT/WIRELESS ROUTER

If the printer is too far away from the access point, it will not be able to communicate with other devices on the network. For most indoor wireless networks, the maximum distance between the access point and the printer is approximately 100 feet (30 meters). This distance could be longer or shorter, depending upon the layout of the network and the limitations of the access point.

REMOVE OBSTACLES BETWEEN THE ACCESS POINT AND THE PRINTER

The wireless signal from your access point will pass through most objects. Most walls, floors, furniture and other objects will not block the wireless signal. However, there are materials that are too dense for the signal to pass through. Objects containing metal and concrete can block the signal, including:

- Cubicle walls
- Ducts
- Window frames
- Poles and interior support columns
- Metal office furniture and cabinets
- Elevators
- Steel doors
- Walls and other structural elements reinforced by rebar

Arrange your printer and access point so that the signal is not blocked by any of these objects.

REMOVE SOURCES OF INTERFERENCE

Other types of radio frequencies can cause problems with the wireless signal on your network. These sources of interference can cause printing issues that seem to come and go. Some common sources of interference are:

- Cordless phones
- Microwave ovens
- Refrigerators and other appliances
- Bluetooth devices
- Other wireless networks
- Motors

Turn off these potential sources of interference where possible. Avoid using microwaves and cordless phones when printing over your wireless network.

If another wireless network is operating in the vicinity, change the wireless channel on the access point.

Do not place your access point on a printer. Printers can also interfere with the wireless signal.

ARRANGE THE NETWORK TO REDUCE SIGNAL ABSORPTION

Even when the wireless signal is able to pass through an object, it is slightly weakened. If it passes through too many objects, it can be significantly weakened. All objects absorb part of the wireless signal when it passes through them, but certain types of objects absorb enough to cause communications problems. To avoid signal absorption, avoid placing the following items between your access point and your printer:

- Stacks of paper or books
- Multiple walls or floors
- Crowds of people
- Objects containing water, such as fish tanks
- Plants

Place your access point as high in the room as possible to avoid signal absorption.

What is an SSID?

A *Service Set Identifier* (SSID) is the name that identifies a wireless network. All devices on the network must know the SSID of the wireless network or they will not be able to communicate with each other. Usually, the wireless network broadcasts the SSID to allow wireless devices in the area to connect to it. Sometimes, the SSID is not broadcast for security reasons.

An SSID can contain up to 32 alphanumeric characters.

How do I find out what type of security my network is using?

You must know the security key and security mode to properly set up the printer for use on the wireless network. To obtain this information, see the documentation that came with your wireless access point (wireless router), see the Web page associated with the wireless access point (wireless router), or consult your system support person.

Note: The network security key is not the same as the password for the wireless access point (wireless router). The password allows you to access the wireless access point (wireless router) settings. The security key is a WEP key or WPA passphrase that allows printers and computers to join your wireless network.

Can I use my printer on a USB and a wireless connection at the same time?

The printer can be configured in the following ways:

- Locally attached (connected to a computer using a USB cable)
- Wireless network
- Wireless network and locally attached simultaneously

If you want to use the printer as both a wireless and locally attached printer at the same time, you will need to run the setup software again and select the additional connection type.

What is a MAC address?

A Media Access Control (MAC) address is a 48-bit identifier associated with the hardware of network equipment. The MAC address may also be called the physical address because it is connected to the hardware of a device instead of its software. The MAC address is displayed as a hexadecimal number in this format: 01-23-45-67-89-AB.

Every device capable of communicating on a network has a MAC address. Network printers, computers, and routers, whether Ethernet or wireless, all have MAC addresses.

While it is possible to change the MAC address of a network device, it is not common practice to do so. For this reason, MAC addresses are considered permanent. IP addresses are easily changed, so MAC addresses are a more reliable method of identifying a specific device on a network.

Routers with security capabilities may allow filtering of MAC addresses on networks. This allows a managed list of devices to access the network, identified by their MAC addresses. MAC address filtering can help prevent access on the network from unwanted devices, such as from intruders on a wireless network. MAC address filtering can also prevent legitimate access if you forget to add a new device to the router's list of allowed addresses. If your network uses MAC address filtering, be sure to add the MAC address of the printer to the list of allowed devices.

How do I find the MAC address?

Most network equipment has a unique hardware identification number to distinguish it from other devices on the network. This is called the *Media Access Control* (MAC) address.

The MAC address is a series of letters and numbers located on the back of your printer.



Note: A list of MAC addresses can be set on an access point (router) so that only devices with matching MAC addresses are allowed to operate on the network. This is called MAC filtering. If MAC filtering is enabled in your access point (router) and you want to add a printer to your network, the MAC address of the printer must be included in the MAC filter list.

What is an IP address?

An IP address is a unique number used by devices (such as a wireless printer, computer, or wireless access point) on an IP network to locate and communicate with each other. Devices on an IP network can communicate with each other only if they have unique and valid IP addresses. A unique IP address means no two devices on the same network have the same IP address.

An IP address is a group of four numbers separated by periods. An example of an IP address is 192.168.100.110.

What is TCP/IP?

Networks are able to function because computers, printers, and other devices are able to send data to each other, either through cables or by using wireless signals. This transfer of data is made possible by sets of data transmission rules called *protocols*. A protocol can be thought of as a language, and like a language, it has rules allowing participants to communicate with each other.

Different types of networks use different protocols, but *Transmission Control Protocol/Internet Protocol* (TCP/IP) is the most popular. TCP/IP is used to send data over the Internet as well as over most corporate and home networks.

Because computers do not understand words and instead rely upon numbers for communication, TCP/IP requires that every device on a network using TCP/IP to communicate must have an IP address. IP addresses are essentially unique computer names in a numeric format, used to transfer data around a network. IP addresses allow TCP/IP to confirm requests for and receipt of data by various devices on the network.

How do I locate IP addresses?

How to locate a computer IP address using Windows

1 Do one of the following:

In Windows Vista

- a Click .
- b Click **All Programs → Accessories**.
- c Click **Command Prompt**.

In Windows XP and earlier

- a Click **Start**.
- b Click **All Programs** or **Programs → Accessories → Command Prompt**.

2 Type `ipconfig`.

3 Press **Enter**.

The IP address appears as four sets of numbers separated by periods, such as 192.168.0.100.

How to locate a computer IP address using Macintosh

1 Click  → **System Preferences**.

2 Click **Network**.

For Mac OS X version 10.5

- a Click **AirPort**.
- b Click **Advanced**.
- c Click **TCP/IP**.

The IP address appears as four sets of numbers separated by periods, such as 192.168.0.100.

For Mac OS X version 10.4 and earlier

- a** From the Show pop-up menu, select **AirPort**.
- b** Click **TCP/IP**.

The IP address appears as four sets of numbers separated by periods, such as 192.168.0.100.

How to locate a printer IP address

- You can locate the printer IP address by viewing the printer network setup page.

How are IP addresses assigned?

An IP address may be assigned automatically by the network using DHCP. Once the printer is set up on a computer, the computer sends all print jobs across the network to the printer using this address.

If the IP address is not automatically assigned, you will be asked during wireless setup to manually enter an address and other network information after selecting your printer from the available list.

What is a key index?

A wireless access point (wireless router) can be configured with as many as four WEP keys. Only one key is used on the network at a time, however. The keys are numbered, and the number of a key is referred to as its key index. All devices on the wireless network must be configured to use the same key index when multiple WEP keys are configured on the wireless access point (wireless router).

The printer is designed to use the first key. Make sure you have configured all of the wireless devices on your network to use the first WEP key where you have the option of selecting a key. Make sure the wireless access point (wireless router) is also configured to use the first key. The first key will usually have an index of 0, though it may be 1 on some devices.

Loading paper

Loading paper

1 Make sure:

- You use paper designed for inkjet printers.
- If you are using photo, glossy, or heavyweight matte paper, you load it with the glossy or printable side facing you. (If you are not sure which side is the printable side, see the instructions that came with the paper.)
- The paper is not used or damaged.
- If you are using specialty paper, you follow the instructions that came with it.
- You do not force paper into the printer.

2 Before loading paper the first time, slide the paper guides out toward the edges of the paper support.

3 Load the paper vertically in the center of the paper support, and adjust the paper guides to rest against the edges of the paper.



Note: To avoid paper jams, make sure the paper does not buckle when you adjust the paper guides.

Loading various paper types

Plain paper

You can load up to 100 sheets (depending on the thickness).

Make sure:

- The paper is designed for use with inkjet printers.
- The paper is loaded in the center of the paper support.
- The paper guides rest against the edges of the paper.

Heavyweight matte paper, photo paper, glossy paper

You can load up to 25 sheets.

Make sure:

- The glossy or printable side of the paper faces you. (If you are not sure which side is the printable side, then see the instructions that came with the paper.)
- The paper is loaded in the center of the paper support.
- The paper guides rest against the edges of the paper.

Note: Photos require more drying time. Remove each photo as it exits, and then allow it to dry to avoid ink smudging.

Envelopes

You can load up to 10 envelopes.



Make sure:

- The print side of the envelopes faces you.
- The stamp location is in the upper left corner.
- The envelopes are designed for use with inkjet printers.
- The envelopes are loaded in the center of the paper support.
- The paper guides rest against the edges of the envelopes.

Warning—Potential Damage: Do not use envelopes that have metal clasps, string ties, or metal folding bars.

Notes:

- Do not load envelopes with holes, perforations, cutouts, or deep embossing.
- Do not use envelopes that have exposed flap adhesive.
- Envelopes require more drying time. Remove each envelope as it exits, and then allow it to dry to avoid ink smudging.

Labels

You can load up to 25 sheets.

Make sure:

- The print side of the labels faces you.
- The top of the label sheets feeds into the printer first.
- The adhesive on the labels does not extend to within 1 mm of the edge of the label sheets.
- You use full label sheets. Partial sheets (with areas exposed by missing labels) may cause labels to peel off during printing, resulting in a paper jam.
- The label sheets are loaded in the center of the paper support.
- The paper guides rest against the edges of the label sheets.

Note: Labels require more drying time. Remove each sheet of labels as it exits, and then allow it to dry to avoid ink smudging.

Transparencies

You can load up to 10 transparencies.

Make sure:

- The rough side of the transparencies faces you.
- If the transparencies have a removable strip, each strip faces away from you and down toward the printer.

- The transparencies are loaded in the center of the paper support.
- The paper guides rest against the edges of the transparencies.

Notes:

- Transparencies with paper backing sheets are not recommended.
- Transparencies require more drying time. Remove each transparency as it exits, and then allow it to dry to avoid ink smudging.

Iron-on transfers

You can load up to 10 transfers.

Make sure:

- You follow the loading instructions that came with the iron-on transfers.
- The print side of the transfers faces you.
- The transfers are loaded in the center of the paper support.
- The paper guides rest against the edges of the transfers.

Note: For best results, load transfers one at a time.

Greeting cards, index cards, photo cards, postcards

You can load up to 25 cards.



Make sure:

- The print side of the cards faces you.
- The cards are loaded in the center of the paper support.
- The paper guides rest against the edges of the cards.

Note: Photo cards require more drying time. Remove each photo card as it exits, and then allow it to dry to avoid ink smudging.

Custom-size paper

You can load up to 100 sheets (depending on the thickness).

Make sure:

- The print side of the paper faces you.
- The paper size fits within these dimensions:

Width:

- 76.2–215.9 mm
- 3.0–8.5 inches

Length:

- 127.0–355.6 mm
- 5.0–17.0 inches

- The paper is loaded in the center of the paper support.
- The paper guides rest against the edges of the paper.

Banner paper

You can load up to 20 sheets.



Make sure:

- You remove all the paper from the paper support before loading the banner paper.
- You tear off only the number of pages needed to print the banner.
- You place the required stack of banner paper on a flat surface behind the printer.
- The leading edge of the banner paper feeds into the printer first.
- The paper is loaded in the center of the paper support.
- The paper guides rest against the edges of the paper.

Loading original documents on the scanner glass

You can scan and then print photos, text documents, magazine articles, newspapers, and other publications. You can scan a document for faxing.

Note: The maximum scan area for the scanner glass is 216 x 297 mm (8.5 x 11.7 in.).

- 1 Open the top cover.



- 2 Place the original document or item facedown on the scanner glass in the lower right corner.



Note: Photos should be loaded as shown.

3 Close the top cover to avoid dark edges on the scanned image.



Using the automatic paper type sensor

The printer is equipped with an automatic paper type sensing device. The Paper Type Sensor automatically detects the type of paper that has been loaded into the printer and adjusts the settings for you. For example, if you want to print a photo, load photo paper into the printer. The printer detects the type of paper and automatically adjusts the settings to give you optimum photo-printing results.

Printing

For instructions on additional printing tasks, see the Help associated with the printer software.

Printing basic documents

Printing a document

- 1 Load the paper.



- 2 Do one of the following to print:

Using Windows

- a With a document open in a Windows program, click **File → Print**.
- b Click **Properties, Preferences, Options, or Setup**.
- c Select the print quality, the number of copies to print, the type of paper to be used, and how the pages should print.
- d Click **OK** to close any printer software dialogs.
- e Click **OK** or **Print**.

Using Macintosh

- a With a document open in a Macintosh application, click **File → Print**.
- b From the Printer pop-up menu, choose the printer.
- c From the print options pop-up menu, choose the print quality, the number of copies to print, the type of paper to be used, and how the pages should print.
- d Click **Print**.

Printing Web pages

If you chose to install the Lexmark Toolbar software for your Web browser, then you can use it to create a printer-friendly version of any Web page.

Notes:

- For Windows, the software supports Microsoft Internet Explorer 5.5 or later or a compatible version of Firefox.
- For Macintosh, the software supports a compatible version of Firefox.

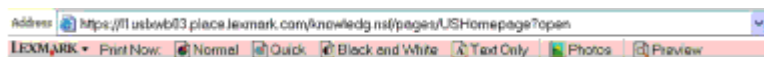

- 1 Load paper.
- 2 Open a Web page using a supported browser.
- 3 Select a print option to print the page.
You can also adjust settings or preview the page before printing.

Printing multiple copies of a document

Using Windows

- 1 With a document open, click **File → Print**.
- 2 Click **Properties, Preferences, Options, or Setup**.
- 3 From the Copies section of the Print Setup tab, enter the number of copies that you want to print.
- 4 Click **OK** to close any printer software dialogs.
- 5 Click **OK** or **Print**.

Using Macintosh

- 1 With a document open, click **File → Print**.
- 2 From the Printer pop-up menu, choose the printer.
- 3 In the Copies field, enter the number of copies that you want to print.
- 4 Click **Print**.

Collating printed copies

If you print multiple copies of a document, you can choose to print each copy as a set (collated) or to print the copies as groups of pages (not collated).

Collated



Not collated



Using Windows

- 1 With a document open, click **File → Print**.
- 2 Click **Properties, Preferences, Options, or Setup**.
- 3 From the Copies section of the Print Setup tab, enter the number of copies that you want to print, and then select **Collate Copies**.
- 4 Click **OK** to close any printer software dialogs.
- 5 Click **OK** or **Print**.

Note: The collate option is available only when you are printing multiple copies.

Using Macintosh

- 1 With a document open, click **File → Print**.
- 2 In the Copies field, enter the number of copies that you want to print, and then select **Collated**.
- 3 Click **Print**.

Note: To prevent smudging when printing photos, remove each photo as it exits the printer, and then let it dry before stacking.

Printing the last page first (reverse page order)

Using Windows

- 1 With a document open, click **File → Print**.
- 2 Click **Properties, Preferences, Options, or Setup**.
- 3 From the Copies section of the Print Setup tab, select **Print Last Page First**.
- 4 Click **OK** to close any printer software dialogs.
- 5 Click **OK** or **Print**.

Using Macintosh

- 1 With a document open, click **File → Print**.
- 2 From the Printer pop-up menu, choose the printer.
- 3 Do one of the following:
 - For Mac OS X versions 10.5 and 10.4**
 - a From the print options pop-up menu, choose **Paper Handling**.
 - b From the Page Order menu, select **Reverse**.
 - For Mac OS X version 10.3**
 - a From the print options pop-up menu, choose **Paper Handling**.
 - b Select **Reverse page order**.
- 4 Click **Print**.

Printing multiple pages on one sheet (N-Up)

Using Windows

- 1 With a document open, click **File → Print**.
- 2 Click **Properties, Preferences, Options, or Setup**.
- 3 From the **Advanced** tab, select **N-Up** under the Layout drop-down menu.
- 4 Select the number of page images to print on each page.
If you want each page image to be surrounded by a border, then select **Print Page Borders**.

5 Click **OK** to close any printer software dialogs.

6 Click **OK** or **Print**.

Using Macintosh

1 With a document open, click **File → Print**.

2 From the print options pop-up menu, choose **Layout**.

- From the Pages per Sheet pop-up menu, choose the number of page images that you want to print on one sheet.
- From the Layout Direction area, click the icon that shows the order that you want the page images to print on one sheet.
- If you want to print a border around each page image, then choose an option from the Border pop-up menu.

3 Click **Print**.

Printing documents from a memory card or flash drive

To enable the File print function:

- The printer must be connected to a computer through a USB cable or through a network.
- The printer and the computer must be on.
- The memory card or flash drive must contain document files that are supported by the printer.
- The computer must contain applications that support the file types in the memory device.

1 Insert a memory card or flash drive.

The following file types are recognized:

- .doc (Microsoft Word)
- .xls (Microsoft Excel)
- .ppt (Microsoft PowerPoint)
- .pdf (Adobe Portable Document Format)
- .rtf (Rich Text Format)
- .docx (Microsoft Word Open Document Format)
- .xlsx (Microsoft Excel Open Document Format)
- .pptx (Microsoft PowerPoint Open Document Format)
- .wps (Microsoft Works)
- .wpd (WordPerfect)



When the printer detects the memory device, the message **Memory Card Detected** or **Storage Device Detected** appears on the printer control panel display.

2 If only document files are stored on the memory device, then the printer automatically switches to File Print mode.

If document files and image files are stored on the memory device, then press  to select **Documents**.

3 Do one of the following:



USB connection

- a Press the arrow buttons to select the file name of the document that you want to print or the folder where the document is saved in the memory device.
- b Press , and then press  to start printing the document.

Wireless connection (selected models only)

- a Wait for the printer to connect to the network computer or to finish searching the network for available computers.
If **Select Computer** appears, press the arrow buttons to select a network computer, and then press .

Notes:

- You may be prompted to enter a PIN if the computer requires it. To assign a computer name and a PIN to the computer, see the Help for the printer software associated with your operating system.
 - Use the arrow buttons to increase or decrease the value for each digit (the default value is 0000) in the PIN, and then press  each time you select a digit.
- b Press the arrow buttons to select the file name of the document that you want to print or the folder where the document is saved in the memory device.
 - c Press , and then press  to start printing the document.

Printing specialty documents

You can also use the programs that are installed with the printer software to print specialty documents. For more information, see the Help associated with these programs.

Choosing compatible specialty paper types

- **Heavyweight matte paper**—A photo paper with a matte finish used for printing high-quality graphics.
- **Photo/Glossy paper**—Photo paper with a special coating. It is used specifically for printing photos with crisp, sharp images.
- **Lexmark Photo Paper**—An outstanding "everyday" heavyweight inkjet photo paper designed for use with Lexmark printers, but compatible with all brands of inkjet printers. Although inexpensive, it offers excellent image quality and outstanding value.
- **Lexmark Premium Photo Paper**—A high-gloss, heavyweight quality photo paper specifically designed to work with Lexmark's evercolor™ inks for eye-catching, color-rich results. It is great for those special photos to be framed, placed in an album, or shared with friends and family.
- **Lexmark PerfectFinish™ Photo Paper**—A high-quality photo paper specifically designed for Lexmark inkjet printers, but compatible with all inkjet printers. It is used specifically for printing professional quality photos with a glossy finish. It is best when used with genuine Lexmark evercolor 2 ink, providing photos that are fade- and water-resistant.
- **Transparency**—A clear, plastic media primarily used for overhead projectors.
- **Card stock**—A very thick paper used for printing sturdier items, such as greeting cards.
- **Iron-On transfer**—A type of media that has a reverse image printed on it that can be ironed onto fabric.

Printing envelopes

- 1 Load the envelopes in the printer.



- 2 Do one of the following:

Using Windows

- a With a document open, click **File → Print**.
- b Click **Properties, Preferences, Options, or Setup**.
- c From the Media Type list of the Print Setup tab, select **Plain**.
- d From the Paper Size list, select the envelope size.

Note: To print on a custom-size envelope, select **Custom Size**, and then specify the height and width of the envelope.

- e Select **Portrait** or **Landscape** orientation.
- f Click **OK** to close any printer software dialogs.
- g Click **OK** or **Print**.

Using Macintosh

- a Customize the settings as needed in the Page Setup dialog.
 - 1 With a document open, click **File → Page Setup**.
 - 2 From the “Format for” pop-up menu, choose the envelope size. If no size matches the size of the envelope, then set a custom size.
 - 3 Select an orientation.
 - 4 Click **OK**.
- b Customize the settings as needed in the Print dialog.
 - 1 With a document open, click **File → Print**.
 - 2 From the Printer pop-up menu, choose the printer that you want to use.
 - 3 Click **Print**.

Notes:

- Most envelopes use landscape orientation.
- Make sure the same orientation is also selected in the software application.

Printing labels

- 1 Load the label sheets in the printer.
- 2 Do one of the following:

Using Windows

- a** With a document open, click **File → Print**.
- b** Click **Properties, Preferences, Options, or Setup**.
- c** From the Paper Size drop-down menu of the Print Setup tab, choose a paper size that matches the size of the label sheet. If no paper size matches the label sheet size, then set a custom size.
If necessary, choose the appropriate type of media from the Media Type drop-down menu.
- d** Click **OK** to close any printer software dialogs.
- e** Click **OK** or **Print**.

Using Macintosh

- a** Customize the settings as needed in the Page Setup dialog.
 - 1** With a document open, choose **File → Page Setup**.
 - 2** From the “Format for” pop-up menu, choose the printer that you want to use.
 - 3** From the Paper Size pop-up menu, choose a paper size that matches the size of the label sheet. If no paper size matches the label sheet size, then create a custom size.
- b** Customize the settings as needed in the Print dialog.
 - 1** With a document open, click **File → Print**.
 - 2** From the Printer pop-up menu, choose the printer that you want to use.
 - 3** From the print options pop-up menu, choose **Quality & Media**.
 - 4** From the Paper type pop-up menu, choose a paper type.
 - 5** From the Print Quality menu, choose a print quality other than Quick Print.

Tips on loading label sheets

- Make sure the top of the label sheet feeds into the printer first.
- Make sure the adhesive on the labels does not extend to within 1 mm of the edge of the label sheet.
- Make sure the paper guide or paper guides rest against the edges of the label sheet.
- Use full label sheets. Partial sheets (with areas exposed by missing labels) may cause labels to peel off during printing, resulting in a paper jam.

Note: Labels require more drying time. Remove each label sheet as it exits, and then allow it to dry to avoid ink smudging.

Printing on custom-size paper

Before beginning these instructions, load the custom-size paper in the printer. For more information, see the “Loading Paper” chapter.

Using Windows

- 1** With a document open, click **File → Print**.
- 2** Click **Properties, Preferences, Options, or Setup**.
The Print Setup tab appears.
- 3** In the Paper Options section, from the “Paper size” list, select **Custom Size**.
The Define Custom Paper Size dialog appears.

- 4 Select the measurement units to use (inches or millimeters).
- 5 Click **OK** to close any printer software dialogs that are open.
- 6 Print the document.

Using Macintosh

- 1 With a document open, click **File → Page Setup**.
- 2 From the Paper size pop-up menu, choose **Manage Custom Sizes**.
- 3 Create a custom size.
 - a Click **+**.
 - b In the Page Size menu, type the Width and Height of the paper.
 - c From the Printer Margins pop-up menu, choose the printer that you want to use. The margins are set by the printer.
If you want to set the margins, choose **User defined**, and then type the margins in the Printer Margins area.
 - d From the custom sizes list on the left of the dialog, double-click **Untitled**, and then type a name for the custom paper size you set.
 - e Click **OK**.
- 4 Open the Paper size pop-up menu again, and then choose the name of the custom paper size you added in Step 3d.
- 5 Click **Print**.

Saving and deleting print settings

Using Windows

- 1 With a document open, click **File → Print**.
- 2 Click **Properties, Preferences, Options, or Setup**.
- 3 Make adjustments to the settings.
- 4 Click **Profiles**, and then click **Save your current settings**.
- 5 Select an empty location for your setting, and then assign a name.
Note: The first location contains Factory Default Settings, which cannot be changed or deleted.
- 6 Click **Save**.
- 7 Close all open software dialogs.

Notes:

- To retrieve your print settings, click **Profiles → Restore a Profile**, and then select the name of the profile that you want to use.
- To delete a setting, click **Profiles → Delete Profiles**. Select the setting that you want to delete, and then click **Delete**.

Using Macintosh

The Presets pop-up menu lets you save the print settings you use often. When print settings are saved into a Preset, there is no need to adjust the print settings for every print job.

- 1 With a document open, click **File → Print**.
- 2 From the print options pop-up menu, choose and adjust the settings.
- 3 From the Presets pop-up menu, choose **Save As**.
The Save Preset dialog appears.
- 4 Type a name for the Preset.
- 5 Click **OK**.

Managing print jobs

Pausing print jobs

Using the printer folder in Windows

- 1 Do one of the following:
 - In Windows Vista**
 - a Click .
 - b Click **Control Panel**.
 - c Under **Hardware and Sound**, click **Printer**.
 - In Windows XP**
 - a Click **Start**.
 - b Click **Printers and Faxes**.
 - In Windows 2000**
 - a Click **Start**.
 - b Click **Settings → Printers**.
- 2 Right-click the printer, and then select **Pause Printing**.

Using the taskbar in Windows

- 1 Double-click the printer icon in the taskbar.
- 2 Right-click the document name, and then select **Pause**.

Using Macintosh

- 1 While the document is printing, click the printer icon in the Dock.
The print queue dialog appears.
- 2 Do one of the following:
 - If you want to pause a particular print job, choose the document name, and then click **Hold**.
 - If you want to pause all print jobs in the queue, click **Pause Printer** or **Stop Jobs**, depending on the operating system version that you are using.

Resuming print jobs

Using the printer folder in Windows

- 1 Do one of the following:

In Windows Vista

- a Click .
- b Click **Control Panel**.
- c Under Hardware and Sound, click **Printer**.

In Windows XP

- a Click **Start**.
- b Click **Printers and Faxes**.

In Windows 2000

- a Click **Start**.
- b Click **Settings → Printers**.

- 2 Right-click the printer name, and then select **Open**.
- 3 Do one of the following:
 - If you want to resume a particular print job, right-click the document name, and then select **Resume**.
 - If you want to resume all print jobs in the queue, click **Printer**, and then clear the selection for Pause Printing.

Using the taskbar in Windows

- 1 Double-click the printer icon in the taskbar.
- 2 Right-click the document name, and then select **Resume**.

Using Mac OS X version 10.5

- 1 From the menu bar, click  → **System Preferences → Print & Fax**.
- 2 Click **Open Print Queue**.
The print queue dialog appears.
 - If you want to resume a particular print job, choose the document name, and then click **Resume**.
 - If you want to resume all print jobs in the queue, then click **Resume Printer**.

Using Mac OS X version 10.4 and earlier

- 1 From the menu bar, click **Go → Utilities → Print Center** or **Printer Setup Utility**.
The Printer List dialog appears.
- 2 Double-click the printer.
The print queue dialog appears.
- 3 Do one of the following:
 - If you want to resume all print jobs in the queue, click **Start Jobs**.
 - If you want to resume a particular print job, choose the document name, and then click **Resume**.

Canceling print jobs

Using the printer control panel

Press **X**.

Using the printing status window of the printer

The printing status window automatically opens at the bottom-right part of your screen when you send a print job. Click **Cancel Printing** to cancel the print job.

Using the printer folder in Windows

- 1 Do one of the following:

In Windows Vista

- a Click .
- b Click **Control Panel**.
- c Under Hardware and Sound, click **Printer**.

In Windows XP

- a Click **Start**.
- b Click **Printers and Faxes**.

In Windows 2000

- a Click **Start**.
- b Click **Settings → Printers**.

- 2 Right-click the printer name, and then select **Open**.
- 3 Do one of the following:
 - If you want to cancel a particular print job, right-click the document name, and then select **Cancel**.
 - If you want to cancel all print jobs in the queue, click **Printer → Cancel All Documents**.

Using the taskbar in Windows

- 1 Double-click the printer icon in the taskbar.
- 2 Do one of the following:
 - If you want to cancel a particular print job, right-click the document name, and then select **Cancel**.
 - If you want to cancel all print jobs in the queue, click **Printer → Cancel All Documents**.

Using Macintosh

- 1 While the document is printing, click the printer icon in the Dock.
- 2 From the print queue dialog, choose the job that you want to cancel, and then click **Delete**.

Working with photos

You can also use the programs that are installed with the printer software to customize and print photos. For more information, see the Help associated with these programs.

Inserting a memory card

1 Insert a memory card.

- Insert the card with the brand name label facing up.
- If there is an arrow on the card, make sure it points toward the printer.
- If needed, make sure you connect the memory card to the adapter that came with it before inserting it into the slot.

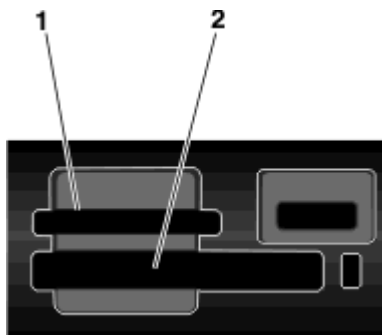

Slot	Memory card
1	<ul style="list-style-type: none">• Secure Digital (SD)• High Capacity Secure Digital (with adapter)• Micro Secure Digital (with adapter) (Micro SD)• Mini Secure Digital (with adapter) (Mini SD)• MultiMedia Card (MMC)• Reduced Size MultiMedia Card (with adapter) (RS-MMC)• MultiMedia Card mobile (with adapter) (MMCmobile)• Memory Stick• Memory Stick PRO• Memory Stick Duo (with adapter)• Memory Stick PRO Duo (with adapter)• xD-Picture Card• xD-Picture Card (Type H)• xD-Picture Card (Type M)
2	<ul style="list-style-type: none">• Compact Flash Type I and Type II• Microdrive

- 2 Wait for the light located near the top memory card slot on the printer to come on. The light blinks to indicate the memory card is being read or is transmitting data.

Warning—Potential Damage: Do not touch cables, any network adapter, any connector, the memory card, or the printer in the area shown while actively printing, reading, or writing from the memory card. A loss of data can occur. Also, do not remove the memory card while actively printing, reading, or writing from it.



When the printer detects the memory card, the message **Memory Card Detected** appears on the printer control panel display.

If the printer does not read the memory card, then remove and reinsert it.

Notes:

- The printer recognizes one memory card at a time. If you insert more than one memory card, then a message appears on the display prompting you to remove one of the memory cards.
- If a flash drive or a digital camera set to mass storage mode is inserted into the PictBridge port while a memory card is in the card slot, then a message appears on the display prompting you to choose which memory device to use.

Inserting a flash drive

- 1 Insert the flash drive into the PictBridge port on the front of the printer.



Note: An adapter may be necessary if your flash drive does not fit directly into the port.

- 2 Wait for the printer to recognize that a flash drive is installed. When the flash drive is recognized, the message **Storage Device Detected** appears.

If the printer does not read the flash drive, remove and reinsert it.

Warning—Potential Damage: Do not touch cables, any network adapter, any connector, the flash drive, or the printer in the area shown while actively printing, reading, or writing from the flash drive. A loss of data can occur. Also, do not remove the flash drive while actively printing, reading, or writing from the flash drive.



Note: The printer recognizes one active media device at a time. If you insert more than one media device, a message appears on the display prompting you to designate the device you want the printer to recognize.

Retrieving and managing photos

Transferring photos from a memory device to the computer

Using the printer control panel

Notes:

- You cannot transfer photos from a memory device to a computer through an external network adapter that does not support memory device connection.
- The printer may require that you select a computer (and a PIN if required by that computer).



1 Insert a memory card, flash drive, or digital camera set to mass storage mode.

2 From the printer control panel, press .



3 Press the arrow buttons until **Save Photos** appears, and then press .

4 Do one of the following:

USB connection

- a** Press .
- b** Press .
- c** On the computer screen, select an option to save photos to the computer.
- d** Follow the instructions on the computer screen.

Wireless connection (selected models only)

- a** Press the arrow buttons until **Network** appears, and then press .
- b** If prompted, press the arrow buttons to select the network computer where you want to save the photos, and then press .

Notes:

- You may be prompted to enter a PIN if the computer requires it. To assign a computer name and a PIN to the network computer, see the Help for the printer software associated with your operating system.
- Use the arrow buttons to increase or decrease the value for each digit (the default value is 0000) in the PIN, and then press  each time you select a digit.

- c On the computer screen, select an option to save photos to the computer.
- d Follow the instructions on the computer screen.

Using Lexmark Productivity Studio in Windows

- If you installed Lexmark Productivity Studio, and if the printer is connected to the computer through a USB cable, then the program launches when you insert the memory device. Follow the instructions on the computer screen to transfer photos.
- If the printer is connected to the computer through a network:
 - 1 Do one of the following:
 - In Windows Vista, click .
 - In Windows XP and earlier, click **Start**.
 - 2 Click **All Programs** or **Programs**, and then select the printer program folder from the list.
 - 3 Click **Lexmark Productivity Studio**.
 - 4 From the Photo Printing section of the main screen, click **Download to library**.
 - 5 Browse to the location of the memory device, and then click **Transfer**.
 - 6 Select the network printer.
 - 7 Insert the memory device into the network printer.
 - 8 Follow the instructions on the computer screen.

Using the Lexmark Network Card Reader in Macintosh

If the printer is connected to a computer through a network, then you can transfer photos from a memory card or flash drive to the computer using the Lexmark Network Card Reader. The printer may require that you select a computer (and a PIN, if required by that computer).

- 1 Insert a memory card, flash drive or a digital camera set to mass storage mode.
- 2 From the Finder desktop, double-click the printer folder.
- 3 Double-click the **Lexmark Network Card Reader** icon.

- 4 From the Source list, choose the printer that you want to use, and then click . Thumbnails of the photos stored on the memory device appear on the dialog.

- 5 If you want to enlarge the thumbnails, then click and drag the slider .
- 6 Select the photos that you want to save, and then click **Save**.
- 7 Browse to the location of the folder where you want to save the photos and documents, and then click **Save**.

Note: For more information, see the Help associated with the application.

Using the default Image Capture application in Macintosh

If the printer is connected to the computer through a USB cable, and you have set an application to launch when a memory device is connected to the computer, then the application automatically launches. Use it to transfer photos to the computer.

Transferring photos from a memory card to a flash drive

- 1 Insert a memory card into the printer.
- 2 After the memory card is detected, press the arrow buttons until **Save Photos** appears.
- 3 Insert the flash drive into the printer, and then press the arrow buttons until **USB Flash Drive** appears.
- 4 Use the arrow buttons to select a save option. You can transfer all the photos, the most recent photo, or photos within a date range. Press **OK** when you make a selection.
- 5 Follow the instructions on the printer control panel display.

Notes:

- If there is not enough memory on the flash drive, a prompt appears on the display.
- Do not remove the flash drive until a message appears on the display indicating that copying is complete.

Printing photos

For more options on printing photos and customizing photos, see the Help associated with the programs installed with the printer software.

Printing photos using the printer control panel

- 1 Load photo paper with the glossy or printable side facing you. (If you are not sure which side is the printable side, see the instructions that came with the paper.)
- 2 From the printer control panel, press .
- 3 Insert a memory card, flash drive, or digital camera set to mass storage mode.
- 4 Press the arrow buttons until **Easy Photo** or **Print Photos** appears, and then press **OK**.

Notes:

- Select **Easy Photo** if you want to print photos quickly.
- Select **Print Photos** if you want to customize the photos before printing the photos.

- 5 Press the arrow buttons to select an option on printing photos, and then press **OK**.

Note: You can choose to print the most recent photo, print all the photos, print photos that fall within a date range, or print photos by selecting the photo numbers that are on the proof sheet. If you want to check the photo numbers of the photos before printing, then print a proof sheet.

- 6 Do one of the following:

- If you are in the **Easy Photo** menu, use the arrow buttons to select the paper size and photo size. Press **OK** each time you make a selection.
- If you are in the **Print Photos** menu, use the arrow buttons to select the photo size, paper size, paper type, layout, and quality of the photos, and to adjust the brightness and color effects of the photos. Press **OK** each time you make a selection.

- 7 Press .

Note: To prevent smudging or scratching, avoid touching the printed surface with your fingers or sharp objects. For best results, remove each printed sheet individually from the paper exit tray, and allow the prints to dry at least 24 hours before stacking, displaying, or storing.

Printing photos from the computer using the printer software

- 1 Load photo paper with the glossy or printable side facing you. (If you are not sure which side is the printable side, then see the instructions that came with the paper.)
- 2 To print the photos:

Using Windows

- a Do one of the following:
 - In Windows Vista, click .
 - In Windows XP and earlier, click **Start**.
- b Click **All Programs** or **Programs**, and then select the printer program folder from the list.
- c Select **Lexmark Productivity Studio**.



Note: This program may not appear in your printer program folder, depending on whether you chose to install it with the printer software during installation.
- d Open the photo that you want to print.
- e Follow the instructions on the computer screen to edit and print photos. You may also view the Help associated with the program.

Using Macintosh

- a Customize the settings as needed in the Page Setup dialog.
 - 1 With a photo open, choose **File → Page Setup**.
 - 2 From the “Format for” pop-up menu, choose the printer.
 - 3 From the Paper Size pop-up menu, choose a paper size.
 - 4 Click **OK**.
- b Customize the settings as needed in the Print dialog.
 - 1 With a photo open, choose **File → Print**.
 - 2 From the Printer pop-up menu, choose the printer.
 - 3 From the print options pop-up menu, choose **Quality & Media**.
 - From the Paper Type pop-up menu, choose a paper type.
 - From the Print Quality menu, choose **Automatic** or **Photo**.
 - 4 Click **Print**.

Note: Manually choosing a paper type, even if you have a paper type sensor, turns off the sensor for the current print job.

Printing photos from a memory device using the printer software

- 1 Load photo paper with the glossy or printable side facing you. (If you are not sure which side is the printable side, then see the instructions that came with the paper.)
- 2 Insert a memory card, flash drive, or digital camera set to mass storage mode.
- 3 From the printer control panel, press .
- 4 Press the arrow buttons until **Save Photos** appears, and then press .
- 5 Transfer the photos to the computer.

USB connection

a Press .

b If you are using Windows:

If you installed Lexmark Productivity Studio, then it launches when you insert the memory device. Follow the instructions on the computer screen to transfer the photos to the computer, and then use the programs installed on the computer to print the photos.

If you are using Macintosh:

If you have iPhoto installed on the computer, then it launches when you insert the memory device. Follow the instructions on the computer screen to transfer the photos to the computer, and then use the applications installed on the computer to print the photos.

Wireless connection (selected models only)

a Press the arrow buttons until **Network** appears, and then press .

b If prompted, press the arrow buttons to select the network computer where you want to save the photos, and then press .

c If you are using Windows:

1 Do one of the following:

- In Windows Vista, click .
- In Windows XP and earlier, click **Start**.

2 Click **All Programs** or **Programs**, and then select the printer program folder from the list.

3 Click **Lexmark Productivity Studio**.

4 From the Photo Printing section of the main screen, click **Download to library**.

5 Browse to the location of the memory device, and then click **Transfer**.

6 Select the network printer.

7 Follow the instructions on the computer screen to transfer and print the photos.

If you are using Macintosh:

If the printer is connected to the computer through a network, then the Lexmark Network Card Reader launches on the computer.

Transfer the photos to the computer using the application, and then use the applications installed on the computer to print the photos.

For more information on transferring photos using the Lexmark Network Card Reader, see the Help associated with the application.

Applying color effects to photos using the printer control panel

You can use the printer control panel to apply color effects to your photos.

- 1** Load photo paper with the glossy or printable side facing you. (If you are not sure which side is the printable side, then see the instructions that came with the paper.)
- 2** From the printer control panel, press .
- 3** Insert a memory card or flash drive.
- 4** Press the arrow buttons until **Print Photos** appears.

5 Press the arrow buttons to select an option on how to print the photos, and then press **OK**.

Note: You can choose to print the most recent photo, print all the photos, print photos that fall within a date range, or print photos by selecting photo numbers.

Lighter/Darker appears on the display.

6 Press the arrow buttons to adjust the brightness of the photo, and then press **OK**.

Photo Effects appears on the display.

7 Press the arrow buttons to select a color effect. You can choose to auto-enhance the photo, or print the photo in sepia, antique grey, or antique brown. Press **OK** when you make a selection.

Note: The color effect applies to all the photos you print until the active memory card or flash drive is removed.

8 Use the arrow buttons to select the photo size, paper size, paper type, layout, and quality of the photos. Press **OK** each time you make a selection.

9 Press **●** to print the photos.

Note: You can also apply color effects to photos using the Lexmark Productivity Studio (if you installed the program during software installation). For more information on applying color effects to photos, see the Help associated with the program.

Printing photos from a PictBridge-enabled digital camera

PictBridge is a technology available in most digital cameras that lets you print directly from your digital camera without using a computer. You can connect a PictBridge-enabled digital camera to the printer, and use the camera to control printing photos.

1 Insert one end of the USB cable into the camera.

Note: Use only the USB cable that came with the camera.

2 Insert the other end of the cable into the PictBridge port on the front of the printer.



Notes:

- Make sure that the PictBridge-enabled digital camera is set to the correct USB mode. If the camera USB selection is incorrect, then the camera is detected as a USB storage device, or an error message will be displayed on the printer control panel. For more information, see the camera documentation.
- The printer reads only one media device at a time.

Warning—Potential Damage: Do not touch the USB cable, any network adapter, any connector, or the printer in the area shown while actively printing from a PictBridge-enabled digital camera. A loss of data can occur. Also, do not remove the USB cable or network adapter while actively printing from a PictBridge-enabled digital camera.





- 3 If the PictBridge connection is successful, then the following message appears on the display: **PictBridge Camera detected. Press OK to change settings.**
- 4 Use the camera to choose and print photos. If desired, you can also use the Pictbridge menu to select the paper size, paper type, photo size, and layout of the photos that you want to print.
Press **OK** to access the PictBridge menu, and then press **OK** each time you make a selection.

Notes:

- If you insert the camera while the printer is performing another job, wait for the job to finish before printing from the camera.
- To use the camera to control printing photos, see the instructions in the camera documentation.

Printing photos stored on a memory device using the proof sheet

- 1 Load letter- or A4-size plain paper.
- 2 From the printer control panel, press .
- 3 Insert a memory card or flash drive.
- 4 Press the arrow buttons until **Proof Sheet** appears, and then press **OK**.
- 5 Press the arrow buttons to select an option to print a proof sheet.
You can print a proof sheet:
 - For all photos on the memory device.
 - For the 20 most recent photos, if there are 20 or more photos on the memory device.
 - By date, if the photos on the card were taken on different dates. If you choose this option, use the arrow buttons on the printer control panel to choose the date range, and then press **OK** to save your selections.
- 6 Press .
- The proof sheets prints.
- 7 Follow the instructions on the proof sheet to select which photos to print, the number of copies per photo, red-eye reduction, page layout, print options, and paper size.
Note: When making selections, make sure to fill in the circles completely.
- 8 Load the proof sheet facedown on the scanner glass.
Scan Proof Sheet appears on the display.
Note: If this option does not appear on the display, then press the arrow buttons until it appears on the display.
- 9 Press .
- The printer scans the proof sheet.

- 10 Load photo paper vertically in the center of the paper support, with the glossy or printable side facing you. (If you are not sure which side is the printable side, then see the instructions that came with the paper.)

Note: Make sure that the paper matches the size that you selected on the proof sheet.

- 11 Press  to print the photos.

Note: To prevent smudging or scratching, avoid touching the printed surface with your fingers or sharp objects. For best results, remove each printed sheet individually from the paper exit tray, and then allow the prints to dry at least 24 hours before stacking, displaying, or storing.

Printing photos from a digital camera using DPOF

Digital Print Order Format (DPOF) is a feature available on some digital cameras. If your camera supports DPOF, then you can specify which photos to print, how many of each, and the print settings while the memory card is still in the camera. The printer recognizes these settings when you insert the memory card into the printer or connect the camera to the printer.

Note: If you specify a photo size while the memory card is still in the camera, then make sure that the size of the paper loaded in the printer is not smaller than the size you specify in the DPOF selection.

- 1 Load photo paper with the glossy or printable side facing you. (If you are not sure which side is the printable side, then see the instructions that came with the paper.)

- 2 Insert a memory card.

When the printer detects the memory card, the message **Memory Card Detected** appears on the printer control panel display.

- 3 Press the arrow buttons until **Print Photos** appears, and then press .







- 4 Press the arrow buttons until **Print DPOF** appears, and then press  to print the photos.

Note: This option appears only if a DPOF file is detected in the memory card.





Note: To prevent smudging or scratching, avoid touching the printed surface with your fingers or sharp objects. For best results, remove each printed sheet individually from the paper exit tray, and allow the prints to dry at least 24 hours before stacking, displaying, or storing.

Copying

Making copies

- 1 Load paper.
- 2 Load the original document facedown on the scanner glass.
- 3 From the printer control panel, press .
- 4 Press the arrow buttons to select the number of copies, and then press  or  to set a color or black-and-white copy.
Note: The  light is on when the printer is in color mode. The  light is on when the printer is in black-and-white mode.
- 5 Press .



Copying photos

- 1 Load photo paper with the glossy or printable side facing you. (If you are not sure which side is the printable side, then see the instructions that came with the paper.)
- 2 Place a photo facedown on the scanner glass.
- 3 From the printer control panel, press .
- 4 Press  until **Photo Reprint** appears.
- 5 Press the arrow buttons until **Yes** appears, and then press .
- 6 Press the arrow buttons until the desired paper size appears. If your desired paper size is not on the list, select **Other**. Additional paper size options appear on the display.
Press  when you make a selection.
- 7 Press .

Note: Make sure you loaded a photo paper into the printer.

Note: To prevent smudging or scratching, avoid touching the printed surface with your fingers or sharp objects. For best results, remove each printed sheet individually from the paper exit tray, and allow the prints to dry at least 24 hours before stacking, displaying, or storing.

Enlarging or reducing images

- 1 Load paper.
- 2 Load an original document facedown on the scanner glass.
- 3 From the printer control panel, press .
- 4 Press  until **Resize** appears.
- 5 Press the arrow buttons until the setting that you want appears.

Notes:

- If you select Custom Resize, press **OK** to enter the next menu, and then press the arrow buttons until the setting that you want appears. Press **OK** to save the setting that you selected.
- If you select Borderless, then the printer will reduce or enlarge the document or photo as necessary to print a borderless copy on the paper size that you selected. For best results with this resize setting, use photo paper and set the paper type selection to Photo, or let the printer automatically detect the paper type.

6 Press **OK**.

Note: After the copy job is finished, press **X** to reset the settings to the default. The resize setting also switches to 100% after two minutes of printer inactivity.

Adjusting copy quality

- 1 Load paper.
- 2 Load an original document facedown on the scanner glass.
- 3 From the printer control panel, press **OK**.
- 4 Press **OK** until **Quality** appears.
- 5 Press the arrow buttons to set the copy quality to Automatic, Draft, Normal, or Photo, and then press **OK** to save your setting.
- 6 Press **OK**.

Making a copy lighter or darker

- 1 Load paper.
- 2 Load an original document facedown on the scanner glass.
- 3 From the printer control panel, press **OK**.
- 4 Press **OK** until **Lighter/Darker** appears.
- 5 Press the arrow buttons to adjust the slider, and then press **OK** to save your setting.

Note: Pressing the left arrow button makes the copy lighter, and pressing the right arrow button makes the copy darker.

6 Press **OK**.

Collating copies using the printer control panel







If you print multiple copies of a document, then you can choose to print each copy as a set (collated) or to print the copies as groups of pages (not collated).

Collated





Not collated



- 1 Load paper.
- 2 Load an original document facedown on the scanner glass.
- 3 From the printer control panel, press .
- 4 Press the arrow buttons to select the number of copies, and then press .
- 5 Press  until **Collate** appears.
- 6 Press the arrow buttons until **On** appears.
- 7 Press  to save the image of the page to the printer memory.
- 8 When prompted if you want to scan another page, press .
- 9 Load the next page of the original document facedown on the scanner glass, and then press .
- 10 Repeat steps 8 and 9 until all the pages that you want to copy have been saved to the printer memory.
- 11 When prompted if you want to scan another page, press the arrow buttons until **No** appears, and then press  to start printing the copies.





Repeating an image on one page



You can print the same page image multiple times on one sheet of paper. This option is helpful when creating labels, decals, flyers, handouts, and so on.

- 1 Load paper.
- 2 Load an original document facedown on the scanner glass.
- 3 From the printer control panel, press .
- 4 Press  until **Copies per Sheet** appears.
- 5 Press the arrow buttons to choose the number of times that an image is repeated on a page: once, four times, nine times, or 16 times.
- 6 Press .



Copying multiple pages on one sheet (N-Up)

The N-Up setting lets you copy multiple pages on one sheet by printing smaller images of each page. For example, you can condense a 20-page document into 5 pages if you use the N-Up setting to print 4 page images per sheet.

- 1 Load paper.
- 2 Load an original document facedown on the scanner glass.
- 3 From the printer control panel, press .
- 4 Press  until **Pages per Sheet** appears.
- 5 Press the arrow buttons to choose the number of pages that you want to copy on a sheet of paper. You may choose to copy one, two, or four page images on a sheet.
- 6 Press  to save the image of the page to the printer memory.
- 7 When prompted if you want to scan another page, press  to choose **Yes**.

- 8** Load the next page of the original document facedown on the scanner glass, and then press .
- 9** Repeat steps 7 and 8 until all the pages that you want to copy have been saved to the printer memory.
- 10** When asked if you want to scan another page, press the arrow buttons until **No** appears, and then press  to start printing.

Canceling a copy job

- 1** Press .
Scanning stops and the scanner bar returns to its home position.
- 2** Press  to turn off the printer.

Scanning

For more options on scanning and customizing scanned images, see the Help associated with the programs installed with the printer software.

Scanning original documents

You can scan and then print photos, text documents, magazine articles, newspapers, and other publications. You can also scan a document for faxing.

Using the printer control panel





- 1 Open the top cover, and then load an original document facedown on the scanner glass.





- 2 Close the top cover to avoid dark edges on the scanned image.

- 3 From the printer control panel, press .

Scan to appears on the display. You can send the scanned image to a computer, flash drive, memory card, or to a computer over a network.

- If you choose to send the scanned image to the computer:
 - a Press .
 - b Wait until the printer has finished downloading the scan applications list.
 - c Press the arrow buttons until the application that you want appears, and then press .
 - d Use the arrow buttons to select the quality and original image size, and then press  each time you make a selection.
 - e Press .
- If you choose to send the scanned image to a memory card or flash drive:
 - a Insert the memory device.

Note: Make sure that the memory device is not write-protected.
 - b Press the arrow buttons until **Memory Card** or **USB Flash Drive** appears, and then press .

- c Use the arrow buttons to select the quality and original image size, and then press **OK** each time you make a selection.
- d Press .

Note: Do not remove the memory device until the menu indicates that the file has been saved.

- If you choose to send the scanned image to a computer over the network (selected models only):
 - a Press the arrow buttons until **Network** appears, and then press **OK**.
 - b If prompted, press the arrow buttons until the computer name of the network computer appears, and then press **OK**.

Notes:

- You may be prompted to enter a PIN if the computer requires it. To assign a computer name and a PIN to the network computer, see the Help for the printer software associated with your operating system.
- Use the arrow buttons to increase or decrease the value for each digit (the default value is 0000) in the PIN, and then press **OK** each time you select a digit.

- c Wait until the printer has finished downloading the scan applications list.
- d Press the arrow buttons until the application that you want appears, and then press **OK**.
- e Use the arrow buttons to select the quality and original image size, and then press **OK** each time you make a selection.
- f Press .

Note: Do not remove the memory device until the menu indicates that the file has been saved.



Using Windows

- 1 Open the top cover, and then load an original document facedown on the scanner glass.
- 2 Close the top cover to avoid dark edges on the scanned image.
- 3 Do one of the following:
 - In Windows Vista, click .
 - In Windows XP and earlier, click **Start**.
- 4 Click **All Programs** or **Programs**, and then select the printer program folder from the list.
- 5 Click **Lexmark Productivity Studio**.
- 6 From the Photo Printing section of the main screen, click **Scan**.
- 7 Follow the instructions on the computer screen.

Using Macintosh

- 1 Open the top cover, and then load an original document facedown on the scanner glass.
- 2 Close the top cover to avoid dark edges on the scanned image.
- 3 From the Finder desktop, double-click the printer folder.
- 4 Double-click **XXXX Series Center**, where XXXX is the printer series.
- 5 From the "What is being scanned?" menu, choose the type of document to be scanned.
- 6 Click **Scan**.



Scanning color or black-and-white original documents

- 1 Open the top cover, and then load an original document facedown on the scanner glass.
- 2 Close the top cover to avoid dark edges on the scanned image.
- 3 From the printer control panel, press .
- 4 Press the arrow buttons to choose where to send the scanned image. You can send the scanned image to a computer, flash drive, memory card, or to a computer over a network.
- 5 When the destination that you want appears, press .
- 6 To scan black-and-white documents, press .

Note: The default setting when you are using the Scan mode is Color. You do not need to press  if you are scanning a color document.

- 7 Press .

Scanning photos for editing

- 1 Open the top cover, and then load an original document facedown on the scanner glass.
- 2 Close the top cover to avoid dark edges on the scanned image.
- 3 From the printer control panel, press .
- 4 Press the arrow buttons until **Computer** or **Network** appears, and then press .

Note: If you choose Network, you will be asked to select a network computer. If prompted, press the arrow buttons until the network computer that you want appears, and then press .



- 5 Wait for the printer to finish downloading the applications list.

Note: This list is downloaded from the applications available on the computer. Make sure a photo-editing application is installed on the computer.

- 6 From the list of applications, press the arrow buttons until the application that you want appears.
- 7 Press .

The scanned image is sent to the photo-editing application that you selected.

Scanning to a computer over a network

- 1 Make sure that:
 - The printer is connected to a network through a print server or through a wireless network connection.
 - The printer, the print server (if used), and the computer receiving the scanned image are all turned on.
 - The printer is configured to scan over a network.
- 2 Load an original document facedown on the scanner glass.
- 3 From the printer control panel, press .
- 4 Press the arrow buttons until **Network** appears, and then press .
- 5 If prompted, press the arrow buttons to select the computer name of the network computer where you want to send the scanned image, and then press .

Notes:

- You may be prompted to enter a PIN if the computer requires it. To assign a computer name and a PIN to the network computer, see the Help for the printer software associated with your operating system.
- Use the arrow buttons to increase or decrease the value for each digit (the default value is 0000) in the PIN, and then press  each time you select a digit.

6 Wait until the printer has finished downloading the scan applications list.

7 Press the arrow buttons until the application that you want appears, and then press .

8 Press .

Canceling scan jobs

Using the printer control panel

To cancel a scan job started in the printer control panel, press .

Using Windows

To cancel a scan job started in the Lexmark Productivity Studio, click **Stop** on the computer screen.

Using Macintosh

To cancel a scan job started in the Lexmark All-in-One Center, click **Cancel** on the computer screen.

Faxing

Before you send a fax, make sure:

- The printer is connected to a computer with an active fax modem, the computer is configured to fax, a phone line is connected to the computer, and both the printer and computer are on.
- The Lexmark Fax Solutions and Lexmark Productivity Studio software are installed on your computer. If you have not installed these additional programs during initial installation, reinsert the installation software CD, run the installation software, and then select **Install Additional Software** from the Software Already Installed screen.

Sending a fax using the computer

You can scan a document to the computer and then fax it to someone using the software.

Using Windows

- 1 Load an original document facedown on the scanner glass.
- 2 Do one of the following:
 - In Windows Vista, click .
 - In Windows XP and earlier, click **Start**.
- 3 Click **All Programs** or **Programs**, and then select the printer program folder from the list.
- 4 Click **Lexmark Productivity Studio**.
- 5 From the Welcome Screen, click **Fax**.
- 6 Select the **Document** option.
- 7 Click **Start**.
- 8 Enter the recipient information, and then click **Next**.

Note: A fax number can include up to 64 numbers, commas, periods, spaces, and/or these symbols: * # + - ().
- 9 Enter the cover page information, and then click **Next**.
- 10 If there are any additional documents that you want to send with your fax, add these now, and then click **Next**.
- 11 To send your fax:
 - Immediately—Select the **Send now** option.
 - At a scheduled time:
 - a Select the **Delay sending until** option.
 - b Set a time and date.
- 12 If you want a paper copy of your fax, then select **Print a copy of your fax**.
- 13 Click **Send**.

Using Macintosh

- 1 Load an original document facedown on the scanner glass.
- 2 From the Finder desktop, double-click the printer folder.

- 3 Double-click **XXXX Series Center**, where XXXX is the printer series.
- 4 From the “What is being scanned?” menu, choose the type of document to be scanned.
- 5 From the “How will the scanned image be used?” pop-up menu, choose **To be faxed**.
- 6 From the “Send scanned image to” pop-up menu, choose **Preview**.
- 7 If you have more than one page to fax, select **Prompt for multiple pages**.
- 8 Click **Scan**.
The Scan dialog appears with a preview of the document.
- 9 From the Scan dialog, click **File → Print**.
- 10 Do one of the following:
 - In Mac OS X version 10.4 or later, select **Fax PDF** from the PDF drop-down menu.
 - In Mac OS X version 10.3, click **Fax**.
- 11 In the “To” field, enter the fax number of the recipient.
You can also click  to choose a recipient from the Address Book, a built-in application in Macintosh. The Address Book shows only contacts with fax numbers.
- 12 If you want to include a cover page, select **Use Cover Page**, and then enter the subject of the fax and a message for the recipient.
- 13 Click **Fax**.

Receiving a fax

Using Windows

- 1 Do one of the following:
 - In Windows Vista, click .
 - In Windows XP and earlier, click **Start**.
- 2 Click **All Programs** or **Programs**, and then select the printer program folder from the list.
- 3 Click **Lexmark Productivity Studio**.
- 4 From the Settings area in the left pane of the Welcome screen, click **Set up and manage faxes**.
- 5 From the “I Want To” menu, click **Adjust speed dial list and other fax settings**.
- 6 Click the **Ringling and Answering** tab.
- 7 From the “Automatically answer incoming calls as a fax” area, select **On** from the Auto Answer drop-down list.
- 8 To turn the Auto Answer feature on and off at scheduled times, select the settings that you want from the drop-down lists.
- 9 To set the number of telephone rings before the printer automatically receives faxes, select a setting from the “Pick-up on the” drop-down list in the “Answering on your phone line type” area.
- 10 Click **OK** to save the settings.

Using Macintosh

In Mac OS X version 10.5

- 1 From the menu bar, click  → **System Preferences**.
- 2 Click **Print & Fax**.
- 3 From the Faxes list, click **Internal Modem**.
- 4 Click **Receive Options**.
- 5 Select **Receive faxes on this computer**.
- 6 Select **Print to**, and then choose the printer from the pop-up menu.
- 7 Customize other settings as needed, and then click **OK**.

In Mac OS X version 10.4

- 1 From the menu bar, click  → **System Preferences**.
- 2 Click **Print & Fax**.
- 3 Click the **Faxing** tab.
- 4 Select **Receive faxes on this computer**.
- 5 Click **Set Up Fax Modem**.
The Fax list appears.
- 6 Click **Internal Modem**, and then close the Fax list.
- 7 Select **Print on printer**, and then choose the printer from the pop-up menu.
- 8 Customize other settings as needed.

In Mac OS X version 10.3

- 1 From the menu bar, click  → **System Preferences**.
- 2 Click **Print & Fax**.
- 3 Click the **Faxing** tab.
- 4 Select **Receive faxes on this computer**.
- 5 Select **Print on printer**, and then choose the printer from the pop-up menu.
- 6 Customize other settings as needed.

Maintaining the printer

Maintaining print cartridges

Installing print cartridges

- 1 Open the printer, and then press down on the cartridge carrier levers.

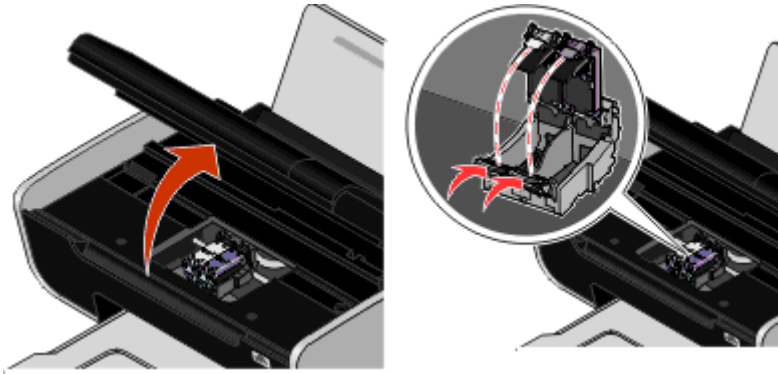

- 2 Remove the used print cartridge or cartridges.
- 3 If you are installing new print cartridges, remove the tape from the back and bottom of the color cartridge, insert the cartridge in the right carrier, and then close the color cartridge carrier lid.

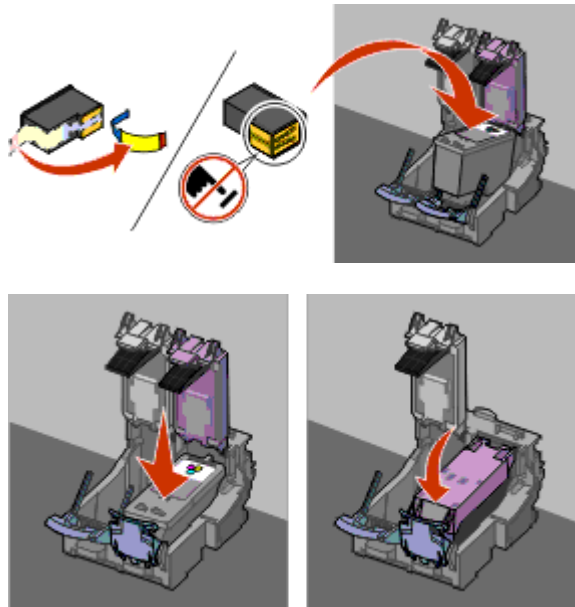

Warning—Potential Damage: Do *not* touch the gold contact area on the back or the metal nozzles on the bottom of the cartridge.

- 4 If a black cartridge is included in the box contents, remove the tape from the back and bottom of the black cartridge, insert the cartridge in the left carrier, and then close the black cartridge carrier lid.

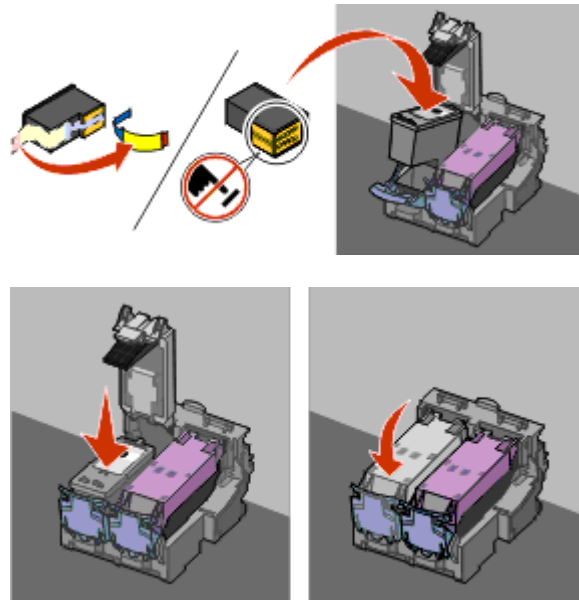

Warning—Potential Damage: Do *not* touch the gold contact area on the back or the metal nozzles on the bottom of the cartridge.

- 5 Close the printer, making sure to keep your hands out from underneath the scanner unit.

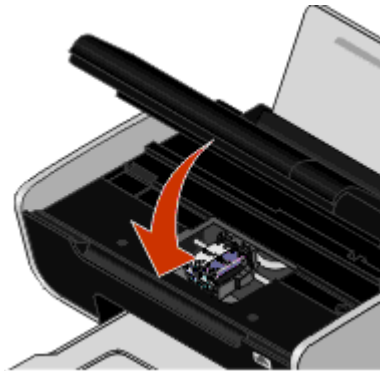

Removing a used print cartridge

- 1 Make sure the printer is on.
- 2 Lift the scanner unit.

The print cartridge carrier moves and stops at the loading position, unless the printer is busy.

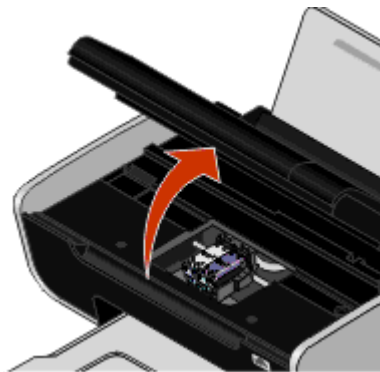

3 Press down on the cartridge carrier latch to raise the cartridge carrier lid.

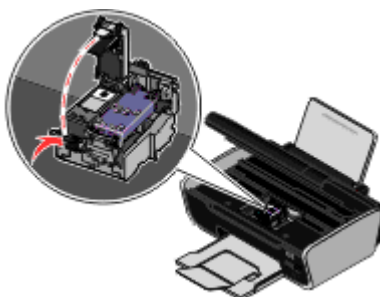

4 Remove the used print cartridge.

Note: If you are removing both cartridges, repeat step 3 and step 4 for the second cartridge.

Refilling print cartridges

The warranty does not cover repair of failures or damage caused by a refilled cartridge. Lexmark does not recommend use of a refilled cartridge. Refilling a cartridge can affect print quality and may cause damage to the printer. For best results, use Lexmark supplies.

Using genuine Lexmark print cartridges

Lexmark printers, print cartridges, and photo paper are designed to perform together for superior print quality.

If you receive an **Out of Original Lexmark Ink** message, the original Lexmark ink in the indicated cartridge (s) has been depleted.

If you believe you purchased a new, genuine Lexmark print cartridge, but the **Out of Original Lexmark Ink** message appears:

- 1** Click **Learn More** on the message.
- 2** Click **Report a non-Lexmark print cartridge**.



To prevent the message from appearing again for the indicated cartridge(s):

- Replace your cartridge(s) with new Lexmark print cartridge(s).
- If you are printing from a computer, click **Learn more** on the message, select the check box, and then click **Close**.
- If you are using the printer without a computer, press **Cancel**.

Lexmark's warranty does not cover damage caused by non-Lexmark ink or print cartridges.

Aligning print cartridges

Using the printer control panel

- 1 Load plain Letter-size paper.
- 2 From the printer control panel, press , and then press .
- 3 Press the arrow buttons until **Align Cartridges** appears, and then press .
An alignment page prints.

Using Windows

- 1 Load plain Letter-size paper.
- 2 Do one of the following:
 - In Windows Vista, click .
 - In Windows XP and earlier, click **Start**.
- 3 Click **All Programs** or **Programs**, and then select the printer program folder from the list.
- 4 From the printer folder, click **Maintenance → Align Cartridges**.
- 5 Click **Print**.
- 6 Follow the instructions on the computer screen.



Using Macintosh

- 1 Load plain Letter-size paper.
- 2 From the Finder desktop, double-click the printer folder.
- 3 Double-click the printer utility icon.
- 4 From the Maintenance tab, click **Print Alignment Page**.
- 5 Follow the instructions on the computer screen.

If you aligned the cartridges to improve print quality, print your document again. If print quality has not improved, then clean the print cartridge nozzles.

Cleaning the print cartridge nozzles

Using the printer control panel

- 1 Load plain Letter-size paper.
- 2 From the printer control panel, press , and then press .
- 3 Press the arrow buttons until **Clean Cartridges** appears, and then press .
A page prints, forcing ink through the print cartridge nozzles to clean them.
- 4 Print the document again to verify that the print quality has improved.

Using Windows

- 1 Load plain Letter-size paper.
- 2 Do one of the following:
 - In Windows Vista, click .
 - In Windows XP and earlier, click **Start**.
- 3 Click **All Programs** or **Programs**, and then select the printer program folder from the list.
- 4 From the printer folder, click **Maintenance → Clean Cartridges**.
- 5 Click **Print**.

A page prints, forcing ink through the print cartridge nozzles to clean them.
- 6 Print the document again to verify that the print quality has improved.

Using Macintosh





- 1 Load plain Letter-size paper.
- 2 From the Finder desktop, double click the printer folder.
- 3 Double-click the printer utility icon.
- 4 From the Maintenance tab, click **Clean Print Nozzles**.

A page prints, forcing ink through the print cartridge nozzles to clean them.
- 5 Print the document again to verify that the print quality has improved.



If print quality has not improved, then try cleaning the nozzles up to two more times, or wipe the print cartridge nozzles and contacts.

Checking ink levels

Using the printer control panel

- 1 From the printer control panel, press , and then press .
- 2 Press  again.
- 3 Press the arrow buttons until **Color Ink** appears, and then press .

Check the ink level of the color cartridge. Install a new cartridge if necessary.

- 4 Press .
- 5 If a black cartridge is included in the box contents, and if you have installed a black cartridge in the printer, then press the arrow buttons until **Black Ink** appears, and then press .

Check the ink level of the black cartridge. Install a new cartridge if necessary.

- 6 Press  until you exit Setup, or press another mode button.

Using Windows

Use the Lexmark Service Center to check the ink levels of the cartridges.

- 1 Do one of the following:
 - In Windows Vista, click .
 - In Windows XP and earlier, click **Start**.
- 2 Click **All Programs** or **Programs**, and then select the printer program folder from the list.
- 3 Select **Lexmark Service Center**.
- 4 If you have not yet downloaded the Lexmark Service Center, download it.
- 5 Check the ink levels of the cartridges on the Printer Maintenance page.
Install a new cartridge if necessary.

Using Macintosh

- 1 From the Finder desktop, double click the printer folder.
- 2 Double-click the printer utility icon.
The Lexmark Printer Utility appears.
- 3 If an exclamation point (!) appears on a print cartridge, then the ink level is low. Install a new cartridge if necessary.

Wiping the print cartridge nozzles and contacts

- 1 Remove the print cartridge(s).
- 2 Dampen a clean, lint-free cloth with water, and then place the cloth on a flat surface.
- 3 Gently hold the nozzles against the cloth for about three seconds, and then wipe in the direction shown.

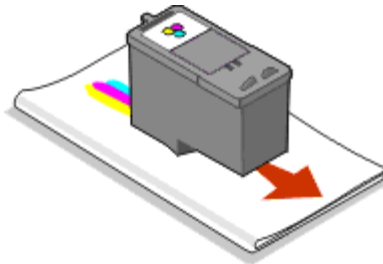

- Using another clean section of the cloth, gently hold the cloth against the contacts for about three seconds, and then wipe in the direction shown.

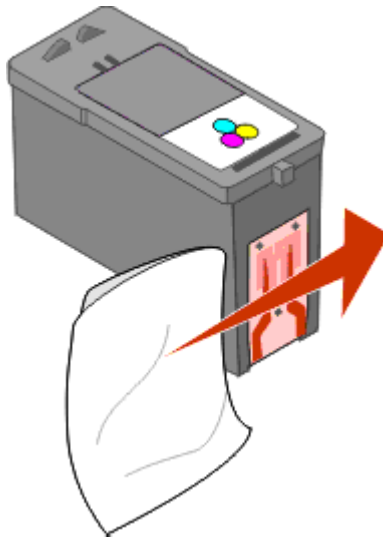

- With another clean section of the cloth, repeat step 3 and step 4, and then let the nozzles and contacts dry completely.
- Reinsert the print cartridge(s), and then print the document again.
- If the print quality does not improve, clean the print nozzles, and then try printing the document again.
- Repeat step 7 up to two more times.
- If print quality is still not satisfactory, replace the print cartridge(s).

Preserving the print cartridges

- Keep new cartridges in their packaging until you are ready to install them.
- Do not remove a cartridge from the printer except to replace, clean, or store it in an airtight container. The cartridges do not print correctly if left exposed for an extended period of time.

Cleaning the scanner glass

- Dampen a clean, lint-free cloth with water.
- Gently wipe the scanner glass clean.

Note: Make sure all ink or corrective fluid on a document is dry before placing the document on the scanner glass.

Cleaning the exterior of the printer

- Make sure that the printer is turned off and unplugged from the wall outlet.

 **CAUTION—SHOCK HAZARD:** To avoid the risk of electric shock, unplug the power cord from the wall outlet and disconnect all cables to the printer before proceeding.

- Remove paper from the paper support and paper exit tray.

3 Dampen a clean, lint-free cloth with water.

Warning—Potential Damage: Do not use household cleaners or detergents, as they may damage the finish of the printer.

4 Wipe only the outside of the printer, making sure to remove any ink residue that has accumulated on the paper exit tray.

Warning—Potential Damage: Using a damp cloth to clean the interior may cause damage to your printer.

5 Make sure the paper support and paper exit tray are dry before beginning a new print job.

Ordering supplies

Ordering print cartridges

Lexmark 3600-4600 Series models (except Lexmark 3690 and Lexmark 4690)

Item	Part number	Average cartridge standard page yield is up to ¹
Black cartridge	36A	Page yield values available at www.lexmark.com/pageyields .
Black cartridge ²	36	
High yield black cartridge	36XLA	
High yield black cartridge ²	36XL	
Color cartridge	37A	
Color cartridge ²	37	
High yield color cartridge	37XLA	
High yield color cartridge ²	37XL	
Photo cartridge	31	Not applicable

¹ Values obtained by continuous printing. Declared yield value in accordance with ISO/IEC 24711.
² Licensed Return Program Cartridge

Lexmark 3690 and Lexmark 4690 models

Item	Part number	Average cartridge standard page yield is up to ¹
Black cartridge	4A	Page yield values available at www.lexmark.com/pageyields .
Black cartridge ²	4	
Color cartridge	5A	
Color Cartridge ²	5	
Photo cartridge	31	Not applicable

¹ Values obtained by continuous printing. Declared yield value in accordance with ISO/IEC 24711.
² Licensed Return Program Cartridge

Ordering paper and other supplies

To purchase supplies or to locate a dealer near you, visit our Web site at www.lexmark.com.

For best results when printing photos or other high-quality images, use Lexmark Photo Paper or Lexmark PerfectFinish Photo Paper and Lexmark print cartridges.

Item	Description
Lexmark Photo Paper	<ul style="list-style-type: none">• Letter• A4• 4 x 6 in.• 10 x 15 cm
Lexmark PerfectFinish Photo Paper	<ul style="list-style-type: none">• Letter• A4• 4 x 6 in.• 10 x 15 cm• L
USB cable	Part number 1021294



Resetting to factory settings

Resetting all settings

You can reset your printer to the original settings without using the printer menus.







Note: Resetting to factory default settings will delete all the printer settings you have previously selected.

- 1 Turn off the printer.

Note: Make sure the printer is not in Power Saver mode. Press and hold  for 2 seconds to turn off the printer. If you have set the Power Saver timeout in the Setup menu, press and hold  according to the time you set in the menu.

- 2 From the printer control panel, press and hold  and , and then press  to turn the printer on.

Resetting menu settings

- 1 From the printer control panel, press .
- 2 Press the arrow buttons until **Default**s appears, and then press .
- 3 Press the arrow buttons until **Set Default**s appears, and then press .
- 4 Press the arrow buttons until **Use Factory** appears, and then press .
- 5 Press  again.
- 6 When prompted, press the arrow buttons to select a language, and then press .
- 7 Press the arrow buttons to select a country, and then press .

Initial Setup Complete appears on the display.

Troubleshooting

Using the printer troubleshooting software (Windows only)

The Lexmark Service Center provides step-by-step troubleshooting help and contains links to printer maintenance tasks and customer support.

To open the Lexmark Service Center, use one of these methods:

Method 1	Method 2
If it appears on an error message dialog, click the For additional assistance, use the Lexmark Service Center link.	<ol style="list-style-type: none">1 Do one of the following:<ul style="list-style-type: none">• In Windows Vista, click .• In Windows XP and earlier, click Start.2 Click All Programs or Programs, and then select the printer program folder from the list.3 Select Lexmark Service Center.

Setup troubleshooting

Incorrect language appears on the display

These are possible solutions. Try one of the following:







CHANGE THE LANGUAGE SELECTION DURING INITIAL SETUP

During initial setup, and every time you reset the printer to factory default settings, you will be asked to select a language.

To select a language, press the arrow buttons until the language that you want appears on the display, and then press .

SELECT A DIFFERENT LANGUAGE AFTER INITIAL SETUP

In case the wrong language was set during initial setup, you can still change the language settings of the printer.

- 1 From the printer control panel, press .
- 2 Press , and then press .
- 3 Press  again.
- 4 Press the arrow buttons until the language that you want appears on the display, and then press .
- 5 If you are sure, press  to change the language.

Power button is not lit

These are possible solutions. Try one or more of the following:



PRESS POWER BUTTON

Make sure the printer is on by pressing .

DISCONNECT AND RECONNECT THE POWER CORD

- 1 Disconnect the power cord from the wall outlet, and then from the printer.
- 2 Plug the cord all the way into the power supply on the printer.



- 3 Plug the cord into an electrical outlet that other electrical devices have been using.
- 4 If the  light is not on, press .

Software did not install

If you encountered problems while installing, or if your printer does not appear in the list in the Printers folder or as a printer option when sending a print job, you can try uninstalling and reinstalling the software.

These are some other possible solutions. Try one or more of the following:

MAKE SURE YOUR OPERATING SYSTEM IS SUPPORTED



The following operating systems are supported: Windows Vista, Windows XP, Windows 2000 with Service Pack 3 or later, and Mac OS X versions 10.5, 10.4 and 10.3.

CHECK THAT YOUR COMPUTER MEETS THE MINIMUM SYSTEM REQUIREMENTS LISTED ON THE PRINTER BOX

CHECK THE **USB** CONNECTION

- 1 Check the USB cable for any obvious damage. If the cable is damaged, use a new one.
- 2 Firmly plug the square end of the USB cable into the back of the printer.
- 3 Firmly plug the rectangular end of the USB cable into the USB port of the computer.
The USB port is marked with the  USB symbol.

RECONNECT THE POWER SUPPLY

- 1 Press  to turn the printer off.
- 2 Disconnect the power cord from the wall outlet.
- 3 Gently remove the power supply from the printer.
- 4 Reconnect the power supply to the printer.
- 5 Plug the power cord into the wall outlet.
- 6 Press  to turn the printer on.

TEMPORARILY DISABLE SECURITY PROGRAMS IN WINDOWS

- 1 Close all open programs.
- 2 Disable any security programs.
- 3 Do one of the following:
 - In Windows Vista, click .
 - In Windows XP and earlier, click **Start**.
- 4 Click **Computer** or **My Computer**.
- 5 Double-click the CD or DVD drive icon.
- 6 If necessary, double-click **setup.exe**.
- 7 Follow the instructions on the computer screen to install the software.
- 8 When the installation is completed, enable the security software again.

Page does not print

These are possible solutions. Try one or more of the following:

CHECK MESSAGES

If an error message appears, then resolve the error before trying to print again.

CHECK POWER

If the  light is not on, then make sure that the power cord is properly connected to the printer and plugged into a known working electrical outlet that other electrical devices have been using.

REMOVE AND THEN RELOAD PAPER

CHECK INK

Check the ink levels, and then install new print cartridges if necessary.

CHECK CARTRIDGES

- 1 Remove the print cartridges.
- 2 Make sure the sticker and tape have been removed.

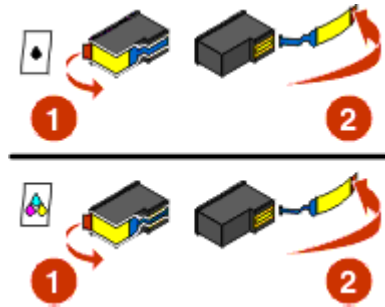

- 3 Reinsert the cartridges.

CHECK PRINTER DEFAULT AND PAUSE SETTINGS

Using Windows

- 1 Do one of the following:

In Windows Vista

- a Click .
- b Click **Control Panel**.
- c Under Hardware and Sound, click **Printer**.

In Windows XP

- a Click **Start**.
- b Click **Printers and Faxes**.

In Windows 2000

- a Click **Start**.
- b Click **Settings → Printers**.

- 2 Double-click the printer.
- 3 Click **Printer**.
 - Make sure no check mark appears next to Pause Printing.
 - If a check mark does not appear next to Set As Default Printer, then you must select the printer for each file that you want to print.

Using Macintosh



For Mac OS X version 10.5

- 1 From the Finder desktop, click  → **System Preferences** → **Print & Fax**.
- 2 From the Default Printer pop-up menu, check if the printer is the default printer.
If the printer is not the default printer, then you must select the printer for each file that you want to print.
If you want to set the printer as the default printer, then select the printer from the Default Printer pop-up menu.
- 3 Click **Open Print Queue**.
The print queue dialog appears.
Make sure that the print job is not on hold. If the print job is on hold:
 - If you want to resume a particular print job, choose the document name, and then click **Resume**.
 - If you want to resume all print jobs in the queue, then click **Resume Printer**.

For Mac OS X version 10.4 and earlier

- 1 From the Finder desktop, click **Go** → **Utilities** → **Print Center** or **Printer Setup Utility**.
The Printer List dialog appears.
- 2 Double-click the printer.
The print queue dialog appears.
 - Make sure that the print job is not on hold.
If the print job is on hold:
 - If you want to resume a particular print job, choose the document name, and then click **Resume**.
 - If you want to resume all print jobs in the queue, then click **Start Jobs**.
 - If the printer is not in bold, then it is not the default printer. You must select the printer for each file that you want to print.
If you want to set the printer as the default printer:
 - a Go back to the Printer List dialog, and then select the printer.
 - b Click **Make Default**.

DISCONNECT AND RECONNECT POWER SUPPLY

- 1 Press  to turn off the printer.
- 2 Disconnect the power cord from the wall outlet.
- 3 Remove the power supply from the printer.
- 4 Reconnect the power supply to the printer.
- 5 Plug the power cord into the wall outlet.
- 6 Press  to turn on the printer.

REMOVE AND REINSTALL THE SOFTWARE



If you encountered problems while installing, or if your printer does not appear in the printers folder or as a printer option when sending a print job, then try uninstalling and reinstalling the software.

Solving printer power problems

The printer and the computer cannot exchange data.

These are possible solutions. Try one or more of the following:

MAKE SURE THE PRINTER POWER SUPPLY IS ATTACHED CORRECTLY

- 1 Press  to turn the printer off.
- 2 Disconnect the power cord from the wall outlet.
- 3 Remove the power supply from the printer.
- 4 Reconnect the power supply to the printer.
- 5 Plug the power cord into the wall outlet.
- 6 Press  to turn the printer on.

MAKE SURE THE PRINTER IS NOT IN SLEEP MODE

If the power light is blinking on and off slowly, then the printer is in sleep mode.

- 1 Unplug the power cord from the wall outlet.
- 2 Wait ten seconds, and then insert the power cord into the wall outlet.
- 3 Press  to turn the printer on.

Removing and reinstalling the software

If the printer is not functioning properly, or if a communications error message appears when you try to use the printer, then you may need to remove and reinstall the printer software.

Using Windows

- 1 Do one of the following:
 - In Windows Vista, click .
 - In Windows XP and earlier, click **Start**.
- 2 Click **All Programs** or **Programs**, and then select the printer program folder from the list.
- 3 Select **Uninstall**.
- 4 Follow the instructions on the computer screen to remove the printer software.
- 5 Restart the computer before reinstalling the printer software.
- 6 Click **Cancel** on all New Hardware Found screens.
- 7 Insert the installation CD, and then follow the instructions on the computer screen to reinstall the software.
If the install screen does not appear automatically after you restart your computer, do one of the following:

In Windows Vista

- a Click .
- b In the Start Search box, type `D:\setup.exe`, where **D** is the letter of your CD or DVD drive.

In Windows XP and earlier

- a Click **Start**.
- b Click **Run**.
- c Type `D:\setup.exe`, where **D** is the letter of your CD or DVD drive.

Using Macintosh

- 1 Close all open software applications.
 - 2 From the Finder desktop, double-click the printer folder.
 - 3 Double-click the **Uninstaller** icon.
 - 4 Follow the instructions on the computer screen to remove the printer software.
 - 5 Restart the computer before reinstalling the printer software.
 - 6 Insert the installation CD, and then follow the instructions on the computer screen to reinstall the software.
- If the software still does not install correctly, visit our Web site at www.lexmark.com to check for the latest software.

- 1 In all countries or regions except the United States, select your country or region.
- 2 Click the links for drivers or downloads.
- 3 Select your printer family.
- 4 Select your printer model.
- 5 Select your operating system.
- 6 Select the file that you want to download, and then follow the instructions on the computer screen.

Enabling the USB port in Windows

To confirm that the USB port is enabled on the computer:

- 1 Do one of the following:

In Windows Vista

- a Click  → **Control Panel**.
- b Click **System and Maintenance** → **System**.
- c Click **Device Manager**.

In Windows XP

- a Click **Start**.
- b Click **Control Panel** → **Performance and Maintenance** → **System**.
- c From the Hardware tab, click **Device Manager**.

In Windows 2000

- a Click **Start**.
- b Click **Settings → Control Panel → System**.
- c From the Hardware tab, click **Device Manager**.

2 Click the plus sign (+) beside **Universal Serial Bus Controller**.

If USB Host Controller and USB Root Hub are listed, then the USB port is enabled.

For more information, see the computer documentation.

Wireless troubleshooting

Wireless troubleshooting checklist





Before beginning to troubleshoot the wireless printer, verify the following:

- The power supply is connected to the printer, and  is on.
- Your SSID is correct.
Print a network setup page to verify the SSID the printer is using.
If you are not sure if your SSID is correct, run the wireless setup again.
- Your WEP key or WPA passphrase is correct (if your network is secure).
Log into the wireless access point (wireless router) and check the security settings.
A security key is like a password. All devices on the same wireless network using WEP, WPA, or WPA2 share the same security key.
If you are not sure if your security information is correct, run the wireless setup again.
- The wireless network is working properly.
Try accessing other computers on your wireless network.
If your network has Internet access, try connecting to the Internet over a wireless connection.
- The printer is within the range of the wireless network.
For most networks, the printer should be within 100 feet (30 meters) of the wireless access point (wireless router).
- The printer is located away from obstacles that could block the wireless signal.
Remove any large metal objects between the access point and the printer.
Make sure the printer and wireless access point are not separated by poles, walls, or support columns containing metal or concrete.
- The printer is located away from other electronic devices that may interfere with the wireless signal.
Many devices can interfere with the wireless signal, including baby monitors, motors, cordless phones, security system cameras, other wireless networks, and some Bluetooth devices.
- The Wi-Fi indicator light is lit.
- The printer driver is installed on the computer from which you are performing a task.
- The correct printer port is selected.

- The computer and printer are both connected to the same wireless network.

Printing a network setup page

A *network setup page* lists the configuration settings of the printer, including the IP address and MAC address of the printer. You can print a network setup page only if your printer has an internal wireless print server.

- 1 Load plain paper.
- 2 From the printer control panel, press .
- 3 Press the arrow buttons until **Network Setup** appears, and then press .
Print Setup Page appears on the display.
- 4 Press .
- 5 Press  again.
The network setup page prints.

Wireless configuration does not continue after the USB cable is attached

Check the USB cable

If the configuration software does not allow you to continue configuring your printer wirelessly after you attach the USB cable, there may be a problem with the cable. Try one or more of the following:

- Make sure that the USB cable is not damaged. If there is any visible damage to the USB cable, try using a new one.
- Attach the cable directly to the computer and the printer. Hubs, switch boxes, and docking stations can sometimes interfere with the USB connection.
- Make sure the USB cable is correctly attached.
 - 1 Attach the large, rectangular connector to any USB port on your computer. USB ports may be on the front or the back of the computer, and may be horizontal or vertical.

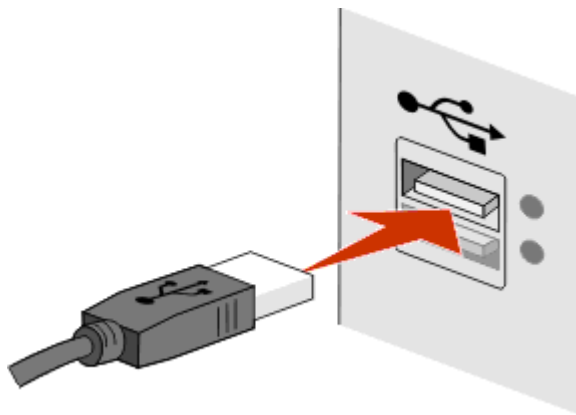

- 2 Attach the small, square connector to the printer.

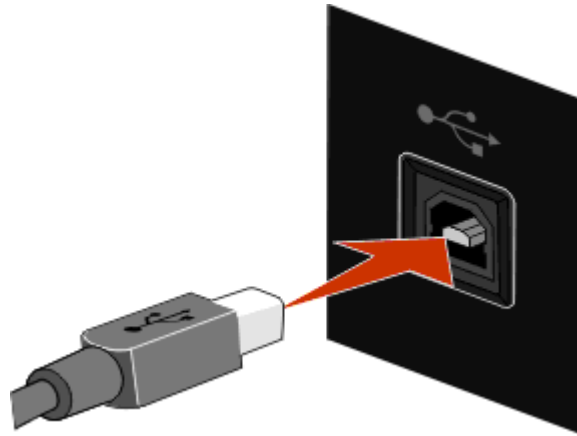

Cannot print over wireless network

If you encountered problems while installing, or if your printer does not appear in the printers folder or as a printer option when sending a print job, you can try uninstalling and reinstalling the software.

These are possible solutions. Try one or more of the following:

MAKE SURE YOUR COMPUTER IS CONNECTED TO YOUR WIRELESS ACCESS POINT (WIRELESS ROUTER)

- See if you have access to the Internet by opening your Web browser and accessing any site.
- If there are other computers or resources on your wireless network, check to see if you can access them from your computer.

MOVE THE COMPUTER AND/OR PRINTER CLOSER TO THE WIRELESS ROUTER

Although the possible distance between devices in 802.11b or 802.11g networks is 300 feet, the maximum range for optimal performance is generally 100–150 feet.

MOVE YOUR ACCESS POINT TO MINIMIZE INTERFERENCE

There may be temporary interference from other devices such as microwave ovens or other appliances, cordless phones, baby monitors, and security system cameras. Make sure your access point is not positioned too closely to these devices.

CHECK WHETHER THE PRINTER IS ON THE SAME WIRELESS NETWORK AS THE COMPUTER

Print a network setup page. Refer to the documentation that came with your printer for details on printing a network setup page.

Make sure the SSID the printer is using matches the wireless network SSID. If you are not sure how to find the network SSID, use one of the following:

Using Windows

- 1 Type the IP address of the wireless access point (wireless router) in the Web address field of your browser.

If you do not know the IP address of the wireless access point:

a Do one of the following:

In Windows Vista

- 1 Click .
- 2 Click **All Programs → Accessories**.
- 3 Click **Command Prompt**.

In Windows XP and earlier

- 1 Click **Start**.
- 2 Click **All Programs** or **Programs → Accessories → Command Prompt**.

b Type `ipconfig`.

c Press **Enter**.

- The “Default Gateway” entry is typically the wireless access point.
- The IP address appears as four sets of numbers separated by periods, such as 192.168.0.100. Your IP address might also start with the numbers 10 or 169. This is determined by your operating system or wireless network software.

2 Type your user name and password for the wireless access point (wireless router) when prompted.

3 Click **OK**.

4 On the main page, click **Wireless** or another selection where settings are stored. The SSID appears.

5 Write down the SSID, security type, and the WEP key/WPA passphrase (if shown).

Note: Make sure you copy the network information down exactly, including any capital letters.

6 Store the SSID and the WEP key or WPA passphrase in a safe place for future reference.

Using Macintosh with an AirPort base station

In Mac OS X version 10.5

1 From the menu bar, click  → **System Preferences**.

2 Click **Network**.

3 Click **AirPort**.

The SSID of the network the computer is connected to is displayed in the Network Name pop-up menu.

4 Write down the SSID.

In Mac OS X version 10.4 and earlier

1 From the menu bar, click **Go → Applications**.

2 From the Applications folder, double-click **Internet Connect**.

3 From the toolbar, click **AirPort**.

The SSID of the network the computer is connected to is displayed in the Network pop-up menu.

4 Write down the SSID.

Using Macintosh with a wireless access point (wireless router)

- 1 Type the IP address of the wireless access point (wireless router) in the Web address field of your browser and continue to Step 2.

If you do not know the IP address of the wireless access point (wireless router), then do the following:

In Mac OS X version 10.5

- a From the menu bar, click  → **System Preferences**.
- b Click **Network**.
- c Click **AirPort**.
- d Click **Advanced**.
- e Click **TCP/IP**.

The "Router" entry is typically the wireless access point (wireless router).

In Mac OS X version 10.4 and earlier

- a From the menu bar, click  → **System Preferences**.
- b Click **Network**.
- c From the Show pop-up menu, select **Airport**.
- d Click **TCP/IP**.

The "Router" entry is typically the wireless access point (wireless router).

- 2 Type your user name and password when prompted.
- 3 Click **OK**.
- 4 On the main page, click **Wireless** or another selection where settings are stored. The SSID will be displayed.
- 5 Write down the SSID, security type and the WEP key/WPA passphrase (if shown).

Notes:

- Make sure you copy the network information down exactly, including any capital letters.
- Store the SSID and the WEP key or WPA passphrase in a safe place for future reference.

CHECK YOUR WEP KEY OR WPA PASSPHRASE

WEP key

Must meet one of the following criteria:

- Exactly 10 or 26 hexadecimal characters. Hexadecimal characters are A-F, a-f, and 0-9.
or
- Exactly 5 or 13 ASCII characters. ASCII characters are letters, numbers, and symbols found on a keyboard. ASCII characters in a WEP key are case-sensitive.

WPA or WPA2 passphrase

Must meet one of the following criteria:

- From 8 to 63 ASCII characters. ASCII characters in a WPA passphrase are case-sensitive.
or
- Exactly 64 hexadecimal characters. Hexadecimal characters are A-F, a-f, and 0-9.

Note: If you do not know this information, see the documentation that came with the wireless network, or contact the person who set up your wireless network.

CHECK YOUR ADVANCED SECURITY SETTINGS

- If you are using MAC address filtering to limit access to your wireless network, you must add the printer MAC address to the list of addresses allowed to connect to the wireless access point (wireless router).
- If you set the wireless access point (wireless router) to issue a limited number of IP addresses, you must change this so that the printer can be added.

Note: If you do not know how to make these changes, see the documentation that came with the wireless network, or contact the person who set up your wireless network.

Cannot print and there is a firewall on the computer

Third-party (non-Microsoft) firewalls can interfere with wireless printing. If the printer and computer are configured correctly, and the wireless network is working, but the printer will not print wirelessly, a firewall could be the problem. If there is a firewall (other than the Windows firewall) on the computer, try one or more of the following:

- Update the firewall using the most recent update available from the manufacturer. Refer to the documentation that came with your firewall for instructions on how to do this.
- If programs request firewall access when you install the printer or try to print, make sure you allow those programs to run.
- Temporarily disable the firewall and install the wireless printer on the computer. Re-enable the firewall when you have completed the wireless installation.

Wi-Fi indicator light is not lit

CHECK POWER

Make sure the  light is on.

Wi-Fi indicator light is green but the printer does not print (Windows only)

If you have completed the configuration for wireless printing and all of the settings appear to be correct, but the printer does not print, try one or more of the following:

ALLOW THE WIRELESS INSTALLATION TO COMPLETE

Do not attempt to print, remove the installation CD, or detach the installation cable until you see the Wireless Setup Successful screen.

ENABLE THE PRINTER

Confirm that the printer is enabled.

- 1 Do one of the following:

In Windows Vista

- a Click .
- b Click **Control Panel**.
- c Under Hardware and Sound, click **Printer**.

In Windows XP

- a Click **Start**.
- b Click **Printers and Faxes**.

In Windows 2000

- a Click **Start**.
- b Click **Settings → Printers**.

- 2 Right-click the new printer. If you see **Use Printer Online** in the menu, select it.
- 3 Close the Printers or Printers and Faxes window and try printing again.

SELECT THE WIRELESS PRINTER

If you have previously set up your printer as a locally attached printer, you may need to select the wireless printer to use the printer wirelessly.

- 1 Do one of the following:

In Windows Vista

- a Click .
- b Click **Control Panel**.
- c Under Hardware and Sound, click **Printer**.

In Windows XP

- a Click **Start**.
- b Click **Printers and Faxes**.

In Windows 2000

- a Click **Start**.
- b Click **Settings → Printers**.

- 2 Check to see if you have a printer called Copy 1 in your folder. If you do, right-click the Copy 1 printer and click **Use Printer Online** from the menu.
- 3 Close the Printers or Printers and Faxes window and try printing again.

SELECT THE WIRELESS PORT

If you have previously set up your printer as a locally attached printer, you may need to select the wireless printer to use the printer wirelessly.

1 Do one of the following:

In Windows Vista

- a** Click .
- b** Click **Control Panel**.
- c** Under Hardware and Sound, click **Printer**.

In Windows XP

- a** Click **Start**.
- b** Click **Printers and Faxes**.

In Windows 2000

- a** Click **Start**.
- b** Click **Settings → Printers**.

2 Right-click the printer, and then select **Properties** from the menu.

3 Click the **Ports** tab.

4 Locate the selected port. The selected port has a check in the Port column.

5 If the Description column of the selected port indicates that it is a USB port, scroll through the list and select the port with Printer Port in the Description column.

6 Click **OK**, and then try to print again.

Wi-Fi indicator light is blinking orange during installation (Windows only)

When the Wi-Fi indicator light is blinking orange, it indicates that the printer has been set up for wireless networking but cannot connect to the network for which it has been configured. The printer may be unable to join the network because of interference, its distance from the wireless access point (wireless router), or until its settings are changed.

These are possible solutions. Try one or more of the following:

MAKE SURE THE ACCESS POINT IS ON

Check the access point and, if necessary, turn it on.

MOVE YOUR ACCESS POINT TO MINIMIZE INTERFERENCE

There may be temporary interference from other devices such as microwave ovens or other appliances, cordless phones, baby monitors, and security system cameras. Make sure your access point is not positioned too closely to these devices.

TRY ADJUSTING EXTERNAL ANTENNAS

Antennas usually work best if they are pointing straight up. You may find that reception improves if you experiment with different angles for the printer and/or wireless access point antennas.

MOVE YOUR PRINTER

Move the printer closer to the access point. Although the possible distance between devices in 802.11b or 802.11g networks is 300 feet, the maximum range for optimal performance is generally 100–150 feet.

You can find the signal strength of the network on the network setup page.

CHECK SECURITY KEYS

If you are using WEP security

A valid WEP key is:

- Exactly 10 or 26 hexadecimal characters. Hexadecimal characters are A–F, a–f, and 0–9.
or
- Exactly 5 or 13 ASCII characters. ASCII characters are letters, numbers, and symbols found on a keyboard.

If you are using WPA security

A valid WPA passphrase is:

- From 8 to 63 ASCII characters. ASCII characters in a WPA passphrase are case-sensitive.
or
- Exactly 64 hexadecimal characters. Hexadecimal characters are A–F, a–f, and 0–9.

If your wireless network is not using security, then you will not have a security key. Using a wireless network with no security is not recommended because it can allow intruders to use your network resources without your consent.

CHECK MAC ADDRESS

If your network uses MAC address filtering, make sure that you include the MAC address of the printer in the MAC address filter list. This will allow the printer to operate on the network. For more information, see “How do I find the MAC address?” on page 51.

PING THE ACCESS POINT TO MAKE SURE THE NETWORK IS WORKING

- 1 If you do not already know it, find the IP address of the access point.
 - a Do one of the following:

In Windows Vista

- 1 Click .
- 2 Click **All Programs → Accessories**.
- 3 Click **Command Prompt**.

In Windows XP and earlier

- 1 Click **Start**.
- 2 Click **All Programs** or **Programs → Accessories → Command Prompt**.

b Type `ipconfig`.

c Press **Enter**.

- The “Default Gateway” entry is typically the access point.
- The IP address appears as four sets of numbers separated by periods, such as 192.168.0.100. Your IP address might also start with the numbers 10 or 169. This is determined by your operating system or wireless network software.

2 Ping the access point.

a Do one of the following:

In Windows Vista

- 1** Click .
- 2** Click **All Programs → Accessories**.
- 3** Click **Command Prompt**.

In Windows XP and earlier

- 1** Click **Start**.
- 2** Click **All Programs** or **Programs → Accessories → Command Prompt**.

b Type `ping` followed by a space and the IP address of the wireless access point. For example:

```
ping 192.168.0.100
```

c Press **Enter**.

3 Check to see whether the access point responds:

- If the access point responds, you will see several lines appear that start with “Reply from.” It is possible that the printer did not connect to the wireless network. Turn off and then restart the printer to try to connect again.
- If the access point does not respond, it will take several seconds and then you will see “Request timed out.”

Try the following:

a Do one of the following:

In Windows Vista

- 1** Click .
- 2** Click **Control Panel**.
- 3** Click **Network and Internet**.
- 4** Click **Network and Sharing Center**.

In Windows XP and earlier

- 1** Click **Start**.
- 2** Click **Control Panel**.
- 3** Click **Network Connection**.

b Select the appropriate connection from the ones shown.

Note: If the computer is connected to the access point by an Ethernet cable, the connection may not include the word “wireless” in its name.

c Right-click the connection, and then click **Repair**.

RUN THE WIRELESS SETUP AGAIN

If your wireless settings have changed, you must run the printer wireless setup again. Some reasons your settings may have changed include your having manually changed your WEP or WPA keys, channel, or other network settings; or the access point having been reset to factory defaults.

Running the wireless setup again can also resolve issues due to misconfigurations that occurred when configuring the printer for wireless access.

Notes:

- If you change network settings, change them on all the network devices before changing them for the access point.
- If you have already changed the wireless network settings on your access point, then you must change the settings on all the other network devices before you can see them on the network.

1 Do one of the following:

- In Windows Vista, click .
- In Windows XP and earlier, click **Start**.

2 Click **All Programs** or **Programs**, and then select the printer program folder from the list.

3 Click **Tools** → **Lexmark Wireless Setup Utility**.

Note: You may be prompted to connect the printer to the computer again using the installation cable as part of the setup process.

4 Follow the instructions on the computer screen.

Wi-Fi indicator light is blinking orange during installation (Macintosh only)

When the Wi-Fi indicator light is blinking orange, it indicates that the printer has been set up for wireless networking but cannot connect to the network for which it has been configured. The printer may be unable to join the network because of interference, its distance from the wireless access point (wireless router), or until its settings are changed.

These are possible solutions. Try one or more of the following:

MAKE SURE THE WIRELESS ACCESS POINT IS ON

Check the wireless access point and, if necessary, turn it on.

MOVE YOUR WIRELESS ACCESS POINT TO MINIMIZE INTERFERENCE

There may be temporary interference from other devices such as microwave ovens or other appliances, cordless phones, baby monitors, and security system cameras. Make sure the wireless access point is not positioned too closely to these devices.

TRY ADJUSTING EXTERNAL ANTENNAS

Antennas usually work best if they are pointing straight up. You may find that reception improves if you experiment with different angles for the printer and/or wireless access point antennas.

MOVE YOUR PRINTER

Move the printer closer to the wireless access point. Although the possible distance between devices in 802.11b or 802.11g networks is 300 feet, the effective range for optimal performance is generally 100–150 feet.

You can find the signal strength of the network on the network setup page.

CHECK SECURITY KEYS

If you are using WEP security

A valid WEP key is:

- Exactly 10 or 26 hexadecimal characters. Hexadecimal characters are A–F, a–f, and 0–9.
or
- Exactly 5 or 13 ASCII characters. ASCII characters are letters, numbers, and symbols found on a keyboard.

If you are using WPA security

A valid WPA passphrase is:

- From 8 to 63 ASCII characters. ASCII characters in a WPA passphrase are case-sensitive.
or
- Exactly 64 hexadecimal characters. Hexadecimal characters are A–F, a–f, and 0–9.

If your wireless network is not using security, then you will not have a WEP key or WPA passphrase. Using a wireless network with no security is not recommended because it can allow intruders to use your network resources without your consent.

CHECK THE MAC ADDRESS

If your network uses MAC address filtering, make sure that you include the MAC address of the printer in the MAC address filter list. This will allow the printer to operate on the network.

PING THE ACCESS POINT TO MAKE SURE THE NETWORK IS WORKING

- 1 Check the AirPort status and, if you do not already know it, find the IP address of the wireless access point.

In Mac OS X version 10.5

a From the menu bar, click  → **System Preferences**.

b Click **Network**.

c Click **AirPort**.

Check Status. It should be on. If it is off, click **Turn AirPort On**.

The AirPort status indicator should also be green. Green means the port is active (turned on) and connected.

Notes:

- Yellow means the port is active but is not connected.
- Red means the port has not been configured.

d Click **Advanced**.

- e Click **TCP/IP**.
 - The IP address appears as four sets of numbers separated by periods, such as 192.168.0.100.
 - The "Router" entry is typically the wireless access point.

In Mac OS X version 10.4 and earlier

- a Click  → **System Preferences**.
- b Click **Network**.
- c If necessary, select **Network Status** in the Show pop-up menu.
The AirPort status indicator should be green. Green means the port is active (turned on) and connected.

Notes:

- Yellow means the port is active but is not connected.
- Red means the port has not been configured.

- d From the Show pop-up menu, select **AirPort**.
- e Click **TCP/IP**.
 - The IP address appears as four sets of numbers separated by periods, such as 192.168.0.100.
 - The "Router" entry is typically the wireless access point.

2 Ping the wireless access point.

- a From the menu bar, click **Go → Utilities**.
- b Double-click **Network Utility**.
- c Click the **Ping** tab.
- d Type the IP address of the wireless access point in the network address field. For example:
`10 . 168 . 0 . 100`
- e Click **Ping**.

3 If the wireless access point responds, you will see several lines that display the number of bytes received from the access point. This ensures that your computer is connected to the access point.

If the wireless access point does not respond, nothing is displayed. You can use Network Diagnostics to help resolve the problem.

RUN THE WIRELESS SETUP AGAIN

- 1 From the Finder desktop, double-click the printer folder.
- 2 Double-click **Lexmark Wireless Setup Assistant**.
- 3 Follow the instructions on the computer screen.

Wi-Fi indicator light is still orange

When the Wi-Fi indicator light is orange, it may indicate that the printer is:

- Being configured for use on the wireless network
- Not configured in infrastructure mode
- Waiting to be configured for ad hoc mode

The printer may be unable to join the network because of interference, its distance from the wireless access point (wireless router), or until its settings are changed.

These are possible solutions. Try one or more of the following:

CHECK NETWORK NAME

Make sure your network does not have the same name as another network near you. For example, if you and your neighbor both use a manufacturer's default network name, your printer could be connecting to your neighbor's network.

If you are not using a unique network name, consult the documentation for your wireless access point (wireless router) to learn how to set a network name.

If you set a new network name, you must reset the printer and computer SSID to the same network name.

CHECK SECURITY KEYS

If you are using WEP security

A valid WEP key is:

- Exactly 10 or 26 hexadecimal characters. Hexadecimal characters are A–F, a–f, and 0–9.
or
- Exactly 5 or 13 ASCII characters. ASCII characters are letters, numbers, and symbols found on a keyboard.

If you are using WPA security

A valid WPA passphrase is:

- From 8 to 63 ASCII characters. ASCII characters in a WPA passphrase are case-sensitive.
or
- Exactly 64 hexadecimal characters. Hexadecimal characters are A–F, a–f, and 0–9.

If your wireless network is not using security, then you will not have a security key. Using a wireless network with no security is not recommended because it can allow intruders to use your network resources without your consent.

MOVE YOUR PRINTER

Move the printer closer to the wireless access point (wireless router). Although the possible distance between devices in 802.11b or 802.11g networks is 300 feet, the maximum range for optimal performance is generally 100-150 feet.

You can find the strength of the network signal on the printer network setup page.

CHECK MAC ADDRESS

If your network uses MAC address filtering, make sure that you include the MAC address of the printer in the MAC address filter list. This will allow the printer to operate on the network. For more information, see "How do I find the MAC address?" on page 51.

Wireless print server not installed

You may see a message during installation indicating that the printer does not have a wireless print server installed. If you are sure the printer is capable of wireless printing, try the following:

CHECK POWER

Make sure the  light is on.

“Communication not available” message displays when printing wirelessly

If you are using a laptop and have power saving settings enabled, you may see the **Communication not available** message on your computer screen when you attempt to print wirelessly. This can occur if the laptop hard drive has powered down.

If you see this message, wait a few seconds and then try to print again. The laptop and printer require a few seconds to power up again and reattach to the wireless network.

If you see this message again after you have waited long enough for the printer and the laptop to attach to the network, there may be a problem with your wireless network. Make sure that the laptop and printer have both received IP addresses. For more information on locating IP addresses, refer to “How do I locate IP addresses?” on page 52.

If the printer and/or the laptop does not have an IP address, or if either has an address of 169.254.x.y (where x and y are any two numbers between 0 and 255):



- 1 Shut down the device that does not have a valid IP address (the laptop, the printer, or both).
- 2 Turn on the device(s).
- 3 Check the IP addresses again.

If the laptop and/or printer still does not receive a valid IP address, there is a problem with your wireless network. Make sure your wireless access point (wireless router) is working, and remove any obstacles that could be blocking the wireless signal.

Communication with printer lost when connected to Virtual Private Network (VPN)

You will lose your connection to a wireless printer on your local network when connected to most *Virtual Private Networks* (VPNs). Most VPNs allow users to communicate with only the VPN and no other network at the same time. If you would like to have the ability to connect to your local network and to a VPN at the same time, the system support person for the VPN must enable split tunneling. Be aware that some organizations will not allow split tunneling due to security or technical concerns.

Resetting the internal wireless print server to factory default settings

- 1 From the printer control panel, press .
- 2 Press the arrow buttons until **Network Setup** appears, and then press .

3 Press the arrow buttons until **Reset Network Adapter Defaults** appears, and then press **OK**.

4 Press the arrow buttons until **Yes** appears, and then press **OK**.

The internal wireless print server is reset to factory default settings. To verify, print a network setup page.

Notices

Product information

Product name:

Lexmark 3600 Series

Machine type:

4438

Model(s):

001, 002

Product name:

Lexmark 4600 Series

Machine type:

4438

Model number 2:

W02, W03, WE2, WE3

Edition notice

March 2008

The following paragraph does not apply to any country where such provisions are inconsistent with local law: LEXMARK INTERNATIONAL, INC., PROVIDES THIS PUBLICATION "AS IS" WITHOUT WARRANTY OF ANY KIND, EITHER EXPRESS OR IMPLIED, INCLUDING, BUT NOT LIMITED TO, THE IMPLIED WARRANTIES OF MERCHANTABILITY OR FITNESS FOR A PARTICULAR PURPOSE. Some states do not allow disclaimer of express or implied warranties in certain transactions; therefore, this statement may not apply to you.

This publication could include technical inaccuracies or typographical errors. Changes are periodically made to the information herein; these changes will be incorporated in later editions. Improvements or changes in the products or the programs described may be made at any time.

References in this publication to products, programs, or services do not imply that the manufacturer intends to make these available in all countries in which it operates. Any reference to a product, program, or service is not intended to state or imply that only that product, program, or service may be used. Any functionally equivalent product, program, or service that does not infringe any existing intellectual property right may be used instead. Evaluation and verification of operation in conjunction with other products, programs, or services, except those expressly designated by the manufacturer, are the user's responsibility.

For Lexmark technical support, visit support.lexmark.com.

For information on supplies and downloads, visit www.lexmark.com.

If you don't have access to the Internet, you can contact Lexmark by mail:

Lexmark International, Inc.
Bldg 004-2/CSC
740 New Circle Road NW
Lexington, KY 40550
USA

© 2008 Lexmark International, Inc.

All rights reserved.

UNITED STATES GOVERNMENT RIGHTS

This software and any accompanying documentation provided under this agreement are commercial computer software and documentation developed exclusively at private expense.

Trademarks

Lexmark and Lexmark with diamond design are trademarks of Lexmark International, Inc., registered in the United States and/or other countries.

evercolor and PerfectFinish are trademarks of Lexmark International, Inc.

All other trademarks are the property of their respective owners.

Licensing notices

The following document can be viewed from the \Drivers\XPS directory on the installation software CD: Zopen.PDF.

Federal Communications Commission (FCC) compliance information statement

This product has been tested and found to comply with the limits for a Class B digital device, pursuant to Part 15 of the FCC Rules. Operation is subject to the following two conditions: (1) this device may not cause harmful interference, and (2) this device must accept any interference received, including interference that may cause undesired operation.

The FCC Class B limits are designed to provide reasonable protection against harmful interference when the equipment is operated in a residential installation. This equipment generates, uses, and can radiate radio frequency energy and, if not installed and used in accordance with the instructions, may cause harmful interference to radio communications. However, there is no guarantee that interference will not occur in a particular installation. If this equipment does cause harmful interference to radio or television reception, which can be determined by turning the equipment off and on, the user is encouraged to try to correct the interference by one or more of the following measures:

- Reorient or relocate the receiving antenna.
- Increase the separation between the equipment and receiver.
- Connect the equipment into an outlet on a circuit different from that to which the receiver is connected.
- Consult your point of purchase or service representative for additional suggestions.

The manufacturer is not responsible for radio or television interference caused by using other than recommended cables or by unauthorized changes or modifications to this equipment. Unauthorized changes or modifications could void the user's authority to operate this equipment.

Note: To assure compliance with FCC regulations on electromagnetic interference for a Class B computing device, use a properly shielded and grounded cable such as Lexmark part number 1021294 for USB attach. Use of a substitute cable not properly shielded and grounded may result in a violation of FCC regulations.

Any questions regarding this compliance information statement should be directed to:

Director of Lexmark Technology & Services
Lexmark International, Inc.
740 West New Circle Road
Lexington, KY 40550
(859) 232-3000

Exposure to radio frequency radiation

The following notice is applicable if your printer has a wireless network card installed.

The radiated output power of this device is far below the radio frequency exposure limits of the FCC and other regulatory agencies. A minimum separation of 20 cm (8 inches) must be maintained between the antenna and any persons for this device to satisfy the RF exposure requirements of the FCC and other regulatory agencies.

Industry Canada compliance statement

This Class B digital apparatus meets all requirements of the Canadian Interference-Causing Equipment Standard ICES-003.

Avis de conformité aux normes de l'industrie du Canada

Cet appareil numérique de classe B est conforme aux exigences de la norme canadienne relative aux équipements pouvant causer des interférences NMB-003.

Industry Canada notice

The following notices are applicable if your printer has a wireless network card installed.

Industry Canada (Canada)

This device complies with Industry Canada specification RSS-210. Operation is subject to the following two conditions: (1) this device may not cause interference, and (2) this device must accept any interference, including interference that may cause undesired operation of the device.

This device has been designed to operate only with the antenna provided. Use of any other antenna is strictly prohibited per regulations of Industry Canada.

To prevent radio interference to the licensed service, this device is intended to be operated indoors and away from windows to provide maximum shielding. Equipment (or its transmit antenna) that is installed outdoors is subject to licensing.

The installer of this radio equipment must ensure that the antenna is located or pointed such that it does not emit RF fields in excess of Health Canada limits for the general population; consult Safety Code 6, obtainable from Health Canada's Web site www.hc-sc.gc.ca/rpb.

The term "IC:" before the certification/registration number only signifies that the Industry Canada technical specifications were met.

Industry Canada (Canada)

Cet appareil est conforme à la norme RSS-210 d'Industry Canada. Son fonctionnement est soumis aux deux conditions suivantes :

(1) cet appareil ne doit pas provoquer d'interférences et (2) il doit accepter toute interférence reçue, y compris celles risquant d'altérer son fonctionnement.

Cet appareil a été conçu pour fonctionner uniquement avec l'antenne fournie. L'utilisation de toute autre antenne est strictement interdite par la réglementation d'Industry Canada.

En application des réglementations d'Industry Canada, l'utilisation d'une antenne de gain supérieur est strictement interdite.

Pour empêcher toute interférence radio au service faisant l'objet d'une licence, cet appareil doit être utilisé à l'intérieur et loin des fenêtres afin de garantir une protection optimale.

Si le matériel (ou son antenne d'émission) est installé à l'extérieur, il doit faire l'objet d'une licence.

L'installateur de cet équipement radio doit veiller à ce que l'antenne soit implantée et dirigée de manière à n'émettre aucun champ HF dépassant les limites fixées pour l'ensemble de la population par Santé Canada. Reportez-vous au Code de sécurité 6 que vous pouvez consulter sur le site Web de Santé Canada www.hc-sc.gc.ca/rpb.

Le terme « IC » précédant le numéro de d'accréditation/inscription signifie simplement que le produit est conforme aux spécifications techniques d'Industry Canada.

European Community (EC) directives conformity

This product is in conformity with the protection requirements of EC Council directives 2004/108/EC and 2006/95/EC on the approximation and harmonization of the laws of the Member States relating to electromagnetic compatibility and safety of electrical equipment designed for use within certain voltage limits.

A declaration of conformity with the requirements of the directives has been signed by the Director of Manufacturing and Technical Support, Lexmark International, Inc., S.A., Boigny, France.

This product satisfies the Class B limits of EN 55022 and safety requirements of EN 60950.

European EC directives conformity statement for radio products

The following notices are applicable if your printer has a wireless network card installed

This product is in conformity with the protection requirements of EC Council directives 2004/108/EC, 2006/95/EC, and 1999/5/EC on the approximation and harmonization of the laws of the Member States relating to electromagnetic compatibility, safety of electrical equipment designed for use within certain voltage limits and on radio equipment and telecommunications terminal equipment.

Compliance is indicated by the CE marking.



The Alert sign indicates that there are restrictions within certain member states.

A declaration of conformity with the requirements of the directives is available from the Director of Manufacturing and Technical Support, Lexmark International, S. A., Boigny, France.

The following restrictions apply:

Country/region	Restriction
All countries/regions	This product is for indoor use only. This product may not be used outdoors.
L'Italia	Si fa presente inoltre che l'uso degli apparati in esame è regolamentato da: <ul style="list-style-type: none"> • D.Lgs 1.8.2003, n.259, articoli 104 (attività soggette ad autorizzazione generale) e 105 (libero uso), per uso privato; • D.M. 28.5.03, per la fornitura al pubblico dell'accesso R-LAN alle reti e ai servizi di telecomunicazioni.

This product satisfies the limits of EN 55022; safety requirements of EN 60950; radio spectrum requirements of ETSI EN 300 328; and the EMC requirements of EN 55024, ETSI EN 301 489-1 and ETSI EN 301 489-17.

Česky	Společnost Lexmark International, Inc. tímto prohlašuje, že výrobek tento výrobek je ve shodě se základními požadavky a dalšími příslušnými ustanoveními směrnice 1999/5/ES.
Dansk	Lexmark International, Inc. erklærer herved, at dette produkt overholder de væsentlige krav og øvrige relevante krav i direktiv 1999/5/EF.
Deutsch	Hiermit erklärt Lexmark International, Inc., dass sich das Gerät dieses Gerät in Übereinstimmung mit den grundlegenden Anforderungen und den übrigen einschlägigen Bestimmungen der Richtlinie 1999/5/EG befindet.
Ελληνική	ΜΕ ΤΗΝ ΠΑΡΟΥΣΑ Η LEXMARK INTERNATIONAL, INC. ΔΗΛΩΝΕΙ ΟΤΙ ΑΥΤΟ ΤΟ ΠΡΟΪΟΝ ΣΥΜΜΟΡΦΩΝΕΤΑΙ ΠΡΟΣ ΤΙΣ ΟΥΣΙΩΔΕΙΣ ΑΠΑΙΤΗΣΕΙΣ ΚΑΙ ΤΙΣ ΛΟΙΠΕΣ ΣΧΕΤΙΚΕΣ ΔΙΑΤΑΞΕΙΣ ΤΗΣ ΟΔΗΓΙΑΣ 1999/5/ΕΚ.
English	Hereby, Lexmark International, Inc., declares that this type of equipment is in compliance with the essential requirements and other relevant provisions of Directive 1999/5/EC.
Español	Por medio de la presente, Lexmark International, Inc. declara que este producto cumple con los requisitos esenciales y cualesquiera otras disposiciones aplicables o exigibles de la Directiva 1999/5/CE.
Eesti	Käesolevaga kinnitab Lexmark International, Inc., et seade see toode vastab direktiivi 1999/5/EÜ põhinõuetele ja nimetatud direktiivist tulenevatele muudele asjakohastele sätetele.
Suomi	Lexmark International, Inc. vakuuttaa täten, että tämä tuote on direktiivin 1999/5/EY oleellisten vaatimusten ja muiden sitä koskevien direktiivin ehtojen mukainen.
Français	Par la présente, Lexmark International, Inc. déclare que l'appareil ce produit est conforme aux exigences fondamentales et autres dispositions pertinentes de la directive 1999/5/CE.
Magyar	Alulírott, Lexmark International, Inc. nyilatkozom, hogy a termék megfelel a vonatkozó alapvető követelményeknek és az 1999/5/EC irányelv egyéb előírásainak.
Íslenska	Hér með lýsir Lexmark International, Inc. yfir því að þessi vara er í samræmi við grunnkröfur og aðrar kröfur, sem gerðar eru í tilskipun 1999/5/EC.
Italiano	Con la presente Lexmark International, Inc. dichiara che questo questo prodotto è conforme ai requisiti essenziali ed alle altre disposizioni pertinenti stabilite dalla direttiva 1999/5/CE.
Latviski	Ar šo Lexmark International, Inc. deklarē, ka šis izstrādājums atbilst Direktīvas 1999/5/EK būtiskajām prasībām un citiem ar to saistītajiem noteikumiem.

Lietuvių	Šiuo Lexmark International, Inc. deklaruoja, kad šis produktas atitinka esminius reikalavimus ir kitas 1999/5/EB direktyvos nuostatas.
Malti	Bil-preżenti, Lexmark International, Inc., jiddikjara li dan il-prodott huwa konformi mal-ħtiġijiet essenzjali u ma dispożizzjonijiet oħrajn relevanti li jinsabu fid-Direttiva 1999/5/KE.
Nederlands	Hierbij verklaart Lexmark International, Inc. dat het toestel dit product in overeenstemming is met de essentiële eisen en de andere relevante bepalingen van richtlijn 1999/5/EG.
Norsk	Lexmark International, Inc. erklærer herved at dette produktet er i samsvar med de grunnleggende krav og øvrige relevante krav i direktiv 1999/5/EF.
Polski	Niniejszym Lexmark International, Inc. oświadcza, że niniejszy produkt jest zgodny z zasadniczymi wymogami oraz pozostałymi stosownymi postanowieniami Dyrektywy 1999/5/EC.
Português	A Lexmark International Inc. declara que este produto está conforme com os requisitos essenciais e outras disposições da Diretiva 1999/5/CE.
Slovensky	Lexmark International, Inc. týmto vyhlasuje, že tento produkt spĺňa základné požiadavky a všetky príslušné ustanovenia smernice 1999/5/ES.
Slovensko	Lexmark International, Inc. izjavlja, da je ta izdelek v skladu z bistvenimi zahtevami in ostalimi relevantnimi določili direktive 1999/5/ES.
Svenska	Härmed intygar Lexmark International, Inc. att denna produkt står i överensstämmelse med de väsentliga egenskapskrav och övriga relevanta bestämmelser som framgår av direktiv 1999/5/EG.

Noise emission levels

The following measurements were made in accordance with ISO 7779 and reported in conformance with ISO 9296.

Note: Some modes may not apply to your product.

1-meter average sound pressure, dBA	
Printing	50
Scanning	40
Copying	50
Ready	inaudible

Values are subject to change. See www.lexmark.com for current values.

Waste from Electrical and Electronic Equipment (WEEE) directive



The WEEE logo signifies specific recycling programs and procedures for electronic products in countries of the European Union. We encourage the recycling of our products. If you have further questions about recycling options, visit the Lexmark Web site at www.lexmark.com for your local sales office phone number.

Product disposal

Do not dispose of the printer or supplies in the same manner as normal household waste. Consult your local authorities for disposal and recycling options.

Temperature information

Ambient temperature	15–32° C (60–90° F)
Shipping temperature	-40–60° C (-40–140° F)
Storage temperature	1–60° C (34–140° F)

ENERGY STAR



Power consumption

Product power consumption

The following table documents the power consumption characteristics of the product.

Note: Some modes may not apply to your product.

Mode	Description	Power consumption (Watts)
Printing	The product is generating hard-copy output from electronic inputs.	Lexmark 3600 Series: 22.1; Lexmark 4600 Series: 24.3
Copying	The product is generating hard-copy output from hard-copy original documents.	Lexmark 3600 Series: 22.5; Lexmark 4600 Series: 29.2
Scanning	The product is scanning hard-copy documents.	Lexmark 3600 Series: 10.7; Lexmark 4600 Series: 12.5
Ready	The product is waiting for a print job.	Lexmark 3600 Series: 9.0; Lexmark 4600 Series: 12.0
Power Saver	The product is in energy-saving mode.	Lexmark 3600 Series: 4.8; Lexmark 4600 Series: 6.5
Off	The product is plugged into a wall outlet, but the power switch is turned off.	0.2

The power consumption levels listed in the previous table represent time-averaged measurements. Instantaneous power draws may be substantially higher than the average.

Values are subject to change. See www.lexmark.com for current values.

Power Saver

This product is designed with an energy-saving mode called Power Saver. The Power Saver Mode is equivalent to the EPA Sleep Mode. The Power Saver Mode saves energy by lowering power consumption during extended periods of inactivity. The Power Saver Mode is automatically engaged after this product is not used for a specified period of time, called the Power Saver Timeout.

Factory default Power Saver Timeout for this product (in minutes):	60
--	----

Off mode

If this product has an off mode which still consumes a small amount of power, then to completely stop product power consumption, disconnect the power supply cord from the wall outlet.

Total energy usage

It is sometimes helpful to calculate the total product energy usage. Since power consumption claims are provided in power units of Watts, the power consumption should be multiplied by the time the product spends in each mode in order to calculate energy usage. The total product energy usage is the sum of each mode's energy usage.

LEXMARK LICENSE AGREEMENTS

PLEASE READ CAREFULLY: BY USING THIS PRODUCT, YOU AGREE TO BE BOUND BY ALL THE TERMS AND CONDITIONS OF THESE LICENSE AGREEMENTS. IF YOU DO NOT AGREE WITH THE TERMS OF THESE LICENSE AGREEMENTS, PROMPTLY RETURN THE PRODUCT UNUSED AND REQUEST A REFUND OF THE AMOUNT YOU PAID. IF YOU ARE INSTALLING THIS PRODUCT FOR USE BY OTHER PARTIES, YOU AGREE TO INFORM THE USERS THAT USE OF THE PRODUCT INDICATES ACCEPTANCE OF THESE TERMS.

CARTRIDGE LICENSE AGREEMENT

I agree that the patented print cartridge(s) shipped with this printing device are sold subject to the following license/agreement: The patented print cartridge(s) contained inside is/are licensed for a single use only and is/are designed to stop working after delivering a fixed amount of ink. A variable amount of ink will remain in the cartridge when replacement is required. After this single use, the license to use the print cartridge terminates, and the used cartridge must be returned only to Lexmark for remanufacturing, refilling or recycling. If I buy another cartridge in the future that is sold subject to the above terms, I accept such terms as to that cartridge. If you do not accept the terms of this single use license/agreement; return this product in its original packaging to your point of purchase. A replacement cartridge sold without these terms is available at www.lexmark.com.

LEXMARK SOFTWARE LICENSE AGREEMENT

This Software License Agreement ("License Agreement") is a legal agreement between you (either an individual or a single entity) and Lexmark International, Inc. ("Lexmark") that, to the extent your Lexmark product or Software Program is not otherwise subject to a written software license agreement between you and Lexmark or its suppliers, governs your use of any Software Program installed on or provided by Lexmark for use in connection with your Lexmark product. The term "Software Program" includes machine-readable instructions, audio/visual content (such as images and recordings), and associated media, printed materials and electronic documentation, whether incorporated into, distributed with or for use with your Lexmark product.

- 1 STATEMENT OF LIMITED WARRANTY.** Lexmark warrants that the media (e.g., diskette or compact disk) on which the Software Program (if any) is furnished is free from defects in materials and workmanship under normal use during the warranty period. The warranty period is ninety (90) days and commences on the date the Software Program is delivered to the original end-user. This limited warranty applies only to Software Program media purchased new from Lexmark or an Authorized Lexmark Reseller or Distributor. Lexmark will replace the Software Program should it be determined that the media does not conform to this limited warranty.
- 2 DISCLAIMER AND LIMITATION OF WARRANTIES.** EXCEPT AS PROVIDED IN THIS LICENSE AGREEMENT AND TO THE MAXIMUM EXTENT PERMITTED BY APPLICABLE LAW, LEXMARK AND ITS SUPPLIERS PROVIDE THE SOFTWARE PROGRAM "AS IS" AND HEREBY DISCLAIM ALL OTHER WARRANTIES AND CONDITIONS, EITHER EXPRESS OR IMPLIED, INCLUDING, BUT NOT LIMITED TO, TITLE, NON-INFRINGEMENT, MERCHANTABILITY AND FITNESS FOR A PARTICULAR PURPOSE, AND ABSENCE OF VIRUSES, ALL WITH REGARD TO THE SOFTWARE PROGRAM. This Agreement is to be read in conjunction with certain statutory provisions, as that may be in force from time to time, that imply warranties or conditions or impose obligations on Lexmark that cannot be excluded or modified. If any such provisions apply, then to the extent Lexmark is able, Lexmark hereby limits its liability for breach of those provisions to one of the following: replacement of the Software Program or reimbursement of the price paid for the Software Program.
- 3 LICENSE GRANT.** Lexmark grants you the following rights provided you comply with all terms and conditions of this License Agreement:
 - a Use.** You may Use one (1) copy of the Software Program. The term "Use" means storing, loading, installing, executing, or displaying the Software Program. If Lexmark has licensed the Software Program to you for concurrent use, you must limit the number of authorized users to the number specified in your agreement with Lexmark. You may not separate the components of the Software Program for use on more than one computer. You agree that you will not Use the Software Program, in whole or in part, in any manner that has the effect of overriding, modifying, eliminating, obscuring, altering or de-emphasizing the visual appearance of any trademark, trade name, trade dress or intellectual property notice that appears on any computer display screens normally generated by, or as a result of, the Software Program.
 - b Copying.** You may make one (1) copy of the Software Program solely for purposes of backup, archiving, or installation, provided the copy contains all of the original Software Program's proprietary notices. You may not copy the Software Program to any public or distributed network.
 - c Reservation of Rights.** The Software Program, including all fonts, is copyrighted and owned by Lexmark International, Inc. and/or its suppliers. Lexmark reserves all rights not expressly granted to you in this License Agreement.
 - d Freeware.** Notwithstanding the terms and conditions of this License Agreement, all or any portion of the Software Program that constitutes software provided under public license by third parties ("Freeware") is licensed to you subject to the terms and conditions of the software license agreement accompanying such Freeware, whether in the form of a discrete agreement, shrink-wrap license, or electronic license terms at the time of download. Use of the Freeware by you shall be governed entirely by the terms and conditions of such license.

- 4 TRANSFER.** You may transfer the Software Program to another end-user. Any transfer must include all software components, media, printed materials, and this License Agreement and you may not retain copies of the Software Program or components thereof. The transfer may not be an indirect transfer, such as a consignment. Prior to the transfer, the end-user receiving the transferred Software Program must agree to all these License Agreement terms. Upon transfer of the Software Program, your license is automatically terminated. You may not rent, sublicense, or assign the Software Program except to the extent provided in this License Agreement, and any attempt to do so shall be void.
- 5 UPGRADES.** To Use a Software Program identified as an upgrade, you must first be licensed to the original Software Program identified by Lexmark as eligible for the upgrade. After upgrading, you may no longer use the original Software Program that formed the basis for your upgrade eligibility.
- 6 LIMITATION ON REVERSE ENGINEERING.** You may not alter, decrypt, reverse engineer, reverse assemble, reverse compile or otherwise translate the Software Program, except as and to the extent expressly permitted to do so by applicable law for the purposes of inter-operability, error correction, and security testing. If you have such statutory rights, you will notify Lexmark in writing of any intended reverse engineering, reverse assembly, or reverse compilation. You may not decrypt the Software Program unless necessary for the legitimate Use of the Software Program.
- 7 ADDITIONAL SOFTWARE.** This License Agreement applies to updates or supplements to the original Software Program provided by Lexmark unless Lexmark provides other terms along with the update or supplement.
- 8 LIMITATION OF REMEDIES.** To the maximum extent permitted by applicable law, the entire liability of Lexmark, its suppliers, affiliates, and resellers, and your exclusive remedy shall be as follows: Lexmark will provide the express limited warranty described above. If Lexmark does not remedy defective media as warranted, you may terminate your license and your money will be refunded upon the return of all of your copies of the Software Program.
- 9 LIMITATION OF LIABILITY.** To the maximum extent permitted by applicable law, for any claim arising out of Lexmark's limited warranty, or for any other claim whatsoever related to the subject matter of this Agreement, Lexmark's and its suppliers' liability for all types of damages, regardless of the form of action or basis (including contract, breach, estoppel, negligence, misrepresentation, or tort), shall be limited to the greater of \$5,000 or the money paid to Lexmark or its Authorized remarketers for the license hereunder for the Software Program that caused the damages or that is the subject matter of, or is directly related to, the cause of action.
- IN NO EVENT WILL LEXMARK, ITS SUPPLIERS, SUBSIDIARIES, OR RESELLERS BE LIABLE FOR ANY SPECIAL, INCIDENTAL, INDIRECT, EXEMPLARY, PUNITIVE, OR CONSEQUENTIAL DAMAGES (INCLUDING BUT NOT LIMITED TO LOST PROFITS OR REVENUES, LOST SAVINGS, INTERRUPTION OF USE OR ANY LOSS OF, INACCURACY IN, OR DAMAGE TO, DATA OR RECORDS, FOR CLAIMS OF THIRD PARTIES, OR DAMAGE TO REAL OR TANGIBLE PROPERTY, FOR LOSS OF PRIVACY ARISING OUT OR IN ANY WAY RELATED TO THE USE OF OR INABILITY TO USE THE SOFTWARE PROGRAM, OR OTHERWISE IN CONNECTION WITH ANY PROVISION OF THIS LICENSE AGREEMENT), REGARDLESS OF THE NATURE OF THE CLAIM, INCLUDING BUT NOT LIMITED TO BREACH OF WARRANTY OR CONTRACT, TORT (INCLUDING NEGLIGENCE OR STRICT LIABILITY), AND EVEN IF LEXMARK, OR ITS SUPPLIERS, AFFILIATES, OR REMARKETERS HAVE BEEN ADVISED OF THE POSSIBILITY OF SUCH DAMAGES, OR FOR ANY CLAIM BY YOU BASED ON A THIRD-PARTY CLAIM, EXCEPT TO THE EXTENT THIS EXCLUSION OF DAMAGES IS DETERMINED LEGALLY INVALID. THE FOREGOING LIMITATIONS APPLY EVEN IF THE ABOVE-STATED REMEDIES FAIL OF THEIR ESSENTIAL PURPOSE.
- 10 TERM.** This License Agreement is effective unless terminated or rejected. You may reject or terminate this license at any time by destroying all copies of the Software Program, together with all modifications, documentation, and merged portions in any form, or as otherwise described herein. Lexmark may terminate your license upon notice if you fail to comply with any of the terms of this License Agreement. Upon such termination, you agree to destroy all copies of the Software Program together with all modifications, documentation, and merged portions in any form.
- 11 TAXES.** You agree that you are responsible for payment of any taxes including, without limitation, any goods and services and personal property taxes, resulting from this Agreement or your Use of the Software Program.

- 12 LIMITATION ON ACTIONS.** No action, regardless of form, arising out of this Agreement may be brought by either party more than two years after the cause of action has arisen, except as provided under applicable law.
- 13 APPLICABLE LAW.** This Agreement is governed by the laws of the Commonwealth of Kentucky, United States of America. No choice of law rules in any jurisdiction shall apply. The UN Convention on Contracts for the International Sale of Goods shall not apply.
- 14 UNITED STATES GOVERNMENT RESTRICTED RIGHTS.** The Software Program has been developed entirely at private expense. Rights of the United States Government to use the Software Program is as set forth in this Agreement and as restricted in DFARS 252.227-7014 and in similar FAR provisions (or any equivalent agency regulation or contract clause).
- 15 CONSENT TO USE OF DATA.** You agree that Lexmark, its affiliates, and agents may collect and use information you provide in relation to support services performed with respect to the Software Program and requested by you. Lexmark agrees not to use this information in a form that personally identifies you except to the extent necessary to provide such services.
- 16 EXPORT RESTRICTIONS.** You may not (a) acquire, ship, transfer, or reexport, directly or indirectly, the Software Program or any direct product therefrom, in violation of any applicable export laws or (b) permit the Software Program to be used for any purpose prohibited by such export laws, including, without limitation, nuclear, chemical, or biological weapons proliferation.
- 17 AGREEMENT TO CONTRACT ELECTRONICALLY.** You and Lexmark agree to form this License Agreement electronically. This means that when you click the "Agree" or "Yes" button on this page or use this product, you acknowledge your agreement to these License Agreement terms and conditions and that you are doing so with the intent to "sign" a contract with Lexmark.
- 18 CAPACITY AND AUTHORITY TO CONTRACT.** You represent that you are of the legal age of majority in the place you sign this License Agreement and, if applicable, you are duly authorized by your employer or principal to enter into this contract.
- 19 ENTIRE AGREEMENT.** This License Agreement (including any addendum or amendment to this License Agreement that is included with the Software Program) is the entire agreement between you and Lexmark relating to the Software Program. Except as otherwise provided for herein, these terms and conditions supersede all prior or contemporaneous oral or written communications, proposals, and representations with respect to the Software Program or any other subject matter covered by this License Agreement (except to the extent such extraneous terms do not conflict with the terms of this License Agreement, any other written agreement signed by you and Lexmark relating to your Use of the Software Program). To the extent any Lexmark policies or programs for support services conflict with the terms of this License Agreement, the terms of this License Agreement shall control.

Networking glossary

ad hoc mode	A setting for a wireless device that lets it communicate directly with other wireless devices without an access point or router
ad hoc network	A wireless network that does not use an access point
AutoIP address	An IP address automatically assigned by a network device. If the device is set to use DHCP, but no DHCP server is available, an AutoIP address may be assigned by the device.
BSS (Basic Service Set)	Basic Service Set describes the type of wireless network that you are using. The BSS type can be one of the following: Infrastructure network or Ad-Hoc network.
channel	A specific radio frequency used by two or more wireless devices to communicate with each other. All devices on the network must use the same channel.
DHCP (Dynamic Host Configuration Protocol)	A language used by DHCP servers
DHCP IP address	An IP address automatically assigned by a DHCP server
DHCP server	A computer or router that gives a unique IP address to each device on the network. Unique addresses prevent conflicts.
infrastructure mode	A setting for a wireless device that lets it communicate directly with other wireless devices using an access point or router
installation cable	Connects the printer to the computer temporarily during some methods of installation.
internal wireless print server	A device that lets computers and printers talk to each other over a network without cables
IP (Internet Protocol) address	The network address of a computer or printer. Each device on the network has its own network address. The address may be assigned manually by you (Static IP address), automatically by the DHCP server (DHCP IP address), or automatically by the device (AutoIP address).
ipconfig	A command that displays the IP address and other network information of a Windows computer
MAC (Media Access Control) address	A hardware address that uniquely identifies each device on a network. You can usually find the MAC address printed on the device.
MAC filtering	A method of limiting access to your wireless network by specifying which MAC addresses may communicate on the network. This setting may be specified on wireless routers or access points.
network adapter/card	A device that lets computers or printers talk to each other over a network
network hub	A device that connects multiple devices on a wired network
network name	See "SSID (Service Set Identifier)" on page 137
ping	A test to see if your computer can communicate with another device
printer nickname	The name you assign to your printer so that you and others can identify it on the network

router	A device that shares a single Internet connection with multiple computers or other devices. The basic router controls network traffic.
security key	A password, such as a WEP key or a WPA pass phrase, used to make a network secure
signal strength	Measure of how strongly a transmitted signal is being received
SSID (Service Set Identifier)	The name of a wireless network. When you connect a printer to a wireless network, the printer needs to use the same SSID as the network. Also referred to as network name or BSS (Basic Service Set).
Static IP address	An IP address assigned manually by you
switch	A device similar to a network hub that can connect different networks together
UAA (Universally Administered Address)	An address assigned to a network printer or print server by the manufacturer. To find the UAA, print a network setup page and look for the UAA listing.
USB cable	A lightweight, flexible cable that lets the printer communicate with the computer at much higher speeds than parallel cables
USB port	A small, rectangular port on the back of the computer that connects the peripheral devices using a USB cable, and lets them communicate at high speeds
WEP (Wired Equivalent Privacy)	A security setting that helps prevent unauthorized access to a wireless network. Other possible security settings are WPA and WPA2.
wireless access point	A device that connects wireless devices together to form a wireless network
wireless router	A router that also serves as a wireless access point
Wi-Fi	An industry term that describes the technology used to create an interoperable wireless local area network (WLAN).
WPA (Wi-Fi Protected Access)	A security setting that helps prevent unauthorized access to a wireless network. WPA is not supported on ad hoc wireless networks. Other possible security settings are WEP and WPA2.
WPA2	A newer version of WPA. Older routers are less likely to support this. Other possible security settings are WPA and WEP.

Index

A

- ad hoc wireless network
 - adding a printer 43
 - creating 40
- additional computers
 - installing wireless printer 39
- AliceBox 36
- aligning print cartridges 96
- appliances
 - wireless network 49
- assigning IP address 53

B

- banner paper, loading 54
- buttons, printer control panel
 - Back 21
 - Cancel 21
 - Copy 21
 - Left arrow 22
 - Lighter / Darker 21
 - OK 22
 - Photo 21
 - Power 21
 - Right arrow 21
 - Scan 21
 - Settings 22
 - Start 21

C

- cable
 - installation 46, 47
 - USB 47
- camera
 - connecting 79
- canceling
 - copying 85
 - print jobs 70
 - scan job 89
- cards
 - loading 54
 - memory card 72
- cartridges, print
 - aligning 96
 - cleaning 96
 - installing 93
 - ordering 100
 - preserving 99

- removing 94
 - using genuine Lexmark 95
 - wiping 98
- changing
 - default settings 27
 - Power Saver timeout 27
 - temporary settings 27
- changing wireless settings after installation (Mac) 38
- changing wireless settings after installation (Windows) 38
- checking
 - ink levels 97
- cleaning
 - exterior of the printer 99
- cleaning print cartridge nozzles 96
- Club Internet 36
- collating copies 83
- color effects
 - applying 78
- Communication not available
 - message 123
- configuring
 - IP address 37
- connection
 - configurations 50
- control panel
 - Photo menu 25
 - PictBridge menu 26
 - Scan menu 25
 - Settings menu 26
- copy
 - customizing settings 24
 - making 82
- Copy menu 24
- copy quality, adjusting 83
- copying 82
 - adjusting quality 83
 - collating copies 83
 - enlarging an image 82
 - making a copy lighter or darker 83
 - multiple page images on one sheet 84
- N-up 84
- photos 82
- reducing an image 82
- repeating an image 84

- customizing settings
 - copy 24
 - scan 25
- custom-size paper, loading 54, 66
- custom-size paper, printing 66

D

- defaults
 - resetting factory defaults 101
 - Settings menu 26
- defaults, changing
 - Scan menu 25
- document
 - multiple copies, printing 61
- documents
 - faxing using the software 90
 - loading on scanner glass 86
 - loading on the scanner glass 58
 - making color or black-and-white scan 88
 - printing 60
 - scanning using the printer control panel 86

E

- emission
 - notices 126, 127, 128, 129, 130
- enlarging an image 82
- envelopes
 - loading 54, 65
 - printing 65
- exterior of the printer
 - cleaning 99

F

- factory default settings
 - resetting internal wireless print server 123
- factory default settings, resetting to 101
- fax
 - receiving 91
- faxing
 - using the software 90
- FCC notices 126, 127
- finding
 - information 10

- MAC address 51
- publications 10
- Web site 10
- finding IP address of computer (Mac) 52
- firewall on computer 114
- flash drive
 - inserting 73
 - printing documents from 63
 - printing photos using the proof sheet 80
- France
 - wireless setup 36
- FreeBox 36

G

- glossy and photo paper, loading 60
- glossy paper, loading 54
- greeting cards
 - loading 54

H

- heavyweight matte paper, loading 54

I

- incorrect language appears on display 102
- index cards
 - loading 54
- information needed for setting up printer on wireless network 35
- information, finding 10
- ink levels, checking 97
- inserting
 - flash drives 73
 - memory cards 72
- installation
 - cable 46, 47
- installing
 - network printer 53
 - print cartridges 93
 - printer software 29, 107
- installing printer
 - on wireless network (Mac) 36
 - on wireless network (Windows) 36
- installing wireless printer
 - additional computers 39

- interference
 - wireless network 49
- internal wireless print server
 - resetting to factory default settings 123
- IP address 51, 52
 - configuring 37
- IP address, assigning 53
- iron-on transfers, loading 54

K

- key index 53

L

- labels, loading 54
- labels, printing 65
- language
 - changing 102
- last page first, printing 62
- LiveBox 36
- loading
 - banner paper 54
 - custom-size paper 54, 66
 - documents on the scanner
 - glass 58
 - envelopes 54, 65
 - glossy and photo paper 60
 - glossy paper 54
 - greeting cards 54
 - heavyweight matte paper 54
 - index cards 54
 - iron-on transfers 54
 - labels 54
 - on scanner glass 86
 - paper 54, 60
 - photo cards 54
 - photo paper 54
 - photos on the scanner glass 58
 - postcards 54
 - transparencies 54

M

- MAC address 51
- MAC address filtering 51
- MAC address, finding 51
- Mac printer software
 - using 32
- Macintosh
 - installing printer on wireless network 36

- magazine articles, loading on the scanner glass 58
- maintenance menus
 - Settings menu 26
- memory card
 - inserting 72
 - printing documents from 63
 - printing photos using the proof sheet 80
- memory card slots 19
- menus
 - diagram of 22
- menus list 22
- multiple copies, printing 61
- multiple WEP keys 53

N

- N9UF Box 36
- network printer
 - installing 53
- network scanning 88
- network security 50
- Network Setup menu 38
- network setup page
 - printing 110
- networking
 - finding IP address of
 - computer 52
 - finding IP address of computer (Mac) 52
 - finding IP address of printer 52
 - IP addresses 52
- newspapers, loading on the scanner glass 58
- noise emission levels 130
- notices 126, 127, 128, 129, 130, 131, 132
- N-up copies 84
- N-up feature 62

O

- ordering paper and other supplies 101

P

- page does not print 104
- paper
 - choosing specialty 64
- paper and other supplies
 - ordering 101
- paper exit tray 19

- paper feed guard 18
 - paper guide 19
 - paper support 18
 - paper type
 - choosing automatically 59
 - paper, loading 54, 60
 - parts
 - memory card slots 19
 - paper exit tray 19
 - paper feed guard 18
 - paper guide 19
 - paper support 18
 - PictBridge port 19
 - power supply port 20
 - print cartridge carrier 20
 - printer control panel 18
 - scanner glass 20
 - scanner unit 20
 - top cover 19
 - USB port 20
 - Wi-Fi indicator 18
 - password 50
 - photo cards, loading 54
 - Photo menu 25
 - photo paper, loading 54
 - photos
 - color effects, applying 78
 - copying photos 82
 - loading on the scanner glass 58
 - making borderless copies 82
 - printing from digital camera using DPOF 81
 - printing using printer software 77
 - printing using the proof sheet 80
 - scanning for editing 88
 - transferring from memory card to flash drive 76
 - transferring from memory device to computer 74
 - photos, printing
 - using printer control panel 76
 - PictBridge menu 26
 - PictBridge port 19
 - PictBridge-enabled camera, connecting 79
 - postcards
 - loading 54
 - power button is not lit 103
 - power supply port 20
 - print cartridge carrier 20
 - print cartridge nozzles, cleaning 96
 - print cartridges
 - aligning 96
 - cleaning 96
 - installing 93
 - ordering 100
 - preserving 99
 - refilling 95
 - removing 94
 - using genuine Lexmark 95
 - wiping 98
 - print jobs, canceling 70
 - print jobs, resuming 69
 - print settings
 - saving and deleting 67
 - printer
 - setting up without a computer 13
 - printer cannot connect to wireless network 111
 - printer control panel 18
 - Copy menu 24
 - Network Setup menu 38
 - using 20
 - printer does not print wireless 114
 - printer does not print wirelessly 114
 - printer menus 22
 - Network Setup menu 38
 - printer software
 - installing 29
 - reinstalling 107
 - removing 107
 - printing
 - collate 61
 - custom-size paper 66
 - documents 60
 - documents from memory card or flash drive 63
 - envelopes 65
 - labels 65
 - last page first 62
 - multiple copies 61
 - multiple pages on one sheet 62
 - network setup page 110
 - photos from digital camera using DPOF 81
 - photos using printer control panel 76
 - photos using printer software 77
 - photos using the proof sheet 80
 - reverse page order 62
 - Web page 60
 - proof sheet, using 80
 - protocol 52
 - publications, finding 10
- ## Q
- Quick Connect laptop port 33
- ## R
- rear USB port 33
 - receiving a fax 91
 - recycling
 - WEEE statement 130
 - reducing an image 82
 - refilling print cartridges 95
 - removing print cartridges 94
 - repeating an image 84
 - resetting
 - internal wireless print server to factory default settings 123
 - resuming
 - print jobs 69
 - reverse page order 62
- ## S
- safety information 9
 - saving
 - settings 27
 - saving and deleting print settings 67
 - Scan menu 25
 - scanner glass 20
 - cleaning 99
 - loading documents 58
 - scanner unit 20
 - scanning
 - canceling a scan 89
 - customizing settings 25
 - making color or black-and-white scan 88
 - over a network 88
 - photos for editing 88
 - to a computer 86
 - to a flash drive 86
 - to a memory card 86
 - to a network 86
 - to computer 88

- using the printer control panel 86
- security information 13
 - wireless network 50
- security key 50
- Service Center 102
- setting up printer
 - on wireless network (Mac) 36
 - on wireless network (Windows) 36
- settings
 - changing Power Saver timeout 27
 - disabling timeout 27
 - saving 27
- Settings menu
 - Defaults 27
 - Device Setup 27
 - Maintenance 26
 - Paper Setup 26
- setup troubleshooting
 - incorrect language appears on display 102
 - page does not print 104
 - power button is not lit 103
 - software did not install 103
- setup, printer 13
- software
 - removing and reinstalling 107
 - Service Center 102
 - XPS driver 30
- software did not install 103
- solving printer communication problems 107
- SSID
 - wireless network 50
- switching
 - from desktop computer to laptop computer 33

T

- TCP/IP 52
- Toolbar
 - printing a Web page 60
- top cover 19
- transferring photos 74
 - from memory card to flash drive 76
 - from memory device to computer 74
- transparencies
 - loading 54

- troubleshooting
 - printer communication problems 107
 - Service Center 102
 - wireless network 109
- troubleshooting, setup
 - incorrect language appears on display 102
 - page does not print 104
 - power button is not lit 103
 - software did not install 103
- troubleshooting, wireless
 - changing wireless settings after installation (Mac) 38
 - changing wireless settings after installation (Windows) 38
 - printer cannot connect to wireless network 111
 - Wi-Fi indicator light is blinking orange 116, 119
 - Wi-Fi indicator light is not lit 114
 - Wi-Fi indicator light is still orange 121

U

- USB
 - cable 47
- USB port 20
 - enabling 108
- using
 - Copy menu 24
 - Mac printer software 32

V

- Virtual Private Network 123
- VPN
 - lose connection to printer 123

W

- Web page
 - printing 60
- Web site
 - finding 10
- WEP key
 - key index 53
- Windows
 - installing printer on wireless network 36
- Windows software
 - Abby Sprint OCR 31
 - Fast Pics 31
 - Fax Setup Utility 31
 - Fax Solutions software 31
 - Printing Preferences 31
 - Productivity Studio 31
 - Service Center 31
 - Toolbar 31
 - Tools for Office 31
 - Wireless Setup Utility 31
- wireless
 - printer does not print 114
 - troubleshooting 114, 123
 - with USB 50
- wireless installation
 - will not continue after attaching USB cable 110
- wireless network
 - adding a printer to existing ad hoc network 43
 - common home configurations 44
 - creating an ad hoc network 40
 - information needed for setting up wireless printing 35
 - installing printer on (Mac) 36
 - installing printer on (Windows) 36
 - interference 49
 - networking overview 44
 - security information 50
 - signal strength 48
 - SSID 50
 - troubleshooting 109
 - types of wireless networks 47
- wireless network compatibility 35
- wireless print server
 - not installed 123
- wireless settings
 - changing after installation (Mac) 38
- wireless setup
 - information needed for 35
- wireless signal
 - strength 48
- wireless signal absorption 49
- wireless troubleshooting
 - changing wireless settings after installation (Mac) 38
 - changing wireless settings after installation (Windows) 38
 - printer cannot connect to wireless network 111
 - Wi-Fi indicator light is blinking orange 116, 119

- Wi-Fi indicator light is not lit 114
- Wi-Fi indicator light is still orange 121
- Wi-Fi indicator 18
 - description of colors 37
 - interpreting colors 37
 - light is not lit 114
- Wi-Fi indicator light is blinking orange 116, 119
- Wi-Fi indicator light is green
 - printer does not print 114
- Wi-Fi indicator light is still orange 121

X

- XPS driver
 - installing 30