

Overview

HPE ProLiant DL385 Gen11

The new HPE ProLiant DL385 Gen11 server is an accelerator-optimized 2U 2P solution that delivers exceptional compute performance, upgraded high-speed data transfer rate and memory depth at 2P compute capability. Powered by 4th Generation AMD EPYC™ 9004 Series Processors with up to 128 cores, increased memory capacity (up to 6TB), high-speed PCIe Gen5 I/O, Gen5 EDSFF storage and the newly designed chassis supporting 8 single wide (SW) or 4 double wide (DW) GPUs*. The HPE ProLiant DL385 Gen11 server is a perfect accelerator-optimized 2U 2P solution.

Notes: *8 single wide (SW) is now available.

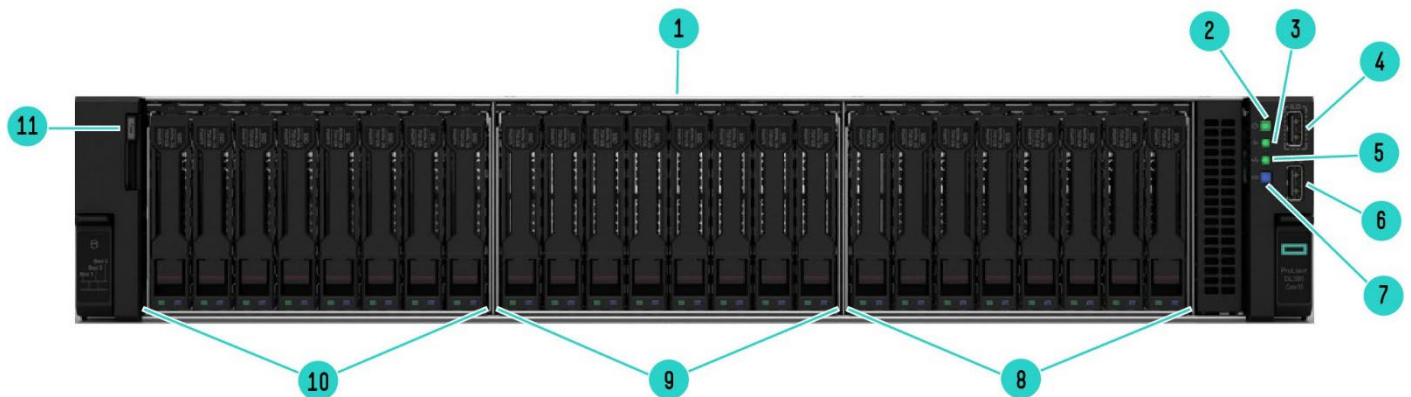

HPE ProLiant DL385 Gen11 SFF CTO Server- Front View

- | | |
|--|--|
| 1. Quick removal access panel | 7. UID button |
| 2. Power On/Standby button and system power LED button | 8. Drive Bay 3. 8 SFF U.3 optional |
| 3. Health LED | 9. Drive Bay 2. 8 SFF U.3 optional |
| 4. iLO front service port | 10. Drive Bay 1. 8 SFF U.3 or Universal Media Bay optional |
| 5. NIC status LED | 11. Serial label pull tag |
| 6. USB 3.2 Gen1 | |

Overview

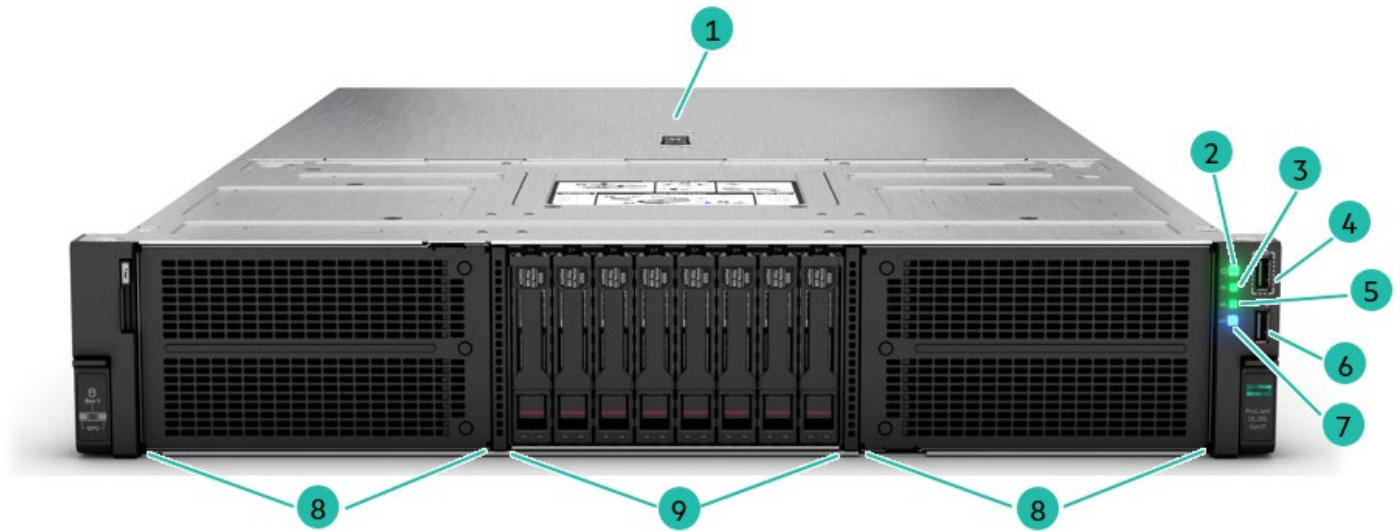

HPE ProLiant DL385 Gen11 GPU CTO Server- Front View

- | | |
|--|--|
| 1. Quick removal access panel | 7. UID button |
| 2. Power On/Standby button and system power LED button | 8. Double Wide GPU 1, 2; Single Wide GPU 1, 2, 3, 4 (Left Box)
Double Wide GPU 3, 4; Single Wide GPU 5, 6, 7, 8 (Right Box) |
| 3. Health LED | 9. Drive Bay 2. 8 SFF U.3 or 8 E3.S EDSFF optional
8 SFF shown here |
| 4. iLO front service port | |
| 5. NIC status LED | |
| 6. USB 3.2 Gen1 | |



Overview

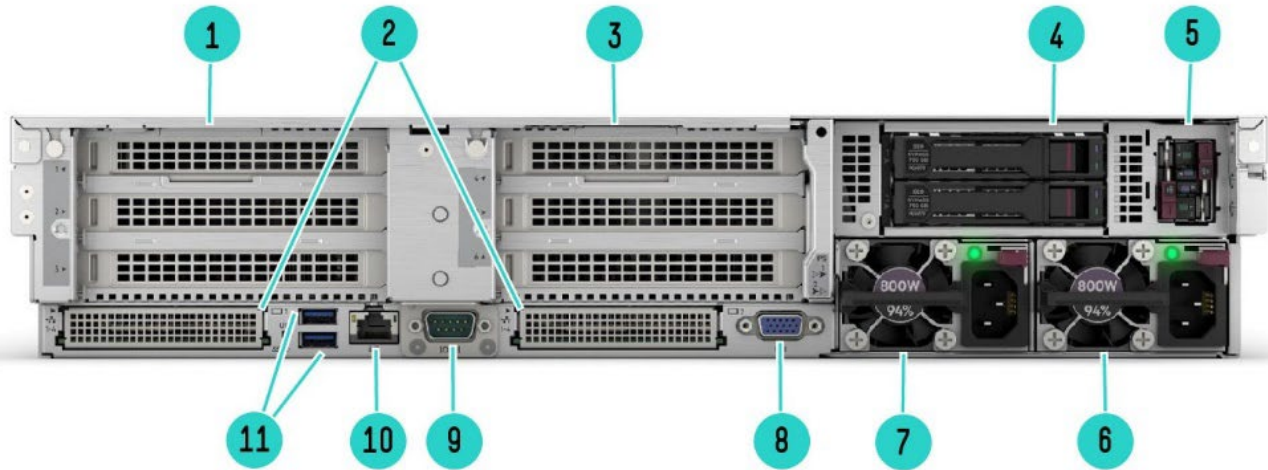

HPE ProLiant DL385 Gen11 all CTO Servers - Rear View

- | | |
|--|---|
| 1. Primary Riser: PCI Slots (Slots 1–3 top to bottom) | 7. HPE Flexible Slot Power Supply bay 2 |
| 2. OCP 3.0 Slot | 8. VGA connector |
| 3. Secondary Riser: PCI Slots (Slots 4–6 top to bottom) | 9. Serial port (optional) |
| 4. Tertiary Riser: (Slots 7–8 top to bottom, not shown).
Optional rear 2 SFF cage | 10. Dedicated iLO management port |
| 5. Hot pluggable M.2 Boot Device (optional, not shown) | 11. USB 3.2 Gen1 ports |
| 6. HPE Flexible Slot power supply bay 1 | |



Overview

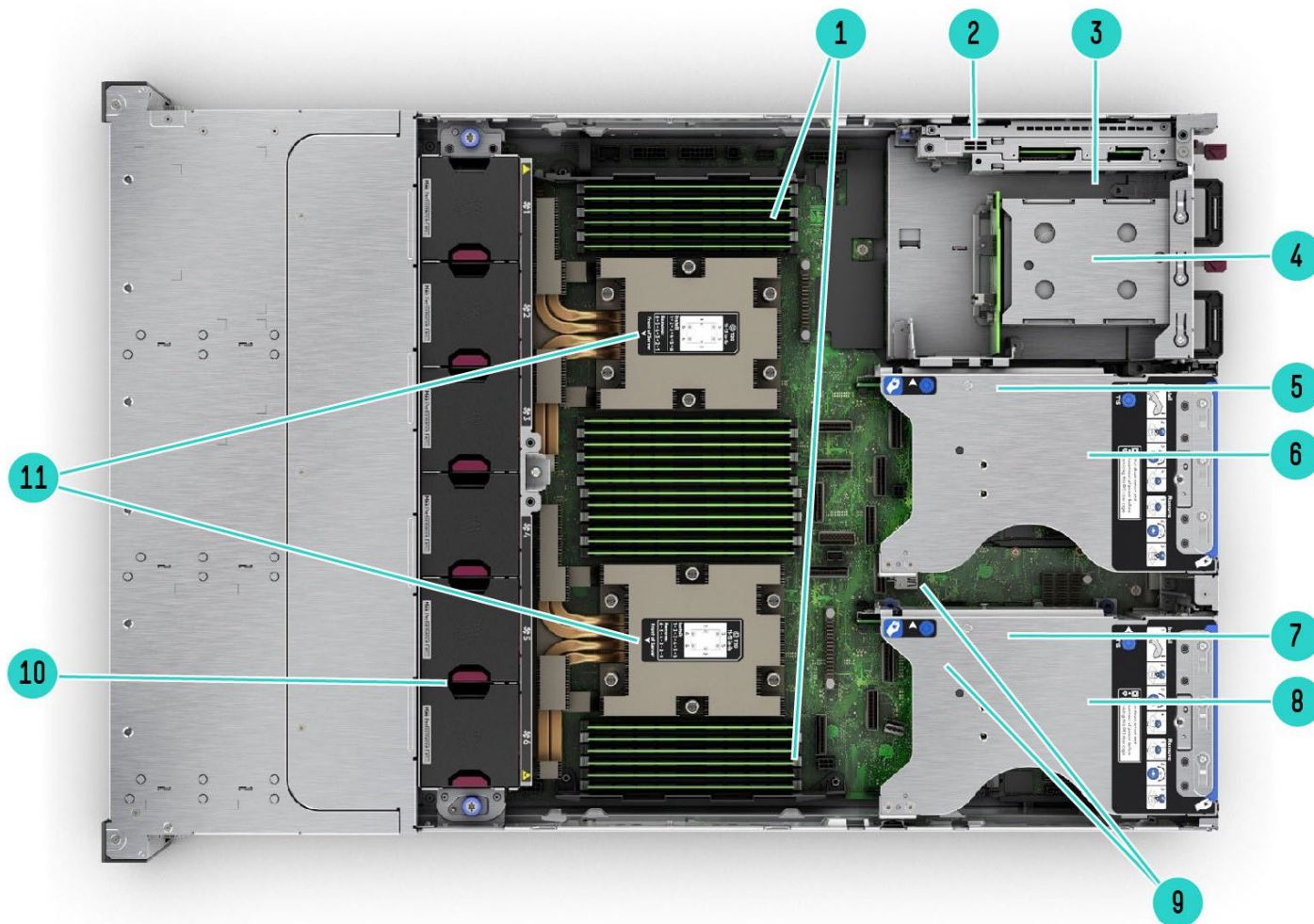

HPE ProLiant DL385 Gen11 SFF CTO Server - Internal View

- | | |
|--|---|
| 1. DDR5 DIMM slots. Shown populated in 24 slots | 7. Primary PCIe riser cage |
| 2. Hot Pluggable M.2 Boot Device bracket | 8. (Under) OCP 3.0 Slot 1 |
| 3. (Under) Up to 2 Hot Plug redundant HPE Flexible Slot Power supplies | 9. 2x USB 3.2 Gen1 ports (one under primary riser cage) |
| 4. Rear 2SFF drive cage | 10. Fan cage shown with 6 Performance Hot-plug fans |
| 5. Secondary PCIe riser cage | 11. 2 Processors (heatsinks shown) |
| 6. (Under) OCP 3.0 Slot 2 | |



Overview

What's New

- Adding two new 4th Generation AMD EPYC™ Series Processors with 128 and 112 cores (9754 & 9734)
- New CTO servers including EDSFF, GPU and 48SFF CTO servers
- GPU CTO Servers now support hardware RAID/ controllers for the front 8SFF drive cage
Notes: [Controllers on GPU CTO Servers won't support storage backup battery until the battery bracket is launched by July 2024](#)
- 8x Single Wide GPU capability is added to DL385 Gen11
- Nvidia H100 94GB NVL GPU added
- Direct Liquid Cooling (DLC) is now supported
- New 128GB Dual Rank x4 Registered DIMM is added
- Advanced data transfer rate and higher network speed from the PCIe Gen5 serial expansion bus
- New HPE Integrated Lights-Out 6 (iLO 6) server management software
- Supports hot-pluggable, high-availability RAID M.2 boot options – NS204i-u
- OpenBMC Capable through iLO6 Transfer of Ownership Process

Platform Information

Form Factor

- 2U rack

Chassis Types

- 8 SFF with optional Universal Media Bay, and optional SFF or NVMe drive bay options. Front drive bay supported up to 24 SFF
- 8 LFF with Universal Media Bay, and optional SFF or NVMe drive bay options. Front drive bay supported up to 12 LFF
- 12 EDSFF with no Universal Media Bay, no rear drive support. Configure up to 36 EDSFF
- GPU CTO Server that supports up to 4x Double Wide GPUs or 8x Single Wide GPUs and with 1x 8SFF U.3 x4 backplane
- 48SFF CTO Server that supports up to 48SFF SAS/SATA/NVMe with tri-mode controllers

Notes:

- [DL385 Gen11 uses Basic Carrier drive cages.](#)
- [The 4 LFF rear drive box will consume space for the primary, secondary and tertiary risers.](#)
- [3x 8 SFF drive cages can be used to build up a 24 SFF configuration.](#)
- [The 12 LFF configuration needs to be built up with 8LFF chassis and one 4LFF drive cage.](#)
- [The Universal Media Bay \(P57857-B21\) is not available with the LFF chassis or the 24 SFF \(3x 8SFF cages\) configuration, and can only be populated in Box 1.](#)
- [U.3 x1 and U.3 x4 drive cages CAN mix.](#)
- [EDSFF offerings will be available within 1H 2023.](#)

System Fans

Standard – fan types included

- Choice of Standard Fan Kit or Performance Fan Kit

Notes:

- [The DL385 Gen11 supports up to 6 fans with fan redundancy built in. One fan rotor failure will place server in degraded mode but fully functional. Two fan rotor failures could provide warning and imminent server shutdown.](#)
- [Each Fan kits are designated to operate under different configuration. For more information, please refer to the Cooling option message in the Unique option section.](#)



Standard Features

Processors Up to 2 of the following depending on model.

Notes: For more information regarding AMD EPYC processors, please see the following:

<https://www.amd.com/en/products/processors/server/epyc.html>

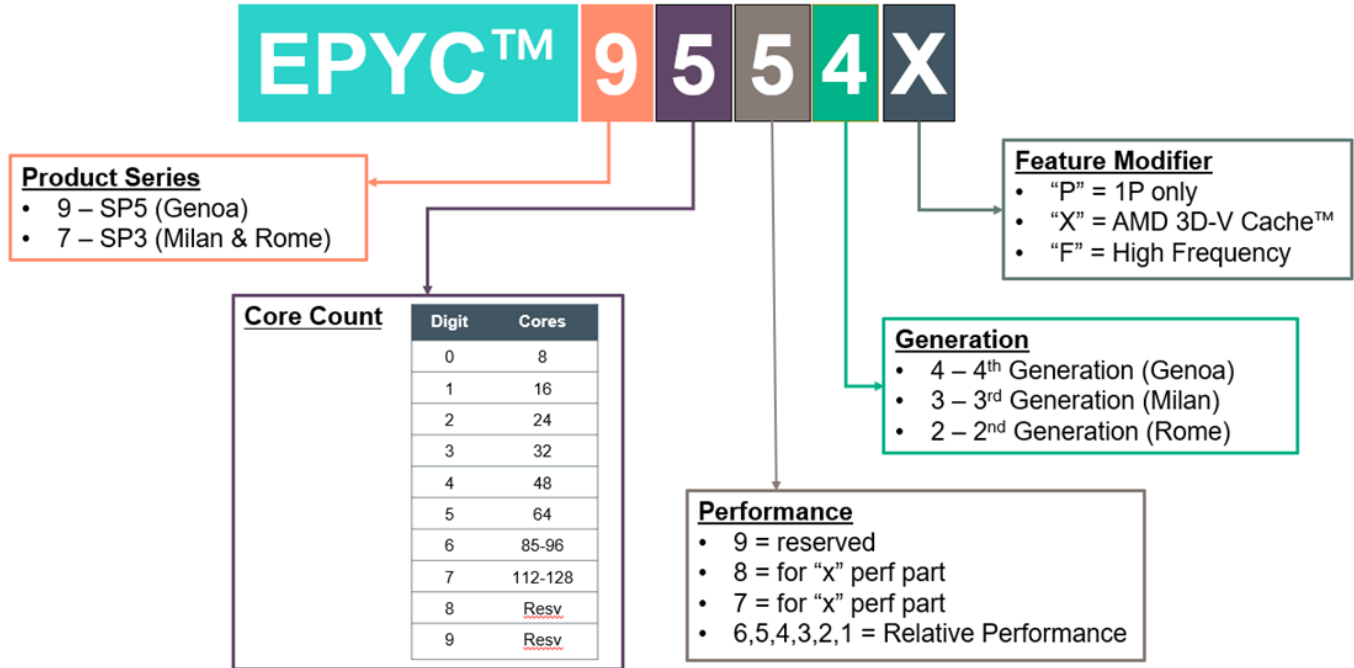

AMD EPYC Processor	Cores	Base Frequency	Max Frequency	Max Memory	Wattage	Cache	Memory
EPYC 9124	16	3.0 GHz	3.7 GHz	3TB	200W	64MB	4800MT/s
EPYC 9174F	16	4.1 GHz	4.4 GHz	3TB	320W	256MB	4800MT/s
EPYC 9224	24	2.5 GHz	3.7 GHz	3TB	200W	64MB	4800MT/s
EPYC 9254	24	2.9 GHz	4.15 GHz	3TB	200W	128MB	4800MT/s
EPYC 9274F	24	4.05 GHz	4.3 GHz	3TB	320W	256MB	4800MT/s
EPYC 9334	32	2.7 GHz	3.9 GHz	3TB	210W	128MB	4800MT/s
EPYC 9354	32	3.25 GHz	3.8 GHz	3TB	280W	256MB	4800MT/s
EPYC 9374F	32	3.85 GHz	4.3 GHz	3TB	320W	256MB	4800MT/s
EPYC 9454	48	2.75 GHz	3.8 GHz	3TB	290W	256MB	4800MT/s
EPYC 9474F	48	3.6 GHz	4.1 GHz	3TB	360W	256MB	4800MT/s
EPYC 9534	64	2.45 GHz	3.7 GHz	3TB	280W	256MB	4800MT/s
EPYC 9554	64	3.1 GHz	3.75 GHz	3TB	360W	256MB	4800MT/s
EPYC 9634	84	2.25 GHz	3.7 GHz	3TB	290W	384MB	4800MT/s
EPYC 9654	96	2.4 GHz	3.7 GHz	3TB	360W	384MB	4800MT/s
EPYC 9734	112	2.2 GHz	3.0 GHz	3TB	340W	256MB	4800MT/s
EPYC 9754	128	2.25 GHz	3.1 GHz	3TB	360W	256MB	4800MT/s
EPYC 9184X	16	3.55 GHz	4.2 GHz	3TB	320W	768MB	4800MT/s
EPYC 9384X	32	3.1 GHz	3.9 GHz	3TB	320W	768MB	4800MT/s
EPYC 9684X	96	2.55 GHz	3.7 GHz	3TB	400W	1,150MB	4800MT/s

Notes:

- All AMD EPYC processors can support up to 3TB of memory each under 1DPC, 12 channel per processor. 6TB of memory per two processors.
- 160 PCIe 5.0 lanes support with two sockets. Motherboard supports 3XGMI two-processor interconnect by default.
- The wattage information indicates the default cTDP (Configurable TDP) of the processor.



Standard Features

Chipset

No chipset – System on Chip (SoC) design.

On System Management Chipset

HPE iLO 6 ASIC

Read and learn more in the [iLO QuickSpecs](#).

Memory

One of the following depending on model

Type	HPE DDR5 Smart Memory, Registered (RDIMM)
DIMM Slots Available	24 12 DIMM slots per processor, 12 channels per processor, 1 DIMM per channel
Maximum capacity (RDIMM)	6.0TB 24 x 256 GB RDIMM* @ 4800 MT/s at 1 DPC

Notes:

- All processors support up to 6TB memory per server when 2 processors are supported.
- LRDIMM and Persistent Memory are not supported.
- For additional information, please see the [HPE DDR5 Smart Memory QuickSpecs](#).
- For General Server Memory Population Rules and Guidelines for Gen11 see details here: <http://www.hpe.com/docs/memory-population-rules>

Memory Protection

Advanced ECC

Advanced ECC uses single device data correction to detect and correct single and all multibit error that occurs within a single DRAM chip.

Expansion Slots

Primary Riser

Notes:

- Bus width indicates the number of physical electrical lanes running to the connector.
- There are three Primary riser configurations:
 - o Default 1 slot only (1x16 on Slot3)
 - o Default Slot3 + Slot1 & 2 with HPE DL385 G11 2x16 Prim FIO Upg Rsr Kit (P57890-B21)
 - o HPE DL385 G11 x16 Prim FIO Rsr LFF Rear (P55098-B21) selectable when rear 4LFF SAS/SATA cage kit (P55088-B21) is configured
- When both Primary Slot1 & OCP Slot21 (OCP1) are supported, Slot1 & Slot21 (OCP1) combined can only support up to 112GB/s bandwidth due to processor limitation

Primary Riser config#1					
Slots #	Technology	Bus Width	Connector Width	Slot Form Factor	Notes
1	N/A	N/A	N/A	N/A	N/A
2	N/A	N/A	N/A	N/A	N/A
3	PCIe 5.0	X16	X16	Full-height, half-length slot	Proc 1



Standard Features

Primary Riser config#2

Slots #	Technology	Bus Width	Connector Width	Slot Form Factor	Notes
1	PCIe 5.0	X16	X16	Full-height, half-length slot	Proc 1. Supported with P57890-B21
2	PCIe 5.0	X16	X16	Full-height, half-length slot	Proc 1. Supported with P57890-B21
3	PCIe 5.0	X16	X16	Full-height, half-length slot	Proc 1

Primary Riser config#3

Slots #	Technology	Bus Width	Connector Width	Slot Form Factor	Notes
1 (below the 4LFF drive cage)	PCIe 5.0	X16	X16	Full-height, half-length slot	Proc 1. Scenario when rear 4LFF SAS/SATA cage is selected

Secondary Riser:

Notes:

- Bus width indicates the number of physical electrical lanes running to the connector.
- There are four Secondary riser configurations:
 - o 1 slot using HPE DL385 Gen11 x16 Sec Riser Kit (P55097-B21)
 - o 2 slots using Slot 6 P55097-B21 + Slot 5 with HPE DL385 G11 x16 Slot5 Sec Upg Rsr Kit (P68392-B21)
 - o 3 slots using Slot 6 P55097-B21 + Slot4 & 5 with HPE DL385 Gen11 2x16 Sec Upg Riser Kit (P57891-B21)
 - o HPE DL385 Gen11 x16 Sec FIO Rsr LFF Rear (P57892-B21) selectable when rear 4LFF SAS/SATA cage kit (P55088-B21) is configured
 - o HPE DL385 Gen11 x16 LP Sec Riser Kit (P59260-B21) selectable when HPE NS204i-u Gen11 Ht Plg Boot Opt Dev (P48183-B21) is selected and rear 4LFF SAS/SATA cage kit (P55088-B21) is configured
- When both Secondary Slot6 & Tertiary Slot7 are supported, Slot6 & Slot7 combined can only support up to 112GB/s bandwidth due to processor limitation

Secondary Riser config#1

Slots #	Technology	Bus Width	Connector Width	Slot Form Factor	Notes
4	N/A	N/A	N/A	N/A	N/A
5	N/A	N/A	N/A	N/A	N/A
6	PCIe 5.0	X16	X16	Full-height, half-length slot	Proc 2

Secondary Riser config#2

Slots #	Technology	Bus Width	Connector Width	Slot Form Factor	Notes
4	N/A	N/A	N/A	N/A	N/A
5	PCIe 5.0	X16	X16	Full-height, half-length slot	Proc 2
6	PCIe 5.0	X16	X16	Full-height, half-length slot	Proc 2

Secondary Riser config#3

Slots #	Technology	Bus Width	Connector Width	Slot Form Factor	Notes
4	PCIe 5.0	X16	X16	Full-height, half-length slot	Proc 2
5	PCIe 5.0	X16	X16	Full-height, half-length slot	Proc 2
6	PCIe 5.0	X16	X16	Full-height, half-length slot	Proc 2



Standard Features

Secondary Riser config#4					
Slots #	Technology	Bus Width	Connector Width	Slot Form Factor	Notes
1 (below the 4LFF drive cage)	PCIe 5.0	X16	X16	Full-height, half-length slot	Proc 2. Scenario when rear 4LFF SAS/SATA cage is selected

Secondary Riser config#5					
Slots #	Technology	Bus Width	Connector Width	Slot Form Factor	Notes
1, Low Profile Type (below the 4LFF drive cage)	PCIe 5.0	X16	X16	Low Profile, half-length slot	Proc 2. Scenario when NS204i-u boot device and rear 4LFF SAS/SATA cage are selected

Tertiary Riser

Notes:

- Bus Width Indicates the number of physical electrical lanes running to the connector.
- There is one type of Tertiary riser configuration by selecting HPE DL385 Gen11 2x16 Tert FIO Riser Kit (P57893-B21)
- When both Secondary Slot6 & Tertiary Slot7 are supported, Slot6 & Slot7 combined can only support up to 112GB/s bandwidth due to processor limitation

Tertiary Riser					
Slots #	Technology	Bus Width	Connector Width	Slot Form Factor	Notes
7	PCIe 5.0	X16	X16	Full-height, half-length slot	Proc 2
8	PCIe 5.0	X16	X16	Full-height, half-length slot	Proc 2

Storage Controllers

The Gen11 controller naming framework has been updated to simplify identification as depicted below. For a more detailed breakout of the available Gen11 Smart Array controllers visit the controller data sheet

NVMe Boot Device

HPE NS204i-u Gen11 NVMe Hot Plug Boot Optimized Storage Device

Notes:

- NS204i-u is a boot device module and is not a PCIe card. The M.2 drives that come with the module are externally accessible. 2pcs of 480GB M.2 NVMe SSD are included in the NS204i-u Hot Plug Boot Device
- RAID 1 supported on the NS204i-u Hot Plug Boot Device.
- There are three locations where NS204i-u Hot Plug Boot Device can be supported and PCIe slots will reduce in some cases:
 - o Tertiary location above power supplies. Tertiary risers will not be supported.
 - o Secondary Slot 4 location. Slot 4 and Slot 5 of the secondary riser cage will not be supported.
 - o Secondary location when selected with the low profile secondary riser, below the 4LFF rear drive cage. In this case, only one riser will be supported in the secondary riser location.

Software RAID – NO Software RAID is support on AMD Gen11 servers

Essential RAID Controllers

- HPE Smart Array E208e-p SR Gen10 Controller



Standard Features

Performance RAID Controllers

- HPE MR216i-p Gen11 x16 Lanes without Cache PCI SPDM Plug-in Storage Controller
- HPE MR216i-o Gen11 x16 Lanes without Cache OCP SPDM Storage Controller
- HPE MR408i-o Gen11 x8 Lanes 4GB Cache OCP SPDM Storage Controller
- HPE MR416i-o Gen11 x16 Lanes 8GB Cache OCP SPDM Storage Controller
- HPE MR416i-p Gen11 x16 Lanes 8GB Cache PCI SPDM Plug-in Storage Controller
- HPE SR932i-p Gen11 x32 Lanes 8GB Wide Cache PCI SPDM Plug-in Storage

Notes: For additional details, please visit:

[HPE Compute MR Gen11 Controllers Quick Specs](#)

[HPE Compute SR Gen11 Controllers Quick Specs](#)

Internal Storage Devices

One of the following depending on model

Optical Drive

- Available on SFF and LFF CTO Servers as an option (DVD-ROM or DVD-RW)

Hard Drives

- None ship standard

Graphics

Integrated Video Standard

- Video modes up to 1920 x 1200@60Hz (32 bpp)
- 16MB Video Memory

HPE iLO 6 on system management memory

- 64 MB Flash
- 8 Gbit DDR4 with ECC protection

Maximum Internal Storage

Drive	Capacity	Configuration
Hot Plug LFF SAS HDD	400 TB	(12+4+4) x20TB (with optional mid –tray and rear 4LFF drive cage)
Hot Plug LFF SATA HDD	400 TB	(12+4+4) x20TB (with optional mid –tray and rear 4LFF drive cage)
Hot Plug LFF SATA SSD	153.6 TB	(12+4+4) x7.68TB (with optional mid –tray and rear 4LFF drive cage)
Hot Plug SFF SAS HDD	81.6 TB	(24+8+2) x2.4TB (with optional mid –tray and rear 2SFF drive cage)
Hot Plug SFF SAS SSD	261.12 TB	(24+8+2) x7.68TB (with optional mid –tray and rear 2SFF drive cage)
Hot Plug SFF SATA HDD	68 TB	(24+8+2) x2TB (with optional mid –tray and rear 2SFF drive cage)
Hot Plug SFF SATA SSD	261.12 TB	(24+8+2) x7.68TB (with optional mid –tray and rear 2SFF drive cage)
Hot Plug SFF NVMe PCIe SSD	522.24 TB NVMe	(24+8+2) x15.36TB (with optional mid –tray and rear 2SFF drive cage)

Power Supply

- HPE 800W Flex Slot Platinum Hot Plug Low Halogen Power Supply Kit
Notes: Available in 94% Power Efficiency
- HPE 1000W Flex Slot Titanium Hot Plug Power Supply Kit
Notes: Available in 96% Power Efficiency



Standard Features

- HPE 1600W Flex Slot Platinum Hot Plug Low Halogen Power Supply Kit

Notes:

- Available in 94% Power Efficiency.
- 200-240VAC power input only.

- HPE 1600W ~48VDC Power Supply Kit

Notes:

- Available in 94% Power Efficiency.
- 200-240VAC power input only.

HPE Flexible Slot (Flex Slot) Power Supplies share a common electrical and physical design that allows for hot plug, tool-less installation into HPE ProLiant Gen11 Performance Servers. Flex Slot power supplies are certified for high-efficiency operation and offer multiple power output options, allowing users to "right-size" a power supply for specific server configurations. This flexibility helps to reduce power waste, lower overall energy costs, and avoid "trapped" power capacity in the data center. All pre-configured servers ship with a standard 6-foot IEC C-13/C-14 jumper cord (A0K02A). This jumper cord is also included with each standard AC power supply option kit. If a different power cord is required, please check the [ProLiant Power Cables](#) web page.

To review the power requirements for your selected system, please use the [HPE Power Advisor Tool](#).

For information on power specifications and technical content visit [HPE Server power supplies](#).

Interfaces

Serial	Optional, rear
Display Port	1 optional on both Universal Media Bay and LFF optical drive module
VGA Port	1 VGA Port standard at rear
Network Ports	None. Choice of OCP or stand up card
HPE iLO Remote Management Network Port	1 Gb Dedicated
Front iLO Service Port	1 standard
USB 3.2 Gen1	5 standard on all models: 1 front, 2 rear, 2 internal 1 optional with Universal Media Bay
USB 2.0	1 optional with Universal Media Bay
SID (Systems Insight Display)	Optional

UEFI

Configure and boot your servers securely with industry standard Unified Extensible Firmware Interface (UEFI).

Learn more at <http://www.hpe.com/servers/uefi>.

Operating Systems and Virtualization Software Support for ProLiant Servers

- [Windows Server 2019](#)
- [Windows Server 2022](#)
- [Red Hat Enterprise Linux \(RHEL\) 8.6](#)
- [Red Hat Enterprise Linux \(RHEL\) 9.0](#)
- [SUSE Linux Enterprise Server \(SLES\) 15 SP4](#)
- [VMware ESXi 7.0 U3](#)
- [VMware ESXi 8.0](#)

Notes: For more information on Hewlett Packard Enterprise Certified and Supported ProLiant Servers for OS and Virtualization Software and latest listing of software drivers available for your server.

<https://www.hpe.com/us/en/servers/server-operating-systems.html>



Standard Features

HPE Server UEFI

Unified Extensible Firmware Interface (UEFI) is an industry standard that provides better manageability and more secured configuration than the legacy ROM while interacting with your server at boot time. HPE ProLiant Gen11 servers have a UEFI Class 2 implementation.

Notes: The UEFI System Utilities tool is analogous to the HPE ROM-Based Setup Utility (RBSU) of legacy BIOS. For more information, please visit <http://www.hpe.com/servers/uefi>.

UEFI enables numerous new capabilities specific to HPE ProLiant servers such as

- Secure Boot and Secure Start enabled for enhanced security
- Operating system specific functionality
- Support for > 2.2 TB (using GPT) boot drives
- USB 3.2 Gen1 Stack
- Embedded UEFI Shell
- Mass Configuration Deployment Tool using iLO RESTful API that is Redfish API Conformant
- PXE boot support for IPv6 networks
- Workload Profiles for simple performance optimization

UEFI Boot Mode only

- TPM 2.0 Support
- NVMe Boot Support
- iSCSI Software Initiator Support.
- HTTP/HTTPs Boot support as a PXE alternative.
- Boot support for option cards that only support a UEFI option ROM

Notes:

- For UEFI Boot Mode, boot environment and OS image installations should be configured properly to support UEFI.
- Enabling TPM 2.0 no longer requires TPM module option kit for Gen11. It is an embedded feature.

Industry Standard Compliance

- ACPI 6.1 Compliant
- PCIe 4.0 Compliant
- WOL Support
- Microsoft® Logo certifications
- Support for Microsoft Secure Code
- PXE Support
- VGA/Display Port

Notes: This support is on the optional Universal Media Bay.

- USB 3.1 Gen1 Compliant (internal)
- USB 2.0 Compliant (external ports)

Notes: This support is on the optional Universal Media Bay.

- USB NIC Driver in UEFI for Factory
- OCP 3.0 SFF NIC Support
- OCP 3.0 SFF Storage Support
- Embedded TPM Support
- Energy Star 4.0

Notes: Energy Star 4.0 is supported. Please configure P68503-B21 to trigger Energy Star 4.0

- SMBIOS 3.1UEFI 2.7
- Redfish API
- IPMI 2.0
- Secure Digital 2.0
- Advanced Encryption Standard (AES)
- Triple Data Encryption Standard (3DES)



Standard Features

- SNMP v3
- TLS 1.2
- DMTF Systems Management Architecture for Server Hardware Command Line Protocol (SMASH CLP)
- DMTF Redfish support for SecureBoot Key Management
- ACPI DSM Drive LED Management
- Memory Page Retire Support
- Retire old VMware Secure Boot Key
- MCTP over PCIe multi-segment (EDKII for GenoaPI 0.0.9.0, HPE under verifying0)
- APML 1.0
- One Button Secure Erase Enhancements
- Active Directory v1.0
- European Union (EU) eco-design regulations for server and storage products, known as Lot 9, go into effect on March 1st, 2020. Among other requirements, for servers this directive establishes power thresholds for idle state, as well as efficiency and performance in active state which vary among configurations. HPE ProLiant Gen10 servers are compliant with Lot9 requirements. For more information regarding HPE Lot 9 conformance, please visit: <https://www.hpe.com/us/en/about/environment/msds-specs-more.html>
- ASHRAE A3/A4
Notes: For additional technical thermal details regarding ambient temperatures, humidity and features support please visit: <http://www.hpe.com/servers/ashrae>
UEFI Class 3 (Unified Extensible Firmware Interface Forum)

Embedded Management

HPE Integrated Lights-Out (HPE iLO)

Monitor your servers for ongoing management, service alerting, reporting and remote management with HPE iLO. Learn more at <http://www.hpe.com/info/ilo>.

UEFI

Configure and boot your server(s) securely with industry standard Unified Extensible Firmware Interface (UEFI).

Intelligent Provisioning

Hassle free server and OS provisioning for 1 or more servers with Intelligent Provisioning. Learn more at <http://www.hpe.com/servers/intelligentprovisioning>.

iLO RESTful API

iLO RESTful API is Redfish API conformance and offers simplified server management automation such as configuration and maintenance tasks based on modern industry standards. Learn more at <http://www.hpe.com/info/restfulapi>.

OpenBMC Support

OpenBMC Capable through iLO6 Transfer of Ownership Process. Learn more at [OpenBMC enablement on HPE ProLiant servers | HPE](#)

Server Utilities

Active Health System

The HPE Active Health System (AHS) is an essential component of the iLO management portfolio that provides continuous, proactive health monitoring of HPE servers. Learn more at <http://www.hpe.com/servers/ahs>.



Standard Features

Active Health System Viewer

The Active System Health Viewer (AHSV) was deprecated as of March 2022. Users are now recommended to use the InfoSight (<https://www.hpe.com/us/en/solutions/infosight.html>) for Servers Portal for AHS viewing capabilities. In InfoSight for Servers portal, users will also be able to view hardware configuration details, firmware and driver information, warranty and support status of a server, wellness alerts, and create support cases for servers under a valid warranty or support contract.

HPE InfoSight provides the same security assurances as that of AHSV. Furthermore, InfoSight can be used as an AHSV replacement even if customers do not want to share AHSV logs and telemetry data on an ongoing basis.

Smart Update

Keep your server(s) up to date with the HPE Smart Update solution by using Smart Update Manager (SUM) to optimize the firmware and driver updates of the Service Pack for ProLiant (SPP). Learn more at <https://www.hpe.com/us/en/servers/smart-update.html>

iLO Amplifier Pack

Designed for large enterprise and service provider environments with hundreds of HPE servers, the iLO Amplifier Pack is a free, downloadable open virtual application (OVA) that delivers the power to discover, inventory and update Gen8, Gen9, Gen10 & Gen10 Plus HPE servers at unmatched speed and scale. Use with an iLO Advanced License to unlock full capabilities. Learn more at <http://www.hpe.com/servers/iLOamplifierpack>.

RESTful Interface Tool

RESTful Interface tool (iLOREST) is a single scripting tool to provision using iLO RESTful API to discover and deploy servers at scale. Learn more at <http://www.hpe.com/info/resttool>.

Scripting Tools

Provision one to many servers using your own scripts to discover and deploy with Scripting Tool (STK) for Windows and Linux or Scripting Tools for Windows PowerShell. Learn more at <http://www.hpe.com/servers/powershell>.

HPE OneView Standard

HPE OneView Standard can be used for inventory, health monitoring, alerting, and reporting without additional fees. It can monitor multiple HPE server generations. The user interface is similar to the HPE OneView Advanced version, but the software-defined functionality is not available. Learn more at <http://www.hpe.com/info/oneview>.

HPE GreenLake for Compute Ops Management

HPE is intelligently transforming compute management with an intuitive cloud operating experience through HPE GreenLake cloud platform to streamline and secure operations from edge-to-cloud. Automated key lifecycle tasks, for onboarding, updating, managing, and monitoring HPE servers, brings agility and greater efficiencies to wherever compute devices reside via a unified single browser-based interface. Manage single locations or multiple, distributed sites. Keep tens to thousands of servers secure with batch policy controls and automated updates.

Compute Ops Management is cloud-native software that is continually updated with new services, features, patches, and fixes. The management application resides in the HPE GreenLake cloud platform (access via <https://console.greenlake.hpe.com>) and leverages the HPE GreenLake architecture, security, and unified operations.

A 3-year subscription to HPE GreenLake for Compute Ops Management is added by default when ordering an HPE ProLiant Gen11 rack, tower, or micro server.

For more information, visit the HPE GreenLake for Compute Ops Management QuickSpecs:

<https://www.hpe.com/psnow/doc/a50004263enw>



Standard Features

Warranty

This product is covered by a global limited warranty and supported by HPE Services and a worldwide network of Hewlett Packard Enterprise Authorized Channel Partners resellers. Hardware diagnostic support and repair is available for three years from date of purchase. Support for software and initial setup is available for 90 days from date of purchase. Enhancements to warranty services are available through HPE Services operational services or customized service agreements. Hard drives have either a one year or three year warranty; refer to the specific hard drive QuickSpecs for details.

Notes: Server Warranty includes 3-Year Parts, 3-Year Labor, 3-Year Onsite support with next business day response. Warranty repairs may be accomplished through the use of Customer Self Repair (CSR) parts. These parts fall into two categories: 1) Mandatory CSR parts are designed for easy replacement. A travel and labor charge will result when customers decline to replace a Mandatory CSR part; 2) Optional CSR parts are also designed for easy replacement but may involve added complexity. Customers may choose to have Hewlett Packard Enterprise replace Optional CSR parts at no charge. Additional information regarding worldwide limited warranty and technical support is available at: <https://www.hpe.com/support/ProLiantServers-Warranties>

Security

- UEFI Secure Boot and Secure Start support
- Immutable Silicon Root of Trust
- FIPS 140-3 validation (iLO 6 certification in progress)
- Common Criteria certification (iLO 6 certification in progress)
- Configurable for PCI DSS compliance
- Advanced Encryption Standard (AES) and Triple Data Encryption Standard (3DES) on browser
- Support for Commercial National Security Algorithms (CNSA)
- Tamper-free updates – components digitally signed and verified
- Secure Recovery – recover critical firmware to known good state on detection of compromised firmware
- Ability to rollback firmware
- Secure erase of NAND/User data
- TPM (Trusted Platform Module) 2.0

Notes: enabling TPM 2.0 no longer requires TPM module option kit for Gen11. It is an embedded feature.

- Bezel Locking Kit option
 - Chassis Intrusion detection option
-



Optional Features

Server Management

HPE iLO Advanced

HPE iLO Advanced licenses offer smart remote functionality without compromise, for all HPE ProLiant servers. The license includes the full integrated remote console, virtual keyboard, video, and mouse (KVM), multi-user collaboration, console record and replay, and GUI-based and scripted virtual media and virtual folders. You can also activate the enhanced security and power management functionality.

HPE OneView Advanced

HPE OneView brings a new level of automation to infrastructure management by taking a template driven approach to provisioning, updating, and integrating compute, storage, and networking infrastructure. It provides full-featured licenses which can be purchased for managing Gen8, Gen9, Gen10 & Gen10 Plus servers. To learn more visit <http://www.hpe.com/info/oneview>.

HPE InfoSight for Servers

HPE InfoSight for Servers combines the cloud-based machine learning of InfoSight with the health and performance monitoring of Active Health System (AHS) and iLO to optimize performance and predict and prevent problems. The end result is an intelligent environment that modernizes IT operations and enhances the support experience by predicting and preventing the infrastructure issues that lead to application disruptions, wasted IT staff time and missed business opportunities.

Learn more at <https://www.hpe.com/servers/infosight>

Rack and Power Infrastructure

The story may end with servers, but it starts with the foundation that makes compute go – and business grow. We've reinvented our entire portfolio of rack and power products to make IT infrastructure more secure, more practical, and more efficient. In other words, we have created a stronger, smarter, and simpler infrastructure to help you get the most out of your IT equipment. As an industry leader, Hewlett Packard Enterprise is uniquely positioned to address the key concerns of power, cooling, cable management and system access.

HPE G2 Advanced and Enterprise Racks are perfect for the server room or today's modern data center with enhanced airflow and thermal management, flexible cable management, and a 10 year Warranty to support higher density computing.

HPE G2 PDUs offer reliable power in flexible form factors that operate at temperatures up to 60°C, include color-coded outlets and load segments and a low-profile design for optimal access to the rack and support for dense rack environments.

HPE Uninterruptible Power Systems are cost-effective power protection for any type workload. Some UPSs include options for remote management and extended runtime modules so your critical dense data center is covered in power outages.

HPE KVM Solutions include a console and switches designed to work with your server and IT equipment reliably. We've got a cost-effective KVM switch for your first rack and multiple connection IP switches with remote management and security capabilities to keep your data center rack up and running.

Learn more about HPE Racks, KVM, PDUs and UPSs at [HPE Rack and Power Infrastructure](#).

One Config Simple (SCE)

SCE is a guided self-service tool to help sales and non-technical people provide customers with initial configurations in 3 to 5 minutes. You may then send the configuration on for configuration help, or use in your existing ordering processes. If you require "custom" rack configuration or configuration for products not available in SCE, please contact Hewlett Packard Enterprise Customer Business Center or an Authorized Partner for assistance. <https://h22174.www2.hpe.com/SimplifiedConfig/Welcome>



Service and Support

HPE Services

No matter where you are in your digital transformation journey, you can count on HPE Services to deliver the expertise you need when, where and how you need it. From planning to deployment, ongoing operations and beyond, our experts can help you realize your digital ambitions.

<https://www.hpe.com/services>

Consulting Services

No matter where you are in your journey to hybrid cloud, experts can help you map out your next steps. From determining what workloads should live where, to handling governance and compliance, to managing costs, our experts can help you optimize your operations.

<https://www.hpe.com/services/consulting>

HPE Managed Services

HPE runs your IT operations, providing services that monitor, operate, and optimize your infrastructure and applications, delivered consistently and globally to give you unified control and let you focus on innovation.

[HPE Managed Services | HPE](#)

Operational services

Optimize your entire IT environment and drive innovation. Manage day-to-day IT operational tasks while freeing up valuable time and resources. Meet service-level targets and business objectives with features designed to drive better business outcomes.

<https://www.hpe.com/services/operational>

HPE Complete Care Service

HPE Complete Care Service is a modular, edge-to-cloud IT environment service designed to help optimize your entire IT environment and achieve agreed upon IT outcomes and business goals through a personalized experience. All delivered by an assigned team of HPE Services experts. HPE Complete Care Service provides:

- A complete coverage approach -- edge to cloud
- An assigned HPE team
- Modular and fully personalized engagement
- Enhanced Incident Management experience with priority access
- Digitally enabled and AI driven customer experience

<https://www.hpe.com/services/completecure>

HPE Tech Care Service

HPE Tech Care Service is the operational support service experience for HPE products. The service goes beyond traditional support by providing access to product specific experts, an AI driven digital experience, and general technical guidance to not only reduce risk but constantly search for ways to do things better. HPE Tech Care Service delivers a customer-centric, AI driven, and digitally enabled customer experience to move your business forward. HPE Tech Care Service is available in three response levels. Basic, which provides 9x5 business hour availability and a 2-hour response time. Essential which provides a 15-minute response time 24x7 for most enterprise level customers, and Critical which includes a 6-hour repair commitment where available and outage management response for severity 1 incidents.

<https://www.hpe.com/services/techcare>



Service and Support

HPE Lifecycle Services

HPE Lifecycle Services provide a variety of options to help maintain your HPE systems and solutions at all stages of the product lifecycle. A few popular examples include:

- Lifecycle Install and Startup Services: Various levels for physical installation and power on, remote access setup, installation and startup, and enhanced installation services with the operating system.
- HPE Firmware Update Analysis Service: Recommendations for firmware revision levels for selected HPE products, taking into account the relevant revision dependencies within your IT environment.
- HPE Firmware Update Implementation Service: Implementation of firmware updates for selected HPE server, storage, and solution products, taking into account the relevant revision dependencies within your IT environment.
- Implementation assistance services: Highly trained technical service specialists to assist you with a variety of activities, ranging from design, implementation, and platform deployment to consolidation, migration, project management, and onsite technical forums.
- HPE Service Credits: Access to prepaid services for flexibility to choose from a variety of specialized service activities, including assessments, performance maintenance reviews, firmware management, professional services, and operational best practices.

Notes: To review the list of Lifecycle Services available for your product go to:

<https://www.hpe.com/services/lifecycle>

For a list of the most frequently purchased services using service credits, see the [HPE Service Credits Menu](#)

Other Related Services from HPE Services:

HPE Education Services

Training and certification designed for IT and business professionals across all industries. Broad catalogue of course offerings to expand skills and proficiencies in topics ranging from cloud and cybersecurity to AI and DevOps. Create learning paths to expand proficiency in a specific subject. Schedule training in a way that works best for your business with flexible continuous learning options.

<https://www.hpe.com/services/training>

Defective Media Retention

An option available with HPE Complete Care Service and HPE Tech Care Service and applies only to Disk or eligible SSD/Flash Drives replaced by HPE due to malfunction.

Consult your HPE Sales Representative or Authorized Channel Partner of choice for any additional questions and services options.

Parts and Materials

HPE will provide HPE-supported replacement parts and materials necessary to maintain the covered hardware product in operating condition, including parts and materials for available and recommended engineering improvements.

Parts and components that have reached their maximum supported lifetime and/or the maximum usage limitations as set forth in the manufacturer's operating manual, product quick-specs, or the technical product data sheet will not be provided, repaired, or replaced as part of these services.

How to Purchase Services

Services are sold by Hewlett Packard Enterprise and Hewlett Packard Enterprise Authorized Service Partners:

- Services for customers purchasing from HPE or an enterprise reseller are quoted using HPE order configuration tools.
- Customers purchasing from a commercial reseller can find services at <https://ssc.hpe.com/portal/site/ssc/>



Service and Support

AI Powered and Digitally Enabled Support Experience

Achieve faster time to resolution with access to product-specific resources and expertise through a digital and data driven customer experience

Sign into the HPE Support Center experience, featuring streamlined self-serve case creation and management capabilities with inline knowledge recommendations. You will also find personalized task alerts and powerful troubleshooting support through an intelligent virtual agent with seamless transition when needed to a live support agent.

<https://support.hpe.com/hpesc/public/home/signin>

Consume IT On Your Terms

HPE GreenLake edge-to-cloud platform brings the cloud experience directly to your apps and data wherever they are—the edge, colocations, or your data center. It delivers cloud services for on-premises IT infrastructure specifically tailored to your most demanding workloads. With a pay-per-use, scalable, point-and-click self-service experience that is managed for you, HPE GreenLake edge-to-cloud platform accelerates digital transformation in a distributed, edge-to-cloud world.

- Get faster time to market
- Save on TCO, align costs to business
- Scale quickly, meet unpredictable demand
- Simplify IT operations across your data centers and clouds

To learn more about HPE Services, please contact your Hewlett Packard Enterprise sales representative or Hewlett Packard Enterprise Authorized Channel Partner. Contact information for a representative in your area can be found at "Contact HPE"

<https://www.hpe.com/us/en/contact-hpe.html>

For more information

<http://www.hpe.com/services>



Pre-configured Models

Pre-Configured models ship with the configurations below.

- Pre-Configured models ship with the configurations below. Options can be selected from the Core or Additional options section of this QuickSpecs.
- Hewlett Packard Enterprise does not allow factory integration of options into pre-configured models. Any additional options purchased will not be shipped inside the server.
- Network Choice models do not include embedded LOM.

SKU Number	P66781-B21 P66781-291	P66782-B21 P66782-291
Model Name	HPE ProLiant DL385 Gen11 9124 3.0GHz 16-core 1P 32GB-R 8SFF 800W PS Server	HPE ProLiant DL385 Gen11 9224 2.5GHz 24-core 1P 32GB-R 8SFF 800W PS Server
Chassis	HPE ProLiant DL385 Gen11 8SFF Configure-to-order Server	
Processor	9124 (16 core, 3.0 GHz, 200W)	9224 (24 core, 2.5 GHz, 200W)
Number of Processors	One with standard heatsink	
Memory	32 GB (1x32 GB , 4800 MT/s)	
Network Controller	Broadcom BCM5719 Ethernet 1Gb 4-port BASE-T OCP3 Adapter for HPE	Broadcom BCM57416 Ethernet 10Gb 2-port BASE-T OCP3 Adapter for HPE
Storage Controller	HPE MR408i-o Gen11 x8 Lanes 4GB Cache OCP SPDM Storage Controller	
Included Hard Drives	None ship standard, 8 SFF supported	
Optical Drive	None ship as standard	
Power Supply	1x HPE 800W Flex Slot Platinum Hot Plug Low Halogen Power Supply Kit	
Fans	6 Fans	
Rail Kit	HPE Easy Install Rail 2 Kit	



Pre-configured Models

SKU Number	P59705-421	P59706-421
Model Name	HPE ProLiant DL385 Gen11 9124 3.0GHz 16-core 1P 32GB-R 8SFF 1000W PS EU Server	HPE ProLiant DL385 Gen11 9224 2.5GHz 24-core 1P 32GB-R 8SFF 1000W PS EU Server
Chassis	HPE ProLiant DL385 Gen11 8SFF Configure-to-order Server	
Processor	9124 (16 core, 3.0 GHz, 200W)	9224 (24 core, 2.5 GHz, 200W)
Number of Processors	One with standard heatsink	
Memory	32 GB (1x32 GB , 4800 MT/s)	
Network Controller	Broadcom BCM5719 Ethernet 1Gb 4-port BASE-T OCP3 Adapter for HPE	Broadcom BCM57416 Ethernet 10Gb 2-port BASE-T OCP3 Adapter for HPE
Storage Controller	HPE MR408i-o Gen11 x8 Lanes 4GB Cache OCP SPDM Storage Controller	
Included Hard Drives	None ship standard, 8 SFF supported	
Optical Drive	None ship as standard	
Power Supply	1x HPE 1000W Flex Slot Titanium Hot Plug Power Supply Kit	
Fans	6 Fans	
Rail Kit	HPE Easy Install Rail 2 Kit	



Pre-configured Models

Smart Choice Models		
SKU Number	P75340-D65	P75346-DM5
Model Name	HPE ProLiant DL385 Gen11 9124 3.0GHz 16c 1P 64GB-R 8SFF MR408i-o 2x480GB SATA 2x800W RPS IN Server	HPE ProLiant DL385 Gen11 9124 3.0GHz 16c 1P 64GB-R 8SFF MR408i-o 2x960GB SSD 2x800W RPS LA Server
Chassis	HPE ProLiant DL385 Gen11 8SFF Configure-to-order Server	
Processor	9124 (16 core, 3.0 GHz, 200W)	
Number of Processors	One with standard heatsink	
Memory	64 GB (2x32 GB, 4800 MT/s)	
Network Controller	Broadcom BCM57416 Ethernet 10Gb 2-port BASE-T OCP3 Adapter for HPE	
Storage Controller	HPE MR408i-o Gen11 x8 Lanes 4GB Cache OCP SPDM Storage Controller	
Included Hard Drives	2x 480GB SATA SSD	2x 960GB SATA SSD
Power Supply	2x HPE 800W Flex Slot Platinum Hot Plug Low Halogen Power Supply Kit	
Fans	6x Standard Fans	
Rail Kit	HPE ProLiant DL3XX Gen11 Easy Install Rail 2 Kit	
Security	TPM (Trusted Platform Module)	

Country Code Key

- -B21 = Worldwide
- -291 = Japan
- -421 = Europe, the Middle East and Africa
- -D65 = HPE Smart Choice for India
- -DM5 = HPE Smart Choice for LATAM

HPE Smart Choice purchase program

- HPE Smart Choice purchase program is designed to make it easier to do business with HPE by offering fully configured solutions.
- Order popular configs in a single SKU.
- Get immediate purchase price in minutes.
- Get fast, predictable shipping.



Configuration Information

Smart Templates from HPE

HPE is releasing new Smart Template technology in the One Config Advanced (OCA) configurator. These Templates represent the CTO equivalents of the top-selling BTO configurations. They are intended to provide simple starting points to assist you in easily creating and customizing your desired Server solutions. HPE Servers that have Platform Templates, developed by HPE Product Managers, will have a separate tab in the HPE OCA configurator.

Workload Solutions Templates from HPE

The Workload Solutions Templates build on the Smart Templates technology to easily develop working configurations of the most compelling Workload Solutions. The templates complement the Reference Builds developed by HPE. Workload Solutions templates preconfigure some of the key architecture decisions and make it easier for Sellers to get started and complete a differentiated server solution for your customer's specific workload.

Mainstream SKUs

HPE launched the Mainstream SKU initiative as a market-driven approach to Demand Steering. It is a simplified portfolio of our top selling options that meet the current and future market trends. HPE has committed to provide a more predictable and faster experience for these options. Mainstream SKUs enjoy higher safety stock levels and have higher fulfillment service levels than non-Mainstream SKUs. Mainstream orders are fulfilled +30% faster than non-Mainstream orders, have fewer shortages and better recovery dates. This platform has Mainstream SKUs in the options portfolio, and is eligible for the improved Mainstream experience. Mainstream SKUs are designated with a Mainstream symbol in our configurators.

Mainstream Configurations

HPE is using the new Smart Templates technology to present Mainstream configurations. All the options in a Mainstream configuration are pre-selected Mainstream SKUs to optimize the performance, predictability and fulfillment experience. Check the Template section in our configurators for eligible Mainstream configurations.

European Union Erp Lot 9 Regulation

Beginning on January 1st, 2024, units sold into the European Union (EU), European Economic Area (EEA), the United Kingdom, or Switzerland must include more efficient AC power supplies: 94% for multi-output and 96% for single-output. HPE Flexible Slot power supplies are single-output, and part numbers 865438-B21, P03178-B21, and P44712-B21 are 96% efficient, thus meeting requirements.

HPE is on target to fulfil compliant systems ahead of time and will begin enforcing these requirements in advance to satisfy requests with the current power supplies by the set deadline.

This section lists some of the steps required to configure a Factory Integrated Model. To ensure only valid configurations are ordered, Hewlett Packard Enterprise recommends the use of an HPE approved configurator. Contact your local sales representative for information on configurable product offerings and requirements.

- Factory Integrated Models must start with a CTO Server.
 - FIO indicates that this option is only available as a factory installable option.
 - All Factory Integrated Models will be populated with sufficient hard drive blanks based on the number of initial hard drives ordered with the server.
 - Some options may not be integrated at the factory. Contact your local sales representative for additional information.
-

Configuration Information

Step 1: Base Configuration (choose one of the following configurable models)

CTO Server	HPE ProLiant DL385 Gen11 8SFF CTO Server	HPE ProLiant DL385 Gen11 8LFF CTO Server
SKU Number	P53921-B21	P53925-B21
Processor	Not included as standard	Not included as standard
DIMM Slots	24-DIMM slots*	24-DIMM slots*
Storage Controller	Choice of HPE OCP and PCIe plug-in controller	
PCIe	One standard in primary riser, up to eight slots with 2 processors	
Drive Cage - included	8 SFF	8 LFF
Network Controller	Choice of OCP or PCIe stand up card	
Fans	Not included as standard**	
Management	Default: HPE iLO Standard with Intelligent Provisioning, HPE OneView Standard (requires download), HPE GreenLake for Compute Ops Management (subscription included)	
USB	Front: 1 USB 3.1 Gen1 + iLO service port Rear: 2 USB 3.1 Gen1 Internal: 2 USB 3.1 Gen1	Front: 1 USB 3.1 Gen1 + iLO service port Rear: 2 USB 3.1 Gen1 Internal: 2 USB 3.1 Gen1

CTO Server	HPE ProLiant DL385 Gen11 12EDSFF CTO Server	HPE ProLiant DL385 Gen11 GPU CTO Server***	HPE ProLiant DL385 Gen11 48SFF CTO Server
SKU Number	P53929-B21	P54198-B21	P57844-B21
Processor	Not included as standard	Not included as standard	Not included as standard
DIMM Slots	24-DIMM slots*	24-DIMM slots*	24-DIMM slots*
Storage Controller	Not Supported	Not Supported	Choice of HPE OCP and PCIe plug-in controller
PCIe	One standard in primary riser, up to eight slots with 2 processors	Two standard in primary and secondary riser. Cannot support riser upgrade kits	Two standard in primary and secondary riser, up to eight slots with 2 processors
Drive Cage - included	12 EDSFF	N/A	6x 8SFF
Network Controller	Choice of OCP or PCIe stand up card		
Fans	Not included as standard**		
Management	Default: HPE iLO Standard with Intelligent Provisioning, HPE OneView Standard (requires download), HPE GreenLake for Compute Ops Management (subscription included)		
USB	Front: 1 USB 3.1 Gen1 + iLO service port Rear: 2 USB 3.1 Gen1 Internal: 2 USB 3.1 Gen1		

Notes:

- * 24 DIMM slots require selection of 2 processors.
- ** Fans should be selected separately depending on the configuration.
- *** To support Double Wide or Single Wide GPUs, the DL385 Gen11 GPU CTO Server must be selected. GPUs cannot be supported in rear PCIe slots for DL385 Gen11.
- HPE offers multiple Trade Agreement Act (TAA) compliant configurations to meet the needs of US Federal Government customers. These products are either manufactured or substantially transformed in a designated country. TAA compliance is only provided when HPE options are included as part of factory integrated orders (CTO).
- All CTO servers are Energy Star 3.0 compliant.

CTO Server	8 SFF CTO Chassis	8 LFF CTO Chassis
Included Drive Cage	None included as standard	8 LFF SAS/SATA
Universal Media Bay	Optional	Not available
ODD	Optional	Optional
4 LFF SAS/SATA Drive Cage	Not available	Up to 1 Additional
8 SFF SAS/SATA Drive Cage	Up to 3 Optional	Not available

Configuration Information

8 SFF SAS/SATA/NVMe (Mid-tray)	Up to 1 Optional	Not available
8 SFF NVMe U.3 Drive Cage	Up to 3 Optional	Not available
2 SFF SAS/SATA/NVMe (Stacked/Front)	Up to 1 Optional	Not available
2 SFF SATA/NVMe (Side-by-side/Front)	Not available	Up to 1 Optional
4 LFF SAS/SATA (Mid-tray)	Not available	Up to 1 Optional
4 LFF SAS/SATA (Rear)	Not available	Up to 1 Optional

Notes: This applies to CTO configurations, field upgrades may differ depending field configuration.

CTO Server	12 EDSFF CTO Chassis	GPU CTO Chassis	48SFF CTO Chassis
Included Drive Cage	12 EDSFF	None included as standard	6x 8SFF
Universal Media Bay	Not available	Not available	Not available
ODD	Not available	Not available	Not available
4 LFF SAS/SATA Drive Cage	Not available	Not available	Not available
8 SFF SAS/SATA Drive Cage	Not available	Not available	Not available
8 SFF SAS/SATA/NVMe (Mid-tray)	Not available	Not available	Not available
8 SFF NVMe U.3 Drive Cage	Not available	Up to 1 Optional	Not available
2 SFF SAS/SATA/NVMe (Stacked/Front)	Up to 1 Optional	Not available	Up to 1 Optional
2 SFF SATA/NVMe (Side-by-side/Front)	Not available	Not available	Not available
4 LFF SAS/SATA (Mid-tray)	Not available	Not available	Not available
4 LFF SAS/SATA (Rear)	Not available	Not available	Not available
12 EDSFF Drive Cage	Up to 2 Optional	Up to 1 Optional	Not available

Notes: This applies to CTO configurations, field upgrades may differ depending field configuration.

Backplane Types – Compatible Drive Type

	SATA	SAS	NVMe (U.3 Static)	NVMe (U.3 Dynamic)
4 LFF SAS/SATA BP	x	x	Not Supported	Not Supported
8 SFF SAS/SATA BP	x	x	Not Supported	Not Supported
8 SFF U.3 Tri-mode BP (Mid-tray)	x	x	x	x
8 SFF U.3 Tri-mode BP (Front)	x	x	x	x
2 SFF U.3 Tri-mode BP (Stacked/Front)	x	x	x	x

	SATA	SAS	NVMe (U.3 Static)	NVMe (U.3 Dynamic)
2 SFF U.3 Tri-mode BP (Side-by-side/Front)	x	x	x	x
4 LFF SAS/SATA BP (Mid-tray)	x	x	Not Supported	Not Supported
4 LFF SAS/SATA BP (Rear)	x	x	Not Supported	Not Supported

Step 2: Choose Required Options (only one of the following unless otherwise noted)

Please select one –B21 processor required below.

For second processor, please select the same processor model with –B21 from Core Options – HPE Processors section.

Notes:

- Mixing of 2 different processor models are NOT allowed. For example: first processor, select P53696-B21 then for second processor, select P53696-B21 as well.
- Processor kits don't include heat sink and fans.



Configuration Information

Step 2a: Choose Processors

Processor Option Kits

AMD EPYC 9124 3.0GHz 16-core 200W Processor for HPE	P53702-B21
AMD EPYC 9224 2.5GHz 24-core 200W Processor for HPE	P58540-B21
AMD EPYC 9254 2.9GHz 24-core 200W Processor for HPE	P53707-B21
AMD EPYC 9334 2.7GHz 32-core 210W Processor for HPE	P53712-B21
AMD EPYC 9354 3.25GHz 32-core 280W Processor for HPE	P53701-B21
AMD EPYC 9454 2.75GHz 48-core 290W Processor for HPE	P53708-B21
AMD EPYC 9534 2.45GHz 64-core 280W Processor for HPE	P53699-B21
AMD EPYC 9554 3.1GHz 64-core 360W Processor for HPE	P53700-B21
AMD EPYC 9634 2.25GHz 84-core 290W Processor for HPE	P53705-B21
AMD EPYC 9654 2.4GHz 96-core 360W Processor for HPE	P53696-B21
AMD EPYC 9734 2.2GHz 112-core 340W Processor for HPE	P60465-B21
AMD EPYC 9754 2.25GHz 128-core 360W Processor for HPE	P60463-B21
AMD EPYC 9174F 4.1GHz 16-core 320W Processor for HPE	P53698-B21
AMD EPYC 9274F 4.05GHz 24-core 320W Processor for HPE	P53711-B21
AMD EPYC 9374F 3.85GHz 32-core 320W Processor for HPE	P53710-B21
AMD EPYC 9474F 3.6GHz 48-core 360W Processor for HPE	P53706-B21
AMD EPYC 9184X 3.55GHz 16-core 320W Processor for HPE	P63491-B21
AMD EPYC 9384X 3.1GHz 32-core 320W Processor for HPE	P63492-B21
AMD EPYC 9684X 2.55GHz 96-core 400W Processor for HPE	P63493-B21

Notes:

- For processors less than 240W, standard heatsink and standard fan kit are required. User is allowed to change to performance/max performance heatsink and performance fan kit
- If Processor wattage is above 240W and below 300W then High Performance Heat Sink and High Performance fan kit must be selected
- If Processor wattage is above 300W then Maximum Performance HS and Max Performance fan kit must be selected
- If Processor is above 300W then Mid Cage cannot be selected

Step 2b: Choose Memory Options

Please select one or more memory from below.

For new Gen11 memory population rule whitepaper and optimal memory performance guidelines, please go to:

<https://www.hpe.com/psnow/doc/a50007481enw>

For additional information, please see the [HPE DDR5 Smart Memory QuickSpecs](#).

For Gen11 memory speed table, please go to: [Server memory population rules for HPE ProLiant Gen11 servers with AMD EPYC 9004 series processors](#)

Notes:

- Memory DIMM availability with a server platform is dependent upon completion of certification testing.
- The maximum memory speed is a function of the memory type, memory configuration, and processor model.
- System may throttle if ambient temp. is over 30C.
- Memory compatibility may vary or be limited within a specific server family depending upon the specific configuration being requested. Because each server environment and requirements can vary, memory compatibility is based not only upon the server family, but may also be affected by the amount and type of additional hardware options installed within a specific server configuration. For this reason, some HPE memory DIMMs may be qualified for a server model or family and yet occasionally not be supported with limited configurations within that server family. Please consult with the HPE server Quickspecs or your HPE representative if you have any questions regarding memory compatibility with a specific HPE server configuration.



Configuration Information

Registered DIMMs (RDIMMs)

HPE 16GB (1x16GB) Single Rank x8 DDR5-4800 CAS-40-39-39 EC8 Registered Smart Memory Kit	P50309-B21
HPE 32GB (1x32GB) Single Rank x4 DDR5-4800 CAS-40-39-39 EC8 Registered Smart Memory Kit	P50310-B21
HPE 32GB (1x32GB) Dual Rank x8 DDR5-4800 CAS-40-39-39 EC8 Registered Smart Memory Kit	P50311-B21
HPE 64GB (1x64GB) Dual Rank x4 DDR5-4800 CAS-40-39-39 EC8 Registered Smart Memory Kit	P50312-B21
HPE 96GB (1x96GB) Dual Rank x4 DDR5-4800 CAS-46-45-45 EC8 Registered Smart Memory Kit	P66676-B21
HPE 128GB (1x128GB) Dual Rank x4 DDR5-4800 CAS-40-39-39 EC8 Registered Smart Memory Kit	P69982-B21
HPE 128GB (1x128GB) Quad Rank x4 DDR5-4800 CAS-46-39-39 EC8 Registered 3DS Smart Memory Kit	P50313-B21
HPE 256GB (1x256GB) Octal Rank x4 DDR5-4800 CAS-46-39-39 EC8 Registered 3DS Smart Memory Kit	P50314-B21

Notes:

- The new 128GB 2Rx4 RDIMM (P69982-B21) is not a 3DS DIMM
- Server system can support 24x of this 256GB DDR5 4800 MT/s DIMMs even with processors >300W, if below components are configured:
 - o P57886-B21/ HPE DL385 G11 2U Std/Perf FIO Baffle Kit
 - o P58459-B21/ HPE DL3X5 Gen11 Perf 2U Heat Sink Kit
- Mixing of x4 & x8 memory is not allowed
- Mixing of Non-3DS and 3DS DIMMs is not allowed
- 256GB DIMM requires Q'ty 6 of Performance Fans
- When Direct Liquid Cooling (DLC) is configured, there will be no configuration restriction with 256GB DIMMs and ambient temperature can be maintained at 35C
- When processor cTDP >= 300W, and server front-end configurations are any of 24SFF, 12LFF, 36EDSFF, 48SFF or GPU, and 256GB DIMMs q'ty is more than 12 then below NIC cards cannot be selected due to thermal:
 - o P31324-B21/ HPE IB HDR/EN 200Gb 2p QSFP56 Adptr
 - o P45641-B21/ HPE IB NDR 1p OSFP MCX75310AAS Adptr
 - o P45642-B21/ HPE IB NDR200 1p OSFP MCX75310AAS Adptr
 - o P26269-B21/ BCM 57504 10/25GbE 4p SFP28 OCP3 Adptr
 - o P22767-B21/ INT E810 100GbE 2p QSFP28 OCP3 Adptr
 - o P31323-B21/ HPE IB HDR/EN 200Gb 1p QSFP56 OCP3 Adptr
 - o P31348-B21/ HPE IB HDR/EN 200Gb 2p QSFP56 OCP3 Adptr
- 256GB DIMM might impose more configuration restrictions due to its high profile thermal condition. Refer to the HPE configurator tool for detailed instructions
- For more detailed information regarding memory population rules, please visit <https://www.hpe.com/docs/server-memory>



Configuration Information

Thermal Support Matrix – Processors

DL385 Gen11 Config.							
Front Cage	Mid Cage	Rear Cage	CPU TDP	Supported Ambient Temp.	Fan Type	Heatsink Type	Boot Device – NS204i-u
8 LFF	N/A	2SFF or PCIe cards	210W and below	30C	STD Fan X6 (P58464-B21)	2U STD HS (P58458-B21)	30C
12 LFF	N/A	2SFF or PCIe cards	210W and below	30C	Perf Fan X6 (P58465-B21)	2U PERF HS (P58459-B21)	
12 LFF	N/A	2SFF or PCIe cards	260W – 290W	30C	Perf Fan X6 (P58465-B21)	2U PERF HS (P58459-B21)	
8 LFF	N/A	2SFF or PCIe cards	320W – 400W	30C	Perf Fan X6 (P58465-B21)	2U Max PERF HS (P58460-B21)	



Configuration Information

DL385 Gen11 Config.							
Front Cage	Mid Cage	Rear Cage	CPU TDP	Supported Ambient Temp.	Fan Type	Heatsink Type	Boot Device – NS204i-u
12 LFF	N/A	2SFF or PCIe cards	320W – 400W	Ta=25C	Perf Fan X6 (P58465-B21)	2U Max PERF HS (P58460-B21)	30C
12 LFF	N/A	2SFF or PCIe cards	All	30C	Perf Fan X6 (P58465-B21)	DLC*	
12 LFF	N/A	4 LFF	210W and below	30C	Perf Fan X6 (P58465-B21)	2U PERF HS (P58459-B21)	
12 LFF	N/A	4 LFF	260W – 290W	30C	Perf Fan X6 (P58465-B21)	2U PERF HS (P58459-B21)	
12 LFF	4 LFF	2SFF or PCIe cards	260W – 290W	30C	Perf Fan X6 (P58465-B21)	1U PERF HS (Included in mid cage kit)	
12 LFF	4 LFF	4 LFF	210W and below	30C	Perf Fan X6 (P58465-B21)	1U PERF HS (Included in mid cage kit)	
12 LFF	4 LFF	4 LFF	260W – 290W	Ta=25C	Perf Fan X6 (P58465-B21)	1U PERF HS (Included in mid cage kit)	
12 LFF	4 LFF	4 LFF	320W – 400W	30C	Perf Fan X6 (P58465-B21)	DLC*	
16 SFF	N/A	2SFF or PCIe cards	210W and below	30C	STD Fan X6 (P58464-B21)	2U STD HS (P58458-B21)	
24 SFF		2SFF or PCIe cards	210W and below	30C	Perf Fan X6 (P58465-B21)	2U PERF HS (P58459-B21)	
24 SFF		2SFF or PCIe cards	260W – 290W	30C	Perf Fan X6 (P58465-B21)	2U PERF HS (P58459-B21)	
24 SFF		2SFF or PCIe cards	320W – 400W	30C	Perf Fan X6 (P58465-B21)	DLC*	
24 SFF		2SFF or PCIe cards	320W – 400W	30C	Perf Fan X6 (P58465-B21)	2U Max PERF HS (P58460-B21)	
24 SFF		8 SFF	2SFF or PCIe cards	260W – 290W	30C	Perf Fan X6 (P58465-B21)	
24 SFF		8 SFF	2SFF or PCIe cards	320W – 400W	30C	Perf Fan X6 (P58465-B21)	DLC*



Configuration Information

DL385 Gen11 Config.							
Front Cage	Mid Cage	Rear Cage	CPU TDP	Supported Ambient Temp.	Fan Type	Heatsink Type	Boot Device – NS204i-u
EDSFF	N/A	N/A	210W and below	30C	Perf Fan X6 (P58465-B21)	2U PERF HS (P58459-B21)	30C
	N/A	N/A	260W – 290W	30C	Perf Fan X6	2U PERF HS (P58459-B21)	
	N/A	N/A	320W – 400W	30C	Perf Fan X6 (P58465-B21)	2U Max PERF HS (P58460-B21)	
EDSFF	N/A	N/A	All	30C	Perf Fan X6 (P58465-B21)	DLC*	
GPU	N/A	N/A	210W and below	30C	Perf Fan X6 (P58465-B21)	2U PERF HS (P58459-B21)	
	N/A	N/A	260W – 290W	30C	Perf Fan X6 (P58465-B21)	2U PERF HS (P58459-B21)	
	N/A	N/A	320W – 400W	30C	Perf Fan X6 (P58465-B21)	2U Max PERF HS (P58460-B21)	
GPU	N/A	N/A	All	30C	Perf Fan X6 (P58465-B21)	DLC*	
48 SFF	N/A	N/A	210W and below	30C	Perf Fan X6 (P58465-B21)	2U PERF HS (P58459-B21)	
	N/A	N/A	260W – 290W	30C	Perf Fan X6 (P58465-B21)	2U PERF HS (P58459-B21)	
	N/A	N/A	320W – 400W	30C	Perf Fan X6 (P58465-B21)	2U Max PERF HS (P58460-B21)	
48 SFF	N/A	N/A	All	30C	Perf Fan X6 (P58465-B21)	DLC*	

Notes: *- For DLC, depending on your rear I/O requirement you can select either one of below kits which supports different tubing outlet locations

- If you need one more PCIe slot and don't require NS204i-u, we recommend you to select P62032-B21

- If you need NS204i-u and don't necessarily need one more PCIe slot, we recommend you to select P62035-B21



Configuration Information

Thermal Support Matrix – 256GB Memory

DL385 Gen11 Front Ends	CPU TDP	256GB Memory Max. Quantity	Supported Ambient Temp.
8LFF	≤290W	24	25C
	>290W	8	
	>290W	24*	
12LFF	≤290W	24	25C
	>290W	8	
	>290W	24*	
8SFF	≤290W	24	25C
	>290W	16	
	>290W	24*	
16SFF	≤290W	24	25C
24SFF	>290W	8	25C
	≤290W	24	
12EDSFF	>290W	8	25C
	≤290W	24	
	>290W	24*	
24EDSFF	>290W	8	25C
	≤290W	24	
36EDSFF	>290W	8	25C
	≤290W	24	
GPU CTO Svr	>290W	8	25C
	≤290W	8	
48SFF CTO Svr	>290W	8	25C
	≤290W	8	
All front ends + DLC	All CPU types	24	25C

Notes: * For the configs that have CPU TDP >290W and fully populated 256GB DIMMs (24), please select P57886-B21 Standard/ Performance Air Baffle Kit and P58459-B21 Performance 2U Heatsink Kit

Step 2c: Choose Power Supplies

Select one or two power supplies from below.

Notes: Mixing of 2 different power supplies is NOT allowed.

HPE Flex Slot Power Supplies

HPE 1800W-2200W Flex Slot Titanium Hot Plug Power Supply Kit	P44712-B21
HPE 1600W Flex Slot Platinum Hot Plug Low Halogen Power Supply Kit	P38997-B21
HPE 1600W Flex Slot -48VDC Hot Plug Power Supply Kit	P17023-B21
HPE 1000W Flex Slot Titanium Hot Plug Power Supply Kit	P03178-B21
HPE 800W Flex Slot Platinum Hot Plug Low Halogen Power Supply Kit	P38995-B21

Notes:

- Mixing of different Power Supply SKU is not allowed
- 1600W -48VDC PSU requires 1x HPE 1600W DC PSU power lug option kit or HPE 1600W DC PSU Power Cable Kit
- Prior to making a power supply selection it is highly recommended that the HPE Power Advisor is run to determine the right size power supply for your server configuration. The HPE Power Advisor is located at: <http://www.hpe.com/info/poweradvisor>.
- HPE ProLiant servers ship with an IEC-IEC power cord used for rack mounting with Power Distribution Units (PDUs). Visit [HPE power cords](#) for a full list of optional power cords.



Configuration Information

Step 2d: Choose Backplane

Notes:

- Select up to 3x front cage/ 1x mid cage/ 1x rear cage (8SFF chassis); 1x additional front cage/ 1x mid cage/ 1x rear cage (8LFF chassis)
- In this generation of DL385, backplane power cables need to be selected separately. Part number and notes describes below

HPE ProLiant DL385 Gen11 SFF Backplane Power Cable Kit P57845-B21

Notes: If Front 8SFF Drive cage is selected Qty above one then SFF Backplane Power Cable Kit must be selected

HPE ProLiant DL385 Gen11 8SFF Tri-Mode U.3 x1 BC Backplane Kit P55082-B21

Notes:

- x1 U.3 8SFF Drive cage can support SAS/SATA and U.3 NVMe drives
- Backplane power cable kit needs to be selected to support this backplane
- Configurable up to 3
- OROC and PCIe controllers support this backplane. OROC x1 or PCIe x1 cable kit selection is needed for controller support
- Mixture of x1 U.3 8SFF and x4 U.3 8SFF backplanes is ALLOWED
- X4 U.3 8SFF mid cage cannot be supported if x1 U.3 8SFF is supported
- Mid cage cannot be supported if server has mixture of x1 U.3 8SFF and x4 U.3 8SFF backplanes

HPE ProLiant DL385 Gen11 8SFF Tri-Mode U.3 x4 BC Backplane Kit P55083-B21

Notes:

- X4 U.3 8SFF Drive cage can support NVMe and SAS/SATA drives
- Backplane power cable kit needs to be selected to support this backplane
- Configurable up to 3
- OROC and PCIe controllers support this backplane. OROC x2/x4 or PCIe x2/x4 cable kit selection is needed for controller support
- Mixture of x1 U.3 8SFF and x4 U.3 8SFF backplanes is ALLOWED
- Mid cage cannot be supported if server has mixture of x1 U.3 8SFF and x4 U.3 8SFF backplanes

HPE ProLiant DL385 Gen11 4LFF SAS/SATA Mid Tray Backplane Kit P55085-B21

Notes:

- This cage kit can only be supported with 8LFF chassis
- This mid cage only allows OROC controllers for controller support. If no controller selected, server can support up to 16x LFF SAS/SATA direct attach with 12 from front cages and 4 from the mid cage
- Two 1U Processor Heatsinks are included in the mid cage kit

HPE ProLiant DL385 Gen11 8SFF Tri-Mode U.3 x1 Mid Tray Backplane Kit P55086-B21

Notes:

- This cage kit can only be supported with 8SFF chassis
- This cage kit can support SAS/SATA and U.3 NVMe drives
- Mid cage cannot be supported if server has mixture of x1 U.3 8SFF and x4 U.3 8SFF backplanes
- 8SFF x1 U.3 mid cage and 8SFF x4 U.3 front cage cannot mix
- Two 1U Processor Heatsinks are included in the mid cage kit

HPE ProLiant DL385 Gen11 8SFF Tri-Mode U.3 x4 Mid Tray Backplane Kit P55087-B21

Notes:

- This cage kit can only be supported with 8SFF chassis
- Mid cage cannot be supported if server has mixture of x1 U.3 8SFF and x4 U.3 8SFF backplanes
- 8SFF x4 U.3 mid cage and 8SFF x1 U.3 front cage cannot mix
- Two 1U Processor Heatsinks are included in the mid cage kit



Configuration Information

HPE ProLiant DL385 Gen11 4LFF SAS/SATA Front FIO Drive Cage Kit P55089-B21

Notes:

- This cage kit can only be supported with 8LFF chassis. Installed on drive cage Box1, it adds front 8LFF to 12LFF
- This cage only allows OROC controllers for controller support. If no controller selected, server can support up to 16x LFF SAS/SATA direct attach with 12 from front cages and 4 from the mid cage
- If this cage is selected, ODD/DP Enablement Kit cannot be selected

HPE ProLiant DL385 Gen11 4LFF SAS/SATA Rear FIO Backplane Kit P55088-B21

Notes:

- This cage kit can only be supported with 8LFF chassis
- Maximum LFF drive count is 20x LFF when 12LFF front + 4LFF mid + 4LFF rear is configured
- If 4LFF Rear drive cage is selected then 2SFF TM U.3 x4 BC Frnt/Rear Kit cannot be selected in the Tertiary location
- When this drive cage is selected, then Primary upgrade riser, Secondary upgrade Risers kit, Tertiary Riser or 1 x16 2U Secondary Riser Kit cannot be selected

HPE ProLiant DL385 Gen11 2SFF Tri-Mode U.3 x4 BC Front/Tertiary Drive Cage Kit P55091-B21

Notes:

- This cage kit can be supported in the 8SFF Universal Media Bay or rear Tertiary position
- Only Tri-mode controller is supported with this cage kit. No direct attach

HPE ProLiant DL385 Gen11 2SFF Tri-Mode U.3 x4 BC Side-by-Side Drive Cage Kit P55093-B21

Notes:

- This cage kit can only be supported with 8LFF chassis on LFF Box1 position. Therefore when this is configured, 4LFF front cage cannot be supported
- Only Tri-mode controller is supported with this cage kit. No direct attach

HPE ProLiant DL3X5 Gen11 SFF Universal Media Bay Kit P57857-B21

Notes:

- Can only be supported with 8SFF chassis
- This kit is required to support ODD with SFF configurations
- 2SFF x4 Tri-Mode cage kit is supported with selection of this UMB kit
- When the SFF UMB kit is selected and ODD is also in the configuration, the DL385 Gen11 ODD/DP enablement kit (P57889-B21) should also be selected

HPE ProLiant DL3X5 Gen11 GPU 8SFF U.3 FIO Backplane Kit P57867-B21

Notes:

- Can only be supported with GPU CTO chassis
- Maximum quantity is one
- Only NVMe drives through direct attach are supported with this backplane and the GPU CTO chassis

HPE ProLiant DL3X5 Gen11 GPU EDSFF FIO Backplane Kit P62355-B21

Notes:

- Can only be supported with GPU CTO chassis
- Maximum quantity is one
- Only EDSFF E3.S 1T drives through direct attach are supported with this backplane and the GPU CTO chassis

Step 3: Choose Additional Factory Integratable Options

One of the following from each list may be selected if desired at time of factory integration

HPE ProLiant DL385 Gen11 8NVMe U.3 2P Balanced FIO Bundle Kit P59754-B21

HPE ProLiant DL385 Gen11 8NVMe U.3 1P Direct FIO Bundle Kit P59755-B21



Configuration Information

HPE ProLiant DL385 Gen11 16NVMe U.3 2P Balanced FIO Kit	P59756-B21
HPE ProLiant DL385 Gen11 24NVMe U.3 2P Balanced FIO Kit	P59875-B21
HPE ProLiant DL385 Gen11 24EDSFF x4 Direct Attach FIO Enablement Kit	P57873-B21
HPE ProLiant DL385 Gen11 32EDSFF x4 Direct Attach FIO Enablement Kit	P57871-B21
Notes: When the 32EDSFF x4 DA FIO Kit is configured, no OCP card can be supported because this FIO Kit includes two OCP re-timer cards which provide PCIe lanes for EDSFF drives.	
HPE ProLiant DL385 Gen11 36EDSFF x2 Direct Attach FIO Enablement Kit	P57874-B21
HPE ProLiant DL385 Gen11 System Insight Display Kit	P57895-B21

HPE Security Options

HPE Trusted Supply Chain for HPE ProLiant	P36394-B21
HPE Trusted Supply Chain E-LTU	R6X85AAE

Notes:

- Intrusion Cable Kit (P48922-B21) must be selected with then Trusted Supply Chain Config
- If Trusted Supply Chain section is selected, only one instance of the HPE Trusted Supply Chain E-LTU software option is required per order (not per server)

Step 4: Choose additional options for Factory Integration from Core and Additional Options sections below



Core Options

Some options may not be integrated at the factory. To ensure only valid configurations are ordered, Hewlett Packard Enterprise recommends the use of an HPE approved configurator. Contact your local sales representative for additional information.

HPE Unique Options

Riser Kits

The CTO or BTO server has 1x Primary riser (slot3) by default. Here are the additional risers available to select:

HPE ProLiant DL385 Gen11 x16/x16 Primary FIO Upgrade Riser Kit P57890-B21

Notes:

- This provides Slot1 and Slot2 in the Primary position
- Cannot be selected if 4LFF rear cage is selected

HPE ProLiant DL385 Gen11 x16 2U Secondary Riser Kit P55097-B21

Notes:

- This provides Slot6 in the Secondary position
- This requires the 2nd processor
- This riser kit is required to select the 2x16 Secondary Riser Upgrade Kit

HPE ProLiant DL385 Gen11 x16 Slot 5 Secondary Upgrade Riser Kit P68392-B21

Notes:

- This provides Slot5 in the Secondary position
- This requires the 2nd processor
- This riser provides the 3rd PCIe slot for the GPU CTO Server
- This riser provides support flexibility by adding only one Secondary riser on top of Slot 6. Whereas P57891-B21 provides two additional Secondary risers.
- This riser kit cannot be supported with P57849-B21 x16 OCP1 OCP2 2P Upgrade Kit

HPE ProLiant DL385 Gen11 x16/x16 Secondary Upgrade Riser Kit P57891-B21

Notes:

- This provides Slot4 and Slot5 in the Secondary position
- This requires the 2nd processor
- To select this kit, the 1x16 Secondary Riser Kit is required
- This riser kit cannot be supported with P57849-B21 x16 OCP1 OCP2 2P Upgrade Kit

HPE ProLiant DL385 Gen11 2x16 Tertiary Riser FIO Kit P57893-B21

Notes:

- This provides Slot7 and Slot8 in the Tertiary position
- This requires the 2nd processor

HPE ProLiant DL385 Gen11 x16 Primary FIO Riser Kit for LFF Rear Cage P55098-B21

Notes:

- This provides one Primary riser positioned below the 4LFF rear cage when it is configured
- When the 4LFF rear cage is configured, only one Primary riser is supported

HPE ProLiant DL385 Gen11 1x16 Secondary Riser FIO Kit for 4LFF rear cage P57892-B21

Notes:

- This provides one Secondary riser positioned below the 4LFF rear cage when it is configured
- When the 4LFF rear cage is configured, only one Secondary riser is supported

HPE ProLiant DL385 Gen11 x16 Low Profile Secondary Riser Kit P59260-B21

Notes:

- This provides one Secondary riser positioned below the 4LFF rear cage when it is configured
- This riser kit is required when NS204i-u NVMe Boot Device is selected along with 4LFF rear cage selection



Core Options

Cooling Options

Air-Cooled Solutions

HPE ProLiant DL3X5 Gen11 2U Standard Heat Sink Kit P58458-B21

HPE ProLiant DL3X5 Gen11 2U Performance Heat Sink Kit P58459-B21

Notes: When Standard or Performance 2U Heat Sink Kit is selected, Standard/Perf Air Baffle Kit is required

HPE ProLiant DL3X5 Gen11 Max Performance 2U Heat Sink Kit P58460-B21

Notes: When Maximum Performance 2U Heat Sink Kit is selected, Hi-Perf Air Baffle Kit is required

Direct Liquid Cooling (DLC) Solutions

HPE ProLiant DL3X5 Gen11 Direct Liquid Cooling Cold Plate Module FIO Kit From Boot Device P62032-B21

HPE ProLiant DL3X5 Gen11 Direct Liquid Cooling Cold Plate Module FIO Kit From PCIe P62035-B21

HPE ProLiant DL3XX Gen11 Direct Liquid Cooling 55cm Quick Disconnect Tube Set FIO Kit P62042-B21

HPE ProLiant Direct Liquid Cooling 450mm Female-Male Connection Quick Disconnect Tube Set FIO Kit P62046-B21

Notes:

- When DLC is configured, most of the configurations can be supported at 35C ambient temperature
- When server is configured as a liquid cooling system, the server can only be shipped to customer within the whole rack. The rack would include a HPE Rack, Liquid Cooling Manifold, CDU, Primary & Secondary Hose kits and servers with DLC CPM module kits and QD Tube Set kits installed
- If DLC Module is selected then 2 processor must be selected
- If DLC Module is selected with server and the server is not standalone then only below racks are allowed in the configuration:
 - o Rack 42U 800mm x 1200mm Ent G2
 - o Rack 48U 800mm x 1200mm Ent G2
- If P62032-B21 is selected with 4LFF rear cage in the configuration, then NS204i-u Gen11 Ht Plg Boot Option Dev cannot be selected
- If DLC Module is selected with LFF CTO Server or 8SFF CTO Server or EDSFF CTO Server then 55cm Tube Kit must be selected
- If DLC Module is selected with GPU CTO Server or 48SFF CTO Server then 45cm Tube kit must be selected
- If DLC Module is selected then Standard Heat Sink or Perf Heat Sink or Max Perf Heat Sink cannot be selected
- DLC Modules only support the 2U Standard/Performance Air Baffle Kit, 2U High Perf Air Baffle Kit cannot be supported
- If DLC Module is selected then Performance Fan kit must be selected

Fan Kits and Air Baffle Kits

HPE ProLiant DL3X5 Gen11 2U Standard Fan Kit P58464-B21

HPE ProLiant DL3X5 Gen11 2U Performance Fan Kit P58465-B21

Notes:

- Gen11 Fan Kits contain only 1 fan
- 1-socket config 6 Standard Fan kits, 2-socket config needs 6 Standard Fan kits
- 1-socket config 4 Performance Fan kits, 2-socket config needs 6 Performance Fan kits

HPE ProLiant DL385 Gen11 2U Standard/Performance FIO Air Baffle Kit P57886-B21

HPE ProLiant DL385 Gen11 2U High Performance FIO Air Baffle Kit P57887-B21

Notes:

- Air Baffles cannot be configured if mid cages are configured
- Refer to OCA for Air Baffle configuration rules
- When Standard or Performance 2U Heat Sink Kit is selected, Standard/Perf Air Baffle Kit is required
- When Maximum Performance 2U Heat Sink Kit is selected, Hi-Perf Air Baffle Kit is required



Core Options

Cooling options summary

CPU cTDP	= < 240W (8LFF and 8/16SFF)	240W – 320W	= > 320 W
Heatsink	Standard 2U H/S	Performance 2U H/S	Max Performance 2U H/S
Fans	Standard Fans	Performance Fans	Performance Fans

HPE Boot Controllers

HPE NS204i-u Gen11 NVMe Hot Plug Boot Optimized Storage Device	P48183-B21
HPE ProLiant DL3X5 Gen11 NS204i-u NVMe Hot Plug Boot Device Cable Kit	P57013-B21
HPE ProLiant DL3X5 Gen11 Tertiary NS204i-u NVMe Hot Plug Boot Device Enablement Kit	P57850-B21
HPE ProLiant DL3X5 Gen11 Secondary NS204i-u NVMe Hot Plug Boot Device Enablement Kit	P57885-B21

Notes:

- NS204i-u is the HPE Gen11 Hot Pluggable M.2 NVMe RAIDed Boot Device
- HPE DL3X5 Gen11 NS204i-u NVMe Boot Cable Kit is required when the NS204i-u boot device is configured along with the 4LFF rear cage
- If HPE DL3X5 Gen11 Tertiary NS204i-u Enablement Kit is configured, then Tertiary riser kit cannot be selected
- If HPE DL3X5 Gen11 Secondary NS204i-u Enablement Kit is configured, then 2x16 Secondary Upgrade Riser Kit cannot be selected

HPE Optical Drives

HPE ProLiant DL385 Gen11 LFF ODD/Display Port Enablement Kit	P57889-B21
Notes: This kit is supportable only for LFF chassis media bays	
HPE ProLiant DL385 Gen11 Optical Disk Drive Cable Kit	P63519-B21
Notes: This kit is supportable only for SFF chassis media bays	
HPE 9.5mm SATA DVD-ROM Optical Drive	726536-B21
HPE 9.5mm SATA DVD-RW Optical Drive	726537-B21
HPE Mobile USB DVD-RW Optical Drive	701498-B21

Notes:

- Maximum 1 Optical Drive is supported
- ODD needs Universal Media Bay for 8SFF CTO Server

Software as a Service Management

HPE GreenLake for Compute Ops Management

Base SKU

HPE GreenLake for Compute Ops Management Enhanced 3-year Upfront ProLiant SaaS	R7A11AAE
--	----------

Upgrade SKUS

HPE GreenLake for Compute Ops Management Enhanced 1-year Upfront ProLiant SaaS	R7A10AAE
HPE GreenLake for Compute Ops Management Enhanced 5-year Upfront ProLiant SaaS	R7A12AAE

HPE OneView

HPE OneView including 3yr 24x7 Support Flexible Quantity E-LTU	E5Y35AAE
HPE OneView w/o iLO including 3yr 24x7 Support Flexible Quantity E-LTU	P8B26AAE

Notes: For customers purchasing HPE GreenLake for Compute Ops Management, without a hardware purchase or a BTO purchase, use this base SKU within ASQ order:



Core Options

HPE GreenLake for Compute Ops Management Base SaaS

R6Z73AAE

For more information, visit the HPE GreenLake for Compute Ops Management QuickSpecs:

<https://www.hpe.com/psnow/doc/a50004263enw>

Supported Servers – CTO only. No OEM. – Complete list can be found here: Latest Supported Server List:

<https://www.hpe.com/info/com-supported-servers>

HPE Storage Controllers

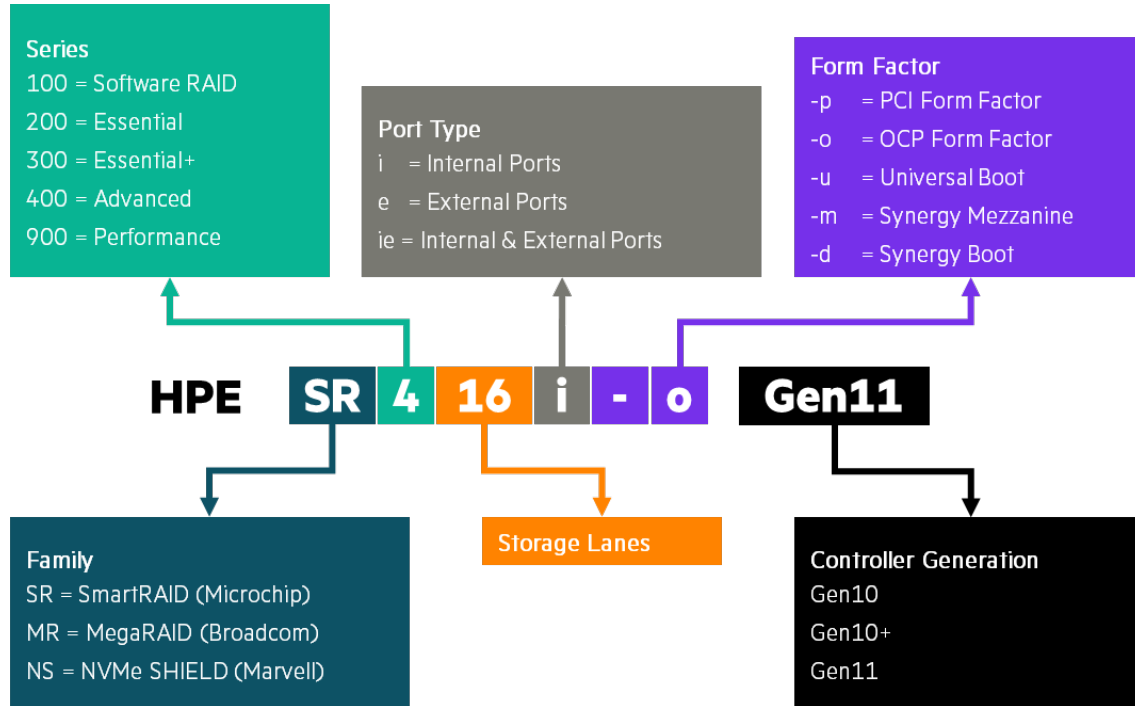

Notes:

- When selecting SR RAID controllers for external storage (E208e, 804398-B21) and MR RAID controllers for internal storage (MR216i/MR416i/MR408i) in the order, please be aware these two products use different RAID configuration tools. HPSSA (HP SR Storage Administrator) is only supported on SR (SmartRAID) controllers. MR (MegaRAID) controllers will support a different tool named MR Storage Administrator
- Not supporting mixing of MR (MegaRAID) series internal controllers and SR (SmartRAID) series internal controllers
- MR (MegaRAID) series controllers are not supported with Intelligent Provisioning feature
- For more information on the HPE Gen11 Storage Controller, please refer to:

[HPE Compute MR Gen11 Controllers Quick Specs](#)

[HPE Compute SR Gen11 Controllers Quick Specs](#)



Core Options

Essential RAID Controllers

HPE Smart Array E208e-p SR Gen10 (8 External Lanes/No Cache) 12G SAS PCIe Plug-in Controller 804398-B21

Notes:

- This controller supports up to 8 SAS/SATA Drives (external)
- Controller Based Encryption (CBE) with a remote key management server is not supported. Local key management (LKM) is supported
- One Button Secure Erase (OBSE) used to sanitize drives and factory reset the controller is not supported
- For more information on the HPE Smart Array E208i-p SR Gen10 Controller, please refer to the

[QuickSpecs](#)

Tri-mode RAID Controllers

HPE MR216i-o Gen11 x16 Lanes without Cache OCP SPDM Storage Controller P47789-B21

Notes:

- This is an OROC type controller which takes up an OCP slot
- This controller supports up to 16 SAS/SATA/NVMe Drives (Only 4 x4 NVMe drives can be supported; 8 x2 NVMe drives can be supported)

HPE MR408i-o Gen11 x8 Lanes 4GB Cache OCP SPDM Storage Controller P58335-B21

Notes:

- This is an OROC type controller which takes up an OCP slot
- This controller supports up to 8 SAS/SATA/NVMe Drives (Only 2 x4 NVMe drives can be supported; 4 x2 NVMe drives can be supported)

HPE MR416i-o Gen11 x16 Lanes 8GB Cache OCP SPDM Storage Controller P47781-B21

Notes:

- This is an OROC type controller which takes up an OCP slot
- This controller supports up to 16 SAS/SATA/NVMe Drives (Only 4 x4 NVMe drives can be supported; 8 x2 NVMe drives can be supported)

HPE MR216i-p Gen11 x16 Lanes without Cache PCI SPDM Plug-in Storage Controller P47785-B21

Notes:

- This is an PCIe type controller which takes up a PCIe slot
- This controller supports up to 16 SAS/SATA/NVMe Drives (Only 4 x4 NVMe drives can be supported; 8 x2 NVMe drives can be supported)

HPE MR416i-p Gen11 x16 Lanes 8GB Cache PCI SPDM Plug-in Storage Controller P47777-B21

Notes:

- This is an PCIe type controller which takes up a PCIe slot
- This controller supports up to 16 SAS/SATA/NVMe Drives (Only 4 x4 NVMe drives can be supported; 8 x2 NVMe drives can be supported)

HPE SR932i-p Gen11 x32 Lanes 8GB Wide Cache PCI SPDM Plug-in Storage Controller P47184-B21

Notes:

- This is an PCIe type controller which takes up a PCIe slot
 - This controller supports up to 32 SAS/SATA/NVMe Drives (Only 8 x4 NVMe drives can be supported; 16 x2 NVMe drives can be supported)
-



Core Options

Controller Battery Cable Kits

HPE Smart Storage Hybrid Capacitor with 260mm Cable Kit	P02381-B21
HPE 96W Smart Storage Lithium-ion Battery with 260mm Cable Kit	P01367-B21
HPE ProLiant DL3X5 Gen11 Smart Storage Battery 2P 96W Cable Kit	P57884-B21

Notes:

- The two 260mm battery cable kit can't be selected together.
- The Extension cable kit is required for either the selection of Hybrid Capacitor or 96W Smart Storage Battery

HPE Drives

Enterprise - 12G SAS - SFF Drives

HPE 300GB SAS 12G Mission Critical 15K SFF BC 3-year Warranty Multi Vendor HDD	P28028-B21
HPE 2.4TB SAS 12G Mission Critical 10K SFF BC 3-year Warranty 512e Multi Vendor HDD	P28352-B21
HPE 1.2TB SAS 12G Mission Critical 10K SFF BC 3-year Warranty Multi Vendor HDD	P28586-B21
HPE 300GB SAS 12G Mission Critical 10K SFF BC 3-year Warranty Multi Vendor HDD	P40430-B21
HPE 900GB SAS 12G Mission Critical 15K SFF BC 3-year Warranty Multi Vendor HDD	P40432-B21
HPE 600GB SAS 12G Mission Critical 15K SFF BC 3-year Warranty Multi Vendor HDD	P53560-B21
HPE 600GB SAS 12G Mission Critical 10K SFF BC 3-year Warranty Multi Vendor HDD	P53561-B21
HPE 1.8TB SAS 12G Mission Critical 10K SFF BC 3-year Warranty 512e Multi Vendor HDD	P53562-B21

Midline - 12G SAS - LFF Drives

HPE 12TB SAS 12G Business Critical 7.2K LFF LP 1-year Warranty Helium 512e Multi Vendor HDD	881781-B21
HPE 14TB SAS 12G Business Critical 7.2K LFF LP 1-year Warranty Helium 512e Multi Vendor HDD	P09155-B21
HPE 8TB SAS 12G Business Critical 7.2K LFF LP 1-year Warranty 512e Multi Vendor HDD	834031-B21
HPE 2TB SAS 12G Business Critical 7.2K LFF LP 1-year Warranty Multi Vendor HDD	833926-B21
HPE 4TB SAS 12G Business Critical 7.2K LFF LP 1-year Warranty Multi Vendor HDD	833928-B21
HPE 6TB SAS 12G Business Critical 7.2K LFF LP 1-year Warranty 512e Multi Vendor HDD	861746-B21
HPE 16TB SAS 12G Business Critical 7.2K LFF LP 1-year Warranty Helium 512e ISE Multi Vendor HDD	P23608-B21
HPE 20TB SAS 12G Business Critical 7.2K LFF LP 1-year Warranty Helium 512e ISE Multi Vendor HDD	P53553-B21

Midline - 6G SATA - SFF Drives

HPE 1TB SATA 6G Business Critical 7.2K SFF BC 1-year Warranty HDD	P28610-B21
HPE 2TB SATA 6G Business Critical 7.2K SFF BC 1-year Warranty 512e HDD	P28500-B21

Midline - 6G SATA - LFF Drives

HPE 2TB SATA 6G Business Critical 7.2K LFF LP 1-year Warranty Multi Vendor HDD	861681-B21
HPE 4TB SATA 6G Business Critical 7.2K LFF LP 1-year Warranty Multi Vendor HDD	861683-B21
HPE 1TB SATA 6G Business Critical 7.2K LFF LP 1-year Warranty Multi Vendor HDD	861686-B21
HPE 12TB SATA 6G Business Critical 7.2K LFF LP 1-year Warranty Helium 512e Multi Vendor HDD	881787-B21
HPE 8TB SATA 6G Business Critical 7.2K LFF LP 1-year Warranty 512e Multi Vendor HDD	834028-B21
HPE 6TB SATA 6G Business Critical 7.2K LFF LP 1-year Warranty 512e Multi Vendor HDD	861742-B21
HPE 16TB SATA 6G Business Critical 7.2K LFF LP 1-year Warranty Helium 512e ISE Multi Vendor HDD	P23449-B21
HPE 18TB SATA 6G Business Critical 7.2K LFF LP 1-year Warranty Helium 512e ISE Multi Vendor HDD	P37678-B21
HPE 20TB SATA 6G Business Critical 7.2K LFF LP 1-year Warranty Helium 512e ISE Multi Vendor HDD	P53554-B21

SED (Self-Encryption Drive)

HPE 2.4TB SAS 12G Mission Critical 10K SFF BC 3-year Warranty 512e Self-encrypting FIPS HDD	P28618-B21
HPE 1.2TB SAS 12G Mission Critical 10K SFF BC 3-year Warranty Self-encrypting FIPS HDD	P28622-B21

Notes:

- Requirements for MR Tri-mode controller SED support
 - o TPM is not required for Local Key Management as key is stored in controller

Core Options

- o iLO Advanced is required for Remote Key Management. Key is stored in remote key manager } (Ex. ESKM)

SSD Selection

Read Intensive - 12G SAS - SFF - Solid State Drives

HPE 960GB SAS 12G Read Intensive SFF BC Value SAS Multi Vendor SSD	P40506-B21
HPE 1.92TB SAS 12G Read Intensive SFF BC Value SAS Multi Vendor SSD	P40507-B21
HPE 3.84TB SAS 12G Read Intensive SFF BC Value SAS Multi Vendor SSD	P40508-B21
HPE 7.68TB SAS 12G Read Intensive SFF BC Value SAS Multi Vendor SSD	P40509-B21
HPE 960GB SAS 24G Read Intensive SFF BC Multi Vendor SSD	P49029-B21
HPE 1.92TB SAS 24G Read Intensive SFF BC Multi Vendor SSD	P49031-B21
HPE 3.84TB SAS 24G Read Intensive SFF BC Multi Vendor SSD	P49035-B21
HPE 7.68TB SAS 24G Read Intensive SFF BC Multi Vendor SSD	P49041-B21
HPE 15.36TB SAS 24G Read Intensive SFF BC Multi Vendor SSD	P49045-B21

Mixed Use - 12G SAS - SFF - Solid State Drives

HPE 960GB SAS 12G Mixed Use SFF BC Value SAS Multi Vendor SSD	P40510-B21
HPE 1.92TB SAS 12G Mixed Use SFF BC Value SAS Multi Vendor SSD	P40511-B21
HPE 3.84TB SAS 12G Mixed Use SFF BC Value SAS Multi Vendor SSD	P40512-B21
HPE 800GB SAS 24G Mixed Use SFF BC Multi Vendor SSD	P49047-B21
HPE 1.6TB SAS 24G Mixed Use SFF BC Multi Vendor SSD	P49049-B21
HPE 3.2TB SAS 24G Mixed Use SFF BC Multi Vendor SSD	P49053-B21
HPE 6.4TB SAS 24G Mixed Use SFF BC Multi Vendor SSD	P49057-B21

Mixed Use SAS- LFF- Solid State Drives

HPE 960GB SAS 12G Mixed Use LFF LPC Value SAS Multi Vendor SSD	P37009-B21
--	------------

Mixed Use - 6G SATA - SFF - Solid State Drives

HPE 480GB SATA 6G Mixed Use SFF BC Multi Vendor SSD	P40502-B21
HPE 960GB SATA 6G Mixed Use SFF BC Multi Vendor SSD	P40503-B21
HPE 1.92TB SATA 6G Mixed Use SFF BC Multi Vendor SSD	P40504-B21
HPE 3.84TB SATA 6G Mixed Use SFF BC Multi Vendor SSD	P40505-B21
HPE 960GB SATA 6G Mixed Use SFF BC Self-encrypting 5400M SSD	P58244-B21

Read Intensive - 6G SATA - SFF - Solid State Drives

HPE 240GB SATA 6G Read Intensive SFF BC Multi Vendor SSD	P40496-B21
HPE 480GB SATA 6G Read Intensive SFF BC Multi Vendor SSD	P40497-B21
HPE 960GB SATA 6G Read Intensive SFF BC Multi Vendor SSD	P40498-B21
HPE 1.92TB SATA 6G Read Intensive SFF BC Multi Vendor SSD	P40499-B21
HPE 3.84TB SATA 6G Read Intensive SFF BC Multi Vendor SSD	P40500-B21
HPE 7.68TB SATA 6G Read Intensive SFF BC Multi Vendor SSD	P40501-B21
HPE 480GB SATA 6G Read Intensive SFF BC Self-encrypting 5400P SSD	P58236-B21

Read Intensive - 6G SATA - LFF - Solid State Drives

HPE 960GB SATA 6G Read Intensive LFF LPC Multi Vendor SSD	P47808-B21
---	------------

SED (Self-Encryption Drive)

HPE 1.6TB SAS 24G Mixed Use SFF BC Self-encrypting FIPS PM6 SSD	P41401-B21
HPE 1.92TB SATA 6G Mixed Use SFF BC Self-encrypting 5400M SSD	P58248-B21
HPE 1.92TB SATA 6G Read Intensive SFF BC Self-encrypting 5400P SSD	P58240-B21
HPE 7.68TB SAS 24G Read Intensive SFF BC Self-encrypting FIPS PM6 SSD	P41399-B21

Notes:

- Requirements for MR Tri-mode controller SED support
 - o TPM is not required for Local Key Management as key is stored in controller



Core Options

- o iLO Advanced is required for Remote Key Management. Key is stored in remote key manager } (Ex. ESKM)

Very Read Optimized (VRO) – EDSFF – E3.S 1T – Solid State Drives

HPE 3.84TB NVMe Gen4 Mainstream Performance Very Read Optimized E3S EC1 EDSFF P5430 SSD	P63930-B21
HPE 7.68TB NVMe Gen4 Mainstream Performance Very Read Optimized E3S EC1 EDSFF P5430 SSD	P63934-B21
HPE 15.36TB NVMe Gen4 Mainstream Performance Very Read Optimized E3S EC1 EDSFF P5430 SSD	P63938-B21

Read Intensive – EDSFF – E3.S 1T – Solid State Drives

HPE 3.84TB NVMe Gen5 High Performance Read Intensive E3S EC1 EDSFF SPDM PM1743 SSD	P57799-B21
HPE 3.84TB NVMe Gen5 High Performance Read Intensive E3S EC1 EDSFF SPDM CM7 SSD	P61179-B21
HPE 7.68TB NVMe Gen5 High Performance Read Intensive E3S EC1 EDSFF SPDM PM1743 SSD	P57803-B21
HPE 7.68TB NVMe Gen5 High Performance Read Intensive E3S EC1 EDSFF SPDM CM7 SSD	P61183-B21
HPE 15.36TB NVMe Gen5 High Performance Read Intensive E3S EC1 EDSFF SPDM PM1743 SSD	P57807-B21
HPE 15.36TB NVMe Gen5 High Performance Read Intensive E3S EC1 EDSFF SPDM CM7 SSD	P61187-B21

Notes: When the PM1743 EDSFF drives are selected with a VMware OS, the internal or external NS204i-u OS Boot device must be selected to run VMware. If a boot device is not used, VMware 8.0 U1 release or later version must be supported.

Mixed Use – EDSFF – E3.S 1T – Solid State Drives

HPE 3.2TB NVMe Gen5 High Performance Mixed Use E3S EC1 EDSFF SPDM CM7 SSD	P61191-B21
HPE 6.4TB NVMe Gen5 High Performance Mixed Use E3S EC1 EDSFF SPDM CM7 SSD	P61195-B21

Read Intensive – NVMe – SFF – Solid State Drives

HPE 1.92TB NVMe Gen4 High Performance Read Intensive SFF BC U.3 PM1733a SSD	P50216-B21
HPE 3.84TB NVMe Gen4 High Performance Read Intensive SFF BC U.3 PM1733a SSD	P50219-B21
HPE 7.68TB NVMe Gen4 High Performance Read Intensive SFF BC U.3 PM1733a SSD	P50222-B21
HPE 15.36TB NVMe Gen4 High Performance Read Intensive SFF BC U.3 PM1733a SSD	P50224-B21
HPE 7.68TB NVMe Gen4 High Performance Read Intensive SFF BC U.3 PS1010 SSD	P70434-B21
HPE 15.36TB NVMe Gen4 High Performance Read Intensive SFF BC U.3 PS1010 SSD	P70436-B21
HPE 960GB NVMe Gen4 Mainstream Performance Read Intensive SFF BC U.3 Static V2 Multi Vendor SSD	P64842-B21
HPE 1.92TB NVMe Gen4 Mainstream Performance Read Intensive SFF BC U.3 Static V2 Multi Vendor SSD	P64844-B21
HPE 3.84TB NVMe Gen4 Mainstream Performance Read Intensive SFF BC U.3 Static V2 Multi Vendor SSD	P64846-B21
HPE 7.68TB NVMe Gen4 Mainstream Performance Read Intensive SFF BC U.3 Static V2 Multi Vendor SSD	P64848-B21
HPE 15.36TB NVMe Gen4 Mainstream Performance Read Intensive SFF BC U.3 Static SPDM Multi Vendor SSD	P69255-B21

Mixed Use - NVMe - SFF - Solid State Drives

HPE 1.6TB NVMe Gen4 High Performance Mixed Use SFF BC U.3 PM1735a SSD	P50227-B21
HPE 3.2TB NVMe Gen4 High Performance Mixed Use SFF BC U.3 PM1735a SSD	P50230-B21
HPE 6.4TB NVMe Gen4 High Performance Mixed Use SFF BC U.3 PM1735a SSD	P50233-B21
HPE 3.2TB NVMe Gen4 High Performance Mixed Use SFF BC U.3 PS1030 SSD	P70426-B21
HPE 6.4TB NVMe Gen4 High Performance Mixed Use SFF BC U.3 PS1030 SSD	P70428-B21
HPE 800GB NVMe Gen4 Mainstream Performance Mixed Use SFF BC U.3 Static V2 Multi Vendor SSD	P64999-B21
HPE 1.6TB NVMe Gen4 Mainstream Performance Mixed Use SFF BC U.3 Static V2 Multi Vendor SSD	P65007-B21
HPE 3.2TB NVMe Gen4 Mainstream Performance Mixed Use SFF BC U.3 Static V2 Multi Vendor SSD	P65015-B21
HPE 6.4TB NVMe Gen4 Mainstream Performance Mixed Use SFF BC U.3 Static V2 Multi Vendor SSD	P65023-B21



Core Options

SED (Self-Encryption Drive)

HPE 1.6TB NVMe Gen4 High Performance Mixed Use SFF BC Self-encrypting FIPS U.3 CM6 SSD	P41404-B21
HPE 3.84TB NVMe Gen4 High Performance Read Intensive SFF BC Self-encrypting FIPS U.3 CM6 SSD	P41403-B21

HPE Tape Backup

For the complete range of tape drives, autoloaders, libraries and media see:

<https://www.hpe.com/us/en/storage/storeever-tape-storage.html>.

For hardware and software compatibility of Hewlett Packard Enterprise tape backup products

<http://www.hpe.com/storage/BURCompatibility>

HPE Storage Options

Emulex Fibre Channel HBAs

HPE SN1610E 32Gb 1-port Fibre Channel Host Bus Adapter	R2J62A
HPE SN1610E 32Gb 2-port Fibre Channel Host Bus Adapter	R2J63A
HPE SN1700E 64Gb 1-port Fibre Channel Host Bus Adapter	R7N77A
HPE SN1700E 64Gb 2-port Fibre Channel Host Bus Adapter	R7N78A

QLogic Fibre Channel HBAs

HPE SN1610Q 32Gb 1-port Fibre Channel Host Bus Adapter	R2E08A
HPE SN1610Q 32Gb 2-port Fibre Channel Host Bus Adapter	R2E09A
HPE SN1700Q 64Gb 1-port Fibre Channel Host Bus Adapter	R7N86A
HPE SN1700Q 64Gb 2-port Fibre Channel Host Bus Adapter	R7N87A

HPE Networking

1 Gigabit Ethernet adapters

Intel I350-T4 Ethernet 1Gb 4-port BASE-T Adapter for HPE	P21106-B21
Broadcom BCM5719 Ethernet 1Gb 4-port BASE-T Adapter for HPE	P51178-B21

10 Gigabit Ethernet adapters

Broadcom BCM57416 Ethernet 10Gb 2-port BASE-T Adapter for HPE	P26253-B21
Broadcom BCM57412 Ethernet 10Gb 2-port SFP+ Adapter for HPE	P26259-B21

10/25 Gigabit Ethernet adapters

Broadcom BCM57414 Ethernet 10/25Gb 2-port SFP28 Adapter for HPE	P26262-B21
Broadcom BCM57504 Ethernet 10/25Gb 4-port SFP28 Adapter for HPE	P26264-B21
Intel E810-XXVDA2 Ethernet 10/25Gb 2-port SFP28 Adapter for HPE	P08443-B21
Mellanox MCX631102AS-ADAT Ethernet 10/25Gb 2-port SFP28 Adapter for HPE	P42044-B21
Intel E810-XXVDA4 Ethernet 10/25Gb 4-port SFP28 Adapter for HPE	P08458-B21
HPE Ethernet 10/25Gb 2-port Secure Network Adapter	S2A69A

100/200 Gigabit Ethernet adapters

Mellanox MCX623106AS-CDAT Ethernet 100Gb 2-port QSFP56 Adapter for HPE	P25960-B21
Intel E810-CQDA2 Ethernet 100Gb 2-port QSFP28 Adapter for HPE	P21112-B21
Mellanox MCX623105AS-VDAT Ethernet 200Gb 1-port QSFP56 Adapter for HPE	P10180-B21

Notes:

- Almost all PCIe Networking Cards need 6x Performance Fans. Refer to OCA configurator for exceptions and details
- Direct Attach Cable (DAC) for copper environments or fiber transceivers and cables for fiber-optic environments must be purchased separately. Please see the related NIC QuickSpecs for Technical Specifications and additional information:
<https://h20195.www2.hpe.com/v2/getpdf.aspx/A00002507ENW.pdf>



Core Options

Recommended System Ambient Temperature						
System Config	CPU cTDP	P08458-B21	R8M41A	P25960-B21	P21112-B21	P10180-B21
12 LFF	< or = 240W	30C	30C	30C	30C	30C
24SFF		30C	30C	30C	30C	30C
8 LFF / 16 SFF	> 240W	30C	30C	30C	30C	25C
12 LFF		25C	25C	25C	25C	25C
24SFF		25C	25C	25C	25C	25C
8SFF		30C	30C	30C	30C	30C

Notes: Other Restrictions

- Required to use Performance Fan Kit
- Only supported on 1/4/5/6/7 PCIe slots
- This recommended system ambient temperature is based on HPE AOC (Active Optical Cables)

OCP Adapter

1 Gigabit Ethernet OCP adapters

Intel I350-T4 Ethernet 1Gb 4-port BASE-T OCP3 Adapter for HPE	P08449-B21
Broadcom BCM5719 Ethernet 1Gb 4-port BASE-T OCP3 Adapter for HPE	P51181-B21

10 Gigabit Ethernet OCP Adapters

Broadcom BCM57412 Ethernet 10Gb 2-port SFP+ OCP3 Adapter for HPE	P26256-B21
Broadcom BCM57416 Ethernet 10Gb 2-port BASE-T OCP3 Adapter for HPE	P10097-B21

10/25 Gigabit Ethernet OCP adapters

Broadcom BCM57414 Ethernet 10/25Gb 2-port SFP28 OCP3 Adapter for HPE	P10115-B21
Broadcom BCM57504 Ethernet 10/25Gb 4-port SFP28 OCP3 Adapter for HPE	P26269-B21
Intel E810-XXVDA2 Ethernet 10/25Gb 2-port SFP28 OCP3 Adapter for HPE	P10106-B21
Mellanox MCX631432AS-ADAI Ethernet 10/25Gb 2-port SFP28 OCP3 Adapter for HPE	P42041-B21

100/200 Gigabit Ethernet adapters

Intel E810-CQDA2 Ethernet 100Gb 2-port QSFP28 OCP3 Adapter for HPE	P22767-B21
--	------------

Notes:

- Almost all PCIe Networking Cards need 6x Performance Fans. Refer to OCA configurator for exceptions and details
- P22767-B21 and P26269-B21 needs selection of an OCP upgrade cable kit

Recommended System Ambient Temperature					
System Config	CPU cTDP	P26269-B21	P10106-B21	P42041-B21	P22767-B21
12 LFF	< or = 240W	30C	30C	30C	30C
24 SFF		30C	30C	30C	30C
8 LFF /16 SFF	>240W	25C	25C	30C	30C
12 LFF		25C	25C	25C	25C
24 SFF		25C	25C	25C	25C
8 SFF		30C	30C	30C	30C

Notes: Other Restrictions

1. Required to use Performance Fan Kit
2. This recommended system ambient temperature is based on HPE AOC (Active Optical Cables)

HPE InfiniBand

HPE InfiniBand HDR100/Ethernet 100Gb 1-port QSFP56 PCIe4 x16 MCX653105A-ECAT Adapter	P23665-B21
HPE InfiniBand HDR100/Ethernet 100Gb 2-port QSFP56 PCIe4 x16 MCX653106A-ECAT Adapter	P23666-B21
HPE InfiniBand HDR/Ethernet 200Gb 1-port QSFP56 PCIe4 x16 MCX653105A-HDAT Adapter	P23664-B21

Core Options

HPE InfiniBand HDR/Ethernet 200Gb 2-port QSFP56 PCIe4 x16 MCX653106A-HDAT Adapter	P31324-B21
HPE InfiniBand NDR 1-port OSFP PCIe5 x16 MCX75310AAS-NEAT Adapter	P45641-B21
HPE InfiniBand NDR200 1-port OSFP PCIe5 x16 MCX75310AAS-HEAT Adapter	P45642-B21
HPE InfiniBand NDR200/Ethernet 200GbE 2-port QSFP112 PCIe5 x16 MCX755106AC-HEAT Adapter	P65333-B21
HPE InfiniBand HDR/Ethernet 200Gb 1-port QSFP56 PCIe4 x16 OCP3 MCX653435A-HDAI Adapter	P31323-B21
HPE InfiniBand HDR/Ethernet 200Gb 2-port QSFP56 PCIe4 x16 OCP3 MCX653436A-HDAI Adapter	P31348-B21

Notes:

- All InfiniBand options require 6 performance fan kit
- For InfiniBand OCP options, OCP upgrade kit is needed
- 200Gb 2-port OCP option cannot be supported with Mid Cages due to thermal restriction
- For more information, please visit: [HPE InfiniBand Options for HPE ProLiant and Apollo Servers](#)

Servers

Recommended System Ambient Temperature								
System Config	CPU cTDP	P23666-B21	P23664-B21	P31324-B21	P45641-B21	P45642-B21	P31323-B21	P31348-B21
12 LFF	< or = 240W	30C	30C	30C	30C	30C	30C	23C
24 SFF		30C	30C	30C	30C	30C	30C	25C
8 LFF /16 SFF	>240W	30C	30C	25C	30C	30C	25C	25C
12 LFF		25C	25C	25C	25C	25C	25C	Not Support
24 SFF		25C	25C	25C	25C	25C	25C	Not Support
8 SFF		30C	30C	30C	30C	30C	30C	25C

Notes:

Other Restrictions

- Required to use Performance Fan Kit
- Only supported on 1/4/5/6/7 PCIe slots
- The P31348-B21 only supported on 2 OCP slot
- This recommended system ambient temperature is based on HPE AOC (Active Optical Cables)



Core Options

HPE ProLiant DL3X5 Gen11 x16 OCP1 1P Upgrade Cable Kit

P57882-B21

Notes:

- This cable kit cannot be selected when 2 processors are configured
- This cable kit upgrades OCP1 from x8 to x16
- When this kit is selected, OCP2 will not be available

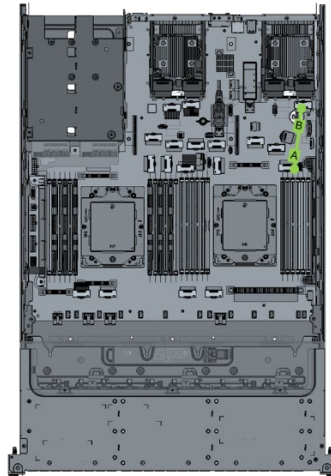

HPE ProLiant DL3X5 Gen11 x16 OCP1 OCP2 2P Upgrade Cable Kit

P57849-B21

Notes:

- This cable kit needs 2 processors configured
- This cable kit upgrades OCP1 from x8 to x16 and OCP2 from x8 to x16
- When this cable kit is selected then the Secondary Riser Upgrade Kit cannot be configured
- When this cable kit is selected then 8SFF x4 U.3 Mid Cage cannot be supported with Direct Attach

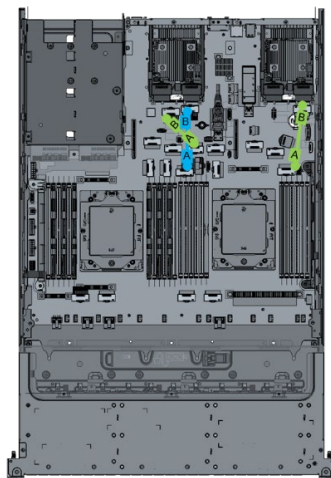

Core Options

HPE Computation and Graphics Accelerator and related option kits

NVIDIA L40S 48GB PCIe Accelerator

S2L70C

Notes:

- Double wide GPUs can only be supported with the GPU CTO chassis
- Mixing different types of GPU is not supportable
- Double wide GPUs require selection of 4DW GPU FIO enablement kit
- When this GPU is selected, the PDB kit must be selected
- When this GPU is selected, the CPU 16pin GPU Power Cable Kit to PDB must be selected (P57866-B21)
- When this GPU is selected, the Nvidia Ampere NVLink 2x2 Bridge cannot be selected

NVIDIA L4 24GB PCIe Accelerator for HPE

S0K89C

Notes:

- Single wide GPUs can only be supported with the GPU CTO chassis
- Mixing different types of GPU is not supportable
- This GPU is now supportable with 8SW GPU FIO enablement kit
- This GPU is supportable with 4DW GPU FIO enablement kit
- Maximum supported quantity is 8 when supported with the 8SW GPU FIO enablement kit
- Maximum supported quantity is 4 when supported with the 4DW GPU FIO enablement kit
- This GPU doesn't require a GPU power cable kit
- When this GPU is selected, the Nvidia Ampere NVLink 2x2 Bridge cannot be selected

NVIDIA L40 48GB PCIe Accelerator for HPE

S0K90C

Notes:

- Double wide GPUs can only be supported with the GPU CTO chassis
- Mixing different types of GPU is not supportable
- Double wide GPUs require selection of 4DW GPU FIO enablement kit
- When this GPU is selected, the PDB kit must be selected
- When this GPU is selected, the CPU 16pin GPU Power Cable Kit to PDB must be selected (P57866-B21)
- When this GPU is selected, the Nvidia Ampere NVLink 2x2 Bridge cannot be selected

NVIDIA H100 NVL 94GB PCIe Accelerator for HPE

S2D86C

Notes:

- Double wide GPUs can only be supported with the GPU CTO chassis
- Mixing different types of GPU is not supportable
- Double wide GPUs require selection of 4DW GPU FIO enablement kit
- When this GPU is selected, the PDB kit must be selected
- When this GPU is selected, the 16pin GPU Power Cable Kit to PDB must be selected (P70192-B21)
- This GPU supports the Nvidia Ampere NVLink 2x2 Bridge

NVIDIA H100 80GB PCIe Accelerator for HPE

R9S41C

Notes:

- Double wide GPUs can only be supported with the GPU CTO chassis
- Mixing different types of GPU is not supportable
- Double wide GPUs require selection of 4DW GPU FIO enablement kit
- When this GPU is selected, the PDB kit must be selected
- When this GPU is selected, the CPU 16pin GPU Power Cable Kit to PDB must be selected (P57866-B21)
- This GPU supports the Nvidia Ampere NVLink 2x2 Bridge



Core Options

NVIDIA A16 64GB PCIe Non-CEC Accelerator for HPE

R8T26C

Notes:

- Double wide GPUs can only be supported with the GPU CTO chassis
- Mixing different types of GPU is not supportable
- Double wide GPUs require selection of 4DW GPU FIO enablement kit
- If A16 64GB GPU is selected without the PDB kit then CPU 8pin GPU Power Cable Kit to MB must be selected (P57851-B21)
- If A16 64GB GPU is selected with the PDB kit then CPU 8p GPU Power Cable Kit to PDB must be selected (P57858-B21)
- When this GPU is selected, the Nvidia Ampere NVLink 2x2 Bridge cannot be selected

NVIDIA Ampere 2-way 2-slot Bridge for HPE

R6V66A

Notes:

- Quantity of this bridge must be 3 or 6. A pair of GPUs can be linked with 3 bridges, therefore a maximum quantity of 6 can be configured with a pair of GPUs installed on each side of the GPU front-end. i.e. 4 double-width GPUs installed.
- Minimum of 2x DW GPUs must be selected to support this bridge

HPE ProLiant DL385 Gen11 8 Single Wide GPU FIO Enablement Kit

P57883-B21

Notes:

- This kit is required for 8x Single Wide GPUs
- This kit provides eight GPU risers supporting up to 8x Single Wide GPUs

HPE ProLiant DL385 Gen11 GPU FIO Switchboard Kit

P57894-B21

Notes:

- This kit is required for the 8SW GPU FIO enablement kit and 8x SW GPUs
- This kit provides two switchboards which provide PCIe lanes for the 8x GPU risers

HPE ProLiant DL385 Gen11 4 Double Wide GPU FIO Enablement Kit

P55094-B21

Notes:

- This kit is required for Double Wide GPUs
- This kit provides four GPU risers supporting up to 4x Double Wide GPUs

HPE ProLiant DL385 Gen11 CPU 8-pin GPU Power Cable From Motherboard

P57851-B21

Notes:

- Required for A16 and A100 GPU
- Maximum quantity =1
- One GPU power cable kit can support up to 4x DW GPUs

HPE ProLiant DL385 Gen11 CPU 8-pin GPU Power Cable From Power Distribution Board

P57858-B21

Notes:

- This cable kit connects to the Power Distribution Board (PDB) supported when four power supplies are configured in the system
- Required for A16 and A100 GPU
- Maximum quantity =1
- One GPU power cable kit can support up to 4x DW GPUs

HPE ProLiant DL380a Gen11 GPU 16-pin FIO Power Cable Kit

P70192-B21

Notes:

- This cable kit connects to the Power Distribution Board (PDB) supported when four power supplies are configured in the system
- Required for H100 94GB NVL GPU
- Maximum quantity =1
- One GPU power cable kit can support up to 4x DW GPUs



Core Options

HPE ProLiant DL385 Gen11 16-pin GPU Power Cable From Power Distribution Board P57866-B21

Notes:

- This cable kit connects to the Power Distribution Board (PDB) supported when four power supplies are configured in the system
- Required for L40, L40S and H100 80GB GPU
- Maximum quantity =1
- One GPU power cable kit can support up to 4x DW GPUs

HPE Power Supplies and Power Related Option Kits

HPE Flexible Slot (Flex Slot) Power Supplies share a common electrical and physical design that allows for hot plug, tool-less installation into HPE ProLiant Gen10 Plus Performance Servers. Flex Slot power supplies are certified for high-efficiency operation and offer multiple power output options, allowing users to "right-size" a power supply for specific server configurations. This flexibility helps to reduce power waste, lower overall energy costs, and avoid "trapped" power capacity in the data center.

Notes:

- Prior to making a power supply selection it is highly recommended that the HPE Power Advisor is run to determine the right size power supply for your server configuration. The HPE Power Advisor is located at: <https://poweradvisor.ext.it.hpe.com/?Page=Index>
- HPE ProLiant servers ship with an IEC-IEC power cord used for rack mounting with Power Distribution Units (PDUs). Visit [HPE Power Cords and Cables](#) for a full list of optional power cords.

HPE 800W Flex Slot Platinum Hot Plug Low Halogen Power Supply Kit P38995-B21

Notes: Flex Slot Platinum Plus power supplies support power efficiency of up to 94% and include a C-14 power inlet connector that can support HPE Power Discovery Services (blue connector).

HPE 1000W Flex Slot Titanium Hot Plug Power Supply Kit P03178-B21

Notes: Flex Slot Titanium Plus power supplies support power efficiency of up to 96% and include a C-14 power inlet connector that can support HPE Power Discovery Services (blue connector).

HPE 1600W Flex Slot -48VDC Hot Plug Power Supply Kit P17023-B21

Notes:

- Flex Slot universal power supplies support power efficiency of up to 94% and support both 277VAC/380VDC power inputs.
- HPE 1600W DC PSU Power Lug Option Kit (P36877-B21) must be selected along with this power supplies.

HPE 1600W Flex Slot Platinum Hot Plug Low Halogen Power Supply Kit P38997-B21

Notes:

- Flex Slot Platinum Plus power supplies support power efficiency of up to 94% and include a C-14 power inlet connector that can support HPE Power Discovery Services (blue connector).
- The power supply selected only supports high line voltage (200VAC to 240VAC)

HPE 1800W-2200W Flex Slot Titanium Hot Plug Power Supply Kit P44712-B21

Notes:

- Flex Slot Titanium Plus power supplies support power efficiency of up to 96% and include a C-14 power inlet connector that can support HPE Power Discovery Services (blue connector)
- The power supply selected only supports high line voltage (200VAC to 240VAC)
- When 4 PSUs is selected including this PSU, mixing two types of PSU is allowed

HPE 1600W -48VDC Power Cable Lug Kit P36877-B21

Notes: Must be selected along with HPE 1600W Flex Slot -48VDC Hot Plug Power Supply Kit (P17023-B21)

HPE ProLiant DL385 Gen11 Power Distribution Board Kit P57888-B21

Notes:

- PDB kit is required when four power supplies are configured in the system
- PDB kit cannot be configured with 8SFF or 8LFF CTO server



Core Options

Riser Support Matrix									
Primary Riser Part Number	Secondary Riser Part Number	Tertiary Riser Part Number	Description	Riser position (number denotes number of slots present)			Bus width (Gen5 lanes)		
				Primary	Secondary	Tertiary	Top slot	Middle Slot	Bottom slot
Default riser	N/A	N/A	This is the default riser in the chassis	1	0	0	0	0	X16
Default riser + P57890-B21	N/A	N/A	Default riser + HPE DL385 G11 2x16 Prim FIO Upg Rsr Kit	3	0	0	X16	X16	X16
N/A	P55097-B21	N/A	HPE DL385 Gen11 x16 Slot6 Sec Riser Kit	0	1	0	0	0	X16
N/A	P55097-B21 + P68392-B21	N/A	HPE DL385 Gen11 x16 Slot6 Sec Riser Kit + HPE DL385 G11 x16 Slot5 Sec Upg Rsr Kit	0	2	0	0	X16	X16
N/A	P55097-B21 + P57891-B21	N/A	HPE DL385 Gen11 x16 Slot1 Sec Riser Kit + HPE DL385 Gen11 2x16 Sec Upg Riser Kit	0	3	0	X16	X16	X16
N/A	N/A	P57893-B21	HPE DL385 Gen11 2x16 Tert FIO Riser Kit	0	0	2	X16	X16	0
P55098-B21	N/A	N/A	HPE DL385 G11 x16 Prim FIO Rsr LFF Rear*	1 (Below 4LFF)	0	0	0	0	X16
N/A	P57892-B21	N/A	HPE DL385 Gen11 x16 Sec FIO Rsr LFF Rear**	0	1 (Below 4LFF)	0	0	0	X16
N/A	P59260-B21	N/A	HPE DL385 Gen11 x16 LP Sec Riser Kit***	0	1 (Below 4LFF + when NS204i-u boot device is supported)	0	0	0	X16

Notes:

- P68392-B21 is a new riser kit that provides Slot 5 on the Secondary position. This provides an additional slot to use under configurations such as GPU configurations or 24x NVMe/ 24x EDSFF configurations where most MCIO connectors are used for GPU risers or direct attached drives.
- * P55098-B21 is supportable when 4LFF rear cage is selected. With this rear cage configured, primary position is supported up to 1 riser
- ** P57892-B21 is supportable when 4LFF rear cage is selected. With this rear cage configured, secondary position is supported up to 1 riser
- *** P59260-B21 is supportable when 4LFF rear cage + NS204i-u M.2 boot device are selected. This riser kit is an alternative to P57892-B21 riser kit in the secondary position
- An illustration of the 4LFF rear cage, Primary riser kit (P55098-B21) and LP Sec. riser kit (P59260-B21) are as follows:



Core Options

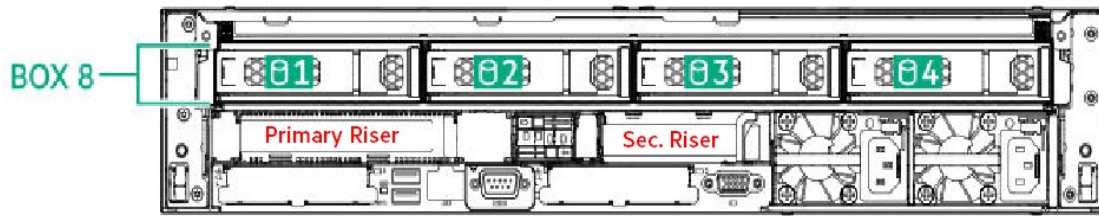

Additional Options

Some options may not be integrated at the factory. To ensure only valid configurations are ordered, Hewlett Packard Enterprise recommends the use of an HPE approved configurator. Contact your local sales representative for additional information.

Embedded Management

HPE iLO Advanced

HPE iLO Advanced Electronic License with 1yr Support on iLO Licensed Features	E6U59ABE
HPE iLO Advanced Electronic License with 3yr Support on iLO Licensed Features	E6U64ABE
HPE iLO Advanced 1-server License with 3yr Support on iLO Licensed Features	BD505A
HPE iLO Advanced Flexible Quantity License with 3yr Support on iLO Licensed Features	BD506A
HPE iLO Advanced AKA Tracking License with 3yr Support on iLO Licensed Features	BD507A
HPE iLO Advanced 1-server License with 1yr Support on iLO Licensed Features	512485-B21
HPE iLO Advanced Flexible Quantity License with 1yr Support on iLO Licensed Features	512486-B21
HPE iLO Advanced AKA Tracking License with 1yr Support on iLO Licensed Features	512487-B21

HPE Converged Infrastructure Management Software

HPE OneView Standard 1yr 9x5 Support Flexible Quantity E-RTU	K6F98AAE
HPE OneView w/o iLO including 3yr 24x7 Support 1-server LTU	P8B24A
HPE OneView w/o iLO including 3yr 24x7 Support Track 1-server LTU	P8B25A
HPE OneView w/o iLO including 3yr 24x7 Support Flexible Quantity E-LTU	P8B26AAE
HPE OneView including 3yr 24x7 Support Flexible Quantity E-LTU	E5Y35AAE
HPE OneView Upgrade from Insight Management 3yr 24x7 Support 1-server LTU	F6Q91A
HPE OneView including 3yr 24x7 Support Physical 1-server LTU	E5Y34A
HPE OneView including 3yr 24x7 Support Track 1-server LTU	E5Y36A
HPE OneView for ProLiant DL Server including 3yr 24x7 Support Bundle Track 1-server LTU	E5Y44A
HPE OneView Upgrade from Insight Management including 3yr 24x7 Support Flexible Quantity E-LTU	E5Y45AAE

Notes: Licenses ship without media. The HPE OneView Media Kit can be ordered separately, or can be downloaded.

HPE Security

HPE Bezel Lock Kit	875519-B21
HPE ProLiant DL385 Gen11 Intrusion Cable Kit	P55713-B21
HPE Gen11 2U Bezel Kit	P50400-B21

HPE Cable Options

HPE ProLiant DL3X5 Gen11 XGMI Interconnection Cable Kit	P57880-B21
---	------------

Notes:

- This kit enhances the interconnection between 2 processors by providing the 4th XGMI interconnection on top of the defaulted 3 interconnections which optimizes system performance
- Requires 2 processors
- This cable kit cannot be supported with 8 NVMe, 16 NVMe or 24 NVMe Balance Kits
- This cable kit cannot be supported with Tertiary riser or Primary riser upgrade kits
- This cable kit cannot be supported with GPU CTO server
- This cable kit cannot be supported with EDSFF CTO server when the EDSFF drives are configured as direct attach



Additional Options

- This cable kit only works with mainboard that is P48793-002 or P48793-003 or a newer version. The XGMI cable kit doesn't work with the P48793-001 mainboard. Here's how you can check version of your mainboard:

- By part number/AS# on the CT label of the mainboard. CT labels are usually pasted next to memory DIMM slots. Please see below images and learn where you can find AS# on a CT label



- In the Active Health System Log (AHS Log), inside the Dashboard tab, you can find PCA part number under the System Board section

HPE DL385 Gen11 GPU Storage Battery Brkt Kit for GPU CTO

P69872-B21

Notes:

- This bracket kit acts as the holder for a smart storage battery for storage controllers
- This kit is only supported with the GPU CTO Server

HPE ProLiant DL3X5 Gen11 GPU 8SFF/EDSFF x4 PCIe Tri-Mode Cable Kit

P69866-B21

Notes:

- This cable kit is only supported by the GPU CTO Server
- This cable kit is used for x4 controller support on the 8SFF or 8EDSFF drive cages
- Only supportable with PCIe controllers
- Controllers on GPU CTO Servers won't support storage backup battery until the battery bracket is launched by July 2024

HPE ProLiant DL3X5 Gen11 GPU 8SFF x2 OCP Tri-Mode Cable Kit

P69868-B21

Notes:

- This cable kit is only supported by the GPU CTO Server
- This cable kit is used for x2 controller support on the 8SFF drive cage only
- Only supportable with OROC controllers
- Controllers on GPU CTO Servers won't support storage backup battery until the battery bracket is launched by July 2024

HPE ProLiant DL385 Gen11 GPU 8SFF x2 PCIe Tri-Mode Cable Kit

P70316-B21

Notes:

- This cable kit is only supported by the GPU CTO Server
- This cable kit is used for x2 controller support on the 8SFF drive cage only
- Only supportable with PCIe controllers
- Controllers on GPU CTO Servers won't support storage backup battery until the battery bracket is launched by July 2024

HPE ProLiant DL385 Gen11 8SFF x1 SATA Direct Attach Cable Kit

P57846-B21

HPE ProLiant DL385 Gen11 8SFF x2 NVMe Direct Attach Cable Kit

P57859-B21

Notes:This DA Cable kit requires 8SFF x4 U.3 front drive cage

HPE ProLiant DL385 Gen11 8SFF x4 NVMe Box 3 Direct Attach Cable Kit

P57853-B21

HPE ProLiant DL385 Gen11 8SFF x4 NVMe Box 2 Direct Attach Cable Kit

P57854-B21

HPE ProLiant DL385 Gen11 8SFF x4 NVMe Box 1 Direct Attach Cable Kit

P57855-B21

Notes: These three x4 NVMe direct attach cable kits are used for 8SFF x4 U.3 drive cages. Acquire these by selecting the matching NVMe Bundle SKU



Additional Options

HPE ProLiant DL385 Gen11 8SFF OROC x1 SAS/SATA Cable Kit	P57847-B21
Notes: This OROC Cable kit is used with 8SFF x1 U.3 front drive cage	
HPE ProLiant DL385 Gen11 8SFF x1 SAS/SATA PCIe Cable Kit	P57848-B21
Notes: This PCIe Cable kit is used for 8SFF x1 U.3 front drive cage	
HPE ProLiant DL385 Gen11 8SFF x4 NVMe PCIe Cable Kit	P57856-B21
Notes:	
– This PCIe Cable kit is used for 8SFF x4 U.3 drive cage	
– This cable kit supports the SR932i-p controller	
HPE ProLiant DL385 Gen11 8SFF OROC x2 NVMe Box 3 Cable Kit	P57862-B21
HPE ProLiant DL385 Gen11 8SFF OROC x2 NVMe Box 2 Cable Kit	P57863-B21
HPE ProLiant DL385 Gen11 8SFF OROC x2 NVMe Box 1 Cable Kit	P57864-B21
Notes: These three x2 OROC tri-mode cable kits are used for 8SFF x4 U.3 drive cages	
HPE ProLiant DL385 Gen11 8SFF x2 NVMe PCIe Cable Kit	P57865-B21
Notes: This PCIe Cable kit is used for 8SFF x4 U.3 drive cages	
HPE ProLiant DL385 Gen11 8SFF x1 SAS/SATA OROC/PCIe Mid Tray Cable Kit	P57868-B21
Notes: This OROC/PCIe Cable kit is used for 8SFF x1 U.3 Mid Cage kit	
HPE ProLiant DL385 Gen11 8SFF x2 NVMe Mid Tray PCIe Splitter Cable Kit	P57869-B21
Notes: This PCIe Cable kit is used for 8SFF x4 U.3 Mid Cage kit	
HPE ProLiant DL385 Gen11 8LFF OROC x1 SAS/SATA Cable Kit	P57870-B21
HPE ProLiant DL385 Gen11 SFF Backplane Power Cable Kit	P57845-B21
Notes: If Front 8SFF Drive cage is selected Qty above one then SFF Backplane Power Cable Kit must be selected	
HPE ProLiant DL36X Gen11 Rear Serial Port Cable Kit	P59431-B21

HPE Disk-Based Backup

HPE RDX External Docking Station	C8S07B
HPE RDX 500GB Removable Disk Cartridge	Q2042A
HPE RDX 1TB Removable Disk Cartridge	Q2044A
HPE RDX 2TB Removable Disk Cartridge	Q2046A
HPE RDX 4TB Removable Disk Cartridge	Q2048A

HPE Racks

- Please see the HPE Advanced Series Racks QuickSpecs for information on additional racks options and rack specifications. **HPE G2 Advanced Series Racks**
- Please see the HPE Enterprise Series Racks QuickSpecs for information on additional racks options and rack specifications. **HPE G2 Enterprise Series Racks**



Additional Options

HPE Power Distribution Units (PDUs)

- Please see the [HPE Basic Power Distribution Units \(PDU\) QuickSpecs](#) for information on these products and their specifications.
- Please see the [HPE Metered Power Distribution Units \(PDU\) QuickSpecs](#) for information on these products and their specifications.
- Please see the [HPE Intelligent Power Distribution Unit \(PDU\) QuickSpecs](#) for information on these products and their specifications.
- Please see the [HPE Metered and Switched Power Distribution Units \(PDU\) QuickSpecs](#) for information on these products and their specifications.

HPE Uninterruptible Power Systems (UPS)

- To learn more, please visit the [HPE Uninterruptible Power Systems \(UPS\) web page](#).
- Please see the [HPE DirectFlow Three Phase Uninterruptible Power System QuickSpecs](#) for information on these products and their specifications.
- Please see the [HPE Line Interactive Single Phase UPS QuickSpecs](#) for information on these products and their specifications.

HPE Rack Options

- Please see the [HPE KVM Switches web page](#) for information on these products and their specifications.

Rail Kits

Notes:

- HPE rail kits are designed to work with HPE racks in compliance with industry standard EIA-310-E. In the event a customer elects to purchase a third-party rack for use with an HPE rail kit, any such use is at customer's own risk. HPE makes no express or implied warranties with respect to such third-party racks and specifically disclaims any implied warranties of merchantability and fitness for a particular purpose. Furthermore, HPE has no obligation and assumes no liability for the materials, design, specifications, installation, safety, and compatibility of any such third-party racks with any rail kits, including HPE rail kits.
- Hewlett Packard Enterprise recommends that a minimum of two people are required for all Rack Server installations. Please refer to your installation instructions for proper tools and number of people to use for any installation.
- CTO Models do not ship with rail kits, they need to be ordered separately

HPE DL3XX Gen11 Easy Install Rail 2 Kit P52351-B21

Notes: Supported on both SFF and LFF Models

HPE Ball Bearing Rail 8 Kit P52345-B21

Notes: Supported on only GPU models

HPE DL3XX Gen11 Ball Bearing Rail 10 Kit P52347-B21

Notes: Supported on only 48 SFF models

HPE DL38X Gen10 Plus 2U Cable Management Arm for Rail Kit P22020-B21

Notes: Supportable when rail kit is selected. Only supported by SFF, LFF and EDSFF models

HPE Apollo 4200 Gen10 Plus Cable Management Arm P28726-B21

Notes: Only supported by GPU models

HPE DL3XX Gen11 2U 2ROW CMA Kit P54963-B21

Notes: Only supported by 48 SFF models



Additional Options

HPE Support Services

Installation & Startup Services

HPE ProLiant DL/ML Install Service	U4554E
HPE ProLiant DL/ML Startup Service	U4555E

Tech Care

HPE 3 Year Tech Care Essential DL385 GEN11 Service	H79H3E
HPE 3 Year Tech Care Essential wDMR DL385 GEN11 Service	H79H4E
HPE 5 Year Tech Care Essential DL385 GEN11 Service	H79K7E
HPE 5 Year Tech Care Essential wDMR DL385 GEN11 Service	H79K8E

Notes: For a full listing of Support Services available for this server, please visit <http://www.hpe.com/services>.



Memory

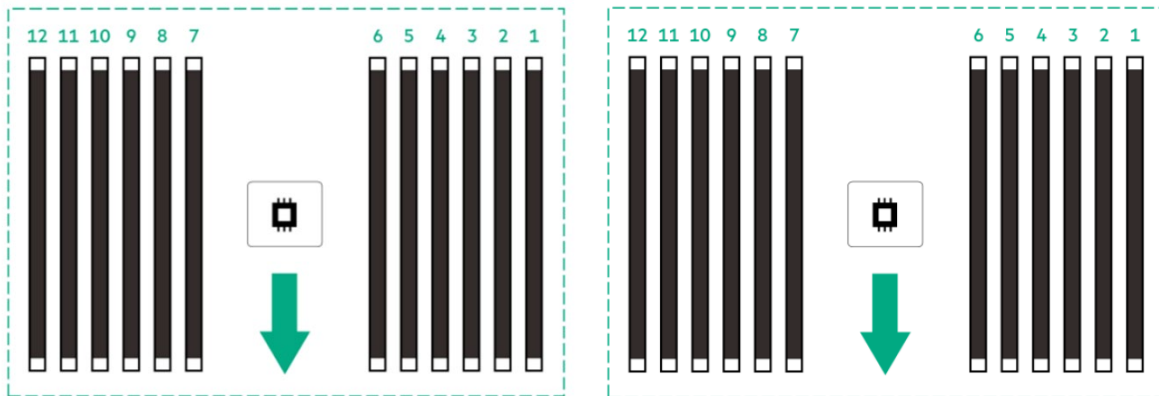

----- Front side of the server -----

General Memory Population Rules and Guidelines

- Install DIMMs only if the corresponding processor is installed.
- If only one processor is installed in a two-processor system, only half of the DIMM slots are available.
- To maximize performance, it is recommended to balance the total memory capacity between all installed processors.
- When two processors are installed, balance the DIMMs across the two processors.
- The maximum memory speed is a function of the memory type, memory configuration, and processor model.
- The maximum memory capacity is a function of the number of DIMM slots on the platform, the largest DIMM capacity qualified on the platform, the number and model of installed processors qualified on the platform.
- To realize the performance memory capabilities listed in this document, HPE DDR5 Smart Memory is required. For additional information, please see the: **[HPE DDR5 Smart Memory QuickSpecs](#)**
- For General Server Memory Population Rules and Guidelines and HPE Server Memory speed, see details here: **<http://www.hpe.com/docs/memory-population-rules>**



Storage



8LFF chassis with Universal media bay and optional 2SFF and optical drive shown

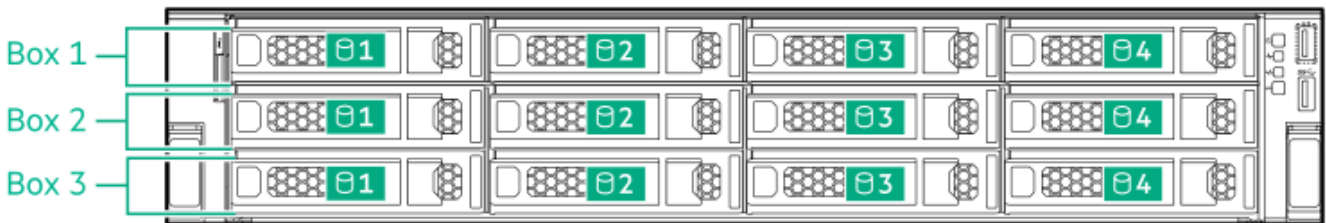

12LFF Front Panel

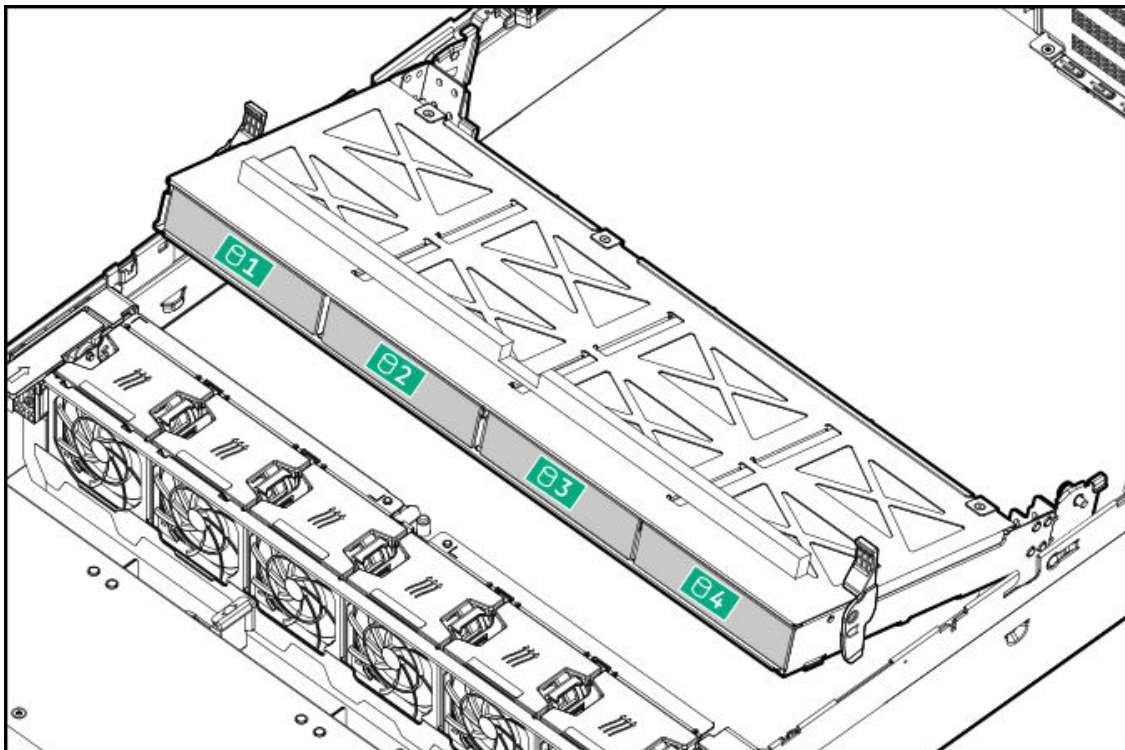

Midplane Box (LFF)



Storage

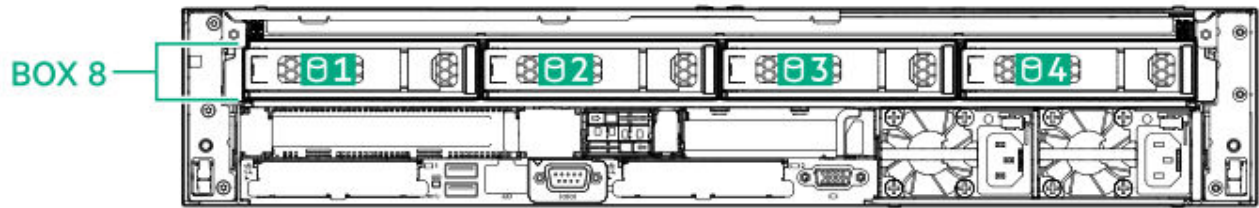

Rear Panel 1x 4LFF

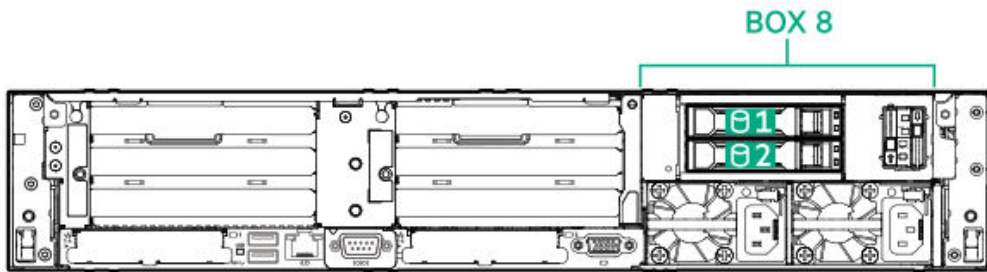
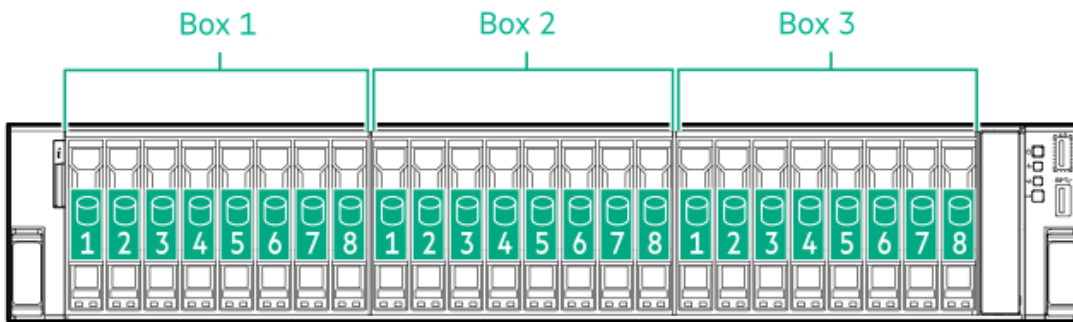

24 SFF + rear 2 SFF drives



Storage

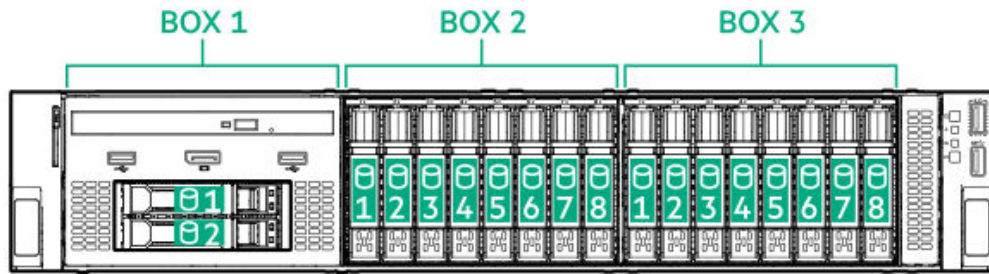

16 SFF + Universal Media Bay

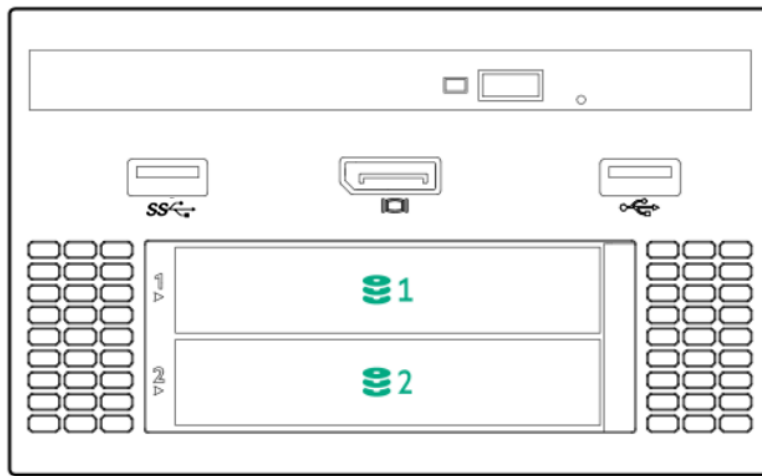

Universal Media Bay

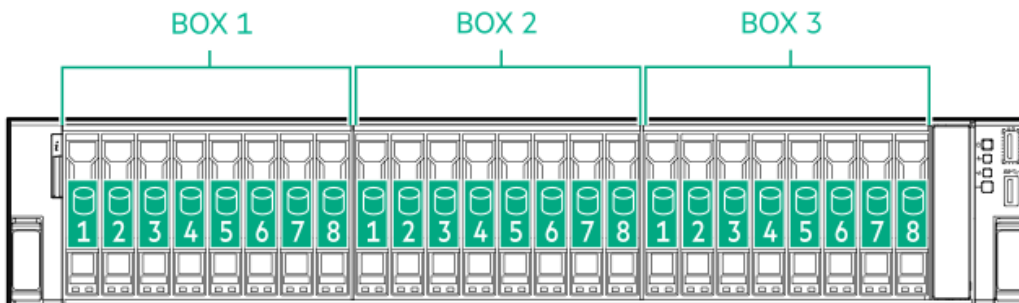

Storage

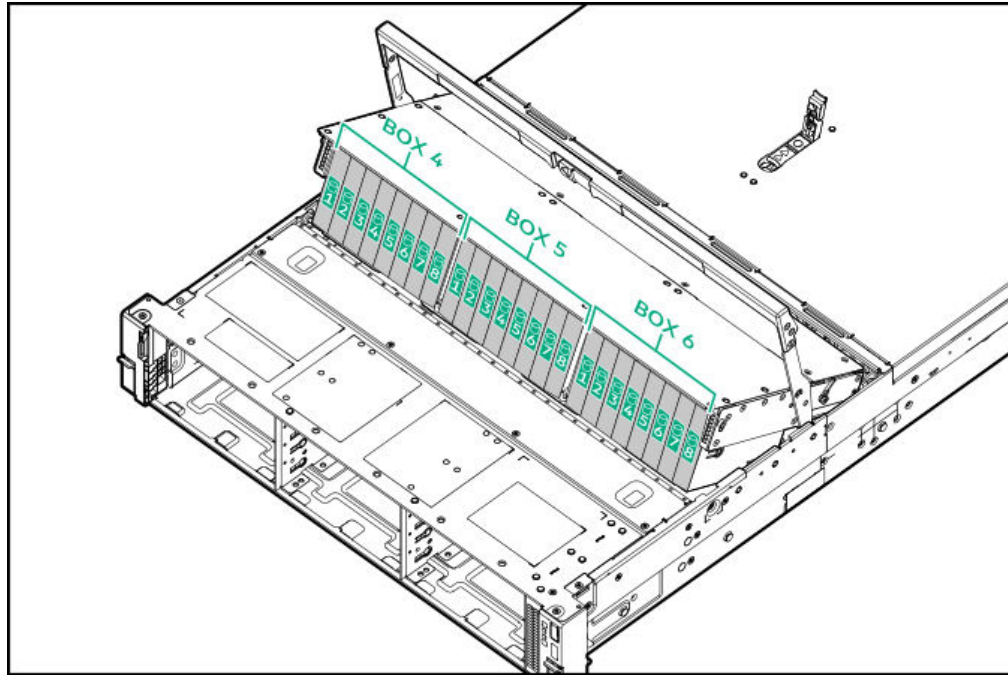

48 SFF

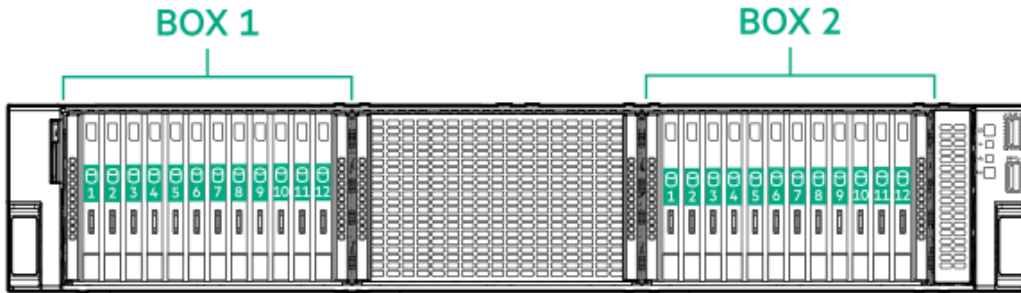

24 E3.S EDSFF

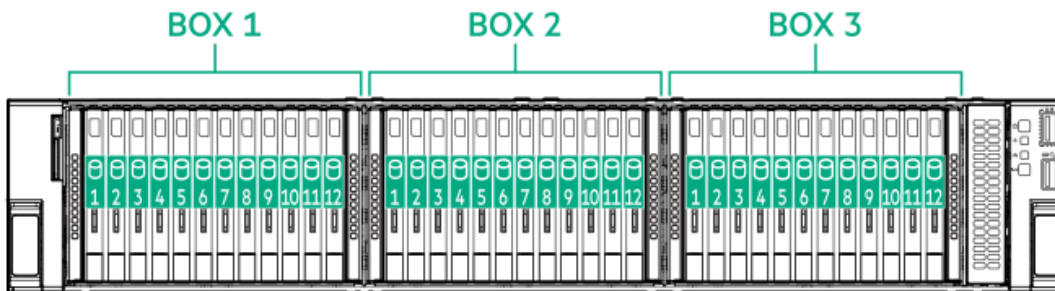

36 E3.S EDSFF



Storage

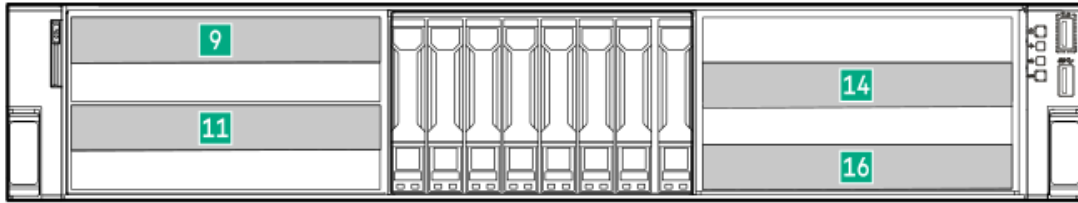

GPU Server with 8 SFF NVMe (Image shows both 4 single-wide and 4 double-wide GPU scenarios)



GPU Server with 8 EDSFF



Technical Specifications

System Unit

Dimensions

- **SFF Drives**
8.75 x 43.47 x 64.64 cm; 3.44 x 17.11 x 25.44 in
- **LFF Drives**
8.75 x 43.47 x 66.3 cm; 3.44 x 17.11 x 26.1 in
- **EDSFF Drives**
8.75 x 43.47 x 64.6 cm; 3.44 x 17.11 x 25.4 in
- **48SFF Drives**
8.75 x 43.47 x 83.3 cm; 3.44 x 17.11 x 32.8 in
- **GPU**
8.75 x 43.47 x 79.9 cm; 3.44 x 17.11 x 31.4 in
- **Packaging**
 - (SFF, LFF, EDSFF) 99.8 x 60 x 27 cm; 39.29 x 23.63 x 10.63 in
 - (GPU, 48SFF) 106.0 x 60 x 27 cm; 41.73 x 23.63 x 10.63 in

Weight (approximate)

- **SFF configuration**
 - **Maximum** 33.4 kg / 73.48 lbs with 24 hard drives
Packaged weight: 39.54 kg
 - **Minimum** 16.78 kg / 36.92 lbs 8 SFF chassis with 1x SFF HDD and 7 HDD blanks, 2x Drive Bay blanks, 1x processor including standard heat sink, 1x power supply (plus blank), 1x Smart Array, 1x Riser installed, cables for the above)
Packaged weight: 26.2 kg
- **LFF configuration**
 - **Maximum** 36.72 kg / 80.78 lbs with 12x LFF hard drives (no rear drives), 2x processors, 2x power supplies, 1x Smart Array, 2x Risers installed)
Packaged weight: 42.82 kg
 - **Minimum** 18.24 kg / 40.13 lbs with 1x LFF hard drive and 7 HDD blanks
Packaged weight: 28.42 kg
- **48SFF configuration**
 - **Maximum** 41.41 kg / 91.29 lbs with 48x SFF HDD, 2x processors, 4x power supplies, 2x OCP NIC cards, 2 DIMMs (plus 22 DIMM blanks)
 - **Minimum** 20.47 kg / 45.13 lbs with 1x SFF HDD, 1x processor, 1x power supply, 1x DIMM (no DIMM blank)
- **GPU configuration**
 - **Maximum** 32.52 kg / 71.69 lbs with 8x SFF HDD, 2x processors, 4x power supplies, 2x OCP NIC cards, 1 DIMM (plus 23 DIMM blanks), 4x DW GPUs
 - **Minimum** 20.04 kg / 44.18 lbs with 1x SFF HDD, 1x processor, 1x power supply, 1x DIMM, 4x DW GPUs

Input Requirements (per power supply)

Rated Line Voltage

- For 1600W (Platinum): 200 to 240 VAC
- For 1000W (Titanium): 100 to 240 VAC
- For 800W (Platinum): 100 to 240 VAC For 1600W (-48 VDC): -40 to -72 VdC



Technical Specifications

BTU Rating

Maximum

- For 1600W (Platinum) Power Supply: 5918 BTU/hr (at 200 VAC), 5884 BTU/hr (at 240 VAC) for China
- For 1000W (Titanium) Power Supply: 3741 BTU/hr (at 100 VAC), 3596 BTU/hr (at 200 VAC), 3582 BTU/hr (at 240 VAC) for China
- For 800W (Platinum) Power Supply: 3207 BTU/hr (at 100 VAC), 3071 BTU/hr (at 200 VAC), 3112 BTU/hr (at 240 VAC) for China Only
- For 1600W (-48VDC) Power Supply: 6026 BTU/hr (at -40 Vdc), 6000 BTU/hr (at -48 Vdc), 5989 BTU/hr (at -72 Vdc)

Power Supply Output (per power supply)

Rated Steady-State Power

- For 1600W (Platinum) Power Supply: 1600W (at 240 VAC), 1600W (at 240 VDC) input for China only
- For 1000W (Titanium) Power Supply: 1000W (at 100 VAC), 1000W (at 240 VAC), 1000W (at 240 VDC) input for China only
- For 800W (Platinum) Power Supply: 800W (at 100 VAC), 800W (at 240 VAC), 800W (at 240 VDC) input for China only
- For 1600W (-48VDC) Power Supply: 1600W (at -40 Vdc), 1600W (at -72Vdc)

Maximum Peak Power

- For 1600W (Platinum) Power Supply: 1600W (at 240 VAC), 1600W (at 240 VDC) input for China only
- For 1000W (Titanium) Power Supply: 1000W (at 100 VAC), 1000W (at 240 VAC), 1000W (at 240 VDC) input for China only
- For 800W (Platinum) Power Supply: 800W (at 100 VAC), 800W (at 240 VAC), 800W (at 240 VDC) input for China only
- For 1600W (-48VDC) Power Supply: 1600W (at -40 Vdc), 1600W (at -72 Vdc)

System Inlet Temperature

- **Standard Operating Temperature**

10° to 35°C (50° to 95°F) at sea level with an altitude derating of 1.0°C per every 305 m (1.8°F per every 1000 ft) above sea level to a maximum of 3050 m (10,000 ft), no direct sustained sunlight. Maximum rate of change is 20°C/hr (36°F/hr). The upper limit and rate of change may be limited by the type and number of options installed.

System performance during standard operating support may be reduced if operating with a fan fault or above 30°C (86°F).

- **Extended Ambient Operating Temperature**

For approved hardware configurations, the supported system inlet range is extended to be: 5° to 10°C (41° to 50°F) and 35° to 40°C (95° to 104°F) at sea level with an altitude derating of 1.0°C per every 175 m (1.8°F per every 574 ft) above 900 m (2953 ft) to a maximum of 3050 m (10,000 ft). The approved hardware configurations for this system are listed at the URL: <http://www.hpe.com/servers/ashrae>

For approved hardware configurations, the supported system inlet range is extended to be: 40° to 45°C (104° to 113°F) at sea level with an altitude derating of 1.0°C per every 125 m (1.8°F per every 410 ft) above 900 m (2953 ft) to a maximum of 3050 m (10,000 ft). The approved hardware configurations for this system are listed at the URL: <http://www.hpe.com/servers/ashrae>

System performance may be reduced if operating in the extended ambient operating range or with a fan fault.

- **Non-operating**

-30° to 60°C (-22° to 140°F). Maximum rate of change is 20°C/hr (36°F/hr).



Technical Specifications

Relative Humidity

- **Operating**
8% to 90% - Relative humidity (Rh), 28°C maximum wet bulb temperature, non-condensing.
- **Non-operating** (non-condensing)
5 to 95% relative humidity (Rh), 38.7°C (101.7°F) maximum wet bulb temperature, non-condensing.

Altitude

- **Operating**
3050 m (10,000 ft). This value may be limited by the type and number of options installed. Maximum allowable altitude change rate is 457 m/min (1500 ft/min).
- **Non-operating**
9144 m (30,000 ft). Maximum allowable altitude change rate is 457 m/min (1500 ft/min).

RTC Accuracy

- 50 ppm

Emissions Classification (EMC) – Regulatory Information

To view the regulatory information for your product, view the Safety and Compliance Information for Server, Storage, Power, Networking, and Rack Products, available at the Hewlett Packard Enterprise Support Center:

<http://www.hpe.com/support/Safety-Compliance-EnterpriseProducts>

Acoustic Noise

Listed are the declared mean A-Weighted sound power levels (LwAm), declared average bystander position A-Weighted sound pressure levels (LpAm) and the statistical adder for verification, Kv, is a quantity to be added to the declared mean A-weighted sound power level, LwA,m when the product is operating in a 23°C ambient environment. Noise emissions were measured in accordance with ISO 7779 (ECMA 74) and declared in accordance with ISO 9296 (ECMA 109). The listed sound levels apply to standard shipping configurations. Additional options may result in increased sound levels. Please have your HPE representative provide information from the HPE EMESC website for further technical details regarding the configurations listed below.

Idle	
LWAd	5.0 B Base
LpAm	36 dBA Base
Operating	
LWAd	5.5 B Base
LpAm	37 dBA Base

Notes:

- The declared mean A-weighted sound power level, LWA,m, is computed as the arithmetic average of the measured A-weighted sound power levels for a randomly selected sample, rounded to the nearest 0,1 B.
- The declared mean A-weighted emission sound pressure level, LpA,m, is computed as the arithmetic average of the measured A-weighted emission sound pressure levels at the bystander positions for a randomly selected sample, rounded to the nearest 1 dB.
- The statistical adder for verification, Kv, is a quantity to be added to the declared mean A-weighted sound power level, LWA,m, such that there will be a 95 % probability of acceptance, when using the verification procedures of ISO 9296, if no more than 6,5 % of the batch of new equipment, has A-weighted sound power levels greater than (LWA,m + Kv).
- The quantity, LWA,c (formerly called LWAd), can be computed from the sum of LWA,m and Kv.
- All measurements made to conform to ISO 7779 / ECMA-74 and declared to conform to ISO 9296 / ECMA-109.
- B, dB, abbreviations for bels and decibels, respectively, where 1 B = 10 dB.



Technical Specifications

- The results in this declaration apply only to the model numbers listed above when operating and tested according to the indicated modes and standards. A system with additional configuration components or increased operating functionality may increase the noise emission values.
-

Environment-friendly Products and Approach - End-of-life Management and Recycling

Hewlett Packard Enterprise offers **end-of-life product return, trade-in, and recycling programs** in many geographic areas, for our products. Products returned to Hewlett Packard Enterprise will be recycled, recovered or disposed of in a responsible manner.

The EU WEEE directive (2002/95/EC) requires manufacturers to provide treatment information for each product type for use by treatment facilities. This information (product disassembly instructions) is posted on the Hewlett Packard Enterprise web site. These instructions may be used by recyclers and other WEEE treatment facilities as well as Hewlett Packard Enterprise OEM customers who integrate and re-sell Hewlett Packard Enterprise equipment.



Summary of Changes

Date	Version History	Action	Description of Change
15-Jul-2024	Version 22	Changed	Pre-Configured Models section was updated.
01-Jul-2024	Version 21	Changed	Overview, Core Options and Additional Options sections were updated.
20-May-2024	Version 20	Changed	Added: <ul style="list-style-type: none"> - Nvidia H100 NVL 94GB GPU (S2D86C) - DL380a Gen11 16-pin GPU power cable for H100 NVL (P70192-B21) - 3.84TB, 7.68TB, 15.36TB P5430 E3.S EDSFF drives - New 128GB 2Rx4 4800 MT/s RDIMM
08-Apr-2024	Version 19	Changed	Core Options section was updated. (Removed OBS SKU P58228-B21)
18-Mar-2024	Version 18	Changed	Standard Features, Core Options and Additional Options sections were updated.
05-Feb-2024	Version 17	Changed	Configuration Information, Core Options and Memory sections were updated. Removed Obsolete SKUs (HPE Drives, SSD Selection and HPE Computation and Graphics Accelerator and related option kits).
08-Jan-2024	Version 16	Changed	Overview, Service and Support and Core Options sections were updated. Added new 8SW GPU Enablement Kit and 8SW GPU Switchboard Kit Added new CM7 EDSFF E3.S 1T drives Added a new Riser Support Matrix in the Configuration Information section Added new Thermal Support Matrices below Processor & Memory sections within the Configuration Information section
04-Dec-2023	Version 15	Changed	Overview, Standard Features, and Configuration Information sections were updated.
06-Nov-2023	Version 14	Changed	Overview, Standard Features, Service and Support, Configuration Information, and Additional Options sections were updated
02-Oct-2023	Version 13	Changed	Standard Features, Configuration Information and Additional Options sections were updated.
05-Sep-2023	Version 12	Changed	Configuration Information section was updated.
07-Aug-2023	Version 11	Changed	Standard Features, Configuration Information, Core Options, and Additional Options sections were updated
10-Jul-2023	Version 10	Changed	Standard Features, Service and Support, Configuration Information, Core Options, Additional Options and Memory sections were updated
13-Jun-2023	Version 9	Changed	Overview, Standard Features, Service and Support, Pre-Configured Models, and Core Options sections were updated.
01-May-2023	Version 8	Changed	Standard Features and Core Options sections were updated
17-Apr-2023	Version 7	Changed	Overview and Core Options sections were updated
03-Apr-2023	Version 6	Changed	Overview, Configuration Information and Core Options sections were updated.
06-Mar-2023	Version 5	Changed	Standard Features and Configuration Information sections were updated.
06-Feb-2023	Version 4	Changed	Overview, Standard Features, Configuration Information, additional Options and Technical Specifications sections were updated.
19-Dec-2022	Version 3	Changed	Standard Features section was updated.
05-Dec-2022	Version 2	Changed	Standard Features, Configuration Information, Core Options and Additional Options sections were updated.
10-Nov-2022	Version 1	New	New QuickSpecs

Copyright

**Make the right purchase decision.
Contact our presales specialists.**

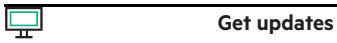

© Copyright 2024 Hewlett Packard Enterprise Development LP. The information contained herein is subject to change without notice. The only warranties for Hewlett Packard Enterprise products and services are set forth in the express warranty statements accompanying such products and services. Nothing herein should be construed as constituting an additional warranty. Hewlett Packard Enterprise shall not be liable for technical or editorial errors or omissions contained herein.

AMD® and EPYC® are registered trademarks of Advanced Micro Devices Corporation in the U.S. and other countries.

Microsoft®, Windows®, and Windows Server® are U.S. registered trademarks of the Microsoft group of companies.

For hard drives, 1GB = 1 billion bytes. Actual formatted capacity is less

a50004300enw - 16904 - Worldwide - V22 - 15-July-2024