

**SAMSUNG**

# USER GUIDE

SM-X350  
SM-X358U

English (USA). 05/2025. Rev.1.0

[www.samsung.com](http://www.samsung.com)

# Table of Contents

## Getting started

- 5 Device layout and functions
- 8 Charging the battery
- 13 Nano-SIM card and eSIM (Mobile network enabled models)
- 15 microSD™ card
- 17 Protective case
- 19 Turning the device on and off
- 19 Initial setup
- 20 Using networks
- 20 Samsung account
- 21 Transferring data from your previous device (Smart Switch)
- 21 Understanding the screen
- 28 Notification panel
- 29 Quick settings panel
- 31 Screen capture and screen record
- 33 Entering text
- 34 Extracting text

## Apps and features

- 35 Installing or uninstalling apps
- 37 S Pen
- 43 Phone
- 43 Contacts
- 47 Camera
- 58 Gallery

- 64 Bixby
- 65 Bixby Vision
- 66 Multi window (Using multiple apps at once)
- 67 Samsung Internet
- 68 Samsung Notes
- 72 Samsung Members
- 73 Samsung Kids
- 73 Samsung Global Goals
- 74 Samsung Find
- 74 Samsung Shop
- 74 Galaxy Shop
- 74 PENUP
- 75 Calendar
- 75 Reminder
- 76 Voice Recorder
- 77 My Files (Checking and managing the files)
- 77 Clock
- 77 Calculator
- 78 SmartThings
- 79 Sharing content
- 80 Music Share
- 81 Smart View (Mirroring on a TV screen)
- 82 Samsung Flow
- 83 Daily Board
- 85 Samsung DeX
- 87 Google apps

## Settings

88	Introduction	105	Home screen
88	Sign in to your Galaxy	106	Lock screen
88	Connections	106	Extend Unlock
90	Wi-Fi	107	Security and privacy
91	Bluetooth	108	Face recognition
93	NFC and contactless payments	110	Fingerprint recognition
94	Data saver (Mobile network enabled models)	113	Secure Wi-Fi
94	Allowed networks for apps (Mobile network enabled models)	114	Secure Folder
95	Mobile Hotspot (Mobile network enabled models)	117	Samsung Pass
95	More connection settings	118	Location
97	Connected devices	118	Safety and emergency
98	Modes and Routines	119	Accounts and backup
98	Using modes	120	Users
99	Using routines	121	Samsung Cloud
100	Sounds and vibration	122	Google
101	Sound quality and effects	122	Advanced features
101	Separate app sound	123	Motions and gestures
102	Notifications	123	Galaxy Avatar
102	Display	124	Dual Messenger
103	Motion smoothness	125	Digital Wellbeing and parental controls
104	Changing the screen mode or adjusting the display color	125	Device care
104	Battery	126	Apps
105	Wallpaper and style	127	General management
		128	Accessibility
		129	Software update
		129	Remote management
		130	About tablet

## **Usage notices**

- 131 Precautions for using the device
- 133 Notes on package contents and accessories
- 134 Maintaining water and dust resistance
- 135 Device overheating situations and solutions



## **Appendix**

- 139 Troubleshooting

# Getting started

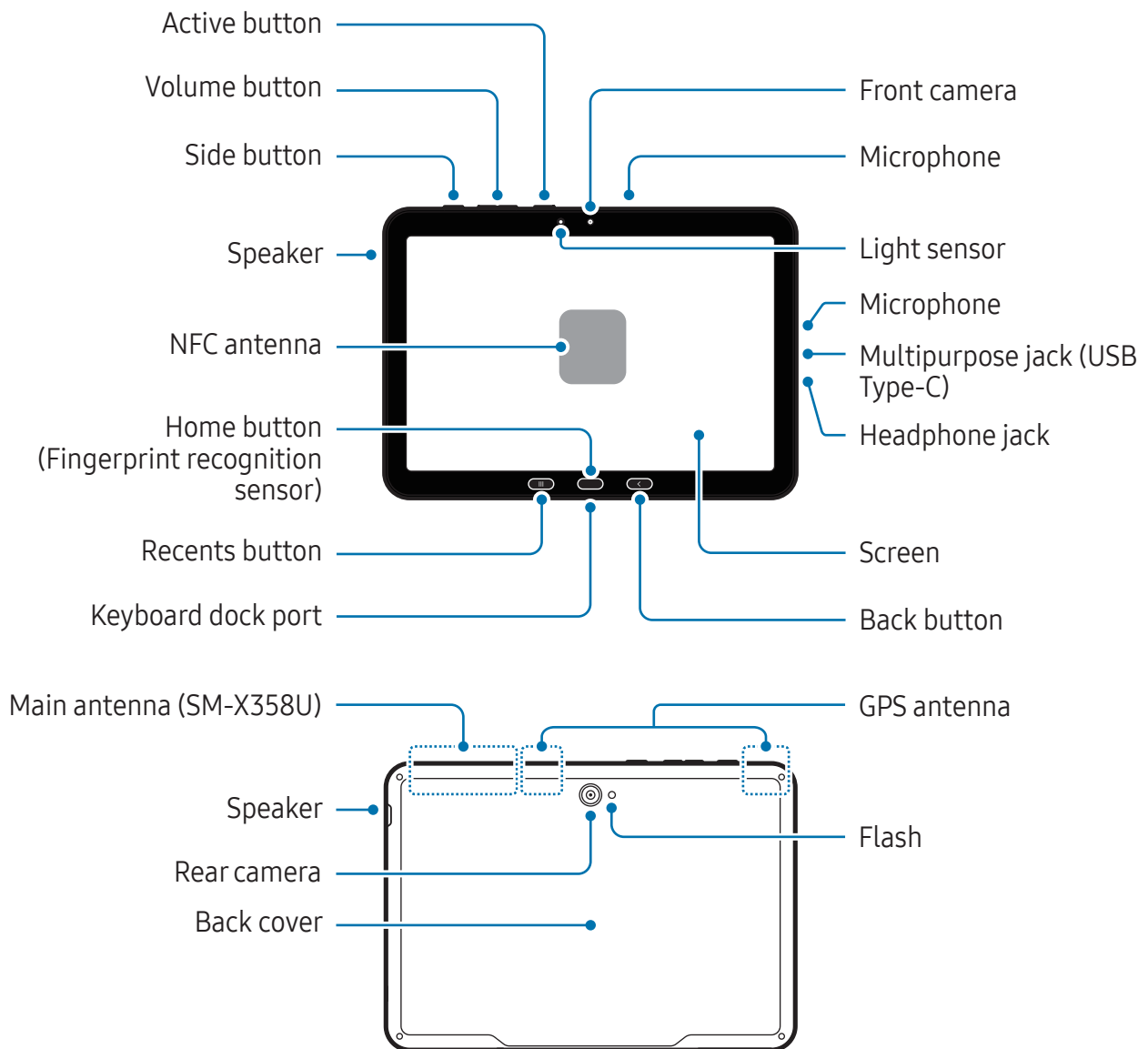
## Device layout and functions



-  When using the speakers, such as when playing media files or using speakerphone, do not place the device close to your ears.
- Be careful not to expose the camera lens to a strong light source, such as direct sunlight. If the camera lens is exposed to a strong light source, such as direct sunlight, the camera image sensor may be damaged. A damaged image sensor is irreparable and will cause dots or spots in pictures.
- If you use the device with its glass or acrylic body broken, there may be a risk of injury. Use the device only after it has been repaired at a Samsung Service Center or an authorized service center.
- If dust or foreign materials enter the microphone, speaker, or receiver, or if these parts are covered, the device's sound may become quiet or certain features may not work. If you attempt to remove the dust or foreign materials with a sharp object, the device may be damaged and its appearance may be affected.
-  Connectivity problems and battery drain may occur in the following situations:
  - If you attach metallic stickers on the antenna area of the device
  - If you attach a device cover made with metallic material to the device
  - If you cover the device's antenna area with your hands or other objects while using certain features, such as calls or the mobile data connection
- Do not cover the light sensor area with accessories, such as stickers or a cover. Doing so may cause the sensor to malfunction.

## Hard buttons

Button	Function
Side button	<ul style="list-style-type: none"> <li>• When the device is off, press and hold to turn it on.</li> <li>• Press to turn on or lock the screen.</li> <li>• Press and hold to start a conversation with Bixby. Refer to <a href="#">Bixby</a> for more information.</li> <li>• Press twice or press and hold to open the app or feature you set.</li> </ul>
Side button + Volume Down button	<ul style="list-style-type: none"> <li>• Press simultaneously to capture a screenshot.</li> <li>• Press and hold simultaneously to turn off the device.</li> </ul>
Active button	Press or press and hold to launch preset apps.
Recents button	Press to open the list of recent apps.
Home button	<ul style="list-style-type: none"> <li>• Press to turn on the screen while the screen is locked.</li> <li>• Press to return to the Home screen.</li> <li>• Press and hold to launch <b>Circle to Search</b>. Tap or draw a circle around an image or text.</li> </ul>
Back button	Press to return to the previous screen.

### Setting the Side button

Select an app or feature to launch by pressing the Side button twice or pressing and holding the Side button.

Open **Settings**, tap **Advanced features** → **Side button**, and then select an option you want.

### Setting the Active button

Select an app to launch by pressing or pressing and holding the Active button.

Open **Settings**, tap **Advanced features** → **Active button**, and then select an option you want.

## Charging the battery

Charge the battery before using it for the first time or when it has been unused for extended periods.

### Inserting the battery

- 1 Remove the back cover.

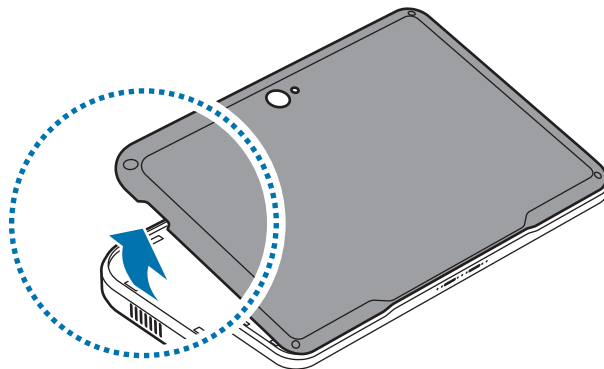

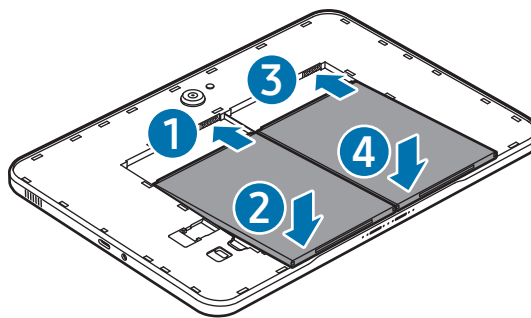

- ⚠ Be careful not to damage your fingernails when you remove the back cover.
  - ⚠ Do not bend or twist the back cover excessively. Doing so may damage the cover.
- 2 Insert the battery with the battery's gold-colored contacts properly aligned with the device's contacts.

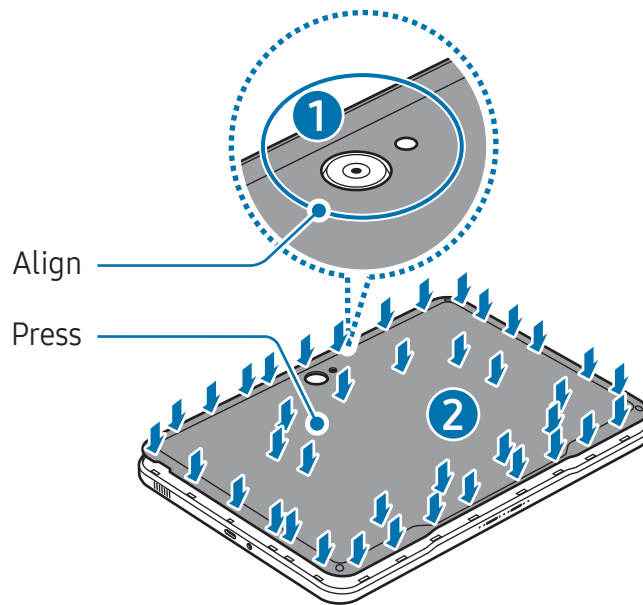

- 📝 Only one battery can be replaced. When the battery is removed while the device is turned on, the screen will turn off, and some features will be limited. After the battery is replaced, the screen will turn on, and the limited features will be reactivated.

### 3 Replace the back cover.



-  Ensure that the back cover is closed tightly to prevent water and dust from entering the device. Open or loose back cover may allow water and dust to enter the device and cause damage.
-  Use only compatible accessories. Damage caused by use of accessories which are not compatible may not be covered by warranty.

## Removing the battery

- 1 Remove the back cover.
- 2 Pull out the battery.

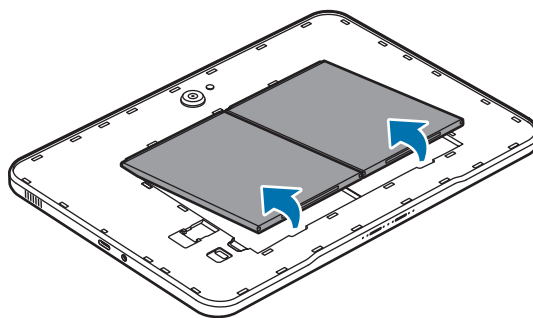

## Wired charging

Connect the USB cable to the USB power adapter and plug the cable into the device's multipurpose jack to charge the battery. After fully charging, disconnect the charger from the device.

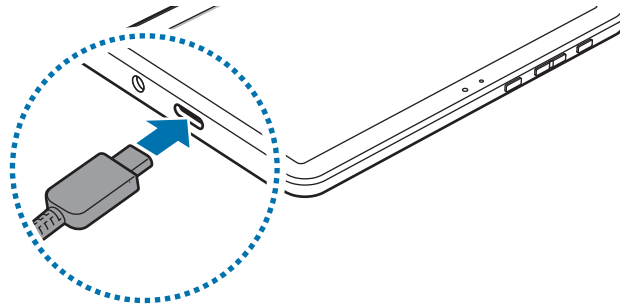

 Do not remove the battery before removing the charger. This may damage the device.

## Quick charging

Use a fast charger.

You can check the connection status of the charger by opening **Settings** and tapping **Battery**.

-  • If fast charging does not work, open **Settings**, tap **Battery** → **Charging settings**, and then check if the feature you want is turned on. Also, check if the USB cable and the USB power adapter are connected properly.
- You can charge the battery more quickly while the device or its screen is turned off.

## Charging other devices

Use the USB cable to charge another mobile device with your tablet's battery.

Connect your tablet and the other device using your tablet's USB cable. A USB connector may be needed depending on the other device.

When charging starts, the battery charging icon will appear on the other device's screen.



-  The app selection pop-up window that appears on your tablet is for data transfer. Do not select an app from the pop-up window.

## Reducing the battery consumption

Your device provides various options that help you conserve battery power.

- Optimize the device using the device care feature.
- When you are not using the device, turn off the screen by pressing the Side button.
- Turn on power saving mode.
- Close unnecessary apps.
- Turn off the Bluetooth feature when not in use.
- Turn off auto-syncing of apps that need to be synced.
- Decrease the backlight time.
- Decrease the screen brightness.

## Battery charging tips and precautions

-  To avoid injury or damage to your device, do not use incompatible, worn or damaged batteries, chargers or cables.
- 
  - Connecting the charger improperly may cause serious damage to the device.
  - Use only USB Type-C cable supplied with the device. The device may be damaged if you use Micro USB cable.
  - If you charge the device while the multipurpose jack is wet, the device may be damaged. Thoroughly dry the multipurpose jack before charging the device.
- 
  - To save energy, unplug the charger when not in use. The charger does not have a power switch, so you must unplug the charger from the electric socket when not in use to avoid wasting power. The charger should remain close to the electric socket and easily accessible while charging.
  - For best charging performance, use only compatible chargers.
  - If the battery is completely discharged, the device cannot be turned on immediately when the charger is connected. Allow a depleted battery to charge for a few minutes before turning on the device.
  - If you use multiple apps at once, network apps, or apps that need a connection to another device, the battery will drain quickly. To avoid losing power during a data transfer, always use these apps after fully charging the battery.
  - Using a power source other than the charger, such as a computer, may result in a slower charging speed because of a lower electric current.
  - The device can be used while it is charging, but it may take longer to fully charge the battery.
  - If the device receives an unstable power supply while charging, the screen may not function. If this happens, unplug the charger from the device.
  - While charging, the device and the charger may heat up. This is normal and should not affect the device's lifespan or performance. If the battery gets hotter than usual, the charger may stop charging.
  - If the device is not charging properly, take the device and the charger to a Samsung Service Center or an authorized service center.
  - Remove the battery before storing your device when it will not be in use for a long period of time.

## Nano-SIM card and eSIM (Mobile network enabled models)

Insert the SIM card or download the eSIM provided by your carrier.

Differing from a physical nano-SIM card, an eSIM is an embedded digital SIM. To have two phone numbers or carriers for a single device, download another eSIM.



- eSIM may not be available depending on the region, carrier, or model.
- Some services that require a network connection may not be available depending on the carrier.
- Using both the nano-SIM card and the eSIM, or two eSIMs may result in slower data transfer speeds in some areas.

### Inserting the SIM card

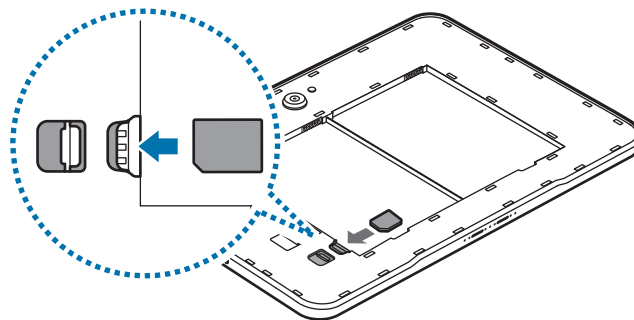

- 1 Remove the back cover and battery.
- 2 Insert the SIM card with the gold-colored contacts facing downwards.
- 3 Replace the battery and back cover.



- Use only a nano-SIM card.
- Use caution not to lose or let others use the SIM card. Samsung is not responsible for any damages or inconveniences caused by lost or stolen cards.
- Do not insert an SD card into the SIM card slot. If an SD card happens to be lodged in the SIM card slot, take the device to a Samsung Service Center or an authorized service center to remove the SD card.



If you insert the SIM card for the first time while the device is turned on, restart the device to recognize it. When replacing the SIM card after removing one battery, it must be replaced within a certain period of time. If the SIM card is not recognized, restart the device.

## Downloading an eSIM

Open **Settings**, tap **Connections** → **SIM manager** → **Add eSIM**, and then follow the on-screen instructions to download the eSIM.

If you have a QR code provided by your carrier, open **Settings**, tap **Connections** → **SIM manager** → **Add eSIM** → **Scan QR code**, and then scan the QR code.

## SIM manager

Open **Settings** and tap **Connections** → **SIM manager**.

- **SIM cards:** Activate the SIM card to use and customize the SIM card settings.
- **eSIMs:** Download or activate the eSIM.
- **Mobile data:** Select to use specific SIM cards when two cards are activated.
- **More SIM settings:** Customize additional settings.

## microSD™ card

### Inserting an SD card

Your device's SD card capacity may vary from other models and some SD cards may not be compatible with your device depending on the SD card manufacturer and type. To check out your device's maximum SD card capacity, refer to the Samsung website.

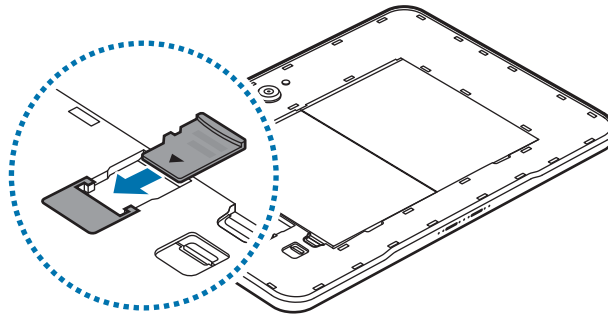

- 1 Remove the back cover.
  - 2 Insert an SD card with the gold-colored contacts facing downwards.
  - 3 Replace the back cover.
- ⚠ • Use only a microSD card.
  - Some SD cards may not be fully compatible with the device. Using an incompatible card may damage the device, the SD card, or the data stored in it.
  - Use caution to insert the SD card right-side up.
  - ✍ • The device supports the FAT and the exFAT file systems for SD cards. When inserting a card formatted in a different file system, the device will ask to reformat the card or will not recognize the card. To use the SD card, you must format it. If your device cannot format or recognize the SD card, contact the SD card manufacturer, a Samsung Service Center or an authorized service center.
  - Frequent writing and erasing of data shortens the lifespan of SD cards.
  - When inserting an SD card into the device, the SD card's file directory appears in the **My Files** → **SD card** folder.

## Removing the SD card

Before removing the SD card, first unmount it for safe removal.

- 1 Open **Settings** and tap **Device care** → **Storage**.
- 2 Swipe to the left to access the **SD card** page.
- 3 Tap the More options icon (⋮) → **Unmount**.

 Do not remove external storage, such as an SD card or USB storage, while the device is transferring or accessing information, or right after transferring data. Doing so can cause data to be damaged or lost or cause damage to the external storage or tablet. Samsung is not responsible for losses, including loss of data, resulting from the misuse of external storage devices.

## Formatting the SD card

An SD card formatted on a computer may not be compatible with the device. Format the SD card on the device.

- 1 Open **Settings** and tap **Device care** → **Storage**.
- 2 Swipe to the left to access the **SD card** page.
- 3 Tap the More options icon (⋮) → **Format**.

 Before formatting the SD card, remember to make backup copies of all important data stored in the SD card. The manufacturer's warranty does not cover loss of data resulting from user actions.

## Protective case

- ⚠ Detach the S Pen from the case before installing or removing the case to avoid damaging the S Pen.

### Installing the protective case

Insert the upper part of the device into the case, and then press the edges of the bottom part one by one using both hands to firmly install it.

1

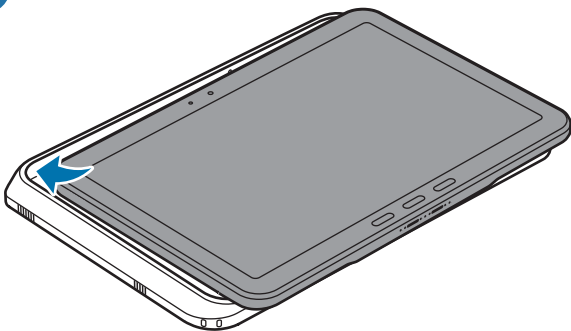

2

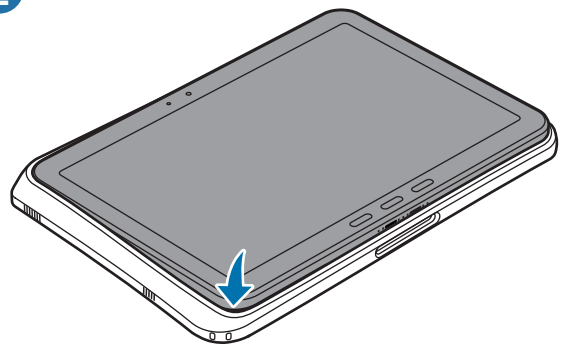

3

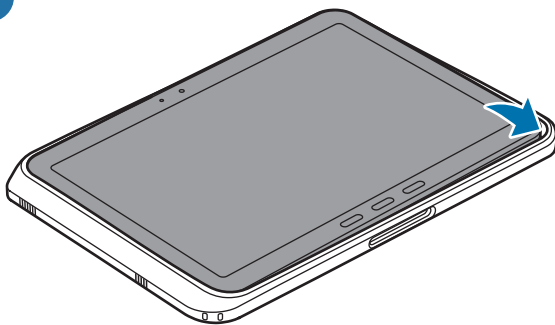

4

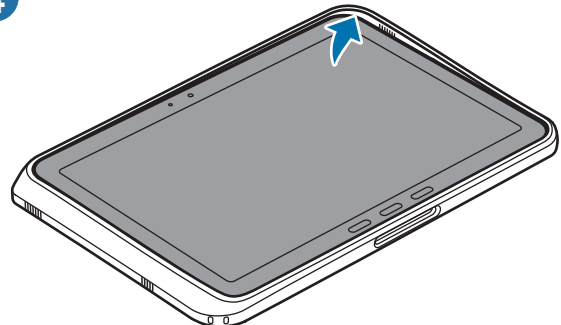

## Removing the protective case

With the device upright, push the edges of the left part one by one using both hands until the device protrudes from the case and remove the device from it.

1

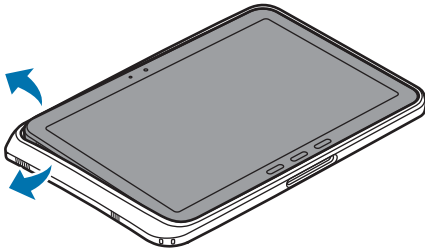

2

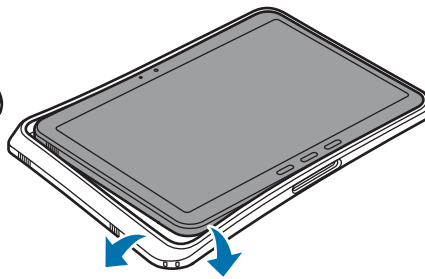

3

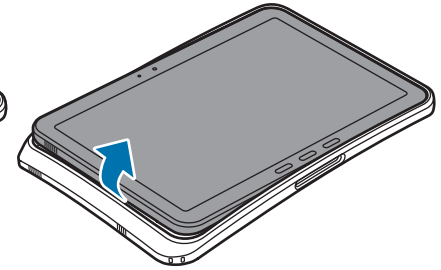

## Inserting the S Pen

Insert the S Pen into the left of the protective case.

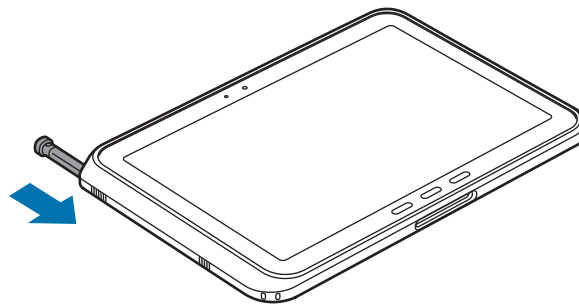

**!** Do not insert the S Pen backwards into the protective case.

## Turning the device on and off

-  Follow all posted warnings and directions from authorized personnel in areas where the use of wireless devices is restricted, such as airplanes and hospitals.

### Turning the device on

Press and hold the Side button for a few seconds to turn on the device.

### Turning the device off

- 1 To turn off the device, press and hold the Side button and the Volume Down button simultaneously. Alternatively, open the quick settings panel and tap the Power off icon (🔌).
  - 2 Tap **Power off** → **Power off**.  
To restart the device, tap **Restart** → **Restart**.
-  If you want to set the device to turn off when you press and hold the Side button, tap **Side button settings** → **Long press** → **Power off menu**.

### Forcing restart

If your device is frozen and unresponsive, press and hold the Side button and the Volume Down button simultaneously for more than 7 seconds to restart it.

## Initial setup

When you turn on your device for the first time or after performing a data reset, follow the on-screen instructions to set up your device.

-  If you do not connect to a Wi-Fi network, you might not be able to set up some device features during the initial setup.

## Using networks

You can use networks, such as a Wi-Fi, Bluetooth, NFC, or mobile network.

Open **Settings**, tap **Connections**, and then tap the switch of the desired network to turn it on.

For the mobile network, tap **Data usage** and tap the **Mobile data** switch to turn it on.

When not using the network, tap the switch to turn it off.

 Some features may not be available depending on the model.

## Samsung account

Using the Samsung account, you can use a variety of Samsung services that are provided through mobile devices, TVs, and the Samsung website.

To check the list of services that can be used with your Samsung account, visit [account.samsung.com](https://account.samsung.com).

- 1 Open **Settings** and tap **Sign in to your Galaxy**.  
Alternatively, open **Settings** and tap **Accounts and backup** → **Manage accounts** → **Add account** → **Samsung account**.
- 2 Sign in to your Samsung account. If you do not have a Samsung account, tap **Forgot password or don't have an account?** → **Create account**.

### Finding your ID and resetting your password

If you forget your Samsung account ID or password, tap **Forgot password or don't have an account?** → **Forgot ID** or **Forgot password** on the Samsung account sign-in screen.

You can find your ID or reset your password after you enter the required information.

### Signing out of your Samsung account

When you sign out of your Samsung account, your data, such as contacts or events, will also be removed from your device.

- 1 Open **Settings** and tap **Accounts and backup** → **Manage accounts**.
- 2 Tap **Samsung account** → **My profile** and tap **Sign out** at the bottom of the screen.
- 3 Tap **Sign out**, enter your Samsung account password, and then tap **OK**.

## Transferring data from your previous device (Smart Switch)

Transfer data from your previous device with the USB cable or wirelessly. You can also transfer data from external storage or computer.

Open **Settings**, tap **Accounts and backup** → **Transfer data for device setup**, and then follow the on-screen instructions to transfer data.

Visit [www.samsung.com/smartswitch](http://www.samsung.com/smartswitch) for details and limitations.

- To transfer data using external storage, tap the External storage icon (📁).
- To check the data that has been transferred, tap the More options icon (⋮) →

### Transfer result.

- 📝 • This feature may not be supported on some devices or computers.
- Samsung takes copyright seriously. Only transfer content that you own or have the right to transfer.

## Understanding the screen

### Controlling the screen

- Tapping: Tap the screen.
- Touching and holding: Touch and hold the screen for approximately 2 seconds.
- Dragging: Touch and hold an item and drag it to the target position.
- Double tapping: Double tap the screen.
- Swiping: Swipe upwards, downwards, to the left, or to the right.
- Spreading and pinching: Spread two fingers apart or pinch on the screen.

- ⚠ • Do not allow the screen to come into contact with other electrical devices. Electrostatic discharges can cause the screen to malfunction.
  - To avoid damaging the screen, do not tap it with anything sharp or apply excessive pressure to it with your fingertips or other object.
  - It is recommended not to use fixed graphics on part or all of the screen for extended periods. Doing so may result in afterimages (screen burn-in) or ghosting.
- 📝 The device may not recognize touch inputs close to the edges of the screen, which are outside of the touch input area.

## Home screen and Apps screen

The Home screen is the starting point for accessing all of the device's features. It displays widgets, shortcuts to apps, and more.

The Apps screen displays icons for all apps, including newly installed apps.

### Switching between Home and Apps screens

On the Home screen, swipe upwards to open the Apps screen.

To return to the Home screen, swipe upwards or downwards on the Apps screen. Alternatively, press the Home button or the Back button.

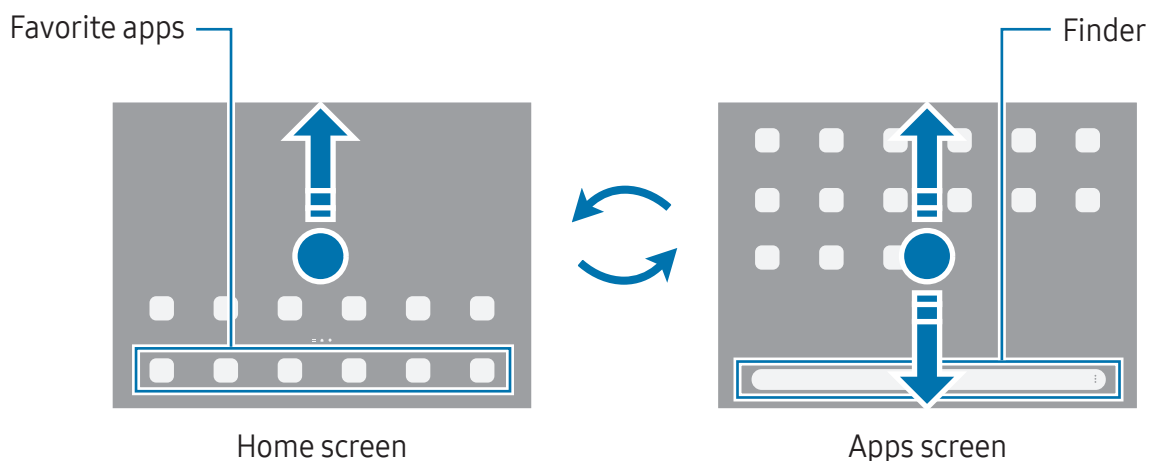

If you add the Apps button on the Home screen, you can open the Apps screen by tapping the button. On the Home screen, touch and hold an empty area, tap **Settings**, and then tap the **Show Apps screen button on Home screen** switch to turn it on. The Apps button (📱) will be added at the bottom of the Home screen.

## Editing the Home screen

On the Home screen, touch and hold an empty area, or pinch your fingers together to access the editing options. You can set the wallpaper, add widgets, and more.

- **Wallpaper and style:** Change the wallpaper settings for the Home screen and the locked screen.
- **Widgets:** Widgets are small apps that launch specific app features to provide information and convenient access on your Home screen. Select a widget and tap **Add**. The widget will be added on the Home screen.
- **Settings:** Configure settings for the Home screen, such as the screen layout.

You can also add, delete, or rearrange Home screen panels.

- Adding panels: Swipe to the left, and then tap the Add page icon (+).
- Moving panels: Drag a panel preview to a new location.
- Deleting panels: Tap the Remove icon (🗑️) on the panel.

## Displaying all apps on the Home screen

Without using a separate Apps screen, you can set the device to display all apps on the Home screen. On the Home screen, touch and hold an empty area, and then tap **Settings** → **Home screen layout** → **Home screen only** → **Apply**.

## Launching Finder

Search for content on the device.

1 On the Apps screen, tap **Search**.

2 Enter a keyword.

Apps and content on your device will be searched.

If you tap the Search icon (🔍) on the keyboard, you can search for more content.

## Moving items

Drag an item to a new location. To move the item to another panel, drag it to the side of the screen. If you touch and hold an item and tap **Select**, you can select more items and move them together at once.

To add a shortcut to an app on the Home screen, touch and hold an item on the Apps screen, and then tap **Add to Home**. A shortcut to the app will be added on the Home screen.

You can also move frequently used apps to the shortcuts area at the bottom of the Home screen.

## Creating folders

On the Home screen or the Apps screen, drag an app over another app.

A new folder containing the selected apps will be created. Tap **Folder name** and enter a folder name.

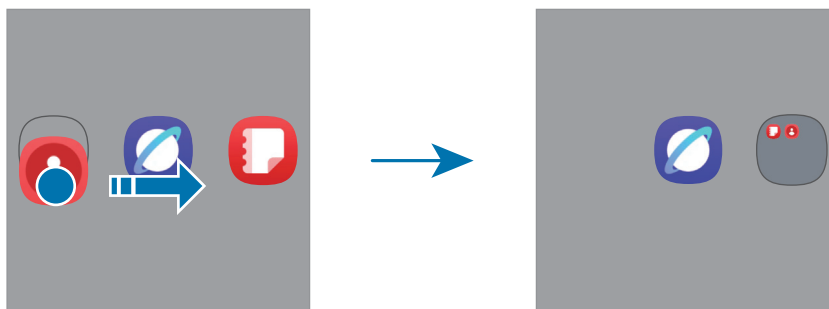

- **Adding more apps**

Tap the Add apps icon (⊕) on the folder. Tick the apps to add and tap **Done**. You can also add an app by dragging it to the folder.

- **Moving apps from a folder**

Drag an app to a new location.

- **Deleting a folder**

Touch and hold a folder, and then tap **Delete**. Only the folder will be deleted. The folder's apps will be relocated to the Apps screen.

## Taskbar

The taskbar appears at the bottom of screen while using an app. The favorite apps from the bottom of the Home screen, recently used apps, and the all apps button will be displayed on the taskbar. You can switch apps by selecting the app you want from the taskbar.

You can also run multiple apps at the same time. While using an app, drag the app you want from the taskbar upwards, and then drop it wherever you want.

 If you do not want to use the taskbar, open **Settings**, tap **Display**, and then tap the **Taskbar** switch to turn it off.

## Edge panel

You can access your favorite apps and features from the Edge panels.

Drag the Edge panel handle towards the center of the screen.

If the Edge panel handle is not visible, open **Settings**, tap **Display**, and then tap the **Edge panels** switch to turn it on.

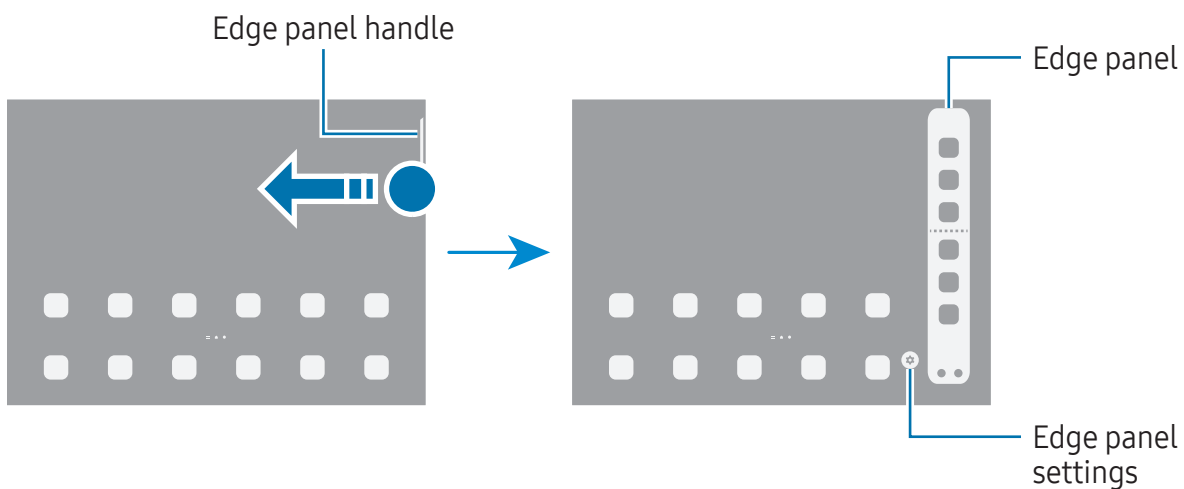

## Lock screen

Pressing the Side button turns off the screen and locks it. Also, the screen turns off and automatically locks if the device is not used for a specified period.

To unlock the screen, swipe in any direction except downwards when the screen turns on.

If the screen is off, press the Side button to turn on the screen. Alternatively, double tap the screen.

## Editing shortcuts

You can change the shortcuts at the bottom of the locked screen to other apps or features you want.

Touch and hold on the locked screen, tap the shortcut icon, select an app or feature you want, and then tap **Done**.

## Changing the screen lock method

To change the screen lock method, open **Settings**, tap **Lock screen** → **Screen lock and biometrics**, and then select a method.

When you set a pattern, PIN, password, or your biometric data for the screen lock method, you can protect your personal information by preventing others from accessing your device. After setting the screen lock method, the device will require an unlock code whenever unlocking it.

 You can set your device to perform a factory data reset if you enter the unlock code incorrectly several times in a row and reach the attempt limit. Open **Settings**, tap **Lock screen** → **Secure lock settings**, unlock the screen using the preset screen lock method, and then tap the **Auto factory reset** switch to turn it on.

## Indicator icons

Indicator icons appear on the status bar at the top of the screen. The icons listed in the table are most common.

Icon	Meaning
•	New notifications
	No signal
	Signal strength
	Roaming (outside of normal service area)
	GPRS network connected
	EDGE network connected
	UMTS network connected
	HSDPA network connected
	HSPA+ network connected
	LTE network connected
	5G network connected
	LTE network connected in LTE network that includes the 5G network
	Wi-Fi connected
	Bluetooth feature turned on
	Location services being used
	Call in progress
	Missed call
	Alarm turned on
	Mute mode / Vibration mode
	Airplane mode turned on
	Error occurred or caution required
	Battery charging / Battery power level



- The status bar may not appear at the top of the screen in some apps. To display the status bar, drag down from the top of the screen.
- Some indicator icons appear only when you open the notification panel.
- Some notifications will be displayed as a dot.
- The indicator icons may appear differently depending on the carrier or model.

## Notification panel

When you receive new notifications, indicator icons appear on the status bar. Open the notification panel to check the details.

To open the notification panel, swipe downwards from the top of the screen, except for the right side. To close the notification panel, swipe upwards on the screen.

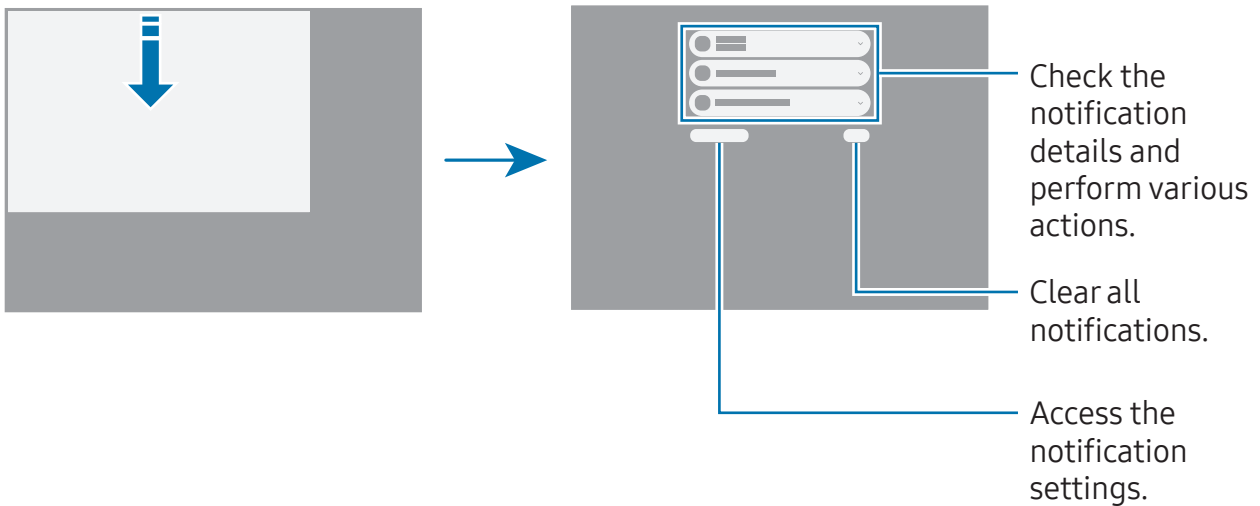

## Quick settings panel

You can turn specific features on or off, such as the Wi-Fi or Bluetooth feature, by tapping each button.

To open the quick settings panel, swipe downwards from the top right side of the screen. To close the quick settings panel, swipe upwards on the screen.

To access more detailed settings, touch and hold a button. To edit buttons, tap the Edit icon (✎) → **Edit**.

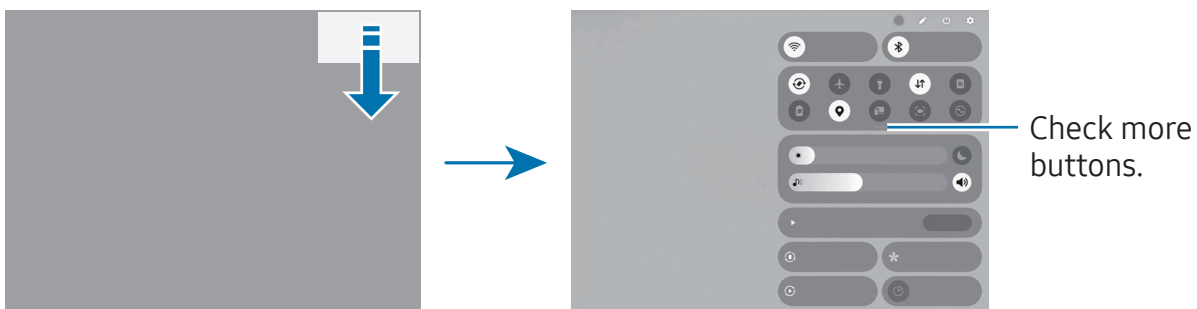

 This image may differ depending on the region or model.

## Controlling media playback

Control media on your tablet and connected nearby devices on the quick settings panel.

- 1 Open the quick settings panel and tap **Media output**.
- 2 Tap the icons on the controller to control the playback.

## Controlling nearby devices

Control nearby connected devices or connect other nearby devices on the quick settings panel.

- 1 Open the quick settings panel and tap **Nearby devices**.  
Nearby connected devices will appear with a line connecting them to the circle around your tablet.
- 2 Select a nearby device to control it.
  - To connect other nearby devices, drag a device from the panel at the bottom of the screen to the circle.
  - To end the connection, drag the device to the panel at the bottom of the screen.

## Controlling frequently used devices

Control devices connected to device control apps, such as SmartThings, and manual routines on the quick settings panel.

- 1 Open the quick settings panel and tap **SmartThings**.
- 2 Tap the switch next to the app you want to turn on and tap **Start**.  
Connected devices and manual routines will appear.
- 3 Select a device to control it, or select a manual routine to launch it.

# Screen capture and screen record

## Screen capture

Capture a screenshot while using the device and write on, draw on, crop, or share the captured screen. You can capture the current screen and scrollable area.

### How to capture a screenshot

Use the following methods to capture a screenshot. You can check the captured screenshots in **Gallery**.

- Button capture

Press the Side button and the Volume Down button simultaneously.

- Swipe capture





With the edge of your hand, swipe your hand to the left or right across the screen.



If capturing a screenshot by swiping is not turned on, open **Settings**, tap **Advanced features** → **Motions and gestures**, and then tap the **Palm swipe to capture** switch to turn it on.



It is not possible to capture a screenshot while using some apps and features.







After capturing a screenshot, use the following options on the toolbar at the bottom of the screen:

- : Capture the current content and the hidden content on an elongated page, such as a webpage. When you tap the Scroll capture icon () , the screen will automatically scroll down and more content will be captured.
- : Write or draw on the screenshot or crop a portion from the screenshot. You can check the cropped area in **Gallery**.
- **#** : Add tags to the screenshot. To search for screenshots by tag, open the **Gallery** app and tap the Search icon (**Q**). You can access the tags list and search for the screenshot you want. If the tags list does not appear, tap the More options icon () → **Search settings** → **Search categories** and tap the **My tags** switch to turn it on.

- : Share the screenshot with others.
  - : Select an area and perform actions, such as sharing or saving. Tap or draw a circle around the content you want to select. Then, select an option to use with the selected area.
-  If the options are not visible on the captured screen, open **Settings**, tap **Advanced features** → **Screenshots and screen recordings**, and then tap the **Show toolbar after capturing** switch to turn it on.

## Screen record

Record the screen while using your device.

- 1 Open the quick settings panel, tap the Expand icon (—), and then tap **Screen recorder** ().
  - 2 Select a sound setting and tap **Start recording**.  
After a countdown, recording will start.
    - To write or draw on the screen, tap the Draw icon (.
    - To show the S Pen pointer on the screen, tap the Pointer icon (.
    - To record the screen with a video overlay of yourself, tap the Selfie video icon (.
  - 3 When you are finished recording the video, tap the Stop icon ().  
You can check the video in **Gallery**.
-  To change the screen recorder settings, open **Settings** and tap **Advanced features** → **Screenshots and screen recordings**.

# Entering text

## Keyboard layout

A keyboard appears automatically when you enter text.

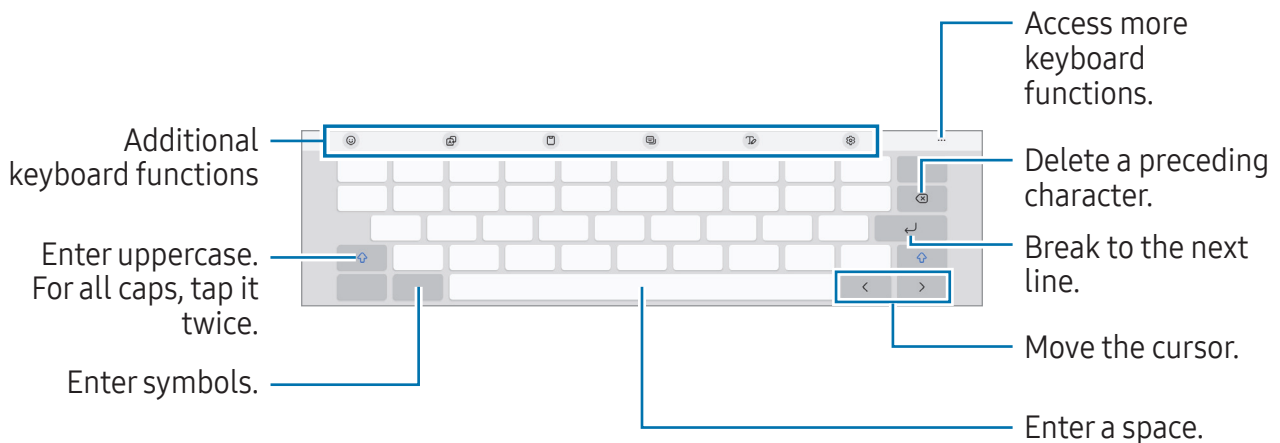

 Text entry is not supported in some languages. To enter text, you must change the input language to one of the supported languages.

## Changing the input language



Tap the Settings icon (⚙️) → **Languages and types** → **Manage input languages** and select the languages to use. When you select two or more languages, you can switch between the input languages by tapping the Change language icon (🌐).

To change the keyboard type, tap the Settings icon (⚙️) → **Languages and types**, select a language, and then select the keyboard type you want.

## Using the keyboard button







You can change the text input method by tapping the keyboard button on the taskbar.

To change the keyboard button on the taskbar, touch and hold the keyboard button and select an option you want.



-  : Enter text by voice.
-  : Change the keyboard.

 If the keyboard button does not appear on the taskbar, open **Settings**, tap **General management** → **Keyboard list and default**, and then tap the **Keyboard button on navigation bar** switch to turn it on.

## Additional keyboard functions



-  : Enter avatars, stickers, and more. You can also enter your avatar stickers that look like you. Refer to [Using Galaxy Avatar stickers](#) for more information.
-  : Translate text and enter it.
-  : Add an item from the clipboard.
-  : Change the keyboard mode.
-  : Switch to handwriting mode.
-  : Change the keyboard settings.

Tap the More options icon (•••) to use more keyboard functions.

-  : Recognize text from documents or images and enter it.
-  : Edit the keyboard function list.



 Some features may not be available depending on the carrier or model.

## Copying and pasting

- 1 Touch and hold over text.
- 2 Drag the Left text selection icon () or the Right text selection icon () to select the desired text, or tap **Select all** to select all text.
- 3 Tap **Copy** or **Cut**.  
The selected text is copied to the clipboard.
- 4 Touch and hold where the text is to be inserted and tap **Paste**.

## Extracting text

While using some apps, such as the **Gallery** or **Camera** app, you can extract text from images and use options, such as copying or sharing it. The following actions are an example of extracting text in the **Gallery** app.

- 1 While checking an image in the **Gallery** app, tap the Extract text icon ().  
The Extract text icon () appears only when there is text to extract.
- 2 Select an area to extract text.
- 3 Select an option you want.

# Apps and features

## Installing or uninstalling apps

### Galaxy Store

Purchase and download apps. You can download apps that are specialized for Samsung Galaxy devices.

Open the **Store** app. Browse apps by category or tap the Search icon (🔍) to search for a keyword.

- 📌 This app may not be available depending on the carrier or model.
- To change the auto update settings, tap **Menu** → the Settings icon (⚙️) → **Auto update apps**, and then select an option.

### Play Store

Purchase and download apps.

Open the **Play Store** app. Browse apps by category or search for apps by keyword.

- 📌 To change the auto update settings, tap your account icon, tap **Settings** → **Network preferences** → **Auto-update apps**, and then select an option.

## Managing apps

### Uninstalling or disabling apps

Touch and hold an app and select an option.

- **Uninstall:** Uninstall downloaded apps.
- **Disable:** Disable selected default apps that cannot be uninstalled from the device.

- 📌 Some apps may not support this feature.

### Enabling apps

Open **Settings**, tap **Apps** → the Sort icon (⌵) → **Disabled** → **OK**, select an app, and then tap **Enable**.

## Setting app permissions

For some apps to operate properly, they may need permission to access or use information on your device.

To access your app permission settings, open **Settings** and tap **Apps**. Select an app and tap **Permissions**. You can check the app's permissions list and change its permissions.

To check or change app permission settings by permission category, open **Settings** and tap **Apps** → the More options icon (⋮) → **Permission manager**. Select an item and select an app.

 If you do not grant permissions to apps, the basic features of the apps may not function properly.

## S Pen

### Using the S Pen

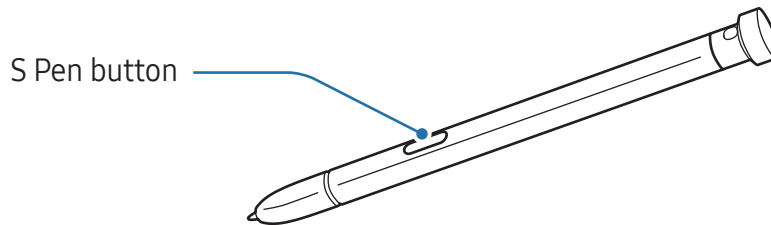

- ❗ Do not bend or apply excessive pressure with the S Pen while using it. The S Pen may be damaged or the nib may be deformed.
- Do not hard press on the screen with the S Pen. The pen nib may be deformed.
- ✍ If there is a magnet near the device, some S Pen actions, such as tapping the screen, may not work.
- If you use the S Pen at sharp angles on the screen, the device may not recognize the S Pen actions.
- If the S Pen is not working properly, take it to a Samsung Service Center or an authorized service center.

### Air command

#### (Launching S Pen features and apps directly)

Air command is a menu that provides S Pen features and direct access to frequently used apps.

Hover the S Pen over the screen and tap the Air command icon (🖋) with the S Pen.

Select a function or app on the Air command panel.

- ✍ If the Air command icon does not appear on the screen, open **Settings**, tap **Advanced features** → **S Pen** → **Air command**, and then tap the **Show Air command icon** switch to turn it on. If you turn on the **Open Air command with Pen button** switch, you can open the Air command panel by hovering the S Pen over the screen and pressing the S Pen button.

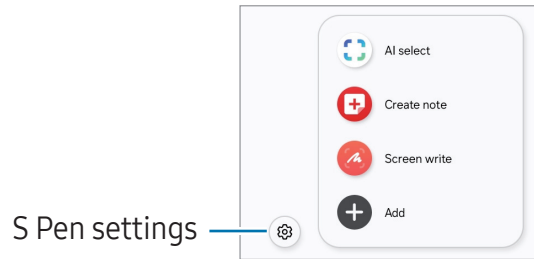

- **AI select:** Use the S Pen to select an area and perform actions, such as sharing or saving. Refer to [AI select](#) for more information.
- **Create note:** Create notes in a pop-up window. You can also launch this feature by double tapping the screen while pressing and holding the S Pen button. Refer to [Samsung Notes](#) for more information.
- **Screen write:** Capture screenshots to write or draw on them or crop an area from the captured image. You can also capture the current content and the hidden content on an elongated page, such as a webpage. Refer to [Screen write](#) for more information.
- **View all notes:** Access all notes in the **Samsung Notes** app.
- **Translate:** Hover the S Pen over a word to translate it. Refer to [Translate](#) for more information.
- **PENUP:** Post your artwork, check out others' artwork, and get useful drawing tips.
- **Write on calendar:** Open the **Calendar** app and write or draw on the screen. Refer to [Write on calendar](#) for more information.
- **Add:** Add shortcuts to frequently used apps to the Air command panel.

## AI select

Use the S Pen to select an area and perform actions, such as sharing or saving. You can also select an area from a video and capture it as a GIF.

- 1 When there is content you want to capture, such as a part of an image, open the Air command panel and tap **AI select**.
- 2 Tap or draw a circle around the content you want to select.
- 3 Select an option to use with the selected area.

## Screen write

Capture screenshots to write or draw on them or crop an area from the captured image.

- 1 When there is content you want to capture, open the Air command panel and tap **Screen write**.

The current screen is automatically captured and the editing toolbar appears.

- 2 Write a memo on the screenshot.
- 3 Share or save the screenshot.

You can check the captured screenshots in **Gallery**.

 It is not possible to capture a screenshot while using some apps.

## Translate

Hover the S Pen over the text you want to translate. The units included in the text will also be converted.

- 1 When there is text you want to translate, open the Air command panel and tap **Translate**.
- 2 Select the languages on the translator panel at the top of the screen.  
You can change the text between words and sentences by tapping the Sentence icon (☰) or the Word icon (Ⓘ).

- 3 Hover the S Pen over the text you want to translate or the unit you want to convert. The translated text will appear. To listen to the pronunciation of the original text, tap the Play icon (▶). The Play icon (▶) may not appear depending on the language you select.

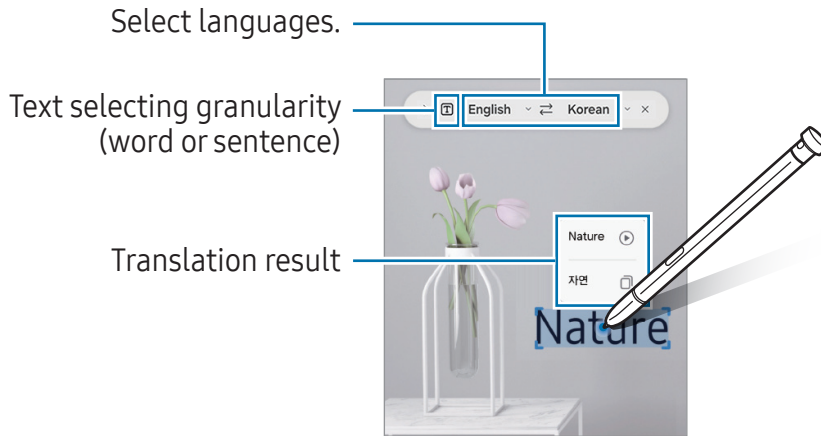

- ✎ This feature does not support some languages.
- This feature is available only when detectable text is on the screen.

## Write on calendar

Fill in your plans by writing or drawing on the calendar screen.

Open the Air command panel, tap **Write on calendar**, and then fill in your plans on the calendar. When you are finished, tap **Save**. To edit it, tap the Write icon (✎).

## S Pen to text

You can set the device to convert anything you write with the S Pen into text.

- 1 Open **Settings**, tap **Advanced features** → **S Pen** → **S Pen to text**, and then tap the switch to turn it on.

✎ To learn about how to edit text with the S Pen, tap **How to edit**.

- 2 Write in a text input field, such as a search field or address bar, using the S Pen. The handwriting will be converted to text.

## Airview

Hover the S Pen over an item on the screen to preview content or access information in a pop-up window.

In some apps, Action buttons will be displayed on the preview window.

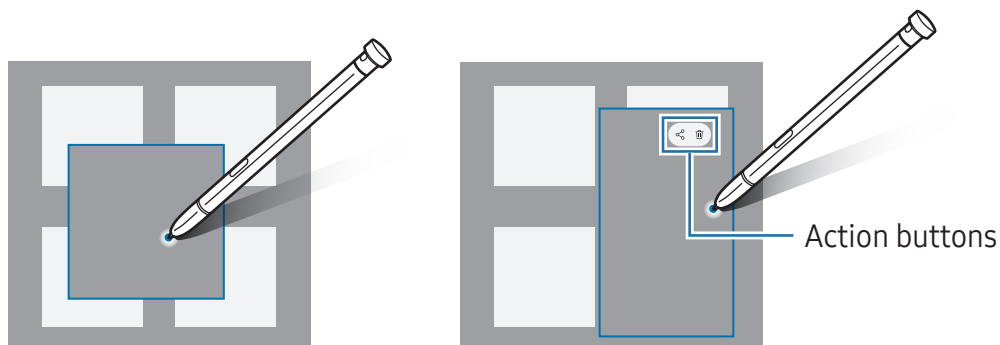

 If this feature is not turned on, open **Settings**, tap **Advanced features** → **S Pen**, and then tap the **Airview** switch to turn it on.

## Pen Select

### (Selecting items quickly with the S Pen)

While pressing and holding the S Pen button, drag the S Pen over text or item lists to select multiple items or text. You can also copy and paste the selected items or text into another app or share them with others.

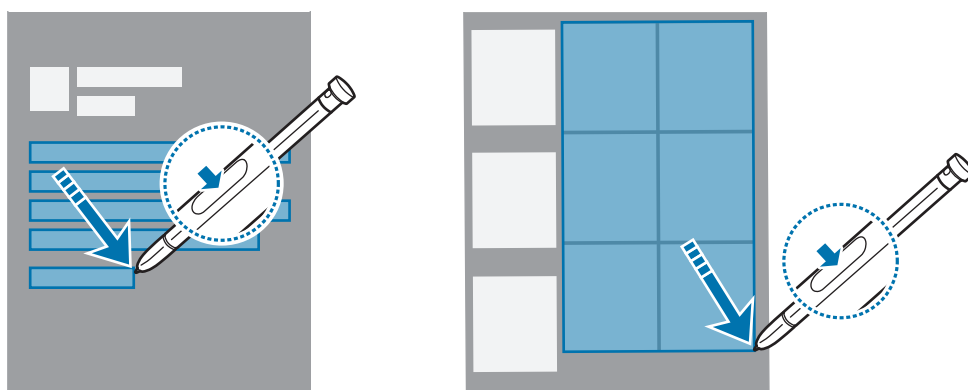



## Screen off memos

You can create memos by writing on the screen without turning on it.

When the screen is off, double tap the screen while pressing and holding the S Pen button.

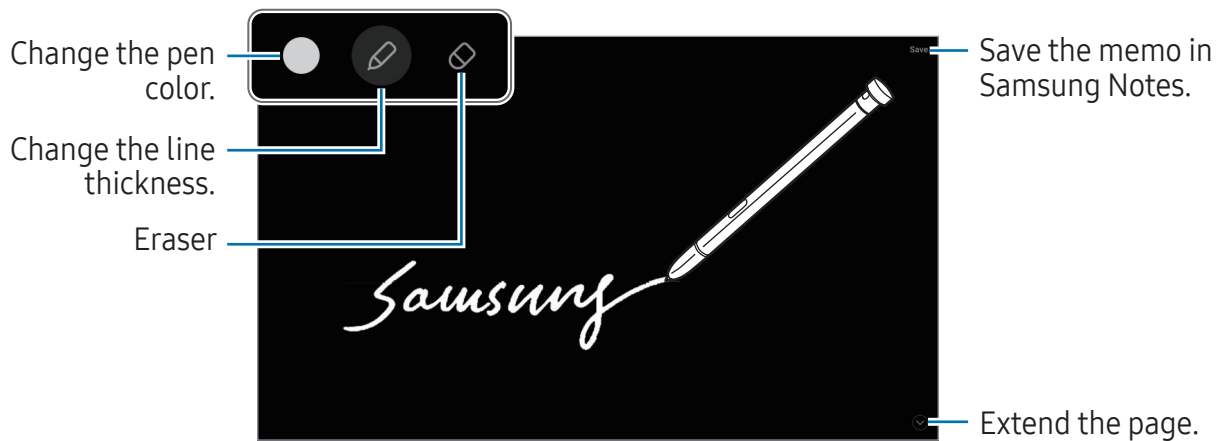
When you tap **Save** after writing a memo, the memo will be saved to **Samsung Notes**.



-  If this feature is not turned on, open **Settings**, tap **Advanced features** → **S Pen**, and then tap the **Screen off memos** switch to turn it on.

## Phone

Make or answer voice and video calls.

-  You can use calling and messaging features on your tablet with your phone number using the **Call & text on other devices** feature. On your tablet and phone, open **Settings**, tap **Connected devices** → **Call & text on other devices**, and then tap the switch to turn it on. You must register and sign in to the same Samsung account on the tablet and phone. Some calling and messaging features may not be available.

## Contacts

### Introduction

Create new contacts or manage contacts on the device.

### Adding contacts

#### Creating a new contact

- 1 Open the **Contacts** app and tap the Create icon (+).
- 2 Select a storage location.
- 3 Enter contact information and tap **Save**.

## Importing contacts

Add contacts by importing them from other storages to your device.

- 1 Open the **Contacts** app, tap the More options icon () at the top of the contacts list, and then tap **Settings** → **Import contacts**.
- 2 Follow the on-screen instructions to import contacts.

## Syncing contacts with your web accounts





Sync your device contacts with online contacts saved in your web accounts, such as your Samsung account.

- 1 Open **Settings**, tap **Accounts and backup** → **Manage accounts** and select the account to sync with.
- 2 Tap **Sync account** and tap the **Contacts** switch to turn it on.

## Searching for contacts

Open the **Contacts** app. Tap the Search icon () at the top of the contacts list and enter search criteria.

Tap the contact. Then take one of the following actions:

-  : Make a voice call.
-  : Compose a message.
-  : Make a video call.
-  : Compose an email.

## Deleting contacts

- 1 Open the **Contacts** app, tap the More options icon (⋮) at the top of the contacts list, and then tap **Select**.
- 2 Select contacts and tap **Delete**.

To delete contacts one by one, tap a contact from the contacts list and tap **More** → **Delete**.

## Sharing contacts

You can share contacts with others by using various sharing options.

- 1 Open the **Contacts** app, tap the More options icon (⋮) at the top of the contacts list, and then tap **Select**.
- 2 Select contacts and tap **Share**.
- 3 Select contact information to share and tap **Done**.
- 4 Select a sharing method.

## Creating groups

You can add groups, such as family or friends, and manage contacts by group.

- 1 Open the **Contacts** app and tap **Groups** → the Create icon (+).
- 2 Follow the on-screen instructions to create a group.

## Merging duplicate contacts

If your contacts list includes duplicate contacts, merge them into one to streamline your contacts list.

- 1 Open the **Contacts** app, tap the More options icon (⋮) at the top of the contacts list, and then tap **Settings** → **Merge duplicate contacts**.
- 2 Tick contacts and tap **Merge**.

## Setting up your profile

You can set your profile picture and profile card.

- 1 Open the **Contacts** app and tap your profile.
- 2 Tap **Create profile card**.
- 3 Follow the on-screen instructions to set up your profile card.  
The image you select for the profile card will also be applied as your profile picture.
- 4 To change your profile picture, tap the profile picture or card and tap the Profile picture icon (🖋️).
- 5 Follow the on-screen instructions to set your profile picture.

## Sharing your profile

People can view your profile when you call them or when they check your contact information.

- 1 Open the **Contacts** app and tap your profile.
- 2 Tap **Profile card and picture** and tap the **Share profile card and picture** switch to turn it on.

# Camera

## Introduction

Take pictures and record videos using various modes and settings.

### Camera etiquette

- Do not take pictures or record videos of other people without their permission.
- Do not take pictures or record videos where legally prohibited.
- Do not take pictures or record videos in places where you may violate other people's privacy.

## Taking pictures

### 1 Open the **Camera** app.

You can also open the app by pressing the Side button twice or dragging the Camera icon () to the left on the locked screen.

-  • Some camera features are not available when you open the **Camera** app from the locked screen or when the screen is turned off while the screen lock method is set.
  - The camera automatically shuts off when unused.
  - Some methods may not be available depending on the carrier or model.

### 2 Tap the image on the preview screen where the camera should focus.

To adjust the brightness of pictures, drag the adjustment bar that appears above or below the circular frame.

3 Tap the Take picture icon (○) to take a picture.

To change the shooting mode, drag the shooting modes list to the left or right, or swipe to the left or right on the preview screen.

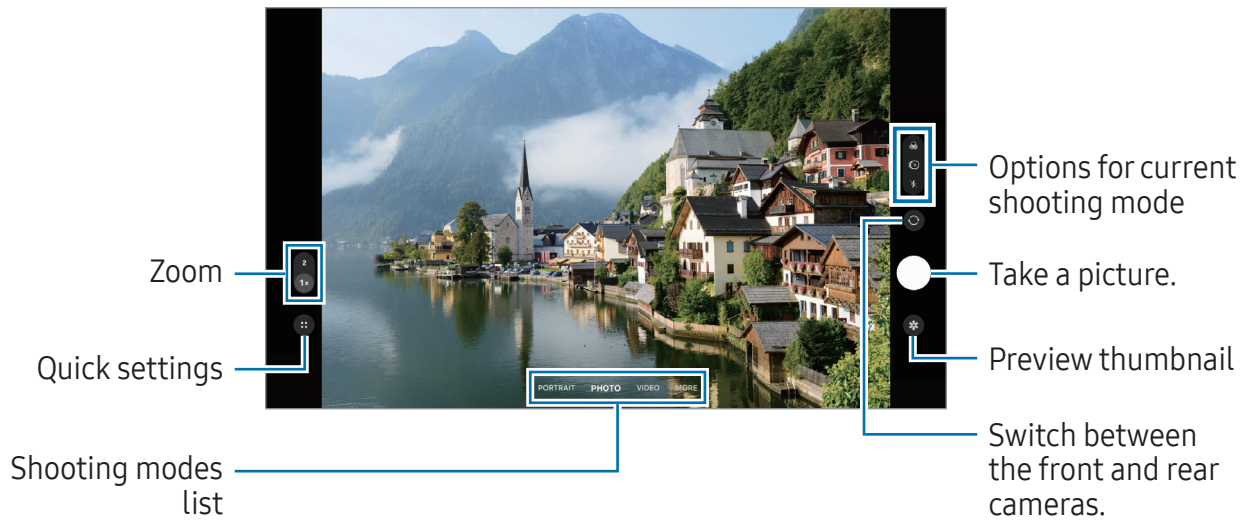

- The preview screen may vary depending on the shooting mode and which camera is being used.
- The focus may not be clear if the subject is close. Take pictures or videos from a good distance.
- If pictures you take appear blurry, clean the camera lens and try again.
- Make sure that the lens is not damaged or contaminated. Otherwise, the device may not work properly in some modes that require high resolutions.
- Your device's camera features a wide-angle lens. Minor distortion may occur in wide-angle pictures or videos and does not indicate device performance problems.
- The camera may fog up or form condensation if the device is exposed to sudden changes in air temperature, because of the difference in temperature outside and inside the camera cover. Try to avoid such conditions when planning to use the camera. If fogging does occur, allow the camera to dry naturally at room temperature before taking pictures or recording videos, otherwise results may look blurry.

## Using the camera button

- Touch and hold the camera button to record a video.
- If you drag the camera button to the Lock icon (🔒), you can record a video without holding the button.
- To take burst shots, swipe the camera button to the edge of the screen and hold it. If you tap the Quick controls icon (⋮) → the Settings icon (⚙️) on the preview screen and tap **Swipe Shutter button to** → **Create GIF**, you can create GIFs.
- If you add another camera button, you can move it anywhere on the screen and take pictures more conveniently. On the preview screen, tap the Quick controls icon (⋮) → the Settings icon (⚙️) → **Shooting methods** and tap the **Floating Shutter button** switch to turn it on.

## Editing the shooting modes list

To edit the shooting modes list, tap **MORE** on the list, tap **Edit**, and then drag modes to where you want.

## Using zoom features

To zoom in or out while using the rear camera, select the desired zoom icon on the preview screen.

You can also select the desired zoom level from the zoom level list that appears when you tap the zoom icon.

To adjust the zoom more precisely, drag the zoom icon, pinch, or spread two fingers apart on the preview screen.



## Locking the focus (AF) and exposure (AE)











You can lock the focus or exposure on a selected area to prevent the camera from automatically adjusting based on changes to the subjects or light sources.

Touch and hold the area to focus, the AF/AE frame will appear on the area and the focus and exposure setting will be locked. The setting remains locked even after you take a picture.

 This feature may not be available depending on the shooting mode.

## Options for current shooting mode

On the preview screen, use the following options. To use more options, tap the Quick controls icon ()

-  : Turn the flash on or off.
-  : Turn the motion photo feature on or off. If you turn it on, a video clip will also be taken from a few seconds before or both before and after tapping the camera button.
-  : Apply a filter effect.
-  : Select a frame rate for hyperlapse videos.
-  : Select a resolution for videos.
-  : Apply beauty effects.
-  : Select a metering method. This determines how light values are calculated. **Center-weighted metering** () uses the light in the center portion of the shot to calculate the exposure of the shot. **Matrix metering** () averages the entire scene. **Spot metering** () uses the light in a concentrated center area of the shot to calculate the exposure of the shot.
-  : In **FOOD** mode, focus on a subject inside the frame and blur the image outside the frame.

 The available options may vary depending on the model or shooting mode.

## Photo mode

The camera adjusts the shooting options automatically depending on the surroundings. On the shooting modes list, tap **PHOTO** and tap the Take picture icon (○) to take a picture.

### Shot suggestions

The camera suggests the ideal composition for the picture by recognizing the position and angle of your subject.

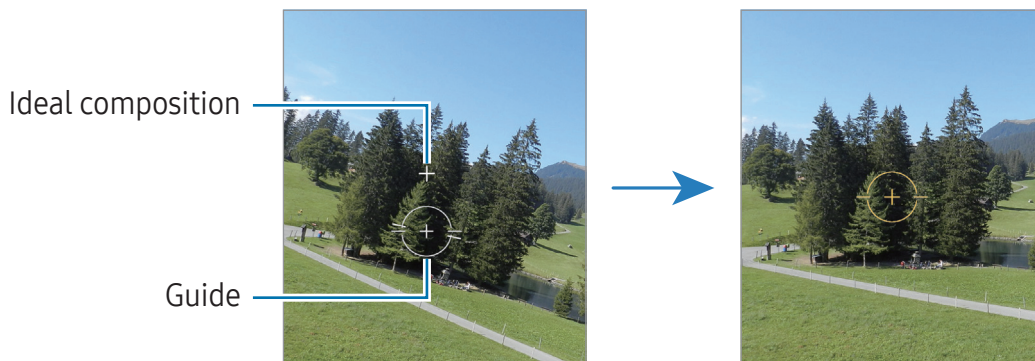

On the preview screen, tap the Quick controls icon (⋮) → the Settings icon (⚙️) and tap the **Shot suggestions** switch to turn it on.

- 1 On the shooting modes list, tap **PHOTO**.  
A guide will appear on the preview screen.
- 2 Point the guide at the subject.  
The camera recognizes the composition, and the recommended composition appears on the preview screen.
- 3 Move the device so the guide matches the recommended composition.  
When the ideal composition is achieved, the guide will change to yellow.
- 4 Tap the Take picture icon (○) to take a picture.





## Taking selfies

You can take self-portraits with the front camera.

- 1 On the preview screen, swipe upwards or downwards, or tap the Switch to the front camera icon () to switch to the front camera for self-portraits.
- 2 Face the front camera lens.  
To take self-portraits with a wide-angle shot of the landscape or people, tap the Switch to wide icon (.
- 3 Tap the Take picture icon () to take a picture.





## Scanning documents or text

You can scan documents or text.

- 1 On the shooting modes list, tap **PHOTO**.
- 2 Point the camera towards the object and tap the Scan documents and text icon ().  
The Scan documents and text icon () will only appear when a document or text is detected.
- 3 Tap **Scan**, select the area you want, and then tap **Save**.



## Video mode

The camera adjusts the shooting options automatically depending on the surroundings.

- 1 On the shooting modes list, tap **VIDEO** and tap the Start recording icon () to record a video.
  - To switch between the front and rear cameras while recording, swipe upwards or downwards on the preview screen or tap the Switch to the front camera icon (  - To capture an image from the video while recording, tap the Capture icon (
- 2 Tap the Stop recording icon () to stop recording the video.

## Portrait mode

Take pictures that focus on the face by blurring the background.

- 1 On the shooting modes list, tap **PORTRAIT**.
- 2 Tap the Portrait icon () and drag the background blur adjustment bar to adjust the blur level.
- 3 When **Ready** appears on the preview screen, tap the Take picture icon () to take a picture.



- Use this feature in a place that has sufficient light.
- The background blur may not be applied properly in the following conditions:
  - The device or the subject is moving.
  - The subject has a similar color to the background.

## Pro mode

Capture pictures while manually adjusting various shooting options, such as exposure value and ISO value.

On the shooting modes list, tap **MORE** → **PRO**. Select options and customize the settings, and then tap the Take picture icon () to take a picture.

## Available options

When you tap an option, the options list will appear. On the list, select options and customize the settings.

- **WB**: Select an appropriate white balance, so images have a true-to-life color range. You can set the color temperature.
- **EV**: Change the exposure value. This determines how much light the camera's sensor receives. For low-light situations, use a higher exposure.
- **ISO**: Select an ISO value. This controls camera light sensitivity. Low values are for stationary or brightly lit objects. Higher values are for fast-moving or poorly lit objects. However, higher ISO settings can result in noise in pictures.
-  : Reset the settings.

## Separating the focus area and the exposure area

You can separate the focus area and the exposure area.

Touch and hold the preview screen. The AF/AE frame will appear on the screen. Drag the frame to the area where you want to separate the focus area and the exposure area.

## Night mode

Take a picture in low-light conditions, without using the flash. When you use a tripod, you can get brighter and steadier results.

- 1 On the shooting modes list, tap **MORE** → **NIGHT**.
- 2 Tap the Take picture icon (○) and hold your device steady until shooting is complete.

## Food mode

Take pictures of food with more vibrant colors.

- 1 On the shooting modes list, tap **MORE** → **FOOD**.  
A frame will appear on the screen and the area outside the frame will be blurred.
- 2 To resize the frame, drag a corner of the frame.  
Tap the area you want or drag the frame to move it.
- 3 Tap the Quick controls icon (⋮) → the Color temperature icon (🔒) and drag the adjustment bar to adjust the color temperature.
- 4 Tap the Take picture icon (○) to take a picture.



## Panorama mode

Using panorama mode, take a series of pictures and then stitch them together to create a wide scene.



- 1 On the shooting modes list, tap **MORE** → **PANORAMA**.
  - 2 Tap the Take picture icon (○) and move the device slowly in one direction.  
Keep the image within the frame on the camera's viewfinder. If the preview image is out of the guide frame or you do not move the device, the device will automatically stop taking pictures.
  - 3 Tap the Done icon (■) to stop taking pictures.
-  Avoid taking pictures of indistinct backgrounds, such as an empty sky or a plain wall.

## Hyperlapse mode

Record scenes, such as passing people or cars, and view them as fast-motion videos.

- 1 On the shooting modes list, tap **MORE** → **HYPERLAPSE**.
- 2 Tap the Speed icon () and select a frame rate option.  
If you set the frame rate to **AUTO**, the device will automatically adjust the frame rate according to the changing rate of the scene.
- 3 Tap the Start recording icon () to start recording.
- 4 Tap the Stop recording icon () to finish recording.

## Customizing camera settings

On the preview screen, tap the Quick controls icon () → the Settings icon (). Some options may not be available depending on the shooting mode.

### Intelligent features

- **Scene optimizer:** Set the device to adjust the color settings and apply the optimized effect automatically depending on the subject or scene.
- **Scan documents and text:** When a document or text is detected by the rear camera, the Scan documents and text icon () will appear.
- **Scan QR codes:** Set the device to scan QR codes from the preview screen.
- **Shot suggestions:** Set the device to suggest the ideal composition for the picture by recognizing the position and angle of your subject.
- **Custom filters:** Create your own filter using an image with a color tone you like from **Gallery**.

### Pictures

- **Swipe Shutter button to:** Select an action to perform when you swipe the camera button to the edge of the screen and hold it.
- **Watermark:** Add a watermark when taking pictures.
- **High efficiency pictures:** Take pictures in the High Efficiency Image Format (HEIF).

## Selfies

- **Save selfies as previewed:** Set the device to save pictures or videos as they appear on the preview screen when taken with the front camera without flipping them.
- **Swipe up/down to switch cameras:** Turn on this feature to switch cameras by swiping upwards or downwards on the preview screen.

## Videos

- **Video stabilization:** Turn on anti-shake to reduce or eliminate blurry image resulting from camera shake while recording a video.
- **Advanced video options**
  - **High efficiency videos:** You can record videos in the High Efficiency Video Codec (HEVC) format. Your HEVC videos will be saved as compressed files to conserve the device's storage.
  - **360 audio recording:** You can record more immersive 3D sound videos using Bluetooth headphones that support the 360 audio recording feature.
  - **Audio playback:** You can play media without pause while recording videos. Media will pause when the 360 audio recording feature is on.
-  You might not be able to play the HEVC videos on other devices or share them online.
- You cannot record videos in the HEVC format in some shooting modes.

## General

- **Auto HDR:** Take pictures with rich colors and reproduce details even in bright and dark areas.
- **Composition guide:** Display viewfinder guides to help composition when selecting subjects.
- **Location tags:** Attach a GPS location tag to the picture.
-  GPS signal strength may decrease in locations where the signal is obstructed, such as between buildings or in low-lying areas, or in poor weather conditions.
- Your location may appear on your pictures when you upload them to the internet. To avoid this, turn off the location tag setting.

- **Shooting methods**
  - **Press Volume buttons to:** Take pictures or record videos, zoom in or out, or control the volume using the Volume button.
  - **Floating Shutter button:** Add another movable button anywhere on the screen to take pictures.
  - **Show palm:** Show your palm to the front camera to take selfies or start recording videos.
- **Settings to keep:** Keep the last settings you used, such as the shooting mode, when you open the camera.
- **Storage location:** Select a storage location. This feature will appear when you insert an SD card.
- **Shutter sound:** Turn the shutter sound on or off.

## Privacy

- **Permissions:** Access the permissions required to use the Camera app.
- **Reset settings:** Reset the camera settings.
- **About Camera:** Check the Camera app version and legal information.
- **Contact us:** Ask questions or check out the frequently asked questions.



Some features may not be available depending on the model.

# Gallery

## Introduction

Access images and videos stored in your device. You can also manage images and videos by album or create stories.

## Using Gallery

Open the **Gallery** app.

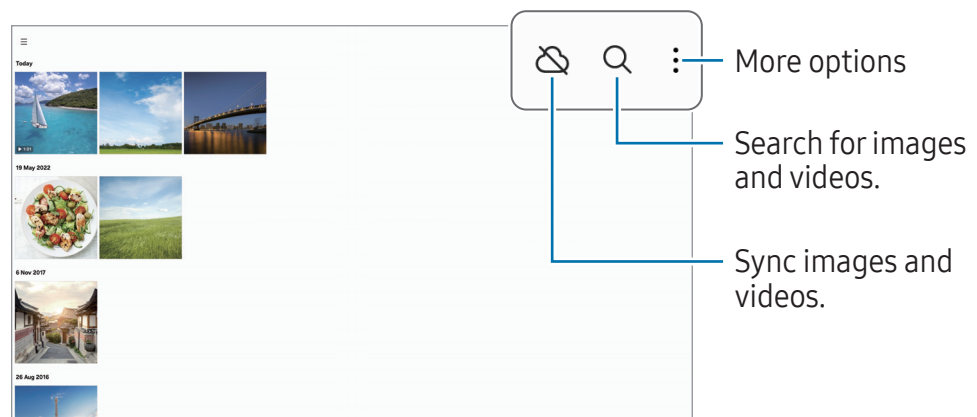

## Viewing images

Open the **Gallery** app and select an image. To view other files, swipe to the left or right on the screen.

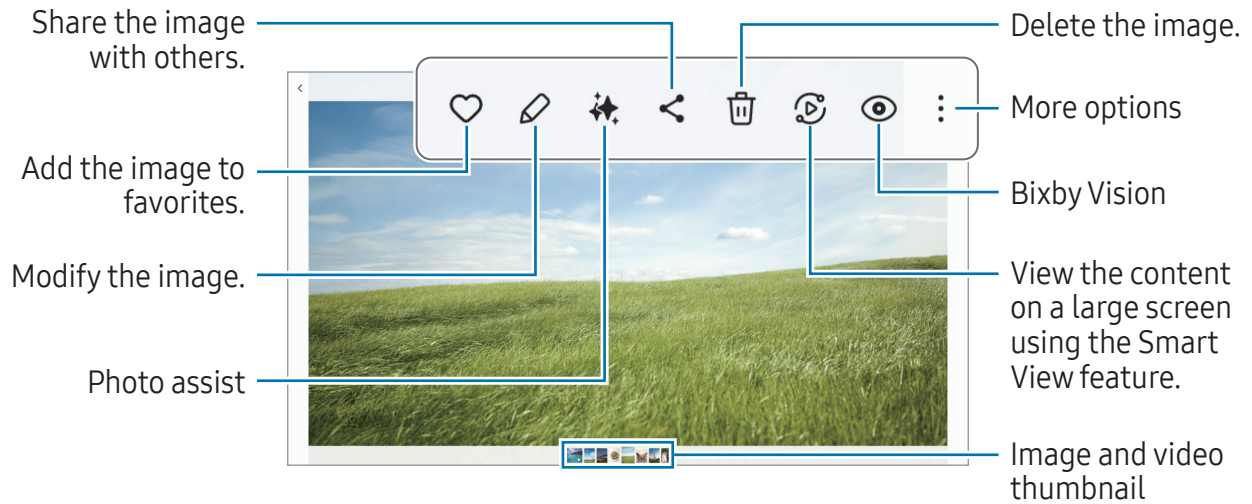

## Remastering images

You can enhance the dull, blurry, and low-resolution images.

- 1 Open the **Gallery** app and select an image.
- 2 Swipe upwards on the screen and tap **Remaster**.  
You can check the before and after.
- 3 Tap the Save icon (↓) to save the remastered image.

## Extracting objects from images

Separate an object from the background and extract it. You can copy the extracted image or use it in various ways by saving it as a sticker or an image.

- 1 Open the **Gallery** app and select an image or a video.
- 2 Touch and hold on the object you want extract and select an option.



For videos, this feature is only available when they are paused.

## Cropping enlarged images

- 1 Open the **Gallery** app and select an image.
- 2 Spread two fingers apart on the area you want to save and tap the Quick crop icon ()

The cropped area will be saved as a file.

## Viewing videos

Open the **Gallery** app and select a video to play. To view other files, swipe to the left or right on the screen.

To use more options during playback, tap the More options icon (⋮) → **Open in Video player**.

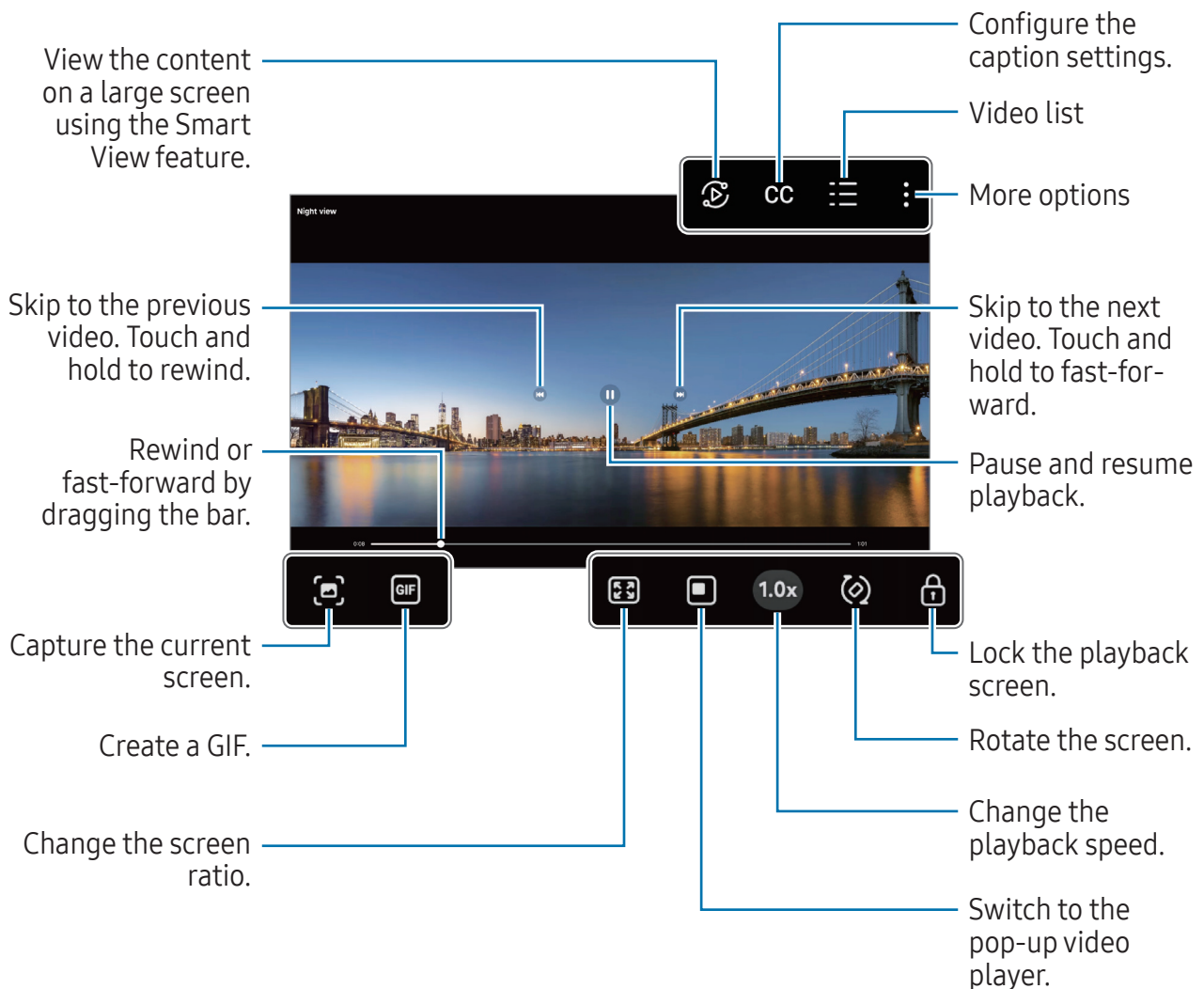

Drag up or down on the left side of the playback screen to adjust the brightness, or drag up or down on the right side of the playback screen to adjust the volume.

To rewind or fast-forward, swipe to the left or right on the playback screen.

## Albums

Open the **Gallery** app, tap the Navigation drawer icon (☰) → **Albums** → the Create icon (+), and then select an album type.

- **Album:** Create new albums and add images and videos manually.
- **Auto-updating album:** Create albums that automatically collect images of people you select.
- **Group:** Create a group of related albums.

 Some features may not be available depending on the region or the model.

## Stories

When you capture or save images and videos, the device will read their date and location tags, sort the images and videos, and then create stories.

Open the **Gallery** app, tap the Navigation drawer icon (☰) → **Stories**, and then select a story. If you tap the More options icon (⋮), you can use various options, such as changing the story title.

If you tap the More options icon (⋮) → **Create story** on the stories list, you can create stories manually.

## Syncing images and videos

Open the **Gallery** app, tap the Sync with OneDrive icon (☁), and then follow the on-screen instructions to complete the sync. When the **Gallery** app and the cloud are synced, the icon will change to the Synced with OneDrive icon (☁).

While syncing, pictures and videos you take will also be saved in the cloud. You can access images and videos saved in the cloud in your **Gallery** app and from other devices.

 When you connect your Samsung account and Microsoft account, you can set the cloud storage as Microsoft OneDrive.

## Deleting images or videos

Open the **Gallery** app, touch and hold an image, a video, or an album to delete, and then tap **Delete**.

## Using the trash feature

Images and videos you delete will be temporarily stored in the trash. The files will be deleted after a certain period.

To access files in the trash, open the **Gallery** app and tap the Navigation drawer icon (☰) → **Trash**. To restore files, tap **Select**, select files, and then tap **Restore**.

## Bixby

Bixby is a user interface that helps you use your device more conveniently. You can say what you want to Bixby. Bixby will launch a feature you request or show the information you want.

Visit [www.samsung.com/bixby](http://www.samsung.com/bixby) for more information.

 Bixby is only available in some languages, and it may not be available depending on the region.

### Waking up Bixby

While pressing and holding the Side button, say what you want to Bixby. To use this feature, open **Settings** and tap **Advanced features** → **Side button** → **Long press** → **Bixby**.

Alternatively, say the wake-up phrase, such as “Hi, Bixby” or “Bixby”, and then say what you want.

### Setting a wake-up phrase

1 Open **Settings**, tap **Advanced features** → **Bixby** → **Voice wake-up**, and then tap the switch to turn it on.

2 Select the wake-up phrase you want under **Wake-up phrase**.

To wake up Bixby with your voice, tap the **Respond to my voice** switch to turn it on.

 When running this app for the first time or restarting it after performing a data reset, follow the on-screen instructions to complete the initial setup.

## Bixby Vision

Bixby Vision is a service that provides various features based on image recognition. You can use Bixby Vision to search for information by recognizing objects. Use a variety of useful Bixby Vision features.

-  • This feature may not be available or you might not get correct search results depending on the image size, format, or resolution.
- Samsung is not responsible for the product information provided by Bixby Vision.

### Launching Bixby Vision

Launch Bixby Vision using one of these methods.

- In the **Camera** app, tap **MORE** on the shooting modes list and tap the Bixby Vision icon (👁️).
- In the **Gallery** app, select an image and tap the Bixby Vision icon (👁️).
- If you added the Bixby Vision app icon to the Home screen, open the **Bixby Vision** app.

### Using Bixby Vision

1 Launch Bixby Vision.

2 Select a feature you want to use.

- **TRANSLATE:** Recognize text from documents or images and translate it.
- **TEXT:** Recognize text from documents or images and extract it.
- **DISCOVER:** Search for images similar to the recognized object online and related information.
- **WINE:** Detect the information from a wine label and search for information on the wine.
- **SCENE DESCRIBER:** Analyze the scene you captured and describe it by voice.
- **OBJECT IDENTIFIER:** Recognize objects and describe them by voice.
- **TEXT READER:** Recognize text and read them aloud.
- **COLOR DETECTOR:** Detect the color of the object and say it aloud.

-  • The available features and search results may vary depending on the region or carrier.
- If some features do not appear, launch Bixby Vision, tap the More options icon (⋮) → **Settings**, and then tap the switches next to the features you want to turn on.

## Multi window

### (Using multiple apps at once)

Run apps at the same time in split screen view or multiple apps in the pop-up view.

 Some apps may not support this feature.

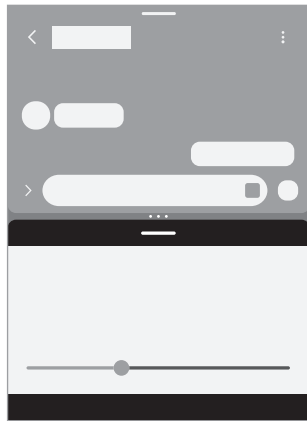

Split screen view

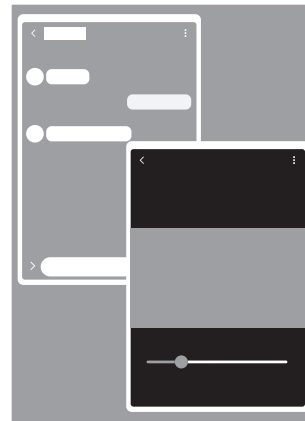

Pop-up view

### Launching Multi window

- Recents button

Press the Recents button, tap an app's icon, and then tap **Open in split screen view** or **Open in pop-up view**.

- Swipe screen

Open **Settings**, tap **Advanced features** → **Multi window**, and then tap the **Swipe for split screen** or **Swipe for pop-up view** switch to turn it on.

- Taskbar

While using an app, drag the app you want from the taskbar upwards and drop it wherever you want.

-  Drag the circles (• • •) between the app windows to adjust the size of the windows.
- Tap the circles (• • •) between the app windows and tap the Add app pair icon (☆). The apps you are using in the split screen view will be saved as an app pair.
- Drag the multi window handle (—) to a new location to move the app window.
- When you tap the multi window handle (—), the available menus will appear.

# Samsung Internet

Browse the internet to search for information and bookmark your favorite webpages to access them conveniently.

- 1 Open the **Internet** app.
- 2 Enter the web address or a keyword, and then tap **Go**.

If the toolbar does not appear, swipe downwards slightly on the screen.

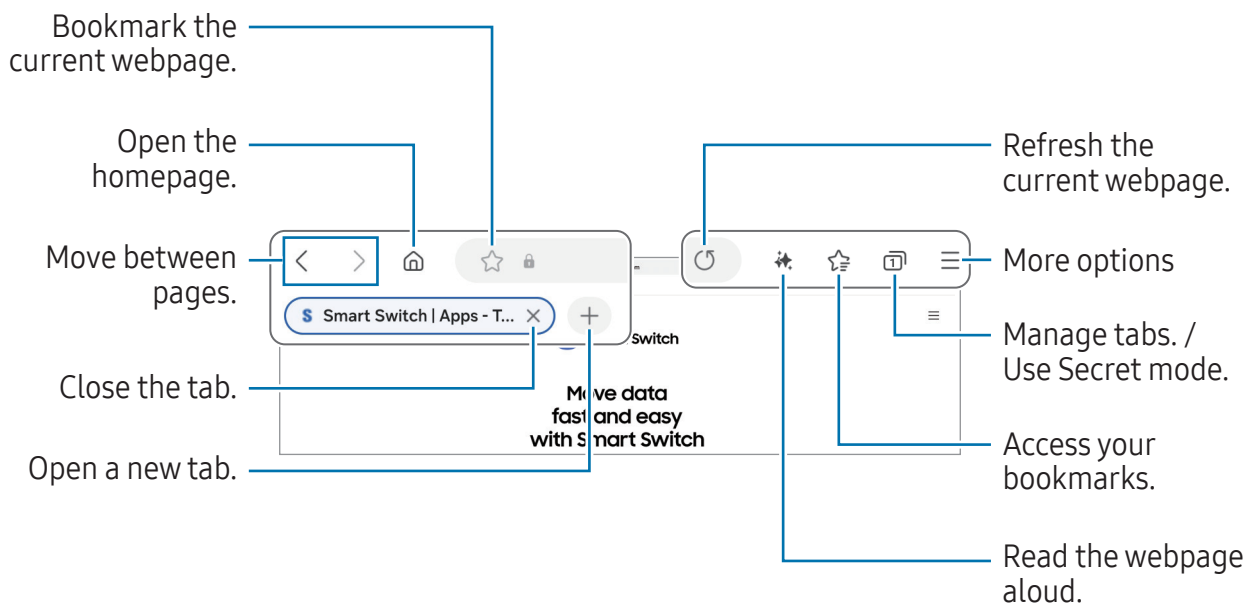

## Using Secret mode

If you set a password for Secret mode, you can prevent others from accessing your search history, browsing history, bookmarks, and saved pages.

- 1 Tap the Tabs icon (☰) → **Turn on Secret mode**.
- 2 Tap the **Lock Secret mode** switch to turn it on, tap **Start**, and then set a password for Secret mode.

In Secret mode, the device will change the color of the toolbars. To turn off Secret mode, tap the Tabs icon (☰) → **Turn off Secret mode**.

# Samsung Notes

## Introduction

Create notes by entering text from the keyboard or by handwriting or drawing on the screen. You can also insert images or voice recordings into your notes.

## Creating notes

- 1 Open the **Notes** app, tap the Create icon (📝), and then create a note.

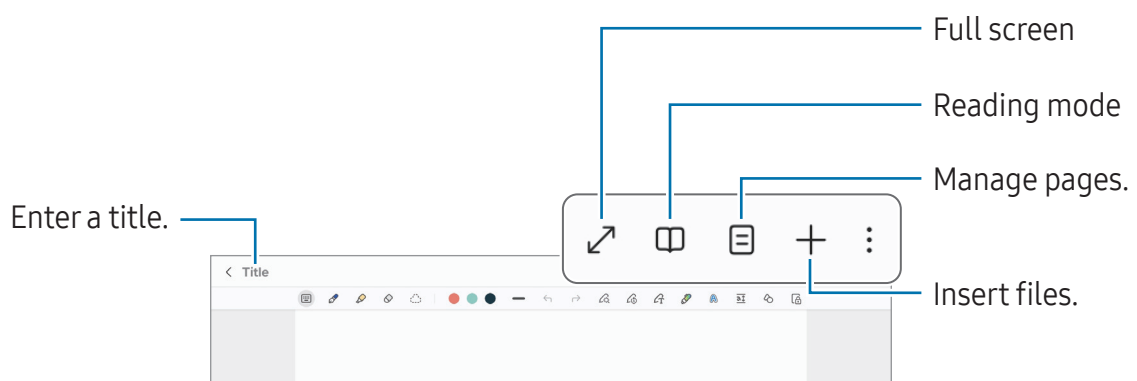

- 2 When you are finished composing the note, press the Back button to save it.  
If you want to save the note in another file format, tap the More options icon (⋮) → **Save as file**.

## Deleting notes

Touch and hold a note to delete and tap **Delete**.

## Syncing notes

You can check and edit notes on all your devices signed in to the same Samsung account. Open the **Notes** app, tap the Navigation drawer icon (☰) → the Settings icon (⚙️), and then tap the **Sync with Samsung Cloud** switch to turn it on.

## Composing notes with handwriting

On the note composer screen, draw or write in your own handwriting.

You can enter your handwriting in a larger size if you magnify the screen by spreading two fingers on it.

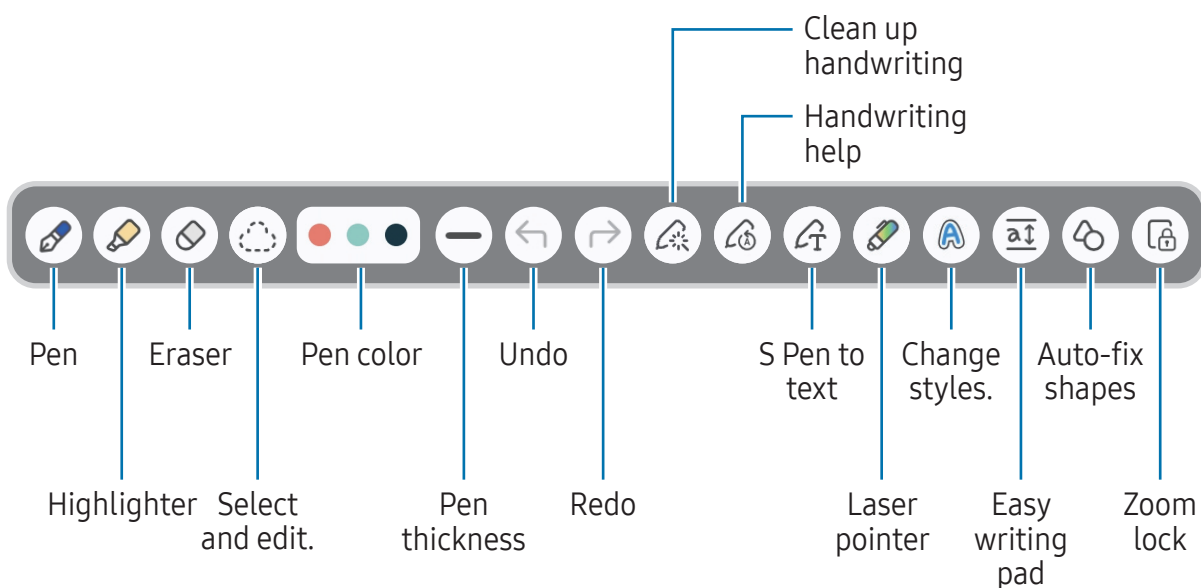

 If finger input does not work, tap the More options icon (⋮) → **Turn on finger drawing.**

## Using the eraser

When you want to erase handwriting from a note, tap the Eraser mode icon () and select an area to erase. Alternatively, select an area while pressing and holding the S Pen button.



To change the eraser type, tap the Eraser mode icon () once more.

- **Stroke eraser:** Erase the line you select.
- **Area eraser:** Erase only the area you select. You can adjust the size of the eraser by dragging the size adjustment bar.

 Even with a smaller eraser, you may still not be able to precisely erase the intended part.

## Editing handwritten notes

Edit handwritten notes using various editing options, such as cutting, moving, or resizing.

- 1 When there is handwriting on the note, tap the Selection mode icon ().  
To change the shape of the selection, tap the Selection mode icon () once more.
- 2 Tap or draw a line around the input to select.
  - To move the input to another location, select the input, and then drag it to a new location.
  - To change the size of the selection, tap the input and drag a corner of the frame that appears.
- 3 Edit the input using the available options.

## Aligning handwriting or converting to text



To straighten your handwriting or drawings horizontally, tap the Clean up handwriting icon () → **Align handwriting**.

To replace your handwriting with the converted text, tap the Clean up handwriting icon () → **Convert to text**. When the preview screen appears, tap the screen and tap **Add to**.

If you want to replace your handwriting with text right away, tap the S Pen to text icon () and then write on the screen with the S Pen.

## Changing styles

You can change the style of your handwriting and drawings.

After writing or drawing on the screen, tap the Change style icon () twice and select a color or line thickness you want. Then, point the S Pen toward where you want to apply the style. When the Arrow icon () appears, tap where you want to change the style.

## Using the easy writing pad

On the note composer screen, tap the Easy writing pad icon (). The input field will be magnified and appear as the easy writing pad.



## Automatically fixing shapes

Tap the Auto-fix shapes icon () and draw a shape. The shape will be fixed.

## Recording voice to notes

Make a recording of your voice while creating a note, and then the content will be synchronized with the recording.

On the note composer screen, tap the Insert icon () → **Voice recording** and create a note.

Select a note from the list and tap the Open Voice Recorder icon () → the Play icon () to play the recording. Then the content you created while recording will be displayed on the screen along with the recording.

## Adding memos to PDF files

Open the **Notes** app, tap the Import PDFs icon (), and then select a PDF file. You can add memos to the PDF file.

## Pinning a note to the Home screen

Pin a note to the Home screen to check it or open and edit it.

- 1 Open the **Notes** app.
- 2 Select a note and tap the More options icon () → **Add to** → **Home screen** → **Add**.  
The note will be added to the Home screen.

## Clipping content

You can add content, such as a webpage link or an image, to a note.

- 1 When there is content you want to clip while using the **Samsung Internet** or **Gallery** app, open the **Notes** app in the split screen view or in the pop-up view. For more information about the split screen view or the pop-up view, refer to [Multi window](#).

Alternatively, double tap the screen while pressing and holding the S Pen button, or open the Air command panel and tap **Create note**.

Options you can use will appear at the bottom of the note composer screen.

- 2 Select an option you want.

## Samsung Members

**Samsung Members** offers support services to customers, such as device problem diagnosis, and lets users submit questions and error reports. You can also share information with others in the Galaxy users' community or check the latest news and tips. **Samsung Members** can help you solve any problems you might encounter while using your device.

## Samsung Kids

You can restrict children's access to certain apps, set their usage times, and configure settings to provide a fun and safe environment for children when they use the device.

Open **Settings** and tap **Apps** → **Samsung Kids** → **Open**. When starting Samsung Kids for the first time or after performing a data reset, follow the on-screen instructions to complete the setup.

On the Samsung Kids screen, select the app you want to use.

 Your preset screen lock method or your created PIN will be used when turning on the **Parental controls** feature or closing Samsung Kids.

### Using parental controls features

You can configure the settings for Samsung Kids and check the usage history.

On the Samsung Kids screen, tap the More options icon (⋮) → **Parental controls** and enter your unlock code.

### Closing Samsung Kids

To close Samsung Kids, press the Back button or tap the More options icon (⋮) → **Close Samsung Kids**, and then enter your unlock code.

## Samsung Global Goals

The Global Goals, which were set up by the United Nations General Assembly in 2015, consist of goals that aim to create a sustainable society. These goals have the power to end poverty, fight inequality, and stop climate change.

With Samsung Global Goals, learn more about the global goals and join the movement for a better future.

## Samsung Find

You can locate your device even if it is not connected to a network. You can also share your location with other people you preset.

Open the **Find** app.

## Samsung Shop

**Samsung Shop** is the mobile shopping service provided by Samsung. Get offers or information about Samsung and its partners' products and services.

Open the **Samsung Shop** app.

 This app may not be available depending on the carrier or model.

## Galaxy Shop

Access the Samsung website and check various information related to products.

Open the **Galaxy Shop** app.

 This app may not be available depending on the carrier or model.



## PENUP

PENUP is a social network service for sharing artwork drawn with the S Pen. Post your artwork, check out others' artwork, and get useful drawing tips.

Open the **PENUP** app.



## Calendar

Manage your schedule by entering upcoming events in your planner.

Open the **Calendar** app and tap the Add event icon () or double tap a date. If the date already has saved events or tasks in it, tap the date and tap the Add event icon ().



### Syncing events with your accounts

- 1 Open **Settings**, tap **Accounts and backup** → **Manage accounts**, and then select the account to sync with.
- 2 Tap **Sync account** and tap the **Calendar** switch to turn it on.

To add accounts to sync with, open the **Calendar** app and tap the Settings icon () → **Manage calendars** → the More options icon () → **Add account**. Then, select an account to sync with and sign in.

## Reminder



Register to-do items as reminders and receive notifications according to the condition you set.

Open the **Calendar** app and tap **Reminders** () → the Add reminder icon (). The Reminder screen will appear and the Reminder app icon () will be added to the Apps screen.

-  • To receive more accurate notifications, connect to a Wi-Fi or mobile network.
- To use location reminders, the GPS feature must be turned on. Location reminders may not be available depending on the model.





### Using Reminder

Open the **Reminder** app.

- To create reminders, tap the Add reminder icon (.
- To complete reminders, tap the Tick box icon () or select a reminder and tap **Complete**.
- To restore reminders, tap **Completed**, select a reminder to restore, and then tap **Restore**.
- To delete a reminder, select a reminder and tap **Delete**.



## Voice Recorder

Record or play voice recordings.

- 1 Open the **Voice Recorder** app.
- 2 Tap the Record icon () to start recording. Speak into the microphone.
  - Tap the Pause icon () to pause recording.
  - While making a voice recording, tap the Add bookmark icon () to insert a bookmark.
- 3 Tap the Stop icon () to finish recording.
- 4 Enter a file name and tap **Save**.
  -  To record your voice and simultaneously convert it into on-screen text, tap **Speech-to-text** before starting the recording and select the language you want.

## Transcribing voice recordings

Convert voice recordings into on-screen text and edit it.

- 1 Select a voice recording.
- 2 Tap the More options icon () → **Transcribe into text**.
- 3 Select a button to start to transcribe the voice recording.  
If you want to transcribe the voice recording into another language, tap **Transcribe into another language** and select the language you want.
- 4 Press the Back button and tap **Save** to save the converted text.
  - To edit the converted text, tap the More options icon () → **Edit transcript text**.
  - To remove the converted text from the voice recording, tap the More options icon () → **Remove transcript**.

## My Files

### (Checking and managing the files)

Access and manage various files stored in the device.

Open the **My Files** app.

To check for unnecessary data and free up the device's storage, tap **Manage storage**.

To search for files or folders, tap the Search icon (Q).

## Clock



Set alarms, check the current time in many cities around the world, time an event, or set a specific duration.

Open the **Clock** app.

## Calculator

Perform basic arithmetic or scientific calculations.

Open the **Calculator** app.

-  : Check the calculation history. To clear the history, tap **Clear history**. To close the calculation history panel, tap the Calculation history icon (.
-  : Use the unit conversion tool. You can convert various values, such as area, length, or temperature, into other units.

# SmartThings

Control and manage smart appliances and Internet of Things (IoT) products.

Open the **SmartThings** app. For more information, tap **Menu** → **How to use**.

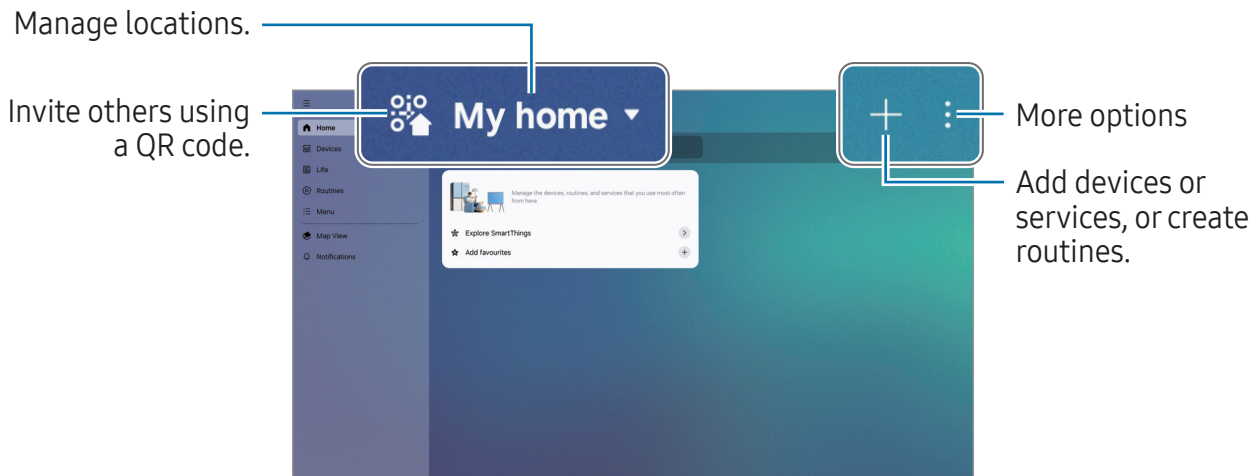

- **Home:** Add and manage frequently used devices, routines, or services.
- **Devices:** Add or manage devices.
- **Life:** Use various services, such as checking the device status or energy usage, and saving energy by using AI energy mode.
- **Routines:** Add or manage routines.
- **Menu:** Check useful information, supported devices, how to use certain features, and more.
- **Map View:** Check and manage connected devices in Map view.
- **Notifications:** Check notifications for connected devices and services.



- The devices you can connect may vary depending on the region. Available features may differ depending on the connected device.
- Connected devices' own problems or defects are not covered by the Samsung warranty. When problems or defects occur on the connected devices, contact the device's manufacturer.

## Sharing content

Share content by using various sharing options. The following actions are an example of sharing images.

- 1 Open the **Gallery** app and select an image.
  - 2 Tap the Share icon (↗) and select a sharing method you want.
-  You may incur additional charges when sharing files through the mobile network.

### Quick Share

Share content with nearby devices or people in your contacts.

- 1 Open the **Gallery** app and select an image.
- 2 On the other device, open **Settings** and tap **Connected devices** → **Quick Share** → **Who can share with you** → **Contacts only** or **Everyone** → **Done**.
- 3 Tap the Share icon (↗) → **Quick Share** and select a device to transfer the image to.
  - To share the link with a QR code, tap **QR code or link** and scan the QR code.
  - To share with contacts, tap **View contact**. (Mobile network enabled models)
  - To share encrypted content, tap the More options icon (⋮) → **Turn on Private sharing**. Shared content cannot be saved, copied, or resent by the recipient.
- 4 Accept the file transfer request on the other device.

### Setting who can find your tablet

Set who is allowed to find and send content to your tablet.

- 1 Open **Settings** and tap **Connected devices** → **Quick Share** → **Who can share with you**.
- 2 Select an option.
  - **No one**: Do not allow others to find your tablet. Only other devices signed in to the same Samsung account can find your tablet.
  - **Contacts only**: Share with people saved in your contacts.
  - **Everyone**: Allow any nearby devices to share with your tablet.

## Music Share

Using the Music Share feature, you can share your Bluetooth speaker that is already connected to your tablet with another person. You can also listen to the same music on your Galaxy Buds and another person's Galaxy Buds.

This feature is available only on devices that support the Music Share feature.

### Sharing a Bluetooth speaker

On your tablet, open **Settings**, tap **Connected devices** → **Music Share**, and then tap the switch to turn it on.

Follow the on-screen instructions to share your Bluetooth speaker.

### Listening to music together with Galaxy Buds

You can listen to music on your tablet together through your Buds and your friend's Buds. This feature is supported only on the Galaxy Buds series.

- 1 Make sure that your tablet, your friend's phone, and a pair of Buds are connected to each other.  
Refer to [Pairing with other Bluetooth devices](#) for how to connect.
- 2 On your friend's phone, open **Settings**, tap **Connected devices**, and then tap the **Music Share** switch to turn it on.  
You can use additional features, such as setting who to share your device with, by tapping **Music Share**.
- 3 On your tablet, open the quick settings panel and tap **Media output**.
- 4 Select your friend's Buds from the detected devices list.
- 5 On your friend's phone, accept the connection request.  
When you play music through your tablet, you can listen to it together through both Buds.

## Smart View

### (Mirroring on a TV screen)

View your tablet's displayed content on a large screen by connecting your tablet to a screen mirroring-enabled TV or monitor.



1 Open the quick settings panel and tap **Smart View**.

2 Select a device to mirror your tablet's screen.

 When you play a video with Smart View, the resolution may vary depending on the TV model.

### Casting apps to the screen

Only display the video on the connected screen while you are checking private messages or using other features on your tablet at the same time.

Open the app to cast a video on the connected screen and tap the Smart View icon () → the App cast icon (.

 Some apps may not support this feature.

## Samsung Flow

Connect your tablet to a phone or a computer and use them together doing things like checking notifications and sharing content.

Samsung Flow must be installed on both devices that you want to connect. If Samsung Flow is not installed, download it from **Galaxy Store** or **Play Store**. For computers, you can download it from the Microsoft Store.

 This feature is only available on some Samsung Android devices and computers running Windows 10 or higher.

### Connecting to a phone

- 1 On your phone, open the Samsung Flow app.
- 2 On your tablet, open the **Flow** app and tap **Connect to phone**.  
If your tablet is connected to a computer, tap the More options icon (⋮) → **Connect to phone**.
- 3 Select your phone from the detected devices list.  
If the connection method selection pop-up window appears, select the method you want.
- 4 Confirm the passkey on both devices.  
The devices will be connected.

### Connecting to a computer

- 1 On your tablet, open the **Flow** app and tap **Connect to computer**.  
If your tablet is connected to a phone, tap the More options icon (⋮) → **Connect to computer**.
- 2 On your computer, open the Samsung Flow app and tap **Start**.
- 3 Select your tablet from the detected devices list.  
If the connection method selection pop-up window appears, select the method you want.
- 4 Confirm the passkey on both devices.  
The devices will be connected.

# Daily Board

## Introduction

Use your tablet as a picture frame or bulletin board when it is charging with a USB cable or charging dock. You can enjoy a slide show with your favorite images and check information, such as the time, weather, or your calendar. You can also create a note and control music while using it.

## Starting Daily Board

1 Charge the device with a USB cable or charging dock.

 To connect the device to a charging dock, slide the device into the charging dock to bring the device's connectors and charging dock's charging terminals into contact with each other.

2 Open the notification panel and tap **Tap here to start Daily Board**.

The Daily Board main screen will appear and you can check the clock, weather, or calendar.

## Using Daily Board

### Playing the slide show

You can use your device as a picture frame. Enjoy slide shows of your favorite images on Daily Board.

On the Daily Board main screen, swipe to the right to play a slide show.

 To add your favorite images to display to a slide show, open **Settings**, tap **Advanced features** → **Daily Board** → **Slideshow** → the Settings icon (⚙️) next to **Albums**, and then select the album.

### Making a note on Daily Board

You can use your device as a bulletin board to make a note on Daily Board.

1 Swipe to the left on the Daily board main screen and tap the Draw icon (✍️).

2 Select a pen and write or draw on the screen.

3 Tap **Done**.

The note you make will be pinned to Daily Board.

## Controlling the music

You can control music playback on Daily Board.

Tap the Music playback icon () and select an app to control playback.

## Configuring settings for Daily Board

Configure various settings for Daily Board and make Daily board more personalized.

Open **Settings** and tap **Advanced features** → **Daily Board**.

- **Time, weather, and calendar:** Change the setting for Daily Board main screen.
- **Memo:** Turn the memo feature on Daily Board on or off.
- **SmartThings:** Set the device to show SmartThings devices and scenes on the Daily Board.
- **Slideshow:** Select the images to add to the slide show and change the settings for slide show, such as the image order, transition speed, and style. You can also set the clock or weather information shown on the slide show.
- **Music:** Turn the music controller feature on Daily Board on or off.
- **Charge battery or tap icon:** While charging, a notification will appear on the notification panel that you can tap to start Daily Board.
  - **Add Daily Board to Apps screen:** The Daily Board app icon () will be added to the Apps screen.
  - **Auto start when connected to USB charger:** Daily Board will be start automatically when the device is charging with a USB cable.
- **Same as screen saver:** Use Daily Board as a screen saver.
- **Dark mode:** Apply Dark mode to the Daily Board. You can also set the schedule to apply Dark mode.
- **Turn off as scheduled:** Set the schedule to close Daily Board. When activating this feature, tap **Set time** to set the time to close Daily Board.
- **About Daily Board:** Check out the Daily Board version and legal information.
- **Contact us:** Ask questions or check frequently asked questions.

## Closing Daily Board

To close Daily Board, press the Home button or the Back button.

## Samsung DeX

Using Samsung DeX, you can use your mobile device like a computer by connecting the mobile device to an external display, such as a TV or monitor. While using Samsung DeX, you can simultaneously use your mobile device.

Visit [www.samsung.com/samsung-dex](http://www.samsung.com/samsung-dex) for more information.

-  • When starting or ending Samsung DeX, running apps may be closed.
- Some apps or features may not be available when using Samsung DeX.

### Selecting a Samsung DeX mode

Open **Settings**, tap **Connected devices** → **Samsung DeX**, and then select a mode you want.

- **New**: Use the same home screen layout, widgets, and icons of the tablet.
- **Classic**: Use your tablet's features in an interface environment similar to a computer.

### Wireless connections to external displays

On your mobile device, open **Settings** and tap **Connected devices** → **Samsung DeX** → **Classic** → **Connect wirelessly**. Follow the on-screen instructions to complete the connection. Some TVs or monitors will only be detected when its screen mirroring mode is turned on.

### Wired connections to external displays

You can connect your mobile device to an external display using an HDMI adapter (USB Type-C to HDMI).

Open **Settings**, tap **Connected devices** → **Samsung DeX** → **Classic**, and then tap the **Auto start when HDMI is connected** switch to turn it on.

-  Use only official Samsung DeX supported accessories that are provided by Samsung. Performance problems and malfunctions caused by using accessories that are not officially supported are not covered by the warranty.

## Controlling the Samsung DeX screen

Use the following methods to control the Samsung DeX screen on an external display.

- Controlling with an external keyboard and mouse

You can use a wireless keyboard/mouse.



You can set the mouse pointer to flow from the external display to the mobile device's screen. Open **Settings**, select **Samsung DeX → Mouse and trackpad**, and then select the **Flow pointer to tablet screen** switch to turn it on.

- Using your mobile device as a touchpad

On your mobile device, open the notification panel and tap **Use your tablet as a touchpad**.

- Using the screen keyboard

When you enter text to send messages, create notes, or perform other tasks, a screen keyboard will appear automatically on your mobile device's screen without connecting an external keyboard.

## Google apps

Google provides entertainment, social network, and business apps. You may require a Google Account to access some apps.

To check out more app information, access each app's help menu.

- **Chrome:** Search for information and browse webpages.
- **Gmail:** Send or receive emails through the Google Mail service.
- **Maps:** Find your location on the map, search the world map, and access location information for various places around you.
- **YT Music:** Enjoy various music and videos provided by YouTube Music. You can also access the music collections stored on your device and play them.
- **Google TV:** Purchase or rent videos, such as movies and TV programs, from **Play Store**.
- **Drive:** Store your content on the cloud, access it from anywhere, and share it with others.
- **YouTube:** Watch or create videos and share them with others.
- **Photos:** Search for, manage, and edit all your pictures and videos from various sources in one place.
- **Google:** Search for items on the internet or your device.
- **Meet:** Make video calls or create or join video meetings.
- **Messages:** Send and receive messages on your device or computer, and share various content, such as images and videos.
- **Gemini:** Chat with Gemini to use various features, such as searching for information, creating custom images, or writing content.



Some apps may not be available depending on the carrier or model.

# Settings

## Introduction

Customize device settings.

On the Apps screen, tap **Settings**. Alternatively, open the quick settings panel and tap the Settings icon (⚙️).

To search for settings by entering keywords, tap the Search icon (🔍). You can also search for settings by selecting a topic.

## Sign in to your Galaxy

Sign in to your Samsung account and manage it.

On the Settings screen, tap **Sign in to your Galaxy**.

## Connections

### Options

Change settings for various connections, such as the Wi-Fi feature and Bluetooth.

On the Settings screen, tap **Connections**.

- **Wi-Fi:** Turn on the Wi-Fi feature to connect to a Wi-Fi network and access the internet or other network devices. Refer to [Wi-Fi](#) for more information.
- **Bluetooth:** Use Bluetooth to exchange data or media files with other Bluetooth-enabled devices. Refer to [Bluetooth](#) for more information.
- **NFC and contactless payments:** Read near field communication (NFC) tags that contain information about products. You can also use this feature to make payments and buy tickets for transportation or events after downloading the required apps. Refer to [NFC and contactless payments](#) for more information.

- **Airplane mode:** Set the device to turn off all wireless functions on your device. You can use only non-network services.
    - ⚠ Follow the regulations provided by the airline and the instructions of aircraft personnel. In cases where it is allowed to use the device, always use it in Airplane mode.
  - **SIM manager:** Activate your SIM cards and customize the SIM card settings. Refer to [SIM manager](#) for more information.
  - **Mobile networks:** Configure your mobile network settings.
  - **Data usage:** Keep track of your data usage amount and customize the settings for the limitation. Set the device to automatically disable the mobile data connection when the amount of mobile data you have used reaches your specified limit.

You can turn on the data saver feature to prevent some apps running in the background from sending or receiving data. Refer to [Data saver \(Mobile network enabled models\)](#) for more information.

You can also set apps to use only a Wi-Fi or mobile data, or both. Refer to [Allowed networks for apps \(Mobile network enabled models\)](#) for more information.
  - **Mobile Hotspot and Tethering:** Use the tablet as a mobile hotspot to share the tablet's mobile data connection with other devices. For more information about Mobile Hotspot, refer to [Mobile Hotspot \(Mobile network enabled models\)](#).
    - 📝 You may incur additional charges when using this feature.
  - **Tethering:** Use tethering to share the device's internet connection with other devices.
  - **More connection settings:** Customize settings to control other features. Refer to [More connection settings](#) for more information.
- 📝 Some features may not be available depending on the model.

## Wi-Fi

Turn on the Wi-Fi feature to connect to a Wi-Fi network and access the internet or other network devices.

### Connecting to a Wi-Fi network

1 On the Settings screen, tap **Connections** → **Wi-Fi** and tap the switch to turn it on.

2 Select a network from the Wi-Fi networks list.

Networks with a lock icon require a password.

-  • Once the device connects to a Wi-Fi network, the device will reconnect to that network each time it is available without requiring a password. To prevent the device from connecting to the network automatically, tap the Settings icon (⚙️) next to the network and tap the **Auto reconnect** switch to turn it off.
- If you cannot connect to a Wi-Fi network properly, restart your device's Wi-Fi feature or the wireless router.

### Sharing Wi-Fi network passwords

If you make a request to a person who is connected to a secured Wi-Fi network to share its password, you can connect to the network without entering the password. This feature is available between the devices which have contacts each other and the screen of the other device must be turned on.

1 On the Settings screen, tap **Connections** → **Wi-Fi** and tap the switch to turn it on.

2 Select a network from the Wi-Fi networks list.

3 Tap **Request password**.

4 Accept the share request on the other device.

The Wi-Fi password is entered on your device and it is connected to the network.

## Wi-Fi Direct

Wi-Fi Direct connects devices directly through a Wi-Fi network without requiring an access point.

- 1 On the Settings screen, tap **Connections** → **Wi-Fi** and tap the switch to turn it on.
- 2 Tap the More options icon (⋮) → **Wi-Fi Direct**.  
The detected devices are listed.  
If the device you want to connect to is not in the list, request that the device turns on its Wi-Fi Direct feature.
- 3 Select a device to connect to.  
The devices will be connected when the other device accepts the Wi-Fi Direct connection request.  
To end the device connection, select the device to disconnect from the list.

## Bluetooth

Use Bluetooth to exchange data or media files with other Bluetooth-enabled devices.

### ⚠ Precautions for using Bluetooth

- Samsung is not responsible for the loss, interception, or misuse of data sent or received through Bluetooth.
- Always ensure that you share and receive data with devices that are trusted and properly secured. If there are obstacles between the devices, the operating distance may be reduced.
- Some devices, especially those that are not tested or approved by the Bluetooth SIG, may be incompatible with your device.
- Do not use the Bluetooth feature for illegal purposes (for example, pirating copies of files or illegally tapping communications for commercial purposes). Samsung is not responsible for the repercussion of illegal use of the Bluetooth feature.

## Pairing with other Bluetooth devices

- 1 On the Settings screen, tap **Connections** → **Bluetooth** and tap the switch to turn it on.  
The detected devices will be listed.
  - 2 Select a device to pair with.  
If the device you want to pair with is not on the list, set the device to enter Bluetooth pairing mode. Refer to the other device's user guides.
-  Your tablet is visible to other devices while the Bluetooth settings screen is open.
- 3 Accept the Bluetooth connection request on your tablet to confirm.  
The devices will be connected when the other device accepts the Bluetooth connection request.  
To unpair the devices, tap the Settings icon (⚙️) next to the device name to unpair and tap **Unpair**.

## Sending and receiving data

Many apps support data transfer through Bluetooth. You can share data, such as contacts or media files, with other Bluetooth devices. The following actions are an example of sending an image to another device.

- 1 Open the **Gallery** app and select an image.
- 2 Tap the Share icon (↗️) → **Bluetooth** and select a device to transfer the image to.  
If the device you want to pair with is not in the list, request that the device turns on its visibility option.
- 3 Accept the Bluetooth connection request on the other device.

## NFC and contactless payments

You can use your tablet to read near field communications tags (NFC) that contain information about products. You can also use this feature to make payments and buy tickets for transportation or events after downloading the required apps.

- ❗ The center of the device's front contains a built-in NFC antenna. Handle the device carefully to avoid damaging the NFC antenna.

### Reading information from NFC tags

Use the NFC feature to read product information from NFC tags.

- 1 On the Settings screen, tap **Connections** and tap the **NFC and contactless payments** switch to turn it on.
- 2 Place the NFC antenna area on the front of your device near an NFC tag. The information from the tag appears.

- 📝 Ensure that the device's screen is turned on and unlocked. Otherwise, the device will not read NFC tags or receive data.

### Making payments with the NFC feature

Before you can use the NFC feature to make payments, you must register for the mobile payment service. To register or get more information about the service, contact your service provider.

- 1 On the Settings screen, tap **Connections** and tap the **NFC and contactless payments** switch to turn it on.
- 2 Touch the NFC antenna area on the front of your device to the NFC card reader.

To set the default payment app, on the Settings screen, tap **Connections** → **NFC and contactless payments** → **Default wallet app** and select an app.

- 📝 • The payment services list may not include all available payment apps.
- If you update the payment app or install a new one, the payment services that you used before may not work properly. If that is the case, on the Settings screen, tap **Connections** → **NFC and contactless payments** → **Default wallet app** or **Non-payment NFC services**, and then select another app instead of the updated or newly installed app. Or, deselect the selected app.

## Data saver (Mobile network enabled models)

Reduce your data usage by preventing some apps running in the background from sending or receiving data.

On the Settings screen, tap **Connections** → **Data usage** → **Data saver** and tap the switch to turn it on.

When the data saver feature is turned on, the Data saver icon () will appear on the status bar.

 To select apps to use data without restriction, tap **Apps that can always use data** and select apps.

## Allowed networks for apps (Mobile network enabled models)

Set apps to use only a Wi-Fi or mobile data, or both.



For example, you can set the device to use only mobile data for apps that you want to keep secure or streaming apps that can be disconnected. Even if you do not turn off the Wi-Fi feature, the apps will open using the mobile data.

On the Settings screen, tap **Connections** → **Data usage** → **Allowed networks for apps**. Tap an app you want from the apps list and select a network option.

 You may incur additional charges when using the mobile data.

## Mobile Hotspot (Mobile network enabled models)

Use your tablet as a mobile hotspot to share your tablet's mobile data connection with other devices.

- 1 On the Settings screen, tap **Connections** → **Mobile Hotspot and Tethering** → **Mobile Hotspot**.
  - 2 Tap the switch to turn it on.  
You can change the network name, password, and more.  
The Hotspot icon () appears on the status bar.
  - 3 On the other device's screen, search for and select your tablet from the Wi-Fi networks list.  
Alternatively, tap **QR code** on the Mobile Hotspot screen and scan the QR code with the other device.
-  • If the mobile hotspot is not found, on your tablet, set **Band** to **2.4 GHz**, tap **Advanced**, and then tap the **Hidden network** switch to turn it off.
  - If you turn on the **Auto Hotspot** feature, you can share your tablet's mobile data connection with other devices signed in to your Samsung account.

## More connection settings

Customize settings to control other connection features.

On the Settings screen, tap **Connections** → **More connection settings**.

- **Nearby device scanning:** Set the tablet to scan for nearby devices to connect to.
- **Printing:** Configure settings for printer plug-ins installed on the device. You can search for available printers or add one manually to print files. Refer to [Printing](#) for more information.
- **VPN:** Set up virtual private networks (VPNs) on your device to connect to a school or company's private network.
- **Private DNS:** Set the device to use the security enhanced private DNS.
- **Ethernet:** When you connect an Ethernet adapter, you can use a wired network and configure network settings.
- **Auto update system configurations:** Allow automatic configuration changes to ensure that network connection features work as expected.

## Printing

Configure settings for printer plug-ins installed on the device. You can connect the device to a printer through Wi-Fi or Wi-Fi Direct, and print images or documents.

 Some printers may not be compatible with the device.

### Adding printer plug-ins

Add printer plug-ins for printers you want to connect the device to.

1 On the Settings screen, tap **Connections** → **More connection settings** → **Printing** → **Download plugin**.

2 Select a printer plug-in and install it.

3 Select the installed printer plug-in.

The device will automatically search for printers that are connected to the same Wi-Fi network as your device.

4 Select a printer to add.

 To add printers manually, tap the More options icon (⋮) → **Add printer**.

### Printing content

While accessing content, such as images or documents, access the options list, tap **Print** → the Dropdown icon (▼) → **All printers...**, and then select a printer.

 Printing methods may vary depending on the content type.

## Connected devices

Change settings for device connections.

On the Settings screen, tap **Connected devices**.

- **Quick Share:** Change the Quick Share settings. Refer to [Quick Share](#) for more information.
- **Music Share:** Change the Music Share settings. Refer to [Music Share](#) for more information.
- **Auto switch Buds:** Set the Galaxy Buds to switch from another device to your tablet when you make or answer a call, play media, and more. You can use this feature only when you signed in to the same Samsung account on the other device and you are wearing your Galaxy Buds.
- **Call & text on other devices:** Connect your tablet and phone to use calling and messaging features on the tablet with your phone number. You must register and sign in to the same Samsung account on the tablet and phone. Some calling and messaging features may not be available.
- **Continue on other devices:** Use your tablet's apps and features on other devices signed in to your Samsung account.
- **Storage Share:** Share your tablet's files with your Samsung TV or Galaxy Book. To use this feature, both devices need to be signed in to the same Samsung account and have Wi-Fi, Bluetooth, and the Storage Share feature turned on.
- **Link to Windows:** Access and use the mobile device's data, such as apps or pictures, on a Windows computer. A Microsoft account is required to use this feature. Visit <https://aka.ms/setupltw> for details.
- **Multi control:** Use a mouse and keyboard connected to a Samsung computer that supports this feature on your tablet.
- **Second screen:** Connect your tablet and computer to use the tablet as an additional display for the computer. Your computer must be running Windows 10 or higher.
- **Samsung DeX:** Use your mobile device's features in an interface environment similar to a computer. Refer to [Samsung DeX](#) for more information.
- **Smart View:** View your tablet's displayed content on a large screen by connecting your tablet to a screen mirroring-enabled TV or monitor. Refer to [Smart View](#) for more information.

- **SmartThings:** Control and manage smart appliances and Internet of Things (IoT) products. Refer to [SmartThings](#) for more information.
- **Android Auto:** Connect your device to a vehicle and control some of your device's features on the vehicle's display.

 Some features may not be available depending on the model.

## Modes and Routines

### Using modes

Add a mode based on your current activity or location. Your device's settings will change to match your activity or situation. You can turn the mode on or off from the quick settings panel.

### Adding modes

- 1 On the Settings screen, tap **Modes and Routines** → the Modes icon (🕒).
- 2 Select a mode you want or tap **Add mode** to add your own modes.

### Running modes

Modes will run automatically when their conditions are detected. You can also run them manually by tapping the button whenever you want.

To run modes manually, select the mode you want and tap **Turn on**.

To turn off a running mode, tap the mode and tap **Turn off**.

Alternatively, open the quick settings panel, tap **Modes**, and then select a mode to turn it on. To turn the mode off, tap the mode button on the quick settings panel.

## Using routines

Automate your repetitive daily tasks. For example, you can automatically change your sound settings depending on where you are, optimize your device's settings for gaming, and more.

### Adding routines

- 1 On the Settings screen, tap **Modes and Routines** → the Routines icon (👤).
- 2 Tap the Create icon (+) and add your own routines or tap the Discover icon (🔍) and select a routine you want.  
If you want to set the routine's running condition to manual, tap **Start manually**. This option will appear only when there are no running conditions set.

### Running routines

Auto routines will run automatically when their conditions are detected. For routines which you set the running condition as **Start manually**, you can run them manually by tapping the button whenever you want.

To run routines manually, tap the Start icon (▶) next to the routine you want to run. If you want to use a widget, tap a routine under **Manual routines** and tap **More** → **Set as widget** → **Add**. The routine will be added as a widget to the Home screen and you can run the routine by tapping the widget.

To stop running routines, tap the Routine list icon (⏏), tap the routine under **Running**, and then tap **Stop**, or tap the routine's widget on the Home screen.

# Sounds and vibration

## Options

Change settings for various sounds on the device.

On the Settings screen, tap **Sounds and vibration**.

- **Sound / Vibrate / Mute**: Set the device to use sound mode, vibration mode, or silent mode.
- **Vibrate while ringing**: Set the device to vibrate and play a ringtone for incoming calls.
- **Temporary mute**: Set the device to use silent mode for a certain period.
- **Ringtone**: Change the call ringtone.
- **Notification sound**: Change the notification sound.
- **System sound**: Change the sound to use for certain actions, such as charging the device.
- **Volume**: Adjust the device's volume level.
- **Call vibration**: Change the call vibration settings.
- **Notification vibration**: Change the notification vibration settings.
- **System vibration**: Select actions to receive vibration feedback and adjust the vibration intensity.
- **Vibration intensity**: Adjust the force of the vibration notification.
- **Sound quality and effects**: Set the device's sound quality and effects. Refer to [Sound quality and effects](#) for more information.
- **Separate app sound**: Set the device to play media sound from a specific app separately on the other audio device. Refer to [Separate app sound](#) for more information.



Some features may not be available depending on the model.

## Sound quality and effects

Set the device's sound quality and effects.

On the Settings screen, tap **Sounds and vibration** → **Sound quality and effects**.

- **Dolby Atmos:** Select a surround sound mode optimized for various types of audio, such as movies, music, and voice. With Dolby Atmos, you can experience moving audio sounds that flow all around you.
- **Equalizer:** Change the sound profile and enjoy optimized sound.
- **Loudness normalization:** Reduce the differences in volume between different content. The device will automatically increase the volume of content with low volume.
- **App sound settings:** Check and manage the optimized sound settings you saved for each media app. To adjust sound settings for each app, open the quick settings panel while playing content in the app, touch and hold the volume adjustment bar, and then change the settings. The same settings will be applied the next time you run the app.
- **Adapt sound:** Set the best sound for you.
- **UHQ upscaler:** Enhance the sound resolution of music and videos when using wired headphones or Bluetooth headphones that support UHQ.



Depending on the model, you must connect headphones to use some features.

## Separate app sound

Set the device to play media sound from a specific app on the connected Bluetooth speaker or headset.

For example, you can listen to the Navigation app through your device's speaker while listening to playback from the Music app through the vehicle's Bluetooth speaker.

- 1 On the Settings screen, tap **Sounds and vibration** → **Separate app sound** and tap the switch to turn it on.
- 2 Select an app to play media sounds separately and press the Back button.
- 3 Select a device for playing the selected app's media sound.

## Notifications

Change the notification settings.

On the Settings screen, tap **Notifications**.

- **App notifications:** Select the apps you want to receive notifications from.
- **Lock screen notifications:** Set how to show notifications on the locked screen.
- **Status bar:** Set how to display notification icons and whether to display the remaining battery percentage on the status bar.
- **Notification pop-up style:** Select a notification pop-up style and change the settings.
- **Do not disturb:** Set the device to mute all sounds except for allowed exceptions.
- **Advanced settings:** Configure advanced settings for notifications.

## Display

### Options

Change the display and the Home screen settings.

On the Settings screen, tap **Display**.

- **Light / Dark:** Turn Dark mode on or off.
- **Dark mode settings:** Reduce eye strain by applying the dark theme when using the device at night or in a dark place. You can set a schedule for applying Dark mode.  
 The dark theme may not be applied in some apps.
- **Brightness:** Adjust the brightness of the display.
- **Adaptive brightness:** Set the device to keep track of your brightness adjustments and apply them automatically in similar lighting conditions.
- **Motion smoothness:** Change the refresh rate of the screen. When a high refresh rate is set, the screen will scroll more smoothly. Refer to [Motion smoothness](#) for more information.

- **Eye comfort shield:** Reduce eye strain by limiting the amount of blue light emitted by the screen. You can set a schedule for applying this feature.
- **Screen mode:** Change the screen mode to adjust the display's color and contrast. Refer to [Changing the screen mode or adjusting the display color](#) for more information.
- **Font size and style:** Change the font size and style.
- **Screen zoom:** Make the items on the screen larger or smaller.
- **Aspect ratio:** Select an aspect ratio for each app to run.
- **Screen timeout:** Set the length of time the device waits before turning off the display's backlight.
- **Edge panels:** Change the settings for the Edge panel.
- **Taskbar:** Change the settings for the taskbar. Refer to [Taskbar](#) for more information.
- **Navigation type:** Change the navigation type settings.
- **Touch sensitivity:** Increase the touch sensitivity of the screen for use with screen protectors.
- **Screen saver:** Set the device to launch a screensaver when the device is charging.



Some features may not be available depending on the model.

## Motion smoothness

The refresh rate is the number of times the screen is refreshed every second. Use a high refresh rate to prevent the screen from flickering when switching between screens. The screen will scroll more smoothly. When you select a standard refresh rate, you can use the battery longer.

- 1 On the Settings screen, tap **Display** → **Motion smoothness**.
- 2 Select a refresh rate.
  - **Adaptive:** Get smoother animations and scrolling by automatically adjusting your screen refresh rate into a higher one.
  - **Standard:** Use a standard refresh rate in normal situations to conserve battery power.

## Changing the screen mode or adjusting the display color

Change the screen mode or adjust the display color to your preference.

### Changing the screen mode

On the Settings screen, tap **Display** → **Screen mode** and select a mode you want.

- **Vivid:** This optimizes the color range, saturation, and sharpness of your display.
- **Natural:** This adjusts the screen to a natural tone.
-  • You can adjust the display color only in **Vivid** mode.
- **Vivid** mode may not be compatible with third-party apps.

### Optimizing the full screen color balance

Optimize the display color by adjusting the color tones to your preference.

On the Settings screen, tap **Display** → **Screen mode** → **Vivid** and adjust the color adjustment bar under **White balance**.

When you drag the color adjustment bar towards **Cool**, the blue color tone will increase. When you drag the bar towards **Warm**, the red color tone will increase.

## Battery

Check the remaining battery power and time to use the device. For devices with low battery levels, conserve battery power by turning on power saving features.

On the Settings screen, tap **Battery**.

- **Power saving:** Turn on power saving mode to extend the battery's usage time.
- **Background usage limits:** Limit battery usage for apps that you do not use often.
- **Battery protection:** Set to stop charging when the battery is fully charged or limit the maximum charge to the preset level.

- **Today:** Check the battery level and usage history.
- **Charging settings:** Configure the charging settings.
- **Auto dim screen:** Dim the screen when the remaining battery power drops below a certain level.
- **Show battery percentage:** Display the remaining battery percentage on the status bar.
- **Battery information:** Check out battery information.



- The usage time left shows the time remaining before the battery power runs out. Usage time left may vary depending on your device settings and operating conditions.
- The remaining battery power is displayed as the average level of the batteries.
- If the remaining battery power of the batteries is different, the device automatically balances the difference. To reduce the difference, the battery with the higher power may be consumed even when the device is not in use.
- You might not receive notifications from some apps that use power saving mode.

## Wallpaper and style

Change the wallpaper settings for the Home screen and the locked screen.

On the Settings screen, tap **Wallpaper and style**.

## Home screen

Configure settings for the Home screen, such as the screen layout.

On the Settings screen, tap **Home screen**.

# Lock screen

## Options

Change the settings for the locked screen.

On the Settings screen, tap **Lock screen**.

- **Screen lock and biometrics:** Change the screen lock method.
  - **Extend Unlock:** Set the device to unlock itself when trusted locations or devices are detected. Refer to [Extend Unlock](#) for more information.
  - **Secure lock settings:** Change screen lock settings for the selected lock method.
  - **Now bar:** Select items to display on the locked screen.
  - **Touch and hold to edit:** Set the device to display the editing options when you touch and hold the locked screen.
  - **Roaming clock:** Change the clock to show both the local and home time zones on the locked screen when roaming.
  - **Contact information:** Set the device to show contact information, such as your email address, on the locked screen.
  - **Show unlock transition effect:** Set to display the unlock transition effect when you unlock the screen through your biometric data.
  - **About Lock screen:** Check out the Lock screen version and legal information.
-  • Some features may not be available depending on the carrier or model.
- The available options may vary depending on the screen lock method selected.

## Extend Unlock

You can set the device to unlock itself and remain unlocked when trusted locations or devices are detected.

For example, if you have set your home as a trusted location, when you get home your device will detect the location and automatically unlock itself.

On the Settings screen, tap **Lock screen** → **Extend Unlock** and follow the on-screen instructions to complete the setup.

-  • This feature will be available to use after you set a screen lock method.
- If you do not use your device for four hours or when you turn on the device, you must unlock the screen using the pattern, PIN, or password you set.

# Security and privacy

## Options

Check the device's security and privacy status and change the settings.

On the Settings screen, tap **Security and privacy**.

- **Lock screen:** Change the settings for the locked screen.
- **Account security:** Change the settings for your accounts.
- **Lost device protection:** Turn the Find My Mobile feature on or off. Access [smarthingsfind.samsung.com](https://smarthingsfind.samsung.com) to track and control your lost or stolen tablet. You can also check the location of the wearable devices connected to this tablet.
- **App security:** Scan apps and keep your device safe from malicious software.
- **Updates:** Check the version of your device's software and check for updates.
- **Screen lock and biometrics:** Change the settings for the locked screen and biometric data. Refer to [Face recognition](#) and [Fingerprint recognition](#) for more information.
- **Auto Blocker:** Keep your device safe by blocking threats and other suspicious activity.
- **Security status of your devices:** Check the security status of your devices that are signed in to your Samsung account.
- **More security settings:** Configure additional security settings. Refer to [Secure Wi-Fi](#), [Secure Folder](#), and [Samsung Pass](#) for more information.
- **Permissions used in last 24 hours:** Check the app or feature's permission usage history.
- **Internet privacy protection:** Check the internet privacy protection history and change settings. This feature will be added when you use the **Samsung Internet** app.
- **Controls and alerts:** Control access to features such as the microphone and clipboard.
- **More privacy settings:** Configure additional privacy settings.



Some features may not be available depending on the carrier or model.

## Face recognition

You can set the device to unlock the screen by recognizing your face.

-  • If you use your face as a screen lock method, your face cannot be used to unlock the screen for the first time after turning on the device. To use the device, you must unlock the screen using the pattern, PIN, or password you set when registering the face. Be careful not to forget your pattern, PIN, or password.
- If you change the screen lock method to **Swipe** or **None**, which are not secure, all of your biometric data will be deleted.

### Precautions for using face recognition

Before using the face recognition to unlock your device, keep the following precautions in mind.

- Your device could be unlocked by someone or something that looks like your image.
- Face recognition is less secure than Pattern, PIN, or Password.

### For better face recognition

Consider the following when using face recognition:

- Consider the conditions when registering, such as wearing glasses, hats, masks, beards, or heavy makeup
- Ensure that you are in a well-lit area and that the camera lens is clean when registering
- Ensure your image is not blurry for better match results

## Registering your face

For better face registration, register your face indoors and out of direct sunlight.

1 On the Settings screen, tap **Security and privacy** → **Screen lock and biometrics** → **Face recognition**.

2 Set a screen lock method.

3 Read the on-screen instructions and tap **Continue**.

4 Tap **Register** and position your face inside the frame on the screen.

The camera will scan your face.



- If unlocking the screen with your face is not working properly, tap **Remove face data** to remove your registered face and register your face again.

- To enhance the face recognition, tap **Add alternative appearance to enhance recognition** and add an alternate appearance.

## Unlocking the screen with your face

You can unlock the screen with your face instead of using a pattern, PIN, or password.

1 On the Settings screen, tap **Security and privacy** → **Screen lock and biometrics**.

2 Unlock the screen using the preset screen lock method.

3 Tap **Face recognition** and tap the **Face unlock** switch to turn it on.

4 On the locked screen, look at the screen.

When your face is recognized, you can unlock the screen without using any additional screen lock method. If your face is not recognized, use the preset screen lock method.

## Deleting the registered face data

You can delete face data that you have registered.

1 On the Settings screen, tap **Security and privacy** → **Screen lock and biometrics**.

2 Unlock the screen using the preset screen lock method.

3 Tap **Face recognition** → **Remove face data** → **Remove**.

Once the registered face is deleted, all the related features will also be turned off.

## Fingerprint recognition

In order for fingerprint recognition to function, your fingerprint information needs to be registered and stored in your device.

-  • This feature may not be available depending on the carrier or model.
- Fingerprint recognition uses the unique characteristics of each fingerprint to enhance the security of your device. The likelihood of the fingerprint sensor confusing two different fingerprints is very low. However, in rare cases where separate fingerprints are very similar the sensor may recognize them as identical.
- If you use your fingerprint as a screen lock method, your fingerprint cannot be used to unlock the screen for the first time after turning on the device. To use the device, you must unlock the screen using the pattern, PIN, or password you set when registering the fingerprint. Be careful not to forget your pattern, PIN, or password.
- If your fingerprint is not recognized, unlock the device using the pattern, PIN, or password you set when registering the fingerprint, and then re-register your fingerprints. If your pattern, PIN, or password is forgotten, you will not be able to use the device if you do not reset it. Samsung is not responsible for any data loss or inconvenience caused by forgotten unlock codes.
- If you change the screen lock method to **Swipe** or **None**, which are not secure, all of your biometric data will be deleted.

## For better fingerprint recognition

When you scan your fingerprints on the device, be aware of the following conditions that may affect the feature's performance:

- The device may not recognize fingerprints that are affected by wrinkles or scars.
- The device may not recognize fingerprints from small or thin fingers.
- To improve recognition performance, register the fingerprints of the fingers used most often to perform tasks on the device.
- The Home button has a built-in fingerprint recognition sensor. Ensure that the fingerprint recognition sensor is not scratched or damaged by metal objects, such as coins, keys, and necklaces.
- Covering the fingerprint recognition sensor with accessories, such as stickers, may decrease the fingerprint recognition rate.
- Ensure that the fingerprint recognition sensor and your fingers are clean and dry.
- If you bend your finger or use a fingertip, the device may not recognize your fingerprints. Make sure to cover the entire fingerprint recognition sensor with your finger.
- In dry environments, static electricity can build up in the device. Avoid using this feature in dry environments or before using the feature, discharge static electricity by touching a metal object.

## Registering fingerprints

On the Settings screen, tap **Security and privacy** → **Screen lock and biometrics** → **Fingerprints** and follow the on-screen instructions to register your fingerprint. After registering, you can check whether your fingerprint is registered and its name by tapping **Check added fingerprints**.

## Unlocking the screen with your fingerprints

You can unlock the screen with your fingerprint instead of using a pattern, PIN, or password.

- 1 On the Settings screen, tap **Security and privacy** → **Screen lock and biometrics**.
- 2 Unlock the screen using the preset screen lock method.
- 3 Tap **Fingerprints** and tap the **Fingerprint unlock** switch to turn it on.
- 4 On the locked screen, place your finger on the fingerprint recognition sensor and scan your fingerprint.

## Recognizing your fingerprints with the screen turned off

- 1 On the Settings screen, tap **Security and privacy** → **Screen lock and biometrics**.
- 2 Unlock the screen using the preset screen lock method.
- 3 Tap **Fingerprints** and tap the **Fingerprint always on** switch to turn it on.

## Deleting registered fingerprints

You can delete registered fingerprints.

- 1 On the Settings screen, tap **Security and privacy** → **Screen lock and biometrics**.
- 2 Unlock the screen using the preset screen lock method.
- 3 Tap **Fingerprints**, select a fingerprint to delete, and then tap **Remove**.

## Secure Wi-Fi

Secure Wi-Fi is a service that secures your Wi-Fi network connection. It encrypts data using Wi-Fi networks and disables tracking apps and websites so that you can use Wi-Fi networks safely. For example, when using an unsecure Wi-Fi network in public places, such as cafes or airports, Secure Wi-Fi is automatically turned on so that no one can hack your login information or monitor your activity in apps and websites.

On the Settings screen, tap **Security and privacy** → **More security settings** → **Secure Wi-Fi** and follow the on-screen instructions to complete the setup. If you tap **Protection activity**, you can check the history of how and when your network was protected with Secure Wi-Fi.

When Secure Wi-Fi is turned on, the VPN icon (🔒) will appear on the status bar.

- 📌 • Using this feature may result in a slower Wi-Fi network speed.
- This feature may not be available depending on the Wi-Fi network, carrier, or model.

## Selecting apps to protect using Secure Wi-Fi

Select apps to protect using Secure Wi-Fi so that you can safely protect data, such as your password or your activity in apps, from being accessed by others.

On the Settings screen, tap **Security and privacy** → **More security settings** → **Secure Wi-Fi** → the More options icon (⋮) → **Settings** → **Protected apps** and tap the switches next to the apps you want to protect using Secure Wi-Fi.

- 📌 Some apps may not support this feature.

## Purchasing protection plan

You are provided with a free protection plan for Wi-Fi networks every month. You can also purchase paid protection plans and have unlimited bandwidth protection for a limited time.



- 1 On the Settings screen, tap **Security and privacy** → **More security settings** → **Secure Wi-Fi**.
- 2 Tap **Protection plan** → **Upgrade** and select the plan you want.
  - 📌 For certain protection plans, you can transfer the protection plan to another device signed in to your Samsung account.
- 3 Follow the on-screen instructions to complete the purchase.

## Secure Folder



Secure Folder protects your private content and apps, such as pictures and contacts, from being accessed by others. You can keep your private content and apps secure even when the device is unlocked.

-  Secure Folder is a separate, secured storage area. The data in Secure Folder cannot be transferred to other devices through unapproved sharing methods, such as USB or Wi-Fi Direct. Attempting to customize the operating system or modifying software will cause Secure Folder to be automatically locked and inaccessible. Before saving data in Secure Folder, make sure to back up a copy of the data in another secure location.

### Setting up Secure Folder

- 1 Open **Settings** and tap **Security and privacy** → **More security settings** → **Secure Folder**.
  - 2 Follow the on-screen instructions to complete the setup.  
When a pop-up window asking whether you want to reset the Secure Folder lock type with your Samsung account appears, tap **Allow**. If you have forgotten the lock type, you can reset it using your Samsung account. If you do not turn on this feature, you cannot reset the lock type when you have forgotten it.  
When the setup is complete, the Secure Folder screen will appear and the Secure Folder app icon () will be added to the Apps screen.
- 
    - When the **Secure Folder** app is locked, you must unlock it using your preset lock method.
    - To change the name or icon of Secure Folder, tap the More options icon () → **Customize**.

### Setting an auto lock condition for Secure Folder

- 1 Open the **Secure Folder** app and tap the More options icon () → **Settings** → **Auto lock Secure Folder**.
  - 2 Select a lock option.
-  To manually lock your Secure Folder, tap the More options icon () → **Lock and exit**.

## Moving content to Secure Folder

Move content, such as pictures and videos, to Secure Folder. The following actions are an example of moving an image from the default storage to Secure Folder.

- 1 Open the **Secure Folder** app and tap the More options icon (⋮) → **Add files**.
- 2 Tap **Images**, tick images to move, and then tap **Done**.
- 3 Tap **Move**.  
The selected items will be deleted from the original folder and moved to Secure Folder. To copy items, tap **Copy**.

 The method for moving content may vary depending on the content type.

## Moving content from Secure Folder

Move content from Secure Folder to the corresponding app in the default storage. The following actions are an example of moving an image from Secure Folder to the default storage.

- 1 Open the **Secure Folder** app and tap **Gallery**.
- 2 Select an image and tap the More options icon (⋮) → **Move out of Secure Folder**.  
The selected items will be moved to **Gallery** in the default storage.

## Adding apps

Add an app to use in Secure Folder.

- 1 Open the **Secure Folder** app and tap the Add apps icon (+).
- 2 Tick one or more apps installed on the device and tap **Add**.

## Removing apps from Secure Folder

Touch and hold an app to delete, and tap **Uninstall**.

## Adding accounts

Add your Samsung and Google accounts, or other accounts, to sync with the apps in Secure Folder.

- 1 Open the **Secure Folder** app and tap the More options icon (⋮) → **Settings** → **Manage accounts** → **Add account**.
- 2 Select an account service.
- 3 Follow the on-screen instructions to complete the account setup.

## Hiding Secure Folder

You can hide the Secure Folder shortcut from the Apps screen.

Open the **Secure Folder** app, tap the More options icon (⋮) → **Settings**, and then tap the **Add Secure Folder to Apps screen** switch to turn it off.

If you want to show the Secure Folder again, open **Settings**, tap **Security and privacy** → **More security settings** → **Secure Folder**, unlock the screen using the preset screen lock method, and then tap the **Add Secure Folder to Apps screen** switch to turn it on.

## Uninstalling Secure Folder

You can uninstall Secure Folder, including the content and apps in it.

Open the **Secure Folder** app and tap the More options icon (⋮) → **Settings** → **More settings** → **Uninstall**.

To back up content before uninstalling Secure Folder, tick **Move media files out of Secure Folder** and tap **Uninstall**. To access data backed up from Secure Folder, open the **My Files** app and tap **Internal storage** → **Download** → **Secure Folder**.

 Notes saved in **Samsung Notes** will not be backed up.

## Samsung Pass

Verify your identity with Samsung Pass when using services which require your login or personal information.

### Registering Samsung Pass

On the Settings screen, tap **Security and privacy** → **More security settings** → **Passwords, passkeys, and autofill** → **Samsung Pass**. Follow the on-screen instructions to complete the setup.

### Saving your information to Samsung Pass

When you save apps' or websites' sign-in or personal information in Samsung Pass, you can enter the information automatically.

 You can save your information manually or check and manage the saved information on Samsung Pass.

### Saving your sign-in information

On the sign-in page of the app or website, enter your ID and password, and then tap the sign-in button. When a pop-up window asking whether you want to save the sign-in information appears, tap **Save**.

### Saving your personal information

On the Samsung Pass main screen, select an option under **Private info**, enter the information, and then tap **Save**.

### Entering your information automatically

You can automatically enter your sign-in or personal information, such as your address or payment card information, saved in Samsung Pass.

- 
- This feature may not be available in some apps or websites.
  - The website autofill feature is only available for websites that you access through the **Samsung Internet** app.

## Signing in using passkeys

In apps or websites that support sign-in with a passkey, you can sign in with a passkey saved in Samsung Pass instead of the sign-in information.

- 1 On the app or website you are using, create a passkey.  
The method for creating a passkey may differ depending on the app or website.
- 2 When a pop-up window asking whether you want to save the passkey appears, select Samsung Pass and follow the on-screen instructions to save the passkey.  
Now you can sign in with the passkey saved in Samsung Pass.

## Location

Change settings for location information permissions.

On the Settings screen, tap **Location**.

- **App permissions:** Check the list of apps that have permission to access the device's location and edit the permission settings.
- **Location services:** Set the device to use the Wi-Fi or Bluetooth feature to increase the accuracy of your location information, even when the features are turned off. You can also check the location services your device is using.
- **Recent access:** Check which apps request your current location information.

## Safety and emergency

Manage your medical information and emergency features.

- **Medical info:** Enter your medical information.
- **Emergency sharing:** Set the device to send information, such as your location or your device's lower battery notifications, to your emergency contacts for a certain period of time.
- **Emergency Location Service:** Turn on the Emergency Location Service (ELS) feature.
- **Earthquake alerts:** Turn on the earthquake alert feature.



Some features may not be available depending on the region or the model.

# Accounts and backup

## Options

Sync, back up, or restore your device's data using Samsung Cloud. You can also sign in to accounts, such as your Samsung account or Google Account, or transfer data to or from other devices through Smart Switch.

On the Settings screen, tap **Accounts and backup**.

- **Manage accounts:** Add your Samsung and Google accounts, or other accounts, to sync with.
  - **Users:** Set up additional user accounts for other users to use the device with personalized settings, such as email accounts, wallpaper preferences, and more. Refer to [Users](#) for more information.
  - **Samsung Cloud:** Back up your data and settings, and restore the previous device's data and settings even when you do not have it. Refer to [Samsung Cloud](#) for more information.
  - **Google Drive:** Keep your personal information, app data, and settings safe on your device. You can back up your sensitive information. You must sign in to your Google Account to back up data.
  - **Smart Switch:** Open Smart Switch and transfer data from your previous device. Refer to [Transferring data from your previous device \(Smart Switch\)](#) for more information.
-  Regularly back up your data to a safe location, such as Samsung Cloud or a computer, so that you can restore it if the data is damaged or lost because of an unintended factory data reset.

## Users

Set up additional user accounts for other users to use the device with personalized settings, such as email accounts, wallpaper preferences, and more.

Following types of user accounts are available:

- **Owner:** The owner account is created only when setting up the device for the first time, and cannot be created more than one. This account has full control of the device including user account management. You can add or delete user accounts only when using this account.
- **Guest:** A guest account can access the device, but information and data used during a guest session is temporarily stored. Each time you use this account, you are asked whether to continue the previous guest session or reset it.
- **New user:** A user account can access its own apps and content, and customize the device settings that affect all accounts.
- **New restricted account:** A restricted account can only access the apps and content allowed by the owner account, and cannot use the services that require logging in.

### Adding users

- 1 On the Settings screen, tap **Accounts and backup** → **Users**.
- 2 Tap **Add user or profile** and follow the on-screen instructions to set up a user account.

### Adding restricted profiles

- 1 On the Settings screen, tap **Accounts and backup** → **Users**.
- 2 Tap **Add user or profile** → **User (restricted profile)** and follow the on-screen instructions to set up a user account.

### Switching users

Tap the user account icon at the top of the locked screen and select an account to switch to.

## Managing users

When using the owner account, you can delete accounts or change account settings.

On the Settings screen, tap **Accounts and backup** → **Users**.

To delete a user account, tap the user account you want to delete and tap **Delete user**.

To change account settings, tap user account and change the settings.

## Samsung Cloud

Back up your device's data to Samsung Cloud and restore it later.

### Backing up data

You can back up your device's data to Samsung Cloud.

1 On the Settings screen, tap **Accounts and backup** and tap **Back up data** under **Samsung Cloud**.

2 Tap the switches next to the items you want to back up and tap **Back up now**.

3 Tap **Done**.



- Some data will not be backed up. To check which data will be backed up, on the Settings screen, tap **Accounts and backup** and tap **Back up data** under **Samsung Cloud**.
- To check the backup data for other devices in your Samsung Cloud, on the Settings screen, tap **Accounts and backup** → **Restore data**, and then select a device you want.

### Restoring data

You can restore your backup data from Samsung Cloud to your device.

1 On the Settings screen, tap **Accounts and backup**.

2 Tap **Restore data** and select a device you want.

3 Tick items you want to restore and tap **Restore**.

# Google

Configure settings for some features provided by Google.

On the Settings screen, tap **Google**.

## Advanced features

### Options

Turn on advanced features and change the settings that control them.

On the Settings screen, tap **Advanced features**.

- **Intelligent features:** Use AI features to help you use your device.
- **Bixby:** Bixby is a user interface that helps you use your device more conveniently. Refer to [Bixby](#) for more information.
- **Labs:** Use new features of the device.
- **S Pen:** Change the settings for using the S Pen. Refer to [S Pen](#) for more information.
- **Side button:** Select an app or feature to launch using the Side button. Refer to [Setting the Side button](#) for more information.
- **Active button:** Select an app to launch using the Active button. Refer to [Setting the Active button](#) for more information.
- **Multi window:** Set how to launch Multi window. You can also configure settings for Multi window. Refer to [Multi window](#) for more information.
- **Motions and gestures:** Turn on the motion feature and configure settings. Refer to [Motions and gestures](#) for more information.
- **Screenshots and screen recordings:** Change the settings for screenshots and screen recorder.
- **Daily Board:** Set the device to show a slideshow with selected features while charging. Refer to [Daily Board](#) for more information.
- **Accessories:** Change the accessory settings.
- **Galaxy Avatar:** Create avatars any way you want and have fun using them in various features. Refer to [Galaxy Avatar](#) for more information.
- **Dual Messenger:** Install the second app and use two separate accounts for the same messenger app. Refer to [Dual Messenger](#) for more information.



Some features may not be available depending on the carrier or model.

## Motions and gestures

Turn on the motion feature and configure settings.

On the Settings screen, tap **Advanced features** → **Motions and gestures**.

- **Double tap to turn on screen:** Set the device to turn on the screen by double tapping anywhere on the screen while the screen is turned off.
- **Double tap to turn off screen:** Set the device to turn off the screen by double tapping an empty area on the Home screen or the locked screen.
- **Cover screen to mute:** Set the device to mute certain sounds by using motions or gestures.
- **Palm swipe to capture:** Set the device to capture a screenshot when you swipe your hand to the left or right across the screen. You can check the captured images in **Gallery**. It is not possible to capture a screenshot while using some apps and features.



Excessive shaking or an impact to the device may cause an unintended input for some features using sensors.

## Galaxy Avatar

Create avatars any way you want and have fun using them in various features.

On the Settings screen, tap **Advanced features** → **Galaxy Avatar**. If you added the app icon to the Apps screen, open the **Galaxy Avatar** app.

### Creating a Galaxy Avatar

Launch Galaxy Avatar, tap the Create icon () , and then follow the on-screen instructions to create an avatar.

### Using Galaxy Avatar stickers

When you create avatars, stickers with avatar expressions and actions will be created automatically. You can use your avatar stickers when sending messages or on a social network.

Launch Galaxy Avatar and tap **Avatar Stickers**. To create your own stickers, tap the Make custom stickers icon () at the top of the stickers list.

## Using the Galaxy Avatar camera

Create fun pictures or videos with avatars using various shooting modes.

Launch Galaxy Avatar and tap **Avatar Camera**. Select the avatar and the mode you want to use, then take a picture or record a video.

## Dual Messenger

Install the second app and use two separate accounts for the same messenger app.

1 On the Settings screen, tap **Advanced features** → **Dual Messenger**.

Supported apps will appear.

2 Tap the switch of an app to install the second app.

The second app will be installed. The second app's icon will be displayed with the Second app icon (📱).

- 📌 • The Dual Messenger feature may not be available depending on the app.
- Some features of the app may be limited for the second app.

## Uninstalling a second app

1 On the Settings screen, tap **Advanced features** → **Dual Messenger**.

2 Tap the switch of the app you want to uninstall and tap **Uninstall**.

All data related to the second app will be deleted.

- 📌 If you uninstall the first app, the second app will also be deleted.

## Digital Wellbeing and parental controls

Check the history of your device usage and use features to prevent your device from interfering with your life. You can also set up parental controls for your children and manage their digital use.

On the Settings screen, tap **Digital Wellbeing and parental controls**.

- **Most used app categories:** Check out the list of the most used app categories for a day.
- **Screen time goal:** Set goals for how much you use your device a day.
- **App timers:** Limit the daily usage time for each app by setting a timer. When you reach the limit, the app will be turned off and you cannot use it.
- **Driving monitor:** Turn on the driving monitor to monitor the amount of the time you use your device while driving.
- **Walking monitor:** Turn on the walking monitor to monitor the amount of the time you use your device while walking.
- **Volume monitor:** Turn on the volume monitor to protect your hearing.
- **Content restrictions:** Limit websites or set a maximum rating for apps and games. This feature is only available in the **Samsung Internet** app and **Store** app.
- **Parental controls:** Manage your children's digital use.

## Device care

The device care feature provides an overview of the status of your device's battery, storage, memory, and system security. You can also optimize the device.

On the Settings screen, tap **Device care**.

- **Optimize now:** Close apps running in the background or using an abnormal amount of battery and scan for crashed apps and malware to optimize your device.
- **Battery:** Check the remaining battery power and time to use the device. For devices with low battery levels, conserve battery power by turning on power saving features. Refer to [Battery](#) for more information.

- **Storage:** Check the status of used and available storage and free up storage by deleting unnecessary files, such as the files in the trash, unused files, or duplicated files after checking them.
  -  • The actual available capacity of the internal storage is less than the specified capacity because the operating system and default apps occupy part of the storage. The available capacity may change when you update the device.
  - You can check the available capacity of the internal storage in the Specification section for your device on the Samsung website.
- **Memory:** Check memory usage or tap **Clean now** to free up memory by stopping background apps.
- **App protection:** Scan your device for malware and other suspicious activity to stay safe.
- **Auto optimization:** Perform auto optimization by closing background apps or cleaning up memory, to keep the device running in its best condition.

Tap **Auto restart** to set the device to restart automatically when performance issues are detected or at a time you set.
- **Software update:** Update your device's software through the firmware over-the-air (FOTA) service. You can also schedule software updates.
- **Diagnostics:** Test your device using Samsung Members.
- **Maintenance mode:** Turn on maintenance mode to protect your privacy while someone else is using your device, such as when you send it for repairs.

## Apps

Manage the device's apps and change their settings. You can check the apps' usage information, change their notification or permission settings, or uninstall or disable unnecessary apps.

On the Settings screen, tap **Apps**.

# General management

Customize your device's system settings or reset the device.

On the Settings screen, tap **General management**.

- **Language:** Select device languages. Refer to [Adding device languages](#) for more information.
- **App languages:** Select the language you want to use for each app.
- **Voice input:** Download language packs to use the voice input feature offline.
- **Date and time:** Access and alter the settings to control how the device displays the time and date.
  -  If the battery remains fully discharged or removed from the device, the time and date is reset.
- **Samsung Keyboard settings:** Change the settings for the Samsung Keyboard.
- **Keyboard list and default:** Select a keyboard to use by default and change the keyboard settings.
- **Physical keyboard:** Change the settings for an external keyboard.
- **Mouse and trackpad:** Change the settings for an external mouse or trackpad.
- **Reset:** Reset your device's settings or perform a factory data reset.
- **Contact us:** Ask questions or check the frequently asked questions.

## Adding device languages

You can add languages to use on your device.

- 1 On the Settings screen, tap **General management** → **Language** → **Add language**.
- 2 Select a language to add.
- 3 To set the selected language as the default language, tap **Set as default**. To keep the current language setting, tap **Keep current**.

The selected language will be added to your languages list. If you changed the default language, the selected language will be added to the top of the list.

To change the default language from your languages list, select the language you want and tap **Apply**. If an app does not support the default language, the next supported language in the list will be used.

## Accessibility

Configure various settings to improve accessibility to the device.

On the Settings screen, tap **Accessibility**.

- **Recommended for you:** Check the accessibility features you are currently using and check other recommended features.
- **Vision enhancements:** Customize the settings to improve accessibility for visually impaired users.
- **TalkBack:** Turn on TalkBack, which provides voice feedback. To check help information to learn how to use this feature, tap **Settings** → **TalkBack tutorial**.
- **Hearing enhancements:** Customize the settings to improve accessibility for users with hearing impairment.
- **Interaction and dexterity:** Customize the settings to improve accessibility for users who have reduced dexterity.
- **Advanced settings:** Configure settings for Direct access and notification features.
- **Installed apps:** Check out accessibility services installed on the device.
- **About Accessibility:** Check the Accessibility information.
- **Contact us:** Ask questions or check frequently asked questions.

## Software update

Update your device's software through the firmware over-the-air (FOTA) service. You can also schedule software updates.

On the Settings screen, tap **Software update**.

- **Download and install:** Check for and install updates manually.
- **Auto download / Auto download over Wi-Fi:** Select when to automatically download software updates.
- **Last update:** Check out information about the last software update.

 If emergency software updates are released for your device's security and to block new types of security threats, they will be installed automatically without your agreement.

## Security updates information

Security updates are provided to strengthen the security of your device and protect your personal information. For security updates for your model, visit [security.samsungmobile.com](https://security.samsungmobile.com).

 The website supports only some languages.

## Remote management

If you have any questions or technical problems with your device, you can get help through the remote support service.

On the Settings screen, tap **Remote management**.

## About tablet

Access your device's information.

On the Settings screen, tap **About tablet**.

To change your device's name, tap **Rename**.

- **Status information:** Check out various device information, such as the Wi-Fi MAC address and serial number.
- **Legal information:** Access legal information related to the device, such as safety information and the open source license.
- **Software information:** Access the device's software information, such as its operating system version and firmware version.
- **Battery information:** Check out battery information.

# Usage notices

## Precautions for using the device

Please read this guide when using the device to ensure safe and proper use.

- Descriptions are based on the device's default settings.
- Some content may differ from your device depending on the region, service provider, model specifications, or device's software.
- The device may require a connection to a Wi-Fi or mobile network when using some apps or features.
- Content (high quality content) that requires high CPU and memory usage will affect the overall performance of the device. Apps related to the content may not work properly depending on the device's specifications and the environment that it is used in.
- Samsung is not liable for performance issues caused by apps supplied by providers other than Samsung.
- Samsung is not liable for performance issues or incompatibilities caused by edited registry settings or modified operating system software. Attempting to customize the operating system may cause the device or apps to work improperly.
- Software, sound sources, wallpapers, images, and other media provided with this device are licensed for limited use. Extracting and using these materials for commercial or other purposes is an infringement of copyright laws. Users are entirely responsible for illegal use of media.
- You may incur additional charges for data services, such as messaging, uploading and downloading, auto-syncing, or using location services depending on your data plan. For large data transfers, it is recommended to use the Wi-Fi feature.
- Default apps that come with the device are subject to updates and may no longer be supported without prior notice.
- Modifying the device's operating system or installing software from unofficial sources may result in device malfunctions and data damage or loss. These actions are violations of your Samsung license agreement and will void your warranty.



- You can see the screen clearly even in strong outdoor sunlight by automatically adjusting the contrast range based on the surrounding environment. Because of the nature of the product, displaying fixed graphics for extended periods may result in afterimages (screen burn-in) or ghosting.
  - It is recommended not to use fixed graphics on part or all of the screen for extended periods and turn off the screen when not using the device.
  - You can set the screen to turn off automatically when you are not using it. Open **Settings**, tap **Display** → **Screen timeout**, and then select the length of time you want the device to wait before turning off the screen.
  - To set the screen to automatically adjust its brightness based on the surrounding environment, open **Settings**, tap **Display**, and then tap the **Adaptive brightness** switch to turn it on.

- Depending on the region or model, some devices are required to receive approval from the Federal Communications Commission (FCC).

If your device is approved by the FCC, you can check out the FCC ID of the device. To access the FCC ID, open **Settings** and tap **About tablet** → **Status information**. If your device does not have an FCC ID, it means that the device has not been authorized for sale in the U.S. or its territories and may only be brought to the U.S. for the owner's personal use.

- The bandwidths supported by the device may vary depending on the region or carrier.
- 5G network availability may vary depending on the model, country, network provider, and user environment.
- **WARNING! Your device contains magnets. Keep it away from credit cards, implanted medical devices, and other devices that may be affected by magnets. In the case of medical devices, keep your device more than 15 cm apart. Stop using your device if you suspect any interference with your medical device and consult your physician or your medical device manufacturer.**

## Instructional icons

-  **Warning:** situations that could cause injury to yourself or others
-  **Caution:** situations that could cause damage to your device or other equipment
-  **Notice:** notes, usage tips, or additional information

## Notes on package contents and accessories

Refer to the quick start guide for package contents.

- The items supplied with the device and any available accessories may vary depending on the region or carrier.
- The supplied items are designed only for this device and may not be compatible with other devices.
- Appearances and specifications are subject to change without prior notice.
- You can purchase additional accessories from your local Samsung retailer. Make sure they are compatible with the device before purchase.
- Use only compatible charging devices and accessories. Damage caused by use of accessories which are not compatible may not be covered by warranty.
- Availability of all accessories is subject to change depending entirely on manufacturing companies. For more information about available accessories, refer to the Samsung website.
- The included USB cable supports up to 2A charging.

## Maintaining water and dust resistance

Your device is water- and dust-resistant and meets the following international standards.

- IP68 water resistance rating certification: According to the requirements of the IEC 60529 standard, it was tested in 15-35 °C, 86-106 kPa, 1.5 m fresh water for 30 minutes without moving.

You must follow the guidelines to maintain the water- and dust-resistance of your device.

- Do not expose the device to swimming pool water or sea water.
- If the device is exposed to unclean water or other liquids, such as soapy water, oil, perfume, sunscreen, hand cleaner, chemical products such as cosmetics, or liquids that include the alcohol, clean the device with fresh water that does not flow, wipe it with a soft and clean cloth, and then dry it thoroughly before use to maintain the water resistance.
- Do not expose the device to water moving with force. A sudden rise in the water pressure may exceed the guaranteed level of water resistance.
- In places, such as a sauna or steam room, the water-resistant performance may be damaged because of sudden changes in the temperature.
- If the device is subjected to an external shock or is damaged, its water resistance may decrease.
- Do not open the device's covers when the device is in water or in very humid places, such as swimming pools or bathrooms.
- Do not open the back cover using wet hands or when the device is wet.
- The rubber seal fitted to the back cover is an important component of the device. Take care when opening and closing the back cover to avoid damaging the rubber seal. Also, ensure that the rubber seal is free from debris, such as sand or dust to prevent damage to the device.
- The back cover may be loosened if the device is dropped or receives an impact. Ensure that all the covers are properly aligned and tightly closed.

If the device is exposed to water or pollutants, follow the guidelines:

- Wipe the device with a soft and clean cloth, and then dry it thoroughly.
- If the microphone or speaker is not completely dry, it may result in the sound not being clear during a call.
- The screen and other features may not work properly if the device is used in water.
- Do not connect the charger or any accessories until the device is completely dry. The device can be damaged if an accessory or charger is connected when the multipurpose jack is not yet dry.

The water and dust resistance of your Samsung Galaxy device is not permanent and may diminish over time because of normal wear and tear.

## Device overheating situations and solutions

### When the device heats up while charging the battery

While charging, the device and the charger may become hot. During wireless charging or fast charging, the device may feel hotter to the touch. This does not affect the device's lifespan or performance and is in the device's normal range of operation. If the battery becomes too hot, the charging speed may decrease or the charger may stop charging.

#### **Do the following when the device heats up:**

- Disconnect the charger from the device and close any running apps. Wait for the device to cool down and then begin charging the device again.
- If the lower part of the device overheats, it could be because the connected USB cable is damaged. Replace the damaged USB cable with a new compatible one.
- When using a wireless charger, do not place foreign materials, such as metal objects, magnets, and magnetic stripe cards, between the device and the wireless charger.

 The wireless charging or fast charging feature is only available on supported models.

## When the device heats up during use

When you use features or apps that require more power or use them for extended periods, your device may temporarily heat up because of increased battery consumption. Close any running apps and do not use the device for a while.

Refer to the following examples of situations in which the device may overheat.

- During the initial setup after purchase or when restoring data
- When downloading large files
- When using apps that require more power or using apps for extended periods
  - When playing high-quality games for extended periods
  - When recording videos for extended periods
  - When streaming videos while using the maximum brightness setting
  - When connecting to a TV
- While multitasking (or, when running many apps in the background)
  - When using Multi window
  - When updating or installing apps while recording videos
  - When downloading large files during a video call
  - When recording videos while using a navigation app
- When using large amount of data for syncing with the cloud, email, or other accounts
- When using a navigation app in a car while the device is placed in direct sunlight
- When using the Mobile Hotspot and Tethering feature
- When using the device in areas with weak signals or no reception
- When charging the battery with a damaged USB cable
- When the device's multipurpose jack is damaged or exposed to foreign materials, such as liquid, dust, metal powder, and pencil lead
- When you are roaming

### **Do the following when the device heats up:**

- Keep the device updated with the latest software.
- Conflicts between running apps may cause the device to heat up. Restart the device.
- Turn off the Wi-Fi, GPS, and Bluetooth features when not using them.
- Close apps that increase battery consumption or that run in the background when not in use.
- Delete unnecessary files or unused apps.
- Decrease the screen brightness.
- If the device overheats or feels hot for a prolonged period, do not use it for a while. If the device continues to overheat, contact a Samsung Service Center or an authorized service center.

## **Precautions for device overheating**

If you begin to feel uncomfortable because of the device overheating, stop using the device.

When the device heats up, the features and performance may be limited or the device may turn off to cool down. The feature is only available on supported models.

- If the device overheats, the screen brightness, the screen refresh rate, and the performance speed will be limited to lower the device's temperature. Even if the battery charging indicator icon appears, charging may be slow. When charging stops because of a rise in the device's temperature, the battery indicator icon will blink.
- If the device reaches a certain temperature, a warning message will appear to prevent device failure, skin irritation and damage, and battery leakage. Running apps will be closed and all calling and other features will be limited, except for emergency calls, until the device cools down.

- If the second message appears because of a further increase of the device's temperature, the device will turn off. Do not use the device until the device's temperature is within the recommended operating temperature range. If the second warning message appears during an emergency call, the call will not be disconnected by a forced termination.

 **Recommended operating temperature range**

The device's recommended operating temperature is between 0 °C to 35 °C. Using the device outside of the recommended temperature range may damage the device or reduce the battery's lifespan.

## Precautions for operating environment

Your device may heat up because of the environment in the following conditions. Use caution to avoid shortening the battery's lifespan, damaging the device, or causing a fire.

- Do not store your device in very cold or very hot temperatures.
- Do not expose your device to direct sunlight for extended periods.
- Do not use or store your device for extended periods in very hot areas, such as inside a car in the summertime.
- Do not place the device in any areas that may overheat, such as on an electric heating mat.
- Do not store your device near or in heaters, microwaves, hot cooking equipment, or high pressure containers.
- Do not use a cable whose covering is peeled off or damaged, and do not use any charger or battery that is damaged or malfunctioning.

# Appendix

## Troubleshooting

Before contacting a Samsung Service Center or an authorized service center, please attempt the following solutions. Some situations may not apply to your device.

You can also use Samsung Members to solve any problems you might encounter while using your device.

### **When you turn on your device or while you are using the device, it prompts you to enter one of the following codes:**

- **Password:** When the device lock feature is turned on, you must enter the password you set for the device.
- **PIN:** When using the device for the first time or when the PIN requirement is turned on, you must enter the PIN supplied with the SIM card. You can turn off this feature by using the Lock SIM card menu.
- **PUK:** Your SIM card is blocked, usually as a result of entering your PIN incorrectly several times. You must enter the PUK supplied by your carrier.
- **PIN2:** When you access a menu requiring the PIN2, you must enter the PIN2 supplied with the SIM card. For more information, contact your carrier.

### **Your device displays network or service error messages**

- When you are in areas with weak signals or poor reception, you may lose reception. Move to another area and try again. While moving, error messages may appear repeatedly.
- You cannot access some options without a subscription. For more information, contact your carrier.

## Your device does not turn on

When the battery is completely discharged, your device will not turn on. Fully charge the battery before turning on the device.

- The battery may not be inserted properly. Insert the battery again.
- Wipe both gold-colored contacts and insert the battery again.

## Touch recognition works slowly or improperly

- Touch recognition may not work properly in the following situations:
  - If you attach a screen protector or optional accessories to the screen
  - If you are wearing gloves, if your hands are not clean while touching the screen, or if you tap the screen with a sharp object or your fingertips
  - In humid conditions or when exposed to water
- Restart your device to clear any temporary software problems.
- Ensure that your device software is updated to the latest version.
- If the screen is scratched or damaged, visit a Samsung Service Center or an authorized service center.

## Your device freezes or encounters a fatal problem

Try the following solutions. If the problem is still not resolved, contact a Samsung Service Center or an authorized service center.

### Restarting the device

If your device freezes or hangs, you may need to close apps or turn off the device and turn it on again.

### Forcing restart

If your device is frozen and unresponsive, press and hold the Side button and the Volume Down button simultaneously for more than 7 seconds to restart it.

## Resetting the device

If these methods do not solve your problem, perform a factory data reset.

Open **Settings** and tap **General management** → **Reset** → **Factory data reset** → **Reset** → **Delete all**. Before performing the factory data reset, remember to make backup copies of all important data stored in the device.

## Calls are not connected

- Ensure that you have accessed the right cellular network.
- Ensure that you have not set call barring for the phone number you are dialing.
- Ensure that you have not set call barring for the incoming phone number.

## Others cannot hear you speaking on a call

- Ensure that you are not covering the built-in microphone.
- Ensure that the microphone is close to your mouth.
- If you are using headphones, ensure that they are properly connected.

## Sound echoes during a call

Adjust the volume by pressing the Volume button or move to another area.

## A cellular network or the internet is often disconnected or audio quality is poor

- Ensure that you are not blocking the device's internal antenna.
- When you are in areas with weak signals or poor reception, you may lose reception. You may have connectivity problems because of issues with the carrier's base station. Move to another area and try again.
- When using the device while moving, wireless network services may be disabled because of issues with the carrier's network.

## The battery does not charge properly

- Ensure that the charger is connected properly.
- If the battery terminals are dirty, the battery may not charge properly or the device may turn off. Wipe both gold-colored contacts and try charging the battery again. If charging does not work properly, visit a Samsung Service Center or an authorized service center. Bring the charger and USB cable you are using for better service support.

## The battery depletes faster than when first purchased

- When you expose the device or the battery to very cold or very hot temperatures, the useful charge may be reduced.
- Battery consumption will increase when you use certain features or apps, such as GPS, games, or the internet.
- The battery is consumable and the useful charge will get shorter over time.

## Error messages appear when opening the camera

Your device must have sufficient available storage and battery power to operate the camera app. If you receive error messages when opening the camera, try the following:

- Charge the battery.
- Free some storage by transferring files to a computer or deleting files from your device.
- Restart the device.

If you are still having trouble with the camera app after trying these tips, contact a Samsung Service Center or an authorized service center.

## Picture quality is poorer than the preview

- The quality of your pictures may vary, depending on the surroundings and the photography techniques you use.
- If you take pictures in dark areas, at night, or indoors, image noise may occur or images may be out of focus.

## Error messages appear when opening multimedia files

If you receive error messages or multimedia files do not play when you open them on your device, try the following:

- Free some storage by transferring files to a computer or deleting files from your device.
- Ensure that the music file is not Digital Rights Management (DRM)-protected. If the file is DRM-protected, ensure that you have the appropriate license or key to play the file.
- Ensure that the file formats are supported by the device. If a file format is not supported, such as DivX or AC3, install an app that supports it. To check the file formats that your device supports, visit the Samsung website.
- Your device supports pictures and videos captured with the device. Pictures and videos captured by other devices may not work properly.
- Your device supports multimedia files that are authorized by your carrier or providers of additional services. Some content circulated on the internet, such as ringtones, videos, or wallpapers, may not work properly.

## Bluetooth is not working well

If another Bluetooth device is not located or there are connection problems or performance malfunctions, try the following:

- Ensure that the device you wish to connect with is ready to be scanned or connected to.
- Ensure that your tablet and the other Bluetooth device are within the maximum Bluetooth range (10 m).
- On your tablet, open **Settings**, tap **Connections**, and then tap the **Bluetooth** switch to turn it on again.
- On your tablet, open **Settings**, tap **General management** → **Reset** → **Reset Wi-Fi and Bluetooth settings** → **Reset settings** to reset network settings. You may lose registered information when performing the reset.

If these tips do not solve the problem, contact a Samsung Service Center or an authorized service center.

## **A connection is not made when you connect the device to a computer**

- Ensure that the USB cable you are using is compatible with your device.
- Ensure that you have the proper driver installed and updated on your computer.

## **Your device cannot find your current location**

GPS signals may be obstructed in some locations, such as indoors. Set the device to use Wi-Fi or a mobile network to find your current location in these situations.

## **Data stored in the device has been lost**

Always make backup copies of all important data stored in the device. Otherwise, you cannot restore data if it is damaged or lost. Samsung is not responsible for the loss of data stored in the device.

## **A small gap appears around the outside of the device case**

- This gap is a necessary manufacturing feature and some minor rocking or vibration of parts may occur.
- Over time, friction between parts may cause this gap to expand slightly.

## **There is not enough space in the device's storage**

Delete unnecessary data, such as cache, using the device care feature or manually delete unused apps or files to free up storage space.

## Copyright

Copyright © 2025 Samsung Electronics Co., Ltd.

This guide is protected under international copyright laws.

No part of this guide may be reproduced, distributed, translated, or transmitted in any form or by any means, electronic or mechanical, including photocopying, recording, or storing in any information storage and retrieval system.

## Trademarks

- Samsung and the Samsung logo are registered trademarks of Samsung Electronics Co., Ltd.
- Bluetooth® is a registered trademark of Bluetooth SIG, Inc. worldwide.
- Wi-Fi®, Wi-Fi Direct™, Wi-Fi CERTIFIED™, and the Wi-Fi logo are registered trademarks of the Wi-Fi Alliance.
- Manufactured under license from Dolby Laboratories. Dolby, Dolby Atmos, and the double-D symbol are trademarks of Dolby Laboratories.
- All other trademarks and copyrights are the property of their respective owners.