

47" CLASS (46.9" DIAGONAL)

M4712C-BA

42" CLASS (42.0" DIAGONAL)

M4212C-BA

## LCD Widescreen HD Capable Monitor



NATIVE DISPLAY RESOLUTION  
1366 x 768 (WXGA)

NARROW BEZEL  
29mm (M4212C-BA), 36mm (M4712C-BA)

CONVENIENT EXTERNAL SPEAKER-OUT

NEW! INFORMATION DISPLAY FOR SERIAL NUMBER

VIEWING ANGLE and LIFE EXPECTANCY  
Enhanced in Portrait Mode (M4212C-BA)

SPLIT ZOOM (self video wall)  
New! Up to 5 x 5 matrix - adjusts for bezel width

HIGH BRIGHTNESS  
500 cd/m<sup>2</sup>

CONTRAST RATIO  
3000:1 (DCR)

HDMI™/DVI WITH HDCP

SUPER IPS  
178° Viewing Angle

OSD and REMOTE CONTROL LOCK

RS-232C CONTROL

NEW! OPTIONAL HIDDEN SPEAKERS

3-YEAR LIMITED WARRANTY  
parts/labor

NOTE: IP-Cast™ ready via interface box using LG's IP card solution for Digital Signage applications. Contact DSinfo@LGcommercial.com for more information.

# XD ENGINE

SHARPER  
BRIGHTER  
CLEARER

**ULTRA CONTRAST**  
AT A BLAZINGLY FAST 370 MILLION PIXELS PER SECOND, THE PROCESSOR USES A HISTOGRAM ANALYZATION TOOL TO CLARIFY THE IMAGE DATA ACCORDING TO SIGNAL BRIGHTNESS LEVELS.

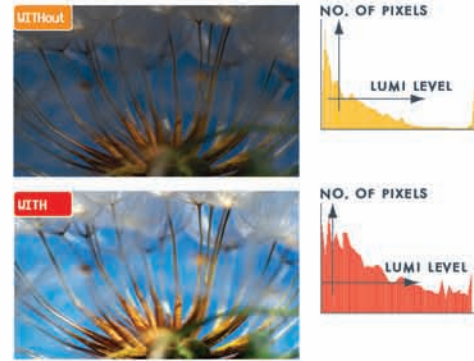

Dramatization

**DYNAMIC BLACK STRETCH**  
THE MINIMUM BLACK LEVEL OF AN IMAGE IS AUTOMATICALLY DETECTED AND ADJUSTED ACCORDING TO BRIGHTNESS.

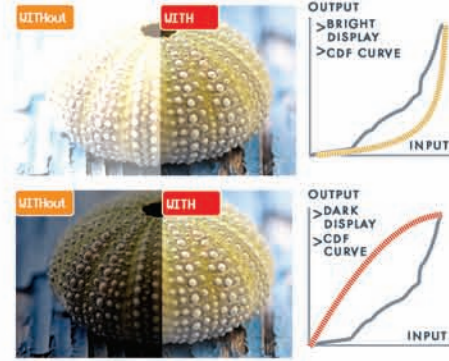

Dramatization

**CLEAR SCREEN**  
USING THE NOISE FILTER INSIDE THE XD ENGINE<sup>®</sup> CHIP, THE IMAGE IS ANALYZED FOR TEMPORAL AND SPATIAL INFORMATION TO REDUCE MPEG NOISE.

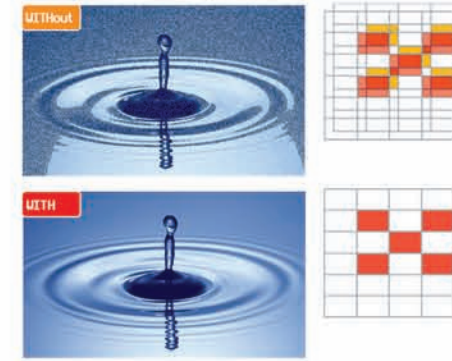

Dramatization

**ADVANCED VIVID COLOR**  
COLORS THAT ARE SENSITIVE TO THE HUMAN EYE ARE OPTIMIZED TO THE NEAREST TRUE COLOR BY THE SELECTIVE COLOR CONTROL.

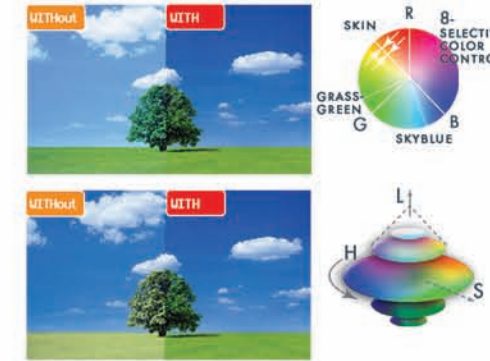

Dramatization

**INTELLIGENT EDGE CONTROL**  
EDGE LINES ARE EMPHASIZED BY IMPROVING THE TRANSITION FROM THE BACKGROUND TO THE MAIN OBJECT.

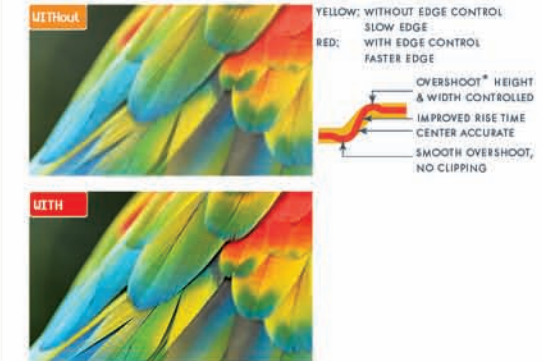

Dramatization

# FEATURES

## SPLIT ZOOM SELF VIDEO WALL

Display to multiple screens by linking displays using a 15-pin D-Sub signal cable



M4712C-BA 3 x 3 Matrix (5 x 5 Max)



M4212C-BA 5 x 5 Matrix  
VIEWING ANGLE and LIFE EXPECTANCY  
Enhanced in Portrait Mode



Stand ST4210K (optional)  
(fits M4212C-BA)

**HIDDEN SPEAKERS**  
SP0000K (optional)  
Dimensions (WxHxD)  
1.61"x12.92"x2.17"  
Weight 1.65 lbs. each  
10 Watts



## HIDDEN SPEAKERS

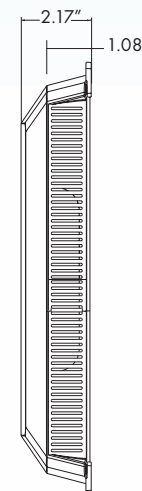
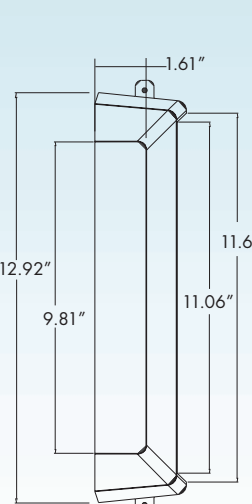

# DIMENSIONS

## M4712C-BA

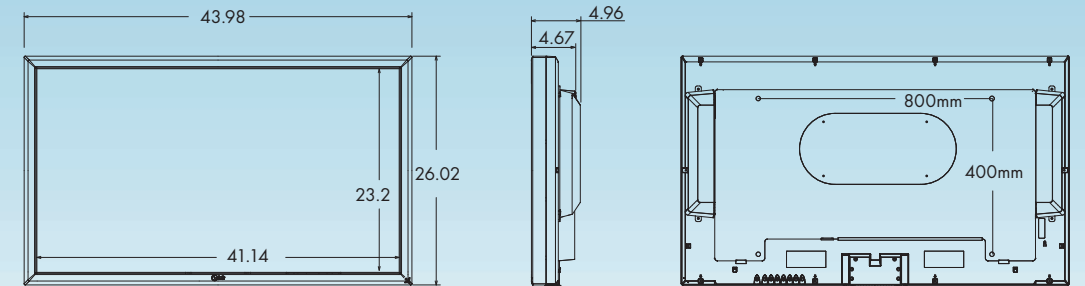

## M4212C-BA

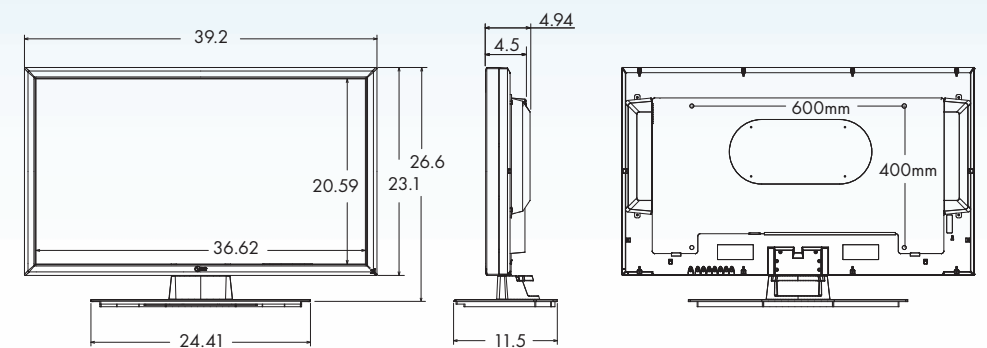

## REAR JACK PANEL

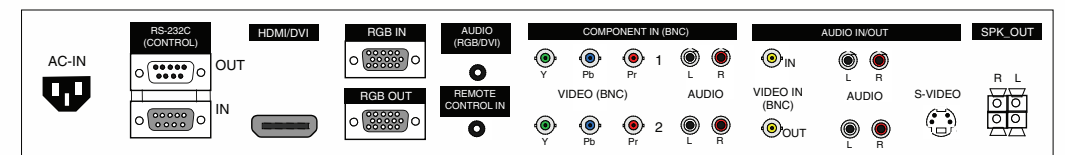

## SPECIFICATIONS

**PANEL**

LCD Panel Type	47" (M4712C-BA) 42" (M4212C-BA)
Display Area	46.9" diagonal (M4712C-BA) 42.0" diagonal (M4212C-BA)
Aspect Ratio	16 : 9
Native Resolution	1366 x 768 (WXGA)
Pixels (H x V x 3)	3,147,264
Brightness	500cd/m2
Contrast Ratio	3,000:1 (DCR)
Viewing Angle (H x V)	178 x 178
Color Depth	16.7 Million
Response Time	8 ms (G to G) (47") 9 ms (G to G) (42")
Surface Treatment	Hard Coating (3H) Anti-glare
MTBF	50,000 Hr. (Minimum) Landscape (47") 50,000 Hr. (Minimum) Portrait & Landscape (42")

**VIDEO**

Max Input Resolution	1600 x 1200 @ 60Hz (Analog) 1920 x 1080 @ 60Hz (Digital)
Recommended Resolution	1360 x 768 @ 60Hz (Analog/Digital)
H-Scanning Frequency	30 ~ 83kHz (Analog/Digital)
V-Scanning Frequency	56 ~ 75 Hz (Analog), 60 Hz (Digital)
Pixel Frequency	162 MHz (D-Sub) 148.5 MHz (HDMI/DVI)
Sync Compatibility	Separate / Composite
Video Input	RGB Analog / Digital
Picture mode	Vivid/Standard/Cinema/Sports/Game/ User1/User2
Color temperature	Warm/Medium/Cool/User

**REAR INPUTS**

Component Video	2 Hi-Res (BNC)
PC Input via 15-Pin Sub "D"	1 / 1
Composite Video Input/Output	1 (BNC) / 1 (BNC)
Audio Output	1
Audio Inputs	3 Plus PC Sound
HDTV Formats	Component : 720p/1080i HDMI : 720p/1080i/1080p
PC Formats	Auto Scaling to XGA
HDMI/DVI with HDCP	Yes
RS-232C Input/Output	1 / 1
S-Video	1 (S-Video has a priority but there is no input mode)
Audio Jack Built-in (No Amp)	Yes
Discrete IR Input	Yes
External_Speaker Out	Yes

**AUDIO**

Auto Volume	Yes
Balance	Yes
Audio Power	20W (10W x 2)
Speaker On/off	Yes
Sound mode	Clear Voice/Standard/Music/Cinema/ Sports/Game/User

**POWER**

Power Supply	100-240V~, 50/60Hz
Power Type	Built-in Power
Power Switch Type	Tact Switch
Power Saving	
Normal	300 W (47"), 220 W (42")
Stand-by/Suspend	1W (RGB)/4W (HDMI/DVI)
DPM Off	1W (RGB)/4W (HDMI/DVI)
Switch Off	1W

**SPECIAL FEATURES**

New Temperature Sensor	Yes
New Split Zoom	Yes, supports natural mode
(Self Video Wall, Max 5 x 5)	
Source Selection	Digital (HDMI/DVI)/Analog (RGB)/ Component 1/Component 2/AV
Brightness/Contrast	Yes
Color	Warm/Medium/Cool User Control (R/G/B)
Position	H / V
Tracking	Auto/Clock/Phase
Set-up	Language(English/French/Spanish/ Italian/German/Portugues/ Korean/Japanese/Chinese/Russian)
ISM Method	Normal/White wash/Orbiter/ Inversion/Dot wash
Advanced	Gamma/Film mode/Black level/ Noise Reduction
Time	Clock/On/off timer/Auto sleep/ Power on Delay
Information display	Serial Number, SET ID, S/W Version
Mute	Yes
Sleep Timer	Yes
Auto Power/Source Memory	Yes
Key Lock	Yes
DPM Select	Yes

**CABINET**

Monitor Dimensions (W×H×D)	43.98" x 26.02" x 4.67" (47") 39.2" x 23.1" x 4.5" (42")
Monitor Weight (W×H×D)	63.5lbs (47") 46.7lbs (42")
Packaging (W×H×D)	46.7" x 29.8" x 12.4" (47") 44.1" x 26" x 11.2" (42")
Weight with Packaging	75.2 lbs (47") 55.6 lbs (42")
Color	Black
VESA™ Standard Mount Interface	800mm x 400mm (47") 600mm x 400mm (42")

**STANDARD (CERTIFICATION)**

Safety	UL/c-UL/CB scheme/TUV/NEMKO
EMC	FCC Class "B"/VCCI/C-tick/GOST/ CE/ MIC

**UPC**

7 19192 18480 0	M4712C-BA
7 19192 18476 3	M4212C-BA

**SERVICE/LIMITED WARRANTY**

Limited Warranty (Parts/Labor)	3 Years
--------------------------------	---------

**OPTIONAL ACCESSORIES**

SPO000K (speakers)	fits both M4712C-BA and M4212C-BA
Dimensions (W x H x D) (each)	1.61" x 12.92" x 2.17"
Weight (each)	0.815 lbs.
Packaging Dimensions (W x H x D)	15.12" x 5.28" x 6.85"
Packed Weight	2.36 lbs (2 Speakers/1 Package)
ST4210K (stand)	fits M4212C-BA
Dimensions (W x H x D)	24.41" x 6.2" x 11.5"
Weight	7.9 lbs.
Packaging Dimensions (W x H x D)	31.2" x 9.64" x 14.57"
Packed Weight	11.68 lbs.

Note: There is no optional stand for the M4712C-BA model.

www.LGcommercial.com

LG Electronics U.S.A., Inc.  
Commercial Products Division  
2000 Millbrook Drive,  
Lincolnshire, IL 60069

Customer Service: 888.865.3026

Contact your LG Regional Sales Representative:  
B2B: 800.897.8788  
Channel Markets: 800.897.8871  
IT: 800.321.5501  
Hospitality: 800.228.1236

M47\_4212C-BA LG050803\_PR



All screen images are simulated. Dimensions and weights are approximate. Design, features and specifications subject to change without notice.

© Copyright 2008 LG Electronics USA, Inc. All Rights Reserved. "LG Life's Good" is a registered trademark of LG Corp. XD Engine is a registered trademark of LG Electronics USA, Inc.

VESA is a trademark of Video Electronics Standards Association. All other product and brand names are trademarks or registered trademarks of their respective companies.

Printed in the USA. June 2008

