

FX-890II / FX-2190II



413456600

| | |
|----|---------------------|
| EN | Start Here |
| DE | Hier starten |
| FR | Démarrez ici |
| IT | Inizia qui |
| ES | Para empezar |
| CA | Comenceu aquí |
| PT | Começar por aqui |
| NL | Hier beginnen |
| DA | Start her |
| FI | Aloita tästä |
| NO | Start her |
| SV | Starta här |
| CS | Začínáme |
| HU | Itt kezdje |
| PL | Rozpocznij tutaj |
| SK | Prvé kroky |
| BG | Започнете от тук |
| RO | Începeți aici |
| ET | Alusta siit |
| LV | Sāciet šeit |
| LT | Pradėkite čia |
| EL | Ξεκινήστε εδώ |
| TR | Buradan Başlayın |
| SL | Začnite tukaj |
| HR | Počnite ovdje |
| MK | Почнете от тука |
| SR | Počnite ovde |
| RU | Установка |
| KK | Осы жерден бастаңыз |
| AR | ابدأ من هنا |
| FA | از اینجا شروع کنید |
| MS | Mula Di Sini |
| VI | Bắt đầu tại đây |
| ID | Mulai Di Sini |

For detailed information and safety recommendations, refer to the User's Guide (included in the CD-ROM).

Ausführliche Informationen und Sicherheitsempfehlungen finden Sie im Benutzerhandbuch, das auf der CD-ROM enthalten ist.

Pour plus d'informations et des recommandations concernant la sécurité, reportez-vous au Guide d'utilisation (compris dans le CD-ROM).

Per informazioni dettagliate e suggerimenti sulla sicurezza consultare la Guida per l'utente (inclusa nel CD-ROM).

Para obtener información detallada y recomendaciones sobre seguridad consulte la Guía de usuario (incluida en el CD-ROM).

Per obtenir informació detallada i instruccions de seguretat, consulte la Guia de l'usuari (inclosa al CD-ROM).

Para mais informações e recomendações sobre segurança, consulte o Manual do Utilizador (incluído no CD-ROM).

Raadpleeg de gebruikershandleiding (meegeleverd op de cd-rom) voor meer informatie en veiligheidsvoorschriften.

Der findes yderligere oplysninger og anbefalinger om sikkerhed i brugervejledningen (medfølger på cd-rom'en).

Lisätietoja ja turvaohjeita on Käyttöoppaassa (mukana CD-ROM).

Hvis du vil ha mer detaljert informasjon og sikkerhetsanbefalinger, kan du se i brukerhåndboken (som du finner på CD-en).

Detaljerad information och säkerhetsföreskrifter finns i Användarhandboken (medföljer på CD-ROM-skivan).

Podrobné informácie a bezpečnostní doporučení najdete v Uživatelské příručce (na disku CD-ROM).

Részletes információk és a biztonsággal kapcsolatos tudnivalók a CD-ROM-on lévő használati útmutatóban találhatók.

Szczegółowe informacje oraz zalecenia dotyczące bezpieczeństwa zawiera Podręcznik użytkownika (zapisany na dysku CD-ROM).

Podrobné informácie a bezpečnostné odporúčanie nájdete v Uživatelskej príručke (dodaná na disku CD-ROM).

Подробна информация и препоръки за безопасност ще намерите в Ръководството за потребителя (включено в CD-ROM-a).

Pentru informații detaliate și recomandări cu privire la siguranță, consultați User's Guide (Ghidul utilizatorului) (inclus pe CD-ROM).

Üksikasjalikumat teavet ja ohutusaseid soovitusi vt kasutusjuhendist (leidub seadmega kaasnenud CD-ROM-il).

Sikāku informāciju un ieteikumus par drošību skat. Lietotāja rokasgrāmātā (iekļauta CD-ROM).

Detaliesnės informacijos ir saugos patarimų ieškokite vartotojo vadove (pateiktame kompaktiniame diske).

Για περισσότερες πληροφορίες και συστάσεις για την ασφάλεια, ανατρέξτε στον Οδηγό χρήσης (συμπεριλαμβάνεται στο CD-ROM).

Ayrıntılı bilgi ve güvenlik önerileri için Kullanım Kılavuzuna (CD-ROM'da bulunan) başvurun.

Podrobne informacije in varnostna priporočila najdete v Navodilih za uporabo (na CD-ROM-u).

Detaljne informacije i preporuke o sigurnosti pogledajte u Korisničkom priručniku (nalazi se na CD-ROM-u).

За подетални информации и препораки за безбедноста видете во "Корисничкиот прирачник" (вклучен во ЦД-РОМ).

Za detaljne informacije i mere bezbednosti pogledajte Korisničko uputstvo (koje možete da nađete na CD ROM-u).

Дополнительная информация и рекомендации по безопасности приведены в Руководстве пользователя (см. на компакт-диске в комплекте поставки)

Толыгырақ ақпаратты және қауіпсіздік туралы кеңестерді Пайдаланушы нұсқаулығынан қараңыз (CD-ROM дискісінде қамтылған).

للحصول على مزيد من المعلومات التفصيلية وتوصيات السلامة، قم بالرجوع إلى دليل المستخدم (المتضمن في اسطوانة CD-ROM).

برای جزئیات بیشتر و توصیه های ایمنی به راهنمای کاربر (موجود درون سی دی) رجوع کنید.

Untuk mendapatkan Maklumat terperinci dan cadangan keselamatan, rujuk Panduan Pengguna (Disertakan di dalam CD-ROM).

Để biết Thông tin chi tiết và khuyến nghị về an toàn, tham khảo Hướng dẫn sử dụng (Được bao gồm trong CD-ROM).

Untuk informasi dan saran keamanan selengkapnya, baca Panduan Pengguna (Sudah disertakan dalam CD-ROM).

Standards and Approvals

Für Verbraucher aus Deutschland

Maschinenlärminformations-Verordnung 3. GPSGV: Der höchste Schalldruckpegel beträgt 70 dB(A) oder weniger gemäß EN ISO 7779.

Das Gerät ist nicht für die Benutzung im unmittelbaren Gesichtsfeld am Bildschirmarbeitsplatz vorgesehen. Um störende Reflexionen am Bildschirmarbeitsplatz zu vermeiden, darf dieses Produkt nicht im unmittelbaren Gesichtsfeld platziert werden.

Türkiye'deki kullanıcılar için

AEEE Yönetmeliğine Uygundur.

Ürünün Sanayi ve Ticaret Bakanlığınca tespit ve ilan edilen kullanma ömrü 5 yıldır.

Tüketicilerin şikayet ve itirazları konusundaki başvuruları tüketici mahkemelerine ve tüketici hakem heyetlerine yapılabilir.

Üretici: SEIKO EPSON CORPORATION

Adres: 3-5, Owa 3-chome, Suwa-shi, Nagano-ken 392-8502 Japan

Tel: 81-266-52-3131

Web: <http://www.epson.com/>

Для пользователей из России

Срок службы: 5 года

Для українських користувачів

Обладнання відповідає вимогам Технічного регламенту обмеження використання деяких небезпечних речовин в електричному та електронному обладнанні.

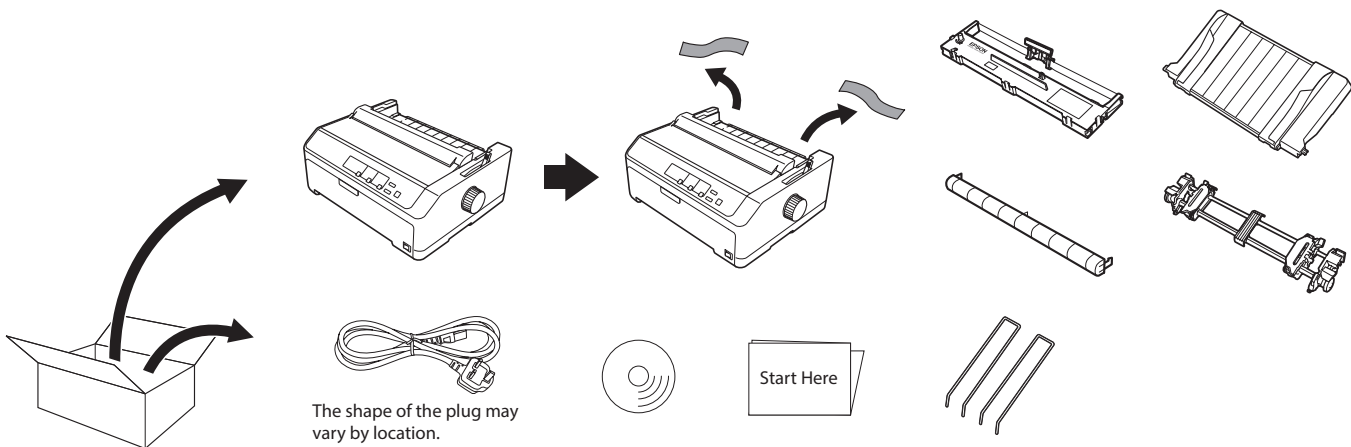
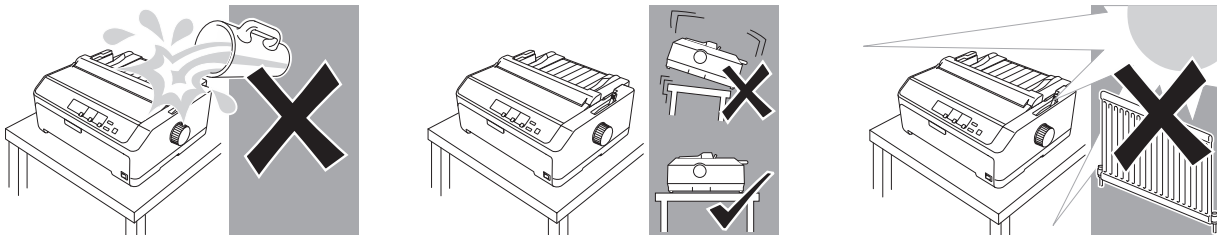

No part of this publication may be reproduced, stored in a retrieval system, or transmitted in any form or by any means, electronic, mechanical, photocopying, recording, or otherwise, without the prior written permission of Seiko Epson Corporation. The information contained herein is designed only for use with this Epson printer. Epson is not responsible for any use of this information as applied to other printers.

Neither Seiko Epson Corporation nor its affiliates shall be liable to the purchaser of this product or third parties for damages, losses, costs, or expenses incurred by the purchaser or third parties as a result of: accident, misuse, or abuse of this product or unauthorized modifications, repairs, or alterations to this product, or (excluding the U.S.) failure to strictly comply with Seiko Epson Corporation's operating and maintenance instructions. Seiko Epson Corporation shall not be liable for any damages or problems arising from the use of any options or any consumable products other than those designated as Original Epson Products or Epson Approved Products by Seiko Epson Corporation.

General Notice: Other product names used herein are for identification purposes only and may be trademarks of their respective owners.

Epson disclaims any and all rights in those marks.

The contents of this manual are subject to change without notice.

1

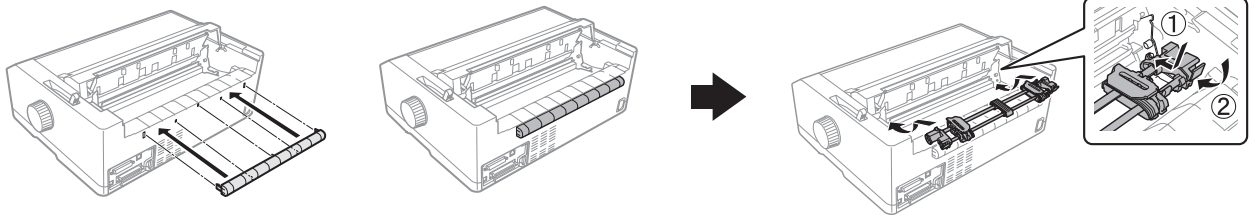

Installing the wing on the printer

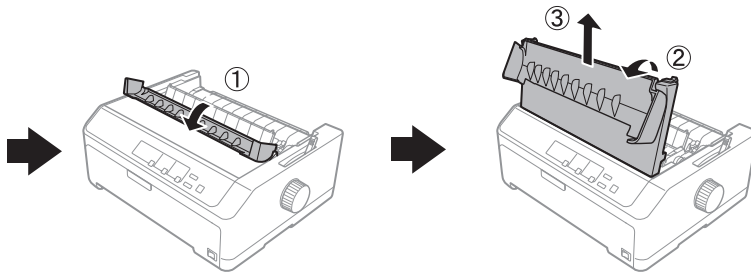

Remove the printer cover

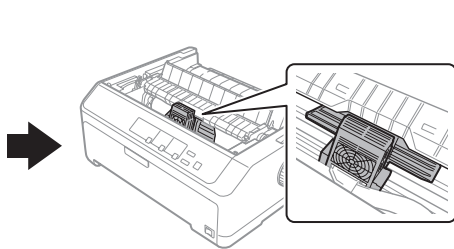

Slide the print head so that it does not hit the paper tension unit

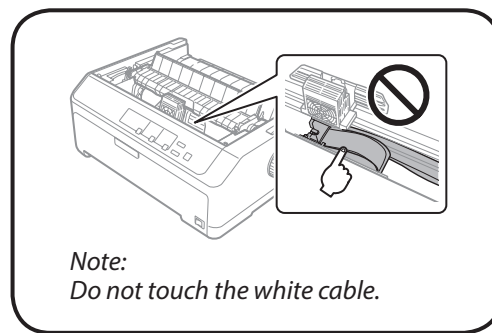

Note:
Do not touch the white cable.

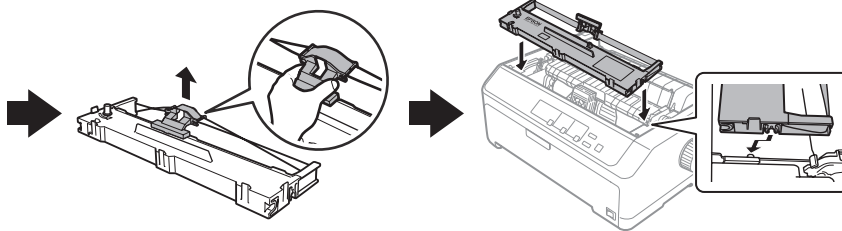

Pull the ribbon guide until it is out of the cartridge

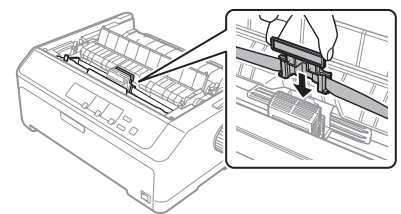

Slide the ribbon guide into the print head until it clicks in place

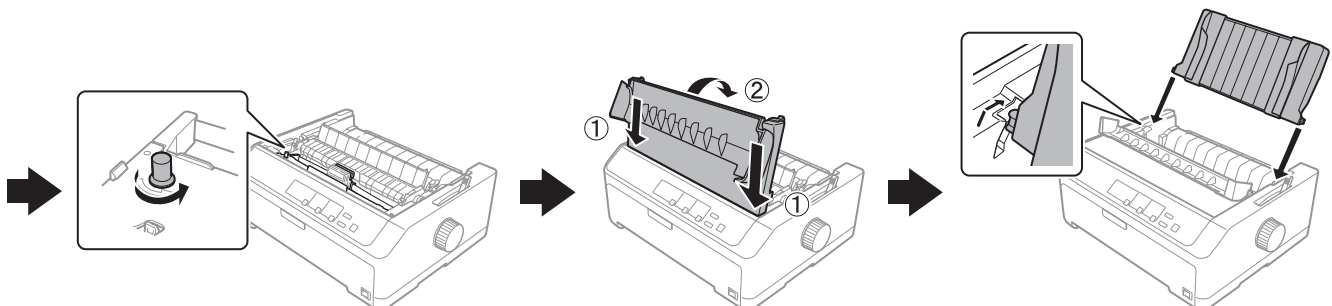

2

USB

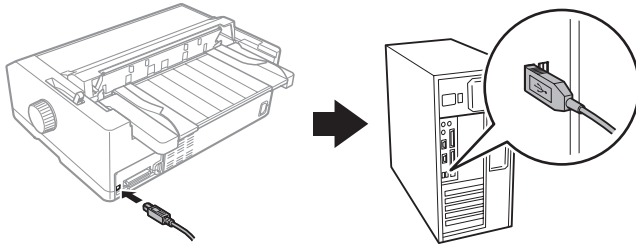

Parallel

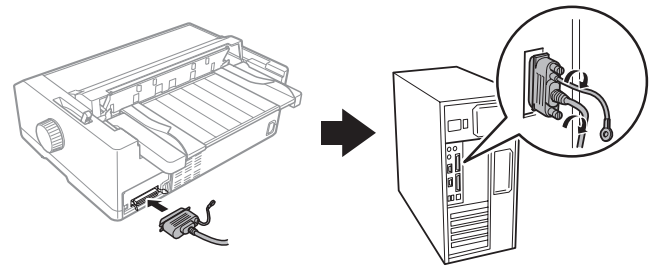

3

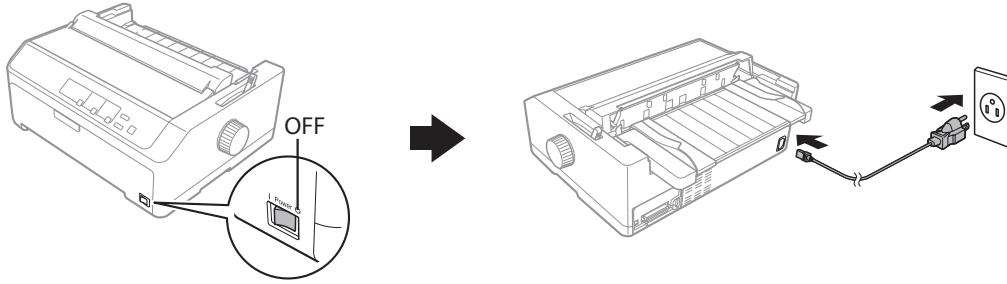

4

From Web site

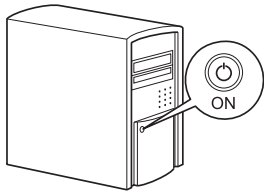

Download and install the Epson software if necessary.

From CD-ROM

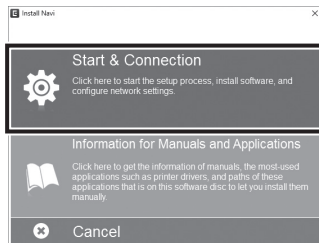
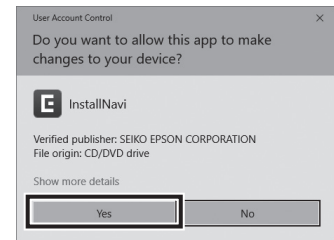
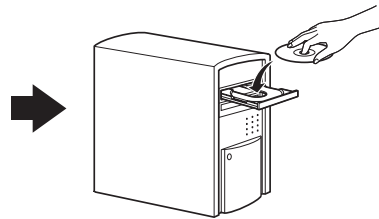
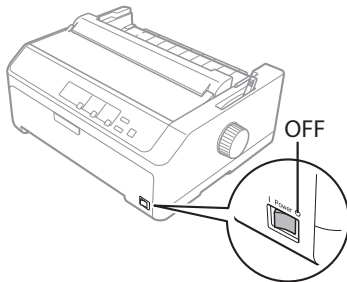

Follow the instructions

