

Kensington®

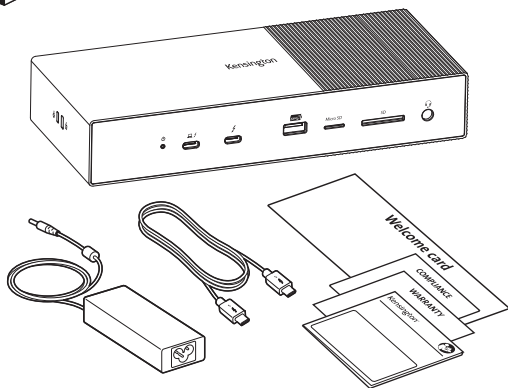

SD5000T5 EQ Thunderbolt™ 5 Triple 4K Docking Station



US



EU



UK



AU/CN



JP



IN



kensington.com/register

1

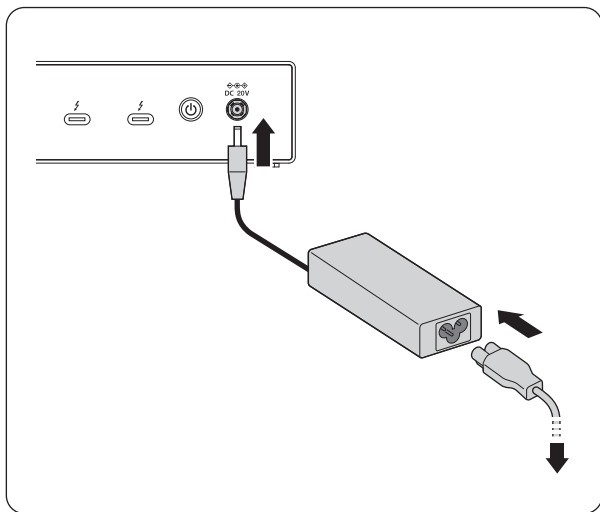

US

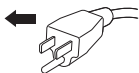

AU

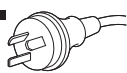

EU

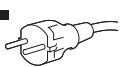

JP



UK



IN



2

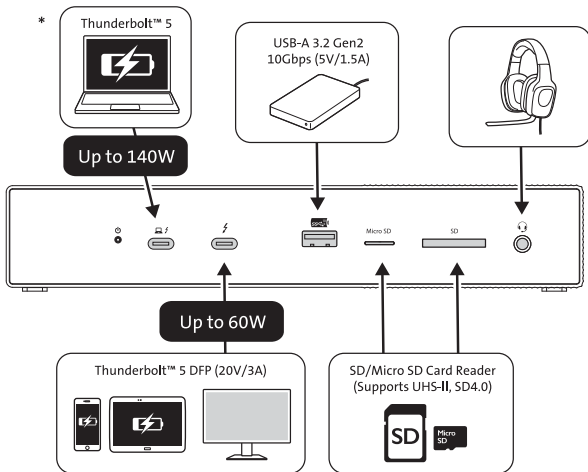
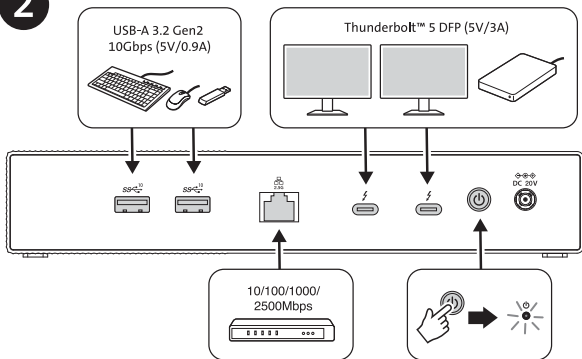

- ★ The connected devices powered by this docking station shall have a fire enclosure complying with IEC 60950-1 or IEC 62368-1. Please contact your device's manufacturer to confirm the above compliance.
 - ★ Les appareils connectés alimentés par cette station d'accueil doivent avoir une enceinte coupe-feu conforme à la norme CEI 60950-1 ou CEI 62368-1. Veuillez contacter le fabricant de votre appareil pour valider la conformité aux normes indiquées ci-dessus.
 - ★ Die über diese Dockingstation verbundenen Geräte verfügen über ein Brandschutz-Gehäuse, das mit IEC 60950-1 oder IEC 62368-1 übereinstimmt. Wenden Sie sich bitte an den Gerätehersteller, um die Einhaltung der oben genannten Anforderungen zu bestätigen.
 - ★ I dispositivi collegati e alimentati tramite questa docking station devono essere dotati di un involucro a prova di incendio che soddisfi i requisiti dello standard IEC 60950-1 o IEC 62368-1. Contattare il produttore del dispositivo per confermare la conformità di cui sopra.
 - ★ Os produtos conectados ligados a esta estação de ancoragem devem dispor de uma proteção contra incêndio em conformidade com a IEC 60950-1 ou IEC 62368-1. Contacte o fabricante do seu dispositivo para confirmar a conformidade indicada acima.
 - ★ Los dispositivos conectados alimentados con esta estación de carga deben contar con una carcasa contra incendios conforme con las normas IEC 60950-1 y IEC 62368-1. Póngase en contacto con el fabricante de su dispositivo para confirmar el cumplimiento de lo anterior.
 - ★ 由该扩展坞供电的连接设备应具备符合 IEC 60950-1 或 IEC 62368-1 标准的防火外壳。请联系您的设备制造商以确认上述合规性。
 - ★ このドッキングステーションで駆動される接続デバイスには、IEC 60950-1またはIEC 62368-1に準拠する防火筐体に収納されています。上記準拠について確認するには、デバイスのメーカーにお尋ねください。
- ★ يجب أن تتضمن الأجهزة المتصلة التي تعمل باستخدام محطة الإرساء هذه غطاءً للحماية من الحرائق يتوافق مع المعيار IEC 60950-1 أو IEC 62368-1. يُرجى الاتصال بالشركة المصنّعة للجهاز لتأكيد التوافق الموضح أعلاه.

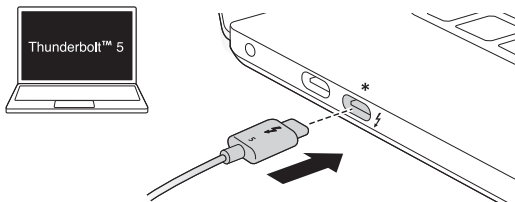
3**a**

*Laptop must support the USB-C® PD 3.1 EPR (Extended Power Range) standard for 140W charging.

*L'ordinateur portable doit prendre en charge la norme USB-C® 3.1 EPR (Extended Power Range) pour une charge de 140 W.

*Laptop muss den Standard USB-C® PD 3.1 EPR (Extended Power Range) für 140-W-Aufladung unterstützen.

*Il portatile deve supportare lo standard USB-C® PD 3.1 EPR (Extended Power Range) per la ricarica a 140 W.

*O laptop deve suportar o padrão USB-C® PD 3.1 EPR (Extended Power Range) para carregamento de 140W.

*El portátil debe soportar el estándar USB-C® PD 3.1 EPR (Extended Power Range) para la carga de 140W.





*笔记本电脑必须支持USB-C® PD 3.1 EPR（扩展功率范围）标准以进行140W充电。

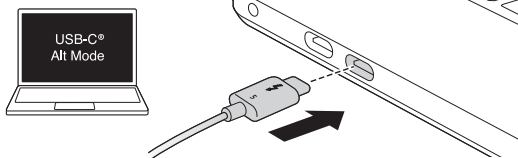
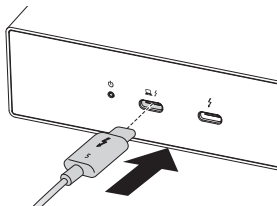



*ノートPCは140Wで充電するためにはUSB-C® PD3.1 EPR(Extended Power Range)企画に対応する必要があります。

* للشحن بقدرة 140 واط USB-C® PD 3.1 لتقنية (EPR) يجب أن يدعم الكمبيوتر المحمول معيار نطاق الطاقة الممتد *

b**4**

5

  High Resolution			
Thunderbolt™ 5 (Windows)	Up to 8K @ 60Hz	Up to 8K @ 60 Hz**	Up to 4K @ 144 Hz**
Thunderbolt™ 4***/USB 4** (Windows)	Up to 8K @ 60 Hz**	Up to 4K @ 60Hz**	X
USB-C® Alt Mode*** (Windows)	Up to 4K @ 60 Hz	X	X
MacBook M1/M2/M3 Pro and Max chipsets***	Up to 6K @ 60Hz	Up to 6K @ 60Hz**	X
MacBook M1/M2/M3 Base chipsets***	Up to 4K @ 60Hz (Single display for M1 & M2)	Up to 1 x 5K @ 60Hz** Up to 1 x 6K @ 60Hz** (M3 only when lid is closed)	X

 High Refresh Rate	Thunderbolt™ 5 (Windows)	Thunderbolt™ 4*** / USB 4***(Windows)
	Up to 1080p @ 540 Hz**	Up to 4K @ 120Hz** or 1440p @ 240Hz**
	Up to 4K @ 144 Hz**	Up to 1080p @ 120Hz**
	Up to 4K @ 144 Hz**	X

macOS - Apple has not yet announced their plans to support Thunderbolt™ 5 modern docks. For more information, contact your Apple support.

**Support for Display Stream Compression (DSC) is required. Thunderbolt™ 5 technology with Bandwidth Boost can push the transmit speed up to 120Gbps when needed for maximum resolution and the highest refresh rate. Achieving the maximum resolution depends on the capabilities of both the host device and the monitor.

*** The dock's capabilities are reduced when connected to a non-Thunderbolt™ 5 laptop, including Thunderbolt™ 4/USB4 (40Gbps), M1/M2/M3 MacBooks (40Gbps), or USB-C® Alt mode (10Gbps), each representing the maximum bandwidth.

6

Optimizing Your Laptop Experience

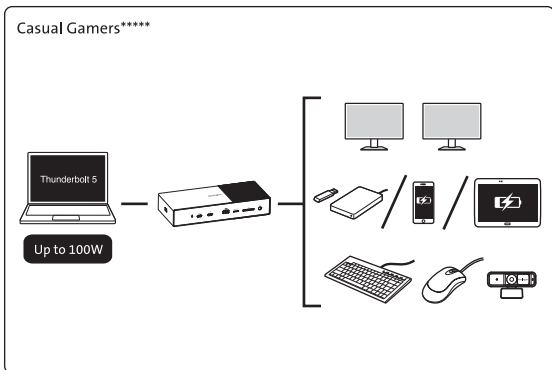
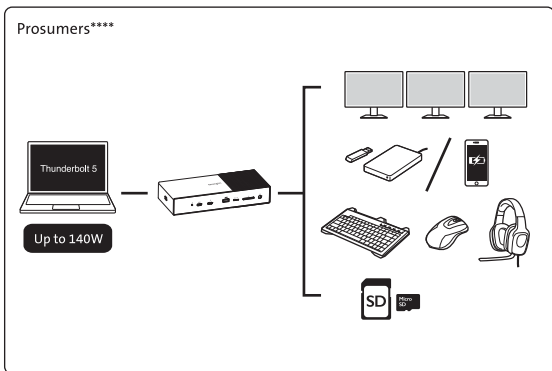

****Prosumers who play games should follow device usage guidelines to prevent laptop throttling and ensure stable power delivery of 140 watts. It is advisable to avoid connecting high-power devices (up to 60W) during gameplay.

*****Casual gamers can freely allocate power; their laptop allows power allocation during gameplay to charge other devices, such as a tablet or other device up to 60W.

EN macOS - Apple has not yet announced their plans to support Thunderbolt™ 5 modern docks. For more information, contact your Apple support.

**Support for Display Stream Compression (DSC) is required. Thunderbolt™ 5 technology with Bandwidth Boost can push the transmit speed up to 120Gbps when needed for maximum resolution and the highest refresh rate. Achieving the maximum resolution depends on the capabilities of both the host device and the monitor.

*** The dock's capabilities are reduced when connected to a non-Thunderbolt™ 5 laptop, including Thunderbolt™ 4/USB4 (40Gbps), M1/M2/M3 MacBooks (40Gbps), or USB-C® Alt mode (10Gbps), each representing the maximum bandwidth.

****Prosumers who play games should follow device usage guidelines to prevent laptop throttling and ensure stable power delivery of 140 watts. It is advisable to avoid connecting high-power devices (up to 60W) during gameplay.

*****Casual gamers can freely allocate power; their laptop allows power allocation during gameplay to charge other devices, such as a tablet or other device up to 60W.

DE macOS - Apple hat ihre Pläne zur Unterstützung moderner Thunderbolt™ 5-Docks noch nicht mitgeteilt. Weitere Informationen erhalten Sie von Ihrem Apple-Support.

**Unterstützung für Display Stream Compression (DSC) ist erforderlich. Thunderbolt™ 5-Technologie mit Bandbreitensteigerung kann die Übertragungsgeschwindigkeit für maximale Auflösung und höchste Bildwiederholfrequenz bei Bedarf auf bis zu 120 Gb/s erhöhen. Die Erreichung der maximalen Auflösung hängt von den Fähigkeiten von Hostcomputer und Monitor ab.

*** Die Fähigkeiten des Docks werden bei Anschluss an einen Nicht-Thunderbolt™ 5-Laptop reduziert, einschließlich Thunderbolt™ 4/USB4 (40 Gb/s), M1/M2/M3 MacBooks (40 Gb/s) oder USB-C® Alt Mode (10 Gb/s), was jeweils die maximale Bandbreite repräsentiert.

****Prosumenten, die spielen, sollten die Nutzungsrichtlinien des Gerätes befolgen, damit ihr Laptop nicht gedrosselt und eine stabile Stromversorgung von 140 Watt gewährleistet wird. Sie sollten während des Spielens keine leistungshungrigen Geräte (bis 60 W) anschließen.

*****Gelegenheitsgamer können Leistung frei zuweisen; ihr Laptop ermöglicht die Leistungszuweisung während des Spielens, um andere Geräte, wie einen Tablet oder ein anderes Gerät mit bis zu 60 W, aufzuladen.

FR macOS - Apple n'a pas encore annoncé son intention de prendre en charge les stations d'accueil modernes Thunderbolt™ 5. Pour en savoir plus, contactez votre assistance Apple.

**Il doit prendre en charge de la compression de flux d'affichage (DSC). La technologie Thunderbolt™ 5 avec Augmentation de la bande passante peut pousser la vitesse de transmission jusqu'à 120 Gbit/s lorsque nécessaire pour une résolution maximale et le taux de rafraîchissement le plus élevé. L'obtention de la résolution maximale dépend des capacités à la fois de l'appareil hôte et du moniteur.

*** Les capacités de la station d'accueil sont réduites lorsque celle-ci est connectée à un ordinateur portable non Thunderbolt™ 5, y compris Thunderbolt™ 4/USB4 (40 Gbit/s), les MacBook M1/M2/M3 (40 Gbit/s) ou USB-C® Alt Mode (10 Gbit/s), chacun représentant la bande passante maximale.

****Les prosummateurs qui jouent à des jeux doivent suivre les directives d'utilisation de l'appareil pour éviter l'étranglement de l'ordinateur portable et assurer une alimentation stable de 140 watts. Il est conseillé d'éviter de connecter des appareils à forte puissance (jusqu'à 60 W) en cours de jeu.

*****Les joueurs occasionnels peuvent librement allouer de l'énergie. Leur ordinateur portable permet d'allouer de l'énergie en cours de jeu pour charger d'autres appareils, comme une tablette ou un autre appareil jusqu'à 60 W.

IT macOS - Apple non ha ancora annunciato l'intenzione di supportare i dock moderni Thunderbolt™ 5. Per maggiori informazioni, contattare l'assistenza Apple.

***È necessario il supporto della tecnologia Display Stream Compression (DSC). La tecnologia Thunderbolt™ 5 con Bandwidth Boost può portare la velocità di trasmissione a 120 Gbps quando necessario per ottenere la massima risoluzione e la più alta frequenza di aggiornamento. Il raggiungimento della massima risoluzione dipende dalle capacità del dispositivo host e del monitor.

*** Le capacità del dock si riducono quando viene collegato a un computer portatile privo della tecnologia Thunderbolt™ 5, tra cui Thunderbolt™ 4/USB4 (40 Gbps), MacBook M1/M2/M3 (40 Gbps) o USB-C® in modalità Alt (10 Gbps), ciascuna delle quali rappresenta la massima larghezza di banda.

****I prosumer che praticano il gaming devono attenersi alle linee guida sull'utilizzo del dispositivo per evitare il throttling del portatile e garantire un'erogazione di potenza stabile di 140 watt. È consigliabile evitare di collegare dispositivi ad alta potenza (fino a 60 W) durante il gioco.

*****I gamer occasionali possono utilizzare liberamente l'energia; il portatile consente di ripartire l'energia durante il gioco per ricaricare altri dispositivi, ad esempio un tablet o un altro dispositivo fino a 60 W.

ES macOS: Apple no ha anunciado aún sus planes de compatibilidad con las bases modernas Thunderbolt™ 5. Para obtener más información, póngase en contacto con el soporte técnico de Apple.

**Se requiere compatibilidad con Display Stream Compression (DSC). La tecnología Thunderbolt™ 5 con Bandwidth Boost puede impulsar la velocidad de transmisión hasta 120 Gbps cuando sea necesario para obtener la máxima resolución y la mayor frecuencia de actualización. Conseguir la máxima resolución depende de la capacidad tanto del dispositivo anfitrión como del monitor.

*** Las capacidades de la base se reducen cuando se conecta a un portátil que no sea Thunderbolt™ 5, incluidos Thunderbolt™ 4/USB4 (40 Gbps), MacBooks M1/M2/M3 (40 Gbps) o USB-C® modo Alt (10 Gbps), cada uno representa el máximo ancho de banda.

****Los prosumidores que juegan deben seguir las directrices de uso del dispositivo para evitar la ralentización del portátil y garantizar un suministro estable de energía de 140 vatios. Se recomienda evitar conectar dispositivos de alta potencia (hasta 60 W) durante el juego.

*****Los jugadores ocasionales pueden asignar energía libremente; su portátil permite asignar energía durante el juego para cargar otros dispositivos, como una tablet u otro dispositivo de hasta 60 W.

PT macOS - Apple ainda não anunciou planos para um suporte futuro das estações modernas Thunderbolt™ 5. Para informações, contacte o suporte da Apple.

**É necessário suporte para a Compressão do fluxo de ecrã (DSC). A tecnologia Thunderbolt™ 5 com Boost de banda larga pode aumentar a velocidade de transmissão até 120 Gbps quando necessário para obter a máxima resolução e a mais elevada taxa de atualização. A obtenção da resolução máxima depende das capacidades do dispositivo anfitrião e do monitor.

*** As capacidades da estação de ancoragem são reduzidas quando ligada a um portátil não Thunderbolt™ 5, incluindo Thunderbolt™ 4/USB4 (40 Gbps), MacBooks M1/M2/M3 (40 Gbps) ou modo USB-C® Alt (10 Gbps), cada um representando a largura de banda máxima.

****Os Prosumers que jogam devem seguir as diretrizes de utilização do dispositivo para evitar a limitação do computador portátil e garantir um fornecimento de energia estável de 140 watts. É aconselhável evitar ligar dispositivos de alta potência (até 60 W) durante o jogo.

*****Os jogadores casuais podem atribuir energia livremente; o seu computador portátil permite a atribuição de energia durante o jogo para carregar outros dispositivos, como um tablet ou outro dispositivo de até 60 W.

CN macOS - Apple尚未宣布其支持Thunderbolt™ 5现代扩展坞的计划。欲了解更多信息，请联系Apple。

**需要支持显示流压缩（DSC）。Thunderbolt™ 5技术的带宽增强功能在需要时可以将传输速度提高到120Gbps，以实现最大分辨率和最高刷新率。实现最大分辨率取决于主机设备和显示器的能力。

***当连接到非Thunderbolt™ 5笔记本电脑，包括Thunderbolt™ 4/USB4（40Gbps）、M1/M2/M3 MacBooks（40Gbps）或USB-C® Alt模式（10Gbps）时，扩展坞的功能会受到限制，以上数据代表了这些非Thunderbolt™ 5笔记本电脑最大的带宽。

****玩游戏的专业用户应遵循设备使用指南，以防止笔记本电脑降速并确保稳定的140瓦电源供应。建议在游戏期间避免连接高功率设备（最高60W）。

*****闲游戏玩家可以自由分配电力；他们的笔记本电脑允许在游戏过程中分配电力，以对其他设备进行充电，例如平板电脑或其他高达60瓦的设备。

JP macOS-AppleはThunderbolt™5ドッキングステーション今後対応する予定を発表していません。詳細については、Appleサポートにお問い合わせください。

**ディスプレイストリーム圧縮(DSC)に対応している必要があります。

Thunderbolt™5テクノロジーのBandwidth Boost機能で最大解像度と最大のリフレッシュレートで使用する場合は、転送速度は最大120Gbpsです。最大解像度を使用するにはホストデバイスとモニターの仕様によります。

***Thunderbolt™5ではないノートPC（Thunderbolt™4/USB4[40Gbps]、M1/M2/M3 MacBook[40Gbps]またはUSB-C®Altモード[10Gbps]を含む）で接続した場合、ドックの機能が制限されます。ドックの機能はそれぞれの最大帯域幅によります。

****ゲームで使用する場合は、ノートPCのスロットリングを防ぎ、140Wの安定した電力供給を確保するために、デバイスの取扱説明書に従う必要があります。ゲームでの使用中に高出力デバイス（最大60W）を接続することは推奨致しません。

*****ライトにゲームで使用する場合は、自由に電力を割り当てることができます。ノートPCをゲームをプレイしながら他のデバイス（タブレットや他のデバイスを最大60W）に充電するための電力割当を行うことができます。

macOS - لم تعلن شركة Apple بعد عن خططها لدعم محطات الإرساء الحديثة المزودة بتقنية Thunderbolt™ 5. للحصول على مزيد من المعلومات، اتصل بفريق دعم شركة Apple.

**يلزم دعم تقنية ضغط تدفق العرض (DSC). يمكن لتقنية Thunderbolt™ 5 المزودة بميزة تعزيز عرض النطاق الترددي زيادة سرعة النقل إلى ما يصل إلى 120 جيجابايت في الثانية عند الحاجة للحصول على أعلى دقة وأعلى معدل تحديث. يعتمد الوصول إلى أعلى دقة على إمكانيات كل من الجهاز المضيف والشاشة.

***تقل إمكانيات محطة الإرساء عند الاتصال بكمبيوتر محمول غير مزود بتقنية Thunderbolt™ 5، بما في ذلك Thunderbolt™ 4/USB4 (40 جيجابايت في الثانية) أو أجهزة MacBook المزودة بشرائح M1/M2/M3 (40 جيجابايت في الثانية) أو الوضع البديل من USB-C® (10 جيجابايت في الثانية)، بحيث يمثل كل منها الحد الأقصى لعرض النطاق الترددي.

****يجب على المستهلكين المحترفين الذين يلعبون الألعاب اتباع إرشادات استخدام الجهاز لمنع تقليل سرعة الكمبيوتر المحمول وضمان توصيل الطاقة بشكل مستقر بقدرة 140 واط. يُنصح بتجنب توصيل الأجهزة عالية الطاقة (ما يصل إلى 60 واط) في أثناء اللعب.

*****يمكن للاعبين العاديين توزيع الطاقة كما يشاؤون؛ حيث يسمح الكمبيوتر المحمول الخاص بهم بتوزيع الطاقة في أثناء اللعب لشحن الأجهزة الأخرى، مثل الجهاز اللوحي أو جهاز آخر تصل قدرته إلى 60 واط.

7

Initial Thunderbolt 4/5 connection for Windows

New Thunderbolt™ device have been attached

Thunderbolt™ devices were attached. In order to approve them for use this application must be run with administrator privileges.
Click OK to run the Thunderbolt™ software with administrator privileges.

OK

Cancel

6.1 Manage Thunderbolt 4/5 devices and settings later



6.2

View Attached Devices

Approve Attached Devices ▸

Manage Approved Device

Settings

Exit



Sold separately

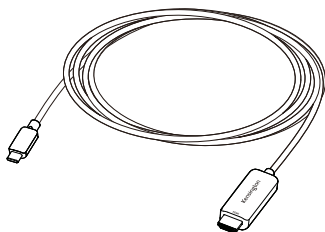
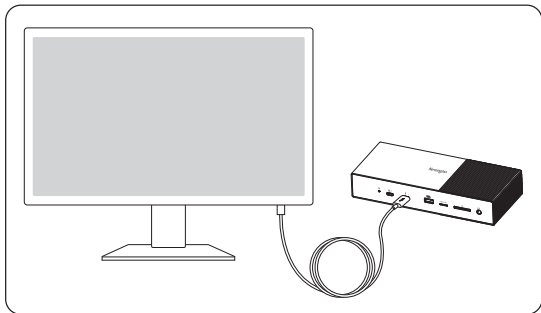

Recommended:
K38343WW USB-C® to HDMI® Unidirectional 8K Cable (M/M)
for Monitor Display.

Sold separately

1

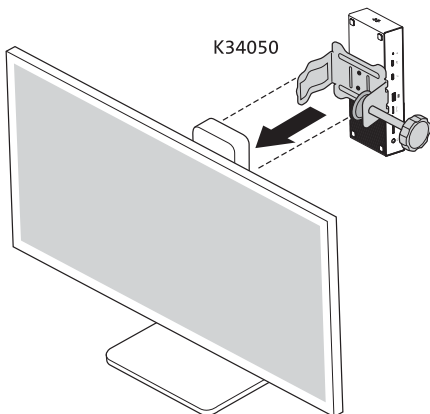

2

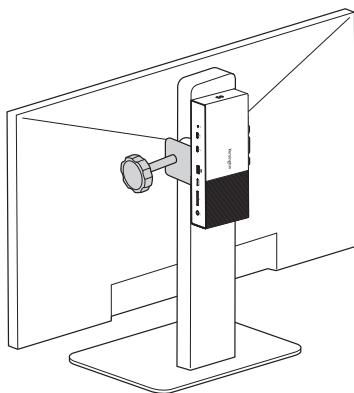

Sold separately

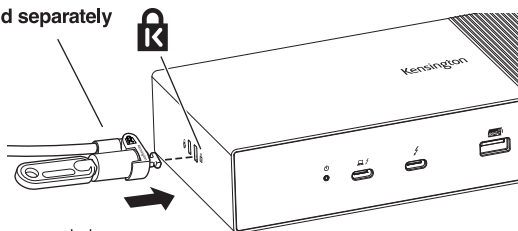

Recommended
K65020WW MicroSaver® 2.0 Keyed Laptop Lock

Sold separately

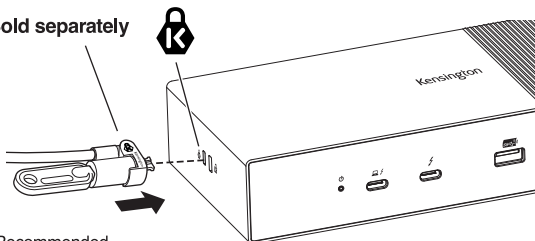

Recommended
K65021WW Slim NanoSaver® 2.0 Keyed Laptop Lock

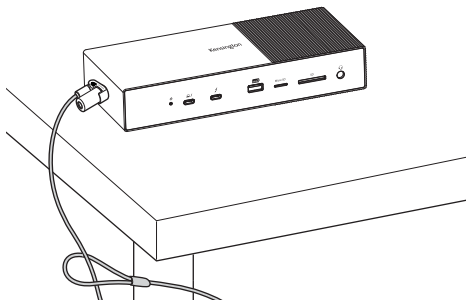



www.kensington.com/support

Kensington® is a registered trademark of ACCO Brands. Windows is a registered trademark of Microsoft Corporation in the U.S. and/or other countries. macOS is a trademark of Apple Inc. registered in the U.S. and other countries. Thunderbolt and the Thunderbolt logo are trademarks of Intel Corporation in the U.S. and/or other countries. USB-C® and USB4 are trademarks of USB Implementers Forum. All other registered and unregistered trademarks are the property of their respective owners.

© 2024 Kensington Computer Products Group, a division of ACCO Brands.

Patents: <https://www.accobrand.com/patents/>

