

# W7F HP33 UK

12NC: 859991657710

GTIN (EAN) code: 8003437639814

Whirlpool

SENSING THE DIFFERENCE

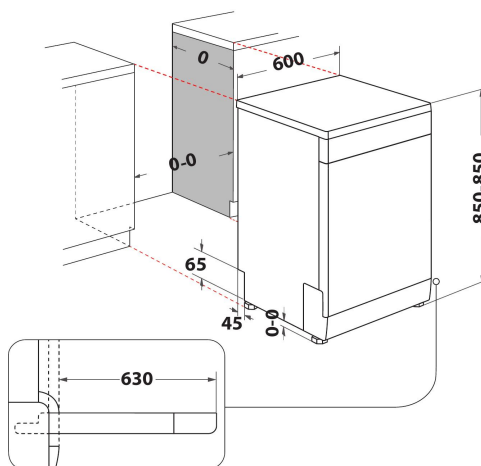

- Installation Type: Free-standing
- Energy class: D
- Maximum number of place settings: 15
- 6TH Sense Technology
- Noise level: 43 dB(A)
- 9.5 L per cycle (2660 L per year)
- PowerCleanPRO
- Third rack: Yes, flexible + handle plastic
- Metallic filter
- Start delay 1-24 h
- FlexiSpace
- Adjustable upper rack
- Half load
- Prewash
- Hot water connection
- Eco 50°C
- Glass 45°C
- Glass Care: long stem glass accessory
- Child lock
- Electronic control
- Annual energy consumption: 242 kWh/annum

## Whirlpool dishwasher: white color, full size - W7F HP33 UK

This Whirlpool Dishwasher features: white color. Outstanding A+++ energy rating, for reduced energy consumption. Convenient digital countdown timer, to inform you when the washing cycle is complete. Innovative technology ensuring extra silent performance, for a very quiet appliance. Superb cleaning performance, for ideal washing results.

### EcoFriendly



Extraordinary savings. 6th SENSE EcoFriendly technology features intelligent sensors to continuously monitor the wash cycle and detect the level of soiling, adjusting resources accordingly. Enjoy ideal cleaning results and save up to 50% energy, water and time.\* (\*Comparison between minimum and maximum consumption on the 6th SENSE programs.)

### Flex Third Rack



The third rack is perfect for accommodating cutlery and utensils and is equipped with sliding modules that allows you to easily load higher items on the middle rack.

### PowerClean Pro



Thanks to 60% more powerful jets\* PowerClean Pro for Maxi Space can remove even the toughest soil from every corner without the need for pre-washing, while delivering 30% extra space\*\* in the lower area thanks to the pan holders. \*Percentage of water power calculated with PowerClean option activated vs non activated. \*\*Percentage calculated vs. the loading space on models of the same Whirlpool range without the PowerClean Pro solution.

### MaxiSpace Tub



10% extra \*\* space that offers loading versatility and plenty of space for every item, for every occasion. \*Comparison between Whirlpool dishwasher models with standard tub and Whirlpool dishwasher models with MaxiSpace tub. Extra space refers to the increased total loading area among the three racks.

### Silent



Silent performance. Your Whirlpool Dishwasher is designed to provide ideal washing results, while ensuring the lowest possible noise output.

### 6th Sense



No prewash required. technology provides perfect washing results with no pre-washing, soaking or scrubbing by hand, while effectively reducing water consumption and costs.

### D energy efficiency



Optimal energy efficiency. Your Dishwasher's D energy rating will allow you to enjoy both great performance and optimal energy consumption.

# W7F HP33 UK

12NC: 859991657710

GTIN (EAN) code: 8003437639814

Whirlpool

SENSING THE DIFFERENCE

## MAIN FEATURES



Construction type	Free-standing
Installation type	Free-standing
Type of control	Electronic
Type of control settings	-
Removable work top	Yes
Main colour of product	White
Electrical connection rating (W)	1900
Current (A)	13
Voltage (V)	220-240
Frequency (Hz)	50
Length of electrical supply cord (cm)	130
Plug type	UK
Length inlet hose (cm)	155
Length outlet hose (cm)	150
Adjustable feet	Yes - front only
Height of the product	850
Width of the product	600
Depth of the product	590
Minimum niche height	0
Maximum niche height	0
Minimum niche width	0
Maximum niche width	0
Niche depth	590
Net weight (kg)	50
Gross weight (kg)	52.5

## TECHNICAL FEATURES

Automatic programmes	Yes
Maximum temperature for water intake (°C)	60
Start delay options	Continuous
Start delay time max. (h)	24
Progress indicator	-
Digital countdown indicator	Yes
Salt light indicator	Yes
Rinse aid light indicator	Yes
Safety device	Yes
Adjustable upper basket	Yes
Largest loadable dish upper basket (cm)	0
Largest loadable dish lower basket (cm)	0
Maximum number of place settings (EU 2017/1369)	15
Column installation	No
Connectivity	No

## PERFORMANCES



Energy efficiency class (EU 2017/1369)	D
Energy Consumption for 100 cycles Eco Programme (EU 2017/1369)	86
Power consumption in standby mode (Psm) (EU 2017/1369)	0,50
Power consumption in off-mode (Po) (EU 2017/1369)	0,50
The water consumption of the eco programme in liters per cycle (EU 2017/1369)	9,5
Airborne acoustical noise emissions (EU 2017/1369)	43
Airborne acoustical noise emission class (EU 2017/1369)	B
Programme duration in HMM (EU 2017/1369)	3:30



 **ENERGY** 

WHIRLPOOL W7F HP33 UK

**A**  
**B**  
**C**  
**D** ←  
**E**  
**F**  
**G**

**86 kWh / 100**

 **15 x**  **9,5 L**

 **3:30**  **43 dB**  
ABCD

2019/2017