

HP Deskjet 6980 series



User's guide

Hewlett-Packard Company notices

The information contained in this document is subject to change without notice.

All rights reserved. Reproduction, adaptation, or translation of this material is prohibited without prior written permission of Hewlett-Packard, except as allowed under copyright laws.

The only warranties for HP products and services are set forth in the express warranty statements accompanying such products and services. Nothing herein should be construed as constituting an additional warranty. HP shall not be liable for technical or editorial errors or omissions contained herein.

Acknowledgements

Microsoft, Windows, and Windows XP are registered trademarks of Microsoft Corporation.

TrueType is a U.S. trademark of Apple Computer, Inc.

Adobe, Adobe Photoshop, and Acrobat are trademarks of Adobe Systems Incorporated.

Bluetooth is a trademark owned by its proprietor and used by Hewlett-Packard Company under license.

Copyright 2005 Hewlett-Packard Development Company, L.P.

Accessibility

The HP printer provides a number of features that make it accessible for people with disabilities.

Visual

The printer software is accessible for users with visual impairments or low vision through the use of Windows accessibility options and features. It also supports most assistive technology such as screen readers, Braille readers, and voice-to-text applications. For users who are color blind, colored buttons and tabs used in the software and on the HP printer have simple text or icon labels that convey the appropriate action.

Mobility

For users with mobility impairments, the printer software functions can be executed through keyboard commands. The software also supports Windows accessibility options such as

StickyKeys, ToggleKeys, FilterKeys, and MouseKeys. The printer doors, buttons, paper trays, and paper guides can be operated by users with limited strength and reach.

Support

For more details about the accessibility of this product and HP's commitment to product accessibility, visit HP's Web site at: www.hp.com/accessibility.

Contents

1	Welcome	4
2	Special features	5
3	Get started	6
	Printer features	6
	Buttons and lights	8
	Paper trays	10
	Photo/envelope feeder	12
	Print cartridges	15
	Ink-backup mode	16
	Automatic paper-type sensor	17
4	Connect to the printer	18
	USB	18
	Wireless networking	19
	Wired Ethernet networking	47
	Bluetooth wireless printing	53
	HP iPAQ Wi-Fi printing	57
5	Print photos	59
	Print borderless photos	59
	Print photos with a border	61
	HP Real Life technologies	63
	Photo print cartridge	64
	Maximum dpi	64
	Advanced color settings	65
	Color management	66
	Gray photo print cartridge	67
	Exif Print	67
	Store and handle photo paper	68
	Save money when printing photos	68
	Other photo projects	69
	Share photos with friends and family	69
6	Print photos from a digital camera	70
	Use a PictBridge camera	70
	Use a Bluetooth camera phone	72
7	Print other documents	73
	E-mail	73
	Letters	74
	Documents	75
	Envelopes	76
	Brochures	77
	Greeting cards	78
	Postcards	79
	Transparencies	80
	Labels	81
	Index cards and other small media	83
	Booklets	84

	Posters	85
	Iron-on transfers	86
	Banners	88
	CD/DVD tattoos	89
8	Printing tips	91
	Printing shortcuts	91
	Fast/economical printing	92
	General everyday printing	92
	Presentation printing	92
	Print in grayscale	92
	Select a print quality	92
	Set the page order	93
	Print multiple pages on a single sheet of paper	94
	Print preview	94
	Set a custom paper size	94
	Select a paper type	95
	Select a paper source	96
	Print task quick sets	97
	Automatic two-sided printing	98
	Manual two-sided printing	101
	Resize a document	105
	Watermarks	107
9	Printer software	109
	Printer Properties dialog box	109
	What's This? help	109
	Ink Status window	109
	Download printer software updates	110
10	Maintenance	112
	Install print cartridges	112
	Set the auto-off feature	115
	Align the print cartridges	116
	Calibrate color	116
	Automatically clean print cartridges	116
	Print a test page	116
	View estimated ink levels	116
	Maintain the printer body	117
	Remove ink from your skin and clothing	117
	Manually clean print cartridges	117
	Maintain print cartridges	118
	Printer Toolbox	119
11	Troubleshooting	121
	Ethernet problems	121
	Wireless communication problems	123
	Printer does not print	127
	Paper jam	128
	Paper problems	129
	Paper mismatch	130
	Printer is stalled	131
	Print cartridge problems	132
	Photos do not print correctly	133

PictBridge problems	136
Bluetooth printing problems	137
Banners do not print correctly	138
Print quality is poor	139
Document is misprinted	140
Problems with borderless documents	141
Error messages	145
Printer lights are on or flashing	147
Document prints slowly	148
If you continue to have problems	149
HP support process	149
12 Accessories	151
Automatic Two-Sided Printing Accessory (duplexer)	151
250-Sheet Plain Paper Tray	159
Auto Two-Sided Print Accessory with Small Paper Tray	164
13 Supplies	175
Paper	175
USB cables	175
Accessories	175
14 Specifications	176
Printer specifications	176
15 Environmental information	177
Environmental statement	177
Print cartridge recovery	178

1 Welcome

To find an answer to a question, select one of the following topics:



- [Special features](#)
- [Get started](#)
- [Connect to the printer](#)
- [Print photos](#)
- [Print photos from a digital camera](#)
- [Print other documents](#)
- [Printing tips](#)
- [Printer software](#)
- [Maintenance](#)
- [Troubleshooting](#)
- [Optional accessories](#)
- [Supplies](#)
- [Specifications](#)
- [Environmental information](#)

2 Special features

Congratulations! You have purchased an HP Deskjet printer that is equipped with several exciting features:

- **Built-in networking capabilities:** Connect to either a [wired](#) or a [wireless](#) network without using an external print server.
- **Ink-backup mode:** Use [ink-backup mode](#) to continue printing with one print cartridge when the other print cartridge has run out of ink.
- **Print Cancel button:** Cancel print jobs at the touch of a [button](#).
- **Borderless printing:** Use the entire page surface when printing [photos](#) and [brochures](#) with the borderless printing feature.
- **Real Life technologies:** Get better photos easier with [HP Real Life technologies](#). Automatic red-eye removal and adaptive lighting to enhance detail in shadows are just a few of the many technologies included.
- **Six-ink upgradeable printing:** Enhanced photo printing with a six-ink [photo print cartridge](#) (purchased separately).
HP Vivera Inks deliver true-to-life photo quality and exceptional fade resistance resulting in vivid colors that last. HP Vivera Inks are specially-formulated and scientifically tested for quality, purity and fade resistance.
- **Printing from a digital camera:** Print photos directly from a PictBridge-compatible camera using the [front USB port](#).
- **Automatic paper-type sensor:** Use the [auto paper-type sensor](#) to optimize print quality for various papers.
- **Quiet Mode:** Use the Quiet Mode [button](#) when you require quieter printing such as with a baby sleeping or a client in the office.
- **Photo/envelope feeder:** Use the [photo/envelope feeder](#) to conveniently print single envelopes, photos, or postcards.
- **Bluetooth printing:** Print images without a cable using Bluetooth. Use an optional [HP Bluetooth Wireless Printer Adapter](#) to print images from most Bluetooth devices to the printer without a cable connection.
- **Optional Automatic Two-Sided Printing Accessory:** Purchase an [Automatic Two-Sided Printing Accessory](#) to print two-sided documents automatically.
- **Optional Auto Two-Sided Print Accessory with Small Paper Tray:** Purchase an [Auto Two-Sided Print Accessory with Small Paper Tray](#) to print two-sided documents automatically and load small media from the back of the printer.
- **Optional 250-Sheet Plain Paper Tray Accessory:** Purchase a [250-Sheet Plain Paper Tray Accessory](#) to expand the printer's paper-handling capability.

3 Get started

- Printer features
- Buttons and lights
- Paper trays
- Photo/envelope feeder
- Print cartridges
- Ink-backup mode
- Automatic paper-type sensor

For a description of the optional accessories, see the [optional accessories page](#).

Printer features

The printer has several features to make printing easier and more efficient.

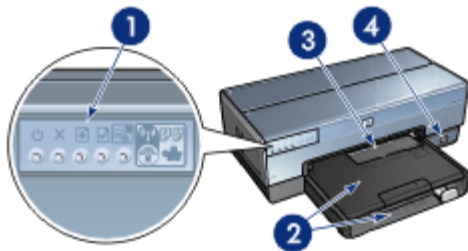

1	Buttons and lights
2	Paper trays
3	Photo/envelope feeder
4	Front USB port

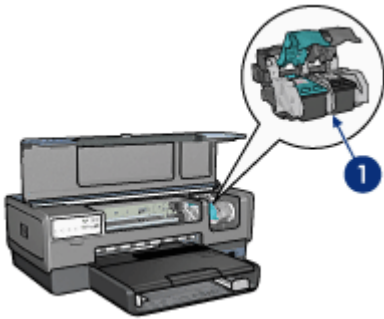

- | | |
|---|---|
| 1 | Print cartridges |
| 2 | Automatic paper-type sensor (not illustrated) |
| 3 | Ink-backup mode (not illustrated) |

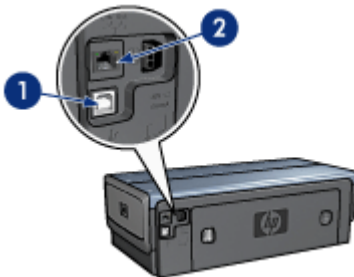

- | | |
|---|---------------------|
| 1 | Rear USB port |
| 2 | Wired Ethernet port |

Optional accessories



Automatic Two-Sided
Printing Accessory
(optional)

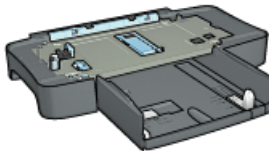

250-Sheet Plain Paper
Tray (optional)

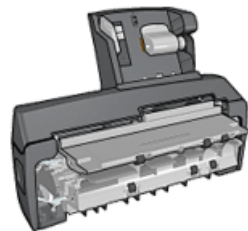

Auto Two-Sided Print Accessory
with Small Paper Tray (optional)

Buttons and lights

Use the printer buttons to turn the printer on and off, cancel a print job, restart a job, operate in Quiet Mode, and set up a wireless connection with SecureEasySetup. The printer lights give you visual cues about the status of the printer.

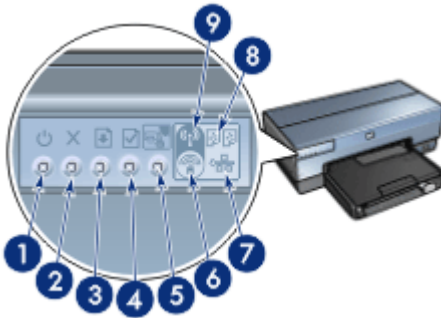

1	Power button and light
2	Print Cancel button
3	Resume button and light
4	Report Page button
5	Quiet mode button
6	SecureEasySetup button
7	Network light
8	Print Cartridge Status lights
9	Wireless Status light

For a description of the following buttons and lights, click the appropriate option:

- [Report Page button](#)
- [SecureEasySetup button](#)
- [Network light](#)
- [Wireless Status light](#)

Power button and light

Use the Power button to turn the printer on and off. It can take a few seconds for the printer to turn on after you press the Power button.

The Power light flashes when the printer is processing.



Caution Always use the Power button to turn the printer on and off. Using a power strip, surge protector, or a wall-mounted switch to turn the printer on and off might cause printer failure.

The printer is designed with an [auto-off feature](#) that, when set, automatically places the printer into a low power mode when it has been idle for 30 minutes. In this mode, the printer continues to consume a maximum 3.0 watts of power with the radio off (maximum 5.5 watts with the radio on) and turns back on automatically when print jobs are sent to the printer. You can manually turn the printer off by pressing and holding the Power button

for three seconds. When the printer is manually turned off, the printer uses less than one watt of power.



Note Energy consumption can be prevented by turning the printer power off, and then disconnecting the end of the printer power cord from the electrical source.

Print Cancel button

Pressing the Print Cancel button cancels the current print job.

Resume button

The Resume light flashes when an action is required, such as loading paper or clearing a paper jam. When the problem is solved, press the Resume button to continue printing.

Quiet mode button

Use the Quiet Mode feature when you have an occasion that requires quieter printing such as a baby sleeping or a client in the office. By pressing the Quiet Mode button, the speed and sound level of the print job is reduced. To resume normal printing speed, press the Quiet Mode button again. The button is illuminated when Quiet Mode is active.

Quiet mode can be used in Normal, Fast Normal, and Draft print modes.

If the printer is printing while the Quiet Mode button is pressed, Quiet Mode goes into effect on the next page. The light on the Quiet Mode button will blink to show that the mode is pending, and then turn on fully when Quiet Mode is in effect.

Print Cartridge Status lights

The Print Cartridge Status lights indicate the status of the [print cartridges](#).

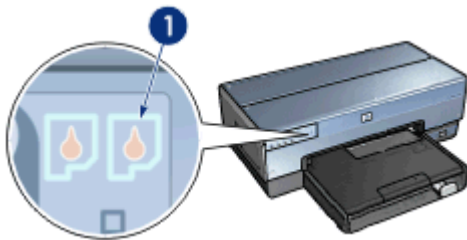

1 | Print Cartridge Status lights

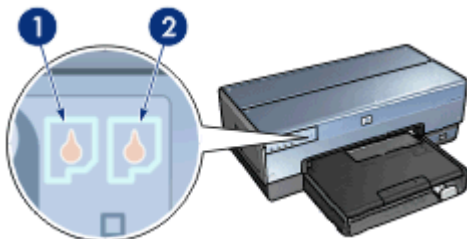

1. The left status light represents the tri-color print cartridge, which is installed in the left side of the print cartridge cradle.
 - The light is on and solid when the tri-color print cartridge is low on ink.
 - The light flashes when the tri-color print cartridge needs to be serviced.
2. The right status light represents the print cartridge that is installed in the compartment on the right side of the print cartridge cradle. That print cartridge can be the black print cartridge, the **photo print cartridge**, or the **gray photo print cartridge**.
 - The light is on and solid when the black, photo, or gray photo print cartridge is low on ink.
 - The light flashes when the black, photo, or gray photo print cartridge needs to be serviced.

PictBridge lights

Plug a PictBridge-enabled camera into the front USB port using a digital camera USB cable to print digital photographs.

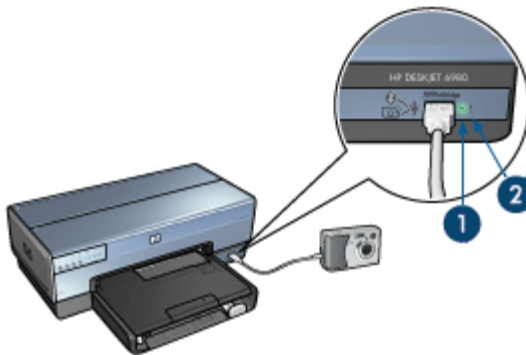

1	Connection light
2	Error light

When a PictBridge-compatible camera is connected correctly, the green Connection light is illuminated. The printer Power light flashes and the Connection light remains lit solid when printing from the camera. If the camera is not PictBridge-compatible or is not in PictBridge mode, the amber Error light flashes.

Paper trays

The printer has two paper trays:

In tray

The In tray holds paper or other media.



1	In tray
---	---------

Slide the paper guides firmly against the edges of the media on which you are printing.

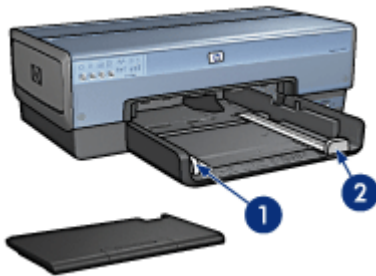

1	Paper-width guide
2	Paper-length guide

Out tray

Printed pages are deposited in the Out tray.

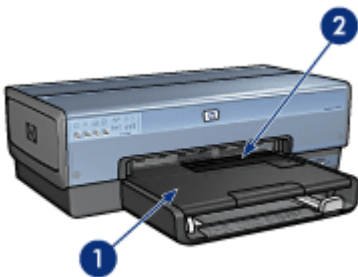

1	Out tray
2	Photo/envelope feeder

Use the [photo/envelope feeder](#) to print single envelopes, small photos, and cards. Raise the Out tray to load paper or other media. Lower the Out tray before printing.

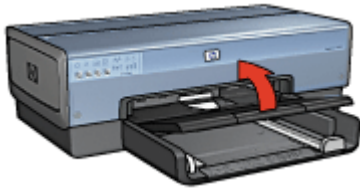

To prevent paper from falling out of the Out tray, fully pull out the Out-tray extension. If you are printing in the Fast Draft mode, unfold the Out-tray extension stop.

Do not unfold the Out-tray extension stop when printing on legal paper.



1	Out-tray extension
2	Out-tray extension stop

After the print job is complete, fold the Out-tray extension stop, and then push the Out-tray extension into the Out tray.



Photo/envelope feeder

Use the photo/envelope feeder to print a variety of media sizes including the following documents:

- Envelopes
- Photos
- Postcards



1 | Photo/envelope feeder

Envelopes

Follow these steps to use the photo/envelope feeder for single envelopes:

1. Insert the envelope into the photo/envelope feeder with the side to be printed on facing down and the flap to the left.

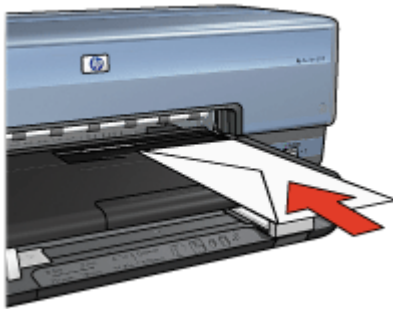

2. Push the envelope into the printer as far as it will go without bending.
3. Slide the photo/envelope feeder forward as far as it will go.



4. Print the envelope.

Photos

Follow these steps to use the photo/envelope feeder to print a single photo:

1. Insert the photo paper into the photo/envelope feeder with the side to be printed on facing down.
2. Gently push the photo paper into the photo/envelope feeder as far as it will comfortably go.



3. Slide the photo/envelope feeder forward as far as it will go.



4. Print the [photo](#).

Postcards

Follow these steps to use the photo/envelope feeder to print a single postcard:

1. Insert the postcard into the photo/envelope feeder with the side to be printed on facing down.
2. Gently push the postcard into the photo/envelope feeder as far as it will comfortably go.



- Slide the photo/envelope feeder forward as far as it will go.



- Print the postcard.

Print cartridges

Four print cartridges can be used with the printer.



1	Black print cartridge
2	Tri-color print cartridge
3	Photo print cartridge
4	Gray photo print cartridge



Note The availability of print cartridges varies by country/region.

Use print cartridges

The print cartridges can be used in the following ways:

- **Everyday printing:** Use the black and tri-color print cartridges for everyday print jobs.
- **Quality color photos:** For more vibrant colors when printing color photographs or other special documents, remove the black print cartridge and install a photo print cartridge. The photo print cartridge, in combination with the tri-color print cartridge, provides you with virtually grain-free photos.
- **Quality black and white photos:** For outstanding black and white photographs, remove the black print cartridge and use a gray photo print cartridge in combination with the tri-color print cartridge.

Replace print cartridges

When buying print cartridges, look for the print cartridge selection number.

You can find the selection number in three places:

- Selection number label: Look at the label on the print cartridge that you are replacing.

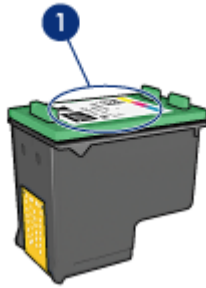

1	Selection number label
---	------------------------

- Printer documentation: For a list of print cartridge selection numbers, see the reference guide that came with the printer.
- Print Cartridge Ordering Information dialog box: For a list of print cartridge selection numbers, open the printer [Toolbox](#), click the **Estimated Ink Level** tab, and then click the **Print Cartridge Information** button.

If a print cartridge runs out of ink, the printer can operate in [ink-backup mode](#).

For information about installing a replacement print cartridge, see the [print cartridge installation](#) page.

Ink-backup mode

Use the ink-backup mode to operate the printer with only one print cartridge. The ink-backup mode is initiated when a print cartridge is removed from the print cartridge cradle.

Ink-backup mode output

Printing in ink-backup mode slows the printer and affects the quality of printouts.

Installed print cartridge	Result
Black print cartridge	Colors print as grayscale.
Tri-color print cartridge	Colors print but black is grayed and is not a true black.
Photo print cartridge	Colors print as grayscale.
Gray photo print cartridge	Colors print as grayscale.



Note HP does not recommend using the photo print cartridge or the gray photo print cartridge for ink-backup mode.

Exit ink-backup mode

Install two print cartridges in the printer to exit ink-backup mode.

For instructions about installing a print cartridge, see the [print cartridge installation page](#).

Automatic paper-type sensor

The HP automatic paper-type sensor detects the paper in the printer, and then selects optimal print settings for that media. The result is fewer mouse clicks to start printing, and automatic optimal print quality on plain, photo, brochure and other high-quality papers. The sensor also checks the paper width to ensure it matches the size selected in the printer software. If the widths are different, the printer warns you so that you do not waste a sheet of paper.

When the auto paper-type sensor is engaged, the printer uses a red optical sensor light to scan the first page of a document and determine the best paper-type setting and check paper width. If the paper width is different from the printer software, the printer warns you and gives you the opportunity to stop printing. If the width matches, the printer determines the paper-type setting and the page is printed.



Note The Automatic Paper-Type Sensor is not available for documents that are printed from the 250-Sheet Plain Paper Tray Accessory or the Auto Two-Sided Print Accessory with Small Paper Tray.

For more information about using the automatic paper-type setting, see [Select a paper type](#).



Caution Do not place the printer in direct sunlight. Direct sunlight can interfere with the auto paper-type sensor.

4 Connect to the printer

- [Wireless networking](#)
- [Wired Ethernet networking](#)
- [Connecting a digital camera](#)
- [USB](#)
- [Bluetooth wireless printing](#)
- [HP iPAQ Wi-Fi printing](#)

USB

The printer connects to the computer with a universal serial bus (USB) cable. The computer must be running Windows 98 SE or later to use a USB cable.

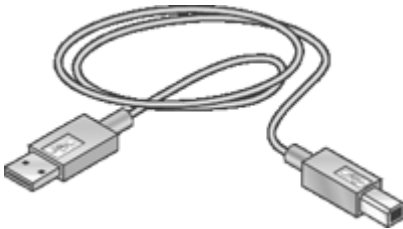

For instructions about connecting the printer with a USB cable, see the setup poster that came with the printer.



Note A USB cable might not be packaged with the printer.

Change the printer from a USB connection to a network connection

If you first install the printer with a USB connection, you can later change to either a wireless or Ethernet network connection. If you already understand how to connect to a network, you can use the general instructions that follow. For more detailed instructions on connecting the printer to a network, see the Setup Guide.



Note For optimal performance and security in a wireless network, use an access point (such as a wireless router) to connect the printer.

To change a USB connection to a wireless connection

1. Unplug the USB connection from the back of the printer.
2. Insert the printer software CD in the computer CD-ROM drive, and then follow the onscreen instructions.
This runs the Setup Wizard.
3. On the **Connection Type** screen, select **Wireless**, and then click **Next**.

4. Follow the onscreen instructions to complete the network installation.
5. When the installation is complete, open **Printers and Faxes** in **Control Panel** and delete the printers for the USB installation.

To change a USB connection to a wired (Ethernet) connection

1. Unplug the USB connection from the back of the printer.
2. Connect an Ethernet cable from the Ethernet port on the back of the printer to an available Ethernet port on the router, switch, or access point.
3. Insert the printer software CD in the computer CD-ROM drive, and then follow the onscreen instructions.
This runs the Setup Wizard.
4. On the **Connection Type** screen, select **Wired Network**, and then click **Next**.
5. Follow the onscreen instructions to complete the network installation.
6. When the installation is complete, open **Printers and Faxes** in **Control Panel** and delete the printers for the USB installation.

Wireless networking

For setup information, click one of the following options:

- [Wireless network basics](#)
- [Wireless security](#)

For a description of the printer's wireless feature, click one of the following options:

- [SecureEasySetup button](#)
- [Wireless Status light](#)
- [Report Page button](#)
- [Network light](#)
- [Wireless radio](#)
- [HP Report page](#)
- [Embedded Web server \(EWS\)](#)

Other information:

- [Resetting the printer to the factory defaults](#)
- [Troubleshooting](#)
- [Glossary](#)

Wireless networking basics

The printer's built-in wireless communications feature allows you to connect the printer directly to an **802.11g** or **802.11b** Wi-Fi wireless network without the aid of an external print server.

To install the printer on a wireless network, follow the wireless installation instructions in the Setup guide.

Wi-Fi

802.11g and 802.11b

Wi-Fi is a wireless communications technology that allows you to connect computers and other devices (such as printers) to each other and the Internet without the use of wires. The printer is compatible with two types of Wi-Fi technology: **802.11g** and **802.11b**.

Both 802.11g and 802.11b operate by radio transmission in the 2.4 Gigahertz (GHz) frequency band. 802.11g devices communicate at a maximum speed of 54 megabits per second (Mb/s). 802.11b devices communicate at a maximum speed of 11 Mb/s.

For instructions to switch the printer between 802.11b and 802.11g, click [here](#).

802.11a

802.11a is an emerging wireless networking technology that operates in the 5 GHz frequency band and offers communication speeds similar to those of 802.11g. The printer cannot communicate with 802.11a devices over a wireless connection.

If you have an 802.11a wireless network, you can use an [Ethernet cable](#) to connect the printer to the network's [Wireless Access Point \(WAP\)](#) in order to achieve a processing speed comparable to that of the 802.11a network. If your wireless network supports 802.11g and 802.11b technology, another option is to switch the rest of the network to the lower frequency to use the printer wirelessly.



To connect the printer to an Ethernet network, follow the [Ethernet network installation instructions](#).

Adapters and access points

Adapters

While some devices, such as the printer, have built-in Wi-Fi capability, other devices need an adapter to become Wi-Fi-enabled.

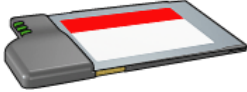
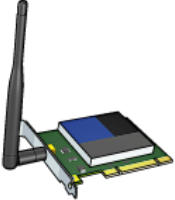
Examples of common adapters include:

	<p>PCMCIA card that plugs into the PCMCIA slot in a laptop</p>
	<p>ISA or PCI card that can be used with a desktop computer</p>
	<p>USB adapter that connects to the USB port on a desktop or laptop computer</p>

Other types of adapters are available. All adapters come with configuration software that allows you to configure the adapter for a wireless network.

Access points

[Infrastructure networks](#) are a common variety of wireless network. An infrastructure network requires the use of a [Wireless Access Point \(WAP\)](#).

A WAP acts as a central hub for a wireless network or as a router connecting the wireless network to another network (such as the Internet or an Ethernet network). Devices on the network communicate through the WAP.



Wireless network examples

To see some examples of wireless networks, see the [wireless network examples page](#).

Communication modes

There are two types of communication modes for wireless devices:

- [Infrastructure mode](#)
- [ad hoc](#)

Infrastructure mode

For optimal performance and security in a wireless network, HP recommends you use a [Wireless Access Point \(WAP\)](#) (802.11b or g) to connect the printer and other network devices. When network devices are connected through an access point, this is called an **infrastructure** network. A wireless network without an access point is called an **ad hoc** network.

The advantages of a wireless infrastructure network as compared to an ad hoc network include:

- Advanced network security
- Enhanced reliability
- Network flexibility
- Better performance, especially with 802.11g mode
- Shared Internet access



What you need for a wireless infrastructure network

To connect the printer to a wireless network, you need the following:

- A wireless 802.11b or g network that includes a wireless access point.
- A desktop computer or laptop with either wireless networking support, or a network interface card (NIC). You can use either an Ethernet (wired) connection or a wireless connection from the computer to the access point. If you want to use an Ethernet connection to the access point, follow the directions in the Setup Guide.
- Broadband Internet access (recommended) such as cable or DSL. If you connect the printer on a wireless network that has Internet access, HP recommends that you use a wireless router (access point) that uses Dynamic Host Configuration Protocol (DHCP).
- Network name (SSID)
- WEP key (suggested), WPA Passphrase (if needed)

Ad hoc mode

When the printer is set to the ad hoc communication mode, the printer communicates directly with other wireless devices on the network without the use of a [WAP](#). You might want to use an ad hoc connection if you do not want to invest in an access point, or you want to set up a simpler, more casual network.



Note An ad hoc is available if you do not have an access point. However, it provides little flexibility, a low level of network security, and slower network performance than with an access point.

For a wireless ad hoc setup, you need to manually turn on the wireless radio.

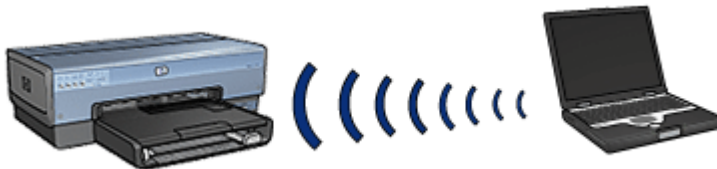

Switch between 802.11b and 802.11g

The ad hoc communication mode defaults to 802.11b. The infrastructure communication mode defaults to 802.11g. Use the printer's [embedded Web server \(EWS\)](#) to change these settings.



Note To switch from ad hoc 802.11b to ad hoc 802.11g, the computer must have an 802.11g card or adapter installed.

Wireless network settings

Devices (such as computers and printers) on a wireless network must share the following settings:

Network name (SSID)

A network name, or "Service Set Identifier (SSID)," identifies a particular wireless network. In order to operate on a network, a device must know the network's network name.

For an in-depth explanation of network names, see the [network names page](#).

Wireless profiles

A wireless profile is a group of network settings unique to a given wireless network. A wireless device might have wireless profiles for several wireless networks. In order to use the printer, the computer must be set to the profile for the printer's wireless network.

For example, a laptop that is used both at work and at home, might have one profile for a wireless network at work and another profile for a wireless network at home.

The printer does not support multiple profiles.

For more information on wireless profiles, see the [wireless profiles page](#).

Wireless security

Devices on a wireless network must share the same security settings.

For a description of the wireless security options available for the printer, see the [wireless security page](#).

Reduce interference in a wireless network

The following tips help reduce the chances for interference in a wireless network:

- Keep the wireless devices away from large metal objects, such as filing cabinets, and other electromagnetic devices, such as microwaves and cordless telephones, as these objects can disrupt radio signals.
- Keep the wireless devices away from large masonry structures and other building structures as these objects can absorb radio waves and lower signal strength.
- For an infrastructure network, position the WAP in a central location in line of sight with the wireless devices on the network.
- Keep all wireless devices on the network within range of one another.

Printing

Computers on the network send print jobs directly to the printer, which prints them in the order received.

The printer can accept print jobs sent simultaneously from four users.

For example, if five users each send a print job to the printer at the same time, the printer accepts four of the print jobs and rejects the fifth. The user who sent the fifth print job should wait a few minutes and then resend the print job.

Wireless network examples

There are three common configurations for wireless networks:

Ad hoc networks

An ad hoc network is a type of wireless network in which devices directly communicate with each other rather than through a [Wireless Access Point \(WAP\)](#).

For example, a simple ad hoc wireless network might consist of a laptop and a printer communicating directly with one another.

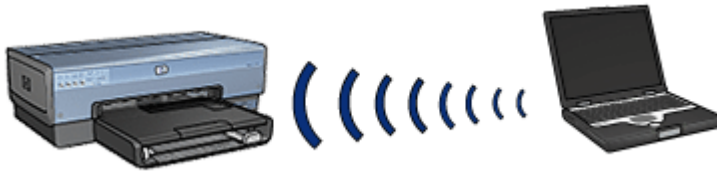

Ad hoc networks are typically small and simple. Performance on these types of networks can degrade if more than six devices are on the network.

Infrastructure networks

On an infrastructure network, devices, such as computers and printers, communicate through a **Wireless Access Point (WAP)**. WAPs act as **routers** or **gateways** on small networks.

For example, a simple infrastructure wireless network might consist of a laptop and a printer communicating through a WAP.



Mixed wired and wireless networks

Wireless devices often exist on a largely wired network.

In this case, a **WAP** is connected to the main network by an Ethernet cable plugged into the WAP's WAN port. The WAP acts as the go-between for the wired devices and the wireless devices. The wired devices communicate with the WAP over the Ethernet cable, while the wireless devices communicate with the WAP over radio waves.

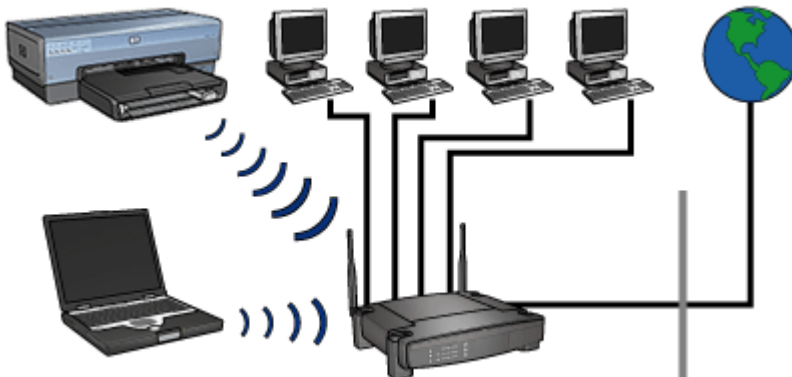

For example, a mixed wired and wireless network can consist of the following:

- Several desktop computers
- A WAP connected to an Ethernet network
- A printer connected wirelessly to the WAP

In order to use the printer, a desktop PC sends a print job over the Ethernet cable to the WAP. The WAP then wirelessly transmits the print job to the printer.

Wireless profiles

A wireless profile is a set of network settings unique to a given wireless network.

Many wireless devices have configuration utilities that allows the device to have wireless profiles for several wireless networks. In order to use the printer, the computer must be set to the profile for the printer's wireless network.



Note Not all wireless devices support multiple profiles.



The printer only supports one wireless profile.

Example

A person uses the same wireless-enabled laptop at work and at home. They have one wireless network at work, and another wireless network at home

Each network has a unique set of wireless settings. The person creates the following wireless profiles on the laptop:

- **at_work**: Contains the network settings for the office wireless network
- **at_home**: Contains the network settings for the home wireless network

Wireless network location	Profile
Office 	at_work <ul style="list-style-type: none">• Network name: office• Communication mode: infrastructure• Security: WPA• Authentication: WPA/PSK
Home 	at_home <ul style="list-style-type: none">• Network name: home• Communication mode: ad hoc• Security: WEP• Authentication: Open System

When the laptop is being used at work, the person must set the wireless profile to `at_work` in order to connect to the office network.

Conversely, the laptop must be set to the `at_home` wireless profile when the person is at home and wants to connect the laptop to the home network.

Network name (SSID)

A network name, or "Service Set Identifier (SSID)," identifies a particular wireless network. In order to operate on a network, a device must know the network's name.

A wireless network only has one network name.

A given location, such as an office, might have several wireless networks, each with a different network name. Wireless devices use network names to identify overlapping wireless networks.



Caution To prevent other users from accessing the wireless network, HP strongly recommends setting a password or passphrase and a unique SSID in your access point. The access point might have been shipped with a default SSID which can be accessed by others using the same default SSID. For more information on how to change the SSID, see the documentation that came with your access point.

Example

The printer is in an office with two wireless [infrastructure](#) networks. Each network has a [Wireless Access Point \(WAP\)](#).



Note In this example, both wireless networks have the same security settings.



1	Network name equals "network_1"
2	Network name equals "network_2"

The network name for one wireless network is **network_1**. The network name for the other wireless network is **network_2**.

The printer is configured for network_1

The printer's network name (SSID) setting has been configured for **network_1**. The printer can only communicate to **network_1**. In other words, the printer can only accept print jobs from **network_1**.



1	Network name equals "network_1"
2	Network name equals "network_2"

The laptop is configured for network_2

The laptop's network name (SSID) settings have been configured for **network_2**. The laptop is unable to communicate with the printer and cannot send print jobs to the printer.



1	Network name equals "network_1"
2	Network name equals "network_2"

The laptop is reconfigured for network_1

The laptop's network name (SSID) settings have been reconfigured for **network_1**. The laptop is able to communicate with the printer and is ready to send print jobs to **network_1**.



1	Network name equals "network_1"
2	Network name equals "network_2"

Wireless security

The printer can be configured for several wireless security options depending on the type of wireless network of which the printer is part.

Infrastructure networks

- WPA
- WEP
- Open System

Ad hoc networks (wireless direct-connect)

- WEP
- Open System

For more information about wireless security, see the [authentication and encryption page](#).

Add security to the network

As with other networks, security for wireless local area networks (WLANs) focuses on access control and privacy. Traditional WLAN security includes the use of Service Set Identifiers (SSIDs), open or shared-key authentication, static Wired Equivalent Privacy (WEP) keys, and optional Media Access Control (MAC) authentication. This combination offers a rudimentary level of access control and privacy.

If you are using an access point, you might also employ advanced forms of authentication and encryption on the WLAN, such as the Pre-Shared Key mode of Wi-Fi Protected Access (WPA-PSK).

To protect the wireless network, HP strongly suggests you implement a wireless security scheme (either WEP or WPA) during setup, use an antivirus program to protect against computer viruses, and follow basic security rules such as setting strong passwords and not opening unknown attachments. Other network components, including firewalls, intrusion-detection systems, and segmented networks, should also be considered as part of the network design.



Note If you decide to add encryption and authentication to the network after installing the printer, change the settings on the printer prior to changing them on other devices on the network.

Authentication and encryption

Wireless security is a complex and developing topic. This page gives a brief overview of the basics involved in making a wireless network secure.

In the simplest terms, wireless security involves two strategies: authentication and encryption.

A wireless security method, such as [WEP](#) or [WPA](#), involves varying levels of authentication and encryption.

Authentication

Definition

Authentication verifies the identity of a user or device before granting access to a network, making it more difficult for unauthorized users to access network resources.

In order to be authenticated and allowed to use a network, a device must supply a known password to other devices on the network. If the device cannot supply the correct password, it will not be able to use other devices on the network.

Types of authentication

The printer supports three types of authentication. Each type of authentication has its benefits and limitations.

Authentication type	Description	Benefits	Limitations
Open System	Devices on a network identify themselves with the network name (SSID) only.	Least complicated strategy.	Provides little protection against unauthorized users.
Shared Key	Devices use a shared master secret to identify themselves as authorized members of the network.	Convenient to use in conjunction with WEP, since a WEP key can serve as the shared authentication key.	All devices must have the key. The shared key does not change automatically.
WPA/PSK	Devices use a single pre-shared key (PSK) to identify themselves as authorized members of the network and to generate an encryption key.	The pre-shared key and the encryption keys are not identical. Allows smaller networks to use WPA without the need for an authorization server.	All devices must have the key.

Encryption

Definition

Encryption involves using a password to encode data sent over a wireless network in order to make the data unintelligible to eavesdroppers. Only devices that know the password can decode the data.

Types of encryption

The printer supports four types of encryption. Each type of encryption has its benefits and limitations.

Encryption type	Description	Benefits	Limitations
Open System	Devices on a network do not encrypt data.	Least complicated strategy.	Provides no protection against eavesdroppers.

(continued)

Encryption type	Description	Benefits	Limitations
WEP encryption	Devices on a network share a password, called a "WEP key" to encode and decode data.	Simplest strategy that provides encryption.	All devices must have the key. The WEP key does not change automatically. WEP encryption provides less security than both AES or TKIP.
AES	Advanced Encryption Standard (AES) is a U.S. government sponsored encryption method that uses a complex algorithm called "Rijndael." AES uses encryption keys to encode data. AES automatically changes the encryption keys after a certain time interval, thus making the wireless network less vulnerable to eavesdropping.	Since the encryption key changes automatically, the data is more difficult for eavesdroppers to decode.	All devices must have the key.
TKIP	Temporal Key Integrity Protocol (TKIP) uses encryption keys to encode data. TKIP automatically changes the encryption keys after a certain time interval, thus making the wireless network less vulnerable to eavesdropping.	Since the encryption key changes automatically, the data is more difficult for eavesdroppers to decode.	All devices must have the key.

Wi-Fi Protected Access (WPA)

Wi-Fi Protected Access (WPA) provides security by doing the following:

- Encrypting data sent over radio waves from one wireless device to another wireless device
- Controlling access to network resources through authentication protocols

Only devices that share the same WPA settings as the printer will be able to communicate with the printer.

For example, if the printer's network uses WPA, only devices that have the same WPA settings as the printer will be able to use the printer.

WPA provides better security than [WEP](#).

WPA is a network feature

WPA is an optional wireless network feature. Not all wireless networks use WPA.

Configure the printer for WPA only if the printer's network uses WPA. The printer's WPA settings must match the network's settings.

If the printer's network does not use WPA, do not configure the printer to use WPA.

If you do not know if the network uses WPA, see the configuration utility for the computer's NIC card or the network's [Wireless Access Point \(WAP\)](#).

Encryption

WPA uses encryption keys to encode data.

The printer supports two types of WPA encryption: TKIP and AES.

For more information about TKIP and AES, see the [authentication and encryption page](#).

To add WPA security

Follow these steps to configure the printer to use WPA:

1. Open the printer's [embedded Web server \(EWS\)](#).
2. Click the **Networking** tab.
3. Under **Connection**, click **Wireless (802.11)**.
4. Click the **Advanced** tab.
5. Under **Network Settings**, select **Infrastructure**, and then click **WPA-PSK Authentication**.
6. Select one of the following options from the **Encryption** drop-down list:
 - **TKIP**
 - **AES**
 - **AES/TKIP**
 - **WEP**
7. Enter the passphrase in the **Passphrase** box, and then re-enter the passphrase in the **Confirm Passphrase** box.
8. Review the configuration summary, click **Apply**, and then close the EWS.

Wired equivalent privacy (WEP)

Wired Equivalent Privacy (WEP) provides security by encrypting data sent over radio waves from one wireless device to another wireless device.

WEP can also provide security through authentication. For more information about authentication and encryption, see the [authentication and encryption page](#).

WEP encodes the data sent across the network making the data unintelligible to eavesdroppers. Only devices that share the same WEP settings as the printer will be able to communicate with the printer.

For example, if the printer's network uses WEP, only devices that have the same WEP settings as the printer will be able to use the printer.

WEP is a network feature

WEP is an optional wireless network feature. Not all wireless networks use WEP.

Configure the printer for WEP only if the printer's network uses WEP. The printer's WEP settings must match the network's settings. If the network has WEP, you must use an Ethernet cable to connect the printer to the network in order to install the printer software.

If the printer's network does not use WEP, do not configure the printer to use WEP.

If you do not know if the network uses WEP, see the configuration utility for the computer's NIC card or the network's [Wireless Access Point \(WAP\)](#).

WEP keys

Devices on a WEP-enabled network use [WEP keys](#) to encode data.

WEP keys can also be used for authentication.

After creating a set of WEP keys, record and store the keys in a secure location. You might not be able to retrieve the WEP keys if you lose them.



Caution If you lose the WEP keys, you will not be able to add a new device to the network without reconfiguring the WEP settings for every device on the network.

A WEP-enabled network might use multiple WEP keys. Each WEP key is assigned a key number (such as Key 2). Each device on the network must recognize all the network's WEP keys and the key number assigned to each WEP key.

To add WEP encryption

Follow these steps to configure the printer to use WEP:

1. Open the printer's [embedded Web server \(EWS\)](#).
2. Click the **Networking** tab.
3. Under **Connection**, click **Wireless (802.11)**.
4. Click the **Advanced** tab.
5. Under **Network Settings**, select **Infrastructure** or **Ad Hoc**, and then click **WEP encryption**.
6. Select the authentication method from the **Authentication** drop-down list.
7. Enter the WEP key in the **Key** box, re-enter the WEP key in the **Confirm Key** box, and then click a number in the **Index** drop-down list to assign the WEP key an index number.



Note If the network uses multiple WEP keys, repeat step six for each WEP key. Assign each WEP key a different index number.

8. Review the configuration summary, click **Apply**, and then close the EWS.

Open system

A wireless network that does not use any authentication or encryption method is referred to as an "open system."

An open system can still have a minor level of security if the network's wireless access point(s) does not broadcast the network's network name (SSID). A device trying to join the network must then know the network name before connecting.

For more information about network names, see the [network name \(SSID\) page](#).

An open system is highly vulnerable to eavesdropping and intrusion.

Configure the printer for an open system

Follow these steps to configure the printer for an open system:

1. Open the printer's [embedded Web server \(EWS\)](#).
2. Click the **Networking** tab.
3. Under **Connection**, click **Wireless (802.11)**.
4. Click the **Advanced** tab.
5. Under **Network Settings**, select **Infrastructure** or **Ad Hoc**, and then click **No Authentication or Encryption**.
6. Review the configuration summary, click **Apply**, and then close the EWS.

SecureEasySetup button

SecureEasySetup (SES) simplifies the setup of a Wi-Fi network by automating the processes of configuring new wireless networks and adding devices to existing networks. After a user pushes the SecureEasySetup button on their router and printer, SecureEasySetup establishes a private connection between the devices and automatically configures the network's [Service Set Identifier \(SSID\)](#) while enabling WPA security.

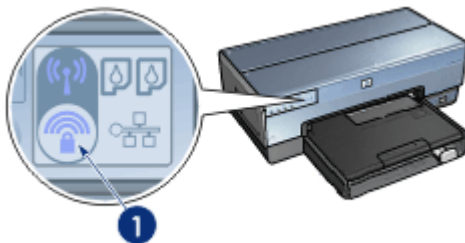

1	SecureEasySetup button
---	------------------------

See the Setup Guide for instructions on how to use SecureEasySetup.

Wireless Status light

The Wireless Status light indicates the status of the printer's internal wireless communications radio.

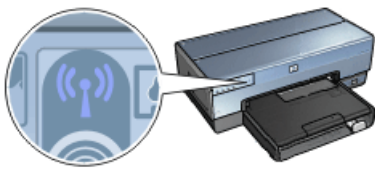
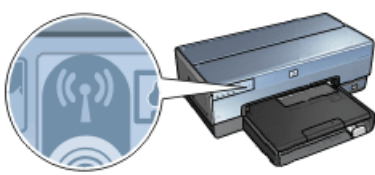
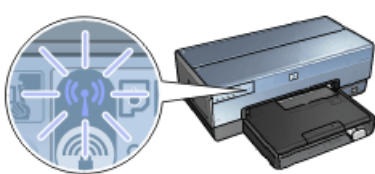
State of the Wireless Status light	Printer status
<p>On</p> 	<p>Able to receive and transmit data wirelessly.</p>
<p>Off</p> 	<p>Is not able to receive and transmit data wirelessly.</p>
<p>Flashing</p> 	<p>Receiving data.</p>

Report Page button

Use the Report Page button to do the following:

- [Print an HP Report page](#)
- [Reset the printer to the factory defaults](#)

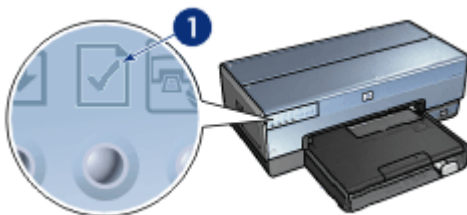

1 Report Page button

Network light

The Network light illuminates when the printer is connected to:

- An [Ethernet](#) network
- An active [wireless](#) network
- An active wireless direct-connection to a computer or other wireless device

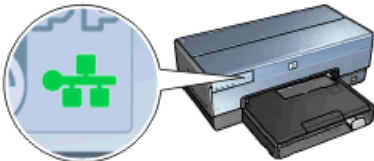
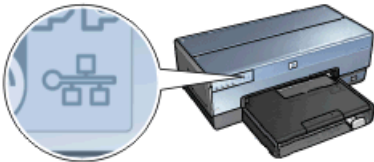
Status of the icon	Status of the printer network connection
On 	Connected to either an Ethernet network or a wireless network.
Off 	Not connected to an Ethernet network or a wireless network.

Wireless radio

The printer has an internal wireless radio for wireless communication. The wireless radio feature is in either an enabled or disabled mode. When enabled, the wireless radio can be on or off but when in the disabled mode, the radio can only be off. The wireless radio is enabled but off by default.

How the wireless radio works

The wireless radio broadcasts on the 2.4 GHz frequency whenever the wireless radio is powered on and enabled.

The wireless radio automatically turns off when the printer is powered off or unplugged from a power source.

If the printer is connected to an active Ethernet network with an Ethernet cable, the wireless radio is inactive and the printer will not make a wireless connection.



Note USB connections have no effect on the radio's functionality.

Wireless Status light

The Wireless Status light indicates the status of the wireless radio. For a description of the Wireless Status light, see the [Wireless Status light page](#).

Disable and enable the wireless radio

Disabling the radio turns the wireless radio off. When disabled, the wireless radio sends no signals even if the printer is powered on, preventing the radio from being turned on accidentally.

Enabling the radio automatically turns the wireless radio on. When enabled, the wireless radio sends signals if the printer is powered on.

Disable the wireless radio

Follow these wireless steps to disable the radio:

1. Verify that the printer is powered on and is idle.
2. Press and hold down the **Report Page** button.
3. While holding down the **Report Page** button, press the **Cancel** button once, and then press the **Resume** button once.
4. Release the **Report Page** button.

Enable the wireless radio

Follow these steps to re-enable the wireless radio:

1. Verify that the printer is powered on and is idle.
2. Press and hold down the **Report Page** button.
3. While holding down the **Report Page** button, press the **Cancel** button once.
4. Release the **Report Page** button.

Manually turn on and off the wireless radio

Use the SES button to quickly turn on and off wireless radio.

Turn radio on

Follow these steps to turn on the wireless radio:

1. Verify the printer is powered on and idle.
2. Open the top cover of the printer.
3. Press the **SES** button twice (two presses within 3 seconds). The wireless radio (and the [Wireless Status light](#)) will turn on and stay on.
4. Close the top cover.



Note Ad hoc connections are now possible if the printer's wireless radio is in ad hoc mode. Press the **Report Page** button and verify on the HP Report page that the communication mode is **ad hoc**, the network name (SSID) is **hpsetup**, and the IP address is something other than **0.0.0.0**. If not in ad hoc mode, you must [access the EWS](#) to change to ad hoc mode or [reset the printer to factory defaults](#).

Turn radio off

Follow these steps to turn off the wireless radio:

1. Verify the printer is powered on and idle, and that the [Wireless Status light](#) is illuminated.
2. Open the top cover of the printer.

3. Press the **SES** button twice (two presses within 3 seconds). The wireless radio (and the **Wireless Status light**) will turn off.
4. Close the top cover.



Note Although now off, the radio is still enabled and can turn on automatically, for example during software installation.

HP Report page

The HP Report page supplies useful information about the printer's **wireless**, **wired**, and **front USB port** connections.

Print an HP Report page

To print an HP Report page, verify that the printer is powered on and idle, and then press the **Report Page** button once.

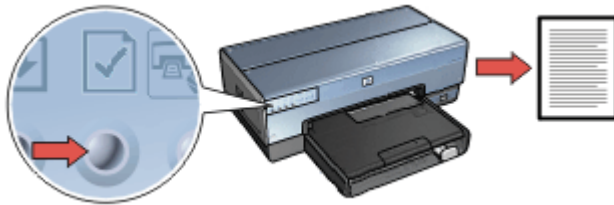

If the printer has just been connected to a network, wait a few minutes before printing the HP Report page to allow the printer to obtain valid settings.

Select the language

The default language for the HP Report page is English. Follow these steps to print the page in another language:

1. Press the **Report Page** button to print the English version of the page.
2. On the lower portion of the page, find the language that you want.
3. To print the page in that language, follow the instructions that correspond to the language.

For example, to print the page in French, press and hold down the **Report Page** button, press the **Resume** button twice, and then release the **Report Page** button.

Understand the HP Report page

The HP Report page lists the following information that you might frequently need to know:

General information

General information applies to both Ethernet and wireless networks:

Item	Meaning
Network Status	The printer's network status: <ul style="list-style-type: none"> ● Ready: The printer is ready to print. ● Offline: The printer is not connected to a network.
Active Connection Type	The type of network the printer is connected to: <ul style="list-style-type: none"> ● Wired: The printer is connected to an Ethernet network. ● Wireless: The printer is connected to a wireless network. ● Disabled: The printer is not connected to a network.
URL	The address to use in order to open the printer's embedded Web server .
Hardware Address (MAC)	The printer's Media Access Control (MAC) address .
Firmware Revision	Revision number of the printer's internal software. This item might be requested by HP Service and Support.
Host Name	The printer's host name on the network.
IP Address	The printer's current IP address on the network.
Subnet Mask	The printer's subnet mask .
Default Gateway	The printer's gateway address.
Configuration Source	How the printer obtained its IP address: <ul style="list-style-type: none"> ● Automatic: AutoIP or DHCP ● Manual: Static IP address
DNS Server	The IP address of the printer's domain name server. Not Specified means that no IP address has been set. This setting does not apply to the printer.
mDNS	The printer's mDNS service name on the network. This name is used by Apple Rendezvous to identify the printer on Mac OS X v10.2.3 and higher.
Admin Password	Indicates whether the printer's embedded Web server is password protected. <ul style="list-style-type: none"> ● Set: A password is required. ● Not Set: A password is not required.
Link Config	The network link configuration: <ul style="list-style-type: none"> ● 802.11 ● 10T-Full ● 10T-Half ● 100TX-Full ● 100TX-Half

802.11 wireless

The 802.11 wireless information applies only to the printer's wireless connection:

Item	Meaning
Wireless Status	<p>The printer's wireless network status:</p> <ul style="list-style-type: none">● Connected: The printer is connected to the wireless network.● Disconnected: The printer is not connected to the wireless network.● Disabled: The wireless radio is off and the printer is connected to an Ethernet network.
Communication Mode	<p>The communication mode to which the printer is configured.</p> <ul style="list-style-type: none">● Infrastructure● Ad hoc
Network Name (SSID)	<p>The SSID setting to which the printer is set.</p>
Signal Strength (1-5 highest)	<p>The strength of the 802.11 radio signal the printer is receiving:</p> <ul style="list-style-type: none">● 1 through 5: 5 indicates an excellent signal; 1 indicates a poor signal.● Not applicable: The printer is set to ad hoc communication mode or the wireless network is disabled.
Channel	<p>One of several pre-set frequencies at which 802.11b-enabled devices communicate in order to reduce interference.</p> <p>The number of channels available varies by country/region.</p> <p>Not applicable means that the wireless network is disabled.</p>
Authentication Type	<p>The printer's authentication setting:</p> <ul style="list-style-type: none">● Open System: No authentication is being used.● Shared Key: The printer is using a WEP key for authentication.● WPA-PSK: Authentication that uses a Pre-Shared Key (PSK). Used as part of WPA for small networks.● None: No authentication is in use.
Encryption	<p>The printer's encryption setting:</p> <ul style="list-style-type: none">● 64-bit WEP: Printer is configured with a five-character or 10-digit WEP key.● 128-bit WEP: Printer is configured with a 13-character or 26-digit WEP key.● AES: An encryption method that can be used with WPA.● TKIP: An encryption method that can be used with WPA.● None: No encryption is being used.
Access Point HW address	<p>The MAC address of the Wireless Access Point (WAP) for the printer's network. This setting applies only to infrastructure</p>

(continued)

Item	Meaning
	networks. Not applicable means that the printer is set to ad hoc communication mode.

Miscellaneous

The Miscellaneous section contains information that applies to both Ethernet and wireless networks and PictBridge connections:

Item	Meaning
Total Packets Transmitted	Number of packets sent without error. This item might be requested by HP Service and Support.
Total Packets Received	Number of packets received without error. This item might be requested by HP Service and Support.
PictBridge Status	<ul style="list-style-type: none"> ● Connected: The printer is connected to a digital camera. ● Error: Something is wrong with the PictBridge connection.
PictBridge Last Error	The last known error to occur in the printer PictBridge function since the printer was last turned on.

Embedded Web server (EWS)

The embedded Web server (EWS) provides a simple way to manage the printer on a network.



Use the printer's EWS to do the following:

- Check the printer's status.
- Adjust the printer's network configuration.
- Check estimated ink levels in the print cartridges.
- View network statistics.
- Configure the printer's [wireless security settings](#).
- Configure [Bluetooth settings](#)
- Visit HP's Web site for support information and to purchase supplies.



Caution It is recommended that the printer and the computers that use it be on the same [subnet](#). Printer installation across subnets can be problematic depending on the type of router used.

Before using the printer's internal Web page, verify that the printer and the computer are powered on and connected to the network.

Open the Embedded Web Server

Follow these steps to open the printer's internal Web page:

1. Launch the Internet browser.
Use Microsoft Internet Explorer 5.0 or higher or Netscape 4.75 or higher.
2. Enter either the printer's **IP address** or **host name** in the browser's address box.



Note If the printer is on a different **subnet** than the computer, enter the printer's IP address (for example: <http://192.168.1.1>) in the browser's address box to open the embedded Web server. Also, if the computer uses a proxy server to access the Internet, you might need to configure the browser to by-pass the proxy server in order to access the EWS.

If you do not know the printer IP address or host name, [print an HP Report page](#).



Caution Use caution when changing the print server's wireless network settings; you can lose the connection. If you lose the connection, you might need to use the new settings to reconnect. If the printer loses its network connection, you might need to reset it to factory defaults and reinstall the software.

Configure Bluetooth settings on a network printer

The following table describes the Bluetooth settings you can configure on the **Networking** tab of the printer's **embedded Web server (EWS)** if the printer is connected to the network either wirelessly or with an Ethernet cable:



Note If your printer is not connected to a network, connect a USB cable from your computer to the rear USB port on the printer and open the printer **Toolbox** to configure the Bluetooth settings.

Parameter	Description
Device Address	The hardware address of the Bluetooth device. Note You cannot change this address.
Device Name	The device name assigned to the printer which can identify it on a Bluetooth device.
Passkey	A 4-digit value that the user must enter in order to print using Bluetooth. The default passkey is 0000.
Visibility	Shows whether or not the printer is visible to other Bluetooth devices that are within range. <ul style="list-style-type: none">● Visible to all: Any Bluetooth device within range can print to the printer.● Not visible: Only Bluetooth devices that have stored the device address of the printer can print to it.

(continued)

Parameter	Description
Security	<p>The level of security set for the printer connected by Bluetooth.</p> <ul style="list-style-type: none"> • High: The printer requires a passkey from the Bluetooth device before allowing the device to send a print job to it. • Low: The printer does not require a passkey. Any Bluetooth device within range can print to it.
Tray Select	<p>Note If the optional 250-Sheet Plain Paper Tray Accessory is not installed, the Tray Select options will not appear.</p> <ul style="list-style-type: none"> • Upper Tray: Selects the upper tray as the paper source. • Lower Tray: Selects the lower tray as the paper source.
Reset Bluetooth	<p>Resets Bluetooth to factory default settings.</p> <ul style="list-style-type: none"> • Yes, reset Bluetooth: Resets Bluetooth to factory default settings. • No: Settings remain as they are.

Reset the printer to the factory default settings

After the printer is configured for a network, its configuration settings are saved in its memory.

Resetting the printer to its factory default settings will clear all the settings from the printer's memory for the network. This should only be done as a last resort when troubleshooting the printer.

Resetting the printer to its factory default settings might require you to reinstall the printer software. Additionally, you will also have to reconfigure the printer's security settings.

The printer's default settings are:

Option	Default setting
Communication Mode	Ad hoc
Network Name (SSID)	hpsetup
Encryption	None
Wireless Radio	Off
EWS Administrator password	[blank]

Follow these steps to reset the printer to the factory default settings:

1. Verify that the printer is powered on.
2. Press and hold down the **Report Page** button.
3. While holding down the **Report Page** button, press the **Cancel** button three times.
4. Release the **Report Page** button.

Networking glossary

numbers

10/100 Base-T: A technical term for Ethernet. 10/100 refers to the speed at which the Ethernet network functions. 10 indicates 10 megabits per second (Mb/s) for normal Ethernet, and 100 indicates 100 Mb/s for Fast Ethernet.

802.11a: A type of wireless networking that provides up to 54 Mb/s transmission in the 5 GHz band.

802.11b: A type of wireless networking that provides up to 11 Mb/s transmission (with a fallback to 5.5, 2 and 1 Mb/s) in the 2.4 GHz band.

802.11g: A type of wireless networking that provides up to 54 Mb/s transmission in the 2.4 GHz band.

a

Ad hoc network: A type of wireless network in which devices directly communicate with each other rather than through a Wireless Access Point (WAP). Ad hoc networks are typically small and simple (for example, two wireless PCs or a wireless PC and a wireless printer). Performance on these types of networks can degrade if more than six devices are on the network. Ad hoc networks are also known as peer-to-peer networks, independent basic service stations (IBSS), or direct-connect wireless networks.

AES: Advanced Encryption Standard (AES) is a U.S. government sponsored encryption method that uses a complex algorithm called "Rijndael." AES uses encryption keys to encode data. AES automatically changes the encryption keys after a certain time interval, thus making the wireless network less vulnerable to eavesdropping.

Authentication: Authentication is a wireless network security strategy. On a network with authentication, devices use a shared key as a password and communicate only with devices that know the key. Authentication does not encrypt the data sent between wireless devices. Authentication can be used in conjunction with WEP. Authentication keys and WEP keys can be identical.

AutoIP: A process by which a device on a network automatically assigns an IP address to itself.

b

BOOTP: Bootstrap Protocol (BOOTP) is an Internet protocol that enables a device to discover its own IP address, the IP address of a BOOTP server on the network, and a file to be loaded into memory to boot the machine. This enables the device to boot without requiring a hard or floppy disk drive.

Broadcast packet: A packet sent from one device on a network to all devices on the network.

c

Channel: One of several pre-set frequencies at which 802.11b-enabled devices communicate in order to reduce interference. The number of channels available varies by country/region.

d

DHCP (Dynamic Host Configuration Protocol): A protocol used to automatically assign an IP address to each device on a network.

e

EAP: Extensible Authentication Protocol (EAP) is a general protocol for authentication that also supports multiple authentication methods, such as token cards, one-time passwords, certificates, and public key authentication. **WPA** uses EAP.

Encryption: A network security that encodes the data sent across a wireless network making the data unintelligible to eavesdroppers. The printer supports **WEP** and **WPA**.

Encryption keys: A sequence of characters or digits that a wireless device uses to encode data. Encryption keys can be static (as they are in **WEP**) or dynamic (as they are in **WPA**).

Ethernet: A popular form of wired computer networking for Local Area Networks.

Ethernet cable: There are two types of Ethernet cables. A straight-through cable is the most common and is used to connect devices on a network to a hub or router. A crossover cable is used to connect two devices that have Ethernet ports but that are not hubs or routers. Use a CAT-5 cable with an RJ-45 plug to connect the printer to an Ethernet network.

f

Firewall: A combination of hardware and software tools that protects a network from unwanted entry.

g

Gateway: A dedicated device (router or computer) that connects two different networks. For example, a computer on an Ethernet network can act as a gateway between the network and the Internet.

h

Host Name: The name by which the printer identifies itself on the network. The printer's host name is displayed on the HP Report page. Use the host name to open the printer's embedded Web server (EWS).

Hub: A simple device that acts as the center of an Ethernet network. Other devices on the network are connected to the hub.

i

ICS (Internet Connection Sharing): A Windows program that allows a computer to act as a gateway between the Internet and a network. ICS uses DHCP to assign IP addresses. For more information about ICS, see the Windows documentation.

Internet Sharing: A Macintosh OSX program that allows a computer to act as a gateway between the Internet and a network. For more information about Internet, see Macintosh documentation.

IP address (Internet Protocol address): A unique number that identifies a device on a network. The IP address is often automatically assigned by DHCP or AutoIP. However, a device can be manually assigned a static IP address.

Infrastructure network: A type of wireless network in which devices communicate with each other through a Wireless Access Point (WAP), such as a wireless network hub, router, or gateway.

j

k

l

LAN (Local Area Network): A high-speed type of computer network that connects devices that are a relatively short distance from one another. An Ethernet network is one type of LAN.

m

MAC address (Media Access Control address): The hardware address for a device on a network. The printer's MAC address is displayed on the HP Report page.

Mb/s (megabits per second): The measure for the rate at which a network functions. For example, 1 Mb/s equals 1,000,000 bits per second (or 125,000 bytes per second).

mDNS: As an alternative to a Domain Name Server, a device issues a Multicast Domain Name Server (mDNS) notification to provide information regarding its service. The notification includes the type of service (such as printing), the name of the service (such as "your printer"), IP and port addresses, and other necessary information. Each device on the network receives the notification and stores the information in a personal DNS server.

n

Network name: A network name is an alphanumeric, case-sensitive character string that provides basic access control to a wireless network. A network name is also known as a "Service Set Identifier (SSID)."

o

p

Packet: A message sent from one device on a network to other devices on the network.

Protocol: A language that devices on a network use to communicate with each other. A popular network protocol is TCP/IP.

q

r

RJ-45: The type of plug at the end of an Ethernet cable.

Router: A complex networking device that directs packets from one network to another network. A router can act as a gateway between a LAN and the Internet.

s

Static IP address: An IP address that is manually assigned to a device on a network. A static IP address remains fixed until changed manually. Alternative methods for assigning IP address are DHCP and AutoIP.

Subnet: A small network that acts as part of a large network. It is recommended that the printer and the computers that use the printer all be on the same subnet.

Subnet mask: A number that identifies the IP addresses that belong to a subnet.

Switch: A network device that manages network traffic in order to minimize collisions and maximize speed.

t

TCP/IP: Transmission Control Protocol/Internet Protocol (TCP/IP) is the network communication protocol used on the Internet. The printer's built-in networking feature supports LANs that use TCP/IP.

TKIP: Temporal Key Integrity Protocol (TKIP) is an encryption method used in [WPA](#).

u

Unicast packet: A packet sent from one device on a network to another device on the network.

v

w

WEP: Wired Equivalent Privacy (WEP) provides security by encrypting data sent over radio waves from one wireless device to another wireless device. WEP encodes the data sent across the network making the data unintelligible to eavesdroppers. Only devices that share the same WEP settings as the printer will be able to communicate with the printer. WEP depends on encryption keys that are static and provides less security than WPA.

WEP key: A WEP key, or encryption key, is a sequence of alphanumeric characters or hexadecimal digits. After creating a WEP key, you must remember it or store it in a secure location. You might not be able to retrieve the WEP key if you lose it. A WEP key is either 64 or 128 bits long. The first 24 bits of the key are provided automatically. When creating the WEP key, the person creating the key provides the remaining bits (40 bits in the case of a 64-bit key, or 104 bits in the case of a 128-bit key).

Wireless Access Point (WAP): A Wireless Access Point (WAP) is a device through which devices (for example, computers and printers) on an infrastructure wireless network communicate with one another. A WAP is also called a base station.

Wireless profile: A wireless profile is a collection of wireless network settings that applies to a particular wireless network. For example, a wireless LAN card can have one

profile for a home network and another profile for an office network. When installing a device on a network, be sure to select the appropriate profile.

Wireless radio: The printer has an internal wireless radio for wireless communication. The wireless radio broadcasts on the 2.4 GHz frequency whenever the wireless radio is powered on and enabled. The Wireless Status light indicates the status of the wireless radio. When the Wireless Status light is on, the wireless radio is on.

WPA: WPA provides security by encrypting data sent over radio waves from one wireless device to another wireless device and by controlling access to network resources through authentication protocols. Only devices that share the same WPA settings as the printer will be able to communicate with the printer. WPA uses encryption keys that change frequently. WPA provides better security than WEP.

x

y

z

Wired Ethernet networking

For setup information, click one of the following options:

- [Ethernet basics](#)
- [What you need for a wired network](#)
- [Install the printer on an Ethernet network](#)

For a description of the printer's Ethernet feature, click one of the following options:

- [Ethernet lights](#)
- [Report Page button](#)
- [Network light](#)
- [Reports page](#)
- [Embedded Web server \(EWS\)](#)

Other information:

- [Resetting the printer to the factory defaults](#)
- [Troubleshooting](#)
- [Glossary](#)

Ethernet basics

The printer's built-in Ethernet feature allows you to connect the printer directly to a [10/100 Base-T](#) Ethernet network without the aid of an external print server.

To install the printer on an Ethernet network, follow the [Ethernet installation instructions](#).

Hardware

Hubs, switches, and routers

On an Ethernet network, devices, such as computers and printers, are each connected to a network [hub](#), [switch](#), or [router](#).

Hubs, switches, and routers can look similar, but there are important differences:

- Hubs are passive. Other devices on the network plug into the hub in order to communicate with one another. A hub does not manage the network.
- A switch allows devices on a network to communicate directly with one another in a smooth and efficient manner. A switch monitors and directs network traffic in order to allow each transmission the most possible bandwidth. By monitoring network traffic, a switch minimizes collisions and maximizes speed.
- Routers primarily connect different networks (for example, connecting a home network to the Internet). Routers are active. Routers have network administration tools, such as [firewalls](#) and [DHCP](#). A router can act as a [gateway](#), while a hub and a switch cannot.

Cables

Use a CAT-5 Ethernet cable to connect the printer to an Ethernet network. Ethernet cables have an RJ-45 plug.

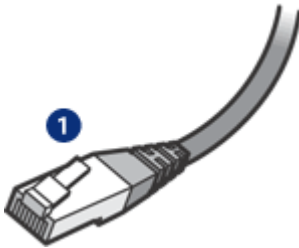

1	RJ-45 plug
---	------------

Network communication

TCP/IP

Devices on a network communicate with one another using a "language" called a [protocol](#). The printer is designed to operate on networks that use a popular protocol called [TCP/IP](#).

IP address

Each device on a network identifies itself with a unique IP address. Most networks use a software tool, such as [DHCP](#) or [AutoIP](#), to automatically assign IP addresses.

Internet connections

Networks might not be connected to the Internet.

If you place the printer on a network connected to the Internet, it is recommended that you use a [gateway](#) so that the printer's [IP address](#) is assigned through [DHCP](#).

A gateway can either be a [router](#) or a Windows computer running [Internet Connection Sharing \(ICS\)](#). For more information about ICS, see the documentation that came with the Windows computer.

Ethernet network examples

To see some examples of Ethernet networks, see the [Ethernet network examples](#) page.

Printing

Computers on the network send print jobs directly to the printer, which prints them in the order received.

The printer can accept print jobs sent simultaneously from four users.

For example, if five users each send a print job to the printer at the same time, the printer accepts four of the print jobs and rejects the fifth. The user who sent the fifth print job should wait a few minutes and then resend the print job.

What you need for a wired network

To connect the printer to a wired network, you need the following:

- A functional Ethernet network that includes an Ethernet router, switch, or a wireless access point with Ethernet ports
- CAT-5 Ethernet cable
Although standard Ethernet cables look similar to standard telephone cables, they are not interchangeable. There is a different number of wires in each one and each has a different connector. An Ethernet cable connector (also called an RJ-45 connector) is wider and thicker and always has eight contacts on the end. A phone connector has between two and six contacts.
- A desktop computer or laptop with either a wired or wireless connection to the router or access point.
- Broadband Internet access (recommended) such as cable or DSL.

Ethernet network examples

These are some common Ethernet network configurations:

Shared Internet connection with a router acting as a gateway



In this example, a **router** manages the network connections and acts as a **gateway** between the network and the Internet.

Shared Internet connection with a PC acting as a gateway



In this example, the network devices are connected to a [hub](#). A computer on the network acts as the [gateway](#) between the network and the Internet. The gateway computer uses [Windows Internet Connection Sharing \(ICS\)](#) to manage the network connections and provide Internet access to the other devices.

DSL or cable Internet connection without a gateway



This example looks similar to the first example. However, in this example, the network devices are connected to a [hub](#), rather than a [router](#). The hub is directly connected to the Internet.

 **Caution** HP does not recommend this configuration. If possible, use a [gateway](#) to manage the network's Internet access in order to limit exposure to viruses and guard against unwanted entry.

Ethernet network without an Internet connection



In this example, the network devices are connected to a [hub](#). Devices use [AutoIP](#) to obtain IP addresses.

Install the printer on an Ethernet network

Installing the printer on an Ethernet network is a two-part process.

First you must connect the printer to the network. Then you must install the printer software on each computer that will use the printer.

- [Connect the printer to an Ethernet network](#)
- [Install the printer software](#)

Connect the printer to an Ethernet network

Follow these steps to connect the printer to an Ethernet network:

1. If necessary, set up the printer hardware.
For printer hardware setup instructions, see the setup poster that came with the printer.
2. Verify that the printer is powered on.
3. Connect the [Ethernet cable](#) to an available port on the network [hub](#) or [router](#).

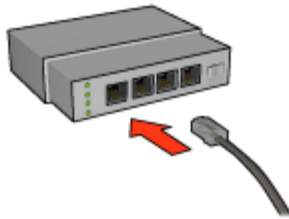

Note Do not plug the Ethernet cable into a port labeled WAN, Uplink, or Internet.

4. Connect the Ethernet cable to the Ethernet port on the back of the printer.



Note The printer's wireless radio is disabled when a Ethernet cable is connected to the printer.

5. Do one of the following:

State of the Link light	Task
On 	Go to step 6.
Off	Repeat steps 2 through 4. If the lights are still off, verify the following items: <ul style="list-style-type: none"> – The printer is powered on. – The network hub or router is powered on. – All cable connections are secure. – You are using an Ethernet cable.

State of the Link light	Task
	

6. [Print an HP Report page.](#)
7. Install the [printer software](#) on each computer that will use the printer.



Caution It is recommended that the printer and the computers that use it be on the same subnet. Printer installation across subnets can be problematic depending on the type of router used.

Install the printer software

Before installing the printer software on a networked computer, verify the following items:

- The printer is set up and powered on.
- The network [hub](#), [switch](#), or [router](#) is powered on and functioning properly.
- All computers on the network are powered on and connected to the network.
- The [printer is installed](#) on the network.

Previous installations

If the printer software was previously installed on the computer, you must use the printer software CD to install an Ethernet version of the printer driver on the computer. Follow the steps below. The printer software installation wizard guides you through the installation process.



Caution It is recommended that the printer and the computers that use it be on the same subnet. Printer installation across subnets can be problematic depending on the type of router used.

Software installation

Follow these steps to install the printer software on the computer:



1. Close all applications running on the computer.
2. Insert the printer software CD in the computer's CD-ROM drive.
3. Follow the onscreen instructions. On the **Connection Type** screen, select **Wired Network**.
4. After the installation has completed, follow the onscreen instructions to print a test page.

Ethernet lights

The printer's Ethernet lights indicate the status of the printer's Ethernet connection.



Link light

The Link light is solid when the printer is connected to an Ethernet network and powered on.

State of the Link light	State of the printer
<p data-bbox="220 197 258 222">On</p> 	<p data-bbox="467 197 1025 222">Connected to an Ethernet network and powered on.</p> <p data-bbox="467 239 1128 293">The printer's wireless radio is disabled when a Ethernet cable is connected to the printer.</p>
<p data-bbox="220 432 258 456">Off</p> 	<p data-bbox="467 432 1047 456">Not connected to an Ethernet network or powered off.</p>

Activity light

The Activity light flashes when the printer is receiving or transmitting data over the Ethernet connection.

State of the Activity light	State of the printer
<p data-bbox="220 900 316 925">Flashing</p> 	<p data-bbox="467 900 1113 925">Receiving or transmitting data over the Ethernet connection.</p>
<p data-bbox="220 1135 258 1159">Off</p> 	<p data-bbox="467 1135 1132 1159">Not receiving or transmitting data over the Ethernet connection.</p>

Bluetooth wireless printing

Use an optional HP Bluetooth Wireless Printer Adapter to print images from most Bluetooth devices to the printer without a cable connection. Simply insert the Bluetooth adapter (also known as a *dongle*) into the front USB port of the printer and print from a Bluetooth device such as a PDA, camera phone, or computer. For more information, see the documentation included with the adapter.

Configure the Bluetooth settings on the printer by using either the printer's embedded web server (EWS) or the printer Toolbox, depending on whether the printer is connected to a network.

The basic procedure for printing from any device with Bluetooth wireless technology is the same:

1. Have the device search for available Bluetooth printers.
2. Select the printer when it is displayed on the device.
3. Send.

Check the documentation that came with the device for detailed instructions.

Connect the HP Bluetooth Wireless Printer Adapter

1. Insert the HP Bluetooth Wireless Printer Adapter into the front USB port of the printer.

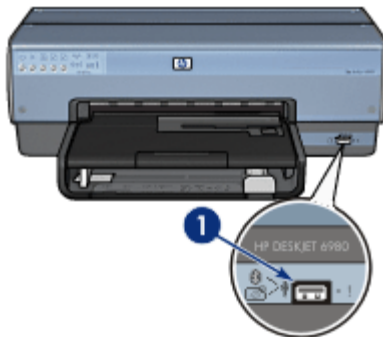

1 | Front USB port

2. Some Bluetooth devices exchange device addresses when they communicate with each other and establish a connection. Also, some Bluetooth devices display the name of the printer when connected.

If the Bluetooth device requires the address of the printer

- a. Print an [HP Report page](#).
The device address of the Bluetooth printer adapter is listed in the Bluetooth settings.
- b. Enter the device address into the Bluetooth device, following the instructions that came with the Bluetooth device.

If the Bluetooth device displays the name of the printer

- Follow the instructions that came with the Bluetooth device to select the printer for printing or to change the name that is displayed for the printer.

Configure Bluetooth settings

The method to configure Bluetooth settings for the printer depends on whether the printer is connected to a network.

If your printer is not connected to a network



Note If your printer is not connected to a network, you will need a USB cable to configure the Bluetooth settings.

1. Connect a USB cable from your computer to the rear USB port on the printer.
2. Open the printer [Toolbox](#).
3. Click the **Configure Bluetooth Settings** tab.
4. Configure the settings you want, and then click **Apply**.

If your printer is connected wirelessly or by Ethernet cable to a network

1. Open the printer's [embedded Web server \(EWS\)](#).
2. Click the **Bluetooth** tab.
3. Configure the settings you want, and then click **Apply**.

The following table describes the Bluetooth settings:

Option	Description
Device Address	The MAC address of your Bluetooth wireless printer adapter.
Device Name	The name assigned to the printer that appears on other Bluetooth devices when they locate the printer. You can enter a new printer name.
Passkey	<p>The 4-digit number you must enter before you can print using Bluetooth. The default passkey is 0000.</p> <p>To change the Passkey</p> <ul style="list-style-type: none">• Toolbox: Click Change Passkey, and then enter a new 4-digit number.• EWS: Enter a new 4-digit number.
Reset Bluetooth	<p>To reset Bluetooth to factory default settings</p> <ul style="list-style-type: none">• Toolbox: Click Reset Device Access.• EWS: Click Yes, reset Bluetooth.
Visibility	<p>To select the printer's visibility to other Bluetooth devices</p> <ul style="list-style-type: none">• Toolbox: Click the Make device visible to other Bluetooth devices check box to allow any Bluetooth device within range to discover and use the printer. If not selected, only sending devices that have stored the printer's Bluetooth device address can discover and use the printer.• EWS: Select one of the following options:<ul style="list-style-type: none">– Visible to All: Any Bluetooth device within range can discover and use the printer.– Not Visible: Only sending devices that have stored the printer's Bluetooth device address can discover and use the printer.

(continued)

Option	Description
Security Level	<p>To set the level of security</p> <p>Select one of the following options:</p> <ul style="list-style-type: none"> • Low: The printer does not require a passkey. Any Bluetooth device within range can print to the printer. • High: The printer requires a passkey from the Bluetooth device before allowing the device to send a print job to it.

HP iPAQ Bluetooth printing

To print a file wirelessly using Bluetooth from the HP iPAQ Pocket PC, complete the following steps:

Step 1: Install Mobile Printing

Install HP Mobile Printing from a desktop computer to the Pocket PC through Microsoft ActiveSync.

1. Save the installer program (**hpmobileprinting.exe**) from www.hp.com/go/pocketpcprint_software to a desktop computer.
2. Connect a Pocket PC to the desktop computer by using the ActiveSync cradle. To properly install this software, the Pocket PC must be in the ActiveSync cradle. If you need help connecting with ActiveSync, see the Pocket PC user guide.
3. Double-click **hpmobileprinting.exe** on the desktop computer. The installer program copies the necessary files to the Pocket PC.

Step 2: Add the printer to the printer list

1. Insert the Bluetooth wireless printer adapter into printer and press the **Report Page** button on the printer to print an HP Report Page.



Note The printer's Bluetooth name by default is **Deskjet 6800 series**.

2. In the iPAQ's HP Mobile Printing program, tap **Tools**, and then tap **Print Config**.
3. Select the **Printers** tab, and then tap **Add**.
4. In the Add Printer screen, select **Network**, and then tap **Next**.
5. In the Add Bluetooth Printer screen, select **Search for a Bluetooth printer near me** to perform a search of the available local Bluetooth devices.
6. After the search has completed, select the printer by its Bluetooth name and tap **Next**.
7. Select a manufacturer and model.
8. As appropriate, select from the following check boxes:
 - **Enable raw file type:** Sends an unprocessed file (such as .PDF) directly to the printer.
 - **Set as default printer:** Sets the current printer the default printer.
9. Tap **Finish**. The Configuration screen is displayed.
10. Tap **OK** on the Configuration screen. The My Printers screen is displayed with the added printer.

Step 3: Print a file



Note See www.hp.com/go/pocketpcprint for supported file types.

1. Open HP Mobile Printing and tap the **File View** icon on the command bar.
2. Do one of the following tasks:
 - **To display the files on the Pocket PC:** Tap the **My Device** icon on the command bar.
 - **To display the files on the network:** Tap the **Network** icon on the command bar, type the path name, and then tap **OK**. You might be prompted to enter a user name and password.
3. Select the file to print.
4. Tap **Print**.
5. Select the printer from the printer list and tap **Print**.

HP iPAQ Wi-Fi printing

To print a file wirelessly from the HP iPAQ Pocket PC, complete the following steps:

Step 1: Install Mobile Printing

Install HP Mobile Printing from a desktop computer to the Pocket PC through Microsoft ActiveSync.

1. Save the installer program (**hpmobileprinting.exe**) from www.hp.com/go/pocketpcprint_software to a desktop computer.
2. Connect a Pocket PC to the desktop computer by using the ActiveSync cradle. To properly install this software, the Pocket PC must be in the ActiveSync cradle. If you need help connecting with ActiveSync, see the Pocket PC user guide.
3. Double-click **hpmobileprinting.exe** on the desktop computer. The installer program copies the necessary files to the Pocket PC.

Step 2: Configure the iPAQ Pocket PC

Before the HP iPAQ Pocket PC can communicate with the printer, configure the iPAQ for a Wi-Fi network. You will need to enter the following settings:

- Network name
- Network type
- Wi-Fi security settings

See the documentation that came with the Wi-Fi PC card for detailed information.

Step 3: Add the printer to the printer list

1. Press the **Report Page** button on the printer to print an HP Report Page.



Note The Report Page should show the printer on the same network as the Pocket PC. See the setup guide for information on changing the printer's wireless network settings, if needed.

2. In the iPAQ's HP Mobile Printing program, tap **Tools**, and then tap **Print Config**.
3. Select the **Printers** tab, and then tap **Add**.

4. In the Add Printer screen, select **Network**, and then tap **Next**.
5. In the Specify Printer screen, select the printer manufacturer and model.
6. Enter the IP address of the printer from the HP Report Page.
7. Enter a unique name for the printer to help with identification.
8. As appropriate, select from the following check boxes:
 - **Enable raw file type**: Sends an unprocessed file (such as .PDF) directly to the printer.
 - **Set as default printer**: Sets the current printer the default printer.
9. Tap **Finish**. The Configuration screen is displayed.
10. Tap **OK** on the Configuration screen. The My Printers screen is displayed with the added printer.

Step 4: Print a file



Note See www.hp.com/go/pocketpcprint for supported file types.

1. Open HP Mobile Printing and tap the **File View** icon on the command bar.
2. Do one of the following tasks:
 - **To display the files on the Pocket PC**: Tap the **My Device** icon on the command bar.
 - **To display the files on the network**: Tap the **Network** icon on the command bar, type the path name, and then tap **OK**. You might be prompted to enter a user name and password.
3. Select the file to print.
4. Tap **Print**.
5. Select the printer from the printer list and tap **Print**.

5 Print photos

The printer software offers several features that make printing digital photos easier and improve photo quality.

Learn how to perform the following tasks:

- Print a [borderless photo](#).
- Print a photo with a [border](#).
- Use [HP Real Life technologies](#) to touch up photos.
- Use the [photo print cartridge](#) for great colors and virtually grain-free photos.
- Use the [gray photo print cartridge](#) for outstanding black-and-white photos.
- Achieve the highest printing resolution with [maximum dpi](#).
- Improve printed colors with the following software options:
 - [Advanced color settings](#)
 - [Color management](#)
- Print an [Exif Print-formatted](#) photo if you have Exif Print-enabled software.
- Prevent photo paper from curling by following the [photo paper storage and handling guidelines](#).
- Use HP Everyday Photo Paper to [save money and ink](#) when printing photos.

Print borderless photos

Use borderless printing to print to the edges of certain paper types and to print on a range of paper sizes—from 3 x 5 inch photo paper to a 210 x 594 mm (8.5 x 23.4 inch) custom photo size.

Guidelines

- For high-quality results, use a [photo print cartridge](#) in combination with the tri-color print cartridge.
- Do not print borderless photos in [ink-backup mode](#). Always have two print cartridges installed in the printer.
- Open the file in a software program such as HP Photosmart Software or Adobe Photoshop and assign the photo size. Ensure that the size corresponds to the paper size on which you want to print the photo.
- If you installed HP Photosmart Software, you can use it to stitch together panoramic digital photos before printing them.
- For maximum fade resistance, use HP Premium Plus Photo Paper.
- Verify that the photo paper that you are using is flat. For information about preventing photo paper from curling, see the [photo paper storage instructions](#).
- Do not exceed the In tray capacity: 25 sheets of photo paper.

Prepare to print

To print a single small photo, use the [photo/envelope feeder](#).

To print larger or multiple photos, follow these steps:

1. Verify that the printer is turned on.
2. For small photos, remove the Out tray. For large photos, raise the Out tray. Remove all of the paper from the In tray.
3. Slide the paper-width guide all the way to the left, and then pull out the paper-length guide.
4. Verify that the photo paper is flat.
5. Place the photo paper in the In tray, with the side to be printed on facing down. If you are using photo paper with a tear-off tab, verify that the tab is pointing away from the printer.
6. Slide the paper guides firmly against the paper.

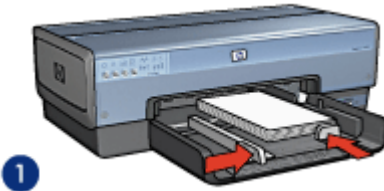

1

1 | Small photos

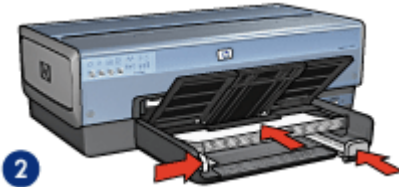

2

2 | Large photos



Note Some panoramic paper sizes might extend beyond the edge of the In tray.

7. For small photos, replace the Out tray. For large photos, lower the Out tray.

Print



Note If the software program includes a photo printing feature, follow the instructions that are provided with the software program. Otherwise, follow these instructions.

1. Open the photo in an application that allows editing, such as HP Photosmart Software or Adobe Photoshop.
2. Open the [Printer Properties](#) dialog box.
3. Click the **Printing Shortcuts** tab.

4. In the **What do you want to do?** drop-down list, click **Photo Printing-Borderless**, and then select the following options:
 - **Print Quality: Normal** or **Best**.



Note For maximum dpi quality, go to the **Paper/Quality** tab, and then click **Maximum dpi** in the **Print Quality** drop-down list.

- **Paper Type:** An appropriate photo paper type
 - **Paper Size:** An appropriate borderless photo paper size
 - **Orientation: Portrait** or **Landscape**
5. Set the [HP Real Life technologies](#) as appropriate.
 6. Click **OK** to print the photo.
If you printed on photo paper with a tear-off tab, remove the tab to make the document completely borderless.

Use the [What's This? help](#) to learn about the features that appear in the Printer Properties dialog box.

Print photos with a border

Follow these instructions to print photos with a white border.

Guidelines

- For high-quality results, use a [photo print cartridge](#) in combination with the tri-color print cartridge.
- For maximum fade resistance, use HP Premium Plus Photo Paper.
- Open the file in a software program such as HP Photosmart Software or Adobe Photoshop and assign the photo size. Ensure that the size corresponds to the paper size on which you want to print the photo.
- If you installed HP Photosmart Software, you can use it to stitch together panoramic digital photos before printing them.
- Verify that the photo paper that you are using is flat. For information about preventing photo paper from curling, see the [photo paper storage instructions](#).
- Do not exceed the In tray capacity: 25 sheets of photo paper.

Prepare to print

To print a single small photo, use the [photo/envelope feeder](#).

To print larger or multiple photos, follow these steps:

1. Verify that the printer is turned on.
2. For small photos, remove the Out tray. For large photos, raise the Out tray. Remove all of the paper from the In tray.
3. Slide the paper-width guide all the way to the left, and then pull out the paper-length guide.
4. Verify that the photo paper is flat.
5. Place the photo paper in the In tray with the side to be printed on facing down.
6. Slide the paper guides firmly against the paper.

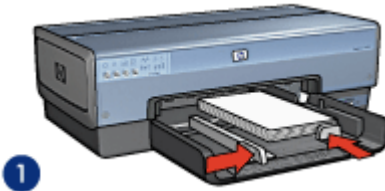

1 | Small photos

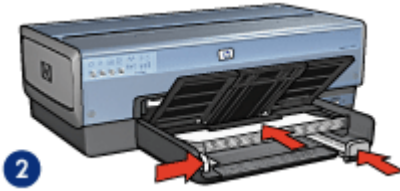

2 | Large photos



Note Some panoramic paper sizes might extend beyond the edge of the In tray.

- For small photos, replace the Out tray. For large photos, lower the Out tray.

Print



Note If the software program includes a photo printing feature, follow the instructions that are provided with the software program. Otherwise, follow these instructions.

- Open the photo in an application that allows editing, such as HP Photosmart Software or Adobe Photoshop.
- Open the [Printer Properties](#) dialog box.
- Click the **Printing Shortcuts** tab.
- In the **What do you want to do?** drop-down list, click **Photo printing-with white borders**, and then select the following options:

- **Print Quality: Normal or Best**



Note For maximum dpi quality, go to the **Paper/Quality** tab, and then click **Maximum dpi** in the **Print Quality** drop-down list.

- **Paper Type:** An appropriate photo paper type
 - **Paper Size:** An appropriate photo paper size
 - **Orientation: Portrait or Landscape**
- Set the [HP Real Life technologies](#) as appropriate.
 - Click **OK** to print the photo.

Use the [What's This? help](#) to learn about the features that appear in the Printer Properties dialog box.

HP Real Life technologies

HP Real Life technologies make it easy for you to get better photos. Automatic red-eye removal and adaptive lighting to enhance detail in shadows are just a few of the technologies included.

Open HP Real Life technologies

Follow these steps to open the HP Real Life technologies dialog box:

1. Open the [Printer Properties](#) dialog box.
2. Click the **Paper/Quality** tab, and then click the **Real Life Digital Photography** button.

Use HP Real Life technologies

Use the HP Real Life technologies dialog box to set these options:

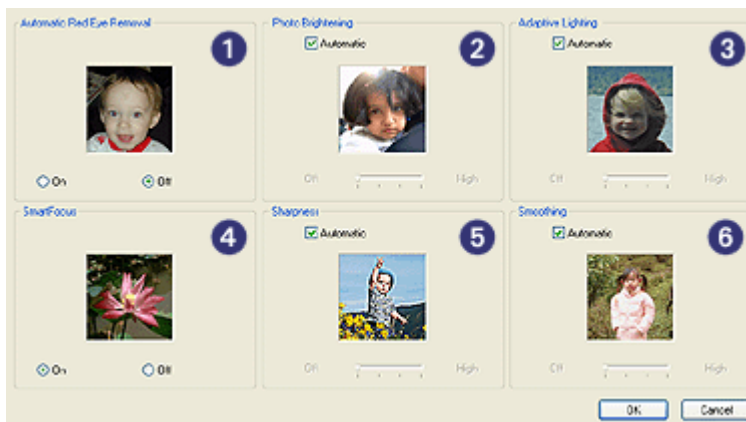

1. **Automatic Red-Eye Removal:** Click **On** to automatically remove or reduce red-eye in the photo.
2. **Photo Brightening:** Automatically enhance colors and contrast for washed-out photos. Click **Automatic** to allow the printer software to intelligently brighten the photo, focusing only on areas that need adjustment.
3. **Adaptive Lighting:** Adjust the exposure in dark areas of photos to bring out detail. Click **Automatic** to allow the printer software to balance lightness and darkness automatically.
4. **SmartFocus:** Enhance the image quality and clarity of low resolution images such as those downloaded from the Internet. Click **On** to allow the printer software to sharpen details in the image automatically.
5. **Sharpness:** Adjust the image sharpness to your preference. Click **Automatic** to allow the printer software to set the level of sharpening for the image automatically.
6. **Smoothing:** Soften an image. Click **Automatic** to allow the printer software to set the level of smoothing for the image automatically.



Note If you installed HP Photosmart Software, you can use it to edit and further enhance digital photos.

Photo print cartridge

The photo print cartridge, when used in conjunction with the tri-color print cartridge, provides virtually grain-free photos. It offers exceptional fade resistance for photos that are printed on HP Premium Plus Photo Paper.



The photo print cartridge can be purchased separately if it is not included with the printer.

Install the photo print cartridge

To install the photo print cartridge, remove the black print cartridge from the printer, and then **install** the photo print cartridge in the right side of the print cartridge cradle.



Note To protect a print cartridge when it is not in the printer, follow these [storage guidelines](#).

Use the photo print cartridge

1. Open the [Printer Properties](#) dialog box.
2. Click the **Printing Shortcuts** tab.
3. In the **What do you want to do?** drop-down list, click either **Photo Printing-borderless** or **Photo Printing-with white borders**.
4. In the **Print Quality** drop-down list, click **Normal** or **Best**.



Note For maximum dpi quality, on the **Paper/Quality** tab, click **Maximum dpi** in the **Print Quality** drop-down list.

5. In the **Paper Type** drop-down list, click the appropriate photo paper type.
6. Select any other print settings that you want, and then click **OK**.

Store the photo print cartridge

Follow these [guidelines](#) when storing the photo print cartridge.

Maximum dpi

The maximum dpi print quality setting offers 4800 x 1200 optimized dots per inch (dpi) printing.

The 4800 x 1200 optimized dpi is the highest quality resolution for this printer. When 4800 x 1200 optimized dpi is selected in the printer software, the tri-color print cartridge

prints in the 4800 x 1200 optimized dpi mode (up to 4800 x 1200 optimized dpi color and 1200-input dpi).

If a [photo print cartridge](#) is also installed, the print quality is enhanced. A photo print cartridge can be purchased separately if it is not included with the printer.



Note Using maximum dpi increases the printing time and requires a large amount of disk space.

Follow these steps to print in the 4800 x 1200 optimized dpi mode:

1. Open the [Printer Properties](#) dialog box.
2. Click the **Paper/Quality** tab.
3. In the **Type is** drop-down list, click **More**, and then select the appropriate photo paper type.
4. In the **Print Quality** drop-down list, click **Maximum dpi**.
5. Select any other print settings that you want, and then click **OK**.



Note Use an HP premium photo paper when printing in the maximum dpi mode to enhance color matching and detail in the photo.

Advanced color settings

Use the Advanced color settings dialog box to adjust how printed colors appear in the photos.

Adjusting these settings causes the printed colors to differ from the colors that appear on the computer monitor.

To specify advanced color settings, follow these steps:

1. Open the [Printer Properties](#) dialog box.
2. Click the **Color** tab, and then click the **Advanced Color Settings** button.
The Advanced Color Settings dialog box is displayed.

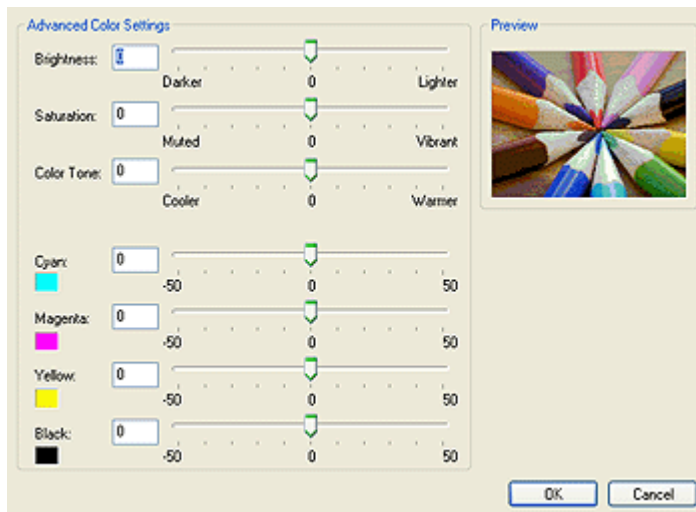

3. You can adjust the following settings:
 - **Advanced color settings:** Adjust the **Saturation**, **Brightness**, and **Color Tone** to affect how overall colors are printed.
 - **Specific color settings:** Adjust the **Cyan**, **Magenta**, **Yellow**, and **Black** sliders to specify the level of each color that is used in printing.



Note When you adjust color settings, the changes are reflected in the Preview box.

4. After specifying the color settings, click **OK**.
5. Select any other print settings that you want, and then click **OK**.

Color management

Color management defines the range of colors that can be printed. The printer software translates the colors of the photo from the current color settings to the color management option that is selected.

Follow these steps to select a color management option:

1. Open the [Printer Properties](#) dialog box.
2. Click the **Color** tab.

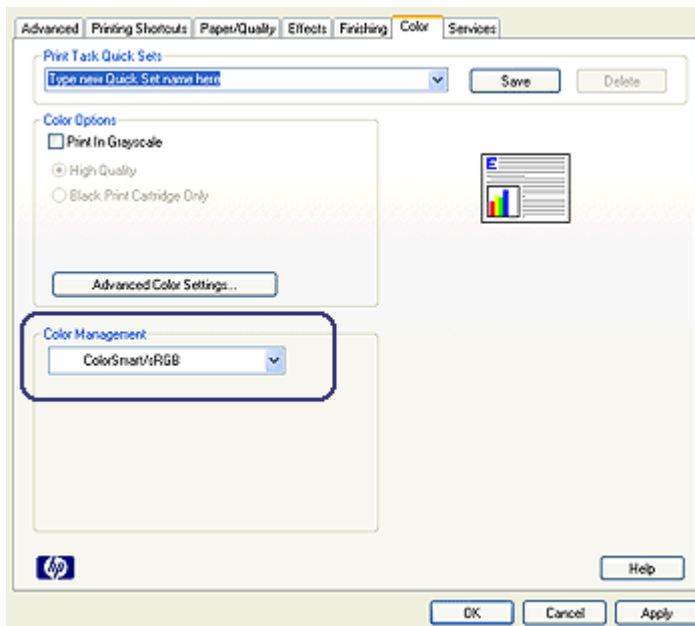

3. Click one of the following options in the **Color Management** drop-down list:
 - **ColorSmart/sRGB:** ColorSmart/sRGB is an appropriate option for most print jobs. It is used for most Web-based documents and current imaging devices.
 - **AdobeRGB:** When using AdobeRGB to print from a professional software program, turn off the color management in the program and allow the printer

- software to manage the color space. Use the AdobeRGB setting for photos that were originally created in the AdobeRGB color space.
- **Managed by Application:** Use this option to allow the program from which you are printing to manage the color of the photo.
 - **ICM (Image Color Management):** ICM is a Microsoft technology that helps ensure that a color image, graphic or text object is printed as close as possible to its original color and helps keep its colors consistent and accurate.
4. Select any other print settings that you want, and then click **OK**.

Gray photo print cartridge

The gray photo print cartridge, used in conjunction with the tri-color print cartridge, prints high-quality black-and-white photographs.

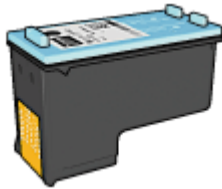

The gray photo print cartridge can be purchased separately if it is not included with the product.

Install the gray photo print cartridge

To install the gray photo print cartridge, remove the black print cartridge from the printer, and then install the gray photo print cartridge in the compartment on the right of the print cartridge cradle.

For more information, see the [print cartridge installation page](#).

Use the gray photo print cartridge

To use the gray photo print cartridge, follow the steps to [print a black-and-white photo](#).

Store the gray photo print cartridge

To maintain the health of the print cartridge, follow the [print cartridge storage guidelines](#).

Exif Print

Exif Print (Exchangeable Image File Format 2.2) is an international digital imaging standard that simplifies digital photography and enhances printed photos. When a photo is taken with an Exif Print-enabled digital camera, Exif Print captures information such as exposure time, type of flash, and color saturation, and stores it in the image file. The HP Deskjet printer software then uses this information to automatically perform image-specific enhancements to create outstanding photos.

To print Exif Print-enhanced photos, you must have the following items:

- A digital camera that supports Exif Print
- Exif Print-enabled photo software

Follow these steps to print Exif Print-enhanced photos:

1. Open the photo in an application that allows editing, such as HP Photosmart Software or Adobe Photoshop.
2. Open the [Printer Properties](#) dialog box.
3. Click the **Paper/Quality** tab.
4. In the **Type is** drop-down list, click **More**, and then select the appropriate photo paper type.
5. In the **Print Quality** drop-down list, click **Normal**, **Best**, or **Maximum dpi**.
6. Select any other print settings that you want, and then click **OK**.

The printer software automatically optimizes the printed image.

Store and handle photo paper

Follow these instructions to maintain the quality of HP brand photo paper.

Storage

- Keep unused photo paper in a plastic bag. Store the packaged photo paper on a flat surface in a cool place.
- When you are ready to print, remove only the paper that you plan to use immediately from the plastic bag. When you have finished printing, return any unused photo paper to the plastic bag.
- Do not leave unused photo paper in the paper tray. The paper might start to curl, which can reduce the quality of the photos.

Handling

- Always hold photo paper by its edges. Fingerprints on photo paper can reduce print quality.
- If the corners of the photo paper curl more than 10 mm (0.4 inch), flatten the paper by putting it in the storage bag, and then gently bending it in the opposite direction of the curl until the paper lies flat.

Photo paper should be flat before it is printed on.

Save money when printing photos

To save money and ink when printing photos, use HP Everyday Photo Paper and set the [print quality](#) to **Normal**.

HP Everyday Photo Paper is designed to create quality photos with less ink.



Note For higher-quality photos, use HP Premium Plus Photo Paper and set the print quality to **Best** or [Maximum dpi](#).

Other photo projects

HP Photosmart Software coordinates the functions of HP imaging devices: scanners, cameras, printers, and all-in-one devices. Depending on the devices you have installed and their capabilities, you can quickly and easily organize, edit, and share digital images.

Organize, edit, and share digital images in creative ways

If you performed the default typical installation of the printer software, you also installed HP Photosmart Software. Use HP Photosmart Software to easily:

- Print photos and digital images
- Transfer images from a camera or memory card
- View images as a slide show
- Edit images
- Create photo album pages and flyers
- Share photos with friends and family

Share photos with friends and family

If you performed the default typical installation of the printer software, you also installed HP Photosmart Software. If you have installed HP Photosmart Software, see the HP Photosmart Software help to learn about how you can use the software to easily select and share images by e-mail without the use of large file attachments.

6 Print photos from a digital camera

Learn how to print photos directly from a digital camera.

- Use a PictBridge camera
- Use a Bluetooth camera phone

Use a PictBridge camera

With a PictBridge-enabled camera, you do not need a computer to print digital photographs. Just plug the camera into the printer's front USB port.



Note Other than PictBridge-compatible cameras and Bluetooth dongles, do not plug other USB devices into the front USB port.

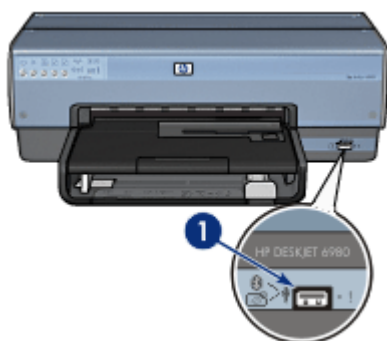

1 Front USB port



Note When two PictBridge devices communicate, they provide only the services that they have in common. For example, some cameras might allow photos formatted as either TIFFs or JPEGs to be printed over a PictBridge connection, but, since the printer does not support TIFFs over a PictBridge connection, only JPEGs can be printed.

When a PictBridge-enabled camera is connected to the front USB port, the default printer settings will print a 4 x 6 inch borderless photo with portrait orientation. For detailed information on printing from the camera, see the documentation that came with the camera.

PictBridge printing

In order to print photos directly from a digital camera, you need the following items:

- A PictBridge-compatible camera
- A digital camera USB cable



Check the documentation that came with the camera to ensure that the camera supports PictBridge.

Follow these steps to print photos from a PictBridge-compatible camera:

1. Verify that the printer is turned on.
2. For small photos, remove the Out tray. For large photos, raise the Out tray. Remove all of the paper from the In tray.
3. Slide the paper-width guide all the way to the left, and then pull out the paper-length guide.
4. Place the photo paper in the In tray, with the side to be printed on facing down.
5. Slide the paper guides firmly against the paper.
6. Connect the camera to the front USB port on the printer using the USB cable supplied with the camera.
7. Turn on the camera, and then set it to PictBridge mode.

If you do not know how to set the camera to PictBridge mode, see the documentation that came with the camera.



Note When the camera is connected correctly, the Connection light is illuminated. The Connection light blinks green when printing from the camera. If the camera is not PictBridge-compatible or is not in PictBridge mode, the Error light flashes.

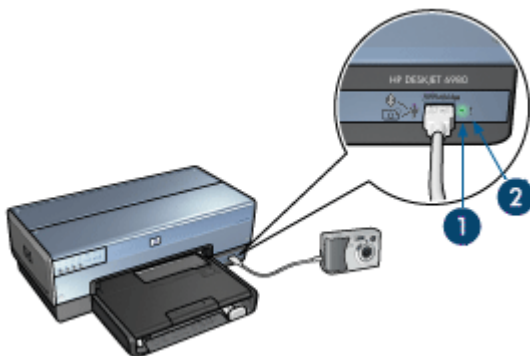

1	Connection light
2	Error light

After you successfully connect the camera to the printer, you can print the photos. Be sure the size of the paper loaded in the printer matches the setting on the camera. See the documentation that came with the camera for detailed information on printing from the camera.

Use a Bluetooth camera phone

If you have a camera phone with Bluetooth wireless technology, you can purchase an [optional HP Bluetooth Wireless Printer Adapter](#) and print from the camera phone using a Bluetooth wireless connection.

Print photos from a Bluetooth camera phone

1. Verify that the printer is turned on.
2. For small photos, remove the Out tray. For large photos, raise the Out tray. Remove all of the paper from the In tray.
3. Slide the paper-width guide all the way to the left, and then pull out the paper-length guide.
4. Place the photo paper in the In tray, with the side to be printed on facing down.
5. Slide the paper guides firmly against the paper.
6. Insert the HP Bluetooth Wireless Printer Adapter into the front USB port of the printer. If you are using photo paper with a tear-off tab, verify that the tab is pointing away from the printer.

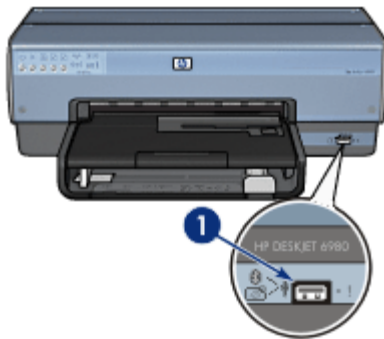

1 Front USB port

The light on the adapter indicates its status:

Display	Description
Double-blinking once a second	The device is installed and has power.
Rapid blinking	A sending device is discovering the HP wireless printer adapter.
On steady	The HP wireless printer adapter is receiving data.

7. Follow the instructions in the documentation that came with the digital camera to send photos to the printer.

7 Print other documents



E-mail



Letters



Documents



Envelopes



Brochures



Greeting cards



Postcards



Transparencies



Labels



Index cards



Booklets



Posters



Banners



Iron-on transfers



CD tattoos

Printing tips: Minimize the cost and effort while maximizing the quality of the printouts with [printing tips](#).

Printer software: Learn about the [printer software](#).

E-mail

Guidelines

Do not exceed the In tray capacity: 150 sheets of plain paper.

Prepare to print

1. Verify that the printer is turned on.
2. Raise the Out tray.
3. Slide the paper-width guide all the way to the left, and then pull out the paper-length guide.
4. Place plain paper in the In tray, pushing the paper into the printer until it stops.
5. Slide the paper guides firmly against the paper.

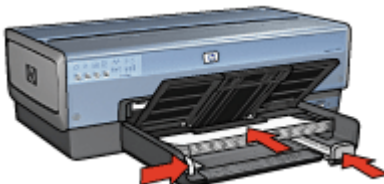

6. Lower the Out tray.

Print

1. Open the [Printer Properties](#) dialog box.
2. Click the **Printing Shortcuts** tab.
3. In the **What do you want to do?** drop-down list, click **General Everyday Printing** or **Fast/Economical Printing**, and then specify the following print settings:
 - **Paper Type:** **Automatic** or **Plain paper**
 - **Paper Size:** An appropriate paper size
4. Select the following print settings as appropriate:
 - [Print Quality](#)
 - [Paper Source](#)
 - [Print In Grayscale](#)
5. Select any other print settings that you want, and then click **OK**.

Use the [What's This? help](#) to learn about the features that appear in the Printer Properties dialog box.

Letters

Guidelines

- Learn how to add a [watermark](#) to the letter.
- For help printing on an envelope, see [envelopes](#).
- Do not exceed the In tray capacity: 150 sheets of paper.

Prepare to print

1. Verify that the printer is turned on.
2. Raise the Out tray.
3. Slide the paper-width guide all the way to the left, and then pull out the paper-length guide.
4. Place the paper in the In tray, pushing the paper into the printer until it stops.



Note If you are using letterhead paper, verify that the letterhead is facing down and toward the interior of the printer.

5. Slide the paper guides firmly against the paper.

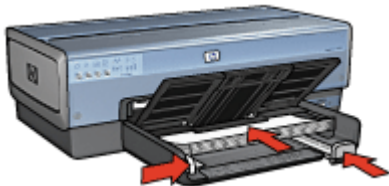

6. Lower the Out tray.
Do not extend the Out-tray extension stop when printing on legal paper.

Print

1. Open the [Printer Properties](#) dialog box.
2. Click the **Printing Shortcuts** tab.
3. In the **What do you want to do?** drop-down list, click **Presentation Printing**, and then specify the following print settings:
 - **Paper Type:** **Automatic** or **Plain paper**
 - **Paper Size:** An appropriate paper size
4. Select the following print settings as appropriate:
 - [Print Quality](#)
 - [Paper Source](#)
5. Select any other print settings that you want, and then click **OK**.

Use the [What's This? help](#) to learn about the features that appear in the Printer Properties dialog box.

Documents

Guidelines

- For draft documents, use [Fast/economical printing](#).
- Save paper with [two-sided printing](#).
- Learn how to add a [watermark](#) to the document.
- Do not exceed the In tray capacity: 150 sheets of paper.

Prepare to print

1. Verify that the printer is turned on.
2. Raise the Out tray.
3. Slide the paper-width guide all the way to the left, and then pull out the paper-length guide.
4. Place plain paper in the In tray, pushing the paper into the printer until it stops.
5. Slide the paper guides firmly against the paper.

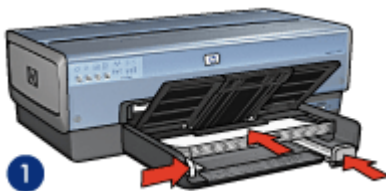

1	Letter or A4 paper
---	--------------------

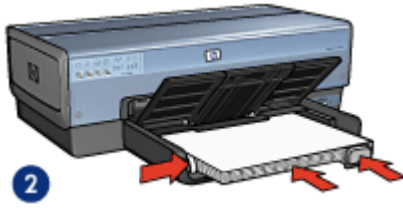

2 | Legal paper (extends over the edge of the In tray)

6. Lower the Out tray.
Do not extend the Out-tray extension stop when printing on legal paper.

Print

1. Open the [Printer Properties](#) box.
2. Click the **Printing Shortcuts** tab.
3. In the **What do you want to do?** drop-down list, click **General Everyday Printing** or **Presentation Printing**, and then specify the following print settings:
 - **Paper Type:** **Automatic** or **Plain paper**
 - **Paper Size:** An appropriate paper size
4. Select the following print settings:
 - [Print Quality](#)
 - [Paper Source](#)
 - [Print On Both Sides](#) if you want to print on both sides of the paper
5. Select any other print settings that you want, and then click **OK**.

Use the [What's This? help](#) to learn about the features that appear in the Printer Properties dialog box.

Envelopes

Guidelines

- Avoid using envelopes that have the following features:
 - Clasps or windows
 - Thick, irregular, or curled edges
 - Shiny or embossed coatings
 - Wrinkles, tears, or other damage
- Align the envelope edges before inserting the envelopes in the In tray.
- Do not exceed the In tray capacity: 20 envelopes.

Prepare to print

To print a single envelope, use the [photo/envelope feeder](#).

To print multiple envelopes, follow these steps:

1. Verify that the printer is turned on.
2. Remove the Out tray, and then remove all paper from the In tray.

3. Slide the paper-width guide all the way to the left, and then pull out the paper-length guide.
4. Place the envelopes in the In tray, as far to the right as possible.
The side to be printed on should face down and the flap should be on the left.
5. Push the envelopes into the printer until they stop.
6. Slide the paper guides firmly against the envelopes.

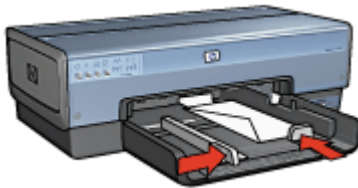

7. Replace the Out tray.

Print

1. Open the [Printer Properties](#) dialog box.
2. Click the **Paper/Quality** tab, and then select the following print settings:
 - **Size is:** An appropriate envelope size
 - **Type is:** **Automatic** or **Plain paper**
3. Select any other print settings that you want, and then click **OK**.

Use the [What's This? help](#) to learn about the features that appear in the Printer Properties dialog box.

Brochures

Guidelines

- Do not print borderless documents in [ink-backup mode](#). Always have two print cartridges installed in the printer.
- Open the file in a software program and assign the brochure size. Ensure that the size corresponds to the paper size on which you want to print the brochure.
- Do not exceed the In tray capacity: 25 sheets of brochure paper.

Prepare to print

1. Verify that the printer is turned on.
2. Raise the Out tray.
3. Slide the paper-width guide all the way to the left, and then pull out the paper-length guide.
4. Place brochure paper in the In tray, pushing the paper into the printer until it stops.
5. Slide the paper guides firmly against the paper.

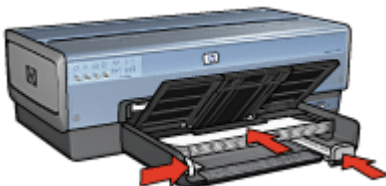

6. Lower the Out tray.

Print borderless brochures

1. Open the [Printer Properties](#) dialog box.
2. Click the **Paper/Quality** tab, and then specify the following print settings:
 - **Size is:** An appropriate paper size
 - **Type is:** Click **More**, and then select an appropriate brochure paper or other paper type.
Do not select **Automatic**.



Note Not all paper sizes and types are available for borderless printing.

3. Select the **Borderless Printing** check box.
4. Set the print quality to **Best**.
5. Click the **Finishing** tab, set the orientation, and then select **Print on both sides** to print on both sides of the paper.
For more information, see [Two-sided printing](#).
6. Click **OK** to print.

Use the [What's This? help](#) to learn about the features that appear in the Printer Properties dialog box.

Print brochures with borders

1. Open the [Printer Properties](#) dialog box.
2. Click the **Printing Shortcuts** tab.
3. In the **What do you want to do?** drop-down list, click **Presentation Printing**, and then specify the following print settings:
 - **Paper Type:** An appropriate brochure paper.
Do not select **Automatic**.
 - **Paper Size:** An appropriate paper size
4. Select the following print settings as appropriate:
 - [Print Quality](#)
 - [Print In Grayscale](#)
 - [Print On Both Sides](#)
5. Select any other print settings that you want, and then click **OK**.

Use the [What's This? help](#) to learn about the features that appear in the Printer Properties dialog box.

Greeting cards

Guidelines

- Unfold prefolded cards, and then place them in the In tray.
- Do not exceed the In tray capacity: 30 cards.

Prepare to print

1. Verify that the printer is turned on.
2. Raise the Out tray, and then remove all paper from the In tray.
3. Slide the paper-width guide all the way to the left, and then pull out the paper-length guide.
4. Fan the edges of the greeting cards to separate them, and then align the edges.
5. Place the greeting cards in the In tray, with the side to be printed on facing down.
6. Push the cards into the printer until they stop.
7. Slide the paper guides firmly against the paper.

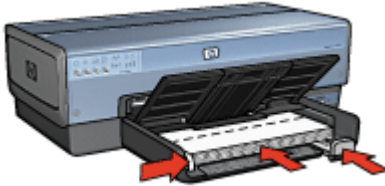

8. Lower the Out tray.

Print



Note If the software program includes a greeting card printing feature, follow the instructions that are provided with the software program. Otherwise, follow the instructions below.

1. Open the [Printer Properties](#) dialog box.
2. Click the **Paper/Quality** tab, and then specify the following print settings.
 - **Size is:** An appropriate card size
 - **Source is: Upper tray**
 - **Type is:** Click **More**, and then select an appropriate card type.
 - **Print Quality: Normal**
3. Select any other print settings that you want, and then click **OK**.

Use the [What's This? help](#) to learn about the features that appear in the Printer Properties dialog box.

Postcards



If the optional Auto Two-Sided Print Accessory with Small Paper Tray is attached to the printer, follow the [steps for printing postcards with the Auto Two-Sided Print Accessory with Small Paper Tray](#).

Guidelines

- Use only cards that meet the paper size specifications for the printer. For specifications, see the reference guide that came with the printer.
- Do not exceed the In tray capacity: 60 cards.

Prepare to print

To print a single card, use the [photo/envelope feeder](#).

To print multiple cards, follow these steps:

1. Verify that the printer is turned on.
2. Remove the Out tray, and then remove all paper from the In tray.
3. Slide the paper-width guide all the way to the left, and then pull out the paper-length guide.
4. Place the cards in the In tray, as far to the right as possible.
The side to be printed on should face down and the short edge should point toward the printer.
5. Push the cards into the printer until they stop.
6. Slide the paper guides firmly against the edge of the cards.

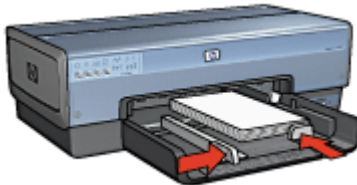

7. Replace the Out tray.

Print

1. Open the [Printer Properties](#) dialog box.
2. Click the **Paper/Quality** tab, and then specify the following print settings:
 - **Size is:** An appropriate card size
 - **Type is:** **Automatic** or click **More**, and then select an appropriate card type
 - **Source is:** **Upper tray**
 - **Print Quality:** **Normal** or **Best**
3. Select any other print settings that you want, and then click **OK**.

Use the [What's This? help](#) to learn about the features that appear in the Printer Properties dialog box.

Transparencies

Guidelines

Do not exceed the In tray capacity: 30 transparencies.

Prepare to print

1. Verify that the printer is turned on.
2. Raise the Out tray, and then remove all paper from the In tray.
3. Slide the paper-width guide all the way to the left, and then pull out the paper-length guide.
4. Place the transparencies in the In tray.
The side to be printed on should face down and the adhesive strip should face up and toward the printer.

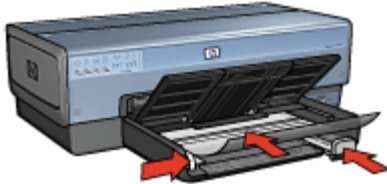

5. Carefully push the transparencies into the printer until they stop, so that none of the adhesive strips catch on one another.
6. Slide the paper guides firmly against the transparencies.
7. Lower the Out tray.

Print

1. Open the [Printer Properties](#) dialog box.
2. Click the **Printing Shortcuts** tab.
3. In the **What do you want to do?** drop-down list, click **Presentation Printing**, and then specify the following print settings:
 - **Paper Type:** **Automatic** or click **More**, and then select an appropriate transparency film.
 - **Paper Size:** An appropriate paper size
 - **Paper Source:** **Upper Tray**
4. Select the following print settings as appropriate:
 - [Print Quality](#)
 - [Print In Grayscale](#)
5. Select any other print settings that you want, and then click **OK**.

Use the [What's This? help](#) to learn about the features that appear on the Printer Properties dialog box.

Labels

Guidelines

- Use only paper, plastic, or clear labels that are designed specifically for inkjet printers.
- Use only full sheets of labels.

- Avoid using labels that are sticky, wrinkled, or pulling away from the protective backing.
- Do not exceed the In tray capacity: 30 sheets of labels (use only Letter or A4-size sheets).

Prepare to print

1. Verify that the printer is turned on.
2. Raise the Out tray, and then remove all paper from the In tray.
3. Slide the paper-width guide all the way to the left, and then pull out the paper-length guide.
4. Fan the edges of the label sheets to separate them, and then align the edges.
5. Place the label sheets in the In tray with the label side facing down.
6. Push the sheets into the printer until they stop.
7. Slide the paper guides firmly against the sheets.

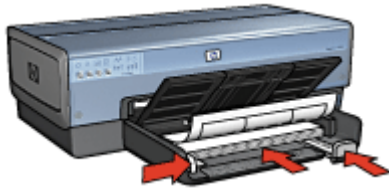

8. Lower the Out tray.

Print



Note If the software program includes a label printing feature, follow the instructions that are provided with the software program. Otherwise, follow the instructions below.

1. Open the [Printer Properties](#) dialog box.
2. Click the **Printing Shortcuts** tab.
3. In the **What do you want to do?** drop-down list, click **General Everyday Printing**, and then specify the following print settings:
 - **Paper Type:** **Automatic** or **Plain paper**
 - **Paper Size:** An appropriate paper size
 - **Paper Source:** **Upper Tray**
4. Select the following print settings as appropriate:
 - [Print Quality](#)
 - [Print In Grayscale](#)
5. Select any other print settings that you want, and then click **OK**.

Use the [What's This help](#) to learn about the features that appear in the Printer Properties dialog box.

Index cards and other small media



If the optional Auto Two-Sided Print Accessory with Small Paper Tray is attached to the printer, follow the small media printing steps for the [Auto Two-Sided Print Accessory with Small Paper Tray](#).

Guidelines

- Use only cards and small media that meet the paper size specifications for the printer. For specifications, see the reference guide that came with the printer.
- Do not exceed the In tray capacity: 60 cards.

Prepare to print

1. Verify that the printer is turned on.
2. Remove the Out tray, and then remove all paper from the In tray.
3. Slide the paper-width guide all the way to the left, and then pull out the paper-length guide.
4. Place the cards in the In tray, as far to the right as possible.
The side to be printed on should face down and the short edge should point toward the printer.
5. Push the cards into the printer until they stop.
6. Slide the paper guides firmly against the cards.

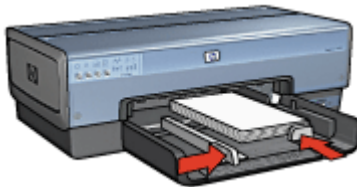

7. Replace the Out tray.

Print

1. Open the [Printer Properties](#) dialog box.
2. Click the **Paper/Quality** tab, and then specify the following print settings:
 - **Size is:** An appropriate card size
 - **Type is:** Click **More**, and then select an appropriate card type.
 - **Source is:** **Upper tray**
3. Select any other print settings that you want, and then click **OK**.

Use the [What's This? help](#) to learn about the features that appear on the Printer Properties dialog box.

Booklets

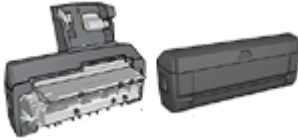

If an optional two-sided printing accessory is attached to the printer, follow the [steps to print a booklet automatically](#).

Booklet printing automatically arranges and resizes the pages of a document so that when the document is folded into a booklet, the page order is correct.

For example, when a four-page booklet is printed on both sides of the paper, the pages are reordered and printed like this:

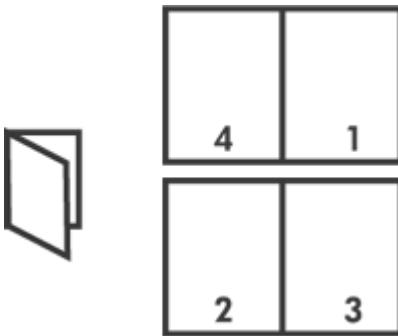

Guidelines

Do not exceed the In tray capacity: 150 sheets of paper.

Prepare to print

1. Verify that the printer is turned on.
2. Raise the Out tray.
3. Slide the paper-width guide all the way to the left, and then pull out the paper-length guide.
4. Place plain paper in the In tray, pushing the paper into the printer until it stops.
5. Slide the paper guides firmly against the paper.

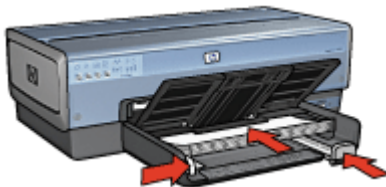

6. Lower the Out tray.

Print

1. Open the [Printer Properties](#) dialog box.
2. Click the **Printing Shortcuts** tab.
3. In the **What do you want to do?** drop-down list, click **Booklet Printing**.
4. In the **Print On Both Sides** drop-down list, click one of the following binding options:
 - **Left Edge Booklet**
 - **Right Edge Booklet**
5. Select any other print settings that you want, and then click **OK**.
6. When prompted, reload the printed pages in the In tray as shown below.

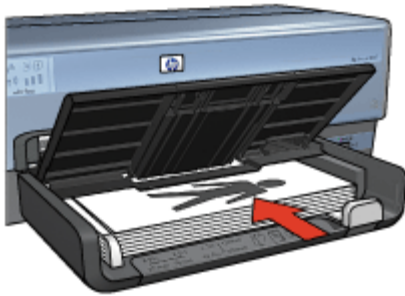

7. Click **Continue** to finish printing the booklet.

Use the [What's This? help](#) to learn about the features that appear in the Printer Properties dialog box.

Posters

Guidelines

- After the sections of a poster have been printed, trim the edges of the sheets and tape the sheets together.



- Do not exceed the In tray capacity: 150 sheets of paper.

Prepare to print

1. Verify that the printer is turned on.
2. Raise the Out tray.
3. Slide the paper-width guide all the way to the left, and then pull out the paper-length guide.
4. Place plain paper in the In tray, pushing the paper into the printer until it stops.
5. Slide the paper guides firmly against the paper.

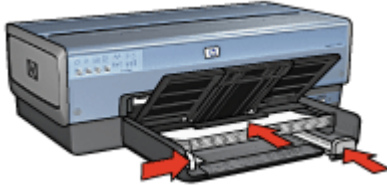

6. Lower the Out tray.

Print

1. Open the [Printer Properties](#) dialog box.
2. Click the **Paper/Quality** tab, and then specify the following print settings:
 - **Size is:** An appropriate paper size
 - **Source is: Upper tray**
 - **Type is: Automatic or Plain paper**
3. Click the **Finishing** tab, and then specify the following print settings:
 - **Pages Per Sheet and Posters: Poster 2 x 2, Poster 3 x 3, Poster 4 x 4, or Poster 5 x 5**
 - **Orientation: Portrait or Landscape**
4. Select any other print settings that you want, and then click **OK**.

Use the [What's This? help](#) to learn about the features that appear in the Printer Properties dialog box.

Iron-on transfers

Guidelines

- When printing a mirror image, the text and the pictures are horizontally reversed from what is displayed on the computer screen.



- Do not exceed the In tray capacity: 20 iron-on transfers.

Prepare to print

1. Verify that the printer is turned on.
2. Raise the Out tray, and then remove all paper from the In tray.
3. Slide the paper-width guide all the way to the left, and then pull out the paper-length guide.
4. Place the iron-on transfer paper in the In tray, with the side to be printed on facing down.
5. Push the paper into the printer until it stops.
6. Slide the paper guides firmly against the paper.

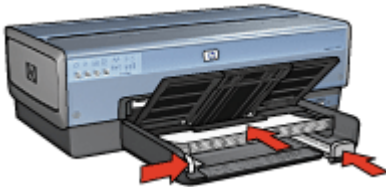

7. Lower the Out tray.

Print



Note If the software program includes an iron-on transfer printing feature, follow the instructions that are provided with the software program. Otherwise, follow the instructions below.

1. Open the [Printer Properties](#) dialog box.
2. Click the **Paper/Quality** tab, and then specify the following print settings:
 - **Size is:** An appropriate paper size
 - **Type is:** Click **More**, and then select **HP Iron-on Transfer**.
 - **Source is:** **Upper tray**
 - **Print Quality:** **Normal** or **Best**
3. Click the **Finishing** tab.
4. Select the **Mirror Image** check box.



Note Some iron-on transfer software programs do not require you to print a mirror image.

5. Select any other print settings that you want, and then click **OK**.

Use the [What's This? help](#) to learn about the features that appear in the Printer Properties dialog box.

Banners

Guidelines

- Remove any perforated strips from the banner paper before loading it in the In tray.

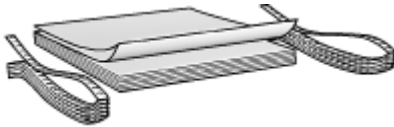

- Do not exceed the In-tray capacity: 20 sheets.

Prepare to print

1. Verify that the printer is turned on.
2. Remove the Out tray, and then remove all paper from the In tray.
3. Slide the paper width-guide all the way to the left, and then pull out the paper-length guide.
4. Place the banner paper in the In tray so that the unattached edge is on top of the paper stack and pointing toward the printer.

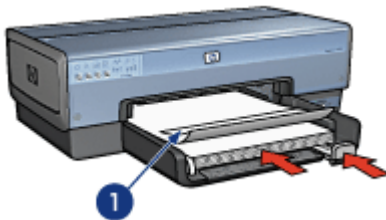

1	Unattached edge
---	-----------------

5. Slide the paper-width guide firmly against the paper.



Note Leave the Out tray off of the printer when printing a banner.

Print

Use the [What's This? help](#) to learn about the features that you see in the **Printer Properties** dialog box.

1. Open the **Printer Properties** dialog box.
2. Click the **Paper/Quality** tab, and then specify the following print settings:
 - **Size is: Letter or A4**
 - **Source is: Upper tray**
 - **Type is: HP Banner Paper**
3. Select any other print settings that you want, and then click **OK**.

CD/DVD tattoos

Guidelines

- Refer to the instructions that are included with the media for the most current printing tips.
- To avoid damage to the printer, do not feed a sheet of tattoos through the printer more than once.
- Separating any part of the tattoo from the protective backing sheet before printing could harm the printer. Be sure that the tattoo covers the entire backing sheet with no exposed spaces.
- Do not use tattoos that are separating from the backing sheet, or that are wrinkled, curled, or damaged in any way.
- If the tattoo sheets do not easily feed through the printer, try one of the following suggestions:
 - Do not load the In tray to capacity.
 - Fan the stack of tattoos.
 - Feed the tattoos one sheet at a time.

Prepare to print

Load the paper

1. Verify that the printer is turned on.
2. Remove the Out tray, and then remove all paper from the In tray.
3. Slide the paper-width guide all the way to the left, and then pull out the paper-length guide.
4. Insert one sheet, pushing it all the way into the printer until it stops.
5. Slide the paper guides firmly against the sheet.
6. Replace the Out tray.

To simplify downloading sample templates and practice sheets, set Adobe Acrobat Reader 5.0 or later as the default PDF reader by following these instructions:

Set up Acrobat as the default PDF reader

1. Right-click any PDF file on the computer.
2. Click **Open With** from the main menu.
3. Click **Choose Program**.
4. Select **Acrobat Reader** or **Adobe Reader 5.0** or later.
5. Select the **Always use the selected program to open this kind of file** check box.

For easy-to-use templates for creating personalized tattoos, go to www.hp.com.

Print



Note Before printing a tattoo, print a practice page to test the layout of the design. The design might need to be adjusted slightly.

1. Select **Print** in the software program.
2. Select the printer from the **Print** dialog box.
3. Select **Properties**.
4. Select Letter (8.5 x 11 in.) as the paper size.
5. Select **HP Premium Plus** as the paper type.
6. Select **Best** for image quality.
7. Make the following selections:
 - **Page Scaling: None**
 - **Auto-Rotate and Center: Off**
8. Click **OK**.

8 Printing tips

Save time

- Use the [Printing Shortcuts](#) tab.
- Create [print task quick sets](#) for documents that you often print.
- Use the [250-Sheet Plain Paper Tray Accessory](#) to reload the printer less often.
- Set the [order](#) that the pages print.

Save money

- Use [Fast/economical printing](#).
- Print [multiple pages](#) on a single sheet of paper.
- Print a two-sided document either [automatically](#) or [manually](#).
- Use [HP Everyday Photo Paper](#) to save money and ink when printing photos.

Enhance the quality of printouts

- [Preview](#) the document before printing it.
- Print on a [custom paper size](#).
- Select the correct [paper type](#).
- Select the correct [print quality](#).
- [Resize](#) the document as needed.
- Add a [watermark](#).
- Print a [borderless brochure](#).

Printing shortcuts

The Printing Shortcuts tab makes it easy to set the printing options for the documents that you want to print.

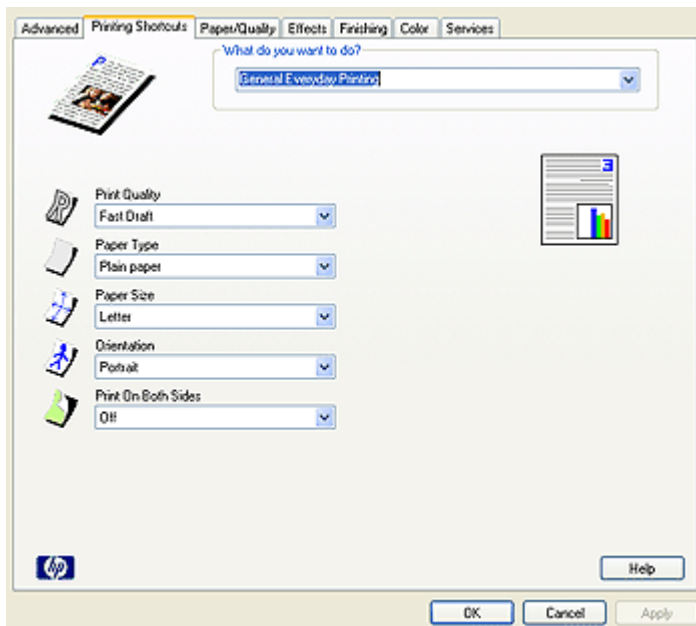

Use the Printing Shortcuts tab for the following print tasks:

- [General everyday printing](#)
- [Photo printing–borderless](#)
- [Photo printing–with white borders](#)
- [Fast/economical printing](#)
- [Presentation printing](#)
- [Two-sided, duplex, printing](#)
- [Postcard printing](#)

Fast/economical printing

Use Fast/economical printing to produce draft-quality printouts quickly.

Follow these steps to use Fast/economical printing:

1. Open the [Printer Properties](#) dialog box.
2. Click the **Printing Shortcuts** tab.
3. In the **What do you want to do?** drop-down list, click **Fast/Economical Printing**.
4. Specify the print settings that you want.
5. Click **OK**.

Use the [What's This? help](#) to learn about the features you see on the Printer Properties dialog box.

General everyday printing

Use General everyday printing to print documents quickly.

- [Documents](#)
- [E-mail](#)

Presentation printing

Use Presentation printing to print high-quality documents, including:

- [Letters](#)
- [Brochures](#)
- [Transparencies](#)

Print in grayscale

Follow these steps to print in grayscale:

1. Open the [Printer Properties](#) dialog box.
2. Click the **Color** tab.
3. Click the **Print In Grayscale** check box, and then click one of the following:
 - **High Quality:** Use this option for photos and other high-quality printouts.
 - **Black Print Cartridge Only:** Use this option for fast, economical printing.
4. Select any other print settings that you want, and then click **OK**.

Select a print quality

Follow these steps to select a print quality:

1. Open the [Printer Properties](#) dialog box.
2. Click the **Printing Shortcuts** tab.
3. Click one of the following options in the **Print quality** drop-down list:
 - **Fast Draft**: Prints at the fastest printing speed while using the least amount of ink.
 - **Fast Normal**: Prints more quickly than Normal mode and at a higher print quality than Fast Draft.
 - **Normal**: Provides the best balance between print quality and speed. This is the appropriate setting for most documents.
 - **Best**: Provides high-quality printing.
 - **Maximum dpi**: Provides the highest quality printing, but requires longer to print than **Best** and requires a large amount of disk space.



Note **Maximum dpi** is available on the **Paper/Quality** tab.



Note The print quality options that are available on the **Printing Shortcuts** tab vary depending on the type of document that you are printing.

Set the page order

The page order determines the order in which the multipage documents print.

To set the page order, follow these steps:

1. Open the [Printer Properties](#) dialog box.
2. Click the **Advanced** tab.

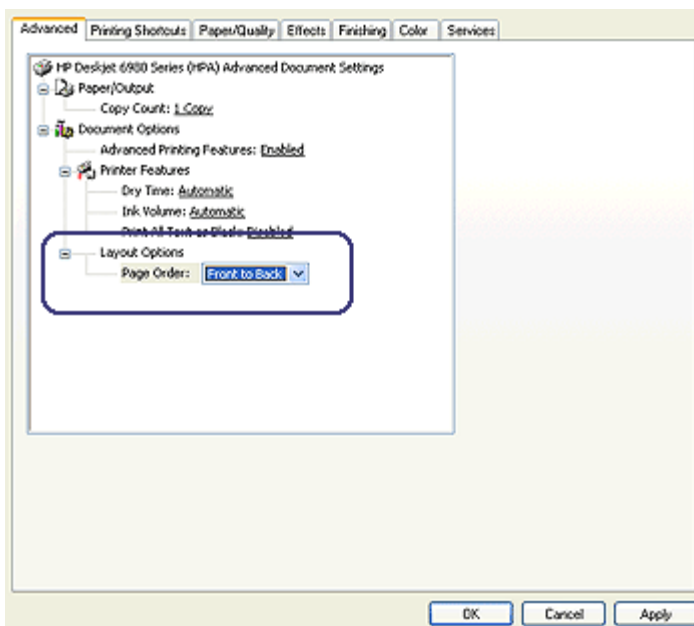

3. Click **Document Options**, and then click **Layout Options**.
4. Click one of the following **Page Order** options:
 - **Front to back**: Prints the first page of the document last. This setting saves time because you do not have to reorder the printed pages. It is the appropriate setting for most print jobs.
 - **Back to front**: Prints the last page of the document last.
5. Select any other print settings that you want, and then click **OK**.

Print multiple pages on a single sheet of paper

Use the printer software to print multiple pages of a document on a single sheet of paper. The printer software automatically resizes the document text and images to fit on the printed page.

Follow these steps to print multiple pages of a document on a single sheet of paper:

1. Open the [Printer Properties](#) dialog box.
2. Click the **Finishing** tab.
3. In the **Pages Per Sheet and Posters** drop-down list, click the number of pages that you want to appear on each sheet of paper.
4. If you want a border to appear around each page image that is printed on the sheet of paper, select the **Print Page Borders** check box.
5. In the **Page Order** drop-down list, click a layout for each sheet of paper.
6. Select any other print settings that you want, and then click **OK**.

Print preview

Use the print preview function to view a printout on the computer before printing a document. If the printout does not look correct, you can cancel the print job and adjust the print settings as needed.

To preview a printed document, follow these steps:

1. Open the [Printer Properties](#) dialog box.
2. Click the **Finishing** tab.
3. Select the **Show Print Preview** check box.
4. Select any other print settings that you want, and then click **OK**.
Before the document prints, a preview is displayed.
5. Do one of the following:
 - Click **File** and then click **Print to HP Deskjet** to print the document.
 - Click **File** and then click **Cancel Printing** to cancel the print job. Adjust the print settings as needed before trying to print the document again.

Set a custom paper size

Use the Custom paper size dialog box to print on a special paper size.



Note This feature is not available for all paper types.

Follow these steps to define a custom paper size:

1. Open the [Printer Properties](#) dialog box.
2. Click the **Paper/Quality** tab.
3. Click the **Custom** button.
The Custom paper size dialog box is displayed.

The custom paper size you have just defined will not become available for selection until you have exited and re-entered the Printing Preferences/Properties.

Name
Custom Save

Paper Size
Width: 4.00
(3.00 - 8.50)
Length: 6.00
(5.00 - 14.00)

Units
 Inches
 Millimeters

OK Cancel

4. In the **Name** drop-down list, click a custom paper size name.
5. Type the paper dimensions in the **Width** and **Length** boxes.
The minimum and maximum dimensions appear beneath each of the boxes.
6. Click the unit of measurement: **Inches** or **Millimeters**.
7. Click **Save** to save the custom paper size.
8. Click **OK** to exit the Custom Paper Size dialog box.

Select a paper type

To determine the paper type used for a printing job, select Automatic to use the automatic paper-type sensor or select a specific paper type.

Use the automatic paper-type sensor

Automatic is the default paper-type setting. When it is used, the [auto paper-type sensor](#) automatically selects the print settings that are appropriate for the media that you are printing, particularly when HP paper and media are used.



Note The Automatic Paper-Type Sensor cannot be used for documents that are printed from the [250-Sheet Plain Paper Tray Accessory](#).

Follow these steps to use the auto paper-type sensor:

1. Open the [Printer Properties](#) dialog box.
2. Click the **Printing Shortcuts** tab.
3. In the **Paper type** drop-down list, click **Automatic**.
4. Select any other print settings that you want, and then click **OK**.



Note Do not use the Automatic setting for high-quality printouts. Instead, select a specific paper type.

Select a specific paper type

When printing a higher-quality document, HP recommends that you select a specific paper type.

Follow these steps to select a specific paper type:

1. Open the [Printer Properties](#) dialog box.
2. Click the **Printing Shortcuts** tab.
3. In the **Paper Type** drop-down list, click an appropriate paper type.
4. Select any other print settings that you want, and then click **OK**.

Select a paper source

The printer offers three sources for paper:



In tray



250-Sheet Plain Paper
Tray Accessory



Auto Two-Sided Print
Accessory with Small
Paper Tray

Follow these steps to select a paper source:

1. Open the [Printer Properties](#) dialog box.
2. Click the **Printing Shortcuts** tab or the **Paper/Quality** tab.
3. Find the appropriate drop-down list:

Tab	Drop-down list
Printing Shortcuts	Paper source
Paper/Quality	Source is

4. Select any other print settings that you want, and then click **OK**.
4. Select one of the following options in the drop-down list:
 - **Upper tray**: prints from the In tray.
 - **Lower tray**: prints from the 250-Sheet Plain Paper Tray Accessory.

- **Upper, then lower:** prints from the In tray. If the In tray is empty, the printer prints from the 250-Sheet Plain Paper Tray Accessory.
- **Lower, then upper:** prints from the 250-Sheet Plain Paper Tray Accessory. If the accessory is empty, the printer prints from the In tray.
- **Rear tray:** prints from the Auto Two-Sided Print Accessory with Small Paper Tray. This option is displayed only if the accessory is attached to the printer.

Print task quick sets

Use print task quick sets to print with or save print settings that you use often.

If you frequently print on envelopes, for example, you can create a print task that contains the paper size, print quality, and orientation setting that you normally use for envelopes. After creating the print task, simply select it when printing on envelopes rather than setting each of the print settings separately.



Note The printer software can save up to 25 print task quick sets.

Create a print task or use the specially designed print tasks that are available in the Print Task Quick Sets drop-down list.

Use a print task quick set

Follow these steps to use a print task quick set:

1. Open the [Printer Properties](#) dialog box.
A Print Task Quick Sets drop-down list is displayed at the top of most tabs.
2. Go to **Print Task Quick Sets** on any tab where it is displayed.
3. In the drop-down list, click the print task that you want to use.

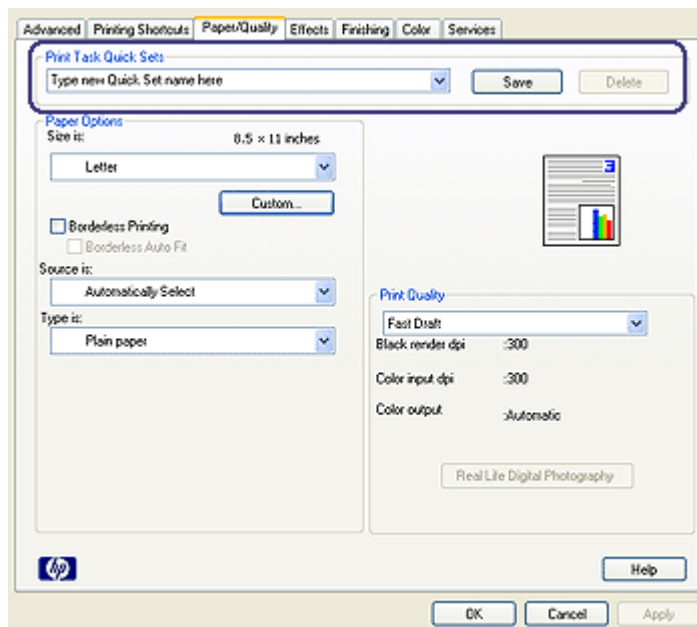

4. Click **OK**.



Note To restore default print settings, click **Default Print Settings** in the **Print Task Quick Sets** drop-down list, and then click **OK**.

Create a print task quick set

Follow these steps to create a print task quick set:

1. Open the [Printer Properties](#) dialog box.
2. Select the options that you want to include in the new print task.
3. Go to **Print Task Quick Sets** on any tab where it is displayed.
4. Type a name for the new print task in the **Print Task Quick Sets** drop-down list, and then click **Save**.

The print task quick set is added to the drop-down list.



Note If you add more options to the print task, rename the print task and then click **OK**.

Delete a print task quick set

Follow these steps to delete a print task quick set:

1. Open the [Printer Properties](#) dialog box.
A Print Task Quick Sets drop-down list is displayed at the top of most tabs.
2. Go to **Print Task Quick Sets** on any tab where it is displayed.
3. In the drop-down list, click the print task that you want to delete and then click **Delete**.



Note Some print task quick sets cannot be deleted.

Automatic two-sided printing

To print a two-sided document automatically, one of the following accessories must be attached to the printer:



[Automatic Two-Sided Printing Accessory](#)



[Auto Two-Sided Print Accessory with Small Paper Tray](#)

The two-sided printing accessories only support certain paper types. For a list of supported paper types, see the documentation that came with the accessory.

If a two-sided printing accessory is not attached to the printer or you are printing on an unsupported paper type, use [manual two-sided printing](#).

Binding type

Select the type of binding that you want for the two-sided document, and then follow the steps for that binding:

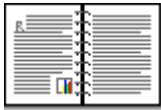

Book binding

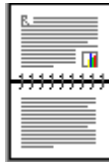

Tablet binding



Note Book binding is the most common type of binding.

Book binding

Follow these steps to print a two-sided document with a book binding:

1. Open the [Printer Properties](#) dialog box.
2. Click the **Printing Shortcuts** tab, and then click **Two-sided (Duplex) Printing** in the drop-down list.

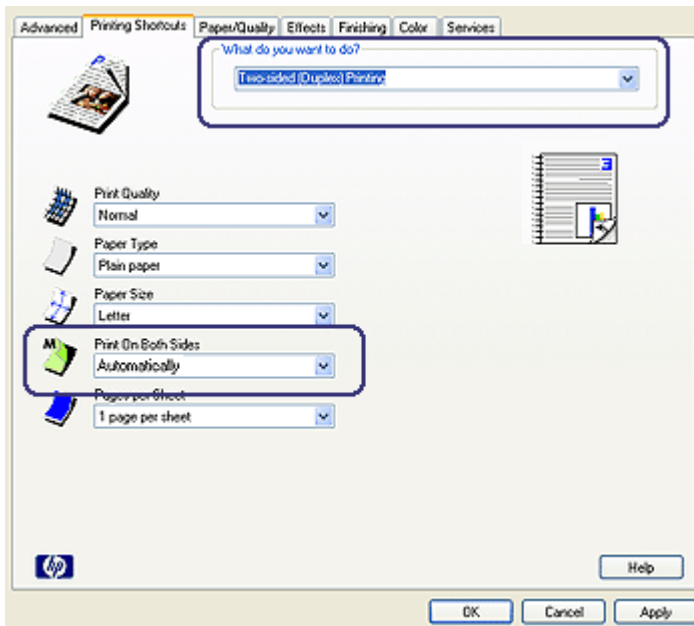

3. In the **Print on both sides** drop-down list, click **Automatically**.
4. Select any other print settings that you want, and then click **OK**.

After the first side of the page is printed, the printer pauses while the ink dries. When the ink is dry, the paper is pulled back into the duplexer and the reverse side of the page is printed.

Do not remove the paper from the printer until both sides of the page have been printed.

Tablet binding

Follow these steps to print a two-sided document with a tablet binding:

1. Open the [Printer Properties](#) dialog box.
2. Click the **Finishing** tab.

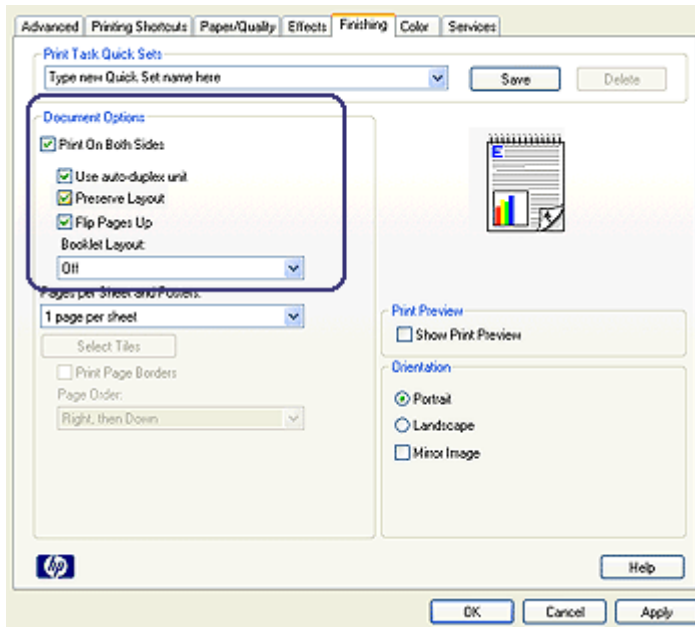

3. Select the **Print on both sides** check box.
4. Select the **Use auto-duplex unit** check box.
5. Select the **Preserve layout** check box.
6. Select the **Flip pages up** check box.
7. Select any other print settings that you want, and then click **OK**.

After the first side of the page is printed, the printer pauses while the ink dries. When the ink is dry, the paper is pulled back into the duplexer and the reverse side of the page is printed.

Do not remove the paper from the printer until both sides of the page have been printed.

Manual two-sided printing

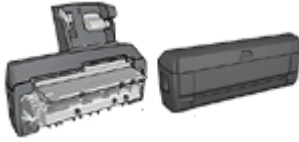

If an optional two-sided printing accessory is attached to the printer, follow the automatic two-sided printing instructions.

Use two-sided printing, also called *duplexing*, to print on both sides of the paper. Printing on both sides of the paper is not only economical, but environmentally conscious as well.

Print a two-sided document

To print a two-sided document, follow these steps:

1. Open the [Printer Properties](#) dialog box.
2. Click the **Printing Shortcuts** tab.

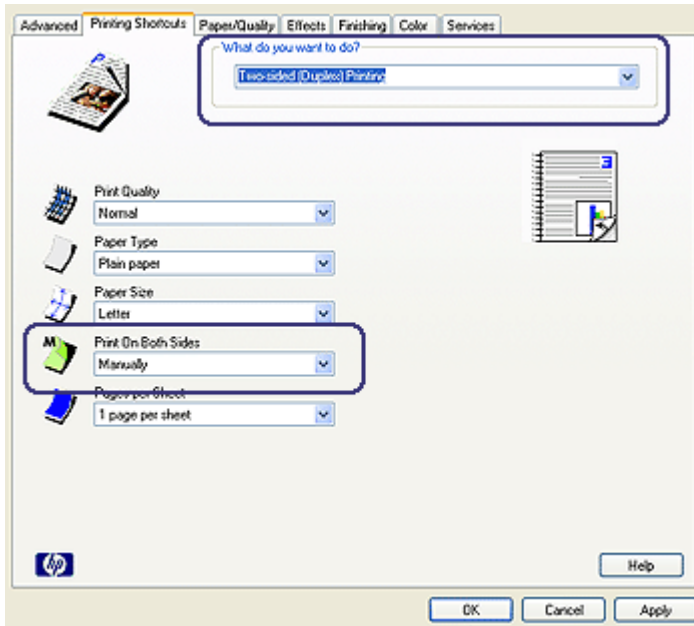

3. In the **What do you want to do?** drop-down list, click **Two-sided (Duplex) Printing**.
4. In the **Print On Both Sides** drop-down list, click **Manually**.
5. Select any other print settings that you want, and then click **OK**.
The printer prints the odd-numbered pages first.
6. After the odd-numbered pages have been printed, reload the printed pages with the printed side facing up.

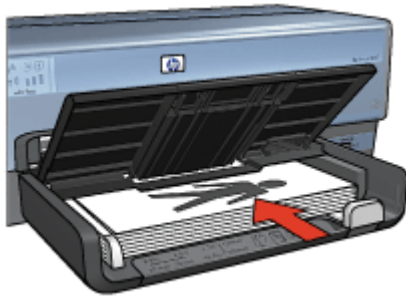

7. Click **Continue** to print the even-numbered pages.

Create a bound two-sided document

Select the type of binding that you want for the two-sided document, and then follow the steps for that binding.

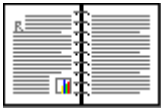

Book binding



Tablet binding



Note Book binding is the most common type of binding.

Book binding

Follow these steps to print a two-sided document with a book binding:

1. Open the [Printer Properties](#) dialog box.
2. Click the **Printing Shortcuts** tab.

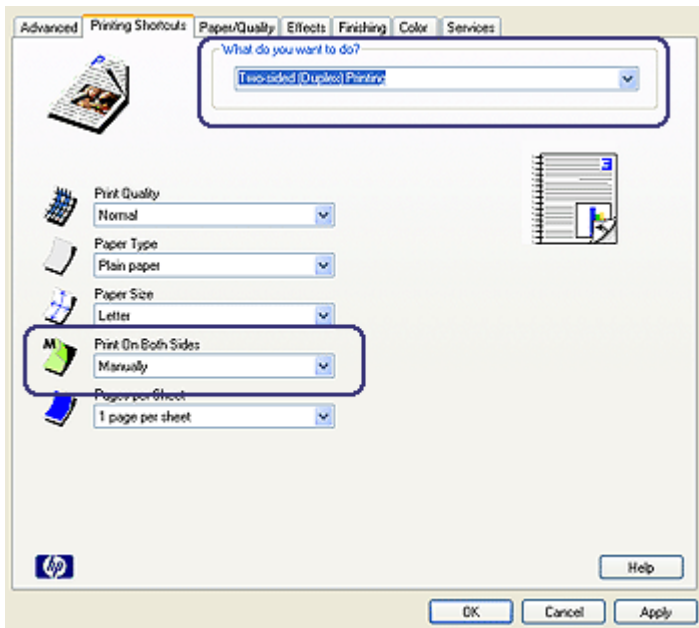

3. In the **What do you want to do?** drop-down list, click **Two-sided (Duplex) Printing**.
4. In the **Print On Both Sides** drop-down list, click **Manually**.
5. Select any other print settings that you want, and then click **OK**.
The printer prints the odd-numbered pages first.
6. After the odd-numbered pages have been printed, reload the printed pages with the printed side facing up.

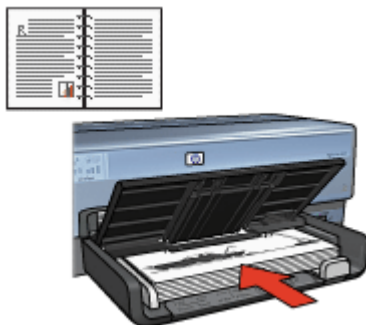

7. Click **Continue** to print the even-numbered pages.

Tablet binding

Follow these steps to print a two-sided document with a tablet binding:

1. Open the [Printer Properties](#) dialog box.
2. Click the **Finishing** tab.

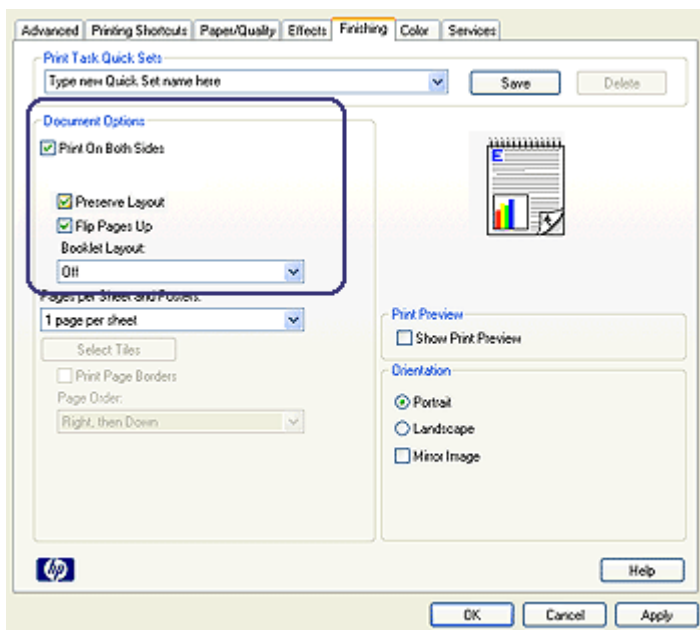

3. Select the following check boxes:
 - **Print On Both Sides (Manually)**
 - **Preserve Layout**
 - **Flip Pages Up**
4. Select any other print settings that you want, and then click **OK**.
The printer prints the odd-numbered pages first.
5. After the odd-numbered pages have been printed, reload the printed pages, with the printed side facing up according to the document orientation, portrait or landscape.

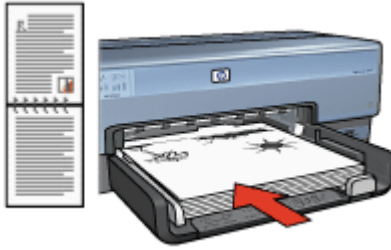

Portrait

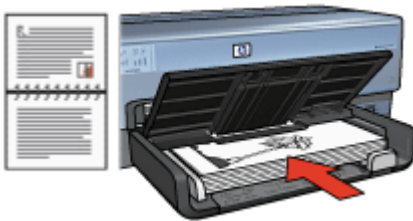

Landscape

6. Click **Continue** to print the even-numbered pages.

Resize a document

Use the printer software for either of these tasks:

- Print a document on a paper size different from the size for which it is formatted.
- Shrink or enlarge text and graphics on the printed page.

Print on a different paper size

Use this feature to print a document that is formatted for one paper size on another paper size. Doing this can be useful if you do not have the correct paper size available.

For example, if you have created a document that is formatted for letter-size paper, but you do not have any letter-size paper available, you can print the document on another paper size that is available.

Follow these steps to resize the document for a different paper size:

1. Open the [Printer Properties](#) dialog box.
2. Click the **Effects** tab.

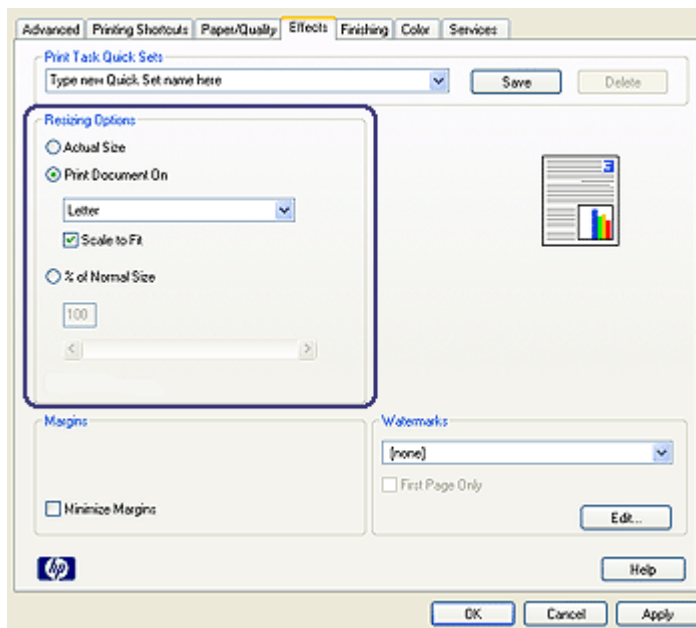

3. Select the **Print document on** check box, and then click the target paper size in the drop-down list.
The target paper size is the size of the paper on which you are printing, not the size for which the document was formatted.
4. Do one of the following:

Objective	Action
Shrink or enlarge the document to fit on the target paper size.	Select the Scale to Fit check box.
Print the document at its original size on the selected paper size.	Do not select the Scale to Fit check box.

5. Select any other print settings that you want, and then click **OK**.

Shrink or enlarge text and graphics

Use this feature to shrink or enlarge printed text and graphics without changing the paper size.

Follow these steps to shrink or enlarge text and graphics:

1. Open the [Printer Properties](#) dialog box.
2. Click the **Effects** tab.
3. In the **% of normal size** box, type the percentage by which you want to shrink or enlarge the text and graphics.

One hundred percent represents the actual size of the text and graphics. Type a number less than 100 to shrink the text and graphics. Type a number greater than 100 to enlarge the text and graphics.

4. Select any other print settings that you want, and then click **OK**.

Watermarks

Watermarks appear as background printing on documents.

Apply an existing watermark

Follow these steps to apply an existing watermark to a document:

1. Open the [Printer Properties](#) dialog box.
2. Click the **Effects** tab.
3. Click a watermark in the **Watermarks** drop-down list.

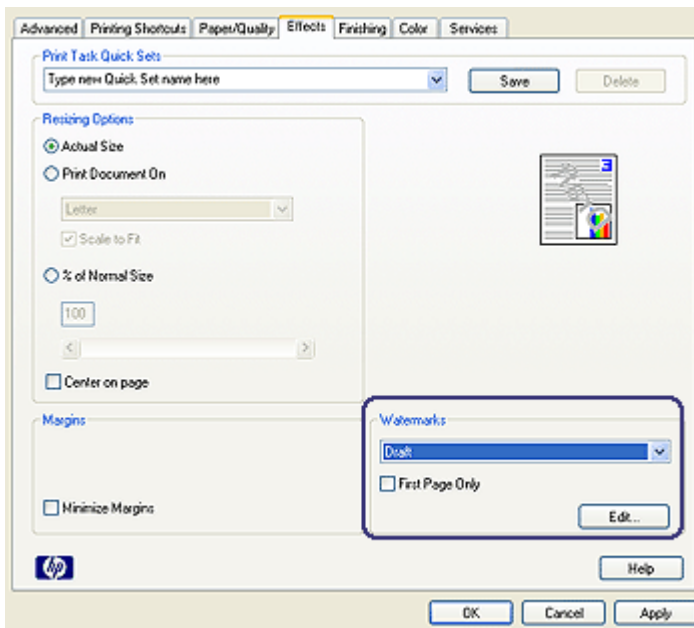

If you do not want to use one of the listed watermarks, [create a new watermark](#).

4. Choose one of the following actions:
 - If you want the watermark to appear on the first page only, select the **First Page Only** check box.
 - If you want the watermark to appear on all printed pages, leave the **First Page Only** check box clear.
5. Print the document according to the instructions for the paper type.

Create or change a watermark

Follow these steps to create or change a watermark:

1. Open the [Printer Properties](#) dialog box.
2. Click the **Effects** tab.

3. Click the **Edit** button.
The Watermark Details dialog box is displayed.

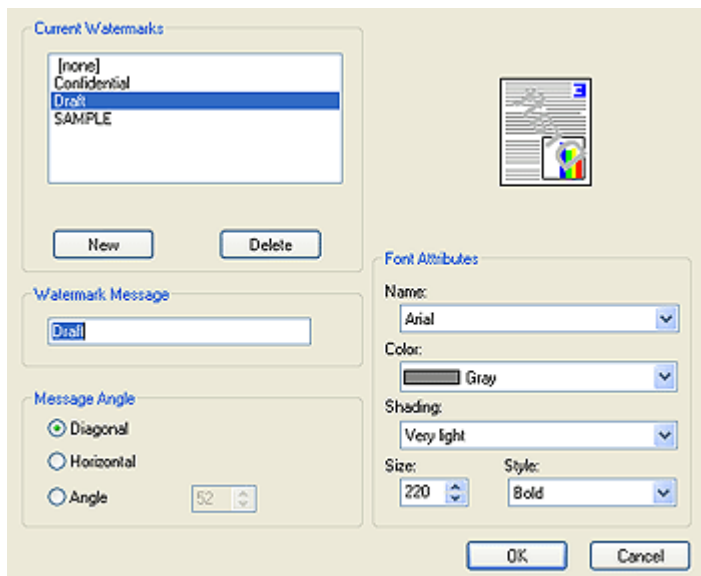

4. Choose one of the following actions:
 - Click the **New** button.
 - Select an existing watermark to change.
5. Type the watermark message, and then select the message angle and the font attributes.
6. After you have set the watermark details, click **OK**.

For instructions about applying watermarks, follow the steps for [applying an existing watermark to a document](#).

Use the [What's This? help](#) to learn about the features that you see on the Printer Properties dialog box.

9 Printer software

- Use the [Printer Properties](#) dialog box to select printing options.
- Use the [What's This? help](#) to learn more about specific print settings.
- Use the [Printing Shortcuts](#) tab to specify print settings quickly.
- View the [Ink Status window](#) for the approximate ink level of each print cartridge.
- Download [printer software updates](#) for the latest features and improvements.

Printer Properties dialog box

The printer is controlled by software that is installed on the computer. Use the printer software, also known as the *printer driver*, to change the print settings for a document.

To change the print settings, open the Printer Properties dialog box.



Note The Printer Properties dialog box is also referred to as the Printing Preferences dialog box.

Open the Printer Properties dialog box

Follow these steps to open the Printer Properties dialog box:

1. Open the file that you want to print.
2. Click **File**, click **Print**, and then click **Properties** or **Preferences**.

The Printer Properties dialog box is displayed.



Note The path to the Printer Properties dialog box can vary depending on the software program you are using.

What's This? help

Use the [What's This? help](#) to learn about the features that you see on the Printer Properties dialog box.

What's This? help

Use What's This? help to learn more about the available printing options.

1. Move the cursor over the feature that you want to learn more about.
2. Click the right mouse button.
The What's This box is displayed.
3. Move the cursor over the **What's This?** box, and then click the left mouse button.
An explanation of the feature is displayed.

Ink Status window

The Ink Status window is displayed each time the printer prints a file. The window displays the approximate ink level of each print cartridge. To close the Ink Status window, click **Close**.

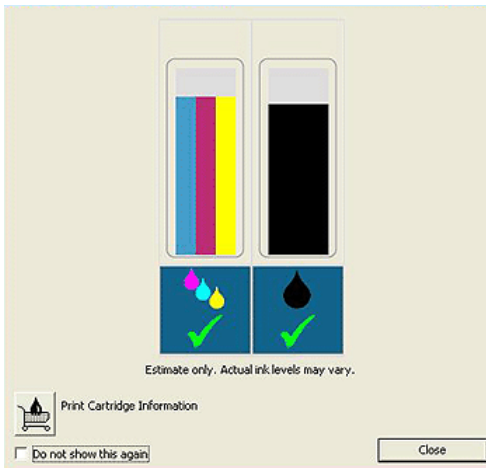

Note The Ink Status window may not display if the printer is operating over a non-Microsoft configuration.

Print cartridge information and ordering

For print cartridge information and to link to HP's Web site for ordering print cartridges, click the **Print Cartridge Information** button.

Display the Ink Status window

If you do not want the Ink Status window to appear when you print, select the **Do not show this again** check box in the lower-left corner of the window.

If you previously chose not to show the Ink Status window but now want it to appear when you print, follow these steps:

1. For Windows 2000, click **Start**, and then click **Settings**. For Windows XP, click **Start**, and then click **Printers and Faxes**.
A list that includes the printers installed on the computer is displayed.
2. Highlight the printer name, and then right-click to display a list of options.
3. Click **Properties**.
The printer properties dialog box is displayed.
4. Click the **Device Settings** tab.
5. For **Display Ink Status Window**, click **On**, and then click **OK**.

Download printer software updates

Download the latest printer software update every few months to ensure you have the latest features and improvements:

1. Make sure you are connected to the Internet.
2. For Windows 2000, click **Start**, click **Programs**, click **HP**, and then click **HP Software Update**. For Windows XP, click **Start**, click **All Programs**, click **HP**, and then click **HP Software Update**.
The HP Software Update window is displayed.

3. Click **Next**.
HP Software Update searches the HP Web site for printer software updates.
 - If the computer has the most recent version of the printer software installed, **No updates are available for your system at this time** is displayed in the HP Software Update window.
 - If the computer does not have the most recent version of the printer software installed, a software update is displayed in the HP Software Update window.
4. If a software update is available, select the check box beside the update name.
5. Click **Install**.
6. Follow the onscreen instructions.

Download HP Photosmart Software

Installing the printer software update you download from the HP Web site does not update HP Photosmart Software you might have installed on the computer. For information about updating HP Photosmart Software, see the HP Photosmart Software Help.

10 Maintenance

- Install print cartridges
- Set the auto-off feature
- Align the print cartridges
- Calibrate color
- Automatically clean print cartridges
- Print a test page
- View estimated ink levels
- Maintain the printer body
- Remove ink from your skin and clothing
- Manually clean print cartridges
- Maintain print cartridges
- Printer Toolbox

Install print cartridges

When you need to replace print cartridges, make sure you have the correct print cartridges for the printer, and then install them in the print cartridge cradle.

Print cartridge combinations

For printing most documents, use the tri-color print cartridge and the black print cartridge. When printing photos, use the photo print cartridge along with the tri-color print cartridge. For printing high-quality black-and-white photographs, use the gray photo print cartridge in conjunction with the tri-color print cartridge.

Always install the tri-color print cartridge in the left side of the print cartridge cradle.

Install the black, photo print cartridge, or the gray photo print cartridge in the right side of the print cartridge cradle.



Note To easily identify the correct side of the cradle in which to install the print cartridge, match the symbol on the print cartridge label with the symbol above the print cartridge cradle.

Selection numbers

When buying replacement print cartridges, look for the print cartridge selection number. You can find the selection number in three places:

- Selection number label: Look at the label on the print cartridge that you are replacing.

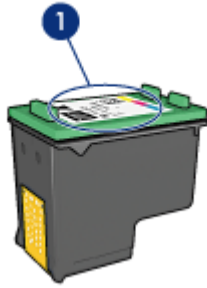

1	Selection number label
---	------------------------

- Printer documentation: For a list of print cartridge selection numbers, see the reference guide that came with the printer.
- Print Cartridge Information dialog box: For a list of print cartridge selection numbers, open the printer [Toolbox](#), click the **Estimated Ink Level** tab, and then click the **Print Cartridge Information** button.

Ink-backup mode

The printer can operate with only one print cartridge installed. For more information, see [Ink-backup mode](#).

Installation instructions

Follow these steps to install a print cartridge:

1. Verify that the printer is turned on.
2. Load Letter or A4 plain, white paper in the In tray.
3. Open the printer cover.
4. Wait until the print cartridge cradle moves to the right side of the printer and is idle and silent, and then lift the print cartridge latch to the open position.

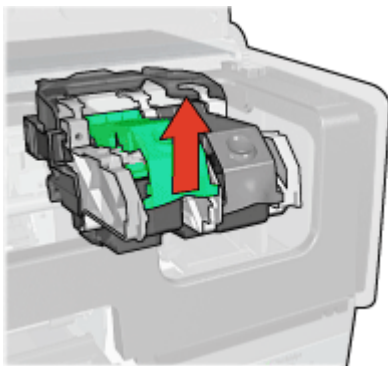

5. Slide the print cartridge out of the print cartridge cradle.

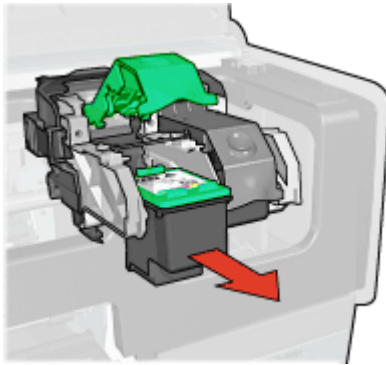

6. Remove the replacement print cartridge from its packaging and carefully remove the plastic tape. Hold the print cartridge so that the copper strips are on the bottom and facing toward the printer.

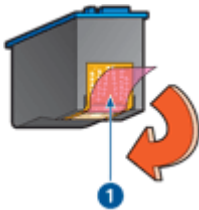

1 | Remove plastic tape

Caution Do not touch the print cartridge ink nozzles or copper contacts. Touching these parts will result in clogs, ink failure, and bad electrical connections. Do not remove the copper strips. They are required electrical contacts.

7. Hold the print cartridge so that the copper strips are on the bottom and facing toward the printer, and then slide the print cartridge into the cradle as shown.

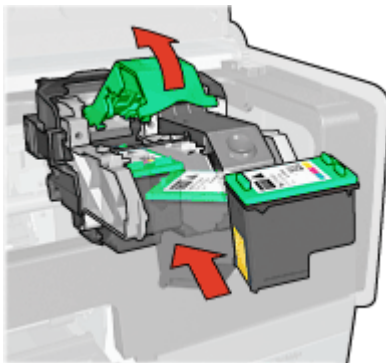

8. Push down on the print cartridge latch until it snaps closed.

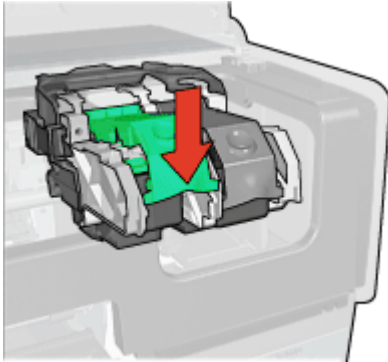

9. Close the printer cover.

The printer automatically prints a calibration page.

For information about storing print cartridges, see [Maintain print cartridges](#).

For information about recycling empty print cartridges, see [Print cartridge recovery](#).



Warning Keep both new and used print cartridges out of the reach of children.

Set the auto-off feature

The printer is designed with an auto-off feature that automatically places the printer into a low power mode when it has been idle for 30 minutes. In this mode, the printer continues to consume a maximum 3.0 watts of power with the radio off (maximum 5.5 watts with the radio on) and turns back on automatically when print jobs are sent to the printer. You can manually turn the printer off by pressing and holding the [Power button](#) for three seconds. When the printer is manually turned off, the printer uses less than one watt of power. Manually powering off the printer is recommended if the printer causes interference with other wireless devices, or if you do not plan to use the printer for a long period of time.

Selecting auto-off cancels the [FEMP](#) energy savings mode.

Energy consumption can be prevented by turning the printer power off, and then disconnecting the end of the printer power cord from the electrical source.

Follow these steps to activate the auto-off feature:

1. For Windows 2000, click **Start**, click **Settings**, and then click **Printers**. For Windows XP, click **Start**, and then click **Printers and Faxes**.
A list that includes the printers installed on the computer is displayed.
2. Highlight the printer name, and then right-click to display a list of options.
3. Click **Properties**.
The Printer Properties dialog box is displayed.
4. Click the **Device Settings** tab.
5. To **Activate the Hardware Auto-off feature**, click **On**, and then click **OK**.

Align the print cartridges

The printer automatically aligns the print cartridges after a new print cartridge is installed. You can also align the print cartridges at other times to ensure optimal print quality.

To align print cartridges:

1. Load Letter or A4 plain, white paper in the In tray.
2. Open the printer [Toolbox](#).
3. Click **Align the Print Cartridges**.
4. Click **Align**, and then follow the onscreen instructions.

Calibrate color

Perform a color calibration if the colors in photos that are printed with the [photo print cartridge](#) consistently look incorrect.

Before performing a color calibration, [align the print cartridges](#), and then reprint the photo. If the color is still incorrect, perform a color calibration.

To calibrate color:

1. Load Letter or A4 plain, white paper in the In tray.
2. Verify that both a tri-color print cartridge and a [photo print cartridge](#) are installed in the printer.
3. Open the printer [Toolbox](#).
4. Click **Calibrate Color**.
5. Click **Start**, and then follow the onscreen instructions.

Automatically clean print cartridges

If the printed pages are missing lines or dots, or if they contain ink streaks, the print cartridges might be [low on ink](#) or might need to be cleaned.

If the print cartridges are not low on ink, follow these steps to clean the print cartridges automatically:

1. Open the printer [Toolbox](#).
2. Click **Clean the Print Cartridges**.
3. Click **Clean**, and then follow the onscreen instructions.

If the documents are still missing lines or dots after cleaning, [replace the print cartridges](#).



Caution Clean print cartridges only when necessary. Unnecessary cleaning wastes ink and shortens the life of the cartridge.

Print a test page

Follow these instructions to print a test page:

1. Open the printer [Toolbox](#).
2. Click the **Print a Test Page** button, and then follow the onscreen instructions.

View estimated ink levels

Follow these instructions to view the estimated ink levels of the print cartridges that are installed in the printer:

1. Open the printer **Toolbox**.
2. Click the **Estimated Ink Levels** tab.



Note If the print cartridges were used before being installed in the printer, the estimated ink levels will not appear on the Estimated Ink Levels tab.

The Estimated Ink Level tab also contains print cartridge ordering information. To view this information, click the **Print Cartridge Information** button.

Maintain the printer body

Because the printer ejects ink onto the paper in a fine mist, ink smudges will eventually appear on the printer case and adjacent surfaces. To remove smudges, stains, or dried ink from the exterior of the printer, use a soft cloth moistened with water.

When cleaning the printer, keep these tips in mind:

- *Do not* clean the interior of the printer. Keep all fluids away from the interior.
- *Do not* use household cleaners or detergent. If a household cleaner or detergent has been used on the printer, wipe the exterior surfaces with a soft cloth moistened with water.
- *Do not* lubricate the support rod that the print cartridge cradle uses to slide back and forth. Noise is normal when the cradle moves back and forth.

Remove ink from your skin and clothing

Follow these instructions to remove ink from your skin and clothing:

Surface	Remedy
Skin	Wash the area with an abrasive soap.
White fabric	Wash the fabric in <i>cold</i> water and use chlorine bleach.
Color fabric	Wash the fabric in <i>cold</i> water and use sudsy ammonia.



Caution Always use cold water to remove ink from fabric. Warm or hot water can set the ink into the fabric.

Manually clean print cartridges

If the printer is used in a dusty environment, a small amount of debris can accumulate on the print cartridge contacts.

Gather cleaning supplies

You need the following items to clean the print cartridges.

- Distilled water (tap water can contain contaminants that can damage the print cartridge)
- Cotton swabs or other soft, lint-free material that will not stick to the print cartridge

Be careful not to get **ink on your hands or clothing** as you clean.

Prepare to clean

1. Open the printer cover.
2. Wait until the print cartridge cradle moves to the right side of the printer and is idle and quiet.
3. Remove the print cartridges and place them on a piece of paper, with the copper strips facing up.

 **Caution** Do not leave the print cartridges outside the printer for more than 30 minutes.

Cleaning instructions

1. Lightly moisten a cotton swab with distilled water and squeeze any excess water from the swab.
2. Wipe the print cartridge copper contacts with the cotton swab.

 **Caution** Do not touch the print cartridge ink nozzles. Touching the ink nozzles will result in clogs, ink failure, and bad electrical connections.



1	Ink nozzles (do not touch)
2	Copper contacts

3. Repeat this process until no ink residue or dust appears on the swab.
4. [Insert the print cartridges](#) in the printer, and then close the printer cover.

Maintain print cartridges

The following tips will help maintain HP print cartridges and ensure consistent print quality:

- Keep all print cartridges in their sealed packages until they are needed. Print cartridges should be stored at room temperatures (15° to 35° C or 59° to 95° F).
- Do not remove the plastic tape covering the ink nozzles until you are ready to install the print cartridge in the printer. If the plastic tape has been removed from the print cartridge, do not attempt to reattach it. Reattaching the tape damages the print cartridge.

Follow these instructions to [store print cartridges](#).

Store print cartridges

When print cartridges are removed from the printer, store them in an airtight plastic container or in the print cartridge protector that comes with the photo print cartridge.

If you store the print cartridge in an airtight plastic container, make sure that the ink nozzles are face down but are not in contact with the container.

Insert the print cartridge into the print cartridge protector

Slide the print cartridge at a slight angle into the protector, and snap it securely in place.



Remove the print cartridge from the print cartridge protector

Press down and back on the top of the protector to release the print cartridge. Slide the print cartridge out of the protector.



Caution Do not drop the print cartridge. Dropping the print cartridge can damage it.

Printer Toolbox

The printer Toolbox contains a number of useful tools to enhance the performance of the printer.

Use the printer Toolbox to perform the following tasks:

- [Set the auto-off function](#)
- [Align the print cartridges](#)
- [Calibrate color](#)
- [Clean the print cartridges](#)
- [Print a test page](#)
- [View estimated ink levels](#)
- [Configure Bluetooth settings](#) (if the printer is connected to a computer by a USB cable)

Use the Toolbox

Follow these instructions to use the printer Toolbox:

1. Open the [Printer Properties](#) dialog box.
2. Click the **Services** tab, and then click the **Service this device** button.

11 Troubleshooting

- Ethernet problems
- Wireless communication problems
- Printer does not print
- Paper jam
- Paper problems
- Paper mismatch
- Printer is stalled
- Print cartridge problems
- Photos do not print correctly
- PictBridge problems
- Bluetooth printing problems
- Banners do not print correctly
- Print quality is poor
- Document is misprinted
- Problems with borderless documents
- Error messages
- Printer lights are on or flashing
- Document prints slowly
- If you continue to have problems
- HP support process

Ethernet problems

The following problems can occur with an Ethernet connection.

Printer does not print

Print an [HP Report page](#).

If the HP Report page does not print, verify the following:



- The printer is set up and powered on.
- The [print cartridges are installed](#) correctly.
- The printer is on and the paper tray is loaded.
- The printer is free of paper jams.

Link light

If the printer still does not print, then look at the Link light on the back of the printer:

State of the Link light	Task
Flashing	Resend the document, then look at the Activity light.



(continued)

State of the Link light	Task
	
<p data-bbox="240 350 278 378">Off</p> 	<p data-bbox="516 350 728 378">Verify the following:</p> <ul data-bbox="516 390 1152 512" style="list-style-type: none"> <li data-bbox="516 390 1152 418">• The Ethernet cable is securely connected to the printer. <li data-bbox="516 421 1152 477">• The network hub, switch, or router is on and working properly. <li data-bbox="516 480 1152 508">• The printer is connected to the network.

Activity light

Follow these steps if the Link light is on, but the printer does not print:

1. Wait until the printer is idle.
2. Try to reprint the document.
3. Look at the Activity light on the back of the printer.

State of the Activity light	Task
<p data-bbox="288 894 384 921">Flashing</p> 	<p data-bbox="548 894 1152 949">The Ethernet connection is operating correctly. Try these solutions again.</p>
<p data-bbox="288 1128 326 1156">Off</p> 	<p data-bbox="548 1128 759 1156">Verify the following:</p> <ul data-bbox="548 1168 1152 1347" style="list-style-type: none"> <li data-bbox="548 1168 1152 1223">– The printer is selected in the application from which you are trying to print. <li data-bbox="548 1227 1152 1255">– The computer is connected to the network. <li data-bbox="548 1258 1152 1347">– A personal software firewall might block communication between the printer and the computer. Follow these steps.

Cannot open the printer's embedded web server (EWS)

Verify the following:

- You are not using a phone cord to connect the printer to the network
- The Ethernet cable is securely connected to the printer
- The network [hub](#), [switch](#), or [router](#) is on and working properly
- The computer that you are using is connected to the network

If you still cannot access the printer's EWS, then follow these steps:

1. Print an [HP Report page](#).
2. Find the printer's [IP address](#).
3. Launch the Internet browser.



Note Use Microsoft Internet Explorer 5.0 or higher or Netscape 4.75 or higher.

4. Enter the printer's IP address in the address box, then press **Enter**.

A personal software firewall is blocking communication between the printer and the computer

The personal software firewall is a security program that protects a computer from intrusion. However, the personal firewall might block communication between the computer and the printer.

If you cannot communicate with the printer, try disabling the personal firewall. If you are still unable to communicate with the printer, then re-enable the firewall.

If disabling the firewall allows you to communicate with the printer, you might want to assign the printer a static IP address and then re-enable the firewall. To assign the printer a static IP address, see the Setup guide that came with the printer.

Wireless communication problems

Print a [HP Report page](#).

If the HP Report page *does not* print, verify the following:

- The printer is set up and powered on.
- The [print cartridges are installed](#) correctly.
- The printer is on and the paper tray is loaded.
- The printer is free of paper jams.

If any of these items are problems, then see the [printer is not printing](#) page.

If the HP Report page *does* print, try the following steps:

Check the wireless status light

Look at the printer's [wireless status light](#):

State of the Wireless Status light	Task
On	Follow these steps .

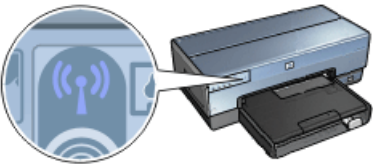

(continued)

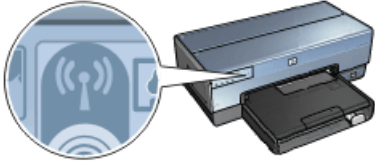
State of the Wireless Status light	Task
<p data-bbox="240 170 278 196">Off</p> 	<p data-bbox="709 170 921 196">Verify the following:</p> <ul data-bbox="709 210 1154 383" style="list-style-type: none"> <li data-bbox="709 210 1154 348">• An Ethernet cable is not connected to the printer. Connecting an Ethernet cable to the printer automatically turns off the wireless radio. Unplug the cable. <li data-bbox="709 354 1021 383">• The printer is plugged in.

Wireless status light is on

If the wireless status light is on, try reprinting the document, then look at the printer's wireless communications light:

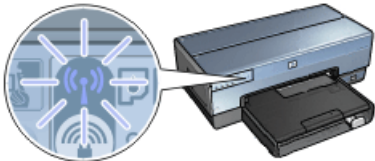
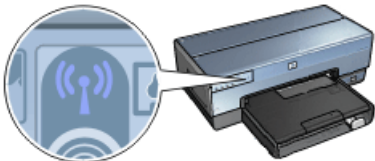
State of the Wireless Status light	Task
<p data-bbox="240 628 328 654">Flashes</p> 	<p data-bbox="709 628 1131 715">The printer's wireless communications feature is operating correctly. Try these solutions, again.</p>
<p data-bbox="240 899 398 925">Does not flash</p> 	<p data-bbox="709 899 1137 986">The wireless radio is functioning but the printer and the computer cannot communicate.</p> <ul data-bbox="709 991 1150 1286" style="list-style-type: none"> <li data-bbox="709 991 1150 1078">• The printer's network settings do not match the settings for the network. Follow these steps. <li data-bbox="709 1083 1150 1170">• The computer might be set to the wrong wireless profile. Follow these steps. <li data-bbox="709 1175 1150 1286">• A personal software firewall might block communication between the printer and the computer. Follow these steps.

Printer's network settings do not match the settings for the network

The printer's network settings must match those of the network.

Printer has the wrong network settings

1. Do one of the following to find the settings for the network:

Printer communication mode	Task
Infrastructure network	Open the Wireless Access Point's (WAP) configuration utility.
Ad hoc network	Open the configuration utility for the network card installed in the computer.

2. Compare the network's settings to those that appear on the HP Report page. Note any differences. Possible problems include:

Problem	Solution
The WAP filters hardware addresses (MAC addresses).	Follow these steps .
One of these settings in the printer might be incorrect: <ul style="list-style-type: none">– Communication mode– Network Name (SSID)– Channel (Ad hoc networks only)– Authentication Type– Encryption– WPA (TKIP)	Follow these steps .

3. Reprint the document.

If the document still does not print, then reset the printer to its [factory defaults](#) and use the printer software CD to reinstall the printer software.

Computer's wireless card is set to the wrong wireless profile

A [wireless profile](#) is a set of network settings unique to a given network. A single wireless card might have several wireless profiles (for example, one for a home network and one for an office network).

Open the configuration utility for the network card installed on the computer and verify that the profile selected is the profile for the printer's network. If not, select the correct profile.

The radio signal is weak

If the printer is printing slowly, then the radio signal might be weak. [Print an HP Report page](#) and look at the radio signal strength numbers (5 indicates an excellent signal; 1 indicates a poor signal). If the signal is weak, then follow the guidelines below.

Reduce interference in a wireless network

The following tips will help reduce the chances for interference in a wireless network:

- Keep the wireless devices away from large metal objects, such as filing cabinets, and other electromagnetic devices, such as microwaves and cordless telephones, as these objects can disrupt radio signals.
- Keep the wireless devices away from large masonry structures and other building structures as these objects can absorb radio waves and lower signal strength.
- For an infrastructure network, position the WAP in a central location in line of sight with the wireless devices on the network.
- Keep all wireless devices on the network within range of one another.

A personal software firewall is blocking communication between the printer and the computer

The personal software firewall is a security program that protects a computer from intrusion. However, the personal firewall might block communication between the computer and the printer.

If you cannot communicate with the printer, try disabling the personal firewall. If you are still unable to communicate with the printer, then re-enable the firewall.

If disabling the firewall allows you to communicate with the printer, you might want to assign the printer a static IP address and then re-enable the firewall. To assign the printer a static IP address, see the Setup guide that came with the printer.

The wireless access point filters MAC addresses

MAC filtering is a security feature in which a [Wireless Access Point \(WAP\)](#) is configured with a list of [MAC addresses](#) (also called "hardware addresses") of devices that are allowed to gain access to the network through the WAP.

If the WAP does not have the hardware address of a device attempting to access the network, the WAP denies the device access to the network.

If the WAP filters MAC addresses, then the printer's MAC address must be added to the WAP's list of accepted MAC addresses.

1. Print an [HP Report page](#).
2. Find the printer's hardware address on the HP Report page.
3. Open the WAP's configuration utility, then add the printer's hardware address to the list of accepted MAC addresses.

Printer has the wrong network settings

If one of these network settings in the printer is incorrect, you will not be able to communicate with the printer:

- [Communication mode](#)
- [Network Name \(SSID\)](#)
- [Channel \(Ad hoc networks only\)](#)
- [Authentication Type](#)
- [Encryption](#)
- [WPA](#)

Follow these steps to correct the printer's network settings:

1. Connect the printer to the network or computer with an Ethernet cable.
2. Open the printer's [embedded Web server \(EWS\)](#).
3. Click the **Networking** tab, and then click **Wireless (802.11)** under the **Connections** heading.
4. Use the Wireless Setup wizard on the **Wireless Setup** tab to change the printer's settings to match the settings of the network.
5. Close the printer's EWS, then disconnect the Ethernet cable from the printer.

Printer does not print

Verify the following

Verify the following conditions if the printer is not printing:

- The printer is connected to the power source.
- The cable connections are secure.
- The printer is turned on.
- The print cartridges are the [correct print cartridges](#) for the printer and are [properly installed](#).
- The paper or other media is correctly loaded in the In tray.
- The printer cover is closed.
- The rear access door is attached.

Check the printer lights

The printer lights indicate the printer status and alert you to potential problems.

For more information, see [Printer lights are on or flashing](#).

Check the printer cable connection

If your printer and computer are USB-connected and are not communicating with each other, try the following:

- Make sure the power cord is firmly connected to the printer and plugged into a power outlet.
- Check the USB cable. If you are using an older cable, it might not be working properly. If you experience problems, the USB cable might need to be replaced. Also verify that the cable does not exceed 3 meters (9.8 feet) in length.
- Check the connection from your printer to your computer. Verify that the USB cable is securely plugged into the USB port on the back of your printer. Make sure the other end of the USB cable is plugged into a USB port on your computer. After the cable is connected properly, turn your printer off and then on again.
- If you are connecting the through a USB hub, make sure the hub is turned on. If the hub is on, try connecting directly to your computer.
- Try connecting the USB cable to another USB port on your computer. After you check the connections, try restarting your computer. Turn your printer off and then on again.

Check the print queue

The printer will not print if a print job is stalled in the print queue. To resolve a print job that is stalled in the queue, complete the following steps:

1. For Windows 2000, click **Start**, click **Settings**, and then click **Printers**. For Windows XP, click **Start**, and then click **Printers and Faxes**.
2. Double-click the name of the HP Deskjet printer.
3. Click the **Printer** menu, and then click **Pause Printing**.
4. Click the **Printer** menu again, and then click **Cancel all documents**.
5. Click **Yes**.
6. Click the **Printer** menu, and then click **Resume Printing**.
7. If there are still documents in the list, restart the computer.
8. After restarting, if there are still documents in the list, repeat steps 1–6.

If the printer still does not print

1. Select the topic below that best describes the problem:
 - [Paper jam](#)
 - [Out-of-paper message](#)
 - [Printer ejects paper](#)
 - [Printer is stalled](#)
2. If the printer still does not print, shut down, and then restart the computer.

Paper jam

Follow these steps to remove a paper jam:

1. Press the **Resume** button.
If the paper jam does not clear, then go to the next step.
2. Turn off the printer.
3. Push the two latch handles on the printer's rear access door toward each other, and then remove the door.

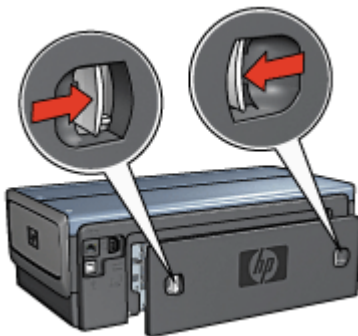

4. Remove any paper that is inside the printer by pulling it out from the back of the printer.
If you are printing labels, verify that a label did not become detached from the label sheet while passing through the printer.
5. Replace the rear access door securely.

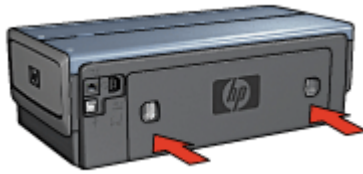

6. If the paper jam cannot be removed from the back of the printer, raise the printer cover, remove the paper jam from the front of the printer, and then lower the cover.

 **Caution** Remove the paper jam carefully as it is possible to damage the printer when removing paper from the front.

7. Turn on the printer, and then press the **Resume** button.
8. Reprint the document.



Note If paper jams occur frequently, try using a heavier paper. See the reference guide for paper weight specifications.

Accessories?



If the Two-Sided Printing Accessory is attached to the printer, follow these steps to clear a paper jam from the [Two-Sided Printing Accessory](#).



If the Auto Two-Sided Print Accessory with Small Paper Tray is attached to the printer, follow these [steps to clear a paper jam Auto Two-Sided Print Accessory with Small Paper Tray](#).

Paper problems

Printer does not feed paper

Try one or more of the following solutions:

- Reduce the number of sheets in the In tray.
- Remove the paper from the In tray, and then reload it.
- Use a different type of paper.

Printer ejects paper

If the printer ejects the paper, try one of the following solutions:

- Move the printer away from direct sunlight. The printer might have been placed in direct sunlight, which can affect the [Automatic Paper-Type Sensor](#).
- Select a [paper type](#) other than Automatic.

- If you are performing a [color calibration](#), install both the tri-color and the photo print cartridges.
- If you are printing a borderless document and the Resume and Print Cartridge Status lights are flashing, follow the [borderless printing](#) guidelines.
- Verify that the protective piece of plastic tape has been removed from the print cartridges.
- If you are printing a borderless document and the Resume light and a Print Cartridge Status light are flashing, you might be trying to print a borderless document with only the black print cartridge installed. When printing a borderless document, always have the tri-color print cartridge and a black or photo print cartridge installed.

Out-of-paper message

If an out-of-paper message is displayed, follow these [guidelines](#).

Paper jam

For information about clearing a paper jam, see the [paper jam](#) page.

Printer prints on multiple sheets at once

If the printer prints on multiple sheets at once, follow these [guidelines](#).

Printer prints on multiple sheets at once

If the printer prints on multiple sheets at once, check the following:

Paper weight

The printer might print on multiple sheets of paper at once if the paper is under the recommended paper weight. Use paper that is within the recommended specifications. For paper weight specifications, see the reference guide that came with the printer.

Paper might be loaded improperly

The printer might print on multiple sheets of paper at once if the paper is loaded too far toward the back of the printer or if the paper guide is not positioned firmly against the paper. Reload the paper into the In tray, pushing the paper until you feel resistance, and then slide the paper guide firmly against the edge of the paper stack.

The printer might also print on multiple sheets at once if different paper types are loaded in the In tray. For example, photo paper might be mixed with plain paper. Empty the In tray and load only the paper type that is appropriate for the document that you are printing.

Paper mismatch

If you receive an error message about a paper mismatch, it indicates that the paper size or type selected in the software program or in the [printer software](#) does not match the paper in the In tray.

You can continue printing with the mismatched paper by pressing the **Resume** button. To cancel printing, press the **Cancel** button.

To correct the paper mismatch, change the paper size and type selections in the software program or the [printer software](#), or change the paper in the In tray.

In the software program, follow these steps:

1. Press the **Cancel** button.
2. Open the **File** menu, and then click **Page Setup**.
3. On the **Page Setup** screen, verify the selected paper size and type.
If the paper size and type match the paper in the In tray, proceed to step 2 below.
If the size and type do not match, select the matching paper size and type or change the paper in the In tray.
4. Press the **Resume** button to continue printing.

In the [printer software](#), follow these steps:

1. Press the **Cancel** button.
2. Open the [Printer Properties](#) dialog box.
3. On the **Paper/Quality** tab, verify that the selected paper size and type match the paper in the In tray.
If the size and type do not match, select the matching paper size and type or change the paper in the In tray.
4. Press the **Resume** button to continue printing.

Printer is stalled

If the printer stalls while printing a document, press the **Resume** button. If the printer does not start printing again, raise the printer cover, and then disconnect the power cable from the back of the printer.



Caution First, check for any loose or broken parts in the printer. If you find loose or broken parts, go to www.hp.com/support or contact HP. Support phone numbers are listed in the reference guide that came with the printer or at www.hp.com/support.

If there are no loose or broken parts, follow these steps:

1. Check for and remove any obstacles, such as packing tape or materials, that prevent the print cartridges from moving back and forth.
2. Make sure the print cartridges are [installed](#) securely in the print cartridge cradle.
3. Make sure the tri-color print cartridge is [installed](#) in the left side of the cradle and the black or photo print cartridge is installed in the right side of the cradle.
4. Check for and clear any [paper jam](#).
5. Lower the printer cover.
6. Connect the power cable to the back of the printer, and then turn on the printer.
 - If the Resume light is not flashing, continue printing the document.
 - If the Resume light is flashing, press the **Resume** button.
If the light still flashes, repeat the steps.

Print cartridge problems

Incorrect print cartridge

The printer can only print when the correct print cartridges are installed. If you receive a print cartridge error message, one or both of the print cartridges cannot be used in the printer. A flashing Print Cartridge Status light indicates which print cartridge is incorrect.

To verify that you have the correct print cartridges:

1. Open the printer cover.
2. Read the selection number on the print cartridge label.

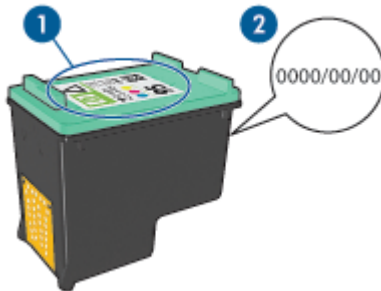

1	Selection number
2	Warranty date

3. Check the list of print cartridges that can be used in the printer.
 - a. Open the printer [Toolbox](#).
 - b. Click the **Estimated Ink Level** tab.
 - c. Click the **Print Cartridge Information** button and view the list of print cartridge selection numbers.

The reference guide that came with the printer also shows the print cartridge selection numbers.

4. Check the warranty date on the print cartridge.
5. If the print cartridge has the wrong selection number, or if the warranty date has expired, [install a new print cartridge](#).
6. Close the printer cover.

If the Print Cartridge Status light stops flashing, then the problem is fixed.

If the Print Cartridge Status light continues to flash, visit HP Technical Support at www.hp.com/support.

Print cartridge problem message

If you receive a message about a problem with one of the print cartridges, follow these steps:

1. Raise the printer cover and remove the print cartridge that was named in the error message.
2. [Reinstall](#) the print cartridge.

If the Print Cartridge Status light is not flashing, the problem is solved.

If the Print Cartridge Status light is flashing, go to the next step.

3. **Manually clean** the print cartridge.
4. Reinsert the print cartridge in the printer and close the printer cover.
If the Print Cartridge Status light is still flashing, the print cartridge is faulty and must be **replaced**.



Note You can print with one print cartridge in **ink-backup mode** if you do not have a replacement print cartridge available.

5. If the Print Cartridge Status light continues to flash after replacing the print cartridge, visit HP Technical Support at www.hp.com/support.

"Printing in ink-backup mode" message

When the printer detects that only one print cartridge is installed, ink-backup mode is initiated. This printing mode lets you print with a single print cartridge, but it slows the printer and affects the quality of printouts.

If you receive the ink-backup mode message and two print cartridges are installed in the printer, verify that the plastic tape has been removed from each print cartridge. When the protective piece of plastic tape covers the print cartridge contacts, the printer cannot detect that the print cartridge is installed.

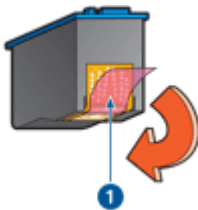

1 Remove plastic tape

"Print cartridge is in the wrong slot" message

If you receive this error message, the print cartridge is installed in the wrong side of the print cartridge cradle.

Always install the tri-color print cartridge in the *left* print cartridge cradle compartment.

Install the black or photo print cartridge in the *right* print cartridge cradle compartment.



Note To easily identify the correct side of the cradle in which to install the print cartridge, match the symbol on the print cartridge with the symbol above the print cartridge cradle.

Photos do not print correctly

Check the paper tray

1. Verify that the photo paper in the In tray with the side to be printed on facing down.
Verify that the photo paper is flat.

2. Slide the paper forward until it stops.
3. Slide the paper guides firmly against the edge of the paper.
Do not press the guide so firmly against the paper that the paper bends or curls.

Check the printer properties

Open the [Printer Properties](#) dialog box and verify the following options:

Tab	Setting
Paper/Quality	Size is: An appropriate paper size Type is: An appropriate photo paper Print Quality: Best or Maximum dpi

Colors are tinted or incorrect

If colors in photos appear tinted or incorrect, follow these steps:

1. Verify that neither print cartridge is [low on ink](#).
If neither print cartridge is low on ink, proceed to step 2.
2. [Align](#) the print cartridges.
3. Reprint the photo.
4. If colors are still tinted or incorrect, [calibrate the color](#).
Both a photo print cartridge and a tri-color print cartridge must be installed for color calibration.
5. Reprint the photo.
6. If colors continue to appear tinted or incorrect, open the [Printer Properties](#) dialog box, click the **Color** tab, and then click the **Advanced Color Settings** button.
7. Adjust the colors by using the Advanced Color Settings dialog box.

Horizontal lines appear on a photo



If light or dark horizontal lines appear on photos, follow this procedure:

1. [Clean](#) the print cartridges.
2. Reprint the photo.
3. If horizontal lines still occur, [align the print cartridges](#).
4. Reprint the photo.

Part of the photo is faded

If part of the photo is faded, follow these [guidelines](#).

Part of the photo is faded

Fading might occur on the edges or near the edges of a photo.

Fading occurs on the edges of a photo



Verify that the photo paper is not curled. If the photo paper is curled, place the paper in a plastic bag and gently bend it in the opposite direction of the curl until the paper lies flat. If the problem persists, then use photo paper that is not curled.

For instructions about preventing photo paper from curling, see [Store and handle photo paper](#).

Fading occurs near the edges of a photo



If fading occurs approximately 25 to 63 mm (1.0 to 2.5 inches) from the edge of a photo, try the following solutions:

- Install a [photo print cartridge](#) and a tri-color print cartridge in the printer.
- Open the [Printer Properties](#) dialog box, click the **Paper/Quality** tab, and then set the **Print Quality** to **Maximum dpi**.
- Rotate the image 180°.

PictBridge problems

Images in a connected digital camera do not print

There are several reasons why images in a connected digital camera do not print:

- The digital camera is not PictBridge-compatible.
- The digital camera is not in PictBridge mode.
- The images are not in a supported format.
- You did not select any photos on the camera for printing.

Check the documentation that came with the camera to ensure it supports PictBridge.

If the camera does support PictBridge, make sure the camera is set to PictBridge mode. For instructions on setting the camera to PictBridge mode, see the documentation that came with the camera.

Verify that the digital camera is saving photos in a file format that the PictBridge transfer feature supports:



- EXIF/JPEG
- JPEG

Before you connect the digital camera to the front USB port on the printer, select some photos on the camera for printing.

PictBridge lights are flashing

State of the lights	Task
<p>Connection light and the Error light are flashing</p> 	<p>The printer has lost connection with the camera while printing. Check the USB connection.</p>
<p>Connection light is on and the Error light is flashing</p>	<p>The camera has lost power. Replace the camera batteries or connect it to a power supply.</p>

(continued)

State of the lights	Task
	
<p>Connection light is on and the Error light flashes twice</p> 	<p>The camera has requested an unsupported command.</p>

Bluetooth printing problems

Bluetooth device cannot find the printer

Try one of the following solutions:

- Make sure the HP Bluetooth Wireless Printer Adapter is plugged into the camera port on the front of the printer. The light on the adapter double-blinks once a second when the adapter is ready to receive data.
- You might be too far from the printer. Move the device with Bluetooth wireless technology closer to the printer. The maximum recommended distance between the device with Bluetooth wireless technology and the printer is 10 meters (30 feet).

No page came out of the printer

The printer might not recognize the type of file sent by the device with Bluetooth wireless technology. Reformat the file to a supported file type and then resend.

A blank page came out of the printer

A blank page ejected from the printer signifies an unsupported file type or the file being printed is corrupted or too large.

Print quality is poor

The image you printed might be low resolution. For better results in the future, set the device to a higher resolution, if possible. Be aware that pictures taken with VGA-

resolution cameras, such as those found in wireless phones, might not have high enough resolution to produce a high-quality print.

The image printed with borders

The printing application installed on the device with Bluetooth wireless technology might not support borderless printing. Contact the vendor of the device, or go to their support website to obtain the latest updates for the printing application.

Bluetooth wireless printer adapter is not working

If the Bluetooth wireless printer adapter does not seem to be working, try the following troubleshooting tips:

- Remove the adapter from the printer for a few seconds, and then re-insert it.
- Turn off the printer with the Bluetooth wireless printer adapter still inserted in the printer, and then turn the printer on again.

Or try this sequence of steps:

1. Turn off the printer.
2. Disconnect the printer from its power source.
3. Insert the Bluetooth wireless printer adapter in the printer.
4. Reconnect power.
5. Turn the printer on.

Banners do not print correctly

Check the paper tray

- Unfold and refold the paper when several sheets feed into the printer at one time.
- Confirm that the unattached edge of the banner paper stack is on top and pointing into the printer.
- Verify that the correct paper for banner printing is in use.

Check the printer properties

Open the [Printer Properties](#) dialog box and verify the following settings:

Tab	Setting
Paper/Quality	Size is: The appropriate banner size Type is: HP Banner Paper

Check the software

- Verify that the software program that you are using prints banners. Not all software programs print banners.
- If gaps appear at the ends of the sheets, verify that the printer software is operating correctly.

Print quality is poor

Streaks and missing lines

If the printed pages are missing lines or dots or if streaks appear, the print cartridges might be [low on ink](#) or might need to be [cleaned](#).

Print is faded

- Verify that neither of the print cartridges is [low on ink](#).
If a print cartridge is low on ink, consider replacing the print cartridge. For the correct part numbers, see the reference guide that came with the printer.
- Verify that a black print cartridge is installed.
If the black text and images on the printouts are faded, you might be printing with only the tri-color print cartridge. Insert a black print cartridge, in addition to the tri-color print cartridge, for optimal black print quality.
- Verify that the protective piece of plastic tape has been removed from the print cartridges.

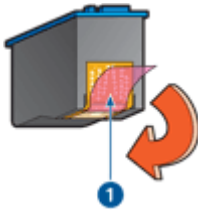

1 | Remove plastic tape

- Consider selecting a higher [print quality](#).

Blank pages print

- The protective piece of plastic tape might still be attached to the print cartridges. Verify that the plastic tape has been removed from the print cartridges.

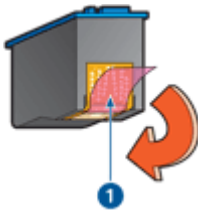

1 | Remove plastic tape

- The print cartridges might be [out of ink](#). Replace one or both empty print cartridges.

- The printer might be in direct sunlight. Direct sunlight can adversely affect the [Automatic Paper-Type Sensor](#). Move the printer out of direct sunlight.
- You might be trying to print a borderless document with only the black print cartridge installed. When printing a borderless document, always have the tri-color print cartridge and a black or photo print cartridge installed.

Too much or too little ink appears on the page

If too much or too little ink appears on the page, [follow these instructions](#).

Too much or too little ink appears on the page

If too much or too little ink appears on the page, try adjusting the ink volume and dry time or selecting a different paper type.

Adjust the ink volume and dry time

1. Open the [Printer Properties](#) dialog box.
2. Click the **Advanced** tab.
3. Click **Document Options**, and then click **Printer Features**.
4. Click **Dry Time**, then select **Change** in the drop-down list, and then click the **Change** button. A **Dry Time** slider is displayed.
5. Move the **Dry Time** slider toward **Less** or **More**.
6. Click **OK**.
7. Click **Ink Volume**, then select **Change** in the drop-down list, and then click the **Change** button. An **Ink Volume** slider is displayed.
8. Move the **Ink Volume** slider toward **Light** or **Heavy**.



Note If you increase the ink volume, move the **Dry time** slider toward **More** to avoid smearing the ink.

9. Click **OK**, and then click **OK** again.

Select a specific paper type

1. Open the [Printer Properties](#) dialog box.
2. Click the **Paper/Quality** tab.
3. In the **Type is** drop-down list, click an appropriate [paper type](#).
Do not select **Automatic**.
4. Click **OK**, and then click **OK** again.

Document is misprinted

Text and images are misaligned

If the text and images on the printouts are misaligned, then [align](#) the print cartridges.

Document is printed off-center or at an angle

1. Verify that the paper is correctly placed in the In tray.
2. Verify that the paper guides fit firmly against the edge of the paper.
3. Reprint the document.

Parts of the document are missing or printed in the wrong place

Open the [Printer Properties](#) and confirm the following options:

Tab	Setting
Finishing	Orientation: Verify the appropriate orientation.
Paper/Quality	Size is: Verify the appropriate paper size.
Effects	Scale to fit: Select this option to scale text and graphics to the paper.
Finishing	Poster printing: Verify that Off is selected.

If parts of the document are still missing, the printer settings might be overridden by the software program print settings. Select the appropriate print settings from within the software program.

Envelope is printed at an angle

1. Slide the flap inside the envelope before loading it in the printer.
2. Confirm that the paper guides fit firmly against the edge of the envelope.
3. Reprint the envelope.

Document does not reflect the new print settings

The printer settings might differ from the software program print settings. Select the appropriate print settings within the software program.

Problems with borderless documents

Borderless printing guidelines

When printing borderless photos or brochures, follow these guidelines:

- Verify that the paper size that is specified in the **Paper Size** drop-down list on the **Printing Shortcuts** tab matches the size of the paper that is loaded in the In tray.
- Select the appropriate paper type in the **Paper Type** drop-down list on the **Printing Shortcuts** tab.
- If printing in grayscale, select **Print in high quality grayscale** on the **Color Option** drop-down list on the **Printing Shortcuts** tab.
- Do not print borderless documents in [ink-backup mode](#). Always have two print cartridges installed in the printer when printing borderless documents.

Streaks appear in a light portion of a photo



If streaks appear in a light portion of a photo, approximately 63 mm (2.5 inches) from one of the long edges of the photo, try the following solutions:

- Install a [photo print cartridge](#) in the printer.
- Rotate the image 180°.
- Open the [Printer Properties](#) dialog box, click the **Paper/Quality** tab, and then set the **Print Quality** to **Maximum dpi**.

Horizontal lines appear on a photo



If light or dark horizontal lines appear on photos:

1. [Clean](#) the print cartridges.
2. Reprint the photo.
3. If the lines still occur, [align](#) the print cartridges.
4. Reprint the photo.

Image is printed at an angle



Verify that no problem exists with the source image. For example, if you are printing a scanned image, verify that the image was not crooked when it was scanned.

If the problem is not caused by the source image, follow these steps:

1. Remove all paper from the In tray.
2. Load the paper correctly in the In tray.

3. Verify that the paper guides fit firmly against the edge of the paper.
4. Follow loading instructions for the paper type.

Ink smears

Follow these guidelines if ink smears appear on the back of the photos, or if the paper sticks together:

- Use an HP photo paper.
- Verify that the photo paper is not curled. If the photo paper is curled, place the paper in a plastic bag and gently bend it the opposite direction of the curl until the paper lies flat.

If the paper is not curled, then follow these steps:

1. Open the [Printer Properties](#) dialog box.
2. Click the **Advanced** tab.
3. Click **Document Options**, and then click **Printer Features**.
4. Click **Dry Time**, then select **Change** in the drop-down list, and then click the **Change** button. A **Dry Time** slider is displayed.
5. Move the **Dry Time** slider toward **More**, and then click **OK**.
6. Click **Ink Volume**, then select **Change** in the drop-down list, and then click the **Change** button. An **Ink Volume** slider is displayed.
7. Move the **Ink Volume** slider toward **Light**, and then click **OK**.



Note The colors in the image might become lighter.

8. Click **OK**.

If the problem persists, try the following steps:

1. Remove the photo paper, and then load plain paper in the In tray.
2. Press and hold down the **Print Cancel** button until the printer starts printing a self-test page, and then release the button.
3. Repeat step 2 until the self-test page contains no ink smears.

Part of the photo is faded

If part of the photo is faded, follow these [guidelines](#).

Photo has unwanted border

If the photo has an unwanted border, follow these [guidelines](#).

Part of the photo is faded

Fading can occur on different parts of a photo.

Fading occurs on the edges of a printout



Verify that photo paper is not curled. If the photo paper is curled, place the paper in a plastic bag and gently bend it in the opposite direction of the curl until the paper lies flat. If the problem persists, then use photo paper that is not curled.

For instructions about preventing photo paper from curling, see [Storing and handling photo paper](#).

Fading occurs near the edges of a photo



If fading occurs approximately 25 to 63 mm (1.0 to 2.5 inches) from the edge of a photo, try the following solutions:

- Install a [photo print cartridge](#) in the printer.
- Open the [Printer Properties](#) dialog box, click the **Paper/Quality** tab, and then set the **Print Quality** to **Maximum dpi**.
- Rotate the image 180°.

Photo has an unwanted border

The following conditions can create an unwanted border.

For most paper types

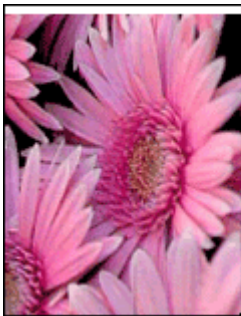

If the photo has an unwanted border, try one of the following solutions:

- [Align the print cartridges](#).
- Open the [Printer Properties](#) dialog box, click the **Paper/Quality** tab, and then verify that the selected paper size matches both the paper size that the photo is formatted for and the size of the paper that is loaded in the In tray.
- Verify that no problem exists with the source image. For example, if you are printing a scanned image, verify that the image was not crooked when it was scanned.

For photo paper with a tear-off tab

If the border appears below the tear-off tab, remove the tab.

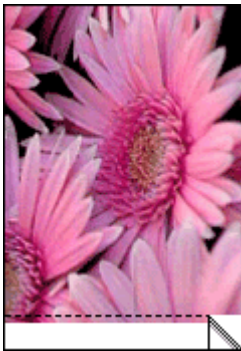

If the border appears above the tear-off tab:

- [Align the print cartridges](#).
- Verify that no problem exists with the source image. For example, if you are printing a scanned image, verify that the image was not crooked when it was scanned.

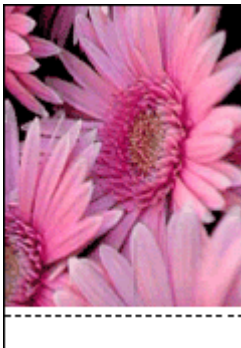

Error messages

Out of paper message

If you receive an out of paper message, follow these [guidelines](#).

"There was an error writing to USB port"

The printer might not be receiving correct data from another USB device or USB hub. Connect the printer directly to the USB port on the computer.

"Two-way communication cannot be established" or "Printer not responding"

The printer might not be able to communicate with the computer if the USB cable is too long.

If you receive this error message, make sure that the USB cable is not greater than 5 meters (approximately 16 feet, 5 inches) in length.

Incorrect print cartridge message

The printer can only print when the correct print cartridges are installed. If you receive an incorrect print cartridge message, [follow these instructions](#).

Print cartridge problem message

If you receive a message stating there is a problem with the print cartridge, the print cartridge might be faulty. Follow [these instructions](#) to resolve the problem.

"Print cartridge carriage is stalled"

Follow [these steps](#) if the printer stalls while you are printing a document.

Paper detected does not match paper size or type selected"

If you receive an error message about a paper mismatch, it indicates that the paper size or type selected in the software program or in the [printer software](#) does not match the paper in the In tray. Follow [these instructions](#) to resolve the problem.

"Print cartridge is in the wrong slot"

If you receive this error message, the print cartridge is installed in the wrong side of the print cartridge cradle.

Always install the tri-color print cartridge in the *left* print cartridge cradle compartment.

Install the black or photo print cartridge in the *right* print cartridge cradle compartment.

"Printing in ink-backup mode"

When the printer detects that only one print cartridge is installed, ink-backup mode is initiated. This printing mode lets you print with a single print cartridge, but it slows the printer and affects the quality of printouts.

If you receive the ink-backup mode message and two print cartridges are installed in the printer, verify that the protective piece of plastic tape has been removed from each print cartridge. When plastic tape covers the print cartridge contacts, the printer cannot detect that the print cartridge is installed.

Out-of-paper message

Follow the appropriate steps for the condition that exists.

If the In tray contains paper

1. Verify the following:
 - A sufficient amount of paper is in the In tray (at least ten sheets).
 - The In tray is not overly full.
 - The paper stack is touching the back of the In tray.
2. Slide the paper guides firmly against the edge of the paper.
3. Press the **Resume** button to continue printing.

If the In tray is empty

1. Load paper in the tray.
2. Press the **Resume** button to continue printing.

Printer lights are on or flashing

The printer lights indicate the printer status.

Wireless Status light is flashing

For information about the Wireless Status light, see the [Wireless Status light page](#).

Power light is flashing

The light stops flashing when the printer has received all data.

The printer is preparing to print.

Resume light is flashing

If the Resume light is flashing, check the following conditions:

- The printer might be out of paper.
Place paper in the In tray, and then press the **Resume** button.
- There might be a paper jam.
Follow these instructions to [clear a paper jam](#).
- The print cartridges are the [correct print cartridges](#) for the printer and are [properly installed](#).
- The printer might be stalled.
Follow these instructions to correct a [stalled printer](#).

Print Cartridge Status light is on or flashing

The printer has two print cartridge status lights.

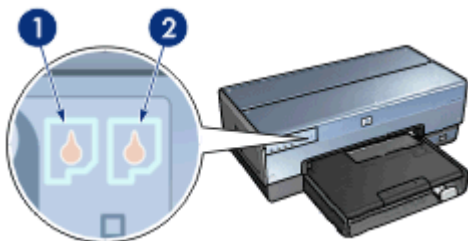

1. The left status light represents the tri-color print cartridge, which is installed in the left side of the print cartridge cradle.
2. The right status light represents the black or the [photo print cartridge](#). One of these print cartridges is installed in the right side of the print cartridge cradle.

If the status light is on and not flashing

- Check to see if a print cartridge is [low on ink](#).
If a print cartridge is low on ink, consider [replacing the print cartridge](#).
- If neither print cartridge is low on ink, press the **Resume** button. If the Print Cartridge Status light remains on, turn off, and then turn on the printer.

If the status light is on and flashing

Verify that the correct [print cartridges](#) are installed.

If you were printing a borderless document when the light started flashing, follow the [borderless printing guidelines](#).

Otherwise, follow these steps:

1. Raise the printer cover, remove the print cartridge on the right, and then lower the cover.
2. Follow one of these steps:
 - If the light is flashing: Open the printer cover, replace the print cartridge that you removed, and then remove the other print cartridge. Proceed to step 3.
 - If the light is off: There is a problem with the print cartridge that you removed. Proceed to step 3.
3. [Manually clean](#) the print cartridge.
After cleaning the print cartridge, reinsert it into the printer.
If the light continues to flash, [replace the print cartridge](#).

All lights are flashing

The printer might need to be restarted.

1. Press the **Power** button to turn off the printer, and then press the **Power** button to restart the printer.
Proceed to step 2 if the lights continue to flash.
2. Press the **Power** button to turn off the printer.
3. Disconnect the printer power cord from the electrical outlet.
4. Reconnect the printer power cord to the electrical outlet.
5. Press the **Power** button to turn on the printer.

Document prints slowly

Multiple software programs are open

The computer resources are insufficient for the printer to print at its optimum speed. To increase printer speed, close all unnecessary software programs when printing.

Complex documents, graphics, or photos are printing

Documents containing graphics or photos print more slowly than text documents.

Best or maximum dpi print mode is selected

The printer prints more slowly when Best or maximum dpi is selected as the print quality. To increase the printer speed, select a different print quality mode.

Printer is in ink-backup mode

The printer might print more slowly if it is in [ink-backup mode](#).

To increase the print speed, use two print cartridges in the printer.

Printer software is outdated

Outdated printer software might be installed.

For information about updating the printer software, see the [software update](#) page.

Computer does not meet system requirements

If the computer does not have enough RAM or a large amount of free space on the hard drive, the printer processing time will be longer.

1. Verify that the computer hard disk space, RAM, and processor speed meet the system requirements.
The system requirements are listed in the reference guide that came with the printer.
2. Make space available on the hard drive by deleting unwanted files.

If you continue to have problems

If you continue to have problems after investigating the troubleshooting topics, shut down the computer and then restart it.

If you still have questions after restarting the computer, visit HP Technical Support at www.hp.com/support.

HP support process

1. Visit HP Technical Support at www.hp.com/support.
HP online service and support is always available to all HP customers for the life of their HP products. It is the fastest source for up-to-date product information and expert assistance, and includes the following features:
 - Fast access to qualified online support specialists
 - Software and printer-driver updates for your product
 - Valuable product and troubleshooting information for common problems
 - Proactive product updates, support alerts, and HP newsgrams that are available when you register your product
2. For Europe only: Contact your local point of purchase.
If your printer has a hardware failure, you will be asked to bring it back to your local point of purchase. (Service is free during the printer limited-warranty period. After the warranty period, you will be quoted a service charge.)
3. Call HP support.

For the appropriate telephone number, see the inside front cover of the Reference Guide that came with your printer. Information about the phone support process can be found in "HP support by phone" in the Reference Guide.

Support options and availability vary by product, country/region, and language.

12 Accessories

The following optional accessories are available to be used with the HP printer.



Automatic Two-Sided
Printing Accessory

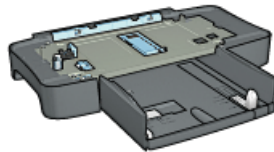

250-Sheet Plain Paper
Tray

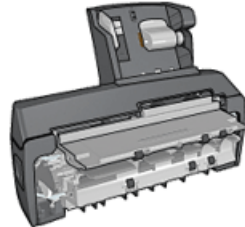

Auto Two-Sided Print
Accessory with Small
Paper Tray

If an accessory is not included with the printer, it can be purchased separately from an authorized HP dealer.

For accessory part numbers, see the [accessory supply list](#).



Note The availability of accessories varies by country/region.

Automatic Two-Sided Printing Accessory (duplexer)

The duplexer is a special hardware device that enables the printer to automatically print on both sides of a page.

Using a duplexer with the printer has several advantages. It allows you to do the following tasks:

- Print on both sides of a page without manually reloading the page.
- Use less paper by printing on both sides of paper sheets.
- Create professional-looking brochures, reports, newsletters, and other special items.

If the duplexer is not packaged with the printer, it can be purchased separately from an authorized HP dealer.



Note The duplexer is not available in all countries/regions.



The duplexer only supports certain paper types. For a list of supported paper types, see the documentation that came with the duplexer.

Install the duplexer

Follow these steps to attach the duplexer to the printer:

1. Push the two latch handles on the printer's rear access door toward each other, and then remove the door.

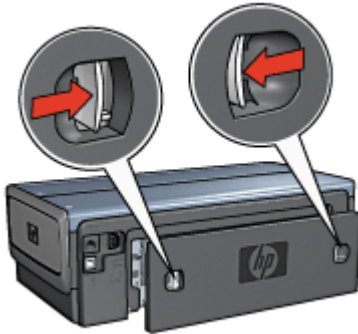

Note Do not discard the rear access door. In order to print, either the duplexer or the rear access door must be attached to the printer.

2. Insert the duplexer in the back of the printer until both sides snap into place.



Note Do not press the buttons on either side of the duplexer when installing it in the printer. Use the buttons only when removing the duplexer from the printer.

Enable the duplexer

Follow these step to enable the duplexer:

1. Open the printer [Toolbox](#).
2. Click the **Configuration** tab.
3. Click **Automatic Two-Sided Printing Module** or **Auto Two-Sided Print Accessory with small paper tray**, and then click **Apply**.

4. Click **OK** in the confirmation box that is displayed.
5. Click the **X** in the upper-right corner to close the screen.



Note After the duplexer is enabled, it is not necessary to re-enable it every time you print.

Automatic two-sided printing

To print a two-sided document automatically, one of the following accessories must be attached to the printer:



Automatic Two-Sided Printing Accessory



Auto Two-Sided Print Accessory with Small Paper Tray

The two-sided printing accessories only support certain paper types. For a list of supported paper types, see the documentation that came with the accessory.

If a two-sided printing accessory is not attached to the printer or you are printing on an unsupported paper type, use manual two-sided printing.

Binding type

Select the type of binding that you want for the two-sided document, and then follow the steps for that binding:

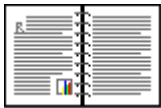

Book binding



Tablet binding



Note Book binding is the most common type of binding.

Book binding

Follow these steps to print a two-sided document with a book binding:

After the first side of the page is printed, the printer pauses while the ink dries. When the ink is dry, the paper is pulled back into the duplexer and the reverse side of the page is printed.

1. Open the [Printer Properties](#) dialog box.
2. Click the **Printing Shortcuts** tab, and then click **Two-sided, duplex, printing** in the drop-down list.

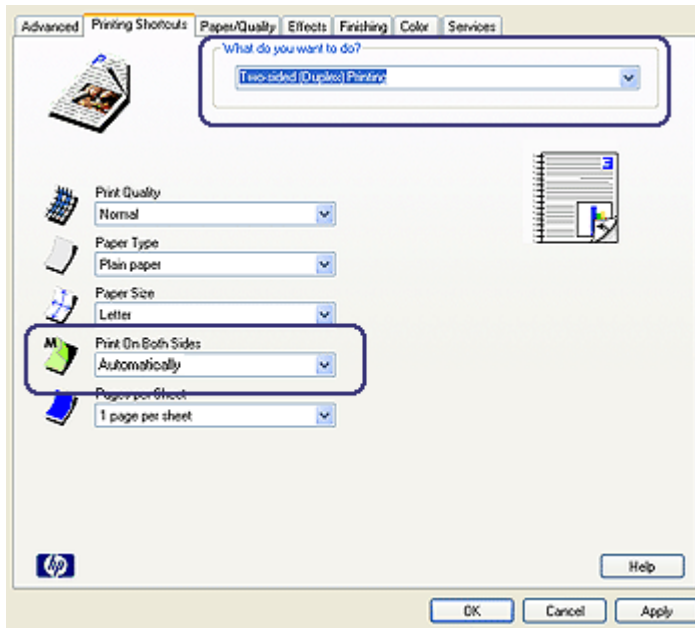

3. In the **Print on both sides** drop-down list, click **Automatically**.
4. Select any other print settings that you want, and then click **OK**.

Do not remove the paper from the printer until both sides of the page have been printed.

Tablet binding

Follow these steps to print a two-sided document with a tablet binding:

After the first side of the page is printed, the printer pauses while the ink dries. When the ink is dry, the paper is pulled back into the duplexer and the reverse side of the page is printed.

1. Open the [Printer Properties](#) dialog box.
2. Click the **Finishing** tab.

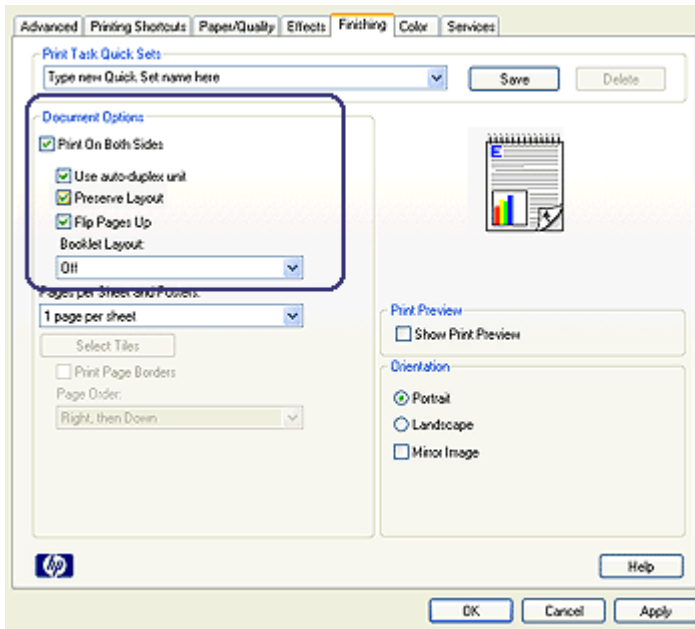

3. Select the **Print on both sides** check box.
4. Select the **Preserve layout** check box.
5. Select the **Flip pages up** check box.
6. Select any other print settings that you want, and then click **OK**.

Do not remove the paper from the printer until both sides of the page have been printed.

Print a booklet automatically

To print a booklet automatically, one of the following accessories must be attached to the printer:



Automatic Two-Sided Printing Accessory



Auto Two-Sided Print Accessory with Small Paper Tray

The two-sided printing accessories only support certain paper types. For a list of supported paper types, see the specifications for either the [Automatic Two-Sided Printing Accessory](#) or the [Auto Two-Sided Print Accessory with Small Paper Tray](#).

If a two-sided printing accessory is not attached to the printer or you are printing on an unsupported paper type, use [manual two-sided printing](#).

Guidelines

Do not exceed the In-tray capacity: 150 sheets.

Print

Load paper in the printer paper tray, and then follow these steps to print a booklet automatically:

1. Open the **Printer Properties** dialog box.
2. Click the **Printing Shortcuts** tab, and then select **Two-sided, duplex, printing** from the drop-down list.

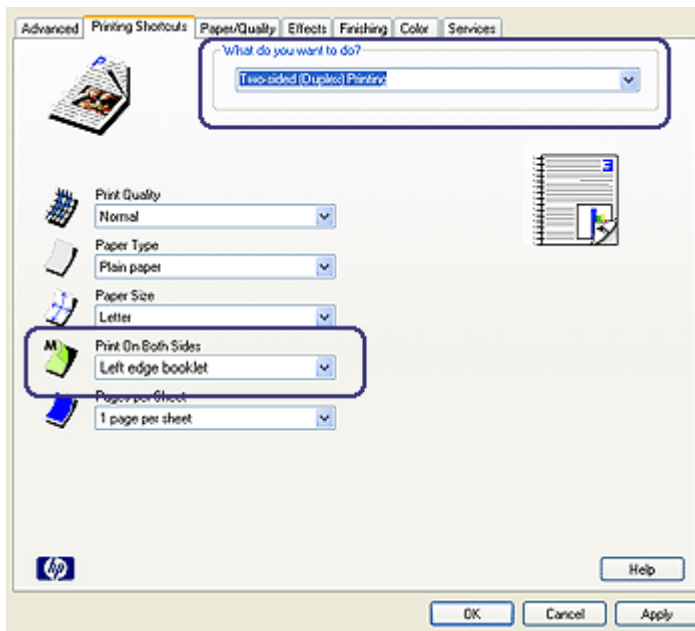

3. From the **Print on both sides** drop-down list, select one of the following binding options:
 - **Left edge booklet**
 - **Right edge booklet**
4. Select any other print settings that you want, and then click **OK**.

After the first side of the page is printed, the printer pauses while the ink dries. When the ink is dry, the paper is pulled back into the duplexer and the reverse side of the page is printed.



Note Do not remove the paper from the printer until both sides of the page have been printed.

Automatic two-sided printing problems

Paper jam occurs inside the Automatic Two-Sided Printing Accessory

Follow these steps to remove a paper jam from the duplexer.

1. Turn off the printer.
2. Press the buttons on the left and right sides of the duplexer, and then remove it from the printer.

 **Warning** Remove the duplexer before opening it when clearing a paper jam.

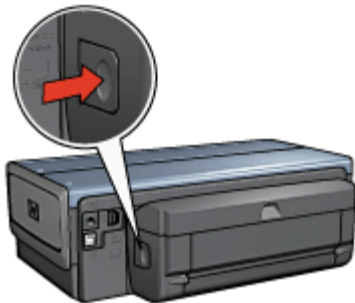

3. Remove any paper inside the printer.
4. Open the duplexer.

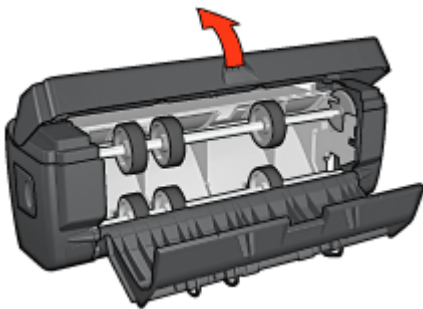

5. Remove any paper from inside the duplexer.
6. Close the duplexer, and then re-attach the duplexer to the printer.

Option for two-sided printing cannot be selected

The printer driver cannot sense the duplexer until a print job is sent to the printer. Print a single sided document, and then print the two-sided document. The option for using the duplexer will appear in the printer software.

If the option for the duplexer still does not appear, verify that the following conditions exist:

- The duplexer is attached to the printer.
- The duplexer is [enabled](#) in the printer software.
- The media type and size selected on the **Paper/Quality** tab are supported by the duplexer.

For a list of supported media types and sizes, see the specifications for the duplexer:

- [Automatic Two-Sided Printing Accessory](#)
- [Auto Two-Sided Print Accessory with Small Paper Tray](#)

Only one side of the page prints when the two-sided printing option is enabled

Verify that the following conditions exist:

- The [correct print options](#) are set in both the printer software and the software program that you are using.
- The photo paper is not curled, if you are printing on two-sided photo paper. Photo paper should be flat before printing. See [storing and handling photo paper](#) for more information.
- If the media type or size is not supported by the duplexer, you can print the document by using the [manual two-sided printing instructions](#).

The media type and size that is selected on the **Paper/Quality** tab are supported by the duplexer.



Note Do not try to print a two-sided document on single-sided paper, such as single-sided photo paper.

Binding margin is in the wrong place

1. Open the [Printer Properties](#) dialog box.
2. Click the **Finishing** tab.
3. Verify that the following conditions exist:
 - **Flip pages up** is not selected for binding along the side (book binding).
 - **Flip pages up** is selected for binding along the top (tablet binding).

For more information, see [two-sided printing](#).

Paper size changes when the two-sided printing option is selected

The paper size is not supported by the duplexer.

Colors look faded

If the colors look faded, try printing the two-sided document by using the [manual two-sided printing instructions](#).

Automatic Two-Sided Printing Accessory specifications

Dimensions when attached to printer

124.6 mm (4.9 in) tall x 320.5 mm (12.62 in) wide x 77.7 mm (3.06 in) deep

Skew (second side of printed page)

Plain paper: +/- .009 mm/mm (.009 in/in)

Cards: +/- .006 mm/mm (.006 in/in)

Envelopes: +/- .012 mm/mm (.012 in/in)

Media weight

Letter/A4: 60 to 90 g/m² (16 to 24 lb)

Cards: Up to 200 g/m² (110 lb index max)

Specialty paper: Up to 160 g/m² (44 lb bond)

Media sizes

Size range: 81 x 117 mm to 216 x 297 mm (3.2 x 4.6 in to 8.5 x 11 in)

Paper:

- U.S. Letter: 216 x 279 (8.5 x 11 in)
- Executive: 184 x 267 mm (7.25 x 10.5 in)
- A4: 210 x 297 mm
- A5: 148 x 210 mm
- B5: 182 x 257 mm

Cards:

- 127 x 203 mm (5 x 8 in)
- 102 x 152 mm (4 x 6 in)
- A6: 105 x 148.5 mm
- Hagaki: 100 x 148 mm
- L size: 89 x 127 mm

250-Sheet Plain Paper Tray

The 250-Sheet Plain Paper Tray Accessory expands the paper capacity of the printer to 400 sheets. It is useful for high-volume printing and for occasions when you want to use the In tray for special media such as letterhead paper, but still have plain paper readily available.

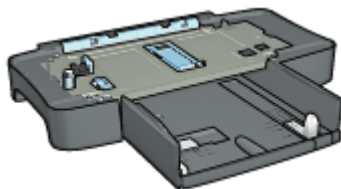

If the 250-Sheet Plain Paper Tray Accessory is not included with the printer, it can be purchased separately from an authorized HP dealer.



Note The 250-sheet Plain Paper Tray Accessory is not available in all countries/regions.

Install the 250-Sheet Plain Paper Tray Accessory

Follow these steps to install the 250-Sheet Plain Paper Tray Accessory:

1. Turn off the printer.
2. Select a location for the printer and place the 250-Sheet Plain Paper Tray Accessory in this location.
3. Carefully lift the printer and orient it above the paper tray.

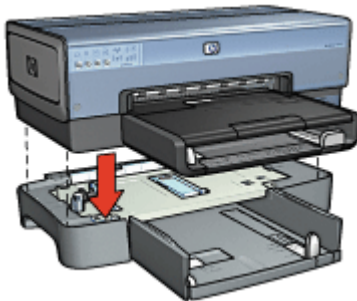

4. Gently place the printer on top of the paper tray.

Load the 250-Sheet Plain Paper Tray Accessory

Follow these instructions to load the 250-Sheet Plain Paper Tray Accessory.

Two parts

The 250-Sheet Plain Paper Tray Accessory has two parts.

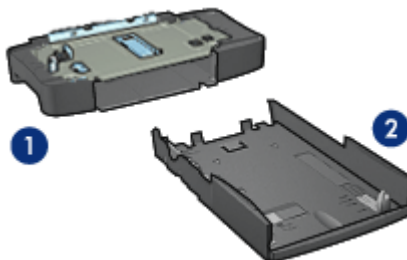

1	Base
2	Lower tray

The lower tray has three size adjusters.

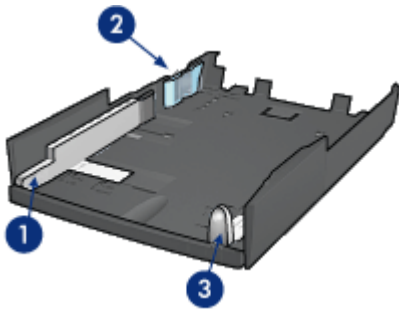

1	Paper-width guide
2	Paper-width fence
3	Paper-length guide



Note When changing the paper size in the paper tray, you must set all three paper guides.

Set the paper size

When changing the paper size in the paper tray, all three paper guides must be set to the correct setting.

Follow these steps to set the paper size:

1. Remove the lower tray from the base.

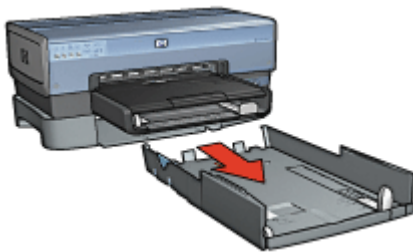

2. Slide the paper-width guide until the arrow is even with the correct setting.

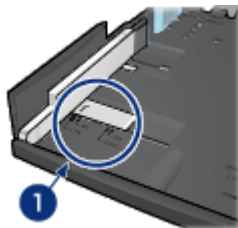

1	Align the arrows
---	------------------



Note To print on legal-sized paper, set the paper-width guide to **LTR**.

3. Set the paper-width fence by carefully inserting it into the appropriate slots.

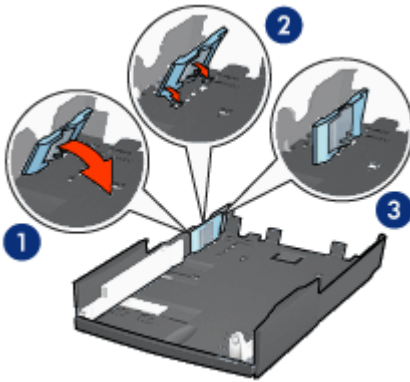

1	Tilt the fence forward
2	Insert the fence into the appropriate slots
3	Tilt the fence back until it locks into place



Note To print on legal-sized paper, set the paper-width guide to **LTR**.

4. Set the paper-length guide by pulling it until the arrow lines up with the paper size.

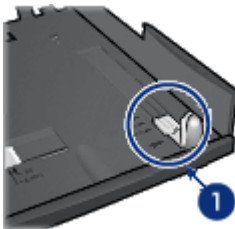

1	Align the arrows
---	------------------



Note To print on legal-sized paper, pull the paper-length guide all the way out.

Load paper

Follow these steps to load paper:

1. Remove the lower tray from the base.
2. Verify that **all three paper guides are set** to the correct setting.
3. Insert the paper into the lower tray.

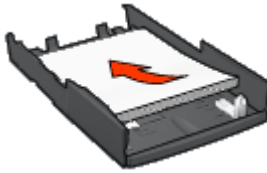

4. Insert the lower tray in the base until it locks into place.

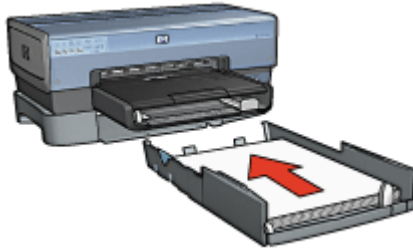

Use the 250-Sheet Plain Paper Tray Accessory

If the 250-Sheet Plain Paper Tray Accessory is not installed on the printer, follow the [installation steps](#).



Note The 250-Sheet Plain Paper Tray Accessory is not available in all countries/regions.

Follow these steps to use the 250-Sheet Plain Paper Tray Accessory:

1. Open the [Printer Properties](#) dialog box.
2. Click the **Printing Shortcuts** tab or the **Paper/Quality** tab.
3. Find the appropriate drop-down list:

Tab	Drop-down list
Printing Shortcuts	Paper source
Paper/Quality	Source is



Note You do not need to set the paper source on both tabs.

4. Select one of the following options in the drop-down list:
 - **Upper tray**: prints from the In tray.
 - **Lower tray**: prints from the 250-Sheet Plain Paper Tray Accessory.
 - **Upper, then lower**: prints from the In tray. If the In tray is empty, the printer prints from the 250-Sheet Plain Paper Tray Accessory.
 - **Lower, then upper**: prints from the 250-Sheet Plain Paper Tray Accessory. If the accessory is empty, the printer prints from the In tray.

250-Sheet Plain Paper Tray Accessory specifications

Dimensions

448 mm (17.64 in) wide x 65 mm (2.56 in) high x 384 (15.12 in) mm deep

Weight

1.99 kg (4.40 lb)

Media weight

Letter/A4 paper: 60 to 105 g/m² (16 to 28 lbs)

Media sizes

US Letter: 216 x 279 mm (8.5 x 11 in)

Executive: 184 x 267 mm (7.25 x 10.5 in)

A4: 210 x 297 mm

A5: 148 x 210 mm

B5: 182 x 257 mm

Auto Two-Sided Print Accessory with Small Paper Tray

The Auto Two-Sided Print Accessory with Small Paper Tray is a hardware device that contains a rear tray for small media and a duplexer for two-sided printing on both full-size and small media.

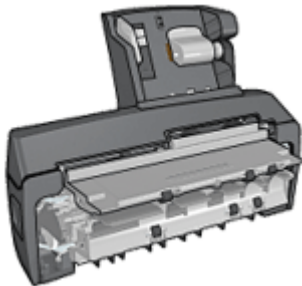

- [Postcards](#) and other small media can be printed on two sides automatically when they are fed from the rear tray.
- [Photo paper](#) and [envelopes](#) can be printed on one side by using the small paper tray.
- Print [two-sided documents automatically](#).

If the Auto Two-Sided Print Accessory with Small Paper Tray is not included with the printer, it can be purchased separately from an authorized HP dealer.



Note The Auto Two-Sided Print Accessory with Small Paper Tray is not available in all countries/regions.

Install the Auto Two-Sided Print Accessory with Small Paper Tray

Use these steps to install the Auto Two-Sided Print Accessory with Small Paper Tray:

1. Push the two latch handles on the printer rear access door toward each other, and then remove the door.

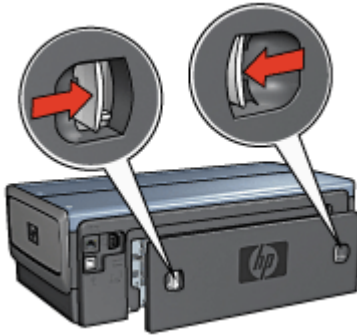

Do not discard the rear access door. In order to print, the accessory or the rear access door must be attached to the printer.

2. Insert the accessory into the back of the printer until both sides snap into place.



Note Do not press the buttons on either side of the accessory when installing it into the printer. Use the buttons only when removing the accessory from the printer.

Enable the duplexer

Follow these step to enable the duplexer:

1. Open the printer [Toolbox](#).
2. Click the **Configuration** tab.
3. Click **Automatic Two-Sided Printing Module** or **Auto Two-Sided Print Accessory with small paper tray**, and then click **Apply**.

4. Click **OK** in the confirmation box that is displayed.
5. Click the **X** in the upper-right corner to close the screen.



Note After the duplexer is enabled, it is not necessary to re-enable it every time you print.

Print postcards

Guidelines

- Use only cards that meet the specifications for the Auto Two-Sided Print Accessory with Small Paper Tray. For more information, see the [Auto Two-Sided Print Accessory with Small Paper Tray specifications](#).
- When printing a large number of cards, remove the printed material from the printer's Out tray about halfway through the print job.
- Do not exceed the maximum capacity for the rear tray: 100 cards.

Prepare to print

1. Slide the paper-width guide to the left.
2. Pull the paper lever forward and insert the cards.
The address side of the cards should face outward.

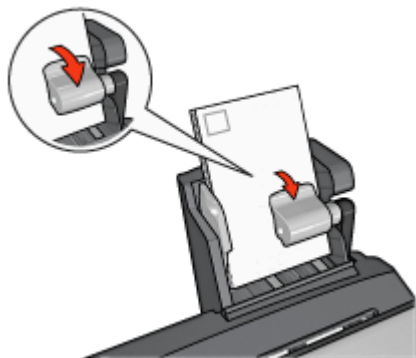

3. Release the paper lever.
4. Slide the paper-width guide against the edge of the cards.

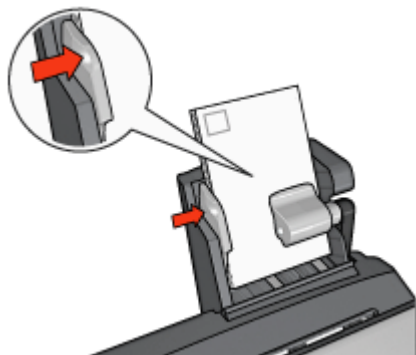

Print

1. Open the [Printer Properties](#) dialog box.
2. On the **Printing Shortcuts** tab, click **Postcard printing**, and then specify the following print settings:
 - **Paper Size:** The appropriate paper size
 - **Paper Type:** **Plain paper**
 - **Paper Source:** **Rear tray**
3. Select any other print settings that you want, and then click **OK**.

Use the [What's This? help](#) to learn about the features that you see in the Printer Properties dialog box.

Use the Auto Two-Sided Print Accessory with Small Paper Tray when printing from a digital camera

In order to use the Auto Two-Sided Print Accessory with Small Paper Tray when printing directly from a digital camera, you might need to configure the printer to feed paper from the accessory rather than the In tray.

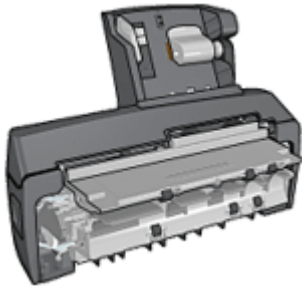

Configure the printer to feed paper from the accessory

Follow these steps to configure the printer to feed paper from the accessory:

1. Press and hold down the **Report Page** button.
2. While holding down the **Report Page** button, press the **Cancel** button twice.
3. Release the Report Page button.

After configuring the printer to feed paper from the accessory, [load the photo paper into the accessory](#) and then follow the [PictBridge printing instructions](#).



Note The printer only needs to be configured to print PictBridge photos from the Auto Two-Sided Print Accessory with Small Paper Tray once. After being configured, the printer will attempt to print from the accessory until the printer is configured to use the In tray for PictBridge photos.

Configure the printer to feed paper from the In tray

Follow these steps to configure the printer to feed paper from the In tray for PictBridge photos:

1. Press and hold down the **Report Page** button.
2. While holding down the **Report Page** button, press the **Cancel** button twice, and then press the **Resume** button once.
3. Release the **Report Page** button.

Print small photos

Guidelines

- For high-quality results, use a [photo print cartridge](#) in combination with the tri-color print cartridge.
- For maximum fade resistance, use HP Premium Plus Photo Paper and install a photo print cartridge in the printer.
- To learn how to use the available [photo printing features](#).
- Use [HP Everyday Photo Paper, Semi-gloss](#) to save money and ink when printing photos.
- Verify that the photo paper that you are using is flat. For information about preventing photo paper from curling, see the [photo paper storage instructions](#).
- Do not exceed the In-tray capacity: 80 sheets of photo paper.

Prepare to print

1. Slide the paper-width guide to the left.
2. Pull the paper lever forward and insert the photo paper.
The side of the photo paper to be printed on should face outward.



Note If the photo paper has a tear-off tab, the tab must point up rather than leading into the printer.

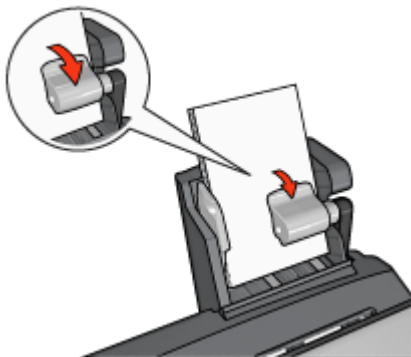

3. Release the paper lever.
4. Slide the paper-width guide against the edge of the photo paper.

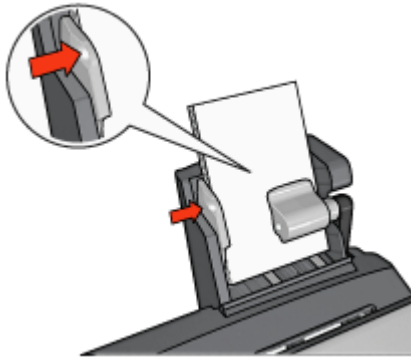

Print

1. Open the [Printer Properties](#) dialog box.
2. On the **Printing Shortcuts** tab, click **Photo printing-borderless** or **Photo printing-with white borders** as the type of document, and then select the following options:
 - **Print quality:** **Normal**, **Best**, or **Max dpi**
 - **Paper size:** The appropriate photo paper size
 - **Paper source:** **Rear tray**
 - **Paper type:** The appropriate photo paper type
 - **Orientation:** **Portrait** or **Landscape**
3. Set the following options as appropriate:
 - [HP digital photography options](#)
 - [Advanced color settings](#)
 - [Color management](#)
 - [Grayscale quality](#)
4. Click **OK** to print the photographs.

Use the [What's This? help](#) to learn about the features that you see in the Printer Properties dialog box.

Print envelopes

Guidelines

- Avoid using envelopes that have the following qualities:
 - Have clasps or windows
 - Have thick, irregular, or curled edges
 - Are shiny or embossed
 - Are wrinkled, torn, or otherwise damaged
- Align the envelope edges before inserting them in the rear tray.
- Do not exceed the maximum capacity of the rear tray capacity: 80 envelopes.

Prepare to print

1. Slide the paper-width guide to the left.
2. Pull the paper lever forward and insert the envelopes.
Insert the envelopes with the address side facing outward and the flap to the left.

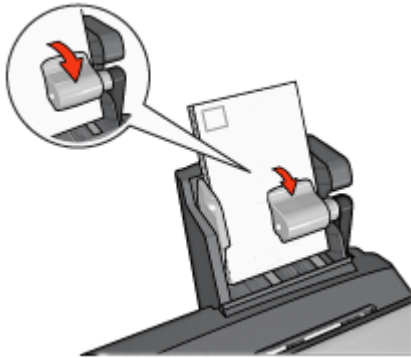

3. Release the paper lever.
4. Slide the paper-width guide against the edge of the envelopes.

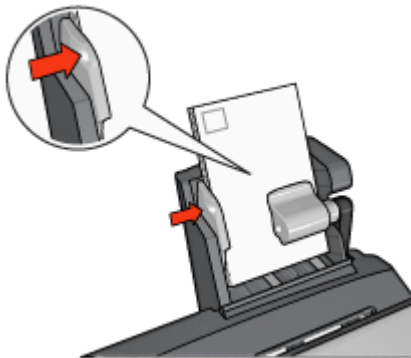

Print

1. Open the [Printer Properties](#) dialog box.
2. Click the **Paper/Quality** tab, and then specify the following print settings:
 - **Size is:** The appropriate envelope size
 - **Type is:** The appropriate paper type
 - **Source is:** **Rear tray**
3. Select any other print settings that you want, and then click **OK**.

Use the [What's This? help](#) to learn about the features that you see in the Printer Properties dialog box.

Problems with the Auto Two-Sided Print Accessory with Small Paper Tray

Paper jam

Do **not** clear a paper jam from the front of the printer.

Follow these steps to remove a paper jam from the Auto Two-Sided Print Accessory with Small Paper Tray:

1. Turn off the printer.
2. Press the buttons on the left and right sides of the accessory, and then remove it from the printer.

 **Warning** Remove the Auto Two-Sided Print Accessory with Small Paper Tray before opening it when clearing a paper jam.

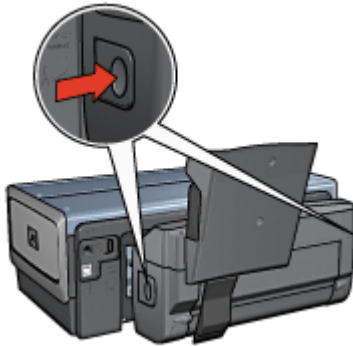

3. Remove any paper that is inside the printer.
4. Lift the back lever on the accessory, and then unhook the Small Paper Tray.

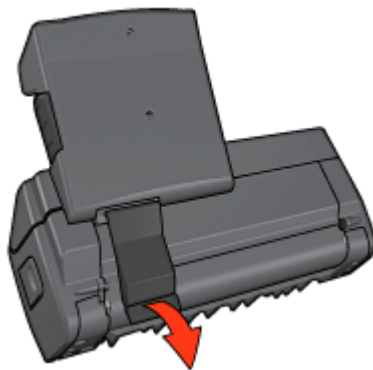

5. Tilt the Small Paper Tray forward and open the lower door of the accessory.

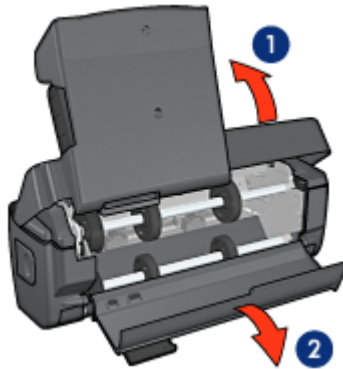

1	Tilt the Small Paper Tray
2	Open the lower door

6. Remove any paper that is inside the accessory.
7. Close the accessory, and then secure the back lever to close the accessory.
8. Re-attach the accessory to the printer.



Option for two-sided printing cannot be selected

The printer driver cannot sense the duplexer until a print job is sent to the printer. Print a single sided document, and then print the two-sided document. The option for using the duplexer will appear in the printer software.

If the option for the duplexer still does not appear, then verify that the following conditions exist:

- The duplexer is attached to the printer.
- The duplexer is [enabled](#) in the printer software.
- The media type and size selected on the Paper/Quality tab are supported by the duplexer.

For a list of supported media types and sizes, see the specifications for the duplexer:

- [Automatic Two-Sided Printing Accessory](#)
- [Auto Two-Sided Print Accessory with Small Paper Tray](#)

Paper size changes when the two-sided printing option is selected

The paper size is not supported by the [duplexer](#).

Binding margin is in the wrong place

1. Open the [Printer Properties](#) dialog box.
2. Click the **Finishing** tab.
3. Verify that the following conditions exist:
 - **Flip pages up** is not selected for binding along the side (book binding).
 - **Flip pages up** is selected for binding along the top (tablet binding).

For more information, see [two-sided printing](#).

Only one side of the page prints when the two-sided printing option is enabled

Verify that the following conditions exist:

- The [correct print options](#) are set in both the printer software and the software program that you are using.
- The photo paper is not curled, if you are printing on two-sided photo paper. Photo paper should be flat before printing. See [storing and handling photo paper](#) for more information.
- The media type and size that is selected on the **Paper/Quality** tab are supported by the [duplexer](#).

If the media type or size is not supported by the duplexer, you can print the document by using the [manual two-sided printing instructions](#).



Note Do not try to print a two-sided document on single-sided paper, such as single-sided photo paper.

Colors look faded

If the colors look faded, try printing the two-sided document by using the [manual two-sided printing instructions](#).

Auto Two-Sided Print Accessory with Small Paper Tray specifications

Dimensions when attached to printer

219.3 mm (8.63 in) tall x 320.5 mm (12.62 in) wide x 142.1 mm (5.6 in) deep

Duplexing specifications

For duplexing specifications, including skew, media weight, and media sizes for paper fed into the printer through the printer In tray, see the [Automatic Two-Sided Printing Accessory specifications](#).

Small paper tray specifications

Media thickness: 7-12 mils

Media sizes:

- Size range:
 - Width: 81.3 to 106 mm (3.2 to 4.17 in)
 - Length: 116.8 to 304.8 mm (4.6 to 12 in)
- Cards:
 - 10x15 cm, 10x15 cm with tab
 - 4x6 in, 4x6 in with tab
 - A6, 105x148 mm
 - Index card, 4x6 in.
 - L, 89x127 mm
- Photo paper:
 - 10x15 cm, 10x15 cm with tab
 - 4x6 in, 4x6 in. with tab
 - A6, 105x148 mm
 - L, 89x127 mm, L, 89x127 mm with tab
 - Panoramic 4x10 in, 4x11 in, 4x12 in
- Envelopes:
 - No. 10 Envelope, 4.12x9.5 in
 - Japanese envelope No. 4, 90x205 mm
- Hagaki:
 - Hagaki, 100x148 mm

Tray capacities:

- Photo paper:
 - 4x6, L size: Up to 80 sheets
 - Panoramic: Up to 5 sheets
- Hagaki:
 - Photo: Up to 80 cards
- Cards:
 - 4x6: Up to 100
 - A6: Up to 100
- Envelopes:
 - No. 10: Up to 20
 - Japanese envelope No. 4: Up to 20

13 Supplies

- Paper
- USB cables
- Accessories
- Print cartridges



Note The availability of supplies and accessories varies by country/region.

Paper

To order media such as HP Premium Paper, HP Premium Inkjet Transparency Film, HP Iron-On Paper, or HP Greeting Cards, go to www.hp.com.

Choose a country/region, and then select Buy or Shopping.

USB cables

C6518A HP USB A–B 2-meter cable

Accessories

If an accessory is not included with the printer, it can be purchased separately from an authorized HP dealer.



Note The availability of accessories varies by country/region.

Automatic Two-Sided Printing Accessory

Q5712A Automatic Two-Sided Printing Accessory

Auto Two-Sided Print Accessory with Small Paper Tray

Q3032A Auto Two-Sided Print Accessory with Small Paper Tray

250-Sheet Plain Paper Tray Accessory

Q3447A 250-Sheet Plain Paper Tray Accessory

HP bt450 Bluetooth Wireless Printer Adapter

Q6398A HP bt450, Bluetooth Wireless Printer Adapter

HP bt400 Bluetooth Wireless Printer Adapter

Q6399A HP bt400, Bluetooth Wireless Printer Adapter

14 Specifications

- [Printer specifications](#)

Printer specifications

See the reference guide that came with the printer for complete printer specifications, including this information:

- Types, sizes, and weights of paper and other printing media that can be used with the printer
- Print speeds and resolutions
- Power requirements
- Computer operating system requirements

15 Environmental information

- [Environmental statement](#)
- [Print cartridge recovery](#)

Environmental statement

Hewlett-Packard continuously improves the design processes of its deskjet printers to minimize the negative impact on the office environment and on the communities where printers are manufactured, shipped, and used.

Reduction and elimination

Paper use: The printer's [two-sided printing](#) capability reduces paper usage and the resulting demands on natural resources. In addition, the [Print Cancel button](#) allows the user to save paper by quickly canceling a print job as needed. This equipment is suitable for using recycled papers (in accordance with EN 12281:2002).

Recycled paper: All paper documentation for this printer is printed on recycled paper.

Ozone: Ozone-depleting chemicals such as CFCs have been eliminated from Hewlett-Packard's manufacturing processes.

Recycling

Design for recycling has been incorporated into this printer. The number of materials has been kept to a minimum while ensuring proper functionality and reliability. Dissimilar materials have been designed to separate easily. Fasteners and other connections are easy to locate, access, and remove using common tools. High priority parts have been designed to access quickly for efficient disassembly and repair.

Printer packaging: The packaging materials for this printer have been selected to provide maximum protection for the least cost possible, while attempting to minimize environmental impact and facilitate recycling. The rugged design of the HP Deskjet printer assists in minimizing both packaging materials and damage rates.

Plastic parts: All major plastics and plastic parts are marked according to international standards. All plastic parts used in the printer housing and chassis are technically recyclable and all use a single polymer.

Product longevity: To ensure the longevity of the HP Deskjet printer, HP provides the following:

- **Extended warranty:** Details can be found in the reference guide that came with the printer.
- **Replacement parts and consumables** are available for a limited period after production has stopped.
- **Product take-back:** To return this product to HP at the end of its useful life, go to www.hp.com/recycle. To return empty print cartridges to HP, see [print cartridge recovery](#).



Note The extended warranty and product take-back options are not available in all countries/regions.

Recycling information for the European Union

Important recycling information for our customers in the European Union: To preserve the environment, this product must be recycled after its useful life as required by law. The symbol below indicates that this product may not be disposed in the general trash. Please return the product for proper recovery/disposal to the authorized collection location nearest to you. For more information regarding return and recycling of HP products generally, please visit www.hp.com/hpinfo/globalcitizenship/environment/recycle/index.html.



Energy consumption

This printer was designed with energy conservation in mind. Not only does this save natural resources, but it also saves money without affecting the high performance of the printer. The printer meets the Federal Energy Management Program (FEMP) requirements, the US government energy savings initiative aimed at reducing power when the printer is turned OFF.

This product qualifies for the ENERGY STAR® Program. ENERGY STAR is a voluntary program established to encourage the development of energy-efficient office products.



ENERGY STAR is a U.S. registered service mark of the U.S. Environmental Protection Agency. As an ENERGY STAR partner, Hewlett-Packard Company has determined that this product meets ENERGY STAR guidelines for energy efficiency.

Energy consumption in standby mode: See the reference guide for energy consumption specifications.

Energy consumption in off-mode: When the printer is off, an amount of energy is still being consumed. Energy consumption can be prevented by turning the printer power off, and then disconnecting the end of the printer power cord from the electrical source.

Print cartridge recovery

Customers interested in recycling their genuine HP print cartridges can participate in HP's Planet Partner's Program for inkjet cartridges. HP offers this program in more countries/regions than any other inkjet cartridge manufacturer in the world. This program is provided as a free service to HP customers as an environmentally sound solution for these products at end-of-life.

To participate, simply follow the directions provided on HP's Web site at this address: www.hp.com/recycle. This service is not available in all countries/regions. Customers may be asked for their name, phone number, and address.

Because HP's unique recycling processes are very sensitive to material contamination, we cannot take back and recycle cartridges from other manufacturers. The end products of the recycling process are used in the manufacture of new products, and HP must ensure the composition of the material is consistent. To do that, we recycle only HP original cartridges. This program does not extend to refilled cartridges.

Returned cartridges are separated for purification into raw materials for use in other industries to manufacture new products. Examples of products made from recycled HP print cartridge materials include automobile parts, trays used in microchip fabrication processes, copper wire, steel plates, and the precious materials used in electronics. Depending on the model, HP is able to recycle up to 65% of the print cartridge by weight. The remaining parts that cannot be recycled (ink, foam, and composite parts) are disposed of in an environmentally responsible manner.

