

RAZER

TURRET

LIVING ROOM
GAMING MOUSE AND LAPBOARD



The key to securing victory every time, is having an arsenal of controls more impressive than your opponents. The Razer Turret puts the power of desktop grade gaming peripherals right in your lap as you play your favorite game titles on the couch. In addition to the undeniable precision achieved by using a keyboard and a mouse, this highly ergonomic lapboard also gives you the power to execute typing commands while you're gaming or browsing, without having to switch devices constantly.

Arm yourself with the Razer Turret, and dominate leaderboards from the comfort of your couch.

CONTENTS

1. PACKAGE CONTENTS / SYSTEM REQUIREMENTS	3
2. REGISTRATION / TECHNICAL SUPPORT	4
3. TECHNICAL SPECIFICATIONS	5
4. DEVICE LAYOUT	6
5. USING YOUR RAZER TURRET	8
6. INSTALLING YOUR RAZER TURRET	19
7. CONFIGURING YOUR RAZER TURRET – GAMING LAPBOARD	20
8. CONFIGURING YOUR RAZER TURRET – MOUSE	29
9. CONFIGURING YOUR RAZER TURRET – MACROS	41
10. CONFIGURING YOUR RAZER TURRET – STATS AND HEATMAPS	46
11. SAFETY AND MAINTENANCE	56
12. LEGALESE	60

1. PACKAGE CONTENTS / SYSTEM REQUIREMENTS

PACKAGE CONTENTS

- Razer Turret gaming lapboard
- Razer Turret gaming mouse
- RF USB Dongle
- Rechargeable battery for Razer Turret gaming mouse
- Charging Dock
- Power connector cable
- Extension dock
- Power adapter
- Interchangeable plugs*
- Important Product Information Guide

**May include adapter plugs for specific regions*

SYSTEM REQUIREMENTS

For RF USB dongle connectivity:

- PC / Mac / Razer Forge TV* with a free USB port
- Windows® 10 / Windows® 8 / Windows® 7 / Mac OS X (10.8 – 10.11)

**requires third party app*

For Bluetooth® connectivity

- PC / Mac
- Windows® 10 / Windows® 8 / Mac OS X (10.10 – 10.11)
- Bluetooth® Smart Ready (Bluetooth 4.0 or higher)

2. REGISTRATION / TECHNICAL SUPPORT

REGISTRATION

Sign up now for a Razer Synapse account to get real-time information on your product's warranty status. To learn more about Razer Synapse and all its features, visit www.razerzone.com/synapse.

If you are already a Razer Synapse user, register your product by clicking on your email address at the Razer Synapse application and select *Warranty Status* from the dropdown list.

To register your product online, visit www.razerzone.com/registration. Please note that you will not be able to view your warranty status if you register via the website.

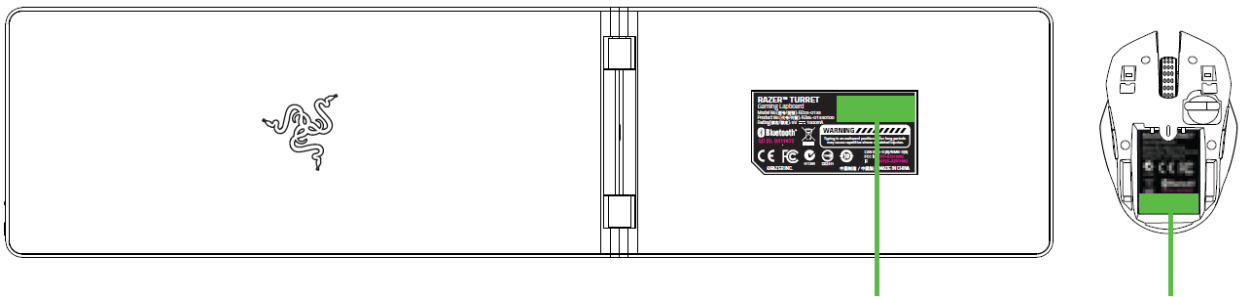

Your product's serial number can be found here

TECHNICAL SUPPORT

What you'll get:

- 1 year limited manufacturer's warranty.
- 6 months limited battery warranty.
- Free online technical support at www.razersupport.com.

3. TECHNICAL SPECIFICATIONS

RAZER TURRET LAPBOARD

- Anti-ghosting capability for up to 10 simultaneous key presses
- Chiclet styled keycaps
- Dedicated Android buttons
- Cortex quick launch button
- Battery life of up to 4 months - The life expectancy of this battery depends upon its usage
- Battery type: Li-Po (1500 mAh)

RAZER TURRET MOUSE

- 3500 DPI optical sensor
- Ambidextrous form factor
- 40 hours battery life for continuous use - The life expectancy of this battery depends upon its usage
- Battery type: Li-Po (1000 mAh)

4. DEVICE LAYOUT

RAZER TURRET GAMING LAPBOARD

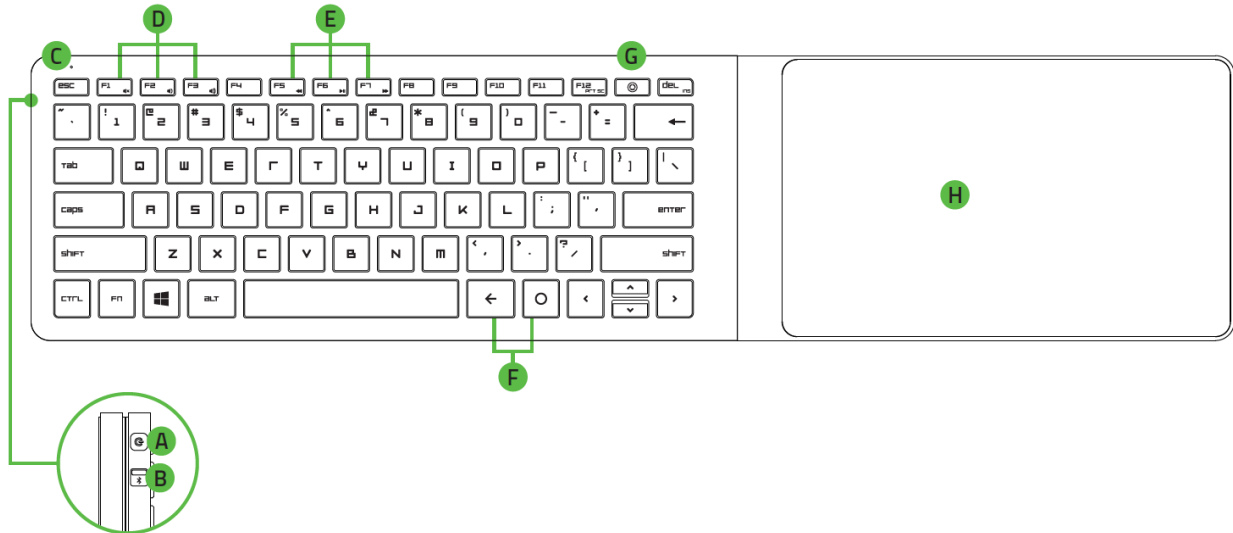

- A. Power / Pairing mode button
- B. Bluetooth Smart () / RF (2.4) slider switch
- C. LED indicator
- D. Volume control keys
- E. Media keys
- F. Android keys
- G. Mouse mat

RAZER TURRET GAMING MOUSE

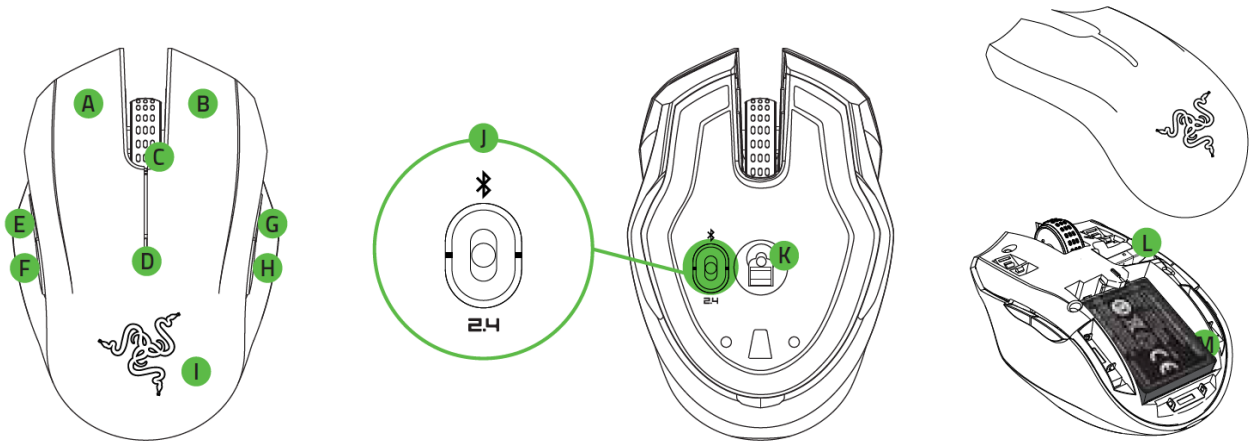

- A. Left mouse button
- B. Right mouse button
- C. Scroll wheel
- D. Battery / Pairing Indicator
- E. Mouse button 5
- F. Mouse button 4
- G. Sensitivity Stage Up
- H. Sensitivity Stage Down
- I. Detachable top mouse cover
- J. Slider Switch
 - Bluetooth Smart () mode
 - Off mode
 - 2.4GHz RF mode
- K. 3500 DPI optical sensor
- L. 2.4GHz USB dongle storage slot
- M. Rechargeable battery

5. USING YOUR RAZER TURRET

GETTING STARTED

Both the Razer Turret gaming lapboard and the Razer Turret gaming mouse are set to Bluetooth mode by default. When setting up your Razer Turret for the first time, please insert the battery into the mouse as follows:

1. Remove the top cover of the Razer Turret gaming mouse by lifting the back of the cover and pulling it backwards.

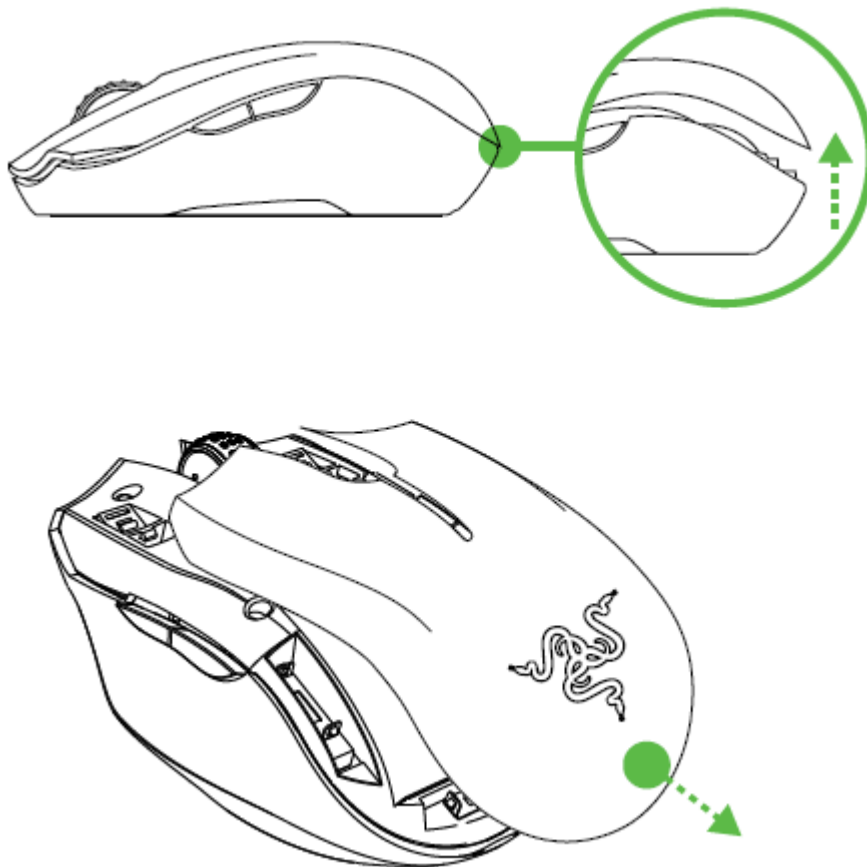

2. Insert the battery into the mouse following the directions indicated.

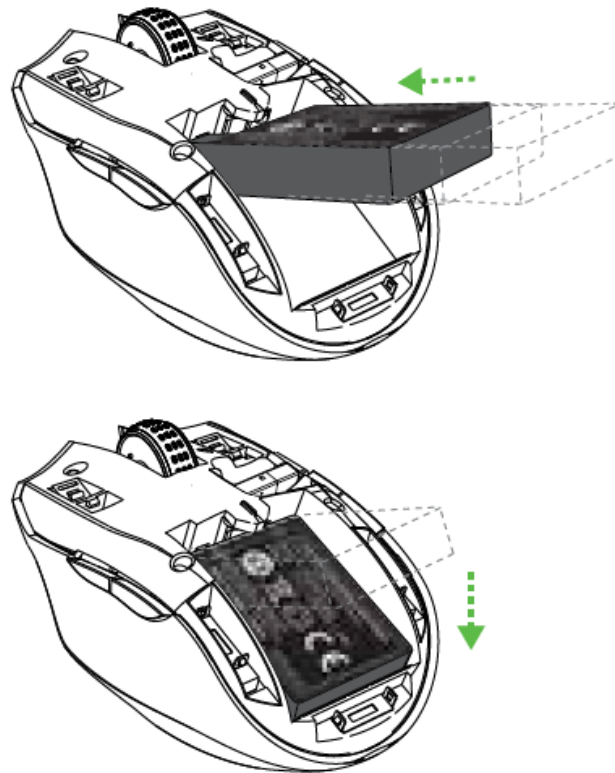

3. Reattach the top cover onto the mouse. Please ensure it is secured.

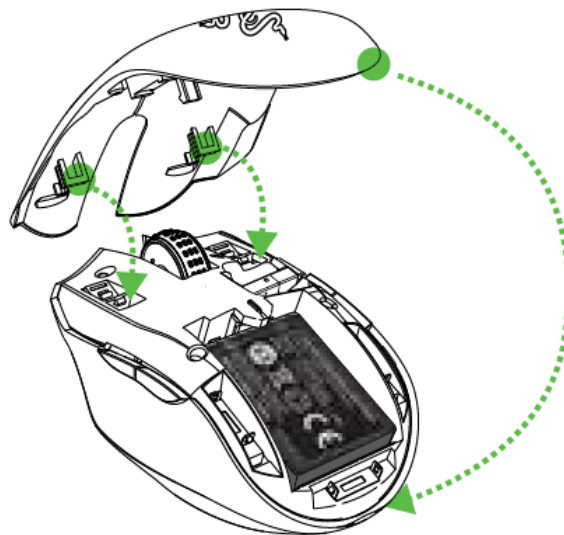

Note: We recommend removing the rechargeable battery from the mouse if you are not intending to use it for a prolonged period of time. Repeat the above steps to remove the battery.

CHARGING THE RAZER TURRET

1. Select the appropriate power plug for your region and attach it to the power adapter.

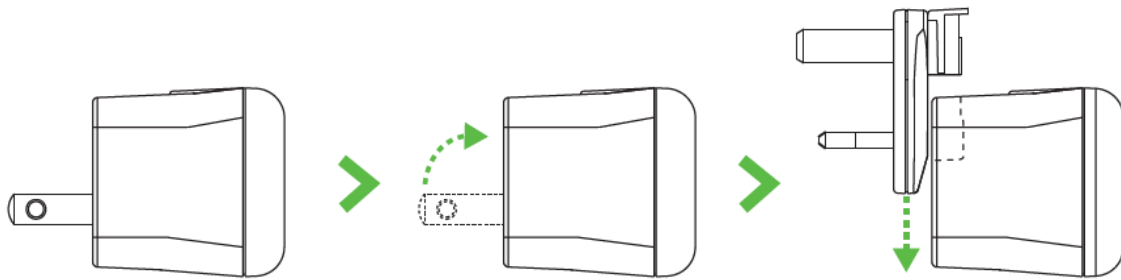
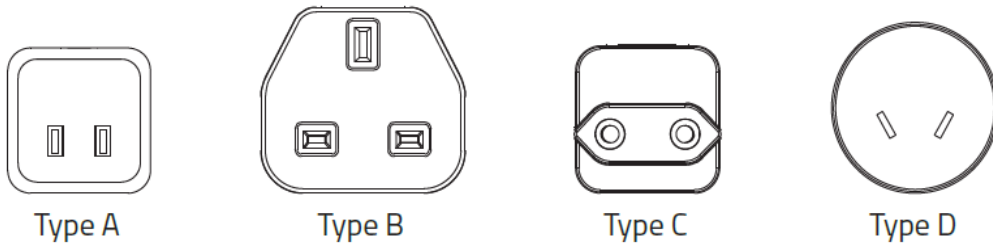

2. Connect the charging dock to the power adapter and plug it into a suitable power source.

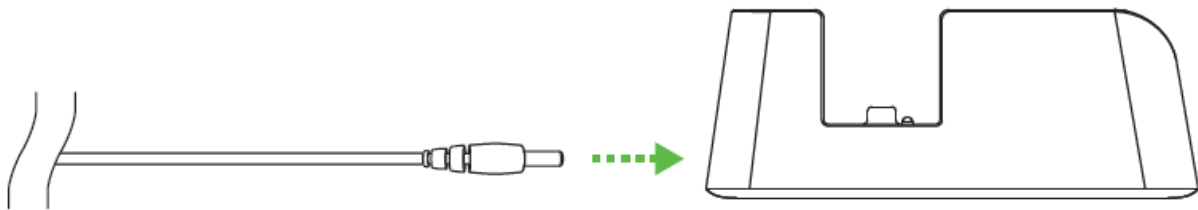

3. Fold back the mouse mat on the Razer Turret gaming lapboard.

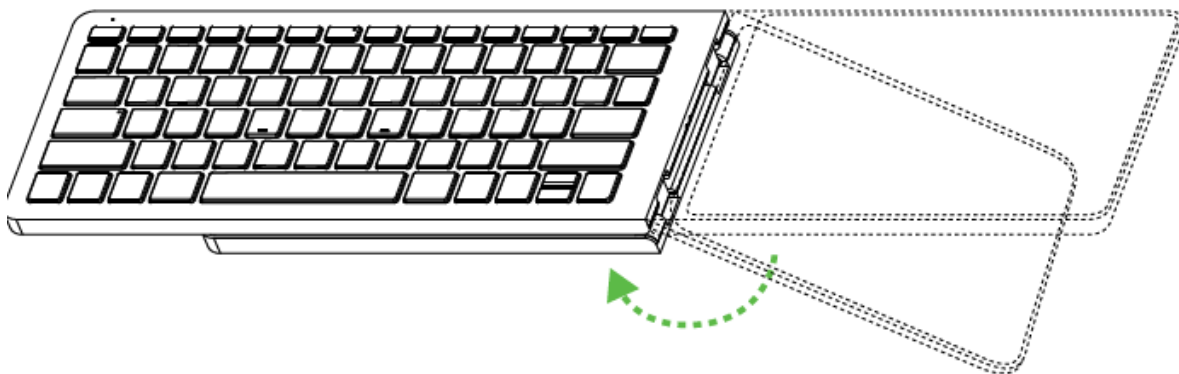

- Place the folded Razer Turret gaming lapboard and mouse into the charging dock. Ensure that the devices are securely in place. The LED flashes red to indicate that the battery is currently charging.

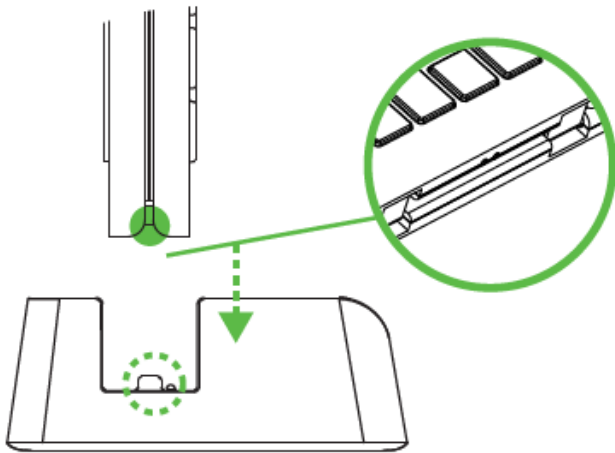



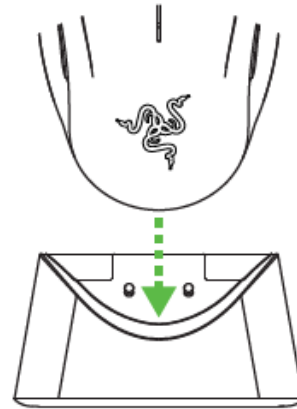











Razer Turret gaming lapboard



Razer Turret gaming mouse





- Wait for the devices to fully charge. A fully depleted battery will charge in approximately 3 hours.

Battery LED Indicator

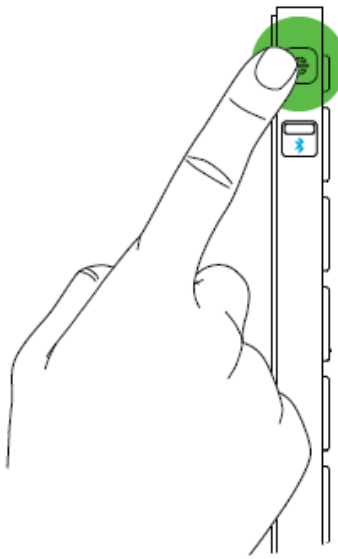
	 Razer Turret gaming lapboard		 Razer Turret gaming mouse	
	Bluetooth mode	RF mode	Bluetooth mode	RF mode
Full battery				
Low Battery				
Charging	<99%	100%	<99%	100%
				

POWERING ON / OFF THE RAZER TURRET GAMING LAPBOARD



Power On		Power off	
Bluetooth mode	RF mode	Bluetooth mode	RF mode
			

Power Saving Mode

The Razer Turret goes into power saving mode after a 15 minutes idle period. Simply press any key or move the mouse to wake the device. The Razer Turret will then automatically attempt to reconnect to the last paired device.

CONNECTING THE RAZER TURRET VIA BLUETOOTH® SMART

Note: The Razer Turret gaming lapboard and mouse are set to Bluetooth mode by default.

Razer Turret gaming mouse

1. Push the slider switch on the Razer Turret mouse to . This switches the mouse on and activates pairing mode. The LED indicator will start to blink in blue.

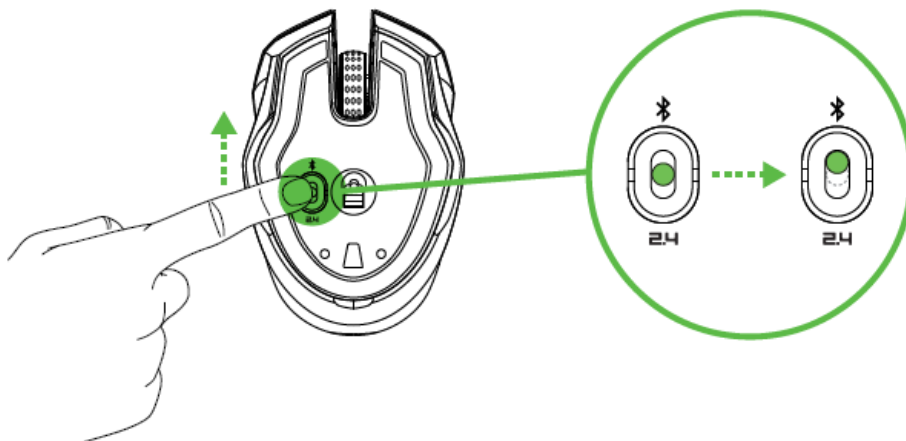

2. Activate Bluetooth® on your device and search for new Bluetooth® devices.

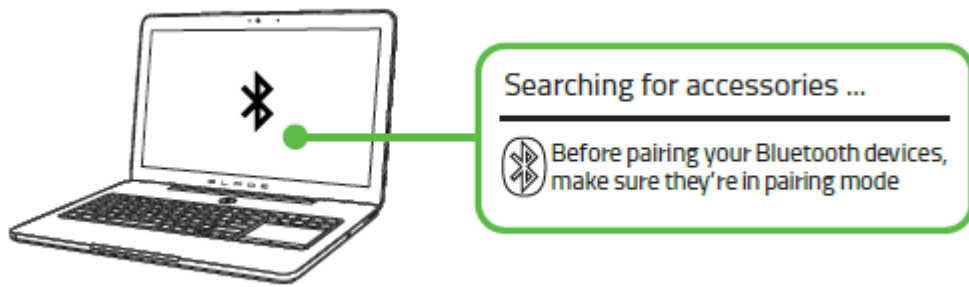

3. Select "Razer Turret gaming mouse" from the list of devices found. When pairing is complete, the LED indicator will stay lit in blue for 5s before fading off.

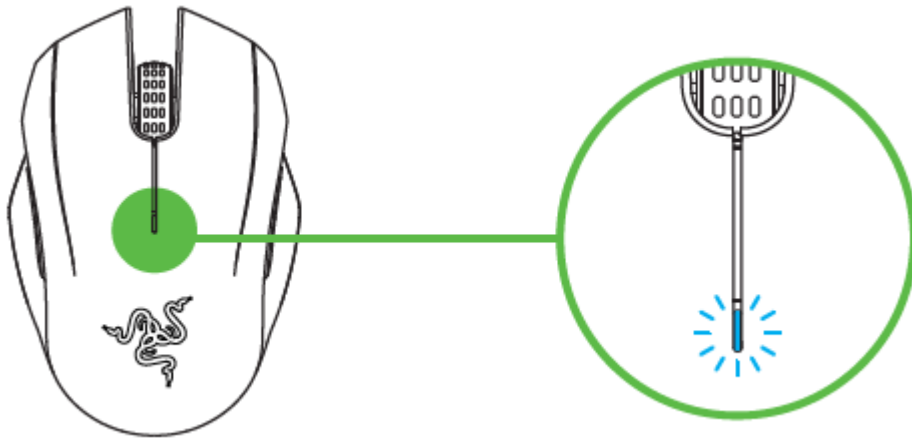

Note: To pair your Razer Turret gaming mouse to a different device, disconnect the current Bluetooth connection from host device. Then, press and hold the 4 side buttons for 3s to manually activate pairing mode.

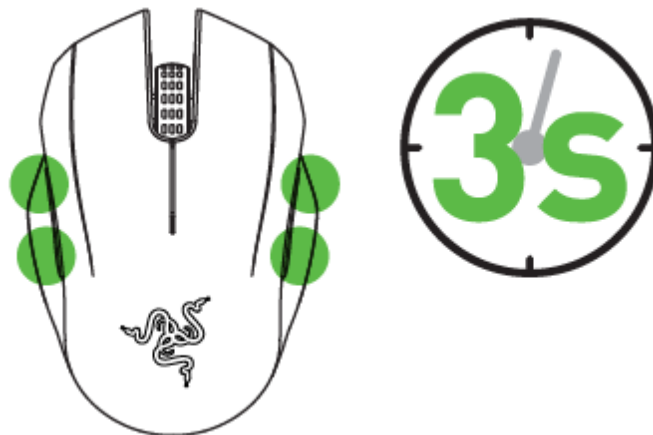

Razer Turret gaming lapboard

1. Push the Slider switch on the Razer Turret gaming lapboard to .

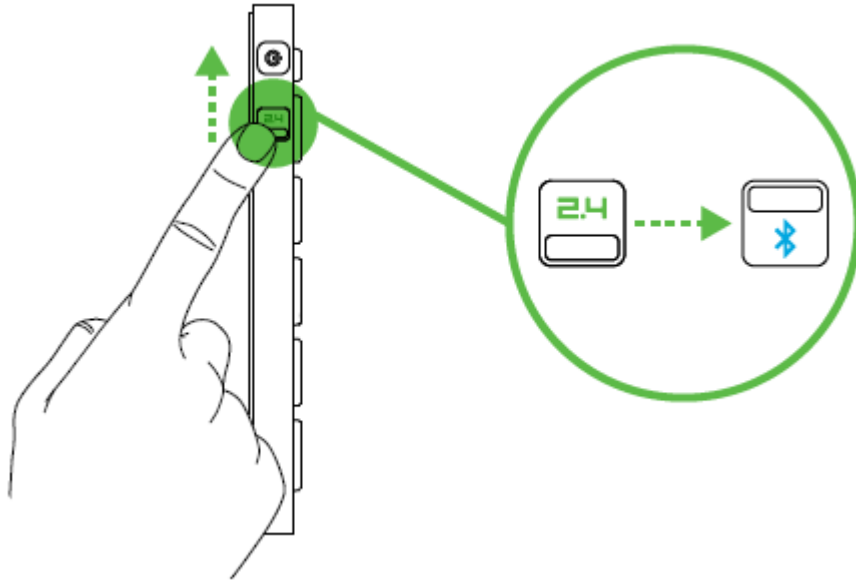

2. Press the Power button to turn the Razer Turret gaming lapboard on and activate pairing mode. The LED indicator will start to blink in blue.

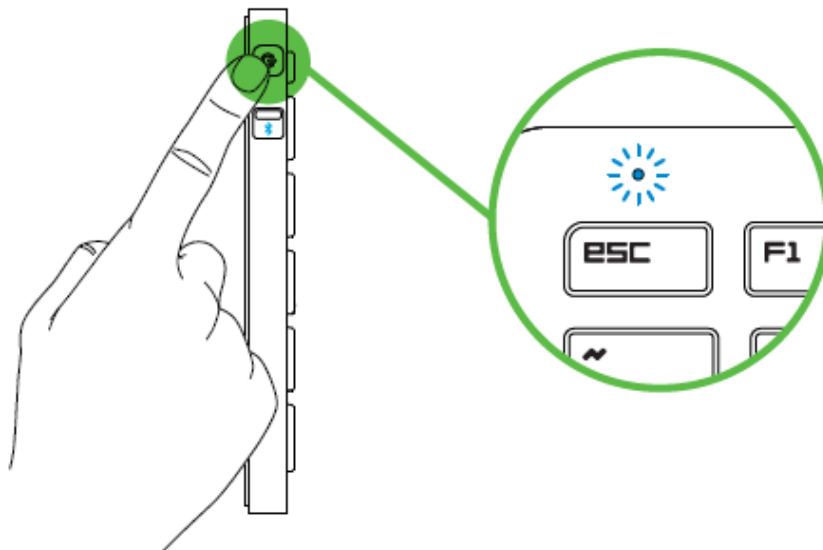

3. Activate Bluetooth® on your device and search for new Bluetooth® devices.

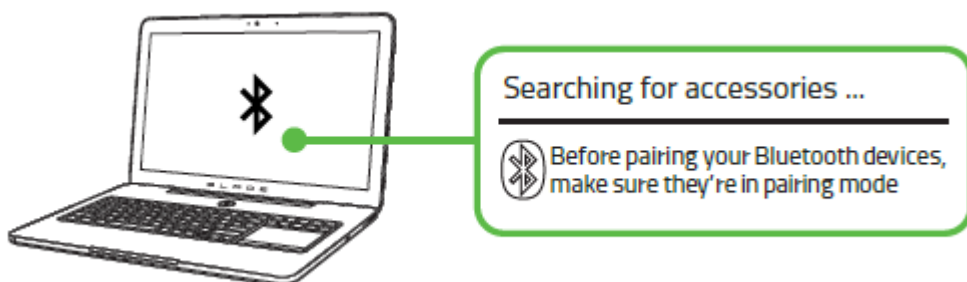

4. Select “Razer Turret gaming lapboard” from the list of devices found. When pairing is complete, the LED indicator will stay lit in blue for 5s before fading off.

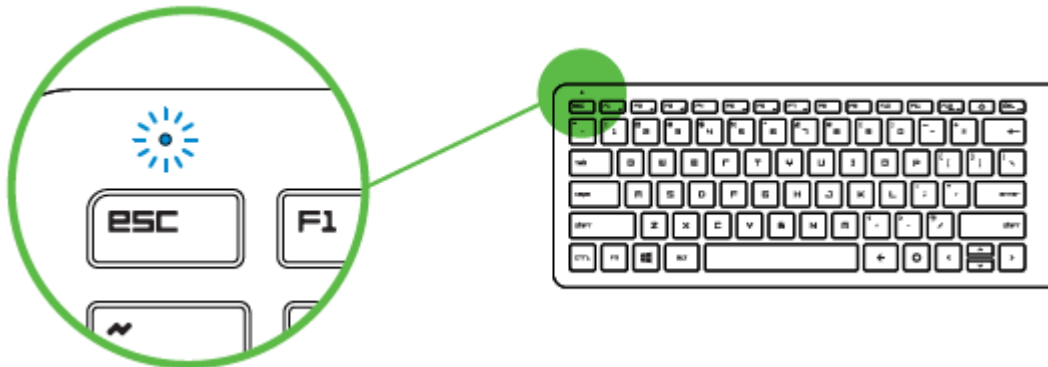

Note: To pair your Razer Turret gaming lapboard to a different device, disconnect the current Bluetooth connection from host device. Then, press and hold the power button for 3s to manually activate pairing mode.

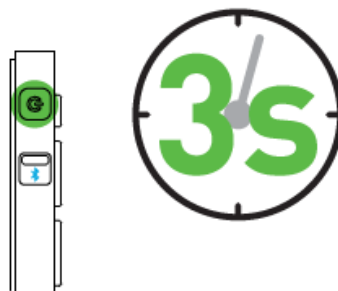

CONNECTING THE RAZER TURRET VIA THE WIRELESS DONGLE

1. Push the Slider switch on both the Razer Turret gaming lapboard and mouse to (2.4GHz wireless).

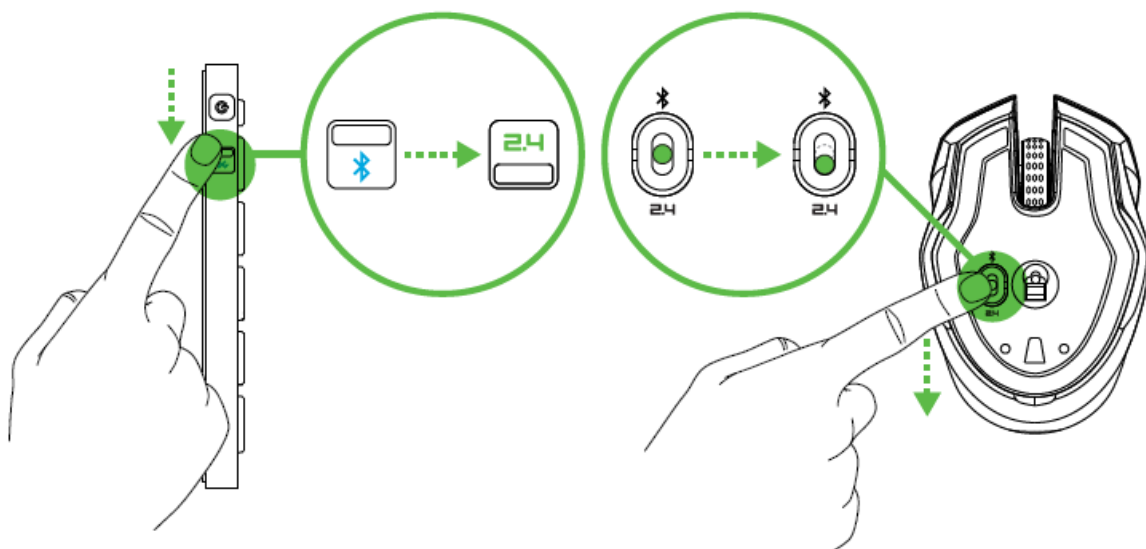

2. Remove the top cover of the Razer Turret gaming mouse by lifting the back of the top cover and pulling it backwards. Retrieve the USB dongle. Reattach the top cover.

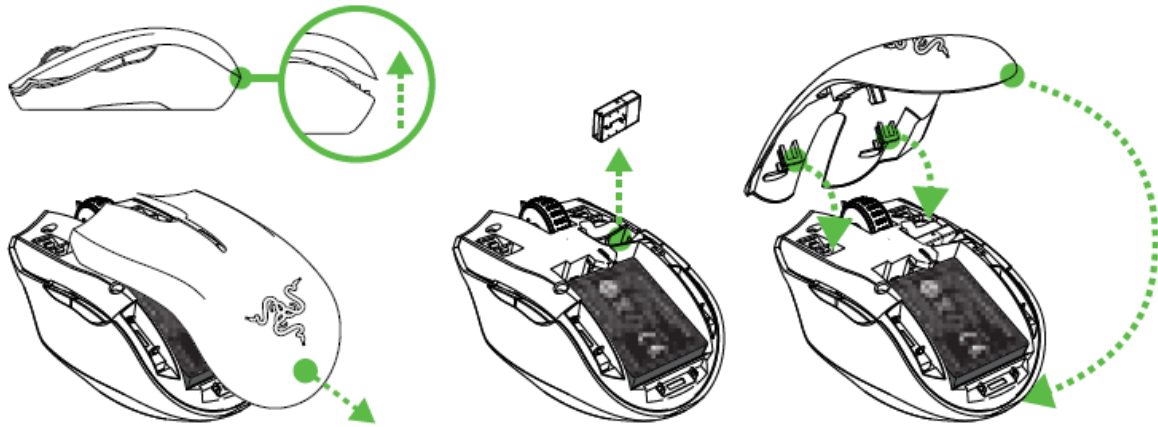

3. Plug the USB dongle to the device you wish to pair to.

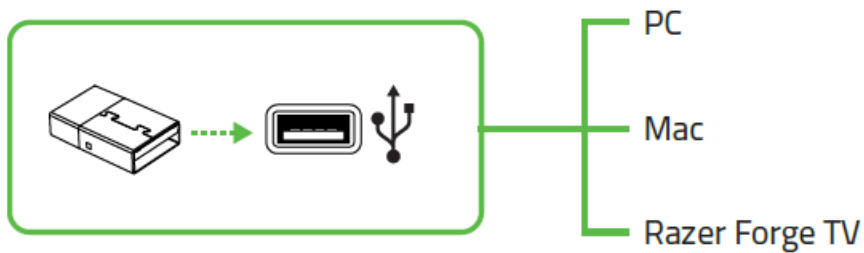

4. Press the Power button to turn the Razer Turret gaming lapboard on.

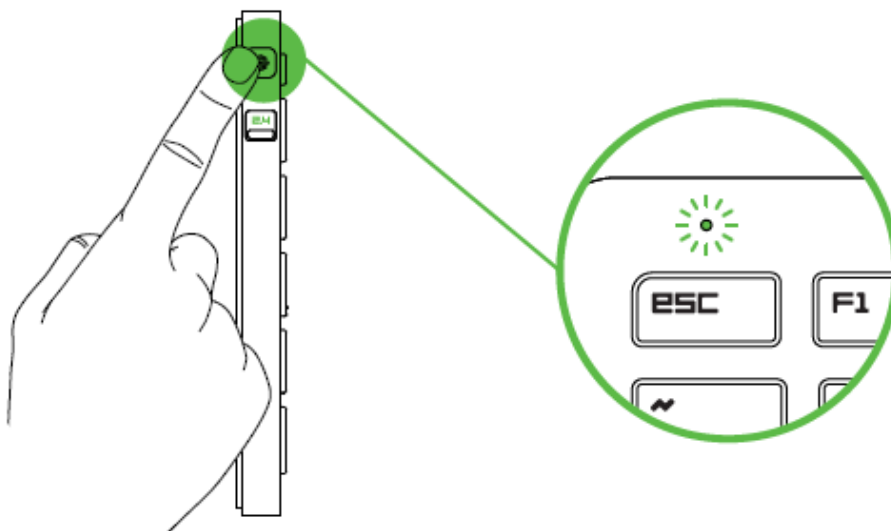

When successfully connected, the LED indicator will stay lit in green for 5s before fading off.

USING THE USB EXTENSION DOCK

Plug the USB extension dock to your gaming system to increase the reach of its USB port. Ensure that the RF USB dongle is within line-of-sight of the Razer Turret for optimum performance.

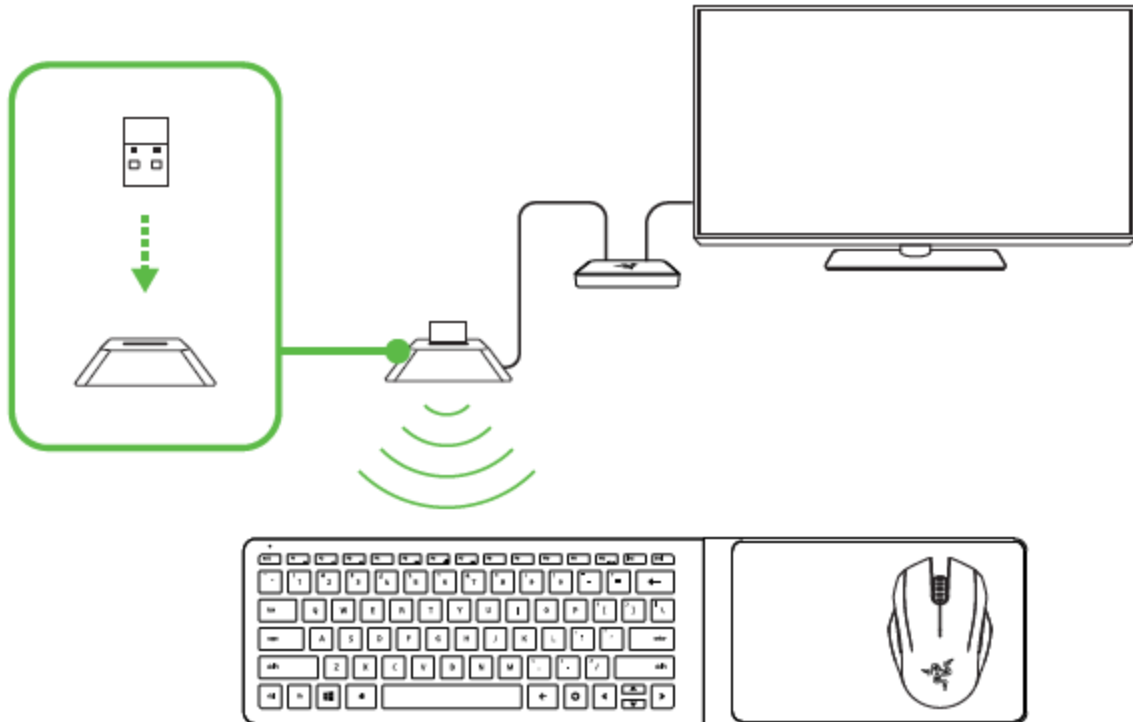

USING THE RAZER TURRET GAMING LAPBOARD

Pressing the “FN” key in combination with the function keys will activate their secondary features.

Volume keys

The audio volume controls allow you to mute, decrease and increase the audio output.

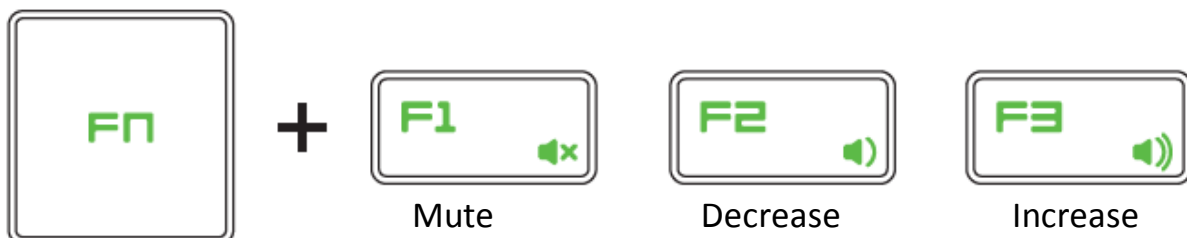

Media keys

The media keys allow you to play/pause a track or skip tracks backward and forward.

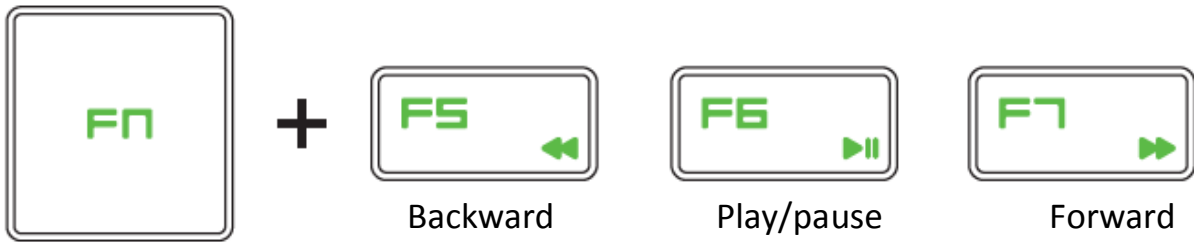

Android shortcut keys

Back and Home shortcut keys for Android devices

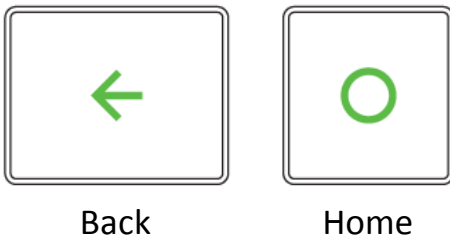

6. INSTALLING YOUR RAZER TURRET

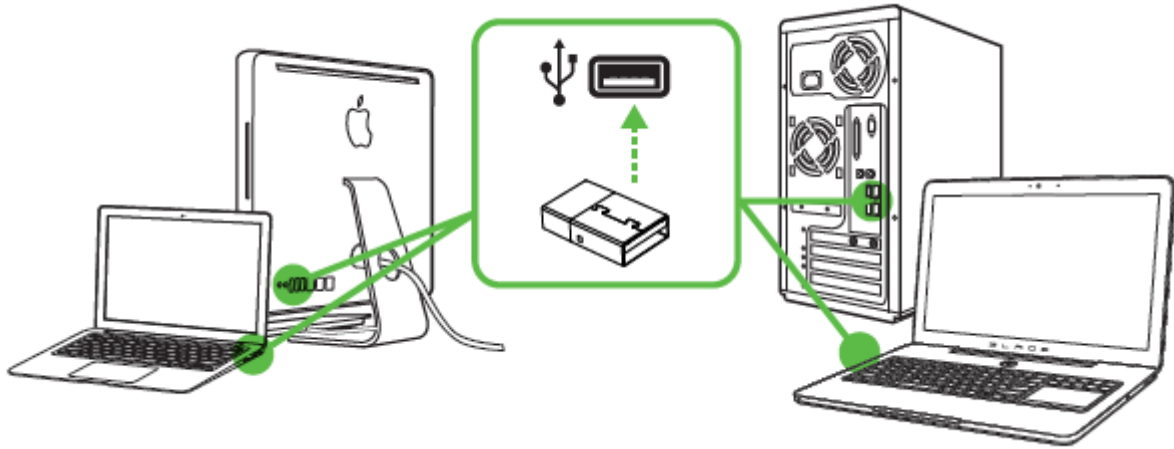

- Step 1: Connect your Razer device to the USB port of your computer.
- Step 2: Install Razer Synapse when prompted* or download the installer from www.razerzone.com/synapse.
- Step 3: Create your Razer ID or login to Synapse with your existing Razer ID.

**Applicable for Windows 8 or later.*

Note: Razer Synapse is only available when the Razer Turret is connected to a PC.

7. CONFIGURING YOUR RAZER TURRET – GAMING LAPBOARD

Disclaimer: The features listed here require you to log in to Razer Synapse. These features are also subject to change based on the current software version and your Operating System.

The Razer Turret displays as 2 separate devices on the Razer Synapse device selector on the bottom left, allowing you to configure the Razer Turret gaming lapboard and the Razer Turret gaming mouse separately.

KEYBOARD TAB

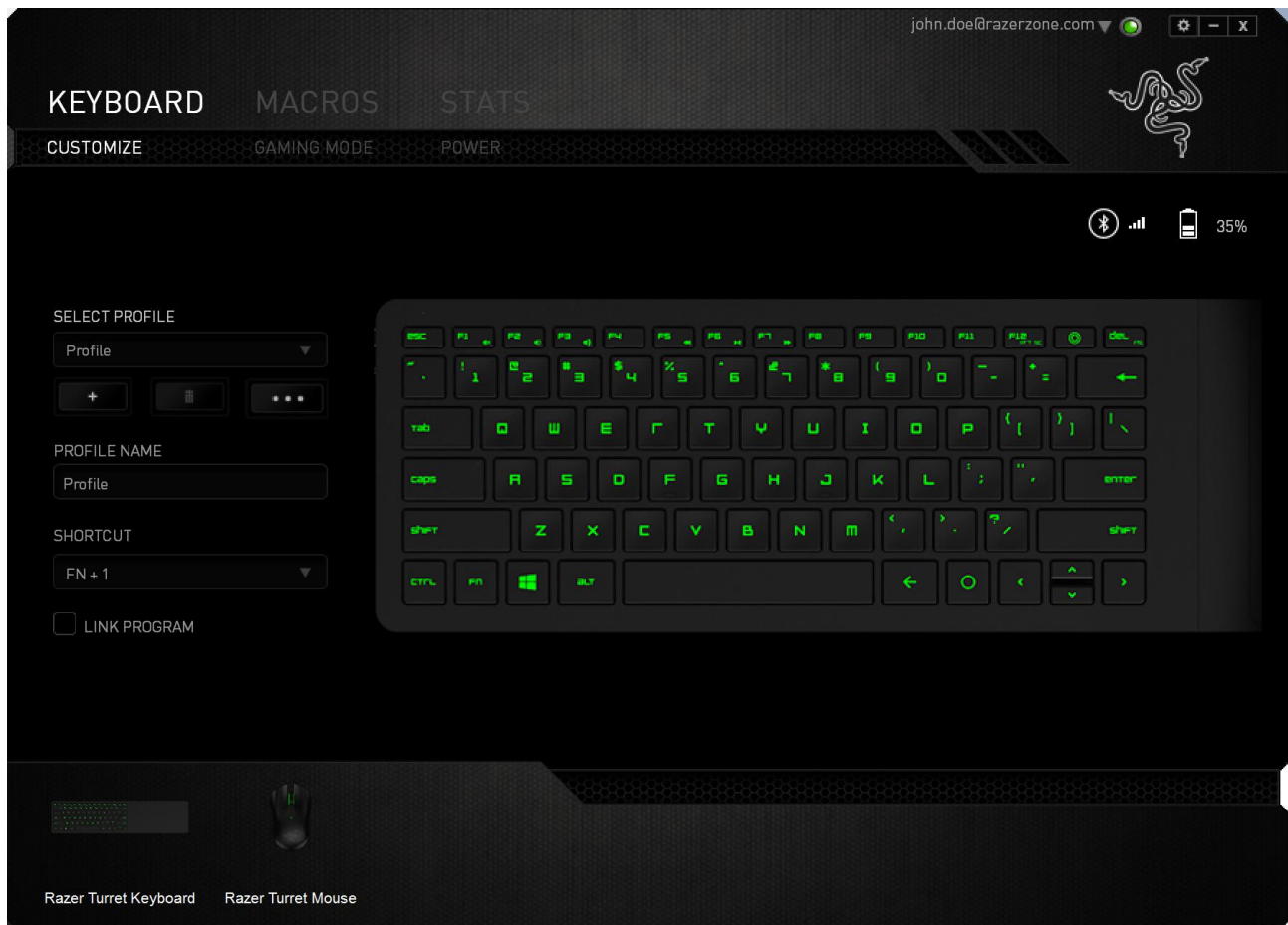

The Keyboard Tab is your default tab when you select the Razer Turret gaming lapboard from the bottom left device selector. This tab allows you to customize your device's profiles and key assignments.

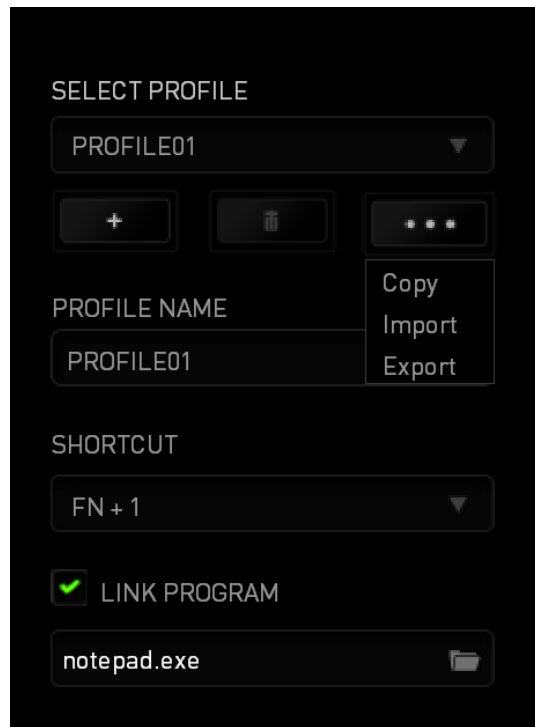

Profile

A profile is a convenient way of organizing all your custom settings and you can have an infinite number of profiles at your disposal. Any changes made within each tab are automatically saved to the current profile and stored into the cloud servers.



You can create a new profile by clicking the  button or delete the current profile by clicking the  button. The  button allows you to Copy, Import, and Export profiles. Your current profile by default is named “Profile” however; you can rename it by typing on the text field below *PROFILE NAME*.

Each profile can be set to *FN + 0 - 9* using the *SHORTCUT* dropdown menu for fast profile switching. Each profile can also be set to automatically activate when you run a program or application through the use of the *LINK PROGRAM* option.

Customize Tab

The Customize Tab is where you can modify the basic functionalities of your device such as key assignments to suit your gaming needs. The changes made in this tab are automatically saved to your current profile.

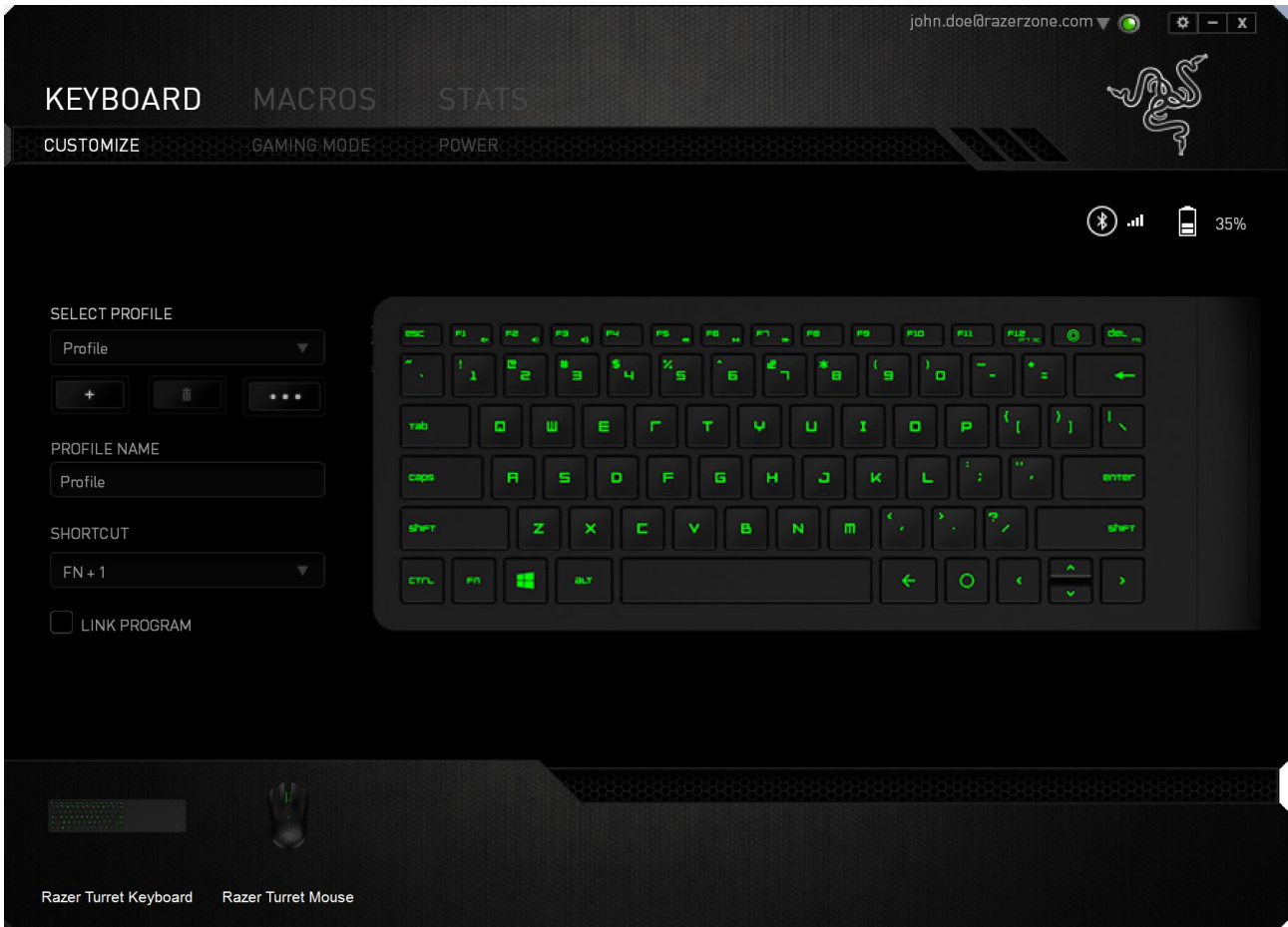

Key Assignment Menu

Initially, each key is set to *DEFAULT*. However, you may change the function of this key by clicking the desired key to access the Key Assignment Menu.

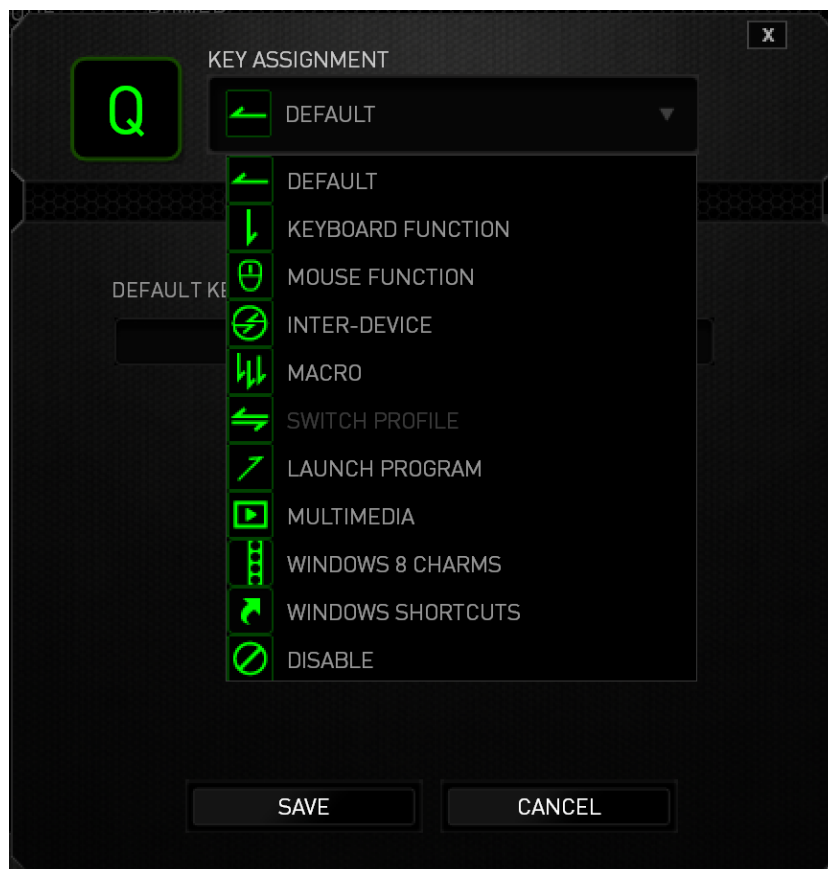

Listed below are the customization options and their description.



Default

This option enables you to return the key to its original function. To choose the *DEFAULT*, simply select it from the Key Assignment Menu.



Keyboard Function

This option enables you to change any key into another keyboard function. To choose a keyboard function, select *KEYBOARD FUNCTION* from the Key Assignment Menu and enter the key you wish to use on the given field below. You may also include modifier keys such as *Ctrl*, *Shift*, *Alt* or any of those combinations.



Mouse Function

This option allows you to change any key into a mouse button function. To choose a mouse function, select *MOUSE FUNCTION* from the Key Assignment Menu and an *ASSIGN BUTTON* submenu will appear.

Listed below are the functions which you can choose from the Assign Button submenu:

- Left Click - Performs a left mouse click using the assigned button.
- Right Click - Performs a right mouse click using the assigned button.
- Scroll Click - Activates the universal scrolling function.
- Double Click - Performs a double left click using the assigned button.
- Mouse Button 4 - Performs a “Backward” command for most internet browsers.
- Mouse Button 5 - Performs a “Forward” command for most internet browsers.
- Scroll Up - Performs a “Scroll Up” command using the assigned button.
- Scroll Down - Performs a “Scroll Down” command using the assigned button.
- Scroll Left - Performs a “Scroll Left” command using the assigned button.
- Scroll Right - Performs a “Scroll Right” command using the assigned button.



Inter-device

Inter-device allows you to change the functionality of other Razer Synapse-enabled devices. Some of these functionalities are device-specific such as using your Razer gaming keyboard to change the Sensitivity Stage of your Razer gaming mouse. When you select Inter-device from the Key Assignment Menu, a sub-menu will appear.

DEVICE TO LINK allows you to choose which currently connected Razer device can be linked while *FUNCTION* allows you to choose which functionality you want to use for the linked device.



Macro

A Macro is a prerecorded sequence of keystrokes and button presses that is executed with precise timing. By setting a key to Macro, you can conveniently execute a chain of commands. When you select this option from the Key Assignment Menu, a submenu will appear which allows you to choose a prerecorded macro command. See the **MACROS TAB** to learn more about creating Macro commands.



Switch Profile

The Switch Profile enables you to change profiles on the fly and immediately load all your pre-configured settings. When you select Switch Profile from the Key Assignment Menu, a sub-menu will appear that will allow you to choose which profile to use. An on-screen display will automatically appear whenever you switch profiles.



Launch Program

Launch Program allows you to launch a program or a website using the assigned key. When you select Launch Program from the Key Assignment Menu, two options will appear which allow you to search for the specific program you want to open or write the address of the website you want to visit.



Multimedia Function

This option allows you to bind multimedia playback controls to your device. After selecting Multimedia Function, a submenu will appear. Listed below are the multimedia playback controls you can choose from the submenu:

- Volume Down - Decreases the audio output.
- Volume Up - Increases the audio output.
- Mute Volume - Mutes the audio.
- Mic Volume Up - Increases the microphone volume.
- Mic Volume Down - Decreases the microphone volume.
- Mute Mic - Mutes the microphone.
- Mute All - Mute both microphone and audio output.
- Play / Pause - Play, pause, or resume playback of the current media.
- Previous Track - Play the previous track.
- Next Track - Play the next track.



Windows 8 Charms

This option enables you to assign the key into an Operating System shortcut command. For more information please visit: <http://windows.microsoft.com/en-us/windows-8/getting-around-tutorial>



Windows Shortcuts

This option enables you to assign the key into an Operating System shortcut command. For more information please visit:

<http://support.microsoft.com/kb/126449>



Disable

This option renders the assigned key unusable. Use Disable if you do not want to use the key or if it interferes with your gaming.

Gaming Mode Tab

The Gaming Mode Tab allows you to customize which keys to disable when Gaming Mode is activated. Depending on your settings, you may choose to disable the Windows key, Alt + Tab and Alt + F4. An indicator will light up when the function is currently turned ON.

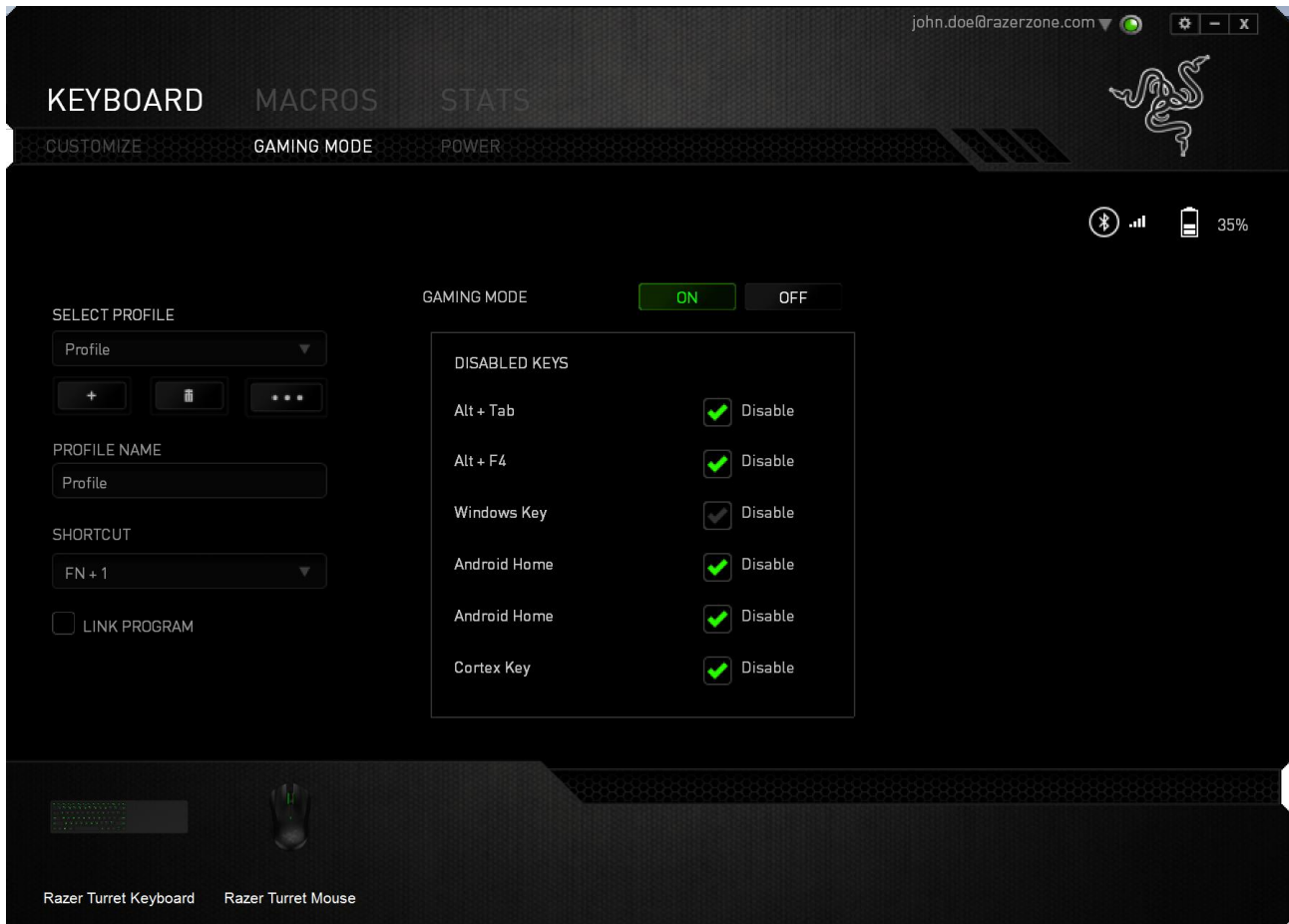

Power Tab

The Power Tab allows you to manage your device's energy consumption when running on batteries. You can set your device to enter sleep mode when it has been idle for a certain amount of time. The Power Tab also allows you to be notified when the device's power is at a certain level.

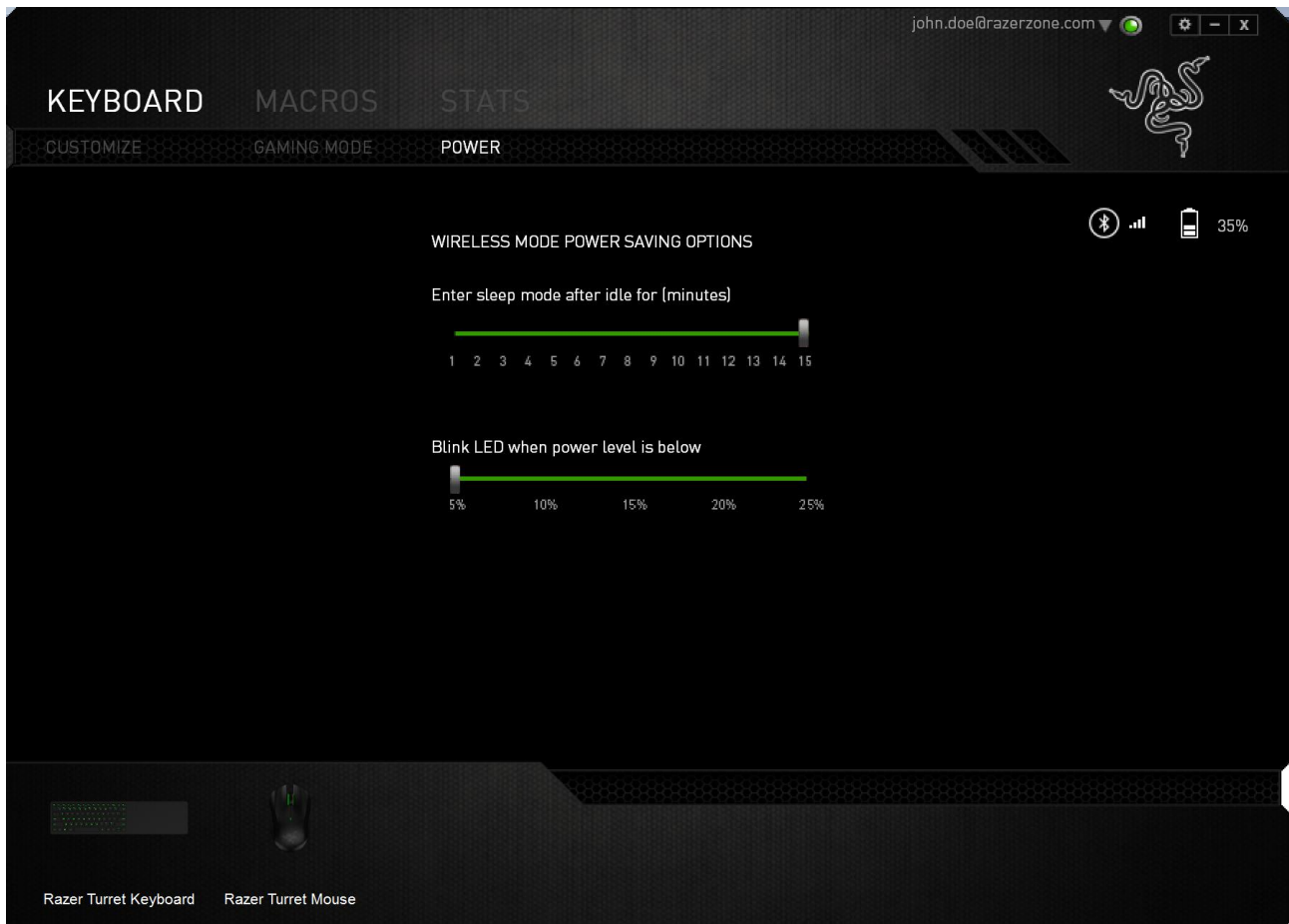

8. CONFIGURING YOUR RAZER TURRET – MOUSE

Disclaimer: The features listed here require you to log in to Razer Synapse. These features are also subject to change based on the current software version and your Operating System.

The Razer Turret displays as 2 separate devices on the Razer Synapse device selector on the bottom left, allowing you to configure the Razer Turret Lapboard and the Razer Turret Mouse separately.

MOUSE TAB

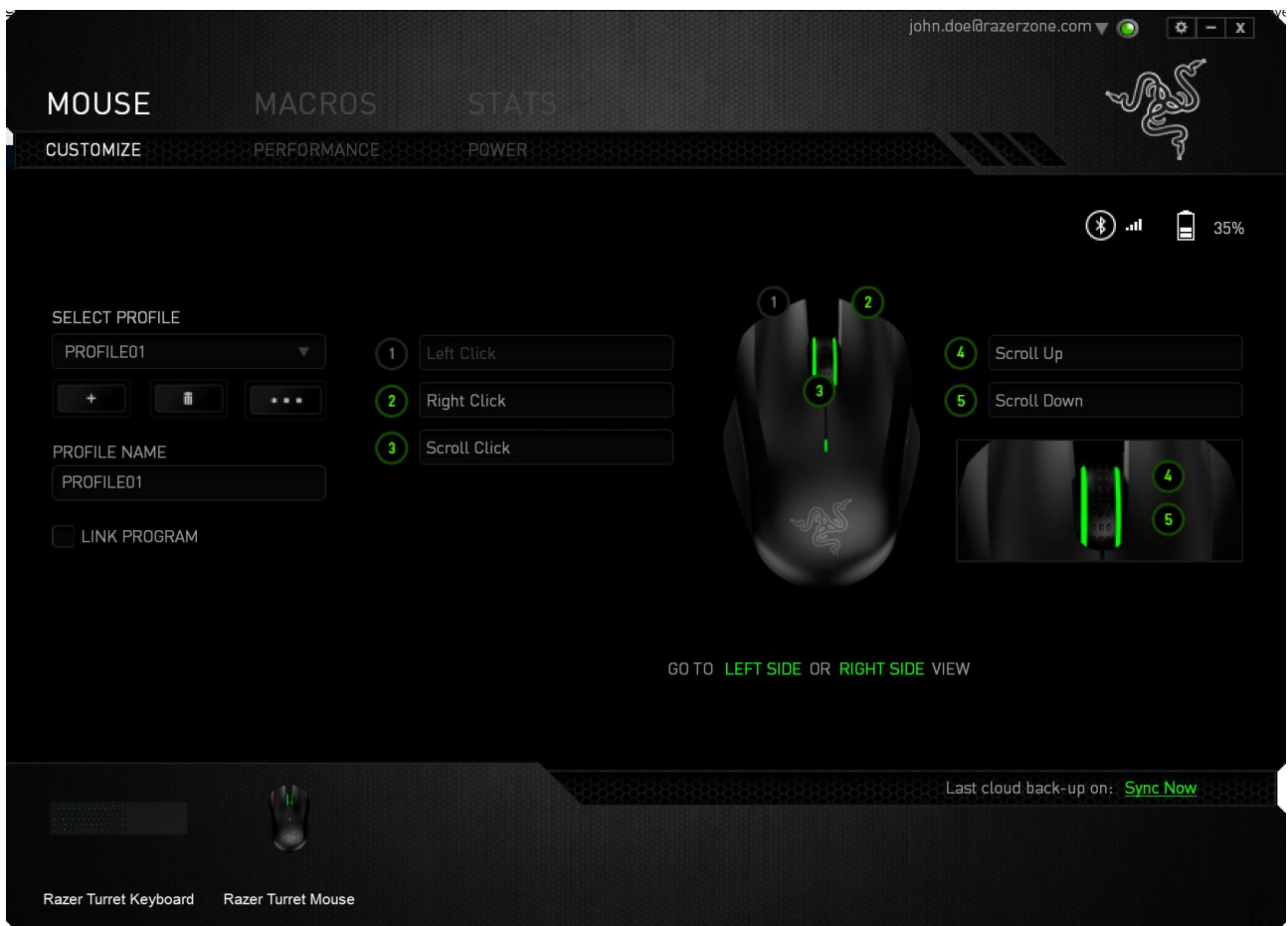

The Mouse Tab is your default tab when you select the Razer Turret gaming mouse from the bottom left device selector. This tab allows you to customize your device's profiles, button assignments, performance, and lighting.

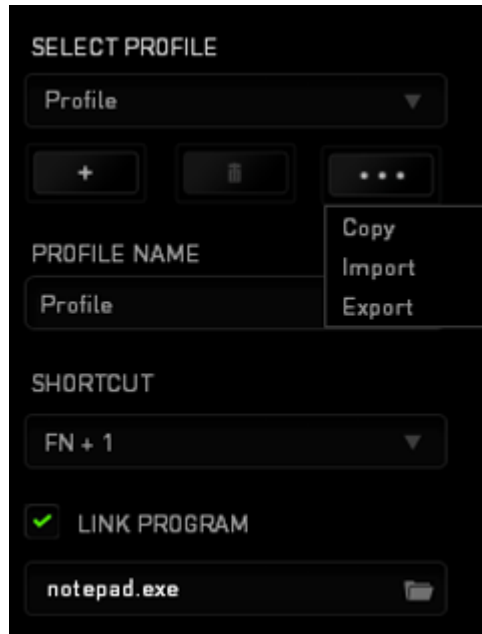

Profile

A profile is a convenient way of organizing all your custom settings and you can have an infinite number of profiles at your disposal. Any changes made within each tab are automatically saved to the current profile and stored into the cloud servers.



You can create a new profile by clicking the  button or delete the current profile by clicking the  button. The  button allows you to copy, import, and export profiles. Your current profile by default is named “Profile” however; you can rename it by typing on the text field below *PROFILE NAME*. Each profile can also be set to automatically activate when you run a program or application through the use of the *LINK PROGRAM* option.

Customize Tab

The Customize Tab is where you can modify the basic functionalities of your device such as button assignments to suit your gaming needs. The changes made in this tab are automatically saved to your current profile.

Top View

The Top View is where you can customize the mouse buttons and the scroll wheel.

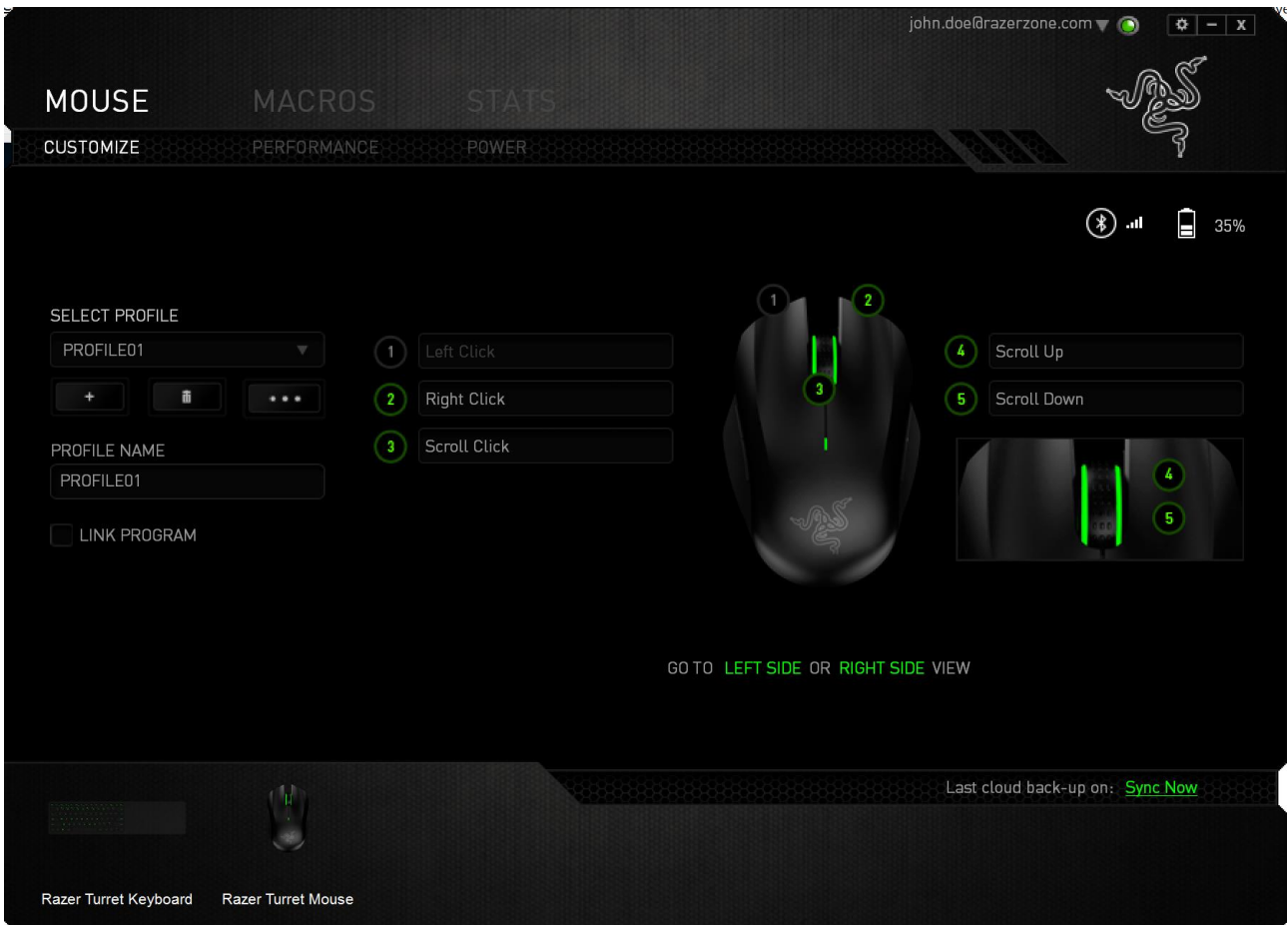

Left Side / Right Side View

The two views allow you to customize the side buttons of your mouse.

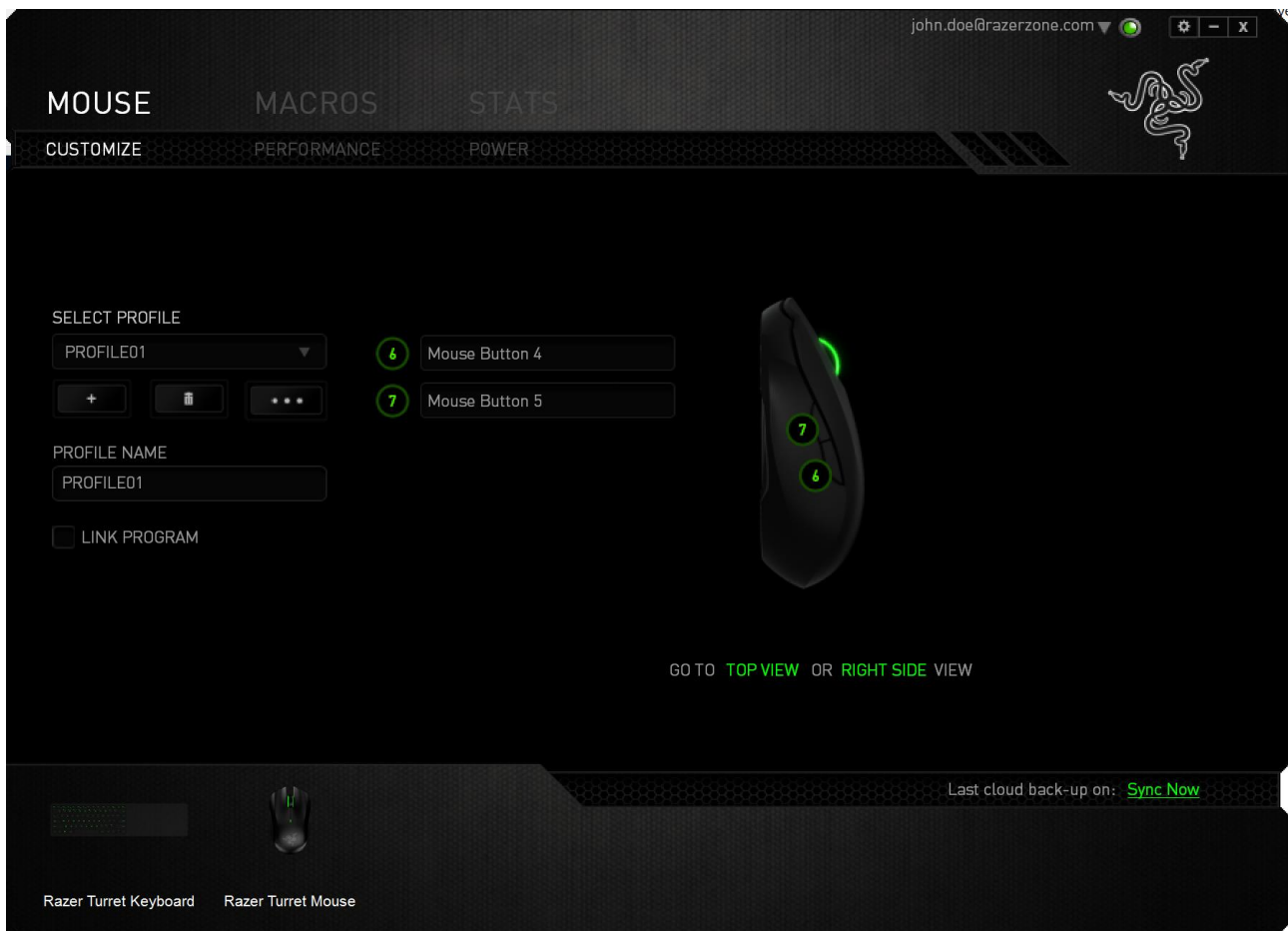

Button Assignment Menu

Initially, each of the mouse buttons is set to *DEFAULT*. However, you may change the function of these buttons by clicking the desired button to access the Button Assignment Menu.

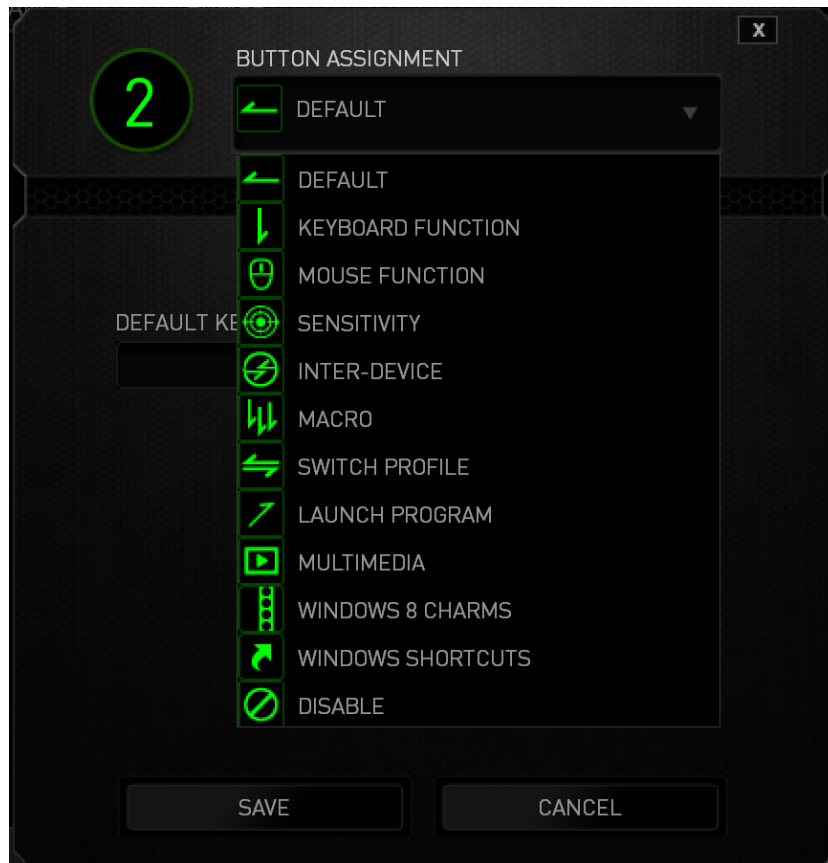

Listed below are the customization options and their description.



Default

This option enables you to return the key to its original function. To choose the *DEFAULT*, simply select it from the Button Assignment Menu.



Keyboard Function

This option enables you to change the mouse buttons into keyboard functions. To choose a keyboard function, select *KEYBOARD FUNCTION* from the Button Assignment Menu and enter the key you wish to use on the given field below. You may also include modifier keys such as *Ctrl*, *Shift*, *Alt* or any of those combinations.



Mouse Function

This option allows you to change the mouse buttons into other mouse functions. To choose a mouse function, select *MOUSE FUNCTION* from the Button Assignment Menu and an *ASSIGN BUTTON* submenu will appear.

Listed below are the functions which you can choose from the Assign Button submenu:

- Left Click - Performs a left mouse click using the assigned button.
- Right Click - Performs a right mouse click using the assigned button.
- Scroll Click - Activates the universal scrolling function.
- Double Click - Performs a double left click using the assigned button.
- Mouse Button 4 - Performs a “Backward” command for most internet browsers.
- Mouse Button 5 - Performs a “Forward” command for most internet browsers.
- Scroll Up - Performs a “Scroll Up” command using the assigned button.
- Scroll Down - Performs a “Scroll Down” command using the assigned button.
- Scroll Left - Performs a “Scroll Left” command using the assigned button.
- Scroll Right - Performs a “Scroll Right” command using the assigned button.



Sensitivity

Sensitivity refers to how fast the mouse pointer can travel across the screen. When you select the Sensitivity function from the dropdown menu, a sub-menu will appear which gives you access to the following options:

- Sensitivity Clutch - Change to a predefined sensitivity as long as the designated button is pressed. Releasing the button will return it to the previous sensitivity.
- Sensitivity Stage Up - Increase the current sensitivity by one stage. See the **PERFORMANCE TAB** to learn more about sensitivity stages.
- Sensitivity Stage Down - Decrease the current sensitivity by one stage. See the **PERFORMANCE TAB** to learn more about sensitivity stages.
- On-The-Fly Sensitivity - Readily adjust the current sensitivity using the assigned button. If On-The-Fly Sensitivity has been set, pressing the designated button and moving the scroll wheel will produce a bar on your screen which would indicate your current sensitivity level.

Cycle Up Sensitivity Stages

- Increase the current sensitivity stage by one and once it reaches the highest sensitivity stage, it will return to stage 1 when the button is pressed again. See the **PERFORMANCE TAB** to learn more about sensitivity stages.

Cycle Down Sensitivity Stages

- Decrease the current sensitivity stage by one and once it reaches stage 1, it will return to the highest sensitivity stage when the button is pressed again. See the **PERFORMANCE TAB** to learn more about sensitivity stages.



Inter-device

Inter-device allows you to change the functionality of other Razer Synapse-enabled devices. Some of these functionalities are device-specific such as using your Razer gaming keyboard to change the Sensitivity Stage of your Razer gaming mouse. When you select Inter-device from the Button Assignment Menu, a sub-menu will appear.

DEVICE TO LINK allows you to choose which currently connected Razer device can be linked while **FUNCTION** allows you to choose which functionality you want to use for the linked device.



Switch Keymap

The Switch Keymap allows you to easily swap key assignments with a press of a key. When you select Switch Keymap from the Key Assignment Menu, a submenu will appear wherein you can choose which keymap to use. The LED on the thumb module will automatically change color to correspond with the keymap.



Macro

A Macro is a pre-recorded sequence of keystrokes and button presses that is executed with precise timing. By assigning a Macro to a button, you can execute complex combinations with ease. The *ASSIGN MACRO* allows you to choose which recorded Macro to use while the *PLAYBACK OPTION* enables you to choose the behavior of the Macro. See the **MACROS TAB** to learn more about creating Macro commands.



Switch Profile

The Switch Profile enables you to change profiles on the fly and immediately load all your pre-configured settings. When you select Switch Profile from the Button Assignment Menu, a sub-menu will appear that will allow you to choose which profile to use. An on-screen display will automatically appear whenever you switch profiles.



Launch Program

The Launch Program allows you to run a program or application using the assigned button. When you select Launch Program from the dropdown menu, a  button will appear which allows you to search for the specific program or application you want to use.



In-game Configurator

The In-Game Configurator enables you to assign the button to launch the configurator while gaming. See **USING THE IN-GAME CONFIGURATOR** to learn more.



Multimedia Function

This option allows you to bind multimedia playback controls to your device. After selecting Multimedia Function, a submenu will appear. Listed below are the multimedia playback controls you can choose from the submenu:

Volume Down	- Decreases the audio output.
Volume Up	- Increases the audio output.
Mute Volume	- Mutes the audio.
Mic Volume Up	- Increases the microphone volume.
Mic Volume Down	- Decreases the microphone volume.
Mute Mic	- Mutes the microphone.
Mute All	- Mute both microphone and audio output.
Play / Pause	- Play, pause, or resume playback of the current media.
Previous Track	- Play the previous track.
Next Track	- Play the next track.



Windows 8 Charms

This option enables you to assign the button into an Operating System shortcut command. For more information please visit: <http://windows.microsoft.com/en-sg/windows-8/getting-around-tutorial>.



Windows Shortcut

This option enables you to assign the button into an Operating System shortcut command. For more information please visit: <http://support.microsoft.com/kb/126449>.



Shortcuts

This option enables you to assign the button into an Operating System shortcut command. For more information please visit: <http://support.apple.com/kb/ht1343>.



Disable

This option renders the assigned button unusable. Use Disable when you have no need for a button or if a particular button interferes with your gaming.

Performance Tab

The Performance Tab allows you to enhance the speed and precision of your mouse pointer. Similar to the Customize Tab, the changes made here are automatically saved to your current profile.

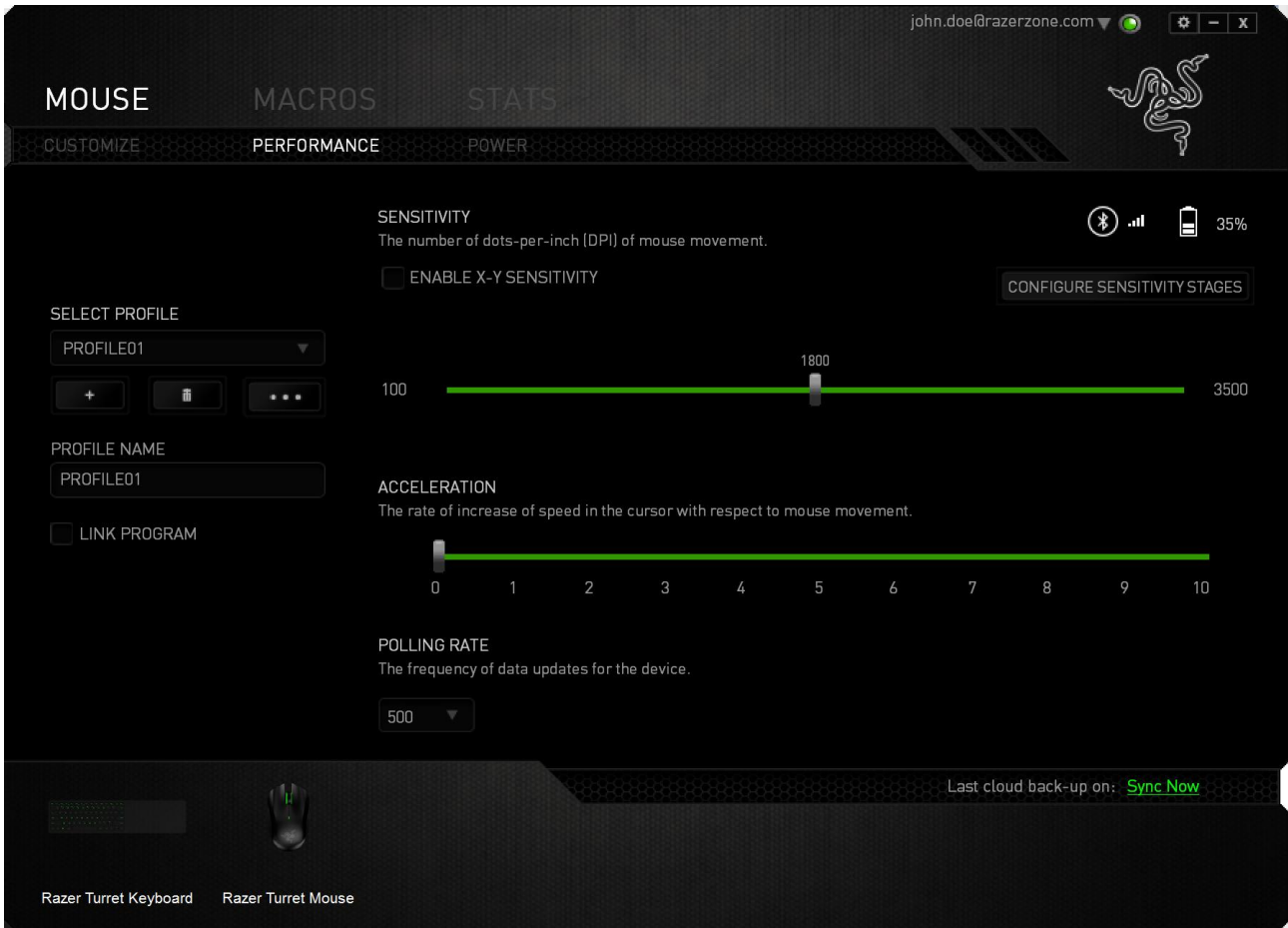

Listed below are the performance options and their descriptions.

Sensitivity

Sensitivity pertains to how much effort is needed to move the mouse pointer in any direction. The higher the sensitivity, the more responsive the mouse will be. (Recommended setting: 1600 – 1800)

Enable X-Y Sensitivity

By default, the X-axis (horizontal) and Y-axis (vertical) use the same sensitivity values. However, you may set different sensitivity values to each of the axes by selecting the *ENABLE X-Y SENSITIVITY* option.

Configure Sensitivity Stages

A sensitivity stage is a preset sensitivity value. You can create up to 5 different sensitivity stages which you can cycle through using the sensitivity stage up/down buttons. You may use the *ENABLE X-Y SENSITIVITY* concurrently with this option. Note that whenever you configure a sensitivity stage, your current sensitivity will match that setting.

Acceleration

Acceleration increases the cursor's movement speed depending on how quickly you move the mouse. The higher the value, the faster the mouse accelerates. (Recommended settings: Windows 0, Mac 5)

Polling Rate

The higher the polling rate, the more often the computer receives information about the status of your mouse, thus increasing the mouse pointer's reaction time. You can switch between 125Hz (8ms) and 500Hz (2ms) by selecting your desired polling rate on the dropdown menu. (Recommended setting: 500Hz)

Power Tab

The Power Tab allows you to manage your device's energy consumption when running on batteries. You can set your device to enter sleep mode when it has been idle for a certain amount of time. The Power Tab also allows you to be notified when the device's power is at a certain level.

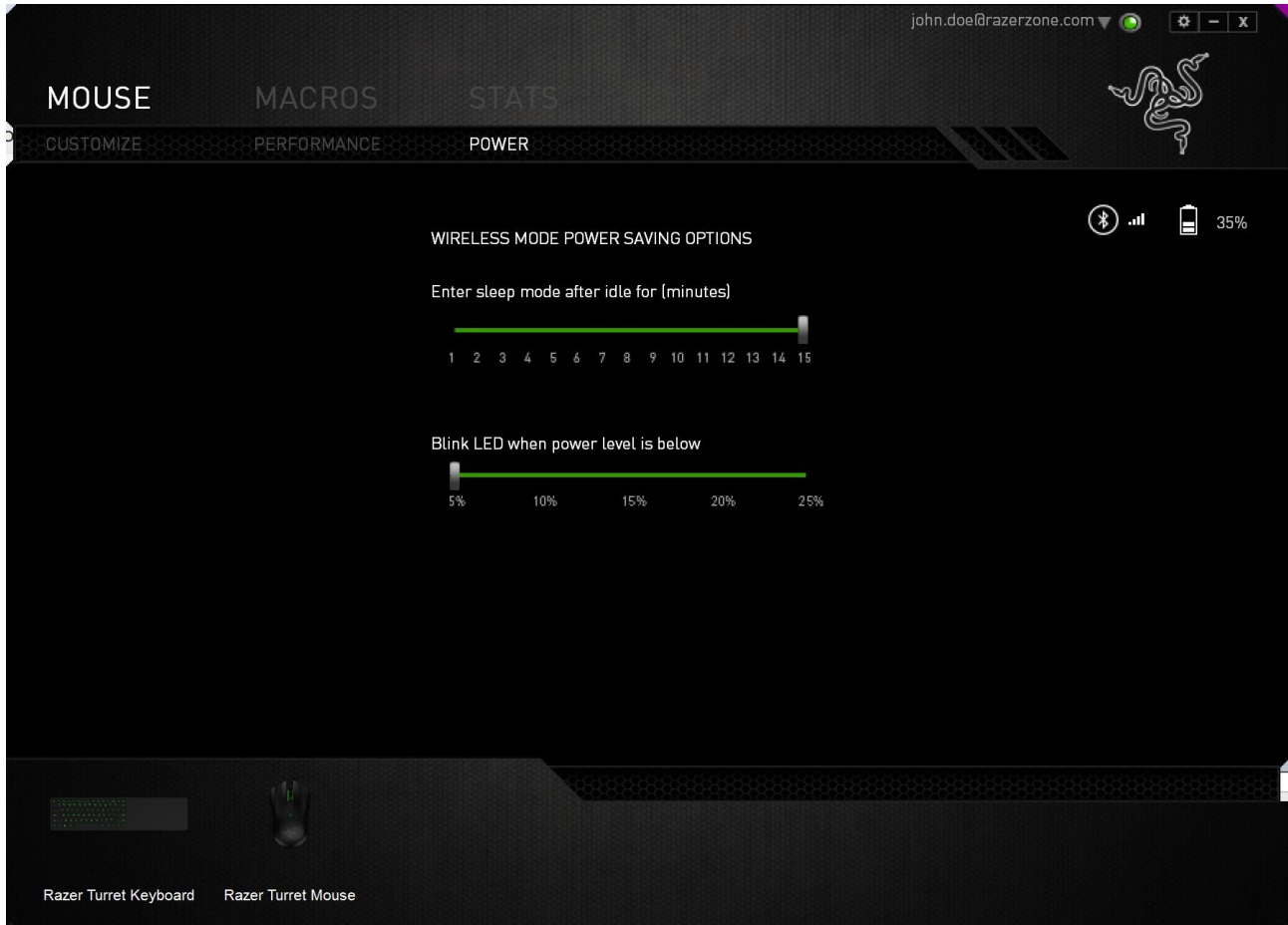





9. CONFIGURING YOUR RAZER TURRET – MACROS

Disclaimer: The features listed here require you to log in to Razer Synapse. These features are also subject to change based on the current software version and your Operating System.

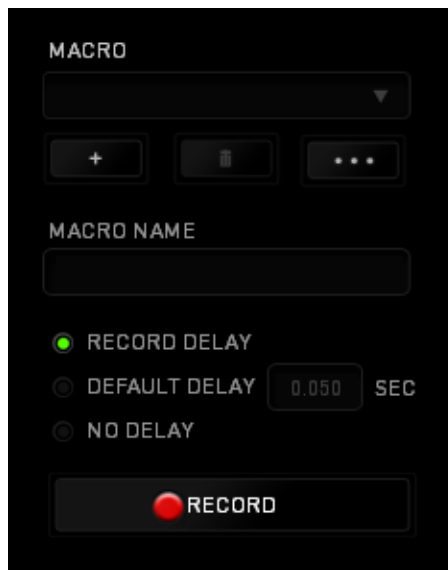
MACROS TAB

The Macros Tab allows you to create a series of precise keystrokes and button presses. This tab also allows you to have numerous macros and extremely long macro commands at your disposal.



The Macro section works similarly to Profile wherein you can rename a macro by typing on the field below *MACRO NAME*. There are also other options available in the macro section such as creating a new macro by clicking the  button, deleting the current macro by clicking the  button or duplicating the current macro by clicking the  button.

To create a macro command, simply click the  button and all your keystrokes and button presses will automatically register on the macro screen.

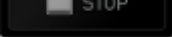
When you are done recording your macro commands, click on the  button to end the session.





The Macro section allows you to input the delay in-between commands. In *RECORD DELAY* the delay in-between commands are registered as how it is entered. The *DEFAULT DELAY* uses a predefined time (expressed in seconds) as the delay. And *NO DELAY* omits all the pauses in-between keystrokes and button presses.

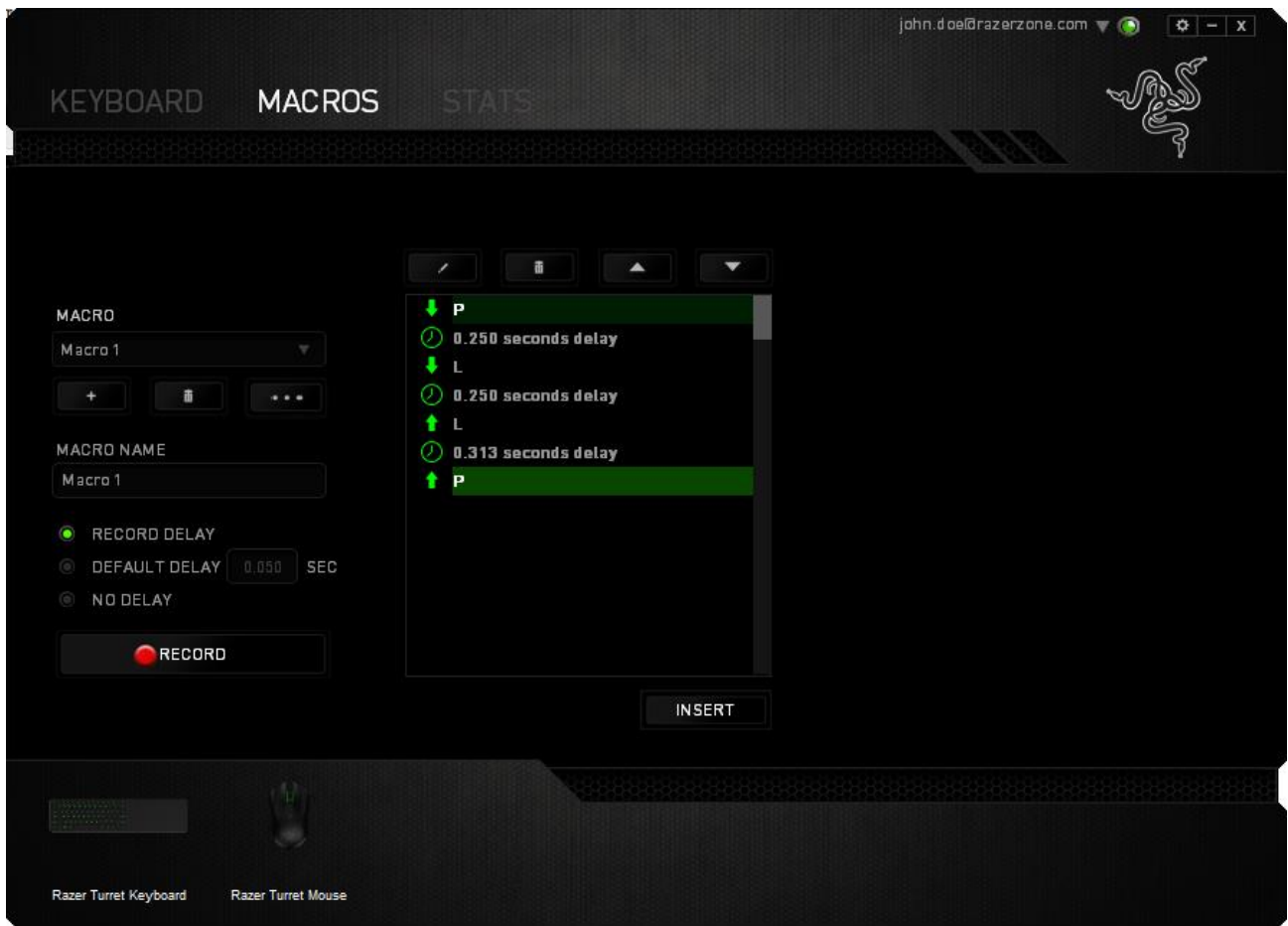

Note: You may use up to three decimal places when inserting values on the seconds (sec) field.

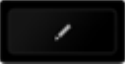
Once you have recorded a macro, you may edit the commands you have entered by selecting each command on the macro screen. Each keystroke or button press is arranged sequentially with the first command shown at the top of the screen.



The  button allows you to edit a particular command and the  button enables you to delete a command. The  and  buttons gives you the option to move the command up or down. The  button allows you to put in additional keystrokes, button presses or time delays either before or after the selected command.

Once you have pressed the Insert button, a new display window will appear beside the list of macro commands. The dropdown menu on this window allows you to choose a keystroke or a delay to be added in before or after the highlighted macro command.



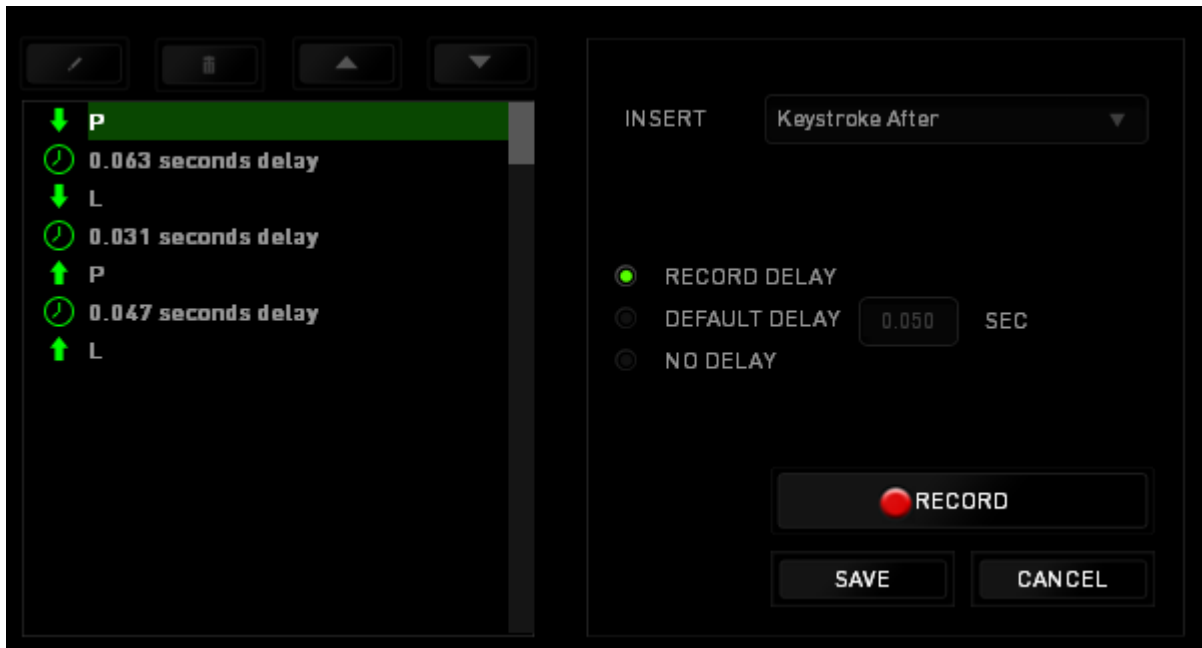

You may add in a new set of macro commands by clicking the  button on the keystroke menu; or input time delays on the duration field using the delay menu.

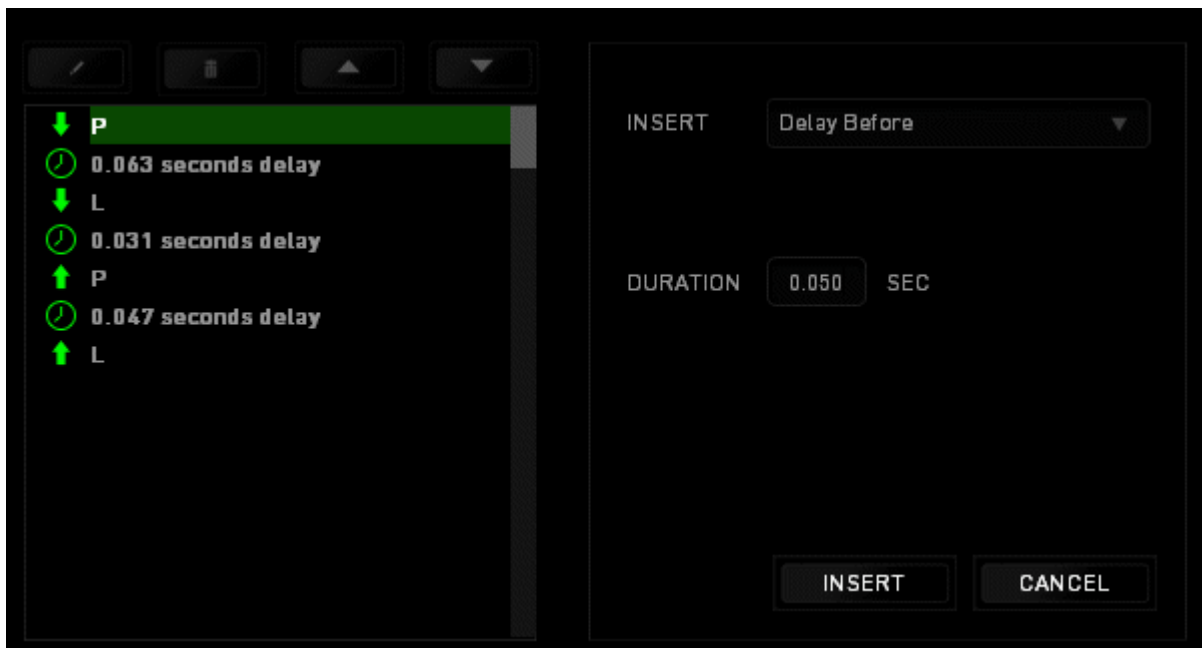

10. CONFIGURING YOUR RAZER TURRET – STATS AND HEATMAPS

Disclaimer: The features listed here require you to log in to Razer Synapse. These features are also subject to change based on the current software version and your Operating System.

STATS & HEATMAPS

Note: The images shown here are for reference only and may differ from the actual device.

Stats & Heatmaps help you analyze your gameplay by tracking your in-game mouse clicks, mouse movement and keyboard usage and visualizing it in form of heatmap overlays.

This function is disabled by default. To enable this function, click the notification icon next to your user name in the Razer Synapse window and select “Enable Stats & Heatmaps”.



Confirm to enable the function in the dialog box that appears.

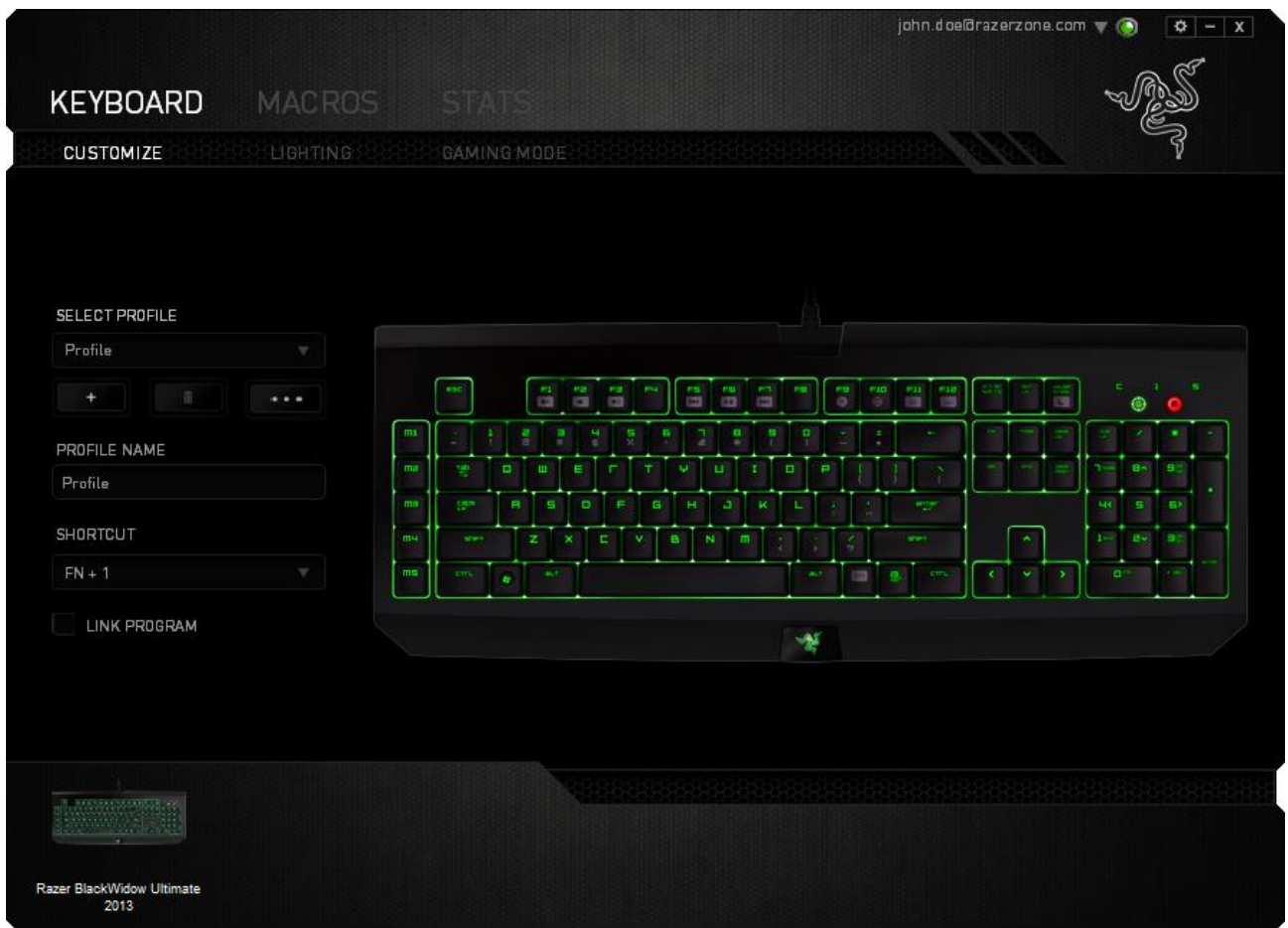

Return to Razer Synapse and a new “Stats” tab will be available. Simply click the tab to open the function window.

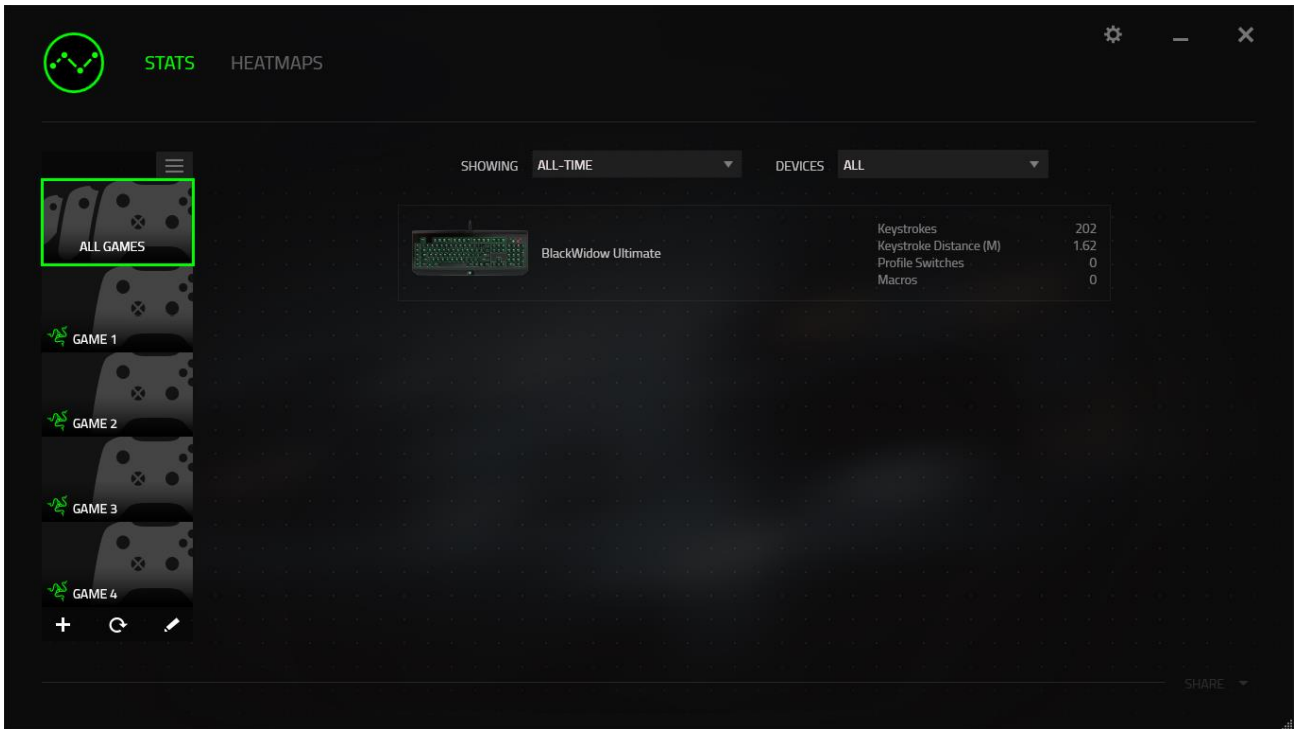

Games List

Stats & Heatmaps work by tracking the usage of all supported devices for each game. When the feature is enabled, it automatically scans your system for installed games and adds them to the Games List located on the left side of the screen. Click  to show or hide the Games List.



From this list, you can add more games that have not been automatically detected, using the , edit games with the  button or re-scan your system with the  button to search for newly installed games.

Stats Tab

By default, the Stats Tab shows you the overall statistics of all your Razer devices for all games and all time. You can select a specific game via the game list on the left side, change the time period using the *SHOWING* dropdown menu, or the Razer device using the *DEVICES* dropdown menu.

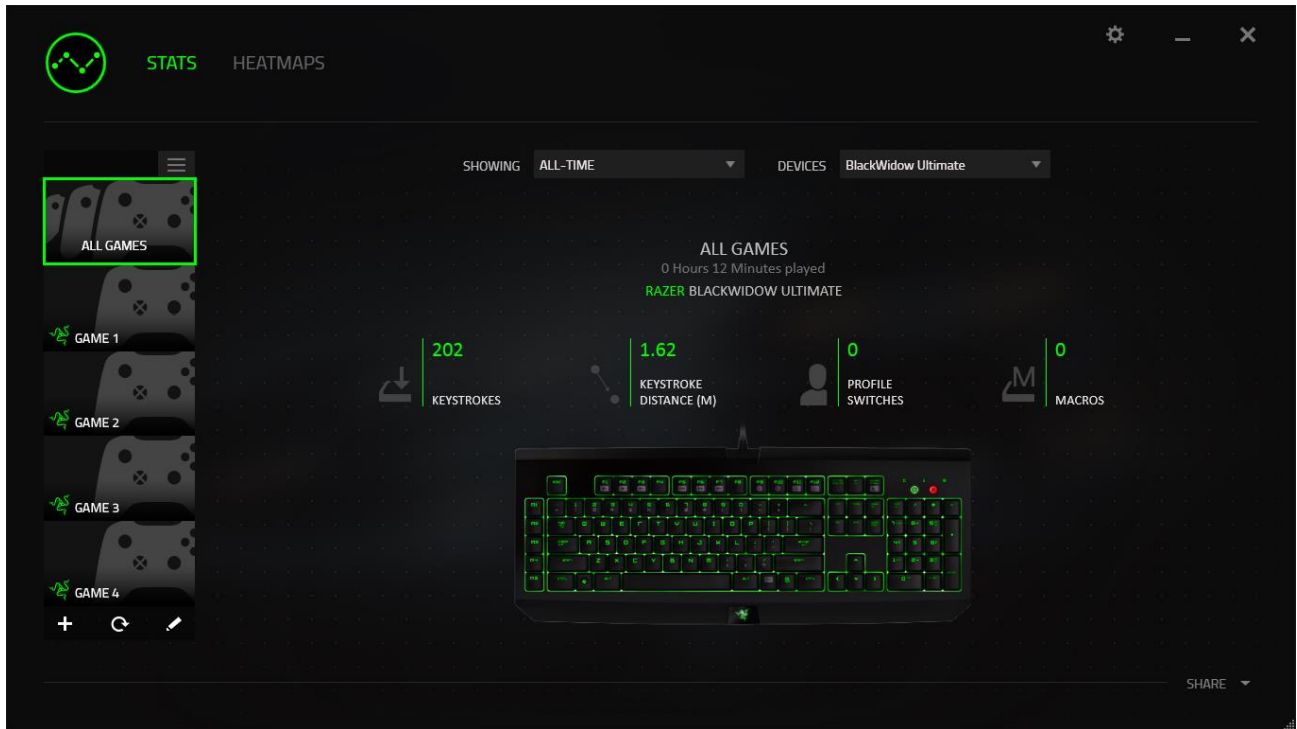

Heatmaps Tab - Mouse

Heatmaps Tab shows detailed information about your Razer device's in-game usage. This includes:

- The **Mouse Clicks** tab, a heat map showing the frequency of mouse clicks on different spots of your screen.

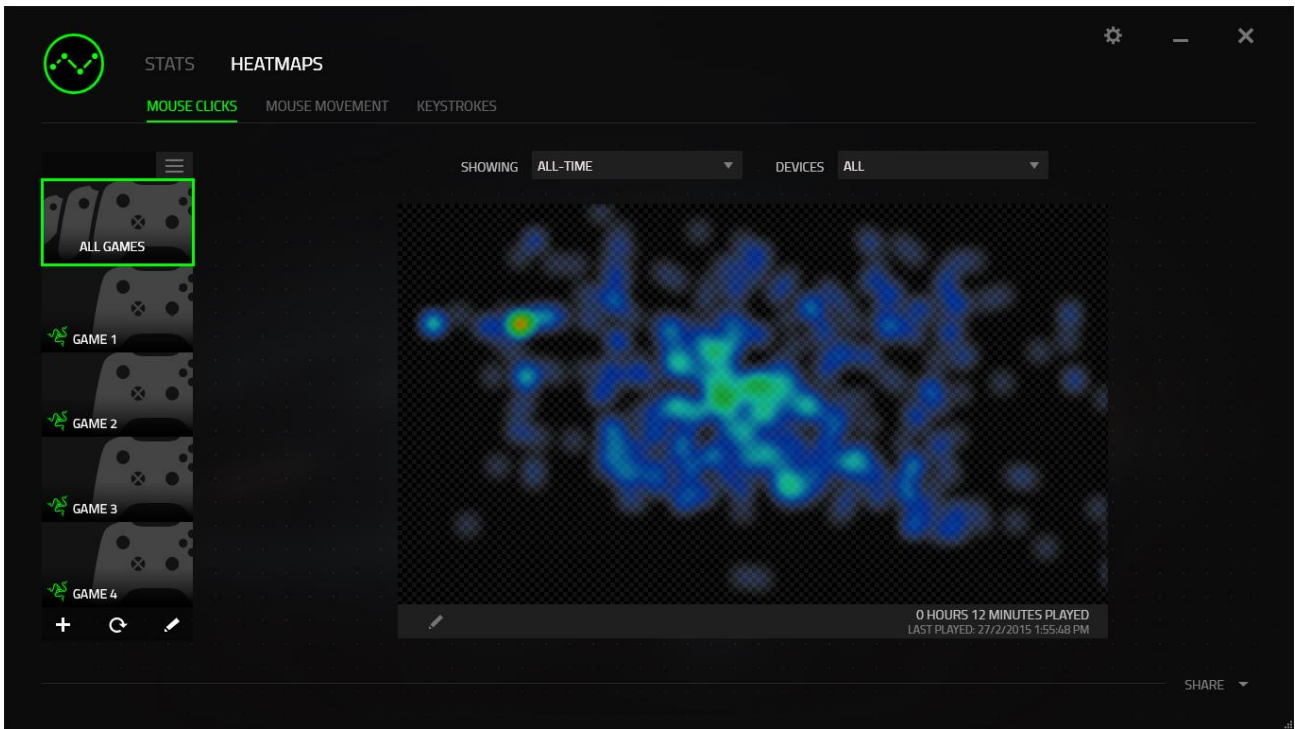

- The **Mouse Movement** tab which shows the movement of your mouse cursor during game play. This tab also displays the locations on screen where your mouse cursor stops in the form of white dots. The longer your cursor hovers at that spot, the larger the dot.

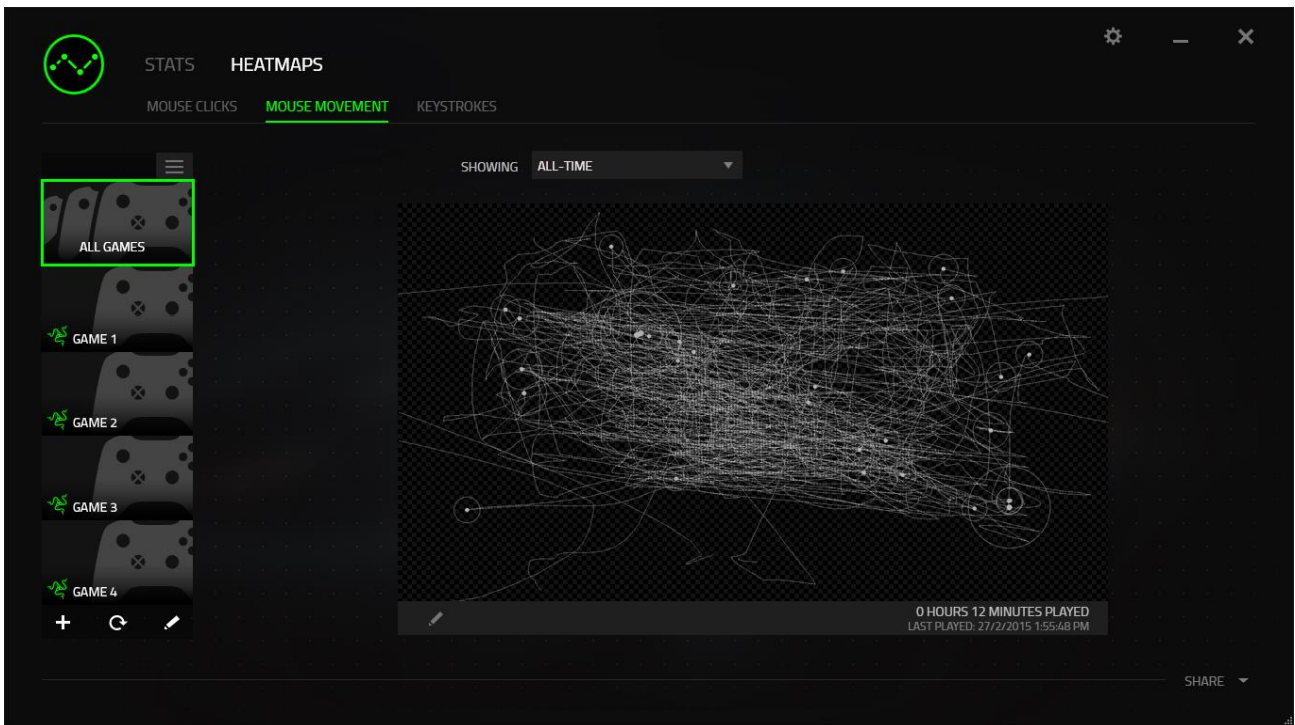



Mouse heatmaps can be overlaid on game screenshots.

Editing the Heatmap Image

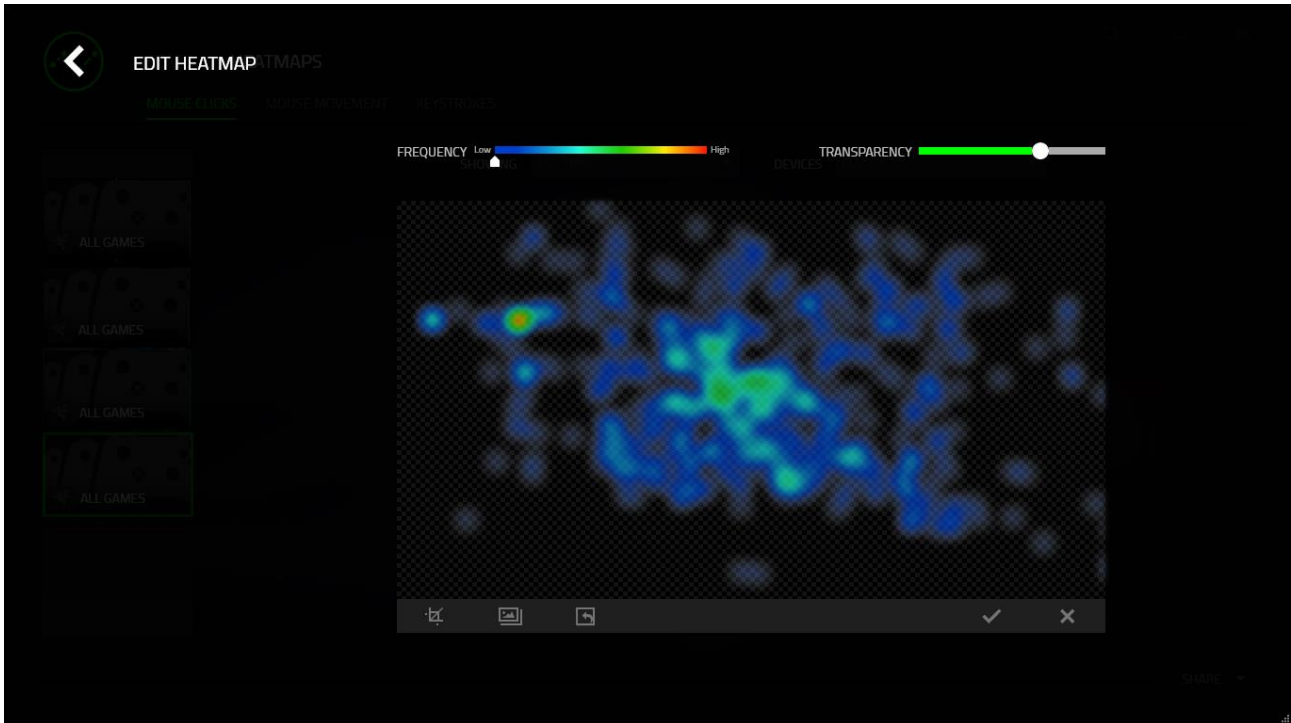
Click  to change the background image and/or transparency of the heatmap overlay



Here you can also adjust the transparency of the heatmap overlay on the background image

Click  to save the changes or  to exit without saving.

Heatmaps Tab - Keyboard

Heatmaps Tab shows the most frequently used keys on your Razer device for each game on your Games List.

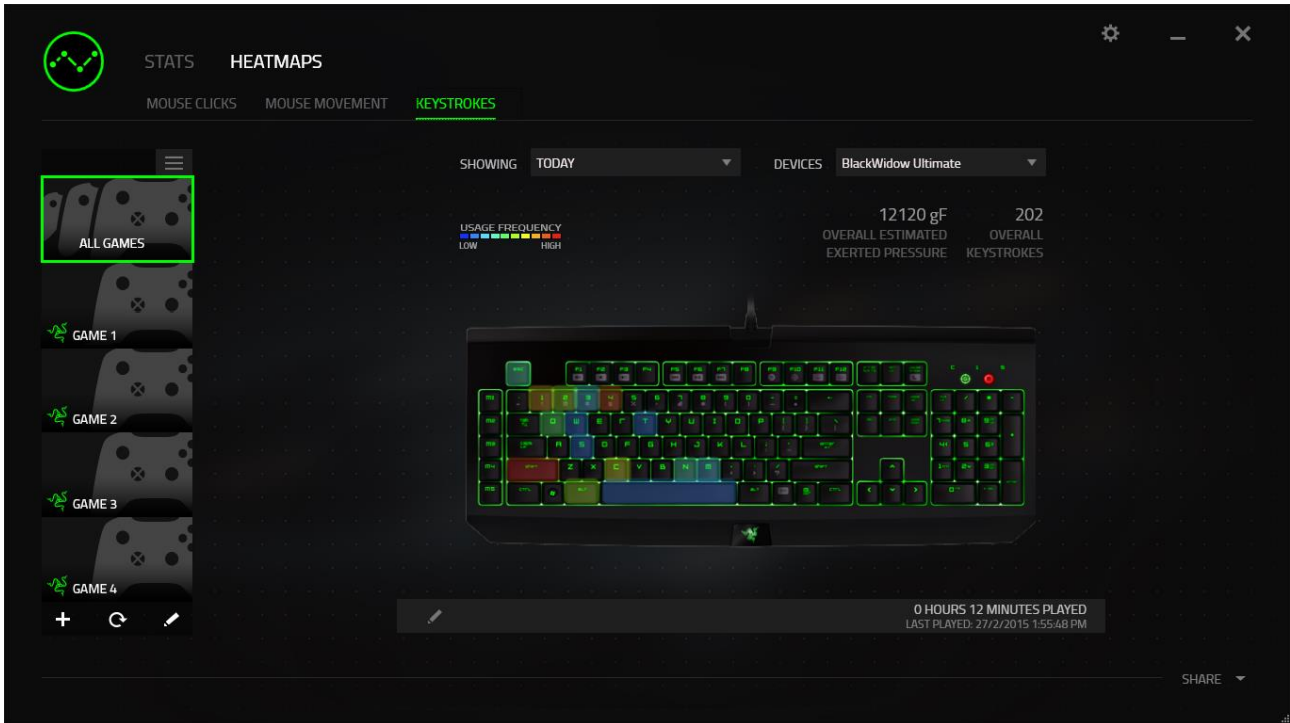

Social Media

You can share your heatmap image on social media networks such as Facebook or Twitter directly from Razer Synapse.

From the **Heatmaps** tab, click the **Share** button on the bottom right of the screen. You will be prompted to login to the selected social media using an existing account if you have not already done so.

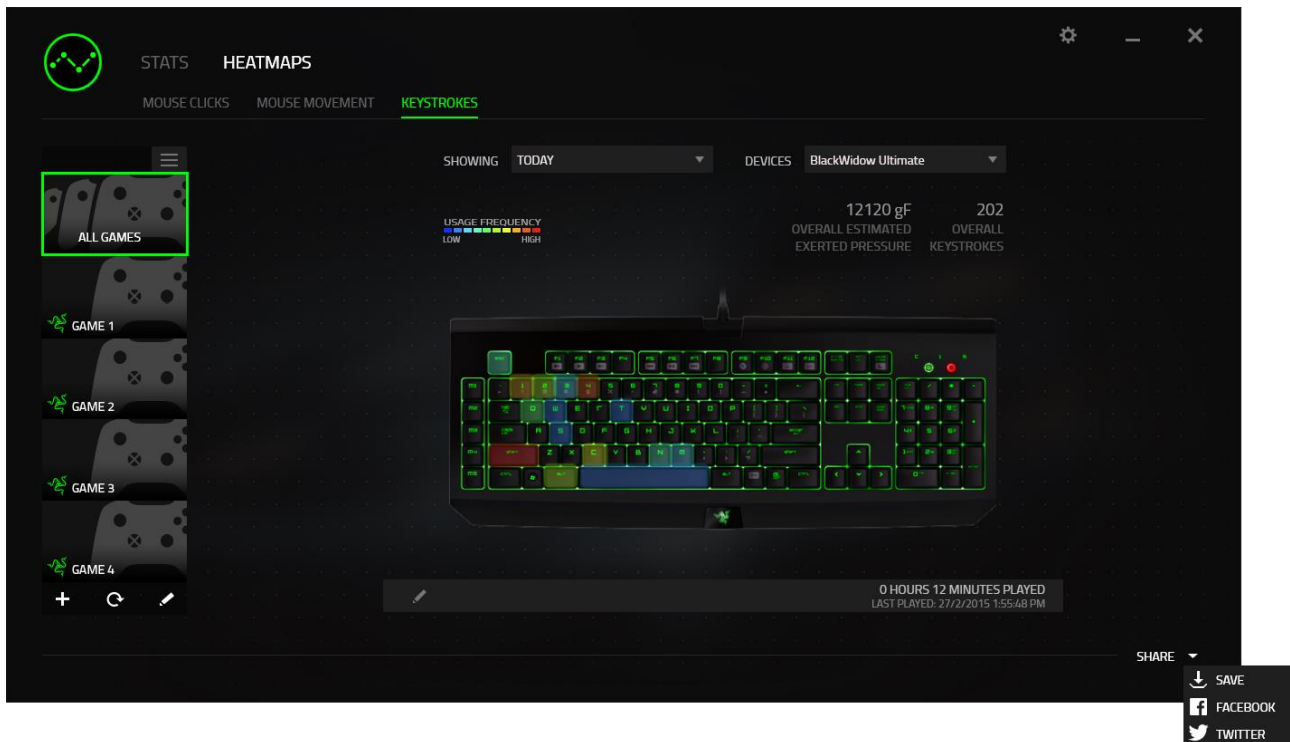

You can also login to your social media accounts first from the “SETTINGS” screen.

From the Stats & Heatmaps window, click . Select the “ACCOUNTS” tab. Click **CONNECT** next to the social media network you wish to sync with. Enter your login details and wait for the connection to complete.

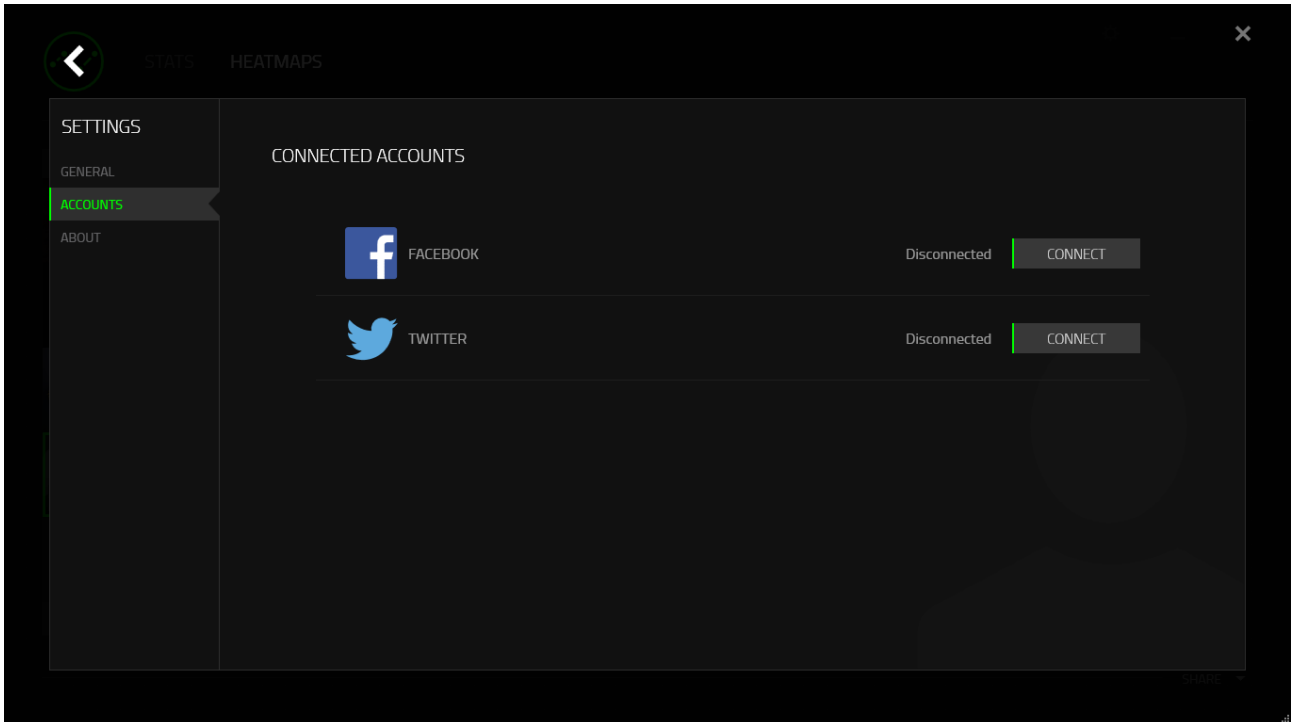

11. SAFETY AND MAINTENANCE

IMPORTANT SAFETY & MAINTENANCE INFORMATION

WARNING: Failure to follow these safety instructions could result in fire, electric shock, or other injury or damage.

Please follow these safety rules for handling your Razer Turret and for working more comfortably. Keep these guide handy for future reference by you and others.

To operate your Razer Turret safely and reduce the possibility of heat-related injuries, follow these guidelines:

1. Set up your Razer Turret and power adapter on a stable work surface that allows for adequate air circulation under and around the computer/TV.
2. Do not use or install near water, moisture, or other wet surfaces.
3. Do not use or install near any heat or naked flame sources. Do not use around radiators, stoves, fire places, candles or other hot surfaces.
4. Do not block ventilation grills or openings. Install the apparatus in a cool, dry place.
5. Clean only with a dry or damp cloth. Unplug the apparatus before cleaning and do not use aerosol or liquid cleaning agents.
6. Do not insert or push any objects into openings on the product.
7. Refer all servicing to qualified service personnel. Do not attempt to service this apparatus yourself. Removing the covers will expose you to dangerous electric currents.

POWER ADAPTER FOR THE RAZER TURRET

NOTICE: Incorrect storage or use of your power adapter may void the manufacturer's warranty.

This power adapter complies with the user-accessible surface temperature limits defined by the International Standard for Safety of Information Technology Equipment (IEC 60950-1).

This apparatus should only be operated from the type of power source indicated on the label. If you are unsure of the power source in the location you intend to operate the apparatus please consult the local power company or a qualified technician. The use of AC Plug Adapters is cautioned because it can allow the product to be plugged into voltages in which the product was not designed to operate. If you are unsure of the correct operational voltage, please contact your local distributor and/or retailer.

1. Use only the power adapter that came with your Razer Turret, or the Razer-authorized power adapter that is compatible with this product.
2. The power adapter is equipped with exchangeable adapter plug, use only the appropriate adapter plug for your region.
3. Make sure the exchangeable adapter plug is fully inserted into the power adapter before plugging the adapter into a power outlet.
4. The power adapter may become very warm during normal use. Never place anything over the power adapter when operating your apparatus.
5. Unplug this apparatus during lightning storms or when unused for extended periods of time to further protect the apparatus.
6. Protect the power cord from being walked on or pinched, particularly at plugs, convenience receptacles, or the point where they exit from the apparatus.
7. Do not overload wall electricity outlets, extension cords and plugs. This may result in fire or electrical shock.

8. Disconnect the power adapter and disconnect any other cables if any of the following conditions exists:
 - You want to clean the case
 - The power cord or plug becomes frayed or otherwise damaged.
 - Your Razer Turret or power adapter is exposed to rain, excessive moisture, or liquid spilled into the case.
 - Your Razer Turret or power adapter has been dropped, the case has been damaged, or you suspect that service or repair is required.

SAFETY GUIDELINES

In order to achieve maximum safety while using your Razer Turret, we suggest that you adopt the following guidelines:

1. Should you have trouble operating the device properly and troubleshooting does not work, unplug the device and contact the Razer hotline or go to www.razersupport.com for support. Do not attempt to service or fix the device yourself at any time.
2. Do not take apart the device (doing so will void your warranty) and do not attempt to operate it under abnormal current loads.
3. Keep the device away from liquid, humidity or moisture. Operate the device only within the specific temperature range of 0°C (32°F) to 40°C (104°F). Should the temperature exceed this range, unplug and/or switch off the device in order to let the temperature stabilize to an optimal level.

COMFORT

Research has shown that long periods of repetitive motion, improper positioning of your computer peripherals, incorrect body position, and poor habits may be associated with physical discomfort and injury to nerves, tendons, and muscles. Below are some guidelines to avoid injury and ensure optimum comfort while using your Razer Turret.

1. Position your keyboard and monitor directly in front of you with your mouse next to it. Place your elbows next to your side, not too far away and your Keyboard within easy reach.

2. Keep your feet well supported, posture straight and your shoulders relaxed.
3. During gameplay, relax your wrist and keep it straight. If you do the same tasks with your hands repeatedly, try not to bend, extend or twist your hands for long periods.
4. Do not rest your wrists on hard surfaces for long periods. Use a wrist rest to support your wrist while gaming.
5. Do not sit in the same position all day. Get up and do exercises to stretch your arms, shoulders, neck and legs.
6. If you should experience any physical discomfort while using your device, such as pain, numbness, or tingling in your hands, wrists, elbows, shoulders, neck or back, please consult a qualified medical doctor immediately.

MAINTENANCE AND USE

The Razer Turret requires minimum maintenance to keep it in optimum condition. Once a month we recommend you unplug the device from the computer and clean it using a soft cloth or cotton swab with a bit of warm water to prevent dirt buildup. Do not use soap or harsh cleaning agents.

12. LEGALESE

COPYRIGHT AND INTELLECTUAL PROPERTY INFORMATION

©2016 Razer Inc. Patent Pending. All rights reserved. Razer, For Gamers By Gamers, and the triple-headed snake logo are trademarks or registered trademarks of Razer Inc. and/or affiliated companies in the United States or other countries. All other trademarks are the property of their respective owners. Actual product may differ from pictures. Information is correct at time of printing. Windows and the Windows logo are trademarks of the Microsoft group of companies.

Android™ and Android TV™ are trademarks of Google Inc.

The Bluetooth word mark and logos are owned by the Bluetooth SIG. Inc. and any use of such marks by Razer is under license.

Razer Inc. (“Razer”) may have copyright, trademarks, trade secrets, patents, patent applications, or other intellectual property rights (whether registered or unregistered) concerning the product in this guide. Furnishing of this guide does not give you a license to any such copyright, trademark, patent or other intellectual property right. The Razer Turret (the “Product”) may differ from pictures whether on packaging or otherwise. Razer assumes no responsibility for such differences or for any errors that may appear. Information contained herein is subject to change without notice.

LIMITED PRODUCT WARRANTY

For the latest and current terms of the Limited Product Warranty, please visit www.razerzone.com/warranty.

LIMITATION OF LIABILITY

Razer shall in no event be liable for any lost profits, loss of information or data, special, incidental, indirect, punitive or consequential or incidental damages, arising in any way out of distribution of, sale of, resale of, use of, or inability to use the Product. In no event shall Razer’s liability exceed the retail purchase price of the Product.

COSTS OF PROCUREMENT

For the avoidance of doubt, in no event will Razer be liable for any costs of procurement unless it has been advised of the possibility of such damages, and in no case shall Razer be liable for any costs of procurement liability exceeding the retail purchase price of the Product.

GENERAL

These terms shall be governed by and construed under the laws of the jurisdiction in which the Product was purchased. If any term herein is held to be invalid or unenforceable, then such term (in so far as it is invalid or unenforceable) shall be given no effect and deemed to be excluded without invalidating any of the remaining terms. Razer reserves the right to amend any term at any time without notice.