

User's Guide

1859m

2009m/v/f

2159m/v

2309m/v

The only warranties for HP products and services are set forth in the express warranty statements accompanying such products and services. Nothing herein should be construed as constituting an additional warranty. HP shall not be liable for technical or editorial errors or omissions contained herein.

HP assumes no responsibility for the use or reliability of its software on equipment that is not furnished by HP.

This document contains proprietary information that is protected by copyright. No part of this document may be photocopied, reproduced, or translated to another language without the prior written consent of HP.

Hewlett-Packard Company
10955 Tantau Avenue
Cupertino, California 95014-0770
USA

Copyright © 2006–2009 Hewlett-Packard Development Company, L.P.

Microsoft and Windows are U.S. registered trademarks of Microsoft Corporation.

Adobe and Acrobat are trademarks of Adobe Systems Incorporated.

ENERGY STAR and the ENERGY STAR logo are U.S. registered marks of the United States Environmental Protection Agency.

Bluetooth is a trademark owned by its proprietor and used by Hewlett-Packard Company under license.

HP supports lawful use of technology and does not endorse or encourage the use of its products for purposes other than those permitted by copyright law.

The information contained herein is subject to change without notice.

Notational Conventions

The following section describes notational conventions used in this document.

Notes, Cautions, and Warnings

Throughout this guide, blocks of text may be accompanied by an icon. These blocks are notes, cautions, and warnings, and they are used as follows:



WARNING: Indicates that failure to follow directions could result in bodily harm or loss of life.



CAUTION: Indicates that failure to follow directions could result in damage to equipment or loss of information.



NOTE: Indicates additional information.

Contents

Notational Conventions.....	iii
Notes, Cautions, and Warnings.....	iii
1 Product Features	
HP LCD Monitors.....	1-1
Features.....	1-1
2 Safety and Maintenance Guidelines	
Important Safety Information.....	2-1
Safety Precautions.....	2-1
Maintenance Guidelines.....	2-2
Cleaning the Monitor.....	2-2
3 Setting Up the Monitor	
Unpacking the Monitor.....	3-1
Installing the Monitor.....	3-1
Preparing the monitor for desktop use.....	3-1
Preparing the monitor for wall-mounting.....	3-2
Connecting the VGA (Analog) or DVI-D (Digital) Cable.....	3-5
To connect the VGA cable.....	3-5
To connect the DVI-D cable.....	3-5
Connecting the HDMI Cable (Select Models Only).....	3-6
Audio and Video Cables and Adapters.....	3-6
High-Bandwidth Digital Content Protection (HDCP).....	3-7
Connecting the Audio Cable.....	3-7
Connecting the Power Cable.....	3-8
Cable Management.....	3-9
Adjusting the Tilt.....	3-9
Adjusting the Swivel.....	3-10
Keyboard Parking.....	3-10
4 Operating the Monitor	
CD Software and Utilities.....	4-1
Installing Drivers.....	4-1
Downloading updated drivers from the Internet.....	4-1
Using the Auto-Adjustment Function.....	4-2
Front-Panel Controls.....	4-3
Using the On-screen Display (OSD).....	4-3
OSD Menu Selections.....	4-4
Selecting Video Input Connectors.....	4-7
Identifying Monitor Conditions.....	4-7
Adjusting Screen Quality.....	4-8
Optimizing Analog Video.....	4-8
Power-Saver Feature.....	4-8
5 Preparing the Monitor for Shipping	
Preparing the Monitor for Shipping.....	5-1

A Troubleshooting

Solving Common Problems	A-1
Getting Support from hp.com	A-3
Preparing to Call Technical Support.....	A-3
Locating the Rating Label.....	A-3

B Technical Specifications

HP LCD Monitors	B-1
Preset Video and High-Definition Modes.....	B-4
LCD Monitor Quality and Pixel Policy.....	B-6
Power Cord Set Requirements	B-6

C Agency Regulatory Notices

Federal Communications Commission Notice.....	C-1
Modifications.....	C-1
Cables	C-1
Declaration of Conformity for Products Marked with FCC Logo, United States Only	C-1
Materials Disposal.....	C-2
Chemical Substances	C-2
Canadian Notice	C-2
Avis Canadien	C-2
European Union Regulatory Notice.....	C-2
Disposal of Waste Equipment by Users in Private Households in the European Union.....	C-3
Japanese Notice	C-3
Japanese Power Cord Notice.....	C-3
Japanese Material Content Declaration	C-3
Korean Notice	C-3
EPA ENERGY STAR® Compliance	C-4
HP Recycling Program.....	C-4

D Index

HP LCD Monitors

The HP LCD (liquid crystal display) monitors have an active matrix, thin-film transistor (TFT) screen. This guide discusses the following models:

- 1859m LCD monitor
- 2009m/v/f LCD monitor
- 2159m/v LCD monitor
- 2309m/v LCD monitor

Features

- Large diagonal display
- Optimum resolution:
 - 1859m: 1366 x 768 @ 60Hz
 - 2009m/v/f: 1600 x 900 @ 60Hz
 - 2159m/v: 1920 x 1080 @ 60Hz
 - 2309m/v: 1920 x 1080 @ 60HzPlus full-screen support for lower resolutions
- Video inputs supported:
 - VGA analog signal (select models only)
 - DVI digital signal (select models only)
 - High-definition multimedia interface (HDMI) (select models only)
- Fast response time, providing better experience for gaming and graphics
- Easy viewing from a sitting or standing position, or while moving from one side of the monitor to the other
- Tilt adjustment
- Swivel adjustment
- Removable pedestal and Video Electronics Standards Association (VESA) standard mounting holes for flexible mounting solutions, including wall-mounting
- Security lock slot for a locking security cable (security cable sold separately)
- Plug and Play capability, if supported by your computer system
- On-screen display (OSD) adjustments for ease of setup and screen optimization (choose English, Simplified Chinese, French, German, Italian, Spanish, Dutch, Japanese, or Brazilian Portuguese)
- Built-in stereo speakers, downward firing
- Keyboard parking
- Power Saver to reduce energy consumption
- Quick View settings display

- CD included:
 - Drivers
 - Auto-adjustment software
 - Webcam software (select models only)
 - Documents
 - Adobe® Acrobat® Reader

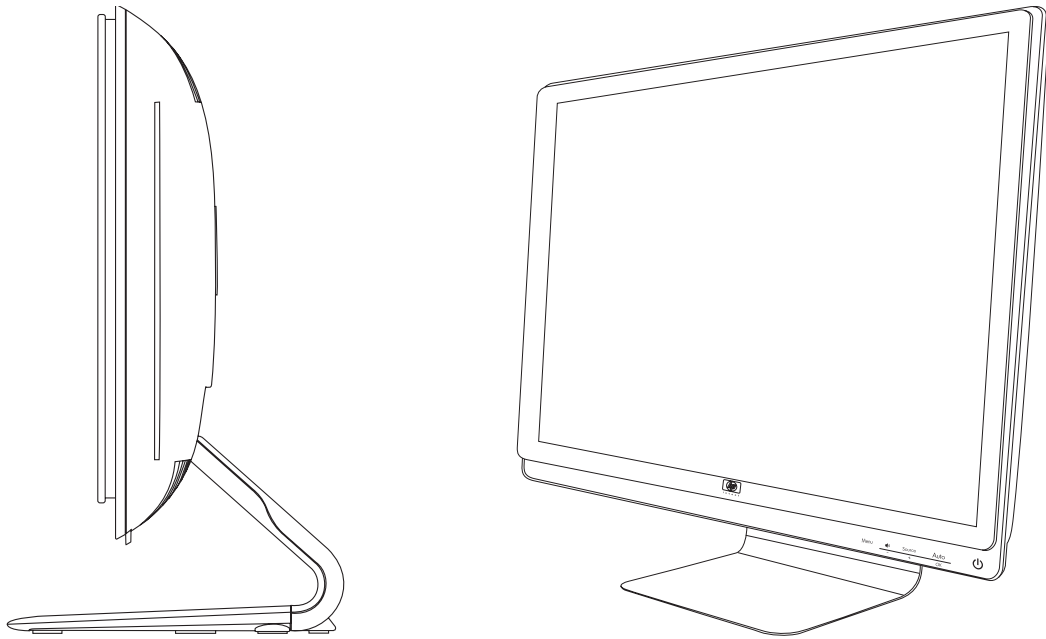

Safety and Maintenance Guidelines

Important Safety Information

The power cord is designed for use with your monitor. To use a different cord, use only a power source and connection compatible with this monitor.



WARNING: Always connect your monitor, the computer, and other equipment to a grounded (earthed) power outlet. To reduce the risk of electric shock or damage to your equipment, do not disable the power cord grounding feature. The grounding plug is an important safety feature.



WARNING: For your safety, be sure that the grounded power outlet you plug the power cord into is easily accessible to the operator and located as close to the equipment as possible. To disconnect power from the equipment, unplug the power cord from the power outlet by grasping the plug firmly. Never pull on the cord.



CAUTION: To protect your monitor, as well as your computer, connect all power cords for your computer and its peripheral devices (such as a monitor, printer, or scanner) to a surge protection device such as a power strip with surge protection or uninterruptible power supply (UPS).

Not all power strips provide surge protection; the power strips must be specifically labeled as having this ability. Use a power strip whose manufacturer offers a damage replacement policy, so you can replace your equipment if surge protection fails.

Safety Precautions

- Use only a power source and connection compatible with this monitor, as indicated on the label/back plate of the monitor.
- Be sure the total ampere rating of the products connected to the outlet does not exceed the current rating of the electrical outlet, and the total ampere rating of the products connected to the power cord does not exceed the rating of the power cord. Look on the power label to determine the ampere rating (Amps or A) for each device.
- Install your monitor near a power outlet that you can easily reach. Disconnect the monitor by grasping the plug firmly and pulling it from the outlet. Never disconnect the monitor by pulling the cord.
- Do not allow anything to rest on the power cord. Do not walk on the cord.

Maintenance Guidelines

To enhance the performance and extend the life of your monitor:

- Do not open your monitor cabinet or attempt to service this product yourself. If your monitor is not operating properly or has been dropped or damaged, contact your Hewlett-Packard authorized dealer, reseller, or service provider.
- Adjust only those controls that are described in the operating instructions.
- Turn your monitor off when not in use. You can substantially increase the life expectancy of the monitor by using a screen saver program and turning off the monitor when not in use.
- Keep your monitor in a well-ventilated area, away from excessive light, heat, or moisture.
- Slots and openings in the cabinet are provided for ventilation. These openings must not be blocked or covered. Never push objects of any kind into cabinet slots or other openings.
- Unplug the monitor from the power outlet before cleaning. Do not use liquid cleaners or aerosol cleaners.
- Do not drop the monitor or place it on an unstable surface.
- When removing the monitor base, you must lay the monitor face down on a soft area to prevent it from getting scratched, defaced, or broken.

Cleaning the Monitor

The monitor is a high-quality optical device that requires special care when cleaning. To clean the monitor, follow these steps:

1. Turn off the computer and the monitor.
2. Unplug your monitor from the power outlet before cleaning.



CAUTION: Do not use benzene, thinner, ammonia, or any volatile substance to clean the monitor screen or cabinet. These chemicals may damage the monitor. Do not use liquid or aerosol cleaners. Never use water to clean an LCD screen.

3. Wipe the screen with a dry, soft, clean cloth.
If the screen requires additional cleaning, use an antistatic screen cleaner.
4. Dust the monitor housing. Use a damp cloth to clean the cabinet.
If the cabinet requires additional cleaning, use a clean cloth dampened with isopropyl alcohol.
5. Plug in the monitor.
6. Turn on the monitor and the computer.

Setting Up the Monitor

Unpacking the Monitor

1. Unpack the monitor. Make sure all contents are included. Store the packing box.
2. Turn off the computer and other attached devices.
3. Determine whether the monitor will be desktop mounted or wall-mounted. See "Installing the Monitor" in this chapter.
4. Prepare a flat area to assemble the monitor. You may need a flat, soft, protected area for placing the monitor screen-down while preparing it for installation.
5. You need a Phillips screwdriver for preparing the monitor for wall-mounting. You may need a straight-slot screwdriver to secure some cables.

Installing the Monitor

You can install the monitor on a desktop or wall-mount it. Place the monitor in a convenient, well-ventilated location near your computer.

Connect the monitor cables after you have installed the monitor.

Preparing the monitor for desktop use

 **CAUTION:** The screen is fragile. Avoid touching or applying pressure to the LCD screen; doing so can cause damage. Unfold the monitor by lifting it from the top edge of the bezel.

1. Set the monitor screen face down on a flat, soft, protected surface.

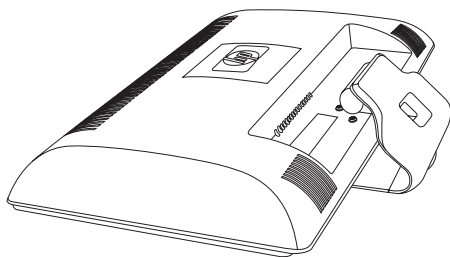

Unfolding the monitor

2. Grip the base near where it attaches to the monitor with one hand and lift the top part of the monitor until it is unfolded into the desired position.

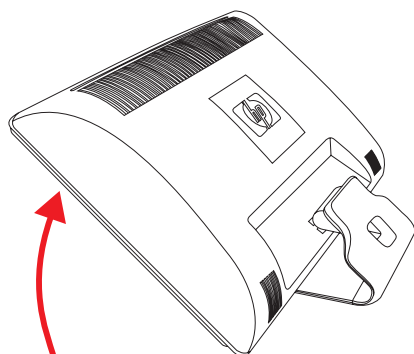

3. Lift the monitor to an upright position and place on a flat, stable surface.

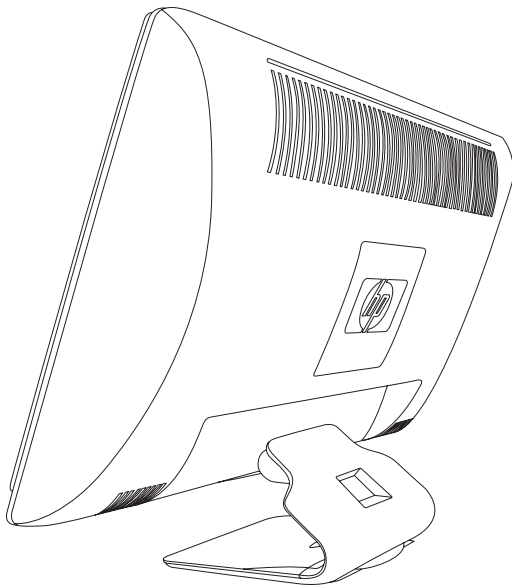

Monitor in upright position

Preparing the monitor for wall-mounting

⚠ WARNING: To reduce the risk of personal injury or of damage to the equipment, check that the wall-mounting fixture is adequately installed and secured before attaching the monitor. Refer to the instructions supplied with the wall-mounting fixture and check that it is capable of supporting the monitor.

1. Disconnect the power cable and any other cables from the monitor.
2. Place the monitor face down on a flat, protected surface.
3. Remove the four screws that fasten monitor base to the monitor.

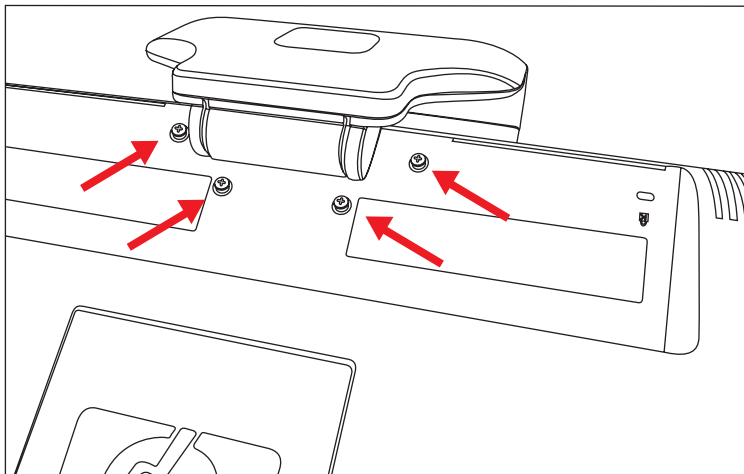

Location of screws securing base to monitor

4. Slide the base away from the bottom of the monitor.

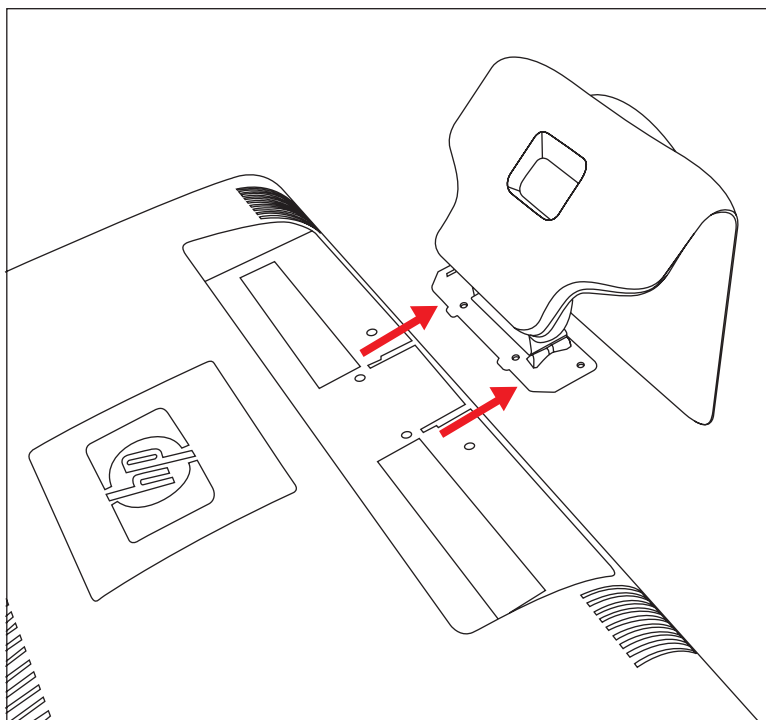

Sliding the base away from the monitor

5. Remove the square plate on the back of monitor. Use a coin at the base of the plate to pry it loose.

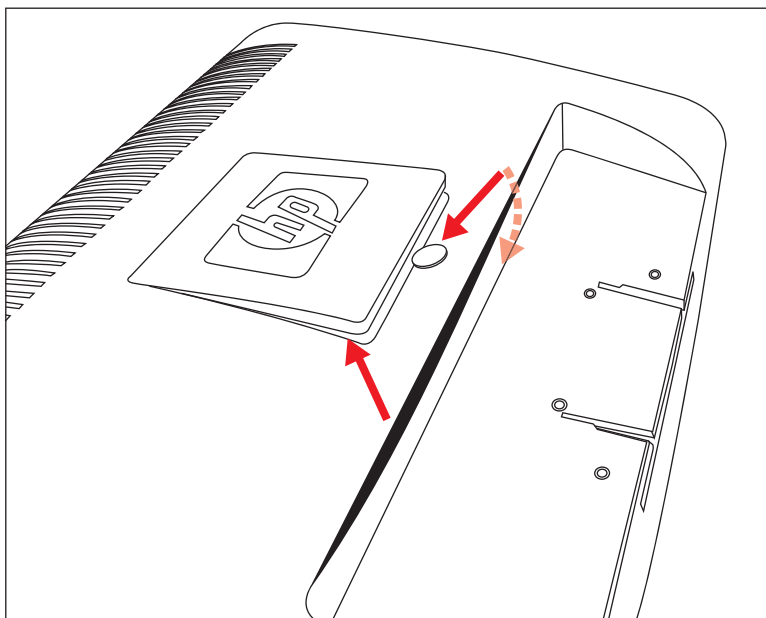

Removing the plate from the back of the monitor

Four threaded holes are exposed. These holes are for screws to attach the swing arm or other mounting fixture to the back of the monitor.

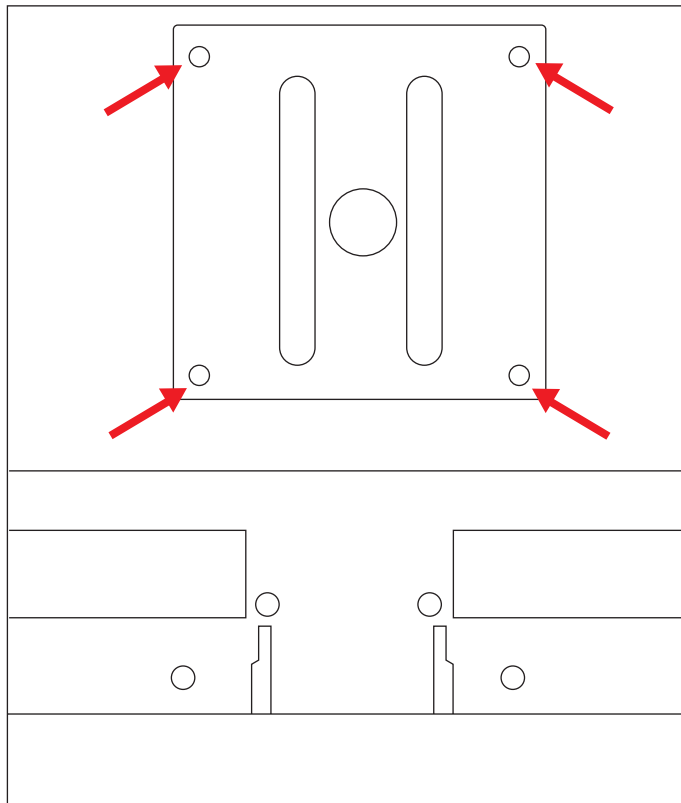

Threaded holes for attaching wall mount

- 6.** Follow the instructions included with the mounting fixture to ensure that the monitor is safely attached.
The four threaded holes that are on the back of the panel are compliant with the VESA standard for mounting flat-panel monitors.
- 7.** Attach a swing arm or other mounting fixture.

Connecting the VGA (Analog) or DVI-D (Digital) Cable

Use a VGA video cable or a DVI-D video cable (provided with select models). To use DVI, you must have a DVI-compliant graphic card. Connectors are located on the back of the monitor. Be sure the computer and monitor are turned off and unplugged.

Some graphic cards have both a DVI connector and a DVI-to-VGA converter included in the box (select models only). If the monitor has a VGA connector but no DVI connector, use the DVI-to-VGA converter to connect to the computer: Connect the DVI-to-VGA converter to the DVI connector on the computer graphic card, and then connect the VGA cable to the converter and the monitor.

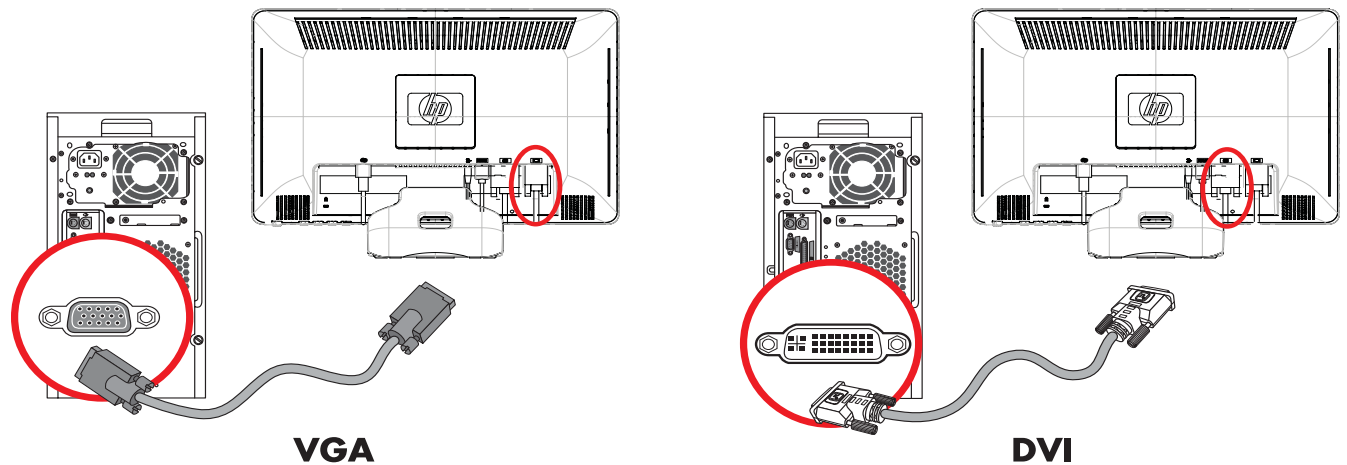

Connecting the VGA or DVI-D cable—connector locations may vary

To connect the VGA cable

Connect one end of the VGA video cable to the back of the monitor and the other end to the VGA video connector on the computer.

To connect the DVI-D cable

Connect one end of the DVI-D video cable to the back of the monitor and the other end to the DVI video connector on the computer. You can use this cable only if your computer has a DVI-compliant graphic card installed. The monitor DVI-D connector and cable are included with select models only.



NOTE: If you use a DVI-to-HDMI adapter, you must connect the green audio cable to enable the speakers. The signal from the DVI connector is for video only.

Connecting the HDMI Cable (Select Models Only)

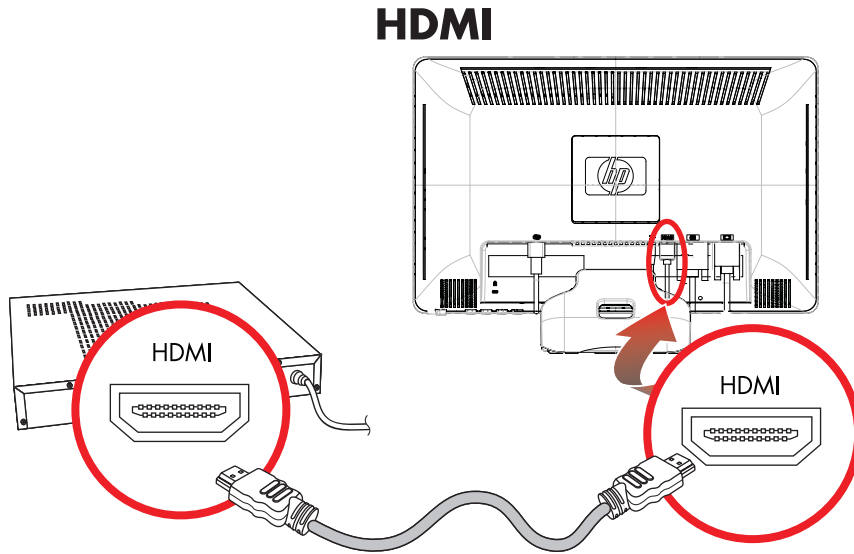

Connect one end of the HDMI cable to the back of the monitor and the other end to a computer with an HDMI connector.



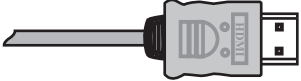
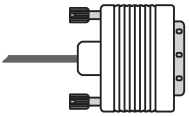

Audio and Video Cables and Adapters

The following table shows the cable and adapter types that may be required to connect the monitor to the computer, TV, or set-top box.

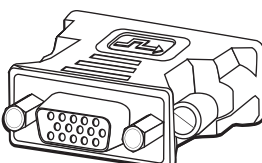
The number and type of cables required may vary by model. Some cables and adapters are included for select models only and may be sold separately.

Cable/Adapter	Name	Description
	HDMI cable	HDMI transmits an all-digital signal. It is the recommended choice for playback from a DVD or DVR. HDMI is capable of transmitting both uncompressed digital audio and digital video signals, because it has video, audio, and control signals.
	DVI cable	DVI transmits an all-digital video signal.
	VGA cable	VGA transmits an analog video signal.
	DVI-to-VGA adapter	Connects a DVI monitor to a VGA connector on the back of the computer, TV, or set-top box or connects a VGA monitor to a DVI connector on the back of the computer, TV, or set-top box.

Cable/Adapter (Continued)	Name	Description
	DVI-to-HDMI adapter	<p>Connects a DVI monitor to an HDMI connector on the back of the computer, TV, or set-top box or connects an HDMI monitor to a DVI connector on the back of the computer, TV, or set-top box.</p> <p>NOTE: If you use a DVI-to-HDMI adapter, you must connect the green audio cable to enable the speakers.</p>
	VGA-to-DVI-I cable	<p>Connects a DVI monitor to a VGA connector on the back of the computer, TV, or set-top box or connects a VGA monitor to a DVI connector on the back of the computer, TV, or set-top box.</p>



NOTE: When using a VGA or DVI signal, you must connect your audio separately because a VGA or DVI signal converts only video data, not audio data. A separate audio connection is not necessary when you use an HDMI signal, because an HDMI signal can convert both video and audio data.

High-Bandwidth Digital Content Protection (HDCP)

If your monitor supports HDCP, it can receive high-definition content. High-definition content is available in many sources, such as Blu-ray Disc devices or HDTV air or cable broadcasts. If you do not have an HDCP-enabled monitor, you may see a black screen or a lower resolution picture when playing high-definition protected content. Your computer graphic card and monitor must both support HDCP to display protected content.

Connecting the Audio Cable

Connect the built-in monitor speakers to the computer by using the audio cable, as shown in the following illustration.

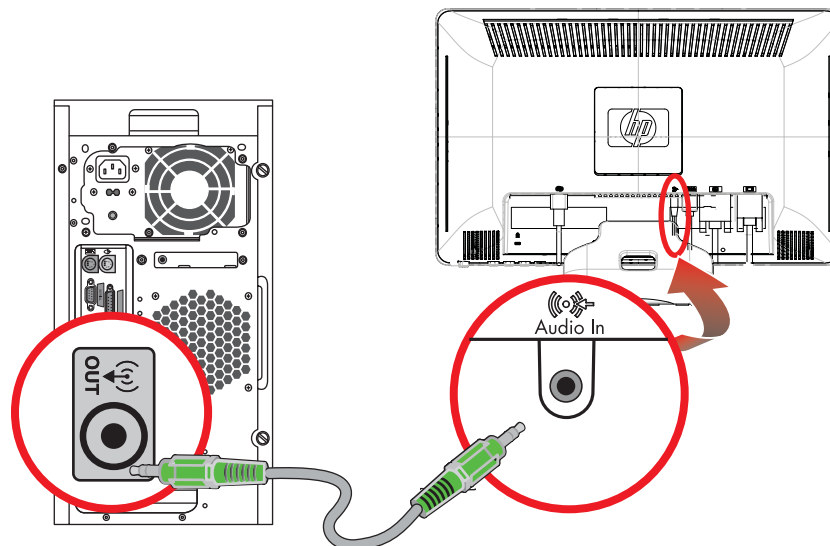

Connecting the audio cables—connector locations may vary

Connecting the Power Cable

1. Read the warning below.



WARNING: To reduce the risk of electric shock or damage to your equipment:

- Do not disable the power cord grounding plug. The grounding plug is an important safety feature. Plug the power cord into a grounded (earthed) electrical outlet.
- Be sure that the grounded power outlet you plug the power cord into is easily accessible to the operator and located as close to the equipment as possible. A power cord should be routed so that it is not likely to be walked on or pinched by items that are placed upon it or against it.
- Do not place anything on power cords or cables. Arrange them so that no one may accidentally step on or trip over them. Do not pull on a cord or cable.

See "Technical Specifications" (Appendix B) for additional information.

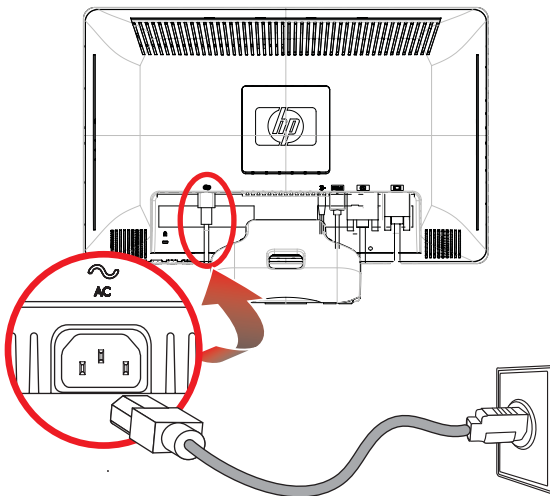

Connecting the power cable

2. Connect one end of the power cable to the monitor and the other end to a grounded electrical outlet.

Cable Management

The HP LCD monitors have cable management. Cables can be easily routed through the square hole in the base and are partially hidden when viewed from the front.

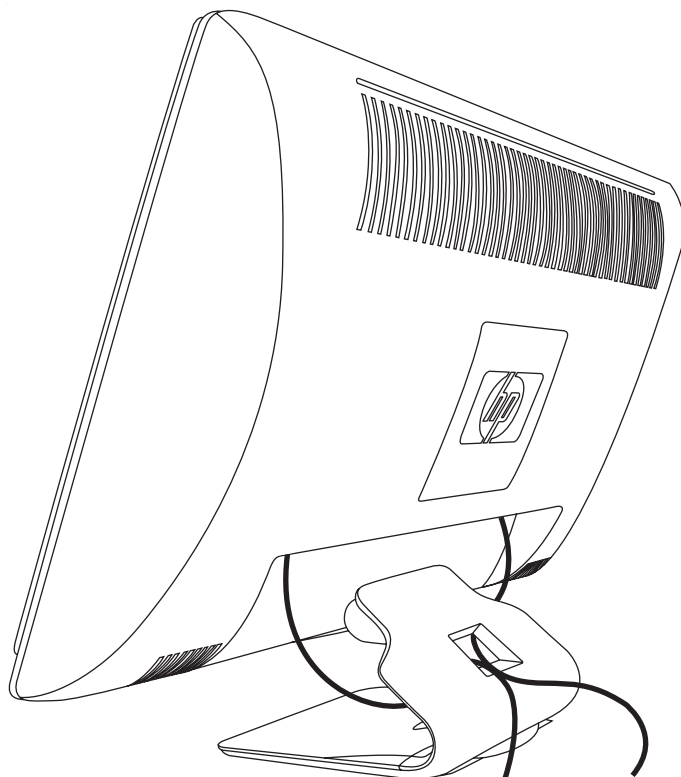

Adjusting the Tilt

For optimal viewing, adjust the screen tilt to your own preference, as follows:

1. Face the front of the monitor and hold the base so that you do not topple the monitor while changing the tilt.
2. Adjust the tilt by moving the top edge of the monitor either toward or away from you, without touching the screen.

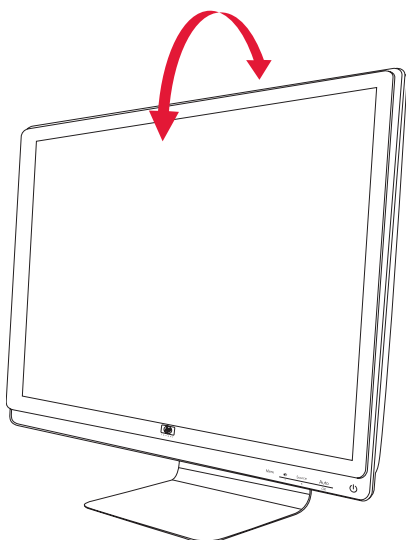

Adjusting the Swivel

The HP LCD monitor allows a usable range of motion with the swivel feature.

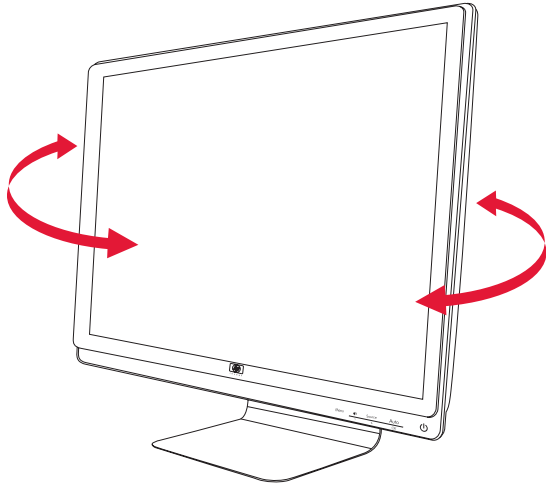

CAUTION: To avoid breakage or other damage, avoid applying pressure to the LCD screen while swiveling it or changing the tilt.

Keyboard Parking

If you need more space on your desktop, place the keyboard under the monitor when not in use.

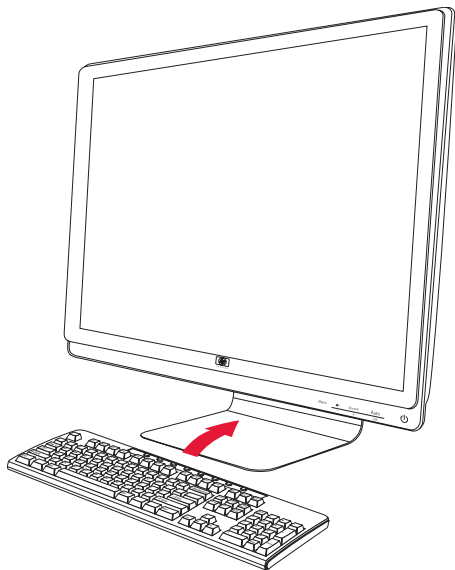

Operating the Monitor

CD Software and Utilities

The CD that is included with this monitor contains the drivers and software that you can install on your computer.

Installing Drivers

If you determine that you need to update the drivers, you can install the monitor-driver INF and ICM files from the CD, or download them from the Internet.

To install the monitor-driver software from the CD:

1. Insert the CD in your computer CD drive. The CD menu appears.
2. Select the language.
3. Click **Install Monitor Driver Software**.
4. Follow the onscreen instructions.
5. Restart the computer.
6. Ensure that the proper resolutions and refresh rates appear in the Display Control Panel settings. Refer to the Windows® operating system documentation for more information.



NOTE: You might need to install the digitally signed monitor drivers (INF or ICM files) manually from the CD, in case of an installation error. Refer to the "Driver Software Readme" file on the CD for instructions (in English only).

Downloading updated drivers from the Internet

To download the latest version of drivers and software files from the HP Support site:

1. Refer to: **<http://www.hp.com/support>**
2. Select your country/region.
3. Select **Download Drivers and Software**.
4. Enter the model number of your monitor. The software-download pages for your monitor are displayed.
5. Download and install the driver and software files by using the instructions in the download pages.
6. Ensure that your system meets the requirements.

Using the Auto-Adjustment Function

You can easily optimize the screen performance for the VGA input by using the Auto/Select button on the monitor and the auto-adjustment pattern software on the CD provided.

Do not use this procedure if your monitor is using a DVI or HDMI input. If your monitor is using the VGA input, this procedure can correct the following image-quality conditions:

- Fuzzy or unclear focus
- Ghosting, streaking, or shadowing effects
- Faint vertical bars
- Thin, horizontal scrolling lines
- Off-center picture



CAUTION: Burn-in image damage may occur on monitors that display the same static image on screen for a prolonged period of time (12 consecutive hours of non-use). To avoid burn-in image damage on your monitor screen, you should always activate a screen saver application or turn off the monitor when it is not in use for a prolonged period of time. Image retention is a condition that may occur on all LCD screens.

To use the auto-adjustment feature:

1. Allow the monitor to warm up for 20 minutes before adjusting.
2. Press the Auto/Select button on the monitor front panel.
 - You can also press the Menu button, and then select **Image Control**, followed by **Auto Adjustment** from the OSD menu. See "Adjusting Screen Quality" in this chapter.
 - If the result is not satisfactory, continue with the procedure.
3. Insert the CD in your computer CD drive. The CD menu displays.
4. Select the language.
5. Select **Open Auto-Adjustment Software**.
6. The setup test pattern displays.

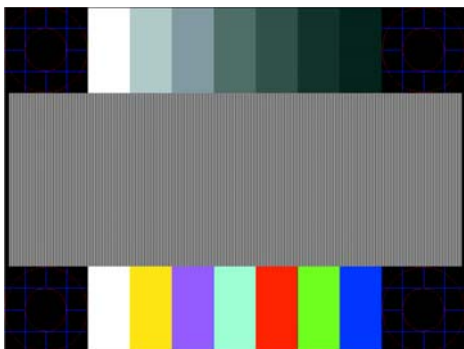



Auto-adjustment setup test pattern

7. Press the Auto/Select button on the monitor front panel to produce a stable, centered image.

Front-Panel Controls

Control buttons are located on the lower right front of the monitor:

Icon	Description
Power 	Turns the monitor on and to standby or sleep mode. NOTE: The power button is located on the top or front of the monitor depending on the model.
Menu	Opens, selects, or exits the OSD menu.
	Adjusts the volume level.
Source	Chooses video input source from the computer.
-	Navigates backward through the OSD menu and decreases adjustment levels.
+	Navigates forward through the OSD menu and increases adjustment levels.
Auto	Auto-adjusts the display to the ideal setting when the OSD is not active.
OK	Enters the selected option.

Using the On-screen Display (OSD)

An On-screen display is an image superimposed on a screen picture, commonly used by monitors, televisions, VCRs, and DVD players to display information such as volume, channel, and time.



NOTE: You can use My Display OSD software or the front-panel control buttons to adjust settings.

1. If the monitor is not already on, press the Power button to turn on the monitor.
2. To access the OSD menu, press the Menu button. The OSD Main Menu displays.
3. To navigate through the Main or Sub-Menu menu, press the + (Plus) button on the monitor's front panel to scroll up, or the - (Minus) button to scroll in reverse. Then press the Auto/Select button to select the highlighted function.

The menu moves to the top if you scroll down at the bottom of the selections. The menu moves to the bottom if you scroll up at the top of the selections.

4. To adjust the scale of a selected item, press the + or - button.
5. Select **Save and Return**.
If you don't want to save the setting, select **Cancel** from the Sub-Menu or **Exit** from the Main Menu.
6. Press the Menu button to exit the OSD.





















NOTE: When a menu is displayed, if the buttons are untouched for 30 seconds (factory default), adjustments and settings are saved and the menu closes.







OSD Menu Selections

The following table lists the On-Screen Display (OSD) menu selections and their functional descriptions. After changing an OSD menu item, and if the menu screen has these options, you may choose to:

- **Cancel** — to return to the previous menu level.
- **Save and Return** — to save all changes and return to the OSD Main Menu screen. This Save and Return option is active only if you change a menu item.
- **Reset** — to change back to the previous setting.

Icon	Main Menu Options	Submenu Options	Description
	Switch Video Input (select models only)		Switches the video input signal source when the monitor is connected to two active and valid video sources. Switching video input sources may take several seconds.
	Brightness		Adjusts the brightness level of the screen.
	Contrast		Adjusts the contrast level of the screen.
	Image Control		Adjusts the screen image. Also enables or disables the ambient light sensor (select models).
		Auto-Adjustment	Automatically adjusts the screen image (VGA Input only).
		Horizontal Position	Adjusts the horizontal position of the picture (VGA Input only).
		Vertical Position	Adjusts the vertical position of the picture (VGA Input only).
		Clock	Minimizes any vertical bars or strips visible on the screen background. Adjusting the Clock will also change the horizontal screen image (VGA Input only).
		Clock Phase	Adjusts the focus of the display. This adjustment allows you to remove any horizontal noise, and clear or sharpen the image of characters (VGA Input only).

Icon	Main Menu Options	Submenu Options	Description (Continued)
	Color		Selects the screen color. The factory default is 6500 K or Custom Color, depending on the model.
		9300 K	Changes to slightly blueish white.
		6500 K	Changes to slightly reddish white.
		Custom Color	Selects and adjusts your own color scales: <i>R</i> — Sets your own red color levels. <i>G</i> — Sets your own green color levels. <i>B</i> — Sets your own blue color levels.
		sRGB	Sets your screen colors to adapt to the color standards used in the image technology industry.
	Language		Selects the language in which the OSD menu is displayed. The factory default is English.
	Management		Selects the power-management features of the monitor.
		Volume	Adjusts the volume level.
	OSD Control		Adjusts the position of the OSD menu on the screen. <i>Horizontal OSD Position</i> — Changes the viewing position of the OSD menu to the left or right area of the screen. The factory default range is 50. 
			<i>Vertical OSD Position</i> — Changes the viewing position of the OSD menu to the top or bottom area of the screen. The factory default range is 50. 
			<i>OSD Transparency</i> — Adjust to view the background information through the OSD. 
			<i>OSD Timeout</i> — Sets the time in seconds that the OSD is visible after the last button is pressed. The factory default is 30 seconds. 
	Power Saver		Enables the power saving feature (see “Power-Saver Feature” in this chapter). Select: <i>On</i> <i>Off</i> The factory default is On.
	Mode Display		Displays the resolution, refresh rate, and frequency information on the screen each time the OSD Main Menu is accessed. Select: <i>On</i> <i>Off</i> The factory default is On or Off, depending on the model.
	Power-On Status Display		Displays the operating status of the monitor each time the monitor is powered on. Select the location to which to display the status: <i>Top</i> <i>Middle</i> <i>Bottom</i> <i>Off</i> The factory default is Top or Off, depending on the model.

Icon	Main Menu Options	Submenu Options	Description (Continued)
		DDC/CI Support	Allows the computer to control some OSD menu features such as brightness, contrast, and color temperature. Set to: <i>On</i> <i>Off</i> The factory default is <i>On</i> .
		Bezel Power LED	Turns the light (LED) in the power button <i>On</i> and <i>Off</i> . When set to <i>Off</i> , the light will remain off at all times.
		Sleep Timer	Provides the timer-adjustment menu options: <i>Set Current Time</i> — Sets the current time in hours and minutes. <i>Set Sleep Time</i> — Sets the time you want to place the monitor in sleep mode. <i>Set on Time</i> — Sets the time you want the monitor to wake up from sleep mode. <i>Timer</i> — Sets the Sleep Timer feature <i>On</i> or <i>Off</i> ; the default setting is <i>Off</i> . <i>Sleep Now</i> — Immediately sets the monitor to enter sleep mode.
		Default Video Input	Selects the default video input signal when the monitor is connected to two active and valid video sources. The default is DVI. You must restart the computer to have the change take effect.
	Information		Selects and displays important information about the monitor.
		Current Settings	Provides the current input video mode.
		Recommended Settings	Provides the recommended resolution mode and refresh rate for the monitor.
		Serial Number	Reports the serial number of the monitor. The serial number is needed if contacting HP technical support.
		Version	Reports the firmware version of the monitor.
		Backlight Hours	Reports the total hours of backlight operation.
		Service Support	For service support, go to: http://www.hp.com/support
	Factory Reset		Returns settings to factory defaults.

Selecting Video Input Connectors

The input connectors are:

- VGA connector (analog)
- DVI-D connector (digital)
- HDMI connector

The monitor automatically determines which inputs have valid video signals, and displays the image.

You can connect the VGA cable, the DVI-D cable, or both. If both cables are installed, the default input selection is DVI. The HDMI cable is in place of the DVI-D cable. The source of input can be switched using the **Switch Video Input** option in the OSD menu. Switching from a VGA to an HDMI input source may take several seconds.

Identifying Monitor Conditions

Special messages appear on the monitor screen for the following monitor conditions:

- **Input Signal Out of Range** — Indicates the monitor does not support the video card's input signal because its resolution or refresh rate are set higher than the monitor supports.
Change your video card settings to a lower resolution or refresh rate. Restart your computer for the new settings to take effect.
- **Monitor Going to Sleep** — Indicates the screen display is entering a sleep mode. The speakers are turned off in sleep mode.
- **Check Video Cable** — Indicates a video input cable is not properly connected to the computer or monitor.
- **OSD Lock-out** — The OSD can be enabled or disabled by pressing and holding the Menu button on the front panel for 10 seconds. If the OSD is locked, the warning message *OSD Lock-out* appears for 10 seconds.
If the OSD is locked, press and hold the Menu button for 10 seconds to unlock the OSD.
If the OSD is unlocked, press and hold the Menu button for 10 seconds to lock the OSD.
- **No Input Signal** — Indicates the monitor is not receiving a video signal from the computer on the monitor video input connector(s). Check to see if the computer or input signal source is off or in the power-saver mode.
- **Auto Adjustment in Progress** — Indicates the auto-adjustment function is active. See "Adjusting Screen Quality" in this chapter.

Adjusting Screen Quality

The auto-adjustment feature automatically fine-tunes the image quality for display size, position, clock, and phase each time a new video mode is displayed. For more precise adjustments of VGA input, run the Auto-Adjustment software on the CD. See “Using the Auto-Adjustment Function” in this chapter.

If you want additional image-quality improvement, use the Clock and Clock Phase controls of the monitor to fine-tune the image. See “Optimizing Analog Video” in this chapter.

Optimizing Analog Video

Some monitors contain advanced circuitry that allow the monitor to function as a standard analog monitor. Two controls in the OSD menu can be adjusted to improve analog image performance:

- **Clock** — Increase or decrease the value to minimize any vertical bars or stripes visible on the screen background.
- **Clock Phase** — Increase or decrease the value to minimize video distortion or video jitter.

Use these controls only when the auto-adjustment function does not provide a satisfactory monitor image in analog mode.

To obtain the best results:

1. Allow the monitor to warm up for 20 minutes before adjusting.
2. Display the adjustment-pattern application provided on the CD.
3. Access the OSD menu, then select **Image Control**.
4. Set the main Clock settings correctly first, because the Clock Phase settings depend on the main Clock setting.
When adjusting the Clock and Clock Phase values, if the monitor images become distorted, continue adjusting the values until the distortion disappears.

To restore the factory settings, access the OSD menu, select **Factory Reset**, and then select **Yes**.

Power-Saver Feature

When the monitor is in normal operating mode, the Power light is green and the monitor uses the normal watts of power. For power usage, refer to “Technical Specifications” (Appendix B).

The monitor also supports a power-saver mode that is controlled by the computer. When the monitor is in the reduced-power state, the monitor screen is blank, the backlight is off, and the Power light is amber. The monitor uses minimum power. When the monitor is “awakened,” a brief warm-up period occurs before the monitor returns to normal operating mode. The energy-saving reduced power state activates if the monitor does not detect either the horizontal sync signal or the vertical sync signal. The power-saver feature must be activated on your computer for this feature to work.

Refer to your computer documentation for instructions on setting energy-saver features (sometimes called power-management features).



NOTE: The energy-saver feature works only when the monitor is connected to computers that have energy-saver features.

Preparing the Monitor for Shipping

Keep the original packing box in a storage area. You may need it later if you move or ship your monitor.



WARNING: Before folding the monitor, turn off the monitor power, and disconnect all power, video, and audio cables. To disconnect power from the equipment, unplug the power cord from the power outlet by grasping the power plug firmly. Never pull on the cord.



CAUTION: The screen is fragile. Placing the monitor screen down on a flat, soft area prevents scratches, defacing, or breakage. Avoid applying pressure to the LCD screen; doing so can cause damage.

Preparing the Monitor for Shipping

1. Disconnect the power, video, and audio cables from the monitor.
2. Set the monitor base on a soft, protected surface.

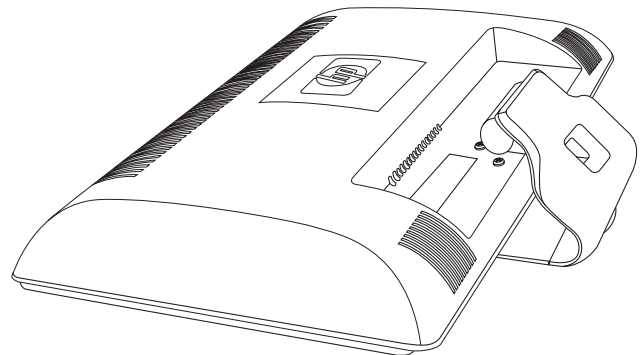
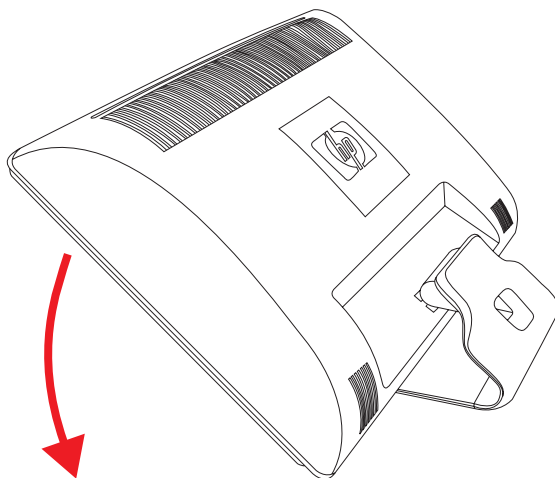



Preparing the monitor for shipping

3. Hold the base with one hand, where it attaches to the rear of the monitor, and push the monitor forward, folding the monitor flat onto the soft, protected surface.
4. Place the monitor and base in the original packing box.

Solving Common Problems

The following table lists possible problems, the possible cause of each problem, and the recommended solutions:

Problem	Solution
Power LED is not on.	Make sure the Power button is on, and the power cord is properly connected to a grounded power outlet and to the monitor. Select Management in the OSD menu, and then select Bezel Power LED . Check if the Bezel Power LED option is set to Off and, if so, set to On mode.
Screen is blank.	Connect the power cord. Turn on the power. Connect the video cable properly. See "Setting Up the Monitor" for more information. Press a key on the keyboard or move the mouse to turn off the screen-blanking utility.
Screen is black or displaying at a lower resolution while displaying high-definition (HD) content.	Check if your monitor and computer support HDCP. Refer to High-Content Digital Bandwidth Protection or http://www.hp.com/support
Image appears blurred, indistinct, or too dark.	Press the Auto/Select button on the monitor front panel. If this does not correct the image, press the Menu button to open the OSD menu, and adjust the brightness and contrast scales.
Image is not centered.	Press the Menu button to access the OSD menu. Select Image Control , and then select Horizontal Position or Vertical Position to adjust the position of the image.
"Check Video Cable" appears on screen.	Connect the monitor VGA signal cable to the VGA connector on the computer, or connect the DVI-D signal cable to the DVI connector on the computer. Be sure that the computer power is off while connecting the video cable.
"Input Signal Out of Range" appears on screen.	Restart your computer and enter Safe Mode. Change your settings to a supported setting (see the table in "Preset Video and High-Definition Modes" in Appendix B). Restart your computer, so that the new settings take effect.
Picture is fuzzy and has ghosting, shadowing problem.	Adjust the contrast and brightness controls. Make sure that you are not using an extension cable or switch box. We recommend plugging the monitor directly into the graphic card output connector on the back of your computer. For VGA input, the auto-adjustment feature might fix this problem.
Unable to set the monitor to the optimal resolution.	Make sure the graphics card supports the optimal resolution. Make sure the latest supported driver is installed for the graphics card. For HP and Compaq systems, you can download the latest graphics driver for your system from: www.hp.com/support . For other systems, refer to the Web site for your graphics card.
Using HDMI connection, unable to hear audio.	Ensure HDMI audio is selected as the main audio output in the operating system. To do so, click Windows Vista start button  , and then click Control Panel . Click Sound , and in the Playback tab, ensure the check mark is next to the HDMI output, and click OK .

Problem	Solution (Continued)
Unable to hear audio from built-in speakers.	<p>Do the following:</p> <ul style="list-style-type: none"> ■ Ensure the source signal is good by using headphones at the source. ■ Press the Menu button to access the OSD menu. Select Management, and then select Volume to adjust the volume. ■ Turn up the volume with the front panel volume button. ■ Ensure speaker volume is not muted or too low: Click the Windows Vista start button , Control Panel, and Hardware and Sound. Under Audio Devices and Sound, click Adjust system volume. Under Main Volume, move the slider up.
No Plug and Play.	<p>In order for the Plug and Play feature of the monitor to work, you need a computer and graphic card that are compatible with Plug and Play. Check with your computer manufacturer.</p> <p>Check the monitor's video cable, and make sure that none of the pins are bent.</p> <p>Make sure that the HP monitor drivers are installed. Refer to "Installing Drivers" in the Operating the Monitor chapter for more information. HP monitor drivers are also available at: http://www.hp.com/support</p>
Picture bounces, flickers, or wave pattern is present in the picture.	<p>Move electrical devices that may cause electrical interference as far away from the monitor as possible.</p> <p>Use the maximum refresh rate that your monitor is capable of at the resolution that you are using.</p>
Monitor is always in "Sleep Mode (Amber LED)."	<p>The computer power switch should be in the On position.</p> <p>The computer graphic card should be snugly seated in its slot.</p> <p>Check that the monitor video cable is properly connected to the computer.</p> <p>Inspect the monitor video cable, and make sure that none of the pins are bent.</p> <p>Check that your computer is operational: Press the Caps Lock key and observe the Caps Lock LED found on most keyboards. The LED should either turn on or off after hitting the Caps Lock key.</p>
USB 2.0 ports are not working.	<p>Make sure the USB hub cable is securely connected to the monitor and the computer.</p>

Getting Support from hp.com

Before you contact customer service, refer to HP Technical Support at: <http://www.hp.com/support>

Select your country/region, and then follow the links to the support page for your monitor.

Preparing to Call Technical Support

If you cannot solve a problem by using the troubleshooting tips in this section, you might have to call technical support. For technical support contact information, refer to the printed documentation included with the monitor. Have the following information available when you call:

- Monitor model number (located on label on back of monitor)
- Monitor serial number (located on label on back of monitor or in the OSD display in the Information menu)
- Purchase date on invoice
- Conditions under which the problem occurred
- Error messages received
- Hardware configuration
- Name and version of hardware and software you are using

Locating the Rating Label

The rating label on the monitor provides the product number and serial number. You may need these numbers when contacting HP about your monitor model.

The rating label is on the back of the monitor.

Technical Specifications

All specifications represent the typical specifications provided by HP's component manufacturers; actual performance may vary either higher or lower.

HP LCD Monitors

Face treatment: Glare polarizer with hard coating

Input Terminals:

- VGA connector (select models)
- DVI-D 24-pin D-type connector (select models)
- HDMI connector (select models)

Specifications

model 1859m

Display Type:	TFT LCD active matrix
Viewable Image Size:	18.5 in. (47.0 cm) diagonal
Tilt:	-5° to +25°
Maximum Weight (unpacked):	9.5 lb (4.3 Kg)
Dimensions (h x w x d):	14.0 x 18.0 x 7.2 in. (355 x 456 x 184 mm)
Maximum Graphics Resolution:	1366 x 768 @ 60 Hz analog mode
Optimum Graphics Resolution:	1366 x 768 @ 60 Hz analog mode
Text Mode:	720 x 400
Dot Pitch:	0.30 x 0.30 mm
Horizontal Frequency (analog mode):	24 to 83 kHz
Vertical Frequency (analog mode):	50 to 76 Hz
Environmental Requirements	
Temperature (independent of altitude)	
Operating Temperature:	41° to 104° F (5° to 40° C)
Non-operating Temperature:	-29° to 140° F (-20° to 60° C)
Relative Humidity (non-condensing):	
Operating Humidity:	20% to 80%
Non-operating Humidity:	5% to 95%
Power Source:	100-240V~, 50/60 Hz
Power Consumption:	40 watts maximum
Sleep Power Consumption:	<2 watts typical

Specifications (Continued)

model 2009m/v/f

Display Type:	TFT LCD active matrix
Viewable Image Size:	20 in. (50.8 cm) diagonal
Tilt:	-5° to +25°
Dimensions (h x w x d):	18.9 x 20.6 x 11.4 in. (481 x 523 x 289 mm)
Maximum Graphics Resolution:	1600 x 900 @ 60 Hz analog mode
Optimum Graphics Resolution:	1600 x 900 @ 60 Hz analog mode
Text Mode:	720 x 400
Dot Pitch:	0.2768 x 0.2768 mm
Horizontal Frequency (analog mode):	24 to 85 kHz
Vertical Frequency (analog mode):	46 to 76 Hz
Environmental Requirements	
Temperature (independent of altitude)	
Operating Temperature:	41° to 104° F (5° to 40° C)
Non-operating Temperature:	-29° to 140° F (-20° to 60° C)
Relative Humidity (non-condensing):	
Operating Humidity:	20% to 80%
Non-operating Humidity:	5% to 95%
Power Source:	100–240V [~] , 50/60 Hz
Power Consumption:	56 watts maximum
Sleep Power Consumption:	<2 watts typical

model 2159m/v

Display Type:	TFT LCD active matrix
Viewable Image Size:	21.53 in. (55.68 cm) diagonal
Tilt:	-5° to +25°
Maximum Weight (unpacked):	13.2 lb (6.0 kg)
Dimensions (h x w x d):	16.3 x 22.2 x 7.6 in. (415 x 563 x 194 mm)
Maximum Graphics Resolution:	1920 x 1080 @ 60 Hz analog mode
Optimum Graphics Resolution:	1920 x 1080 @ 60 Hz analog mode
Text Mode:	720 x 400
Dot Pitch:	0.2480 x 0.2480 mm
Horizontal Frequency (analog mode):	24 to 94 kHz
Vertical Frequency (analog mode):	50 to 76 Hz
Environmental Requirements	
Temperature (independent of altitude)	
Operating Temperature:	41° to 104° F (5° to 40° C)
Non-operating Temperature:	-29° to 140° F (-20° to 60° C)
Relative Humidity (non-condensing):	
Operating Humidity:	20% to 80%
Non-operating Humidity:	5% to 95%
Power Source:	100–240V [~] , 50/60 Hz
Power Consumption:	56 watts maximum
Sleep Power Consumption:	<2 watts typical

Specifications (Continued)**model 2309m/v**

Display Type:	TFT LCD active matrix
Viewable Image Size:	23.0 in. (58.42 cm) diagonal
Tilt:	-5° to +25°
Maximum Weight (unpacked):	21.6 lb (9.8 kg)
Dimensions (h x w x d)	16.2 x 22.6 x 7.9 in (412 x 573 x 200 mm)
Maximum Graphics Resolution:	1920 x 1080 @ 60 Hz analog mode
Optimum Graphics Resolution:	1920 x 1080 @ 60 Hz analog mode
Text Mode:	720 x 400
Dot Pitch:	0.265 x 0.265 mm
Horizontal Frequency (analog mode):	24 to 94 kHz
Vertical Frequency (analog mode):	50 to 76 Hz
Environmental Requirements	
Temperature (independent of altitude)	
Operating Temperature:	41° to 104° F (5° to 40° C)
Non-operating Temperature:	-29° to 140° F (-20° to 60° C)
Relative Humidity (non-condensing):	
Operating Humidity:	20% to 80%
Non-operating Humidity:	5% to 95%
Power Source:	100-240V~, 50/60 Hz
Power Consumption:	130 watts maximum
Sleep Power Consumption:	<2 watts typical

Preset Video and High-Definition Modes

The monitor automatically recognizes many preset video input modes that will appear properly sized and centered on the screen.

Factory Preset Video Input Modes, 1859m

Preset	Resolution	Horizontal Frequency (kHz)	Vertical Frequency (Hz)
1	640 x 480	31.47	59.94
2	720 x 400	31.47	70.09
3	800 x 600	37.88	60.32
4	1024 x 768	48.36	60.00
5	1280 x 960	60.00	60.00
6	1280 x 1024	63.98	60.02
7	1366 x 768	47.71	59.79

Factory Preset Video Input Modes, 2009m/v/f

Preset	Resolution	Horizontal Frequency (kHz)	Vertical Frequency (Hz)
1	640 x 480	31.47	59.94
2	720 x 400	31.47	70.09
3	800 x 600	37.88	60.32
4	1024 x 768	48.36	60.00
5	1280 x 960	60.00	60.00
6	1280 x 1024	63.98	60.02
7	1440 x 900	55.47	59.90
8	1600 x 900	55.54	59.98

Factory Preset Video Input Modes, 2159m/v and 2309m/v

Preset	Resolution	Horizontal Frequency (kHz)	Vertical Frequency (Hz)
1	640 x 480	31.47	59.94
2	720 x 400	31.47	70.09
3	800 x 600	37.88	60.32
4	1024 x 768	48.36	60.00
5	1280 x 960	60.00	60.00
6	1280 x 1024	63.98	60.02
7	1440 x 900	55.47	59.90
8	1600 x 1200	75.00	60.00
9	1680 x 1050	65.29	60.00
10	1920 x 1080	67.50	60.00

High Definition Video Formats				
Preset	Timing Name	Resolution	Horizontal Frequency (kHz)	Vertical Frequency (Hz)
1	480i	720 x 480	15.73	60
2	480p	720 x 480	31.47	60
3	720p60	1280 x 720	45.00	60
4	1080i60	1920 x 1080	33.75	60
5	576i	720 x 576	15.63	50
6	576p	720 x 576	31.25	50
7	720p60	1280 x 1920	37.50	50
8	1080i50	1920 x 1080	28.13	50
9	1080p60	1920 x 1080	67.50	60
10	1080p50	1920 x 1080	56.25	50

LCD Monitor Quality and Pixel Policy

The HP LCD Monitor uses high-precision technology, manufactured according to high standards, to help guarantee trouble-free performance. Nevertheless, the display may have cosmetic imperfections that appear as small bright or dark spots. This is common to all LCD displays used in products supplied by all vendors and is not specific to the HP LCD Monitor. These imperfections are caused by one or more defective pixels or subpixels.

- A pixel consists of one red, one green, and one blue subpixel.
- A defective whole pixel is always turned on (a bright spot on a dark background), or it is always off (a dark spot on a bright background). The first is the more visible of the two.
- A defective subpixel (dot defect) is less visible than a defective whole pixel, and is small and only visible on a specific background.

To locate defective pixels, the monitor should be viewed under normal operating conditions and in normal operating mode at a supported resolution and refresh rate, from a distance of approximately 16 inches (50 cm).

We expect that, over time, the industry will continue to improve its ability to produce displays with fewer cosmetic imperfections, and we will adjust guidelines as improvements are made.

For more information about your HP LCD Monitor, refer to the HP Web site at: <http://www.hp.com/support>

Power Cord Set Requirements

The monitor power supply is provided with Automatic Line Switching (ALS). This feature allows the monitor to operate on input voltages between 100–240V[~], 50/60 Hz, 1.5A.

The power cord set (flexible cord or wall plug) received with the monitor meets the requirements for use in the country/region where you purchased the equipment.

If you need to obtain a power cord for a different country/region, you should purchase a power cord that is approved for use in that country/region.

The power cord must be rated for the product and for the voltage and current marked on the product's electrical ratings label. The voltage and current rating of the cord should be greater than the voltage and current rating marked on the product. If you have questions about the type of power cord to use, contact your HP-authorized service provider.

A power cord should be routed so that it is not likely to be walked on or pinched by items placed upon it or against it. Particular attention should be paid to the plug, electrical outlet, and the point where the cord exits from the product.

Agency Regulatory Notices

Federal Communications Commission Notice

This equipment has been tested and found to comply with the limits for a Class B digital device, pursuant to Part 15 of the FCC Rules. These limits are designed to provide reasonable protection against harmful interference in a residential installation. This equipment generates, uses, and can radiate radio frequency energy and, if not installed and used in accordance with the instructions, may cause harmful interference to radio communications. However, there is no guarantee that interference will not occur in a particular installation. If this equipment does cause harmful interference to radio or television reception, which can be determined by turning the equipment off and on, the user is encouraged to try to correct the interference by one or more of the following measures:

- Reorient or relocate the receiving antenna.
- Increase the separation between the equipment and the receiver.
- Connect the equipment into an outlet on a circuit different from that to which the receiver is connected.
- Consult the dealer or an experienced radio or television technician for help.

Modifications

The FCC requires the user to be notified that any changes or modifications made to this device that are not expressly approved by Hewlett-Packard Company may void the user's authority to operate the equipment.

Cables

Connections to this device must be made with shielded cables with metallic RFI/EMI connector hoods to maintain compliance with FCC rules and regulations.

Declaration of Conformity for Products Marked with FCC Logo, United States Only

This device complies with Part 15 of the FCC Rules. Operation is subject to the following two conditions: (1) this device may not cause harmful interference, and (2) this device must accept any interference received, including interference that may cause undesired operation.

For questions regarding your product, contact:

Hewlett-Packard Company
P. O. Box 692000, Mail Stop 530113
Houston, Texas 77269-2000

Or

Call: 1-800-474-6836

For questions regarding this FCC declaration, contact:

Hewlett-Packard Company
P. O. Box 692000, Mail Stop 510101
Houston, Texas 77269-2000

Or

Call: 1-281-514-3333

To identify this product, refer to the part, series, or model number found on the product.

Materials Disposal

This HP product contains mercury in the fluorescent lamp in the display LCD that might require special handling at end-of-life:

Disposal of this material can be regulated because of environmental considerations. For disposal or recycling information, contact your local authorities or the Electronic Industries Alliance (EIA) (<http://www.eiae.org>).

Chemical Substances

HP is committed to providing our customers with information about the chemical substances in our products as needed to comply with legal requirements such as REACH (Regulation EC No 1907/2006 of the European Parliament and the Council). A chemical information report for this product can be found at:

<http://www.hp.com/go/reach>

Canadian Notice

This Class B digital apparatus meets all requirements of the Canadian Interference-Causing Equipment Regulations.

Avis Canadien

Cet appareil numérique de la classe B respecte toutes les exigences du Règlement sur le matériel brouilleur du Canada.

European Union Regulatory Notice

This product complies with the following EU Directives:

- Low Voltage Directive 2006/95/EC
- EMC Directive 2004/108/EC

Compliance with these directives implies conformity to applicable harmonized European standards (European Norms) which are listed on the EU Declaration of Conformity issued by Hewlett-Packard for this product or product family.

This compliance is indicated by one of the following conformity markings placed on the product:



This marking is valid for non-Telecom products and for EU harmonized Telecom products (for example, Bluetooth).



This marking is valid for EU non-harmonized Telecom products.
*Notified body number (used only if applicable—refer to the product label).

Hewlett-Packard GmbH, HQ-TRE, Herrenberger Straße 140, 71034 Böblingen, Germany

Disposal of Waste Equipment by Users in Private Households in the European Union

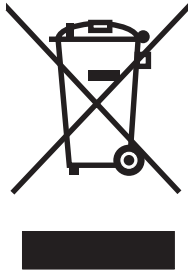

This symbol on the product or on its packaging indicates that this product must not be disposed of with your other household waste. Instead, it is your responsibility to dispose of your waste equipment by handing it over to a designated collection point for the recycling of waste electrical and electronic equipment. The separate collection and recycling of your waste equipment at the time of disposal will help to conserve natural resources and ensure that it is recycled in a manner that protects human health and the environment. For more information about where you can drop off your waste equipment for recycling, please contact your local city office, your household waste disposal service or the shop where you purchased the product.

Japanese Notice

この装置は、情報処理装置等電波障害自主規制協議会（VCCI）の基準に基づくクラスB情報技術装置です。この装置は、家庭環境で使用することを目的としていますが、この装置がラジオやテレビジョン受信機に近接して使用されると、受信障害を引き起こすことがあります。

取扱説明書に従って正しい取り扱いをして下さい。

Japanese Power Cord Notice

製品には、同梱された電源コードをお使い下さい。
同梱された電源コードは、他の製品では使用出来ません。

Japanese Material Content Declaration

A Japanese regulatory requirement, defined by Specification JIS-C-0950, 2005, mandates that manufacturers provide Material Content Declarations for certain categories of electronic products offered for sale after July 1, 2006. To view the JIS-C-0950 material declaration for this product, visit www.hp.com/go/jisc0950

2005年、日本における製品含有表示方法、JISC0950が公示されました。製造事業者は、2006年7月1日以降に販売される電気・電子機器の特定化学物質の含有に付きまして情報提供を義務付けられました。製品の部材表示に付きましては、www.hp.com/go/jisc0950を参照してください。

Korean Notice

B급 기기 (가정용 방송통신기기)	이 기기는 가정용(B급)으로 전자파적합등록을 한 기기로서 주로 가정에서 사용하는 것을 목적으로 하며, 모든 지역에서 사용할 수 있습니다.
-----------------------	------------------------------------------------------------------------------

EPA ENERGY STAR® Compliance

Products marked with the ENERGY STAR® logo on the packaging box qualify with the U.S. Environmental Protection Agency's ENERGY STAR® guidelines for energy efficiency.

Products with the ENERGY STAR® label are designed to use less energy, help you save money on utility bills, and help protect the environment.

ENERGY STAR® is a registered trademark owned by the U.S. government.



HP Recycling Program

HP offers product end-of-life return programs for HP and other manufacturers' hardware in several geographic areas.

The terms and availability of these programs vary by geography because of differences in regulatory requirements and local customer demand. For information on the HP recycling program, refer to the HP Web site at:

<http://www.hp.com/recycle>

The Table of Toxic and Hazardous Substances/Elements and their Content

as required by China's
Management Methods for Controlling Pollution by Electronic Information Products

Part Name	Toxic and Hazardous Substances and Elements					
	Lead (Pb)	Mercury (Hg)	Cadmium (Cd)	Hexavalent Chromium (Cr(VI))	Polybrominated biphenyls (PBB)	Polybrominated diphenyl ethers (PBDE)
Liquid Crystal Display Panel	X	X	O	O	O	O
Chassis/Other	X	O	O	O	O	O

O: Indicates that this toxic or hazardous substance contained in all of the homogeneous materials for this part is below the limit requirement in SJ/T11363-2006.

X: Indicates that this toxic or hazardous substance contained in at least one of the homogeneous materials used for this part is above the limit requirement in SJ/T11363-2006.

All parts named in this table with an "X" are in compliance with the European Union's RoHS Legislation – "Directive 2002/95/EC of the European Parliament and of the Council of 27 January 2003 on the restriction of the use of certain hazardous substances in electrical and electronic equipment".

Note: The referenced Environmental Protection Use Period Marking was determined according to normal operating use conditions of the product such as temperature and humidity.

产品中有毒有害物质或元素的名称及含量
根据中国《电子信息产品污染控制管理办法》

部件名称	有毒有害物质或元素					
	铅 (Pb)	汞 (Hg)	镉 (Cd)	六价铬 (Cr(VI))	多溴联苯 (PBB)	多溴二苯醚 (PBDE)
液晶显示屏	X	X	O	O	O	O
机箱/其他	X	O	O	O	O	O

O: 表示该有毒有害物质在该部件所有均质材料中的含量均在SJ/T11363-2006 标准规定的限量要求以下。

X: 表示该有毒有害物质至少在该部件的某一均质材料中的含量超出SJ/T11363-2006 标准规定的限量要求。

表中标有 "X" 的所有部件都符合欧盟 RoHS 法规

"欧洲议会和欧盟理事会 2003 年 1 月 27 日关于电子电器设备中限制使用某些有害物质的 2002/95/EC 号指令"

注: 环保使用期限的参考标识取决于产品正常工作的温度和湿度等条件

A

- adjustments
 - swivel 3–10
 - tilt 3–9
- audio and video cables and adaptors 3–6

B

- base
 - assembling 3–2

C

- cable management 3–9
- cleaning 2–2
- connecting
 - audio cable 3–7
 - HDMI 3–6
 - power cable 3–8
 - USB hub cable 3–7
 - VGA
 - DVI-D 3–5

F

- features 1–1
- front panel 4–3

H

- High-Bandwidth Digital Content Protection (HDCP) 3–7

I

- installing 3–1 – 3–10

K

- keyboard parking 3–10

M

- maintenance
 - cleaning 2–2
 - guidelines 2–2
- monitor conditions
 - Auto Adjustment in Progress 4–7
 - Check Video Cable 4–7
 - Input Signal Out of Range 4–7
 - Monitor Going to Sleep 4–7
 - No Input Signal 4–7
 - OSD Lock-out 4–7
- monitor operation 4–1 – 4–8
- monitor setup 3–1 – 3–10

P

- power cable
 - connecting 3–8
- power saver 4–8

R

- regulatory notices C–1 – C–5

S

- safety
 - guidelines 2–1
 - precautions 2–1
- setup 3–1 – 3–10
- shipping the monitor 5–1
- software and utilities CD 4–2 – 4–6
- specifications B–1 – B–6
- swivel adjustment 3–10

T

technical specifications B-1 – B-6
tilt adjustment 3-9
troubleshooting A-1 – A-3

U

unpacking 3-1

V

video and audio cables and adapters 3-6
video input connectors
 selecting 4-7

W

wall-mounting 3-2