

# **OLYMPUS<sup>®</sup>**

## DIGITAL CAMERA

# ***STYLUS TG-TRACKER***

## Instruction Manual

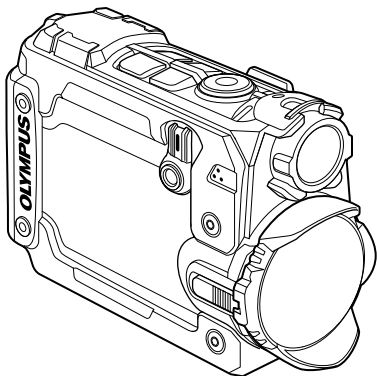

- Thank you for purchasing an Olympus digital camera. Before you start to use your new camera, please read these instructions carefully to enjoy optimum performance and a longer service life. Keep this manual in a safe place for future reference.
- We recommend that you take test shots to get accustomed to your camera before taking important photographs.
- The screen and camera illustrations shown in this manual were produced during the development stages and may differ from the actual product.

## Unpack the box contents

The following items are included with the camera.

If anything is missing or damaged, contact the dealer from whom you purchased the camera.



Digital camera



Strap



Lithium Ion Battery  
(LI-92B)

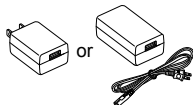

USB-AC adapter  
(F-5AC)



CD-ROM  
(Instruction  
manual/  
Computer  
software)



Lens protector  
(LP-T01)



Underwater lens protector  
(UP-T01)



USB cable  
(CB-USB10)



Joint screw  
(JS-T01)





Mount coupling  
(MC-T01)



Steady grip  
(SG-T01)

Other accessories not shown: Warranty card  
Contents may vary depending on purchase location.

- When using the camera underwater, be sure to attach the underwater lens protector (P. 60) and select [  ] (underwater wide-angle) or [  ] (underwater flipped wide-angle) for **[Field of View]** (P. 27, 31, 32).

## Attaching the camera strap

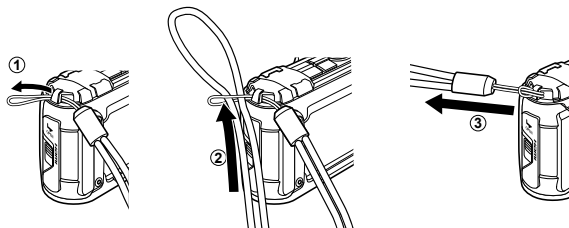

- Pull the strap tight so that it does not come loose.

# Names of parts

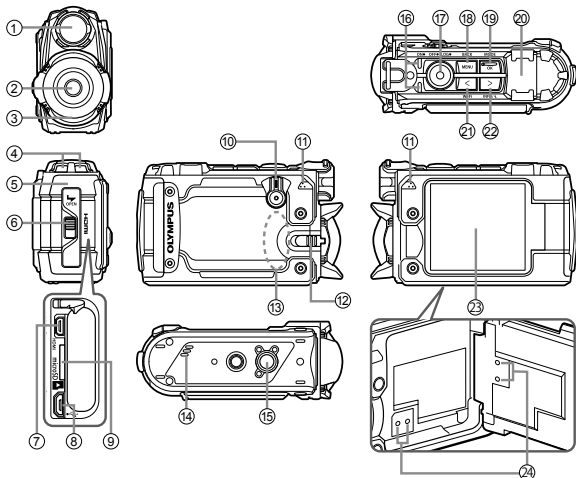

- |  |                                      |   |
|--|--------------------------------------|---|
| ① Headlamp                                       | ⑧ Micro-USB connector                | ⑱ <b>MENU</b> button  |
| ② Lens   | ⑨ Card slot                          | ⑲ <b>OK/MODE</b> button   |
| ③ Lens protector                                 | ⑩ Power switch ( <b>ON/OFF/LOG</b> ) | ⑳ GPS antenna   |
| ④ Strap eyelet                                   | ⑪ Stereo microphone                  | ㉑ <b>&lt;</b> (Left)/ <b>Wi-Fi</b> button                         |
| ⑤ Battery/card compartment/connector cover       | ⑫ Lens latch                         | ㉒ <b>&gt;</b> (Right)/ <b>INFO/</b><br><b>☛</b> (headlamp) button |
| ⑥ Battery/card compartment/connector cover latch | ⑬ Wi-Fi antenna                      | ㉓ Monitor   |
| ⑦ HDMI micro connector                           | ⑭ Speaker                            | ㉔ Pressure adjustment hole*                                       |
|  | ⑮ Tripod socket                      |   |
|  | ⑯ Indicator lamp                     |   |
|  | ⑰ <b>●</b> (record) button           |   |

\* Do not stick pointed objects like a pin into the hole.

- You can adjust the angle of the monitor.
- Strong vibrations may cause the monitor to open.

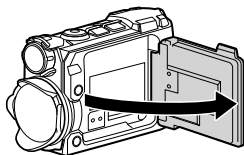

# Preparations for shooting

## Inserting and removing the battery and card

- 1 Keeping the battery/card compartment/connector cover latch pressed (①), open the battery/card compartment/connector cover (②, ③).

- When opening or closing the battery/card compartment/connector cover, be sure the power switch is in the **OFF** position.

Battery/card compartment/  
connector cover latch

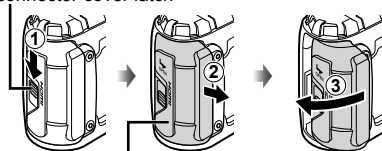

Battery/card compartment/  
connector cover

- 2 Insert the battery while sliding the battery lock knob in the direction of the arrow.

- Insert the battery as illustrated with the  mark toward the battery lock knob.

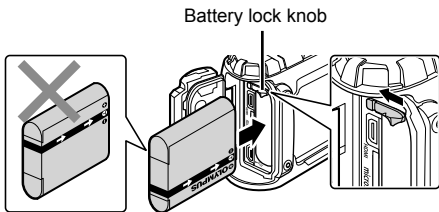

- If you insert the battery in the wrong direction, the camera is not turned on. Be sure to insert it in the correct direction.
- Slide the battery lock knob in the direction of the arrow to unlock, and then remove the battery.

### 3 Insert the card straight until it clicks into place.

- Do not touch the metallic parts of the card directly.
- Always use the specified cards with this camera. Do not insert other types of memory cards.

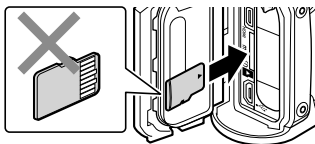

#### Cards compatible with this camera

microSD/microSDHC/microSDXC card (commercially available) (for compatibility card details, visit the Olympus website.)

- “Using the card” (P. 58)

#### To remove the card

- Before removing cards, rotate the power switch to **OFF** and confirm that the indicator lamp (amber) is off.
- Press the card in until it clicks and comes out slightly, then remove the card.

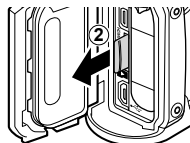
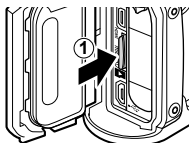

### 4 Follow Steps ①, ② and ③ to close the battery/card compartment/connector cover.

- When using the camera, be sure to close the battery/card compartment/connector cover.
- Securely latch the cover by sliding the battery/card compartment/connector cover latch until it completely covers the red label.

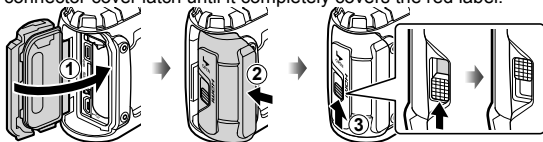

- Read “Important information about water and shock resistant features” (P. 62) before using the camera under water.

## Charging the battery

### 1 Check that the battery is in the camera, and connect the USB cable and USB-AC adapter.

- The battery is not fully charged at shipment. Before use, be sure to charge the battery until the indicator lamp turns off (up to 3.5 hours).

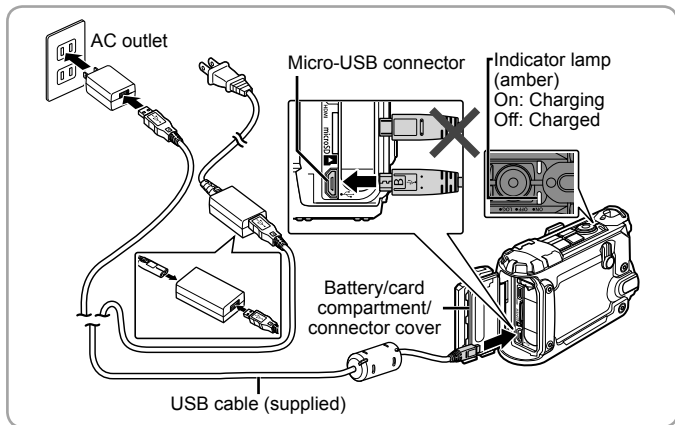

For charging the battery abroad, see “Using your charger and USB-AC adapter abroad” (P. 57).

- Never use any cable other than supplied or Olympus-designated USB cable. This may cause smoking or burning.
- The included F-5AC USB-AC adapter (hereafter referred to as USB-AC adapter) differs depending on the region where you purchased the camera. If you received a plug-in type USB-AC adapter, plug it directly into AC outlet.
- Be sure the power switch is in the **OFF** position during charging.

- For details on the battery, see “SAFETY PRECAUTIONS” (P. 65). For details on the USB-AC adapter, see “SAFETY PRECAUTIONS” (P. 65).
- If the indicator lamp does not light, reconnect the USB cable and USB-AC adapter to the camera.

### When to charge the batteries

Charge the battery when the error message shown on the right appears.

Flashes in red



Error message

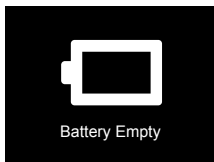

## Turning on the camera

The camera can only be used with a card inserted. Insert a card in the camera.

-  "Using the card" (P. 58)

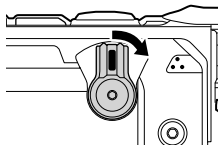

Rotate the power switch to **ON**.

- If the camera does not turn on when the power switch is in the **ON** position, check that the battery is in the correct orientation.  
 "Inserting and removing the battery and card" (P. 4)





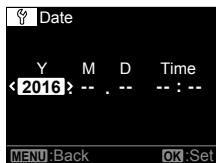

### Setting the clock

The camera will prompt you to set the clock when first turned on. Pictures can not be taken until the clock is set. For information on changing the time zone or resetting the clock, see **[Date]** (P. 37).

- 1 Use  or  to choose the year (**[Y]**) and press **OK** to select.



- 2 Using  or  and pressing **OK** as described in Step 1, set the month (**[M]**), day (**[D]**), and hours and minutes (**[Time]**).

- 3 Use  or  to select a time zone and press **OK**.









## Viewing the shooting mode

The monitor turns on when the power switch is rotated to **ON**. The shooting mode is shown by an icon in the top left corner of the display.







- : **VIDEO** (movie) mode .....(P. 10)
- : **PHOTO** (photography) mode .....(P. 12)
- : **TIME LAPSE**  
(time-lapse movie) mode .....(P. 14)
- : Displayed when **[On]** is selected for **[Loop]** in the **VIDEO** menu (P. 27).
- : Displayed when **[Continuous]** is selected for **[Drive]** in the **PHOTO** menu (P. 30).

## Shooting setting icons

Settings selected in the menus and elsewhere are shown by icons at the top of the shooting display.



- : **[+/-]** .....(P. 27, 30, 32)
- WB: [WB]** .....(P. 27, 30, 32)
- : **[Field of View]** .....(P. 27, 31, 32)
- IS: [IS]** .....(P. 29)
- : **[Timer]** .....(P. 31)
- : **[Wi-Fi]** .....(P. 36)

# Recording movies

## 1 Rotate the power switch to **ON**.

- While the power switch is in the **ON** position, the camera will log GPS and other sensor data, including log position and altitude. Log recording continues during shooting.

## 2 Check the mode.

**VIDEO** (movie) mode



## 3 Press the (record) button to start recording.

- Sound will be recorded with movie footage shot with **[30 fps]** or **[60 fps]** selected for **[fps]** in the **VIDEO** menu (P. 28). Be careful not to cover the microphone.
- When using a camera with a CMOS image sensor, moving objects may appear distorted due to the rolling shutter phenomenon. This is a physical phenomenon whereby distortion occurs in the filmed image when shooting a fast-moving subject or due to camera shaking.
- Chapter marking can be added by pressing **OK** during movie recording. Movies can have up to 200 chapters.



Recording time

## 4 Press the button again to stop recording.

- If the power switch is rotated to **OFF** while the current log is stored in the temporary buffer, a message will be displayed in the monitor. If 10 seconds pass or you press **OK** while the message is displayed, log recording will end and the log will be saved to the card. If you rotate the power switch to **LOG** or **ON** before the 10 seconds are up, log recording will continue and the log will not be saved to the card.
- To disable log recording when the power switch is in the **ON** position, select **[Off]** for **[LOG Setting]** in the **SETUP** menu (P. 34).
- Do not set the clock during log recording (P. 37). The log will not display correctly in OI.Track.

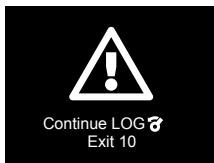



# Taking photographs

## 1 Rotate the power switch to **ON**.

- While the power switch is in the **ON** position, the camera will log GPS and other sensor data, including position and altitude. Log recording continues during shooting, and the log is saved to the card when the power switch is rotated to **OFF**.

## 2 Press the **MODE** button to view the home display.

- Use  or  to highlight items.

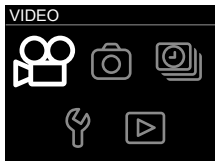

Home display

## 3 Highlight **PHOTO** and press **OK**.

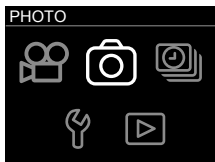

## 4 Press the (record) button to take photos.

- If **[On]** is selected for **[LOG Setting]** in the **SETUP** menu (P. 34), photos will include tags giving the position, altitude, and other location data.

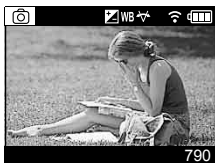

- Distortion may appear in photos of moving objects.
- Large movements or flicker from fluorescent lights or other sources may cause the picture to break up.
- To disable log recording when the power switch is in the **ON** position, select **[Off]** for **[LOG Setting]** in the **SETUP** menu (P. 34).
- Do not set the clock during log recording (P. 37). The log will not display correctly in OI.Track.



# Filming time-lapse movies

The camera shoots photos at a pre-selected interval and joins them together in a movie. Sound is not recorded.

## 1 Rotate the power switch to **ON**.

- While the power switch is in the **ON** position, the camera will log GPS and other sensor data, including position and altitude. Log recording continues during shooting, and the log is saved to the card when the power switch is rotated to **OFF**.

## 2 Press the **MODE** button to view the home display.

- Use  or  to highlight items.

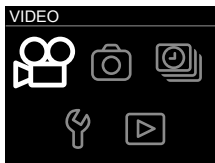

Home display

## 3 Highlight **TIME LAPSE** and press OK.

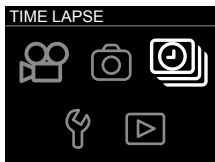

## 4 Press the (record) button to start recording.

- Photos are taken one at a time at the interval selected using the **[Interval]** option (P. 33).











## 5 Press the button again to stop recording.

- The photos are joined together in a movie.

- If the battery runs low during recording, shooting will end and the camera will begin to record the movie to the card. Use a fully-charged battery. A movie will be created from the photos shot before shooting was suspended.
- Time-lapse movies can be up to 29 minutes long (or 4 GB in size).
- To disable log recording when the power switch is in the **ON** position, select **[Off]** for **[LOG Setting]** in the **SETUP** menu (P. 34).
- Do not set the clock during log recording (P. 37). The log will not display correctly in OI.Track.

# Viewing and deleting pictures

## Viewing movies

- 1 Rotate the power switch to **ON**.
- 2 Press the **MODE** button to view the home display.
  - Use  or  to highlight items.
- 3 Highlight  **PLAY** and press **OK**.
  - Pictures will be displayed in a thumbnail list.
  - Use  and  to highlight pictures.
  - Photos are indicated by a  icon.
- 4 Highlight the desired movie and press **OK** to view it full frame.
  - Press  to return to thumbnail playback.
- 5 Press **OK** again to begin playback.
  - Press **OK** to pause playback. To resume, press **OK** again.
  - Press the  (record) button to exit to the shooting display.

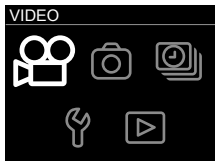

Home display





## ■ During playback

<b>Pausing playback</b>	Press the <b>OK</b> button to pause playback.
<b>Fast forward</b>	Press <b>[&gt;]</b> once for 2× speed, twice for 15× speed.
<b>Rewind</b>	Press <b>[&lt;]</b> once for 2× speed, twice for 15× speed.

## ■ Operations while playback is paused

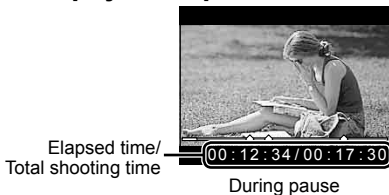



<b>Cueing</b>	Use <b>[&lt;]</b> to return to the previous chapter or <b>[&gt;]</b> to skip to the next chapter. If there is no next chapter, the final frame will be displayed.
<b>Fast forward</b>	Press and hold <b>[&gt;]</b> to fast forward.
<b>Rewind</b>	Press and hold <b>[&lt;]</b> to rewind.
<b>Resuming playback</b>	Press the <b>OK</b> button to resume playback.

## ■ To stop movie playback

Press the **MENU** button.



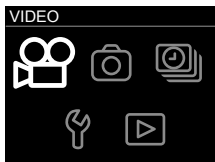

- To play back movies on the computer, the supplied PC software is recommended. For the first use of the PC software, connect the camera to the computer, then launch the software.

## Viewing photographs



- 1 Rotate the power switch to **ON**.
- 2 Press the **MODE** button to view the home display.
  - Use  or  to highlight items.



Home display

- 3 Highlight  **PLAY** and press **OK**.
  - Pictures will be displayed in a thumbnail list.
  - Use  and  to highlight pictures.
  - Photos are indicated by a  icon.



- 4 Highlight the desired photo and press **OK** to view it full frame.
  - Press  to return to thumbnail playback.
  - Press the  (record) button to exit to the shooting display.



## Deleting pictures

**1** In the thumbnail list, highlight the picture you want to delete and press the **MENU** button.

- The playback menu will be displayed.



- You can also press the **MENU** button to display the playback menu in full-frame playback.



**2** Use **<** or **>** to highlight **[🗑 Erase]** and press **OK**.



**3** Highlight **[YES]** and press **OK**.

- To exit to the playback menu without deleting the picture, highlight **[NO]** and press **OK**.
- All pictures can be erased at a time (P. 37).



# Recording and using logs (LOG mode)

While the power switch is in the **LOG** position, the camera will log GPS and other sensor data (P. 22). Logs can be downloaded for use with the OLYMPUS Image Track (OI.Track) smartphone app.

## Recording and saving logs

Rotate the power switch to **LOG**.

- Log recording will start. The indicator lamp lights green during recording.
- To switch to the shooting display, rotate the power switch to **ON**.
- Log recording does not function if no card inserted.
- The camera automatically terminates log data acquisition and recording when the battery runs low. Rotate the power switch to **OFF** to save the log.
- In LOG mode, the camera draws on the battery continuously to acquire location data.
- An altitude (water depth) track can be viewed in the altitude (water depth) log display (P. 23). The camera can not display other track logs.
- No additional log data can be recorded after temporary memory buffer used to store log data fills. If the buffer fills, rotate the power switch to **OFF** to save the log data to the card.

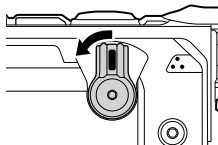

### Saving logs

The current log is saved to the card when the power switch is rotated to **OFF**.

- A message is displayed in the monitor when the power switch is rotated to or through the **OFF** position. If 10 seconds pass or you press **OK** while the message is displayed, log recording will end and the log will be saved to the card. If you rotate the power switch to **LOG** or **ON** before the 10 seconds are up, log recording will continue and the log will not be saved to the card.
- **[Busy...]** is displayed in the monitor while the log is saved. Do not remove the card while this message is displayed. Removing the card before the operation is complete could result in loss of the log file or in damage to the camera or the card.

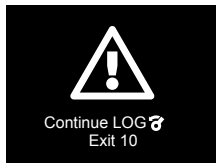

- Each card can store up to 199 log files. An error message will be displayed when the log file count approaches this number (P. 52). Should this occur, insert another card or delete log files after copying them to a computer.
- Log files are recorded to the “GPSLOG” and “SNSLOG” folders on the card (P. 58).

## Using buffered and saved logs

To access logs stored in the camera’s temporary buffer or saved to the card, launch the OLYMPUS Image Track (OI.Track) smartphone app and connect to the smartphone using the camera wireless LAN function (P. 39).

### Things you can do with the specified app, OLYMPUS Image Track (OI.Track)

- Viewing the current log and photos  
The current log and photos can be viewed on the smartphone.
- Downloading the current log and photos  
The current log and photos can be copied to and browsed on the smartphone.
- Viewing tracks  
Logs stored on the card can be copied to the smartphone and viewed as tracks. To view the logs on the card, select **[Off]** for **[LOG Setting]** and turn the camera off and then on again.
- Linking photos to a log  
Photos taken while log recording was enabled can be linked to the log for viewing or file management.
- OI.Track can be used to update GPS assist data (P. 43).

For details, visit the address below:

<http://app.olympus-imaging.com/oitrack/>

# Location data/headlamp

## Viewing location data

The monitor shows location data, an artificial horizon, and altitude (depth).

- The accuracy of the data displayed varies with weather conditions and the like. Use as a rough guide only.

### 1 Press **INFO**.

- Location data will be displayed.
- Location data will not be displayed during playback or if the camera has turned off automatically (P. 35).

### 2 Use to cycle through the information displayed.

- Press  to cycle through the location data, artificial horizon, altitude (depth), and "location data off" displays.



Location data



Artificial horizon and altitude (depth)

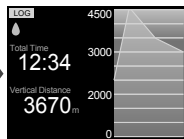

Altitude (depth) log

## Location data displays

### ■ Location data

No.	Name
1	Time
2	Log recording in progress
3	Underwater indicator
4	Direction information
5	Temperature (water temperature)
6	GPS icon
7	Latitude
8	Longitude

## ■ Artificial horizon and altitude (depth)

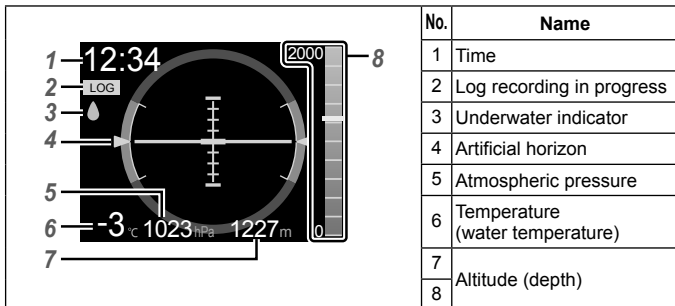

## ■ Altitude (depth) log

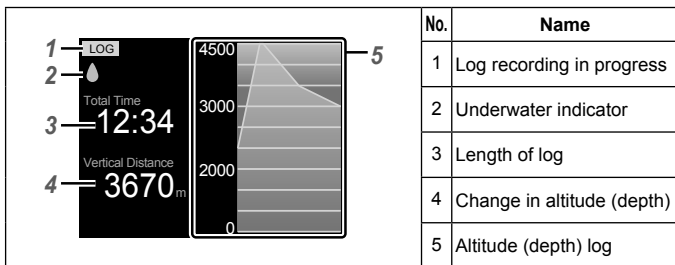

## Latitude and longitude

- If the GPS icon blinks or is not displayed, the camera is unable to determine the current position.
- The latitude and longitude shown when the GPS icon is not displayed are not those for the current position but those most recently measured in the last 120 minutes.
- The latitude and longitude will not be displayed if they have not been updated for more than 120 minutes.

## **GPS and other data displays**

These displays are not intended for applications that require a high degree of precision, and the accuracy of the data (latitude and longitude, heading, depth, temperature, and the like) they provide is not guaranteed. The accuracy of these displays may be also affected by factors not under the control of the manufacturer.

## The headlamp

Press the  (headlamp) button until the headlamp lights. The headlamp will light even if the power switch is in the **OFF** or **LOG** position.

- The headlamp lights for about 60 seconds.
- To turn the headlamp off, press and hold the  (headlamp) button.
- The headlamp will turn off automatically if:
  - you use the power switch,
  - the menus are displayed,
  - a USB or HDMI cable is connected or disconnected, or
  - the camera connects to a Wi-Fi network.

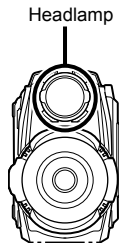



# Camera menus

## Using the menus

### The VIDEO, PHOTO, TIME LAPSE, and PLAY menus

Press the **MENU** button during shooting or playback to display the menu for the current mode.

#### VIDEO (movie) menu (P. 27)

Submenu 1	
Loop +/-* <sup>1</sup>	fps
WB* <sup>1</sup>	IS
Field of View* <sup>1</sup>	G Chapter
Resolution* <sup>1</sup>	Exit

#### PHOTO (photography) menu (P. 30)

Submenu 1	
Drive +/-* <sup>1</sup>	Timer
WB* <sup>1</sup>	Exit
Field of View* <sup>1</sup>	
Resolution* <sup>1</sup>	

#### TIME LAPSE

(time-lapse movie) menu (P. 32)

Submenu 1	
+/-* <sup>1</sup>	Interval
WB* <sup>1</sup>	Exit
Field of View* <sup>1</sup>	
Resolution* <sup>1</sup>	

#### PLAY (playback) menu (P. 34)

Submenu 1	
Erase	
HDMI Control	
Exit	

\*1 Can be set separately for each mode.

## SETUP menu

Highlight [**⏏** SETUP] in the home display and press **OK** to display the **SETUP** menu.

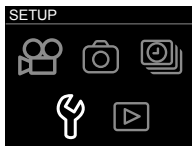



Home display

#### **⏏** SETUP menu (P. 34)

Submenu 1			
Quick Capture	Autopw Off	Wi-Fi	Exit
LOG Setting	Video Light	Date	
Monitor	Beep	Card	
Monitor Off	Manometer	Reset	

## Submenus

- Submenus can be selected using  or . Press **OK** to select the highlighted item and proceed to the second or third submenu as applicable.
- Highlight an item in the second or third submenu and press **OK** to select the highlighted item and return to the main menu.
- Press the **MENU** button to go back to the previous display.



Submenu 1

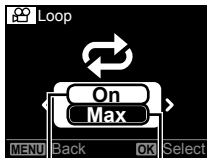

Submenu 2 Submenu 3

- Pressing **OK** when options such as the **[Erase]** (P. 34) item in the **PLAY** menu or the **[Card] > [All Erase]** (P. 37) item in the **SETUP** menu are selected will display a confirmation dialog.

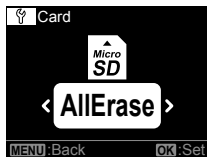

- To exit the menus and return to the shooting display, press the **MENU** button in the first submenu or highlight **[Exit]** and press **OK**.

## VIDEO (Movie) Menu

- The default settings of the function are highlighted in .





### **Repeatedly record fixed-length movies** [Loop]

Submenu 2	Submenu 3	Application
Off	—	Recording is not repeated after shooting ends.
On	Max/3min/ 5min/10min	Recording ends after the selected time and the camera immediately begins recording a new movie. If [Max] is selected, each movie will be 29 minutes long or 4 GB in size.





### **Adjusting overall brightness (exposure compensation)** [+/-]

Submenu 2	Application
-2.0 to +2.0	Set a larger negative (-) value to adjust darker, or a larger positive (+) value to adjust brighter.

### **Adjusting colors according to lighting conditions WB** [WB]

Submenu 2	Application
Auto	The camera automatically adjusts the white balance.  (underwater auto) is selected automatically when the camera is under water.
 (Underwater auto)	Suitable for underwater shooting.
 (Sunny)	Suitable for shooting outdoors under a clear sky.
 (Cloudy)	Suitable for shooting outdoors under a cloudy sky.

### **Choosing a field of view** [Field of View]

Submenu 2	Application
 (Wide)	Choose this option in most situations.
 (Underwater wide)	Use for underwater use. The field of view is optimized for the underwater lens protector.
 (Flipped wide-angle)	The image is rotated 180°. Sound is also recorded with left and right reversed.
 (Underwater flipped wide-angle)	

- Be sure to use the underwater lens protector when using the camera under water (P. 60).

### Choosing a size [Resolution]

Submenu 2	Application
4K/FHD/HD/480	Choose the frame size.

- Some computers may not be able to display movies shot at **[4K]**.
- “Using the card” (P. 58)
- “Maximum movie length/number of photographs” (P. 59)

### Choosing a frame rate [fps]

Submenu 2	Application
240fps/120fps/60fps/30fps	Choose the frame rate. Sound is not recorded with movies shot at <b>[120 fps]</b> or <b>[240 fps]</b> .

### Frame size and frame rate

The frame rates available at different frame sizes (measured in pixels) are shown below.

Frame size		Frame rate (fps)			
		240fps	120fps	60fps	30fps
<b>4K</b>	3840×2160	—	—	—	✓
<b>FHD</b>	1920×1080	—	—	✓	✓
<b>HD</b>	1280×720	✓	✓	✓	✓
<b>480</b>	854×480	✓	✓	✓	✓

### ***Reducing camera blur IS [IS]***

Submenu 2	Application
Off	Disable image stabilization.
On	Enable image stabilization. The field of view is reduced. This option does not take effect when [120 fps] or [240 fps] is selected for [fps].

- Images may not be stabilized if camera shake is too severe.

### ***Using vibration to start new chapters [G Chapter]***

Submenu 2	Application
OFF	Automatic chapter marking disabled.
High	The camera will start a new chapter if the camera detects an acceleration over about 7.0 G during movie recording.
Low	The camera will start a new chapter if the camera detects an acceleration over about 4.0 G during movie recording.



## PHOTO (Photography) Menu

- The default settings of the function are highlighted in .

### **Switching between single-frame and continuous recording** [Drive]

Submenu 2	Submenu 3	Application
Single	—	The camera takes only one photo at a time.
Continuous	0.5sec/ 1sec/2sec/ 5sec/10sec/ 30sec/60sec	The camera takes photos at the selected interval. Depending on shooting conditions, the interval may be longer than the selected value. The camera turns off automatically after 20,000 shots.





### **Continuous photography ([Continuous])**

- ① Press the  (record) button.
  - The camera automatically takes photos at the selected interval.
- ② Press the  button again to end shooting.



### **Adjusting overall brightness (exposure compensation) [+/-]**

Submenu 2	Application
-2.0 to +2.0	Set a larger negative (-) value to adjust darker, or a larger positive (+) value to adjust brighter.

### **Adjusting colors according to lighting conditions WB [WB]**

Submenu 2	Application
Auto	The camera automatically adjusts the white balance.  (underwater auto) is selected automatically when the camera is under water.
 (Underwater auto)	Suitable for underwater shooting.
 (Sunny)	Suitable for shooting outdoors under a clear sky.
 (Cloudy)	Suitable for shooting outdoors under a cloudy sky.

## Choosing a field of view [Field of View]

Submenu 2	Application
 (Wide)	Choose this option in most situations.
 (Underwater wide)	Use for underwater use. The field of view is optimized for the underwater lens protector.

- Be sure to use the underwater lens protector when using the camera under water (P. 60).

## Choosing a size [Resolution]

Submenu 2	Application
8.0MP/2.1MP/0.9MP/0.4MP	Choose the image size.

- “Maximum movie length/number of photographs” (P. 59)

### Image size

The actual size in pixels for each image size option is shown below.

<b>8.0MP</b>	3840×2160
<b>2.1MP</b>	1920×1080
<b>0.9MP</b>	1280×720
<b>0.4MP</b>	854×480

## Choosing the delay between your pressing the (record) button and the start of shooting [Timer]

Submenu 2	Application
Off	Self-timer off.
2sec	The headlamp flashes for about 2 seconds before shooting starts.
12sec	The headlamp lights for about 10 seconds and then flashes for about 2 seconds before shooting starts.

- To stop the timer without taking a picture, press the **MENU** button.





## TIME LAPSE (Time-Lapse Movie) Menu

- The default settings of the function are highlighted in .





### **Adjusting overall brightness (exposure compensation) [+/-]**

Submenu 2	Application
-2.0 to +2.0	Set a larger negative (-) value to adjust darker, or a larger positive (+) value to adjust brighter.

### **Adjusting colors according to lighting conditions WB [WB]**

Submenu 2	Application
Auto	The camera automatically adjusts the white balance.  (underwater auto) is selected automatically when the camera is under water.
 (Underwater auto)	Suitable for underwater shooting.
 (Sunny)	Suitable for shooting outdoors under a clear sky.
 (Cloudy)	Suitable for shooting outdoors under a cloudy sky.

### **Choosing a field of view [Field of View]**

Submenu 2	Application
 (Wide)	Choose this option in most situations.
 (Underwater wide)	Use for underwater use. The field of view is optimized for the underwater lens protector.
 (Flipped wide-angle)	The image is rotated 180°. Sound is also recorded with left and right reversed.
 (Underwater flipped wide-angle)	

- Be sure to use the underwater lens protector when using the camera under water (P. 60).



## ***Choosing a size [Resolution]***

Submenu 2	Application
4K/FHD/HD/480	Choose the frame size.

- Some computers may not be able to display movies shot at **[4K]**.
- “Using the card” (P. 58)
- “Maximum movie length/number of photographs” (P. 59)

### **Frame size**

The actual size in pixels for each frame size option is shown below.

<b>4K</b>	3840×2160
<b>FHD</b>	1920×1080
<b>HD</b>	1280×720
<b>480</b>	854×480

## ***Choosing an interval [Interval]***

Submenu 2	Application
0.5sec/1sec/2sec/5sec/ 10sec/30sec/60sec/	Choose the interval between shots. Depending on shooting conditions, the interval may be longer than the selected value.

## **PLAY (Playback) Menu**

- The default settings of the function are highlighted in .

### ***Deleting pictures [Erase]***

- See “Deleting pictures” (P. 19).

### ***Using a TV remote [HDMI Control]***

- When connected to a TV that supports HDMI control, the camera can be operated using the TV remote control.

Submenu 2	Application
Off	Operate with the camera.
On	Operate with the TV remote control.

- “Using the TV remote control” (P. 45)

## **ƒ SETUP Menu**

- The default settings of the function are highlighted in .

### ***Beginning recording at startup [Quick Capture]***

Submenu 2	Application
Off	Movie recording does not start automatically when the camera is turned on.
On	Movie recording starts automatically when the camera is turned on.

- This option takes effect only when **VIDEO** (movie) is selected for shooting mode.

### ***Recording location, altitude, and other data to a temporary memory buffer [LOG Setting]***

Submenu 2	Application
Off	Log recording and location data embedding disabled.
On	Location data, altitude, and other data are recorded to a temporary memory buffer and embedded in new photographs.

- “Using GPS function” (P. 42).

### *Adjusting the brightness of the monitor [Monitor]*

Submenu 2	Application
Bright	The display in the monitor is brighter than normal.
Normal	Normal brightness.

### *Choosing how long the monitor remains on [Monitor Off]*

Submenu 2	Application
Hold	The monitor does not turn off automatically.
1sec/5sec/10sec	Select the delay between the start of shooting and the monitor turning off automatically.

### *Choosing how long the camera remains on [Autopw Off]*

Submenu 2	Application
Hold	The camera does not turn off automatically.
1min/5min/10min	<p>If no operations are performed, the camera will turn off automatically after the selected time unless movie recording, continuous shooting, time-lapse movie recording, or charging is in progress or the camera is connected via a USB or to a smartphone.</p> <p>To turn the camera back on, rotate the power switch to <b>OFF</b> and then back to <b>ON</b>.</p> <p>This option does take effect when the power switch is in the <b>LOG</b> position.</p> <p>If the power switch is in the <b>ON</b> position and <b>[LOG Setting]</b> is <b>[On]</b>, the camera will continue to acquire and log its position to the temporary buffer after it has turned off.</p>

### *Auto illumination for movies [Video Light]*

Submenu 2	Application
Off	The headlamp does not light automatically.
On	When movie recording starts, the headlamp will automatically turn on at a level suited to movie recording, and remain on until shooting ends. Pressing and holding the <b>INFO</b> button during recording will cause the brightness of the lamp to change for 60 seconds.

## f SETUP Menu

### Adjusting beep volume [Beep]

Submenu 2	Application
Off/70%/100%	Adjust volume.

### Configuring the pressure sensor [Manometer]

- Configure the altitude (depth) display (P. 23).

#### To adjust the altitude/water depth display

- ① Use **<** or **>** to display the altitude (depth) for the current location and press **OK** to select.
  - The depth display can only be configured under water.

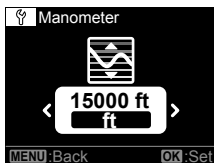

- ② Use **<** or **>** to highlight **[m]** or **[ft]** and press **OK** to select.

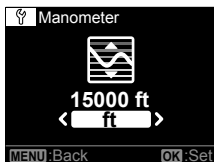

- ③ Press **⊙** (record) to return to the shooting display.

### Setting Wi-Fi [Wi-Fi]

Submenu 2	Application
Wi-Fi Start/ Stop	Initiate or terminate a Wi-Fi connection to a smartphone. ☞ "Connecting the camera to a smartphone" (P. 38)
Password	Regenerate a password. ☞ "Changing password" (P. 41)

### **Setting the clock [Date]**

- ① Use **<** or **>** to choose the year (**[Y]**) and press **OK** to select.
  - ② Using **<** or **>** and pressing **OK** as described in Step 1, set the month (**[M]**), day (**[D]**), and hours and minutes (**[Time]**).
  - ③ Use **<** or **>** to select a time zone and press **OK**.
- The camera clock is automatically synchronized whenever location data are acquired via GPS (P. 42).

### **Erasing data [Card]**

- Before formatting, check that no important data is left in the card.
- Cards must be formatted with this camera before first use or after being used with other cameras or computers.

Submenu 2	Application
All Erase	Delete all image data from the card. Log data are not deleted.
Format	Format the card.

### **Resetting camera settings [Reset]**

- Reset all settings except the date and time to default values. Image and log data are not deleted.

Submenu 2	Application
Cancel	Do not reset camera settings.
Reset	Reset camera settings to default values.

# Connecting the camera to a smartphone

By connecting to a smartphone through this camera's wireless LAN function and using the specified app (OI.Track, OI.Share), you can enjoy even more features during and after shooting.

## Things you can do with the specified app, OLYMPUS Image Share (OI.Share)

- Camera image transfer to a smartphone  
You can load images in the camera to a smartphone.
- Remote shooting from a smartphone  
You can remotely operate the camera and shoot using a smartphone.
- Beautiful image processing  
You can apply art filters and add stamps on images loaded to a smartphone.
- Addition of GPS tags to camera images  
You can add GPS tags to images simply by transferring the GPS log saved on the smartphone to the camera.

For details, visit the address below:

<http://app.olympus-imaging.com/oishare/>

- Before using the wireless LAN function, read "Using the wireless LAN function" (P. 68).
- If using the wireless LAN function in a country outside the region where the camera was purchased, there is a risk that the camera will not conform to the wireless communication regulations of that country. Olympus will not be held responsible for any failure to meet such regulations.
- As with any wireless communication, there is always a risk of interception by a third party.
- The wireless LAN function on the camera cannot be used to connect to a home or public access point.
- Keep the antenna (P. 3) away from metal objects whenever possible.
- During wireless LAN connection, the battery will run down faster. If the battery is running low, the connection may be lost during a transfer.
- Connection may be difficult or slow in proximity to devices that generate magnetic fields, static electricity or radio waves, such as near microwaves, cordless telephone.

## Connecting to a smartphone

- 1 Start the OI.Share App installed on your smartphone.
  - You can also connect to smartphones using OI.Track.
- 2 Highlight **[Wi-Fi]** (P. 36) in the **SETUP** menu and press **OK**.
- 3 Highlight **[Start]** and press **OK**.
  - You can also initiate the connection by pressing and holding .
- 4 The QR code displayed in the camera monitor can be read using the app launched on the smartphone.
  - A connection is established automatically and the camera indicator lamp lights blue.



### Failure of reading QR code

Enter the SSID and password in the smartphone Wi-Fi settings app before connecting (the SSID and password can be viewed by pressing  in the QR code display). See the documentation provided with your smartphone for information on Wi-Fi settings.

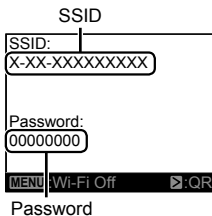

- To end the connection, press the **MENU** button of the camera.

### Error message during Wi-Fi connection

Connect the camera to the smartphone again.

- ① Turn off the Wi-Fi function of your smartphone.
- ② Turn on the Wi-Fi function again. Select the SSID for TG-TRACKER before another connection is made.

## Transferring images to a smartphone

You can select images in the camera and load them to a smartphone.

- 1 Connect the camera to a smartphone. (P. 39)
- 2 Tap the Image Transfer button in OI.Share.
  - The images in the camera are displayed in a list.
  - When an error message is displayed:  "Error message during Wi-Fi connection" (P. 39)
- 3 Select the pictures you want to transfer and tap the Save button.
  - When saving is completed, you can turn off the camera from the smartphone.

## Shooting remotely with a smartphone

You can shoot remotely by operating the camera with a smartphone.

- 1 Connect the camera to a smartphone. (P. 39)
  - 2 Tap the Remote button in OI.Share.
    - When an error message is displayed:  "Error message during Wi-Fi connection" (P. 39)
  - 3 Tap the shutter button to shoot.
    - Photos and movies are saved to the card in the camera.
- Available shooting options are partially limited.
  - In continuous shooting mode, photographs (P. 30) will be taken while the shutter button is pressed in OI.Share.



## Adding position information to images

You can add GPS tags to images that were taken while the GPS log was saving by transferring the GPS log saved on the smartphone to the camera.

- 1 Before beginning to shoot, launch OI.Share and turn on the switch on the Add Location button to begin saving the GPS log.
  - Before beginning to save the GPS log, the camera must be connected to OI.Share once to synchronize the time.
  - You can use the phone or other apps while the GPS log is saving. Do not terminate OI.Share.
- 2 When shooting is complete, turn off the switch on the Add Location button.

Saving the GPS log is complete.
- 3 Connect the camera to a smartphone. (P. 39)
- 4 Transfer the saved GPS log to the camera using OI.Share.
  - GPS tags are added to the images in the card based on the transferred GPS log.
  - When an error message is displayed:  "Error message during Wi-Fi connection" (P. 39)

- Addition of location information can only be used with smartphones that have a GPS function.
- Position information cannot be added to movies.

## Changing password

Choose a new password for smartphone connections.

- 1 Highlight **[Wi-Fi]** (P. 36) in the **SETUP** menu and press **OK**.
- 2 Highlight **[Password]** and press **OK**.
- 3 Press the  button.
  - A new password will be generated automatically.

# Using GPS function

Whether being used to take photographs or not, the camera can acquire and log GPS and other sensor data, including position and altitude. These data can also be embedded in photographs. Logs can be downloaded for use with the OLYMPUS Image Track (OI.Track) smartphone app.

- The camera is not equipped for GPS navigation.
- Be sure to use the latest version of the app.

For details, visit the address below:

<http://app.olympus-imaging.com/oitrack/>

## **Before you begin**

- Before using the GPS function, read “GPS function, electronic compass” (P. 68).
- In certain countries and regions it may be illegal to acquire position information without prior application to the government. Because of this, in certain sales regions, the camera may be set up not to display position information.

When taking the camera abroad, be aware that some regions or countries may have laws regulating the use of this function. Be sure to abide by all local laws.

- Onboard airplanes and in other locations where the use of GPS devices is prohibited, be sure to select **[Off]** for **[LOG Setting]** or rotate the power switch to **OFF**.  **[LOG Setting]** (P. 34)
- This camera also supports Quasi-Zenith Satellites System and GLONASS.

## Before using GPS function (A-GPS data)

Depending on the status of the camera and communication, it may take time to acquire the position information. When the A-GPS is used, the position determination time can be shortened from a few seconds to a few tens of seconds. The A-GPS data can be updated using the smartphone app “OLYMPUS Image Track” (OI.Track) or the PC software “OLYMPUS A-GPS Utility”.

- Make sure that the camera date is set correctly.
- A-GPS data must be updated every 2 weeks.  
The position information may have changed when time has elapsed after updating the data. Use as new A-GPS data as possible.
- The provision of A-GPS data may be terminated without prior notice.

### Updating the A-GPS data using a smartphone

Before update, install the smartphone app “OLYMPUS Image Track” (OI.Track) on your smartphone. Refer to the URL below for details on how to update the A-GPS data.

<http://app.olympus-imaging.com/oitrack/>

Connect the camera and the smartphone, following the procedure described in “Connecting to a smartphone” (P. 39).

### Updating the A-GPS data using a PC

Download the OLYMPUS A-GPS Utility software from the URL below, and install it on your PC.

<http://sdl.olympus-imaging.com/agps/>

Refer to “OLYMPUS A-GPS Utility Instruction Manual” on the website with above URL for details on how to update the data.

### Error message during Wi-Fi connection

Connect the camera to the smartphone again.  P. 39

### Using GPS

Rotate the power switch to **LOG** and use the camera to record location data to a temporary buffer (P. 20) or select **[On]** for **[LOG Setting]** in the **SETUP** menu to record location data to a temporary buffer during shooting (P. 34).

- Do not cover the GPS antenna with your hands or metal objects.
- If you are using the GPS function for the first time and the A-GPS has not been updated, or if the function has not been used for a long time, it may take a few minutes for the position measurement to end.
- When **[LOG Setting]** is set to **[On]**, the battery will run down faster.

# Connecting the camera to another device

## Viewing camera images on TV

Use the HDMI cable (sold separately) to playback recorded images on your TV. Connect the camera to a high-definition TV to view pictures at high resolution.

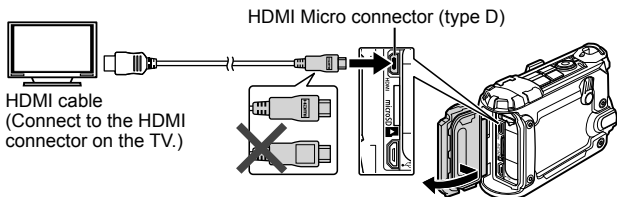

- 1 Use the cable to connect the camera to the TV.
- 2 Rotate the power switch to **ON**.
- 3 Choose the TV input channel.
  - The camera monitor turns off when the cable is connected.
  - For details on changing the input source of the TV, refer to the TV's instruction manual.
  - Depending on the TV's settings, the displayed images and information may become cropped.

## Using the TV remote control

---

When connected to a TV that supports HDMI control, the camera can be operated using the TV remote control. HDMI control must be enabled in the camera menus before the camera is connected.

- 1** Select **[HDMI Control]** (P. 34) in the **PLAY** menu.
  - 2** Highlight **[On]** and press **OK**.
  - 3** Use the cable to connect the camera to the TV.
  - 4** Choose the TV input channel.
  - 5** Operate the camera by using the TV remote control.
    - You can operate the camera by following the operation guide displayed on the TV.
    - Some televisions may not support all features.
- You cannot shoot pictures or movies when the HDMI cable is connected.
  - Do not connect the camera to other HDMI output devices. Doing so may damage the camera.
  - HDMI output is not performed while connected via USB to a computer.

# Connecting the camera to a computer

## Connecting the camera

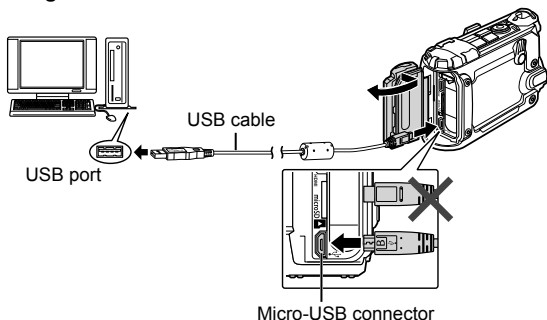

- If nothing is displayed on the camera screen even after connecting the camera to the computer, the battery may be exhausted. Use a full-charged battery.
- If no connection is established, disconnect and reconnect the cable.
- The battery can be charged while the camera is connected to the computer via USB. The charging time varies depending on the performance of the computer. (There may be cases in which it takes approx. 10 hours.)

## Copying pictures to a computer

Your camera supports the USB Mass Storage Class. You can transfer images to a computer by connecting the camera to the computer with the provided USB cable. The following operating systems are compatible with the USB connection:

<b>Windows</b>	Windows Vista SP2 / Windows 7 SP1 / Windows 8 / Windows 8.1 / Windows 10
<b>Macintosh</b>	Mac OS X v10.5-v10.10

- 1** Turn the camera off and connect it to the computer.
  - The location of the USB port varies with the computer. For details, refer to your computer's manual.
- 2** Rotate the power switch to **ON**.
- 3** The computer recognizes the camera as a new device.
  - Data transfer is not guaranteed in the following environments, even if your computer is equipped with a USB port.
    - Computers with a USB port added by means of an extension card, etc.
    - Computers without a factory-installed OS and home-built computers
  - Camera controls can not be used while the camera is connected to a computer.
  - If the computer does not detect the camera, repeat the above from Step 1.

# Installing Software

Use OLYMPUS Viewer 3 to copy pictures from the camera to the computer, where they can be browsed, edited, and organized.

## ■ Windows

### 1 Insert the supplied CD in a CD-ROM drive.

- An Autorun dialog will be displayed. Click “OLYMPUS Setup” to display the “Setup” dialog.
- If the “Setup” dialog is not displayed, open the CD-ROM (OLYMPUS Setup) in Windows Explorer and double-click “LAUNCHER.EXE”.



- If a “User Account Control” dialog is displayed, click “Yes” or “Continue”.

### 2 Follow the on-screen instructions on your computer.

### 3 Register your Olympus product.

- Click the “Registration” button and follow the on-screen instructions.

### 4 Install OLYMPUS Viewer 3.

- Check the system requirements before beginning installation.
- Click the “OLYMPUS Viewer 3” button and follow the on-screen instructions to install the software.

<b>Operating System</b>	Windows Vista SP2/Windows 7 SP1/Windows 8 / Windows 8.1/Windows 10
<b>Processor</b>	Core 2 Duo 2.13 GHz or better
<b>RAM</b>	2 GB or more
<b>Free Hard Drive Space</b>	3 GB or more
<b>Monitor Settings</b>	1024 × 768 pixels or more Minimum 65,536 colors (16,770,000 colors recommended)

- See online help for information on using the software.
- The table above gives the minimum system requirements. Higher specifications may be required at some settings. See the software “Readme” file for more information.



## ■ Macintosh

### 1 Insert the supplied CD in a CD-ROM drive.

- The disk contents should automatically be displayed in the Finder. If they are not, double-click the CD icon on the desktop.
- Double-click the “Setup” icon to display the “Setup” dialog.



### 2 Install OLYMPUS Viewer 3.

- Check the system requirements before beginning installation.
- Click the “OLYMPUS Viewer 3” button and follow the on-screen instructions to install the software.



<b>Operating System</b>	Mac OS X v10.8–v10.11
<b>Processor</b>	Core 2 Duo 2 GHz or better
<b>RAM</b>	2 GB or more
<b>Free Hard Drive Space</b>	3 GB or more
<b>Monitor Settings</b>	1024 × 768 pixels or more Minimum 32,000 colors (16,770,000 colors recommended)

- Other languages can be selected from the language combo box. For information on using the software, see online help.
- The table above gives the minimum system requirements. Higher specifications may be required at some settings. See the software “Readme” file for more information.

# Usage Tips

If the camera does not work as intended, or if an error message is displayed on the screen, and you are unsure of what to do, refer to the information below to fix the problem(s).

## Troubleshooting

### ■ Battery

**The camera does not work even when batteries are installed.**

- Insert recharged batteries in the correct direction.  “Inserting and removing the battery and card” (P. 4)
- Battery performance may have been reduced temporarily due to low temperature. Take the batteries out of the camera, and warm them by putting them in your pocket for a while.

### ■ Card

**An error message is displayed.**

-  “Error message” (P. 52)

### ■ The record button

**Pictures cannot be taken.**

- Turn the camera on.  
If an option other than **[Hold]** is selected for **[Autopw Off]** in the **SETUP** menu, the camera will turn off automatically if no operations are performed for the selected period unless movie recording, continuous shooting, time-lapse movie recording, or charging is in progress or the camera is connected via a USB or to a smartphone. Rotate the power switch to **OFF** and then back to **ON** to turn the camera on again.
- Select shooting mode.
- With prolonged camera use, the internal temperature may increase, resulting in automatic shutdown. If this occurs, wait until the camera has sufficiently cooled.  
The camera's external temperature may also increase during use, however this is normal and does not indicate malfunction.

### ■ Monitor

**Difficult to see.**

- Condensation may have occurred. Turn off the power, and wait for the camera body to become acclimated to the surrounding temperature and dry out before taking pictures.

## The light is caught in the picture.

- Light reflected from dust particles in the air may appear in pictures taken with the headlamp at night.

## ■ Date and time function

### The clock is reset.

- The **[Reset]** option in the **SETUP** menu resets the clock (P. 37).
- If the batteries are removed and left out of the camera for about 3 days\*<sup>1</sup>, the date and time settings return to the default setting, and must be reset.

\*<sup>1</sup> The time until the date and time settings return to the default setting varies depending on how long the batteries have been loaded.

 "Turning on the camera" (P. 8)

## ■ Lens

### Lens gets fogged.

- For rapid temperature change, lens fogging (condensation) may occur.  
Turn off the power, and wait for the camera body to become acclimated to the surrounding temperature and dry out before taking pictures.
- Water droplets inside the lens protector or underwater lens protector may cause clouding. Wipe gently with a soft cloth.











## ■ Miscellaneous



### The compass heading is not correct.

- The compass does not function as expected in the vicinity of strong electromagnetic fields, such as from televisions, microwaves, large electric motors, radio transmitters, and high-voltage power lines.  
Normal function can sometimes be restored by moving the camera in a figure eight while rotating your wrist.

## Error message

- When one of the messages below is displayed on the monitor, check the corrective action.

Error message	Corrective action
 <b>No Card</b>	<b>Card problem</b> Insert a card, or confirm that the card is correctly inserted.
 <b>Card Error</b>	<b>Card problem</b> Insert a new card.
 <b>Write Protect</b>	<b>Card problem</b> Unlock the card.
 <b>Card Full</b>	<b>Card problem</b> <ul style="list-style-type: none"><li>Replace the card.</li><li>Erase unwanted images. Before erasing important images, download them to a computer.</li></ul>
 <b>No Picture</b>	<b>Card problem</b> Take pictures before viewing them.
 <b>Picture Error</b>	<b>Problem with selected image</b> Use photo retouch software, etc. to view the image on a computer. If the image still cannot be viewed, the image file is corrupted.
 <b>LOG Error</b>	<b>Log recording problems</b> The current log has not been saved to the card. Insert the card correctly and save the log to the card.
 <b>LOG Full</b>	<b>Log data problems</b> The current log cannot be saved to the card. Copy log files to a computer and delete them from the card. <ul style="list-style-type: none"><li>Each card can store up to 199 log files.</li></ul>
 <b>GPS Error</b>	<b>GPS problems</b> GPS malfunction. Turn the camera off and then on again; if the message does not clear from the display, contact an OLYMPUS service representative.
 <b>Internal camera temperature is too high.</b>	<b>Problems with the camera</b> The camera will shortly turn off automatically. Wait for the camera's internal temperature to drop so that shooting can be resumed.

Error message	Corrective action
 <b>Caution Depth</b>	<b>Operating conditions</b> Use at shallow depths.
 <b>Battery Empty</b>	<b>Battery problem</b> The battery is exhausted. Charge the battery.
 <b>No Connection</b>	<b>Connection problem</b> Connect the camera and computer or TV correctly.

## Shooting tips

Check the items below if you find that your pictures aren't turning the way you want them.

### ■ Camera shake

#### Filming movies without camera shake

- Shooting movies using [IS].  P. 29

The camera works to reduce the effects of camera shake.

### ■ Exposure (brightness)

#### Taking pictures with the desired brightness

- Using exposure compensation (P. 27, 30, 32)

Adjust brightness while previewing the effect in the display. Generally, snow and other white objects appear darker in photos than in real life; selecting positive values helps restore their natural whiteness. Negative values, in contrast, are recommended when photographing dark subjects.

### ■ Color hue

#### Taking pictures with natural colors



- Choosing an option for [WB] (white balance) (P. 27, 30, 32)

[Auto] produces the best results in most circumstances, but you may prefer to try other settings depending on shooting conditions (for example, whether you are under water or the sun is shining).

### ■ Image orientation

#### Getting the correct results with the camera held upside down



- Using [FIELD OF VIEW] (P. 27, 32)

Select [  ] (flipped wide-angle) or [  ] (underwater flipped wide-angle) to record movies in the correct orientation when the camera is upside down.

### ■ Image distortion

#### Reducing peripheral distortion

- Using [FIELD OF VIEW] (P. 27, 31, 32)

Select [  ] (underwater wide-angle) or [  ] (underwater flipped wide-angle). This reduces the field of view and makes distortion less apparent.

### ■ Shooting interval

#### Changing the interval for time-lapse movies

- "Choosing an interval [Interval]" (P. 33)

## Playback tips

---

### ■ Playback

#### Viewing pictures

- “Viewing movies” (P. 16)
- “Viewing photographs” (P. 18)

#### Viewing images with high picture quality on a high-definition TV

- **Connect the camera to the TV using an HDMI cable.**  P. 44

## Cleaning and storing the camera

### Camera care

#### Exterior:

- Wipe gently with a soft cloth. If the camera is very dirty, soak the cloth in mild soapy water and wring well. Wipe the camera with the damp cloth and then dry it with a dry cloth. If you have used the camera at the beach, use a cloth soaked in clean water and well wrung.
  - Foreign materials may be attached to the camera when using the camera in conditions with foreign materials such as dirt, dust or sand. If you continue to use the camera in such conditions, it could cause damage to the camera. To avoid such damage, wash the camera using the following method.
- ① Close and lock the battery/card compartment/connector cover firmly (P. 5).
  - ② Immerse the camera lens first in a bucket or other container of fresh water and move it vigorously from side-to-side, or rinse the camera directly under a moderately strong stream of tap water while operating the buttons and opening and closing the monitor.
  - ③ Allow the camera to dry. If condensation forms on the lens during use, remove the lens protector and let the camera dry again.

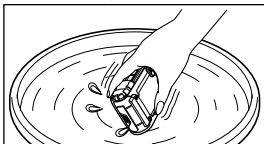

#### Monitor:

- Wipe gently with a soft cloth.

#### Lens:

- Blow dust off the lens with a commercial blower, then wipe gently with a lens cleaner.
- Do not use strong solvents such as benzene or alcohol, or a chemically treated cloth.
- Mold may form on the lens surface if the lens is left dirty.

#### Battery/USB-AC adapter:

- Wipe gently with a soft, dry cloth.



## Storage

---

- When storing the camera for extended periods, remove the battery, adapter and card, and keep in a cool, dry place that is well ventilated.
- Periodically insert the battery and test the camera functions.
- Avoid leaving the camera in places where chemical products are handled since this may result in corrosion.

## Using a separately sold charger

---

A charger (UC-90: sold separately) can be used to charge the battery.

## Using your charger and USB-AC adapter abroad

---

- The charger and USB-AC adapter can be used in most home electrical sources within the range of 100 V to 240 V AC (50/60Hz) around the world. However, depending on the country or area you are in, the AC wall outlet may be shaped differently and the charger and USB-AC adapter may require a plug adapter to match the wall outlet. For details, ask at your local electrical shop or travel agent.
- Do not use travel voltage converters as they could damage your charger and USB-AC adapter.

# Using the card

## Cards compatible with this camera

microSD/microSDHC/microSDXC memory card (commercially available)  
(for compatibility card details, visit the Olympus website.)

- Use a Class 10 or better SDXC memory card. Use SDXC UHS-I cards when recording 4K movies.

## Format

Cards must be formatted with this camera before first use or after being used with other cameras or computers.

- Deleting data or formatting the card using **[Erase]**, **[All Erase]**, or **[Format]** does not completely erase all data from the card. Before disposing of a card, destroy it or take other steps to prevent disclosure of personal information.

## Readout/recording process of the card

The camera displays **[Busy...]** or **[Do Not Remove Cable]** while data are being recorded to the card. Under no circumstances should you open the battery/card compartment/connector cover, remove the card, or disconnect USB cables while either message is displayed. Failure to observe this precaution could not only corrupt image files but also render the card unusable.

## File storage locations

Data on the card are stored in the following folders:

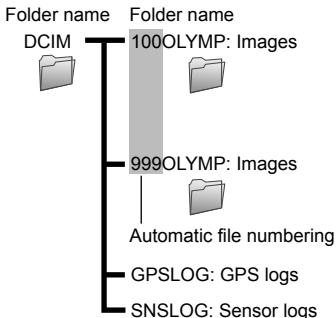

## Maximum movie length/number of photographs

- All figures are approximate. The actual number of photos and length of footage that can be stored vary with the card and shooting conditions.

### Movies

Image Size	Recording length			
	microSD/microSDHC/microSDXC card (4GB)			
	240fps	120fps	60fps	30fps
<b>4K</b> 3840×2160*1	—	—	—	6 min.
<b>FHD</b> 1920×1080*1	—	—	18 min.	27 min.
<b>HD</b> 1280×720*1	14 min.	21 min.	32 min.	51 min.
<b>480</b> 854×480	18 min.	32 min.	57 min.	100 min.

\*1 Individual movies can be up to 29 minutes long.

- The maximum file size of a single movie is 4GB, regardless of the capacity of the card.

### Still pictures

Image Size	Number of storable pictures
	microSD/microSDHC/microSDXC card (4GB)
<b>8.0MP</b> 3840×2160	1530
<b>2.1MP</b> 1920×1080	7120
<b>0.9MP</b> 1280×720	15150
<b>0.4MP</b> 854×480	30300

### Filming more movies or taking more photographs

Either erase unwanted images, or connect the camera to a computer or other device to save the images, and then erase the images in the card.

[Erase] (P. 19, 34), [All Erase] (P. 37), [Format] (P. 37)

## Using accessories

### Attaching the lens protector

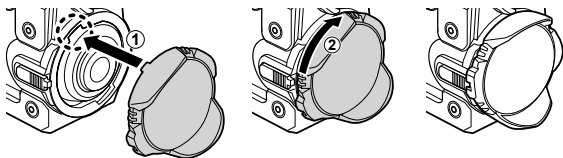

### Removing the lens protector

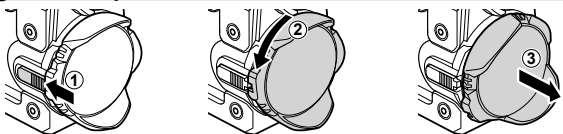

### Attaching the underwater lens protector

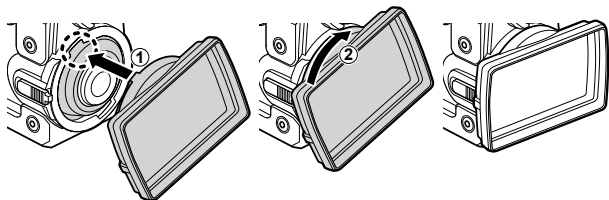

- Before attaching the protector, shake the camera to remove water droplets from the lens.

### Removing the underwater lens protector

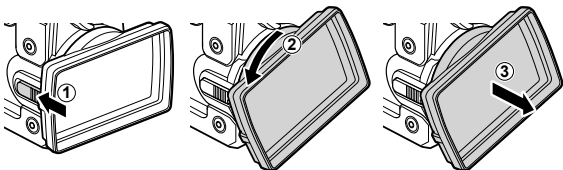

## Attaching the mount coupling and steady grip

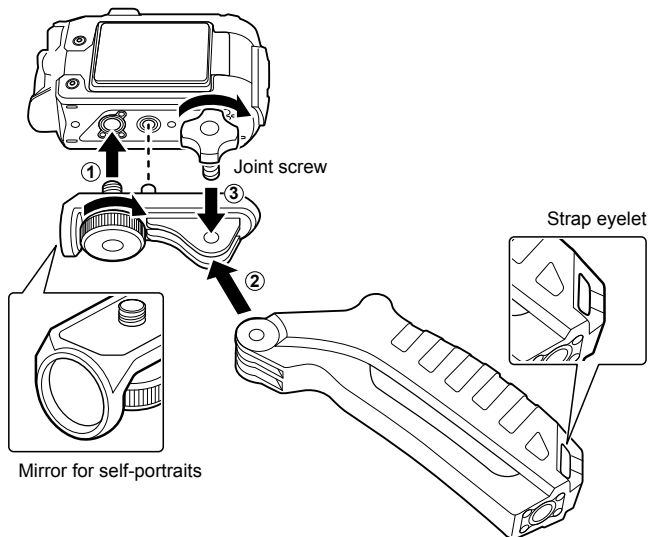

- Tighten screws with a coin or other object.
- Attach the supplied strap (P. 2) to the strap eyelets on the steady grip.
- Use the self-portrait mirror to compose self-portraits.
- Pay attention to your surroundings to avoid danger to yourself or to others when using the camera during active sports or leisure activities that involve many participants. Observe all local laws and regulations.

## Important information about water and shock resistant features

**Water resistance:** The waterproof feature is warranted\*<sup>1</sup> to operate at depths up to 30 m (98.4 feet) for up to one hour.

The waterproof feature may be compromised if the camera is subject to substantial or excessive impact.

**Shock resistance:** The anti-shock feature warrants\*<sup>2</sup> the operation of the camera against accidental impact incurred from everyday use of your digital compact camera. The anti-shock feature does not unconditionally warrant all defective operation or cosmetic damage. Cosmetic damage, such as scratches and dents, are not covered under the warranty.

As with any electronic device, proper care and maintenance are required to preserve the integrity and operation of your camera. To maintain camera performance, please take your camera to the nearest Olympus Authorized Service Center to have it inspected after any major impact. In the event the camera is damaged as a result of negligence or misuse, the warranty will not cover costs associated with the service or repair of your camera. For additional information on our warranty, please visit to the Olympus website for your local area.

Please observe the following care instructions for your camera.

- \*1 As determined by Olympus pressure testing equipment in accordance with IEC Standard Publication 60529 IPX8 - This means that the camera can be used normally under water at a specified water pressure.
- \*2 This anti-shock performance is confirmed by Olympus' testing conditions in accordance with MIL-STD-810F, Method 516.5, Procedure IV (Transit Drop Test) with the lens protector attached, the monitor closed, and the underwater lens protector and mount coupling (with steady grip) not attached. For more details of Olympus' testing conditions, please refer to the Olympus website for your local area.

### Before Use:

- Use a clean, lint-free cloth to remove dust, lint, sand, and other foreign matter from the battery/card compartment/connector cover and lens gaskets and seals.
- Confirm that the battery/card compartment/connector cover and lens gaskets are free from nicks and cracks.
- Securely close the battery/card compartment/connector cover latch.

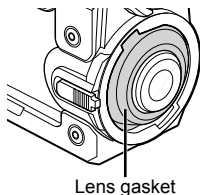

- Do not operate the lens latch or open the battery/card compartment/connector cover with wet hands, while under water, or on a beach or in other damp or dusty locations.
- The camera does not float.
- Do not use in baths or hot springs.
- The lens protector is not for underwater use. Use the underwater lens protector.

### After Use:

- Be sure to wipe off any excess water or debris after using the camera under water.
- **After using the camera in salt water, immerse it in a bucket of fresh water for about 10 minutes (with the underwater lens protector attached and the battery/card compartment/connector cover securely closed and latched) and then leave it to dry in a shady, well-ventilated location. Do not leave the camera for more than 60 minutes before washing it in fresh water. Failure to observe this precaution could adversely affect its appearance or leave it more vulnerable to leaks.**
- **When opening the battery/card compartment/connector cover, open slowly with the camera orientated as shown in the illustration to prevent water drops entering the camera. If any water drops are found on the inner side of the cover, be sure to wipe them off before using the camera.**
- Should water get inside the steady grip, drain the water out through the drain holes in the bottom of the grip and dry it using a dry cloth.

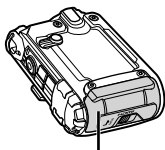

Battery/card compartment/connector cover

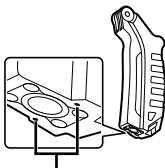

Drain holes

## Storage and Maintenance

- Do not leave the camera in an environment at high temperature (40°C (104°F) or more) or at low temperature (-10°C (14°F) or less). Failure to do so may break down water resistance.
- Do not use chemicals for cleaning, rust prevention, anti-fogging, repairing, etc. Failure to do so may break down water resistance.
- **Do not leave the camera in water for a long time. Prolonged exposure to water will cause damage to the camera's appearance and/or deteriorate water resistance.**
- **In order to preserve the water resistant feature, as with any underwater housing, it is recommended that the waterproof packing (and seals) are replaced annually.**  
**For the Olympus distributors or service stations where the waterproof packing can be replaced, visit Olympus website for your local area.**
- The battery, cables, and USB adapter are not waterproof.



# SAFETY PRECAUTIONS



## CAUTION

**RISK OF ELECTRIC SHOCK  
DO NOT OPEN**



CAUTION: TO REDUCE THE RISK OF ELECTRICAL SHOCK, DO NOT REMOVE COVER (OR BACK). NO USER-SERVICEABLE PARTS INSIDE. REFER SERVICING TO QUALIFIED OLYMPUS SERVICE PERSONNEL.



An exclamation mark enclosed in a triangle alerts you to important operating and maintenance instructions in the documentation provided with the product.



### WARNING

If the product is used without observing the information given under this symbol, serious injury or death may result.



### CAUTION

If the product is used without observing the information given under this symbol, injury may result.



### NOTICE

If the product is used without observing the information given under this symbol, damage to the equipment may result.

**WARNING!**  
**TO AVOID THE RISK OF FIRE OR ELECTRICAL SHOCK, NEVER DISASSEMBLE THIS PRODUCT.**

## General Precautions

**Read All Instructions** — Before you use the product, read all operating instructions. Save all manuals and documentation for future reference.

**Water and Moisture** — For precautions on products with weatherproof designs, read the weatherproofing sections.

**Power Source** — Connect this product only to the power source described on the product label.

**Foreign Objects** — To avoid personal injury, never insert a metal object into the product.

**Cleaning** — Always unplug this product from the wall outlet before cleaning. Use only a damp cloth for cleaning.

Never use any type of liquid or aerosol cleaner, or any type of organic solvent to clean this product.

**Heat** — Never use or store this product near any heat source such as a radiator, heat register, stove, or any type of equipment or appliance that generates heat, including stereo amplifiers.

**Lightning** — If a lightning storm occurs while using a USB-AC adapter, remove it from the wall outlet immediately.

**Attachments** — For your safety, and to avoid damaging the product, use only accessories recommended by Olympus.

**Location** — To avoid damage to the product, mount the product securely on a stable tripod, stand, or bracket.



### WARNING

- Do not use the camera near flammable or explosive gases.
- Do not use the headlamp in close proximity to others, particularly infants.
- Do not look at the sun or strong lights with the camera.

- **Keep young children and infants away from the camera.**
  - Always use and store the camera out of the reach of young children and infants to prevent the following dangerous situations which could cause serious injury:
    - Becoming entangled in the camera strap, causing strangulation.
    - Accidentally swallowing the battery, cards or other small parts.
    - Accidentally being injured by the moving parts of the camera.
- **If you find that the USB-AC adapter is extremely hot or notice any unusual odors, noise, or smoke around it, unplug the power plug from wall outlet immediately and stop using it. Then, contact an authorized distributor or service center.**
- **Stop using the camera immediately if you notice any unusual odors, noise, or smoke around it.**
  - Never remove the batteries with bare hands, which may cause a fire or burn your hands.
- **Do not leave the camera in places where it may be subject to extremely high temperatures.**
  - Doing so may cause parts to deteriorate and, in some circumstances, cause the camera to catch fire. Do not use the charger if it is covered (such as a blanket). This could cause overheating, resulting in fire.
- **Handle the camera with care to avoid getting a low-temperature burn.**
  - When the camera contains metal parts, overheating can result in a low-temperature burn. Pay attention to the following:
    - When used for a long period, the camera will get hot. If you hold on to the camera in this state, a low-temperature burn may be caused.
    - In places subject to extremely cold temperatures, the temperature of the camera's body may be lower than the environmental temperature. If possible, wear gloves when handling the camera in cold temperatures.
- To protect the high-precision technology contained in this product, never leave the camera in the places listed below, no matter if in use or storage:
  - Places where temperatures and/or humidity are high or go through extreme changes. Direct sunlight, beaches, locked cars, or near other heat sources (stove, radiator, etc.) or humidifiers.
  - In sandy or dusty environments.
  - Near flammable items or explosives.
  - In wet places, such as bathrooms or in the rain. When using products with weatherproof designs, read their manuals as well.
  - In places prone to strong vibrations.
- **The camera uses a lithium ion battery specified by Olympus.**

Charge the battery with the specified USB-AC adapter or charger. Do not use any other USB-AC adapters or chargers.
- **Never incinerate or heat batteries in microwaves, on hot plates, or in pressure vessels, etc.**
- **Never leave the camera on or near electromagnetic devices.**

This may cause overheating, burning, or exploding.
- **Do not connect terminals with any metallic objects.**
  - Take precautions when carrying or storing batteries to prevent them from coming into contact with any metal objects such as jewelry, pins, fasteners, keys, etc.
  - The short circuit may cause overheating, exploding, or burning, which burn or damage you.
- **To prevent causing battery leaks or damaging their terminals, carefully follow all instructions regarding the use of batteries. Never attempt to disassemble a battery or modify it in any way, solder, etc.**
- **If battery fluid gets into your eyes, flush your eyes immediately with clear, cold running water and seek medical attention immediately.**
- **If you cannot remove the battery from the camera, contact an authorized distributor or service center.**

Do not try to remove the battery by force.  
Damage to the battery exterior (scratches, etc.) may produce heat or an explosion.
- **Always store batteries out of the reach of small children and pets. If they accidentally swallow a battery, seek medical attention immediately.**
  - To prevent batteries from leaking, overheating, or causing a fire or explosion, use only batteries recommended for use with this product.
  - If rechargeable batteries have not been recharged within the specified time, stop charging them and do not use them.
  - Do not use batteries with scratches or damage to the casing, and do not scratch the battery.

- Never subject batteries to strong shocks or continuous vibration by dropping or hitting. This may cause exploding, overheating, or burning.
- If a battery leaks, has unusual odor, becomes discolored or deformed, or becomes abnormal in any other way during operation, stop using the camera, and keep away from fire immediately.
- If a battery leaks fluid onto your clothing or skin, remove the clothing and flush the affected area with clean, running cold water immediately. If the fluid burns your skin, seek medical attention immediately.
- The Olympus lithium ion battery is designed to be used only for the Olympus digital camera. Do not use the battery to other devices.
- **Do not allow children or animals/pets to handle or transport batteries (prevent dangerous behaviour such as licking, putting in mouth or chewing).**

### Use Only Dedicated Rechargeable Battery, Battery Charger and USB-AC adapter

We strongly recommend that you use only the genuine Olympus dedicated rechargeable battery, battery charger and USB-AC adapter with this camera. Using a non-genuine rechargeable battery, battery charger and/or USB-AC adapter may result in fire or personal injury due to leakage, heating, ignition or damage to the battery. Olympus does not assume any liability for accidents or damage that may result from the use of a battery, battery charger and/or USB-AC adapter that are not genuine Olympus accessories.

### CAUTION

- **Do not cover the headlamp with a hand while firing.**
- **Do not touch the headlamp after it has fired repeatedly.**
- The included USB-AC adapter F-5AC is designed to be used only with this camera. Other cameras cannot be charged with this USB-AC adapter.
- Do not connect the included USB-AC adapter F-5AC to equipment other than this camera.
- **Never store batteries where they will be exposed to direct sunlight, or subjected to high temperatures in a hot vehicle, near a heat source, etc.**
- Keep batteries dry at all times.
- The battery may become hot during prolonged use. To avoid minor burns, do not remove it immediately after using the camera.
- This camera uses one Olympus lithium ion battery. Use the specified genuine battery. There is a risk of explosion if the battery is replaced with the incorrect battery type.
- Please recycle batteries to help save our planet's resources. When you throw away dead batteries, be sure to cover their terminals and always observe local laws and regulations.

### NOTICE

- **Do not use or store the camera in dusty or humid places.**
- **Use microSD/microSDHC/microSDXC memory cards only. Never use other types of cards.**  
If you accidentally insert another type of card into the camera, contact an authorized distributor or service center. Do not try to remove the card by force.
- Be careful with the strap when you carry the camera. It could easily catch on stray objects and cause serious damage.
- Never drop the camera or subject it to severe shocks or vibrations.
- When attaching the camera to or removing it from a tripod, rotate the tripod screw, not the camera.
- Before transporting the camera, remove a tripod and all other non-OLYMPUS accessories.
- Do not touch electric contacts on cameras.
- Do not leave the camera pointed directly at the sun. This may cause lens or shutter curtain damage, color failure, ghosting on the image pickup device, or may possibly cause fires.
- Do not push or pull severely on the lens.
- Before storing the camera for a long period, remove the batteries. Select a cool, dry location for storage to prevent condensation or mold from forming inside the camera. After storage, test the camera by turning it on and pressing the shutter button to make sure that it is operating normally.
- The camera may malfunction if it is used in a location where it is subject to a magnetic/electromagnetic field, radio waves, or high voltage, such as near a TV set, microwave, video game, loud speakers, large monitor unit, TV/radio tower, or transmission towers. In such cases, turn the camera off and on again before further operation.
- Always observe the operating environment restrictions described in the camera's manual.

- Insert the battery carefully as described in the operating instructions.
- Before loading, always inspect the battery carefully for leaks, discoloration, warping, or any other abnormality.
- Always unload the battery from the camera before storing the camera for a long period.
- When storing the battery for a long period, select a cool location for storage.
- Power consumption by the camera varies depending on which functions are used.
- During the conditions described below, power is consumed continuously and the battery becomes exhausted quickly.
  - Images are displayed in the monitor for long periods.
  - GPS is used.
- Using an exhausted battery may cause the camera to turn off without displaying the battery level warning.
- If the battery's terminals get wet or greasy, camera contact failure may result. Wipe the battery well with a dry cloth before use.
- Always charge a battery when using it for the first time, or if it has not been used for a long period.
- When operating the camera with battery power at low temperatures, try to keep the camera and spare battery as warm as possible. A battery that has run down at low temperatures may be restored after it is warmed at room temperature.
- Before going on a long trip, and especially before traveling abroad, purchase extra batteries. A recommended battery may be difficult to obtain while traveling.
- For plug-in type USB-AC adapter:
  - Connect the plug-in type USB-AC adapter F-5AC correctly by plugging it vertically into the wall outlet.

### Using the wireless LAN function

- **Turn off the camera in hospitals and other locations where medical equipment is present.**  
The radio waves from the camera may adversely affect medical equipment, causing a malfunction that results in an accident.
- **Turn off the camera when onboard aircraft.**  
Using wireless devices onboard may hinder safe operation of the aircraft.

### Precautions when using the wireless LAN function

If using the wireless LAN function in a country outside the region where the camera was purchased, there is a risk that the camera will not conform to the wireless communication regulations of that country. Olympus will not be held responsible for any failure to meet such regulations.

### GPS function, electronic compass

- In a location not open to the sky (inside, underground, underwater, in a forest, near high buildings) or in a location subject to strong magnetic or electric fields (near new high-voltage power lines, magnets or electrical goods, 1.5GHz mobile telephones), it may not be possible to determine measurements or generate errors.
- The altitude displayed on the measurement information screen or picture playback screen etc. is displayed/recorded based on information from pressure sensors built into camera body. Be careful since the displayed altitude is not based on GPS position measurements.
- Electronic compass errors may be caused by the effects of strong magnetic or electrical fields (such as televisions, microwaves, large motors, radio towers and high-voltage lines). To restore the electronic compass function, hold the camera firmly and move in a figure of 8 while turning your wrist over.
- Since the GPS function and electronic compass function are not required to be accurate, there is no guarantee that the measured values (latitude, longitude, compass direction etc.) are accurate.

### Monitor

- Do not push the monitor forcibly; otherwise the image may become vague, resulting in a playback mode failure or damage to the monitor.
- A strip of light may appear on the top/bottom of the monitor, but this is not a malfunction.
- When a subject is viewed diagonally in the camera, the edges may appear zigzagged on the monitor. This is not a malfunction; it will be less noticeable in playback mode.

- In places subject to low temperatures, the monitor may take a long time to turn on or its color may change temporarily. When using the camera in extremely cold places, it is a good idea to occasionally place it in a warm place. The monitor exhibiting poor performance due to low temperatures will recover in normal temperatures.
- The monitor of this product is manufactured with high-quality accuracy, however, there may be a stuck or dead pixel on the monitor. These pixels do not have any influence on the image to be saved. Because of the characteristics, the unevenness of the color or brightness may also be found depending on the angle, but this is due to the structure of the monitor. This is not a malfunction.

## Legal and Other Notices

- Olympus makes no representations or warranties regarding any damages, or benefit expected by using this unit lawfully, or any request from a third person, which are caused by the inappropriate use of this product.
- Olympus makes no representations or warranties regarding any damages or any benefit expected by using this unit lawfully which are caused by erasing picture data.

## Disclaimer of Warranty

- Olympus makes no representations or warranties, either expressed or implied, by or concerning any content of these written materials or software, and in no event shall be liable for any implied warranty of merchantability or fitness for any particular purpose or for any consequential, incidental or indirect damages (including but not limited to damages for loss of business profits, business interruption and loss of business information) arising from the use or inability to use these written materials or software or equipment. Some countries do not allow the exclusion or limitation of liability for consequential or incidental damages or of the implied warranty, so the above limitations may not apply to you.
- Olympus reserves all rights to this manual.

## Warning

Unauthorized photographing or use of copyrighted material may violate applicable copyright laws. Olympus assumes no responsibility for unauthorized photographing, use or other acts that infringe upon the rights of copyright owners.

## Copyright Notice

All rights reserved. No part of these written materials or this software may be reproduced or used in any form or by any means, electronic or mechanical, including photocopying and recording or the use of any type of information storage and retrieval system, without the prior written permission of Olympus. No liability is assumed with respect to the use of the information contained in these written materials or software, or for damages resulting from the use of the information contained therein. Olympus reserves the right to alter the features and contents of this publication or software without obligation or advance notice.

## FCC Notice

This equipment has been tested and found to comply with the limits for a Class B digital device, pursuant to part 15 of the FCC Rules. These limits are designed to provide reasonable protection against harmful interference in a residential installation. This equipment generates, uses and can radiate radio frequency energy and, if not installed and used in accordance with the instructions, may cause harmful interference to radio communications. However, there is no guarantee that interference will not occur in a particular installation. If this equipment does cause harmful interference to radio or television reception, which can be determined by turning the equipment off and on, the user is encouraged to try to correct the interference by one or more of the following measures:

- Reorient or relocate the receiving antenna.
- Increase the separation between the equipment and receiver.
- Connect the equipment into an outlet on a circuit different from that to which the receiver is connected.
- Consult the dealer or an experienced radio/TV technician for help.
- Only the OLYMPUS-supplied USB cable should be used to connect the camera to USB enabled personal computers.

## FCC/IC Caution

Changes or modifications not expressly approved by the party responsible for compliance could void the user's authority to operate the equipment.

This transmitter must not be co-located or operated in conjunction with any other antenna or transmitter.

The available scientific evidence does not show that any health problems are associated with using low power wireless devices. There is no proof, however, that these low power wireless devices are absolutely safe. Low power Wireless devices emit low levels of radio frequency energy (RF) in the microwave range while being used. Whereas high levels of RF can produce health effects (by heating tissue), exposure of low-level RF that does not produce heating effects causes no known adverse health effects. Many studies of low-level RF exposures have not found any biological effects. Some studies have suggested that some biological effects might occur, but such findings have not been confirmed by additional research. STYLUS TG-TRACKER has been tested and found to comply with FCC/IC radiation exposure limits set forth for an uncontrolled environment and meets the FCC radio frequency (RF) Exposure Guidelines and RSS-102 of the IC radio frequency (RF) Exposure rules.

## For customers in North America, Central America, South America and the Caribbean

### Declaration of Conformity

Model Number: STYLUS TG-TRACKER  
Trade Name: OLYMPUS  
Responsible Party: OLYMPUS AMERICA INC.  
Address: 3500 Corporate Parkway,  
P.O. Box 610, Center Valley,  
PA 18034-0610, U.S.A.  
Telephone Number: 484-896-5000

Tested To Comply With FCC Standards  
FOR HOME OR OFFICE USE

This device complies with Part 15 of FCC Rules and Industry Canada licence-exempt RSS standard(s). Operation is subject to the following two conditions:

- (1) This device may not cause harmful interference.
- (2) This device must accept any interference received, including interference that may cause undesired operation.

This Class B digital apparatus complies with Canadian ICES-003. CAN ICES-3(B)/NMB-3(B)

The STYLUS TG-TRACKER, when attached to the SG-T01 Steady Grip or similar style of grip, may resemble a weapon.

When attached to the SG-T01 Steady Grip or similar style of grip, refrain from pointing the STYLUS TG-TRACKER at police.

## OLYMPUS AMERICAS LIMITED WARRANTY - OLYMPUS AMERICA INC. PRODUCTS

Olympus warrants that the enclosed Olympus® imaging product(s) and related Olympus® accessories (individually a "Product" and collectively the "Products") will be free from defects in materials and workmanship under normal use and service for a period of one (1) year from the date of purchase.

If any Product proves to be defective within the one-year warranty period, the customer must return the defective Product to the authorized Olympus Repair Service Center designated by Olympus, following the procedure set forth below (See "WHAT TO DO WHEN SERVICE IS NEEDED").

Olympus, at its sole discretion, will repair, replace, or adjust the defective Product at Olympus's cost, provided that an Olympus investigation and factory inspection disclose that (a) such defect developed under normal and proper use and (b) the Product is covered under this limited warranty.

Repair, replacement, or adjustment of defective Products shall be Olympus's sole obligation and the customer's sole remedy hereunder.

Repair or replacement of a Product shall not extend the warranty period provided herein, unless required by law. Except where prohibited by law, the customer is liable and shall pay for shipment of the Products to the designated Olympus Repair Service Center.

Olympus shall not be obligated to perform preventive maintenance, installation, deinstallation, or maintenance.

Olympus reserves the right to (i) use reconditioned, refurbished, and/or serviceable used parts (that meet Olympus's quality assurance standards) for warranty or any other repairs and (ii) make any internal or external design and/or feature changes on or to its products without any liability to incorporate such changes on or to the Products.

## WHAT IS NOT COVERED BY THIS LIMITED WARRANTY

Excluded from this limited warranty and not warranted by Olympus in any fashion, either express, implied, or by statute, are:

- (a) products and accessories not manufactured by Olympus and/or not bearing the "OLYMPUS" brand label (the warranty coverage for products and accessories of other manufacturers, which may be distributed by Olympus, is the responsibility of the respective manufacturer of such products and accessories in accordance with the terms and duration of such manufacturers' warranties);
- (b) any Product which has been disassembled, repaired, tampered with, altered, changed, or modified by persons other than Olympus's own authorized service personnel unless repair by others is made with the written consent of Olympus;
- (c) defects or damage to the Products resulting from wear, tear, misuse, abuse, negligence, sand, liquids, impact, improper storage, nonperformance of scheduled operator and maintenance items, battery leakage, use of non-"OLYMPUS" brand accessories, consumables, or supplies, or use of the Products in combination with non-compatible devices;
- (d) software programs;
- (e) supplies and consumables (including but not limited to lamps, ink, paper, film, prints, negatives, cables and batteries); and/or
- (f) Products which do not contain a validly placed and recorded Olympus serial number, unless they are a model on which Olympus does not place and record serial numbers.
- (g) Products shipped, delivered, purchased, or sold from dealers located outside of North America, Central America, South America and the Caribbean; and/or
- (h) Products that are not intended or authorized to be sold in North America, South America, Central America, or the Caribbean (ie. Gray Market Goods).

### WARRANTY DISCLAIMER; LIMITATION OF DAMAGES; AFFIRMATION OF ENTIRE WARRANTY AGREEMENT; INTENDED BENEFICIALY

EXCEPT FOR THE LIMITED WARRANTY SET FORTH ABOVE, OLYMPUS MAKES NO AND DISCLAIMS ALL OTHER REPRESENTATIONS, GUARANTIES, CONDITIONS, AND WARRANTIES CONCERNING THE PRODUCTS, WHETHER DIRECT OR INDIRECT, EXPRESS OR IMPLIED, OR ARISING UNDER ANY STATUTE, ORDINANCE, COMMERCIAL USAGE OR OTHERWISE, INCLUDING BUT NOT LIMITED TO ANY WARRANTY OR REPRESENTATION AS TO THE SUITABILITY, DURABILITY, DESIGN, OPERATION, OR CONDITION OF THE PRODUCTS (OR ANY PART THEREOF) OR THE MERCHANTABILITY OF THE PRODUCTS OR THEIR FITNESS FOR A PARTICULAR PURPOSE, OR RELATING TO THE INFRINGEMENT OF ANY PATENT, COPYRIGHT, OR OTHER PROPRIETARY RIGHT USED OR INCLUDED THEREIN.

IF ANY IMPLIED WARRANTIES APPLY AS A MATTER OF LAW, THEY ARE LIMITED IN DURATION TO THE LENGTH OF THIS LIMITED WARRANTY.

SOME STATES MAY NOT RECOGNIZE A DISCLAIMER OR LIMITATION OF WARRANTIES AND/OR LIMITATION OF LIABILITY SO THE ABOVE DISCLAIMERS AND EXCLUSIONS MAY NOT APPLY.

THE CUSTOMER MAY ALSO HAVE DIFFERENT AND/OR ADDITIONAL RIGHTS AND REMEDIES THAT VARY FROM STATE TO STATE.

THE CUSTOMER ACKNOWLEDGES AND AGREES THAT OLYMPUS SHALL NOT BE RESPONSIBLE FOR ANY DAMAGES THAT THE CUSTOMER MAY INCUR FROM DELAYED SHIPMENT, PRODUCT FAILURE, PRODUCT DESIGN, SELECTION, OR PRODUCTION, IMAGE OR DATA LOSS OR IMPAIRMENT OR FROM ANY OTHER CAUSE, WHETHER LIABILITY IS ASSERTED IN CONTRACT, TORT (INCLUDING NEGLIGENCE AND STRICT PRODUCT LIABILITY) OR OTHERWISE. IN NO EVENT SHALL OLYMPUS BE LIABLE FOR ANY INDIRECT, INCIDENTAL, CONSEQUENTIAL OR SPECIAL DAMAGES OF ANY KIND (INCLUDING WITHOUT LIMITATION LOSS OF PROFITS OR LOSS OF USE), WHETHER OR NOT OLYMPUS SHALL BE OR SHOULD BE AWARE OF THE POSSIBILITY OF SUCH POTENTIAL LOSS OR DAMAGE.

Representations and warranties made by any person, including but not limited to dealers, representatives, salespersons, or agents of Olympus, which are inconsistent or in conflict with or in addition to the terms of this limited warranty, shall not be binding upon Olympus unless reduced to writing and approved by an expressly authorized officer of Olympus.

This limited warranty is the complete and exclusive statement of warranty which Olympus agrees to provide with respect to the Products and it shall supersede all prior and contemporaneous oral or written agreements, understandings, proposals, and communications pertaining to the subject matter hereof.

This limited warranty is exclusively for the benefit of the original customer and cannot be transferred or assigned.

## WHAT TO DO WHEN SERVICE IS NEEDED

The customer must contact the designated Olympus Consumer Support Team for your region to coordinate the submission of your Product for repair service. To contact your Olympus Consumer Support Team in your region please visit or call the following:

Canada:

[www.olympuscanada.com/repair](http://www.olympuscanada.com/repair) / 1-800-622- 6372

United States:

[www.olympusamerica.com/repair](http://www.olympusamerica.com/repair) / 1-800-622- 6372

Latin America:

[www.olympusamericalatina.com](http://www.olympusamericalatina.com)

The customer must copy or transfer any image or other data saved on a Product to another image or data storage medium prior to sending the Product to Olympus for repair service.

IN NO EVENT SHALL OLYMPUS BE RESPONSIBLE FOR SAVING, KEEPING OR MAINTAINING ANY IMAGE OR DATA SAVED ON A PRODUCT RECEIVED BY IT FOR SERVICE, OR ON ANY FILM CONTAINED WITHIN A PRODUCT RECEIVED BY IT FOR SERVICE, NOR SHALL OLYMPUS BE RESPONSIBLE FOR ANY DAMAGES IN THE EVENT ANY IMAGE OR DATA IS LOST OR IMPAIRED WHILE SERVICE IS BEING PERFORMED (INCLUDING, WITHOUT LIMITATION, DIRECT, INDIRECT, INCIDENTAL, CONSEQUENTIAL OR SPECIAL DAMAGES, LOSS OF PROFITS OR LOSS OF USE), WHETHER OR NOT OLYMPUS SHALL BE OR SHOULD BE AWARE OF THE POSSIBILITY OF SUCH POTENTIAL LOSS OR IMPAIRMENT.

The customer should package the Product carefully using ample padding material to prevent damage in transit. Once the Product is properly packaged, ship the package to Olympus or the Olympus Authorized Repair Service Center location as instructed by the respective Olympus Consumer Support Team.

When sending Products for repair service, your package should include the following:

- 1) Sales receipt showing date and place of purchase. Handwritten receipts will not be accepted;
- 2) Copy of this limited warranty **bearing the Product serial number corresponding to the serial number on the Product** (unless it is a model on which Olympus does not place and record serial numbers);
- 3) A detailed description of the problem; and
- 4) Sample prints, negatives, digital prints (or files on disk) if available and related to the problem.

KEEP COPIES OF ALL DOCUMENTS. Neither Olympus nor an Olympus Authorized Repair Service Center will be responsible for documents that are lost or destroyed in transit.

When service is completed, the Product will be returned to you postage prepaid.

## PRIVACY

Any information provided by you to process your warranty claim shall be kept confidential and will only be used and disclosed for the purposes of processing and performing warranty repair services.

### For customers in Mexico

The operation of this equipment is subject to the following two conditions:

(1) it is possible that this equipment or device may not cause harmful interference, and (2) this equipment or device must accept any interference, including interference that may cause undesired operation.



## For customers in Europe



"CE" mark indicates that this product complies with the European requirements for safety, health, environment and customer protection. "CE" mark cameras are intended for sales in Europe.

Hereby, OLYMPUS CORPORATION and Olympus Europa SE & Co. KG declare that this STYLUS TG-TRACKER is in compliance with the essential requirements and other relevant provisions of Directive 1999/5/EC. For details visit: <http://www.olympus-europa.com/>



This symbol [crossed-out wheeled bin WEEE Annex IV] indicates separate collection of waste electrical and electronic equipment in the EU countries.

Please do not throw the equipment into the domestic refuse.

Please use the return and collection systems available in your country for the disposal of this product.



This symbol [crossed-out wheeled bin Directive 2006/66/EC Annex II] indicates separate collection of waste batteries in the EU countries.

Please do not throw the batteries into the domestic refuse.

Please use the return and collection systems available in your country for the disposal of the waste batteries.

### Provisions of warranty

In the unlikely event that your product proves to be defective, although it has been used properly (in accordance with the written Instruction Manual supplied with it), during the applicable national warranty period and has been purchased from an authorized Olympus distributor within the business area of OLYMPUS EUROPA SE & Co. KG as stipulated on the website: <http://www.olympus-europa.com>, it will be repaired, or at Olympus's option replaced, free of charge. In order to enable Olympus to provide you with the requested warranty services to your full satisfaction and as fast as possible, please note the information and instructions listed below:

- To claim under this warranty please follow the instructions on <http://consumer-service.olympus-europa.com> for registration and tracking (this service is not available in all countries) or take the product, the corresponding original invoice or purchase receipt and the completed Warranty Certificate to the dealer where it was purchased or any other Olympus service station within the business area of OLYMPUS EUROPA SE & Co. KG as stipulated on the website: <http://www.olympus-europa.com>, before the end of the applicable national warranty period.
- Please make sure your Warranty Certificate is duly completed by Olympus or an authorized dealer or Service center. Therefore, please make sure that your name, the name of the dealer, the serial number and the year, month and date of purchase are all completed or the original invoice or the sales receipt (indicating the dealer's name, the date of purchase and product type) is attached to your Warranty Certificate.
- Since this Warranty Certificate will not be re-issued, keep it in a safe place.
- Please note that Olympus will not assume any risks or bear any costs incurred in transporting the product to the dealer or Olympus authorized service station.
- This Warranty does not cover the following and you will be required to pay a repair charge, even for defects occurring within the warranty period referred to above.
  - Any defect that occurs due to mishandling (such as an operation performed that is not mentioned in the Instruction Manual, etc.)
  - Any defect that occurs due to repair, modification, cleaning, etc. performed by anyone other than Olympus or an Olympus authorized service station.
  - Any defect or damage that occurs due to transport, a fall, shock, etc. after purchase of the product.
  - Any defect or damage that occurs due to fire, earthquake, flood damage, thunderbolt, other natural disasters, environmental pollution and irregular voltage sources.
  - Any defect that occurs due to careless or improper storage (such as keeping the product under conditions of high temperature and humidity, near insect repellents such as naphthalene or harmful drugs, etc.), improper maintenance, etc.
  - Any defect that occurs due to exhausted batteries, etc.
  - Any defect that occurs due to sand, mud, water etc. entering the inside of the product casing.
- Olympus's sole liability under this Warranty shall be limited to repairing or replacing the product. Any liability under the Warranty for indirect or consequential loss or damage of any kind incurred or suffered by the customer due to a defect of the product, and in particular any loss or damage caused to any lenses, films, other equipment or accessories used with the product or for any loss resulting from a delay in repair or loss of data, is excluded. Compelling regulations by law remain unaffected by this.

## For customers in Asia

### Provisions of warranty

1. If this product proves to be defective, although it has been used properly (in accordance with the written Handling Care and Operating instructions supplied with it), during a period of up to one year from the date of purchase this product will be repaired, or at Olympus's option replaced, free of charge. To claim under warranty the customer must take the product and this Warranty certificate before the end of the one year warranty period to the dealer where the product was purchased or any Olympus authorized service station listed in the instructions and request the necessary repairs.
2. The customer shall transport the product to the dealer or Olympus authorized service station at his own risk and shall be responsible for any costs incurred in transporting the product.
3. This warranty does not cover the following and the customer will be required to pay repair charge, even for defects occurring within the one year period referred to above.
  - a. Any defect that occurs due to mishandling (such as an operation performed that is not mentioned in the Handling Care or other sections of the instructions, etc.)
  - b. Any defect that occurs due to repair, modification, cleaning, etc. performed by anyone other than Olympus or an Olympus authorized service station.
  - c. Any defect or damage that occurs due to transport, a fall, shock, etc. after purchase of the product.
  - d. Any defect or damage that occurs due to fire, earthquake, flood damage, thunderbolt, other natural disasters, environmental pollution and irregular voltage sources.
  - e. Any defect that occurs due to careless or improper storage (such as keeping the product under conditions of high temperature and humidity, near insect repellents such as naphthalene or harmful drugs, etc.), improper maintenance, etc.
  - f. Any defect that occurs due to exhausted batteries, etc.
  - g. Any defect that occurs due to sand, mud, etc. entering the inside of the product casing.
  - h. When this Warranty Certificate is not returned with the product.
  - i. When any alterations whatsoever are made to the Warranty Certificate regarding the year, month and date of purchase, the customer's name, the dealer's name, and the serial number.
  - j. When proof of purchase is not presented with this Warranty Certificate.
4. This Warranty applies to the product only; the Warranty does not apply to any other accessory equipment, such as the case, strap, lens cap, batteries and battery chargers.
5. Olympus' sole liability under this warranty shall be limited to repairing or replacing the product and any liability for indirect or consequential loss or damage of any kind incurred or suffered by the customer due to a defect in the product, and in particular any loss or damage caused to any film or lenses or other equipment or accessories used with the product or for any loss resulting from delay in repair, is excluded.

### For customers in Thailand

This telecommunication equipment is in compliance with NTC requirements.

### For customer in Singapore

Complies with IDA Standards DB104634
--

### Notes;

1. This Warranty is in addition to and does not affect the customer's statutory right.
2. If you have any queries regarding this Warranty, call any of the Olympus authorized service stations listed in the instructions.

### Notes regarding warranty maintenance

1. This Warranty will only be valid if the Warranty Certificate is duly completed by Olympus or the dealer. Make sure that your name, the name of the dealer, the serial number and the year, month and date of purchase are all completed.
  2. Since this Warranty Certificate will not be re-issued, keep it in a safe place.
  3. Any request for repair by a customer in same country where the product was purchased shall be subject to the terms of the warranty issued by the Olympus distributor in that country. Where the local Olympus distributor does not issue a separate warranty or where the customer is not in the country where the product was purchased the terms of this worldwide warranty shall apply.
  4. Where applicable, this Warranty is valid only in the country the product was purchased. The Olympus authorized service stations listed in this Warranty will gladly honor it.
- \* Please refer to the appended list for the authorized international Olympus service network.

## Disclaimer of Warranty

Olympus makes no representations or warranties, either expressed or implied, by or concerning any content if these written materials or software, and in no event shall be liable for any implied warranty of merchantability or fitness for any particular purpose or for any consequential, incidental or indirect damages (including but not limited to damages for loss of business profits, business interruption and loss of business information) arising from the use of inability to use these written materials or software. Some states do not allow the exclusion or limitation of liability for consequential or incidental damages, so the above limitations may not apply to you.

## Trademarks

- Microsoft and Windows are registered trademarks of Microsoft Corporation.
- Macintosh is a trademark of Apple Inc.
- microSDXC logo is a trademark of SD-3C, LLC.



- Wi-Fi is a registered trademark of the Wi-Fi Alliance.

- The Wi-Fi CERTIFIED logo is a certification mark of the Wi-Fi Alliance.



- All other company and product names are registered trademarks and/or trademarks of their respective owners.

THIS PRODUCT IS LICENSED UNDER THE AVC PATENT PORTFOLIO LICENSE FOR THE PERSONAL AND NONCOMMERCIAL USE OF A CONSUMER TO (i) ENCODE VIDEO IN COMPLIANCE WITH THE AVC STANDARD ("AVC VIDEO") AND/OR (ii) DECODE AVC VIDEO THAT WAS ENCODED BY A CONSUMER ENGAGED IN A PERSONAL AND NON-COMMERCIAL ACTIVITY AND/OR WAS OBTAINED FROM A VIDEO PROVIDER LICENSED TO PROVIDE AVC VIDEO. NO LICENSE IS GRANTED OR SHALL BE IMPLIED FOR ANY OTHER USE. ADDITIONAL INFORMATION MAY BE OBTAINED FROM MPEG LA, L.L.C. SEE [HTTP://WWW.MPEGLA.COM](http://WWW.MPEGLA.COM)

The software in this camera may include third party software. Any third party software is subject to the terms and conditions, imposed by the owners or licensors of that software, under which software is provided to you.

Those terms and other third party software notices, if any, may be found in the software notice PDF file stored within the accompanying CD-ROM or at

<http://www.olympus.co.jp/en/support/imshow/digicamera/download/notice/notice.cfm>

- The standards for camera file systems referred to in this manual are the "Design rule for Camera File system/ DCF" standards stipulated by the Japan Electronics and Information Technology Industries Association (JEITA).

# Specifications

## Camera

<b>Product type</b>	: Digital camera (for shooting and displaying)
<b>Recording system</b>	
<b>Still pictures</b>	: Digital recording, JPEG (in accordance with Design rule for Camera File system (DCF))
<b>Applicable standards</b>	: Exif 2.3, PRINT Image Matching III
<b>Sound with still pictures</b>	: Wave format
<b>Movie</b>	: MOV H.264 linear PCM
<b>Memory</b>	: microSD/microSDHC/microSDXC (supports UHS-I)
<b>Lens</b>	: Olympus lens 1.58 mm, f2.0 (Equivalent to 13.9 mm on a 35 mm film)
<b>Photometric system</b>	: Digital ESP metering, spot metering system
<b>Shutter speed</b>	: 1/2 to 1/24000 sec.
<b>Shooting range</b>	: 0.2 m (0.7 ft.) to ∞
<b>Monitor</b>	: 1.5" TFT color LCD display, 115,200 dots
<b>Connector</b>	: Micro-USB connector/HDMI micro connector (type D)
<b>Automatic calendar system</b>	: 2000 up to 2099
<b>Water resistance</b>	
<b>Type</b>	: Equivalent to IEC 60529 IPX8 (under OLYMPUS test conditions), available in 30 m (98.4 ft.) deep water
<b>Meaning</b>	: Camera can normally be used under water at a specified water pressure.
<b>Dust resistance</b>	: IEC 60529 IP6X (under OLYMPUS test conditions)

<b>Wi-Fi standard</b>	: IEEE802.11b/g/n
<b>GPS</b>	
<b>Reception frequency</b>	: 1575.42 MHz (GPS/ Quasi-Zenith Satellites System) 1598.0625 MHz to 1605.3750 MHz (GLONASS)
<b>Geodetic system</b>	: WGS84
<b>Operating environment</b>	
<b>Temperature</b>	: - 10 °C to 40 °C (14 °F to 104 °F) (operation)/ - 20 °C to 60 °C (- 4 °F to 140 °F) (storage)
<b>Humidity</b>	: 30% - 90% (operation)/10% - 90% (storage)
<b>Power supply</b>	: One Olympus lithium ion battery (LI-92B) or USB-AC adapter (F-5AC)
<b>Dimensions</b>	: 35 mm (W) × 56.5 mm (H) × 93.2 mm (D) (1.4 × 2.2 × 3.7 in.) (excluding protrusions)
<b>Weight</b>	: 180 g (6.3 oz) (including battery and card)

### Lithium ion battery (LI-92B)

<b>Product type</b>	: Lithium ion rechargeable battery
<b>Model No.</b>	: LI-92B
<b>Standard voltage</b>	: DC 3.6 V
<b>Standard capacity</b>	: 1350 mAh
<b>Battery life</b>	: Approx. 300 full charges (varies on usage)
<b>Operating environment</b>	
<b>Temperature</b>	: 0 °C to 40 °C (32 °F to 104 °F) (charging)

### USB-AC adapter (F-5AC)

<b>Model No.</b>	: F-5AC-1/F-5AC-2
<b>Power requirements</b>	: AC 100 to 240 V (50/60 Hz)
<b>Output</b>	: DC 5 V, 1500 mA
<b>Operating environment</b>	
<b>Temperature</b>	: 0 °C to 40 °C (32 °F to 104 °F) (operation)/ - 20 °C to 60 °C (- 4 °F to 140 °F) (storage)

Design and specifications subject to change without notice.  
Please visit our website for the latest specification.

HDMI, the HDMI Logo and High-Definition Multimedia Interface are trademarks or registered trademarks of HDMI Licensing, LLC.

**HDMI**™  
HIGH-DEFINITION MULTIMEDIA INTERFACE

**OLYMPUS KOREA CO., LTD.**

8F Olympus Tower A, 446, Bongeunsa-ro, Gangnam-gu, Seoul, Korea. 135-509  
<http://www.olympus.co.kr> Tel. 1544-3200

**OLYMPUS (MALAYSIA) Sdn Bhd**

10-8, Menara 1 MK, Kompleks '1 Mont Kiara', No.1, Jalan Kiara, Mont Kiara, 50480  
Kuala Lumpur, Malaysia.  
Tel:+603-6411 0000/Fax:+603-6411 0003  
E-mail: [service.oml@olympus-ap.com](mailto:service.oml@olympus-ap.com)  
<http://www.olympus.com.my>

**OLYMPUS (Thailand) CO., LTD.**

23/112 Sorachai Building, 27th Floor, Soi Sukhumvit 63 (Ekamai)  
Sukhumvit road Klongton Nua, Wattana, Bangkok 10110 Thailand  
Tel: 662 787 8200

# OLYMPUS

<http://www.olympus.com/>

## OLYMPUS AMERICA INC.

3500 Corporate Parkway, P.O. Box 610, Center Valley, PA 18034-0610, U.S.A. Tel. 484-896-5000

### Technical Support (U.S.A. / Canada)

24/7 online automated help:

<http://www.olympusamerica.com/support>

Phone customer support:

Tel. 1-800-260-1625 (Toll-free)

Our phone customer support is available from 9 am to 9 pm (Monday to Friday) ET

<http://olympusamerica.com/contactus>

Olympus software updates can be obtained at:

<http://www.olympusamerica.com/digital>

## OLYMPUS EUROPA SE & CO. KG

Premises: Consumer Product Division  
Wendenstrasse 14-18, 20097  
Hamburg, Germany

Tel: +49 40-23 77 3-0 / Fax: +49 40-23 07 61

Goods delivery: Modul H, Willi-Bleicher Str. 36,  
52353 Düren, Germany

Letters: Postfach 10 49 08, 20034 Hamburg,  
Germany

### European Technical Customer Support:

Please visit our homepage <http://www.olympus-europa.com> or call our TOLL FREE NUMBER\* :  
**00800 - 67 10 83 00**

for Austria, Belgium, Czech Republic, Denmark, Finland, France, Germany, Luxemburg,  
Netherlands, Norway, Poland, Portugal, Russia, Spain, Sweden, Switzerland, United Kingdom.

\* Please note some (mobile) phone services / provider do not permit access or request an  
additional prefix to +800 numbers.

For all not listed European Countries and in case that you can't get connected to the above mentioned number,  
please make use of the following CHARGED NUMBERS **+49 40 - 237 73 899**

## OLYMPUS (CHINA) CO., LTD.

Customer Support: 400-650-0303 Homepage: <http://www.olympus-imaging.cn>

### Customer Service Center:

A8F, Ping An International Financial Center, No. 1-3,  
Xinyuan South Road, Chaoyang District, Beijing  
Zip: 100027

10F, K, Wah Centre, 1010 Huaihai Road(M),  
Xuhui District, Shanghai  
Zip: 200031

## OLYMPUS HONG KONG AND CHINA LIMITED

Digital Camera Repair Centre  
L4207, Office Tower, Langham Place, 8 Argyle Street, Mongkok, Kowloon, Hong Kong  
Customer Hotline: +852-2376-2150 Fax: +852-2375-0630

E-mail: [cs.ohc@olympus-ap.com](mailto:cs.ohc@olympus-ap.com)

<http://www.olympus.com.hk>