

OptiPlex 5400

Service Manual

Notes, cautions, and warnings

 **NOTE:** A NOTE indicates important information that helps you make better use of your product.

 **CAUTION:** A CAUTION indicates either potential damage to hardware or loss of data and tells you how to avoid the problem.

 **WARNING:** A WARNING indicates a potential for property damage, personal injury, or death.

Chapter 1: Working inside your computer	6
Safety instructions.....	6
Before working inside your computer.....	6
Safety precautions.....	7
Electrostatic discharge—ESD protection.....	7
ESD field service kit	8
Transporting sensitive components.....	9
After working inside your computer.....	9
BitLocker.....	9
Chapter 2: Removing and installing components	10
Recommended tools.....	10
Screw list.....	10
Major components of OptiPlex 5400 All-in-One.....	12
Stand.....	13
Removing the fixed stand.....	13
Installing the fixed stand.....	13
Removing the height adjustable stand.....	14
Installing the height adjustable stand.....	15
Cable cover—optional.....	16
Removing the cable cover.....	16
Installing the cable cover.....	18
Back cover.....	19
Removing the back cover.....	19
Installing the back cover.....	21
Hard drive.....	23
Removing the hard drive.....	23
Installing the hard drive.....	24
Memory modules.....	25
Removing the memory modules.....	25
Installing the memory modules.....	26
System-board shield.....	28
Removing the system-board shield.....	28
Installing the system-board shield.....	28
Solid-state drive.....	29
Removing the M.2 2230 solid-state drive-slot 1.....	29
Installing the M.2 2230 solid-state drive-slot 1.....	30
Removing the M.2 2280 solid-state drive-slot 1.....	31
Installing the M.2 2280 solid-state drive-slot 1.....	32
Removing the M.2 2230 solid-state drive-slot 2.....	33
Installing the M.2 2230 solid-state drive-slot 2.....	34
Removing the M.2 2280 solid-state drive-slot 2.....	35
Installing the M.2 2280 solid-state drive-slot 2.....	36
System fan.....	37











Removing the system fan—35 W.....	37
Installing the system fan—35 W.....	38
Removing the system fan—65 W.....	39
Installing the system fan—65 W.....	40
Coin-cell battery.....	41
Removing the coin-cell battery.....	41
Installing the coin-cell battery.....	42
Wireless card.....	43
Removing the wireless card.....	43
Installing the wireless card.....	44
Camera assembly.....	46
Removing the camera assembly.....	46
Installing the camera assembly.....	47
Bottom cover.....	48
Removing the bottom cover.....	48
Installing the bottom cover.....	49
Power-supply unit.....	50
Removing the power-supply unit (PSU).....	50
Installing the power-supply unit (PSU).....	52
Power-supply fan.....	54
Removing the PSU fan.....	54
Installing the PSU fan.....	55
Heat sink.....	56
Removing the heat sink—35 W.....	56
Installing the heat sink—35 W.....	57
Removing the heat sink—65 W.....	58
Installing the heat sink—65 W.....	59
Processor.....	60
Removing the processor.....	60
Installing the processor.....	61
Rear-I/O bracket.....	63
Removing the rear-I/O bracket.....	63
Installing the rear-I/O bracket.....	64
System board.....	65
Removing the system board.....	65
Installing the system board.....	67
Speakers.....	70
Removing the speakers.....	70
Installing the speakers.....	71
Power-button board.....	72
Removing the power-button board.....	72
Installing the power-button board.....	73
Microphones.....	74
Removing the microphones.....	74
Installing the microphones.....	76
Side I/O-board.....	77
Removing the side I/O-board.....	77
Installing the side I/O-board.....	78
Audio board.....	80
Removing the audio board.....	80

Installing the audio board.....	80
Antenna modules.....	81
Removing the antenna modules.....	81
Installing the antenna modules.....	82
Display panel.....	83
Removing the display panel.....	83
Installing the display panel.....	85
Middle frame.....	87
Removing the middle frame.....	87
Installing the middle frame.....	88
Chapter 3: Drivers and downloads.....	90
Chapter 4: BIOS setup.....	91
Entering BIOS setup program.....	91
Navigation keys.....	91
One time boot menu.....	91
System setup options.....	92
Updating the BIOS.....	100
Updating the BIOS in Windows.....	100
Updating the BIOS in Linux and Ubuntu.....	100
Updating the BIOS using the USB drive in Windows.....	101
Updating the BIOS from the F12 One-Time boot menu.....	101
System and setup password.....	102
Assigning a system setup password.....	102
Deleting or changing an existing system setup password.....	103
Clearing CMOS settings.....	103
Clearing BIOS (System Setup) and System passwords.....	103
Chapter 5: Troubleshooting.....	104
Dell SupportAssist Pre-boot System Performance Check diagnostics.....	104
Running the SupportAssist Pre-Boot System Performance Check.....	104
Display built-in self test.....	104
Power-Supply Unit Built-in Self-Test	105
System-diagnostic lights.....	105
Recovering the operating system.....	106
Real Time Clock—RTC reset.....	107
Backup media and recovery options.....	107
WiFi power cycle.....	107
Chapter 6: Getting help and contacting Dell.....	108

Working inside your computer

Safety instructions

Use the following safety guidelines to protect your computer from potential damage and to ensure your personal safety. Unless otherwise noted, each procedure included in this document assumes that you have read the safety information that shipped with your computer.

-  **WARNING:** Before working inside your computer, read the safety information that is shipped with your computer. For more safety best practices, see the Regulatory Compliance home page at www.dell.com/regulatory_compliance.
-  **WARNING:** Disconnect your computer from all power sources before opening the computer cover or panels. After you finish working inside the computer, replace all covers, panels, and screws before connecting your computer to an electrical outlet.
-  **CAUTION:** To avoid damaging the computer, ensure that the work surface is flat, dry, and clean.
-  **CAUTION:** To avoid damaging the components and cards, handle them by their edges, and avoid touching the pins and the contacts.
-  **CAUTION:** You should only perform troubleshooting and repairs as authorized or directed by the Dell technical assistance team. Damage due to servicing that is not authorized by Dell is not covered by your warranty. See the safety instructions that is shipped with the product or at www.dell.com/regulatory_compliance.
-  **CAUTION:** Before touching anything inside your computer, ground yourself by touching an unpainted metal surface, such as the metal at the back of the computer. While you work, periodically touch an unpainted metal surface to dissipate static electricity which could harm internal components.
-  **CAUTION:** When you disconnect a cable, pull it by its connector or its pull tab, not the cable itself. Some cables have connectors with locking tabs or thumbscrews that you must disengage before disconnecting the cable. When disconnecting cables, keep them evenly aligned to avoid bending the connector pins. When connecting cables, ensure that the ports and the connectors are correctly oriented and aligned.
-  **CAUTION:** Press and eject any installed card from the media-card reader.
-  **CAUTION:** Exercise caution when handling Lithium-ion batteries in laptops. Swollen batteries should not be used and should be replaced and disposed properly.
-  **NOTE:** The color of your computer and certain components may appear differently than shown in this document.

Before working inside your computer

-  **NOTE:** The images in this document may differ from your computer depending on the configuration you ordered.

Before you begin

Steps

1. Save and close all open files and exit all open applications.
2. Shut down your computer. Click **Start** >  **Power** > **Shut down**.

 **NOTE:** If you are using a different operating system, see the documentation of your operating system for shut-down instructions.

3. Disconnect your computer and all attached devices from their electrical outlets.
4. Disconnect all attached network devices and peripherals, such as keyboard, mouse, and monitor from your computer.
5. Remove any media card and optical disc from your computer, if applicable.
6. After the computer is unplugged, press and hold the power button for 5 seconds to ground the system board.

 **CAUTION:** Place the computer on a flat, soft, and clean surface to avoid scratches on the display.

7. Place the computer face down.

Safety precautions

The safety precautions chapter details the primary steps to be taken before performing any disassembly instructions.

Observe the following safety precautions before you perform any installation or break/fix procedures involving disassembly or reassembly:

- Turn off the system and all attached peripherals.
- Disconnect the system and all attached peripherals from AC power.
- Disconnect all network cables, telephone, and telecommunications lines from the system.
- Use an ESD field service kit when working inside any desktop to avoid electrostatic discharge (ESD) damage.
- After removing any system component, carefully place the removed component on an anti-static mat.
- Wear shoes with non-conductive rubber soles to reduce the chance of getting electrocuted.

Standby power

Dell products with standby power must be unplugged before you open the case. Systems that incorporate standby power are essentially powered while turned off. The internal power enables the system to be remotely turned on (wake on LAN) and suspended into a sleep mode and has other advanced power management features.

Unplugging, pressing and holding the power button for 15 seconds should discharge residual power in the system board.

Bonding

Bonding is a method for connecting two or more grounding conductors to the same electrical potential. This is done through the use of a field service electrostatic discharge (ESD) kit. When connecting a bonding wire, ensure that it is connected to bare metal and never to a painted or non-metal surface. The wrist strap should be secure and in full contact with your skin, and ensure that you remove all jewelry such as watches, bracelets, or rings prior to bonding yourself and the equipment.

Electrostatic discharge—ESD protection

ESD is a major concern when you handle electronic components, especially sensitive components such as expansion cards, processors, memory DIMMs, and system boards. Very slight charges can damage circuits in ways that may not be obvious, such as intermittent problems or a shortened product life span. As the industry pushes for lower power requirements and increased density, ESD protection is an increasing concern.

Due to the increased density of semiconductors used in recent Dell products, the sensitivity to static damage is now higher than in previous Dell products. For this reason, some previously approved methods of handling parts are no longer applicable.

Two recognized types of ESD damage are catastrophic and intermittent failures.

- **Catastrophic** – Catastrophic failures represent approximately 20 percent of ESD-related failures. The damage causes an immediate and complete loss of device functionality. An example of catastrophic failure is a memory DIMM that has received a static shock and immediately generates a "No POST/No Video" symptom with a beep code emitted for missing or nonfunctional memory.
- **Intermittent** – Intermittent failures represent approximately 80 percent of ESD-related failures. The high rate of intermittent failures means that most of the time when damage occurs, it is not immediately recognizable. The DIMM receives a static shock, but the tracing is merely weakened and does not immediately produce outward symptoms related to

the damage. The weakened trace may take weeks or months to melt, and in the meantime may cause degradation of memory integrity, intermittent memory errors, etc.

The more difficult type of damage to recognize and troubleshoot is the intermittent (also called latent or "walking wounded") failure.

Perform the following steps to prevent ESD damage:

- Use a wired ESD wrist strap that is properly grounded. The use of wireless anti-static straps is no longer allowed; they do not provide adequate protection. Touching the chassis before handling parts does not ensure adequate ESD protection on parts with increased sensitivity to ESD damage.
- Handle all static-sensitive components in a static-safe area. If possible, use anti-static floor pads and workbench pads.
- When unpacking a static-sensitive component from its shipping carton, do not remove the component from the anti-static packing material until you are ready to install the component. Before unwrapping the anti-static packaging, ensure that you discharge static electricity from your body.
- Before transporting a static-sensitive component, place it in an anti-static container or packaging.

ESD field service kit

The unmonitored Field Service kit is the most commonly used service kit. Each Field Service kit includes three main components: anti-static mat, wrist strap, and bonding wire.

Components of an ESD field service kit

The components of an ESD field service kit are:

- **Anti-Static Mat** – The anti-static mat is dissipative and parts can be placed on it during service procedures. When using an anti-static mat, your wrist strap should be snug and the bonding wire should be connected to the mat and to any bare metal on the system being worked on. Once deployed properly, service parts can be removed from the ESD bag and placed directly on the mat. ESD-sensitive items are safe in your hand, on the ESD mat, in the system, or inside a bag.
- **Wrist Strap and Bonding Wire** – The wrist strap and bonding wire can be either directly connected between your wrist and bare metal on the hardware if the ESD mat is not required, or connected to the anti-static mat to protect hardware that is temporarily placed on the mat. The physical connection of the wrist strap and bonding wire between your skin, the ESD mat, and the hardware is known as bonding. Use only Field Service kits with a wrist strap, mat, and bonding wire. Never use wireless wrist straps. Always be aware that the internal wires of a wrist strap are prone to damage from normal wear and tear, and must be checked regularly with a wrist strap tester in order to avoid accidental ESD hardware damage. It is recommended to test the wrist strap and bonding wire at least once per week.
- **ESD Wrist Strap Tester** – The wires inside of an ESD strap are prone to damage over time. When using an unmonitored kit, it is a best practice to regularly test the strap prior to each service call, and at a minimum, test once per week. A wrist strap tester is the best method for doing this test. If you do not have your own wrist strap tester, check with your regional office to find out if they have one. To perform the test, plug the wrist-strap's bonding-wire into the tester while it is strapped to your wrist and push the button to test. A green LED is lit if the test is successful; a red LED is lit and an alarm sounds if the test fails.
- **Insulator Elements** – It is critical to keep ESD sensitive devices, such as plastic heat sink casings, away from internal parts that are insulators and often highly charged.
- **Working Environment** – Before deploying the ESD Field Service kit, assess the situation at the customer location. For example, deploying the kit for a server environment is different than for a desktop or portable environment. Servers are typically installed in a rack within a data center; desktops or portables are typically placed on office desks or cubicles. Always look for a large open flat work area that is free of clutter and large enough to deploy the ESD kit with additional space to accommodate the type of system that is being repaired. The workspace should also be free of insulators that can cause an ESD event. On the work area, insulators such as Styrofoam and other plastics should always be moved at least 12 inches or 30 centimeters away from sensitive parts before physically handling any hardware components.
- **ESD Packaging** – All ESD-sensitive devices must be shipped and received in static-safe packaging. Metal, static-shielded bags are preferred. However, you should always return the damaged part using the same ESD bag and packaging that the new part arrived in. The ESD bag should be folded over and taped shut and all the same foam packing material should be used in the original box that the new part arrived in. ESD-sensitive devices should be removed from packaging only at an ESD-protected work surface, and parts should never be placed on top of the ESD bag because only the inside of the bag is shielded. Always place parts in your hand, on the ESD mat, in the system, or inside an anti-static bag.
- **Transporting Sensitive Components** – When transporting ESD sensitive components such as replacement parts or parts to be returned to Dell, it is critical to place these parts in anti-static bags for safe transport.

ESD protection summary

It is recommended that all field service technicians use the traditional wired ESD grounding wrist strap and protective anti-static mat at all times when servicing Dell products. In addition, it is critical that technicians keep sensitive parts separate from all insulator parts while performing service and that they use anti-static bags for transporting sensitive components.

Transporting sensitive components

When transporting ESD sensitive components such as replacement parts or parts to be returned to Dell, it is critical to place these parts in anti-static bags for safe transport.

Lifting equipment

Adhere to the following guidelines when lifting heavy weight equipment:

 **CAUTION: Do not lift greater than 50 pounds. Always obtain additional resources or use a mechanical lifting device.**

1. Get a firm balanced footing. Keep your feet apart for a stable base, and point your toes out.
2. Tighten stomach muscles. Abdominal muscles support your spine when you lift, offsetting the force of the load.
3. Lift with your legs, not your back.
4. Keep the load close. The closer it is to your spine, the less force it exerts on your back.
5. Keep your back upright, whether lifting or setting down the load. Do not add the weight of your body to the load. Avoid twisting your body and back.
6. Follow the same techniques in reverse to set the load down.

After working inside your computer

About this task

 **CAUTION: Leaving stray or loose screws inside your computer may severely damage your computer.**

Steps

1. Replace all screws and ensure that no stray screws remain inside your computer.
2. Connect any external devices, peripherals, or cables you removed before working on your computer.
3. Replace any media cards, discs, or any other parts that you removed before working on your computer.
4. Connect your computer and all attached devices to their electrical outlets.
5. Turn on your computer.

BitLocker

 **CAUTION: If BitLocker is not suspended before updating the BIOS, the next time you reboot the system it will not recognize the BitLocker key. You will then be prompted to enter the recovery key to progress, and the system will ask for this on each reboot. If the recovery key is not known this can result in data loss or an unnecessary operating system reinstall. For more information about this subject, see Knowledge Article: [updating the BIOS on Dell systems with BitLocker enabled](#).**

The installation of the following components triggers BitLocker:

- Hard disk drive or solid state drive
- System board

Removing and installing components

NOTE: The images in this document may differ from your computer depending on the configuration you ordered.

Recommended tools

The procedures in this document may require the following tools:

- Phillips screwdriver #0
- Phillips screwdriver #1
- Phillips screwdriver #2
- Plastic scribe

Screw list

NOTE: When removing screws from a component, it is recommended to note the screw type, the quantity of screws, and then place them in a screw storage box. This is to ensure that the correct number of screws and correct screw type is restored when the component is replaced.

NOTE: Some computers have magnetic surfaces. Ensure that the screws are not left attached to such surfaces when replacing a component.

NOTE: Screw color may vary with the configuration ordered.

Table 1. Screw list























Component	Screw type	Quantity	Screw image
Cable cover—optional	M3x9	1	
System-board shield	M3x5	5	
Bottom cover	M3x5	4	
M.2 2230 solid-state drive	M2x2.5	1	
M.2 2280 solid-state drive	M2x2.5	1	
System fan	M3x5	3	
Wireless-card shield	M2x2.5	2	
Wireless card	M2x2.5	1	

Table 1. Screw list (continued)

Component	Screw type	Quantity	Screw image
Camera assembly	M3x5	2	
Camera door	M3x5	2	
Heat sink—35 W	Captive screws	5	
Heat sink—65 W	Captive screws	5	
Power-supply unit (PSU)	M3x5	1	
PSU fan	M3x5	2	
Rear-I/O bracket	M3x5	4	
System board	M3x5	9	
Speakers	M3 4+7.1xZN	6	
Power-button board	M3x5	1	
Microphones	M2x2.5	2	
Side I/O-board shield	M3x5	2	
Side-I/O board	M2.5x3.5	2	
Antenna modules	M2x2.5	2	
Display panel	M3x5	11 (for touch screen) 12 (for non-touch screen)	
Middle frame	M3x5	17	
Audio board	M3x5	1	

Major components of OptiPlex 5400 All-in-One

The following image shows the major components of OptiPlex 5400 All-in-One.

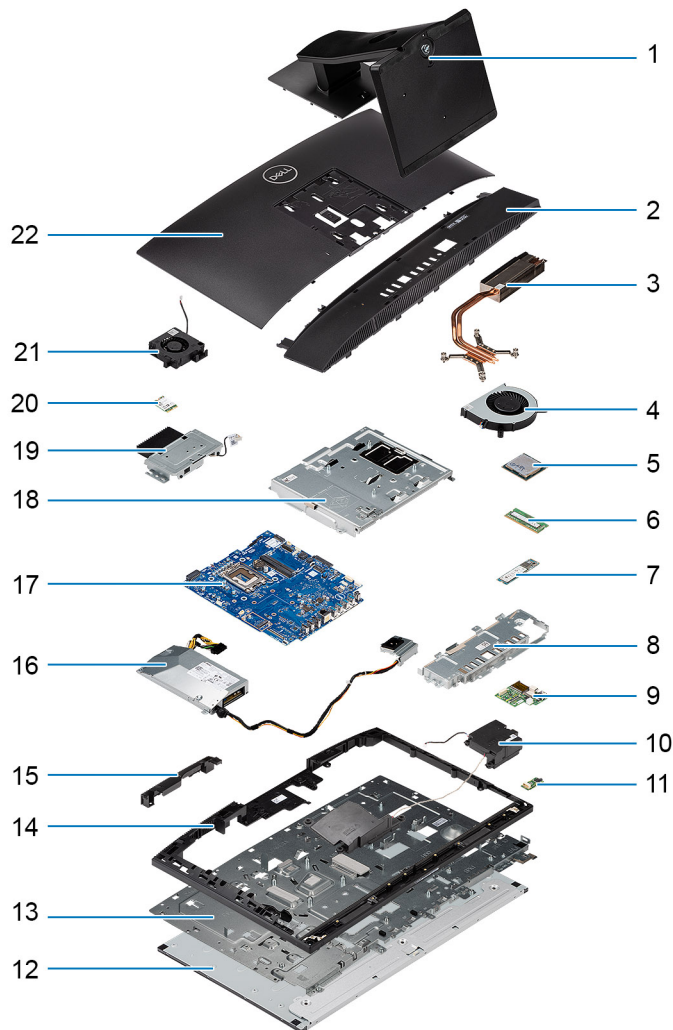

- | | |
|------------------------------------|-----------------------------|
| 1. Stand | 2. Bottom cover |
| 3. Heat sink | 4. System fan |
| 5. Processor | 6. Memory module |
| 7. M.2 2230/2280 solid-state drive | 8. Rear-I/O bracket |
| 9. Side-I/O board | 10. Speakers |
| 11. Audio board | 12. Display panel |
| 13. Display-assembly base | 14. Middle frame |
| 15. Camera-assembly door | 16. Power-supply unit (PSU) |
| 17. System board | 18. System-board shield |
| 19. Camera assembly | 20. Wireless card |
| 21. PSU fan | |

i NOTE: Dell provides a list of components and their part numbers for the original system configuration purchased. These parts are available according to warranty coverages purchased by the customer. Contact your Dell sales representative for purchase options.

Stand

Removing the fixed stand

Prerequisites

1. Follow the procedure in [Before working inside your computer](#).

CAUTION: When servicing the system, place it on an elevated, clean, and flat surface. Dell Technologies recommends removing the stand to avoid accidental damage to the system display during servicing.

About this task

The following image provides a visual representation of the fixed stand removal procedure.

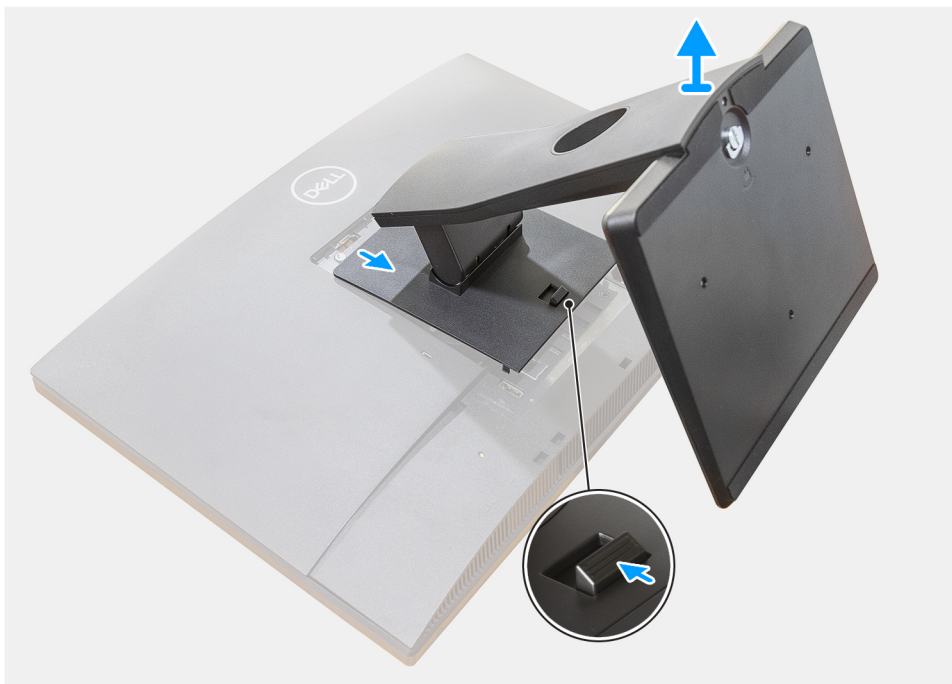

Steps

1. Press and slide the release button up.
2. Hold the button in the release position and lift the stand upward.
3. Slide the stand downward, to lift the stand off the back cover.

Installing the fixed stand

Prerequisites

If you are replacing a component, remove the existing component before performing the installation procedure.

About this task

The following image provides a visual representation of the fixed stand installation procedure.



Steps

Align and insert the hooks on the mounting bracket on the stand into the slots on the monitor, until you hear a click.

Next steps

1. Follow the procedure in [After working inside your computer](#).

Removing the height adjustable stand

Prerequisites

i **NOTE:** Follow the same procedure to remove the Height Adjustable Stand with Optical Disk Drive.

1. Follow the procedure in [Before working inside your computer](#).

⚠ CAUTION: When servicing the system, place it on an elevated, clean, and flat surface. Dell recommends removing the stand to avoid accidental damage to the system display during servicing.

About this task

The following image provides a visual representation of the height adjustable stand removal procedure.

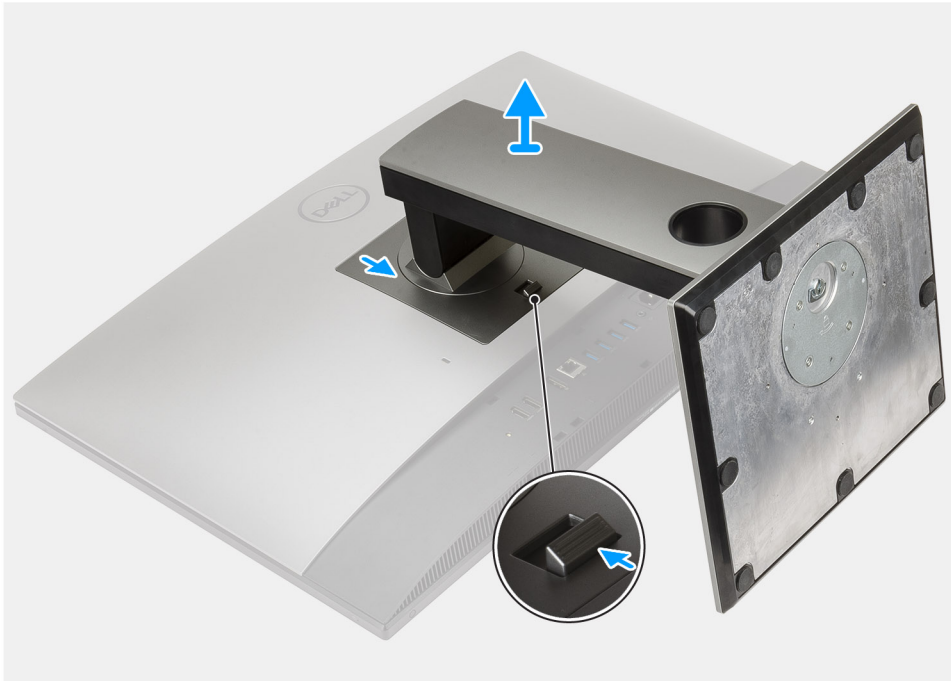

Steps

1. Press and slide the release button up.
2. Hold the button in the release position, and lift the stand upward.
3. Slide the stand downward, to lift the stand off the back cover.

Installing the height adjustable stand

Prerequisites

If you are replacing a component, remove the existing component before performing the installation procedure.

i **NOTE:** Follow the same procedure to install the Height Adjustable Stand with Optical Disk Drive.

About this task

The following image provides a visual representation of the height adjustable stand installation procedure.

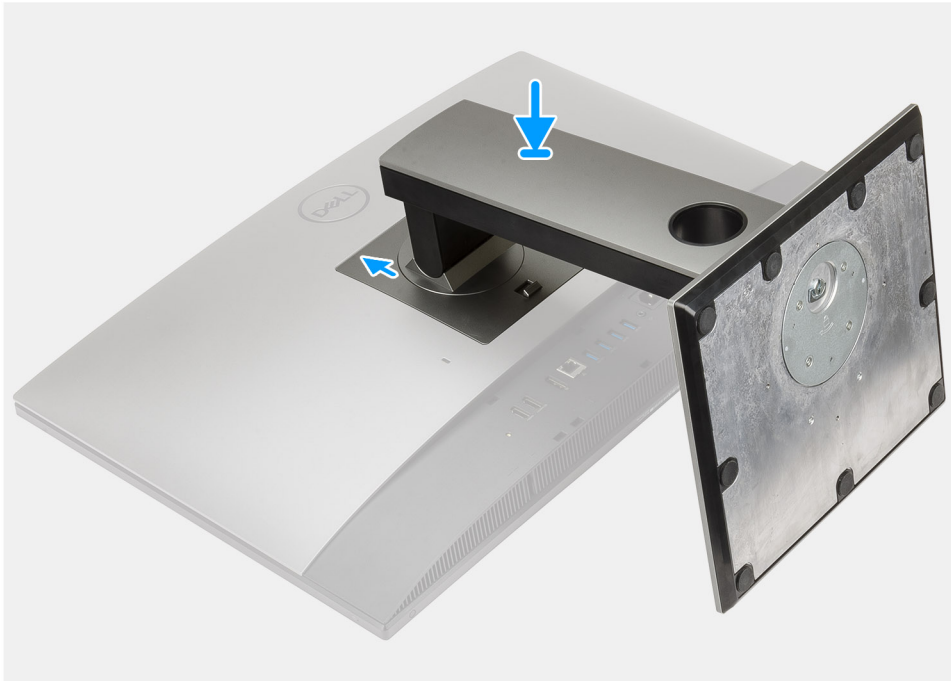

Steps

1. Align the tabs on the stand with the slots on the back cover.
2. Slide the stand upward until it clicks into place.

Next steps

1. Follow the procedure in [After working inside your computer](#).

Cable cover—optional

Removing the cable cover

Prerequisites

1. Follow the procedure in [Before working inside your computer](#).



CAUTION: When servicing the system, place it on an elevated, clean, and flat surface. It is recommended to remove the stand to avoid accidental damage to the system display during servicing.

2. Remove the [stand](#).

About this task

The following image provides a visual representation of the cable cover removal procedure.



1x
M3x5

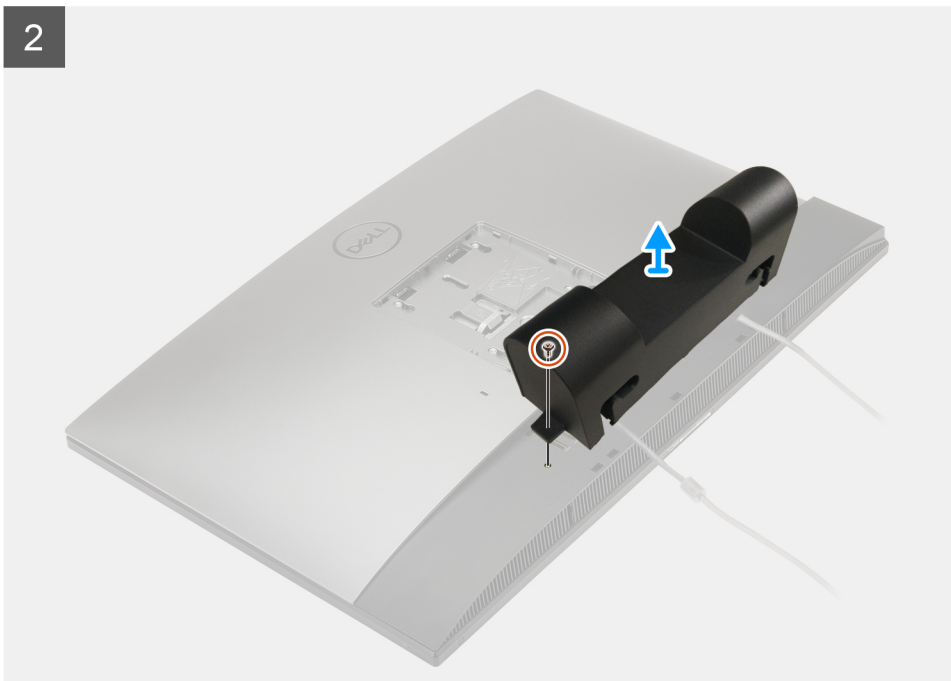
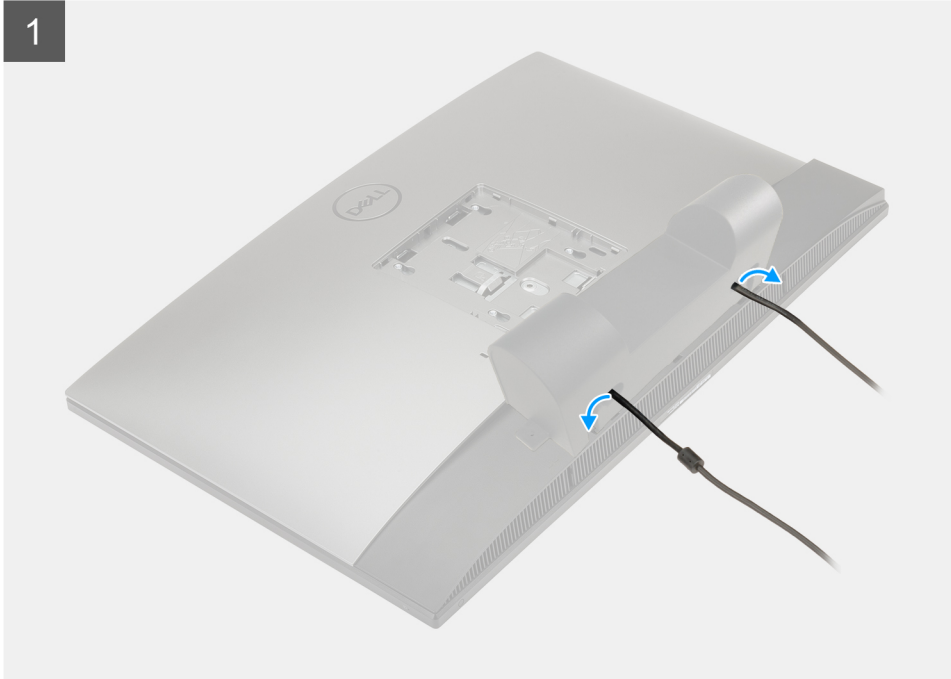

Steps

1. Unroute the power cable from the slots on the cable cover.
2. Remove the screw (M3x5) that secures the cable cover to the bottom cover.
3. Lift the cable cover from the bottom cover.

Installing the cable cover

Prerequisites

If you are replacing a component, remove the existing component before performing the installation procedure.

About this task

The following image provides a visual representation of the cable cover installation procedure:



1x
M3x5

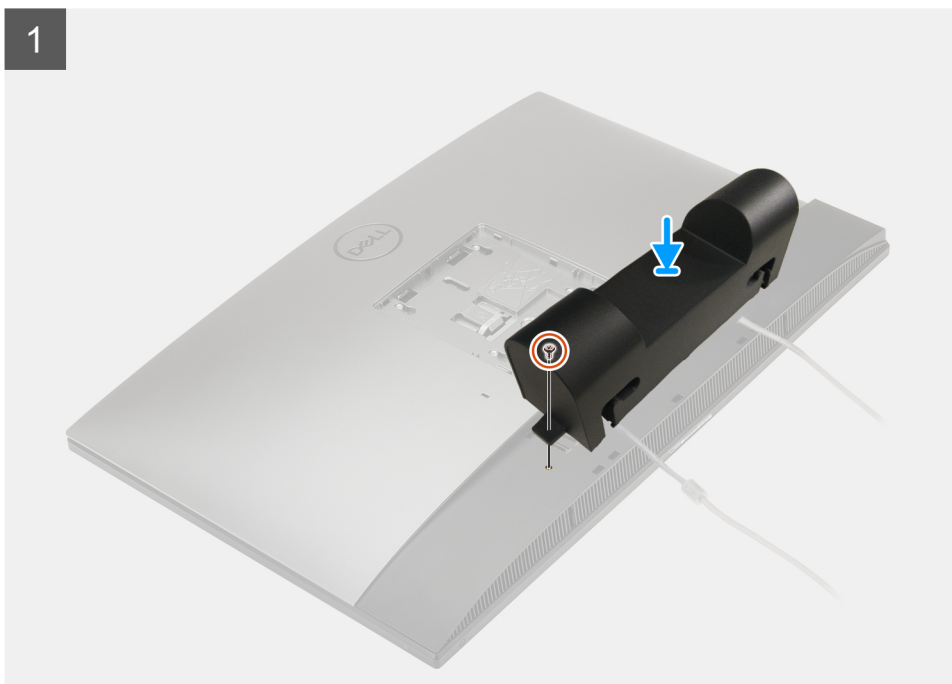

2

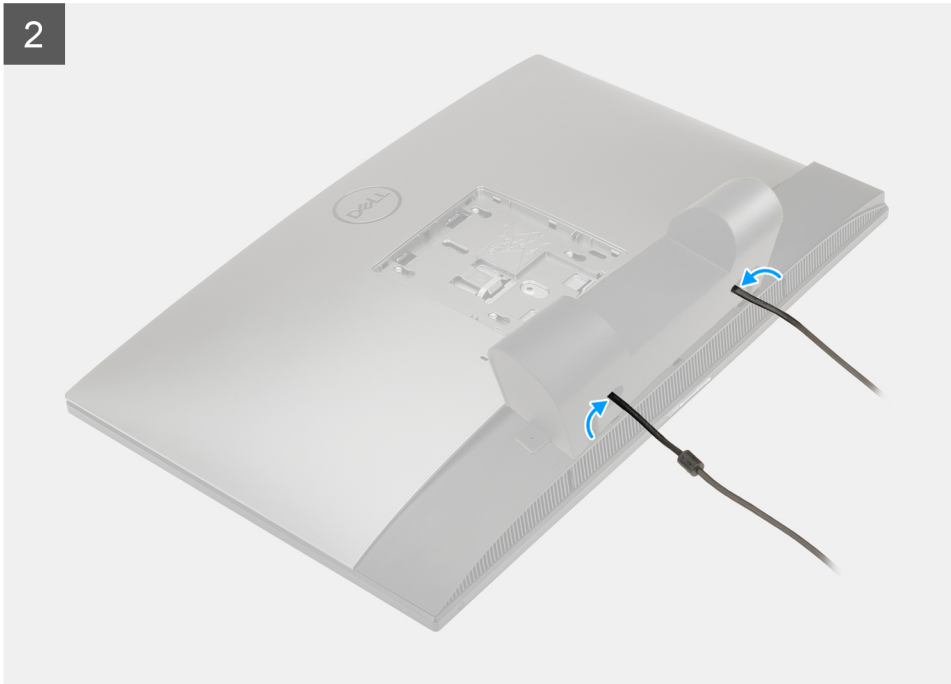

Steps

1. Route the power cable through the slots on the cable cover.
2. Align the screw hole on the cable cover with the screw hole on the bottom cover.
3. Replace the screw (M3x5) to secure the cable cover to the bottom cover.

Next steps

1. Install the [stand](#).
2. Follow the procedure in [After working inside your computer](#).

Back cover

Removing the back cover

Prerequisites

1. Follow the procedure in [Before working inside your computer](#).

 **CAUTION: When servicing the system, place it on an elevated, clean, and flat surface. It is recommended to remove the stand to avoid accidental damage to the system display during servicing.**

2. Remove the [stand](#).
3. Remove the [cable cover](#) (optional).

About this task

The following image provides a visual representation of the back cover removal procedure.

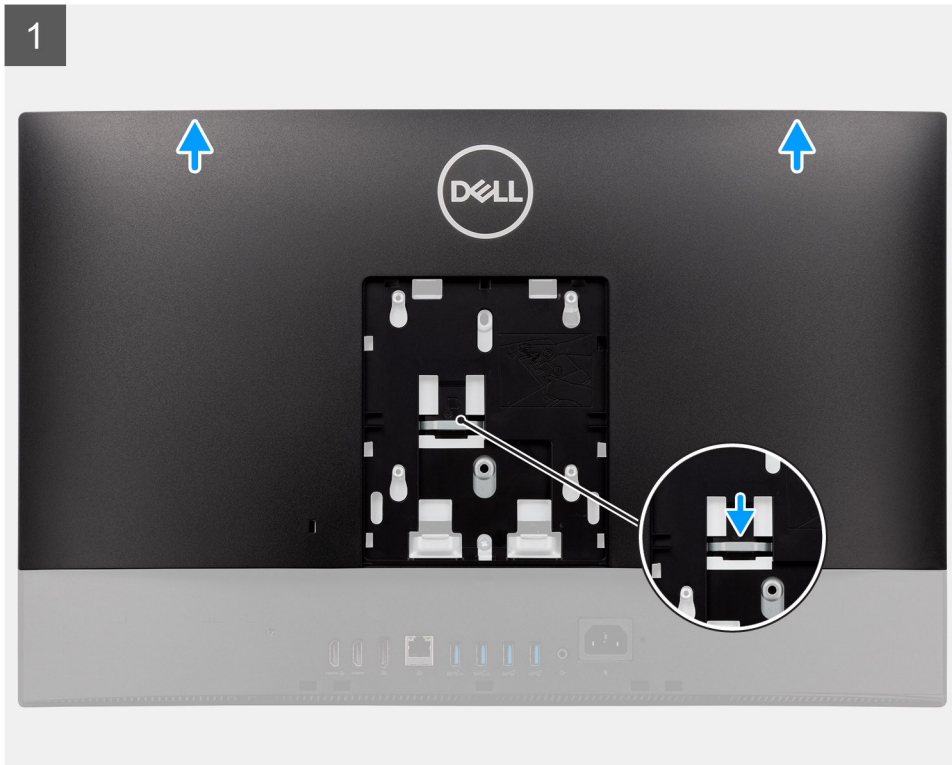

Steps

1. Press and hold the release tab on the back cover to release it from the latch on the system-board shield.
2. Slide the back cover up to release the tabs on the cover from the slots on the middle frame.
3. Lift the back cover and remove it from the system.

Installing the back cover

Prerequisites

If you are replacing a component, remove the existing component before performing the installation procedure.

About this task

The following image provides a visual representation of the back cover installation procedure.

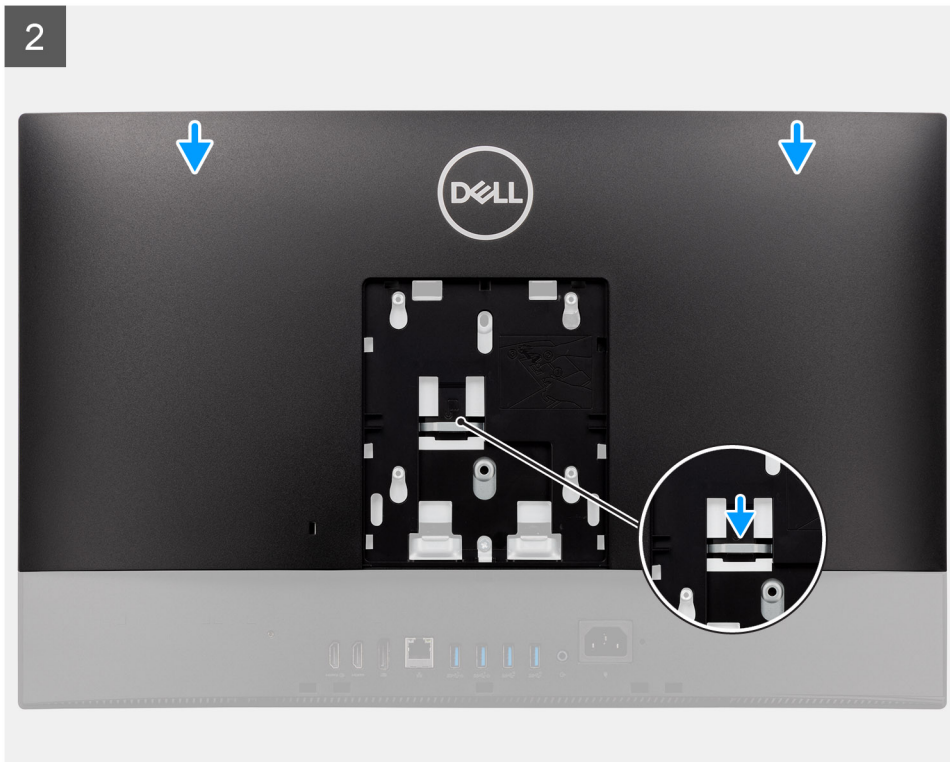

1

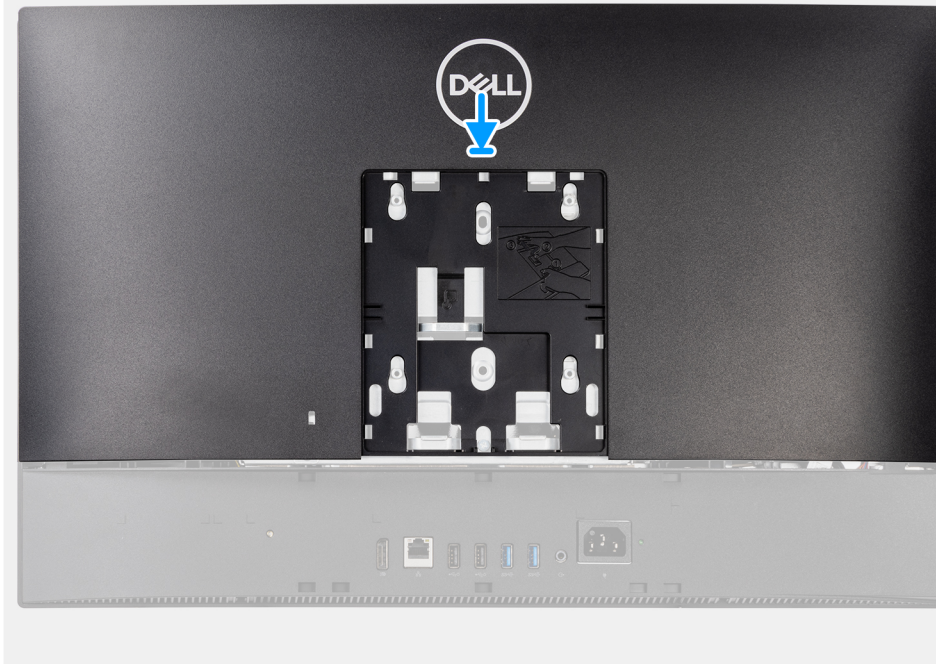

2

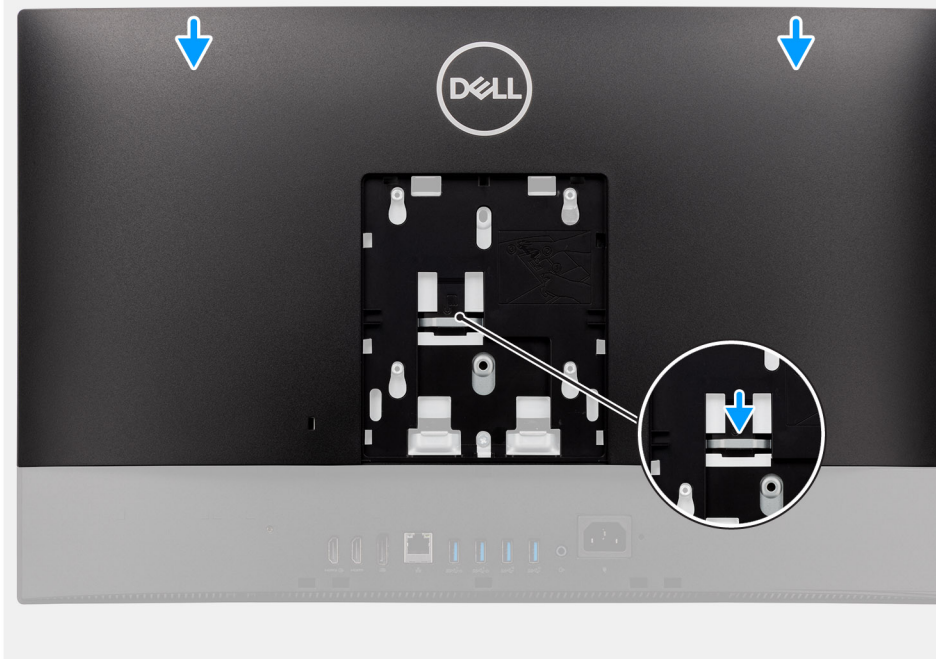

Steps

1. Place the back cover on the middle frame and system-board shield and align the tabs on the back cover with the slots on the middle frame.
2. Slide the back cover to lock the release tab under the latch on the system-board shield.

Next steps

1. Install the [cable cover](#) (optional).

2. Install the [stand](#).
3. Follow the procedure in [After working inside your computer](#).

Hard drive

Removing the hard drive

Prerequisites

1. Follow the procedure in [Before working inside your computer](#).
2. Remove the [stand](#).
3. Remove the [cable cover](#) (optional).
4. Remove the [back cover](#).

About this task

The following image indicates the location of the hard drive and provides a visual representation of the removal procedure.

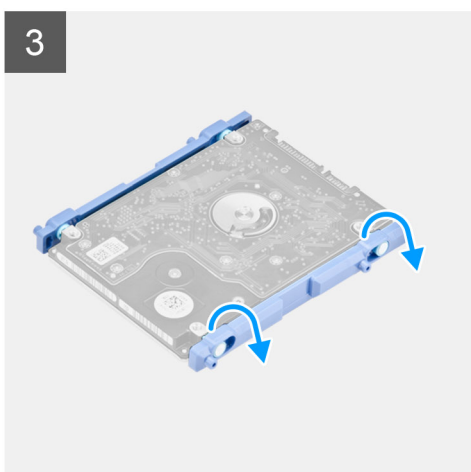
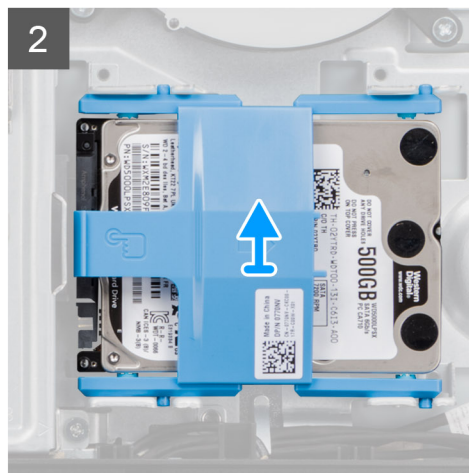
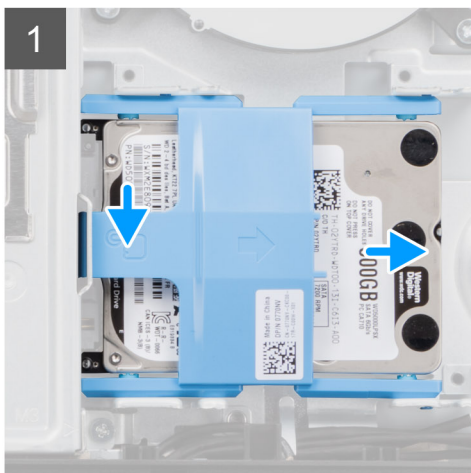
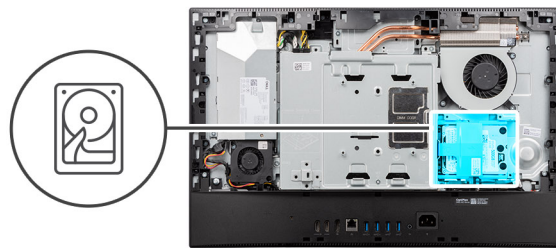

Steps

1. Press down the tab securing the hard-drive assembly to the system-board shield.
2. Slide and lift the hard-drive assembly from the slot on the display-assembly base.
3. Pry the tabs on hard-drive bracket from its slots on the hard drive.
4. Remove the hard drive from the hard-drive bracket.

Installing the hard drive

Prerequisites

If you are replacing a component, remove the existing component before performing the installation procedure.

About this task

The following image indicates the location of the hard drive and provides a visual representation of the installation procedure.

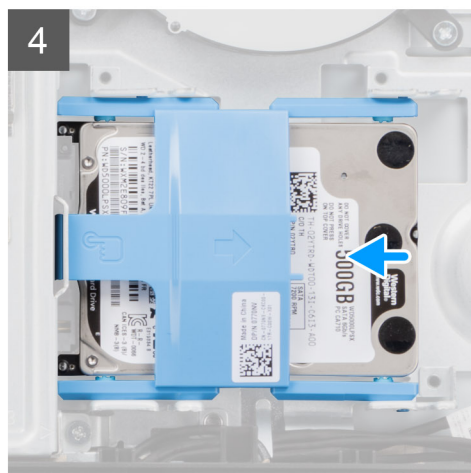
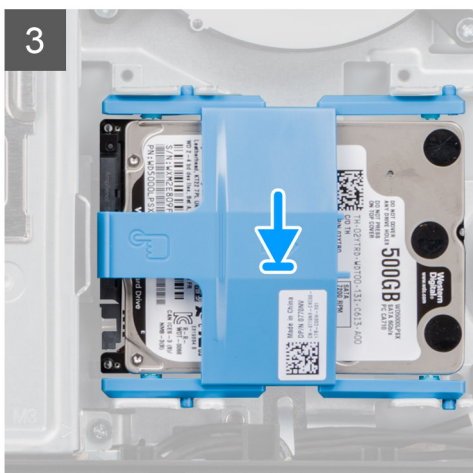
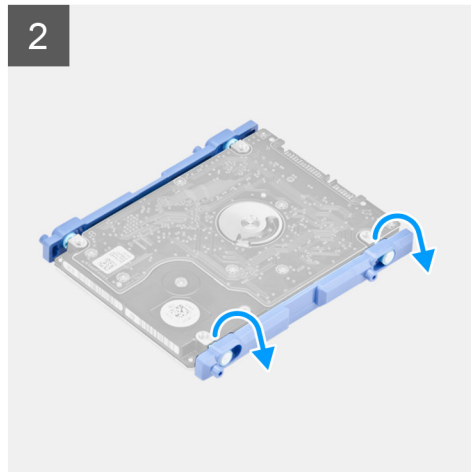
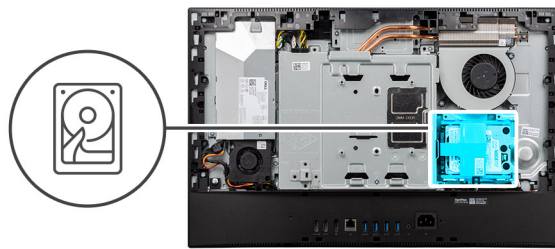

Steps

1. Align the tabs on the hard-drive bracket with the slots on the hard drive.
2. Flex the hard-drive bracket and replace the remaining tabs on the hard-drive bracket with the slots on the hard drive.
3. Place the hard-drive assembly into the slot and slide it to lock the hard-drive assembly on the display-assembly base.

Next steps

1. Install the [back cover](#).
2. Install the [cable cover](#) (optional).
3. Install the [stand](#).
4. Follow the procedure in [After working inside your computer](#).

Memory modules

Removing the memory modules

Prerequisites

1. Follow the procedure in [Before working inside your computer](#).
2. Remove the [stand](#).
3. Remove the [cable cover](#) (optional).
4. Remove the [back cover](#).

About this task

The following image indicates the location of the memory modules and provides a visual representation of the removal procedure.

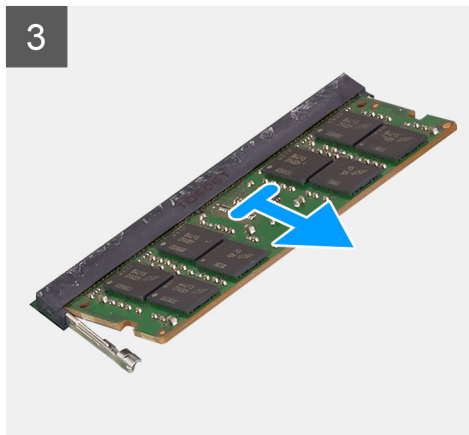
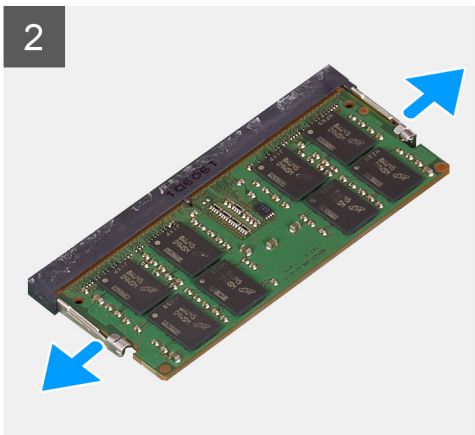
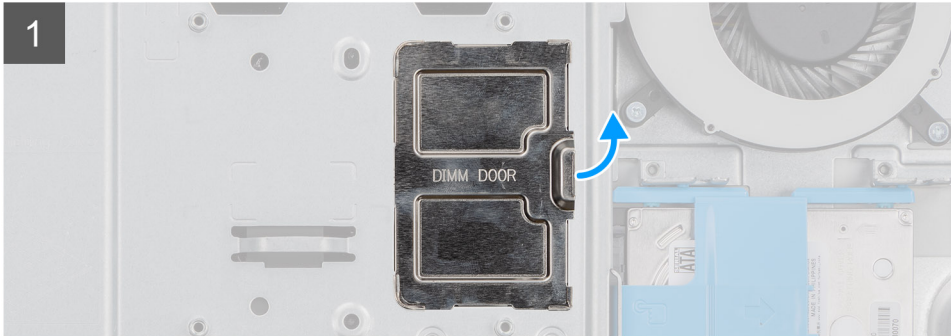
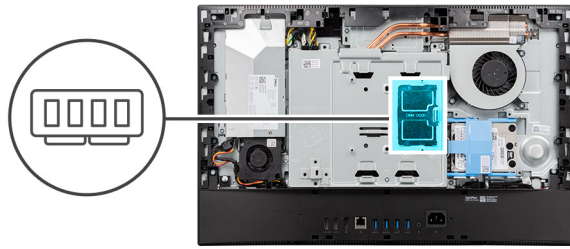

Steps

1. Pry and remove the DIMM door from the system-board shield.
2. Using your fingertips, spread apart the securing clips on the memory-module slot until the memory module pops up.
3. Slide and remove the memory module from the memory-module slot.

i **NOTE:** Repeat step 2 and 3 if there are two memory modules.

Installing the memory modules

Prerequisites

If you are replacing a component, remove the existing component before performing the installation procedure.

About this task

The following image indicates the location of the memory module and provides a visual representation of the installation procedure.

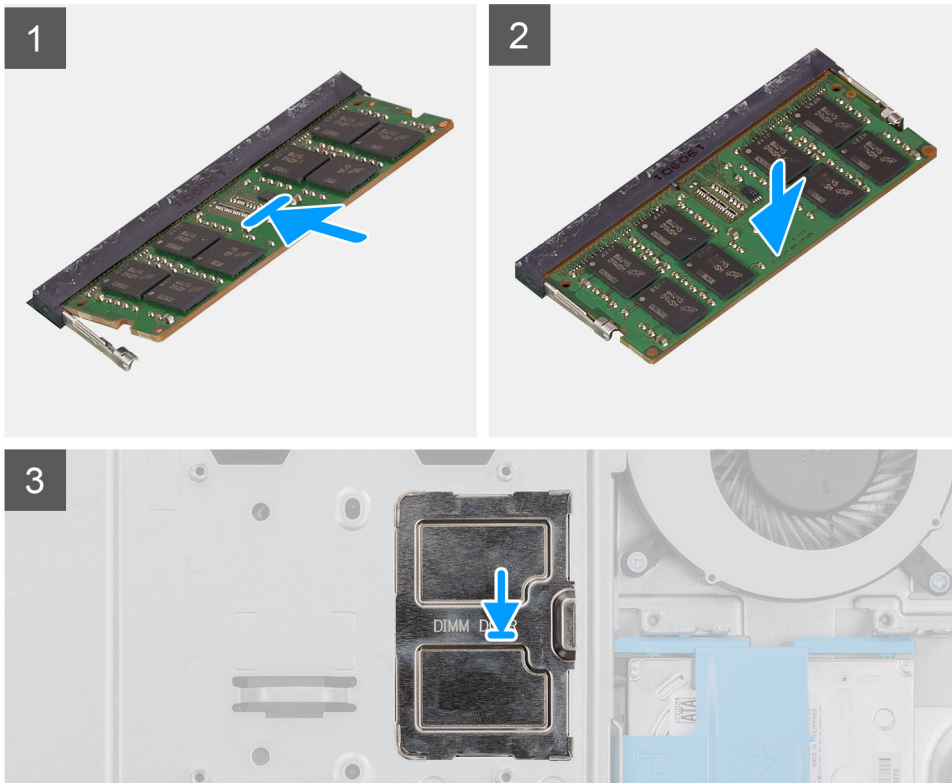
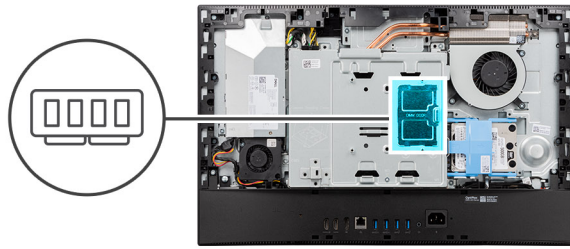

Steps

1. Align the notch on the memory module with the tab on the memory-module slot.
2. Slide the memory module firmly into the slot at an angle and press the memory module down until it clicks into place.
 - i** **NOTE:** If you do not hear the click, remove the memory module and reinstall it.
 - i** **NOTE:** Repeat step 1 and 2 if there are two memory modules.
3. Align the tabs on the DIMM door with the slots on the system-board shield and snap into place.

Next steps

1. Install the [back cover](#).
2. Install the [cable cover](#) (optional).
3. Install the [stand](#).
4. Follow the procedure in [After working inside your computer](#).

System-board shield

Removing the system-board shield

Prerequisites

1. Follow the procedure in [Before working inside your computer](#).
2. Remove the [stand](#).
3. Remove the [cable cover](#) (optional).
4. Remove the [back cover](#).

About this task

The following image indicates the location of the system-board shield and provides a visual representation of the removal procedure.



5x
M3x5

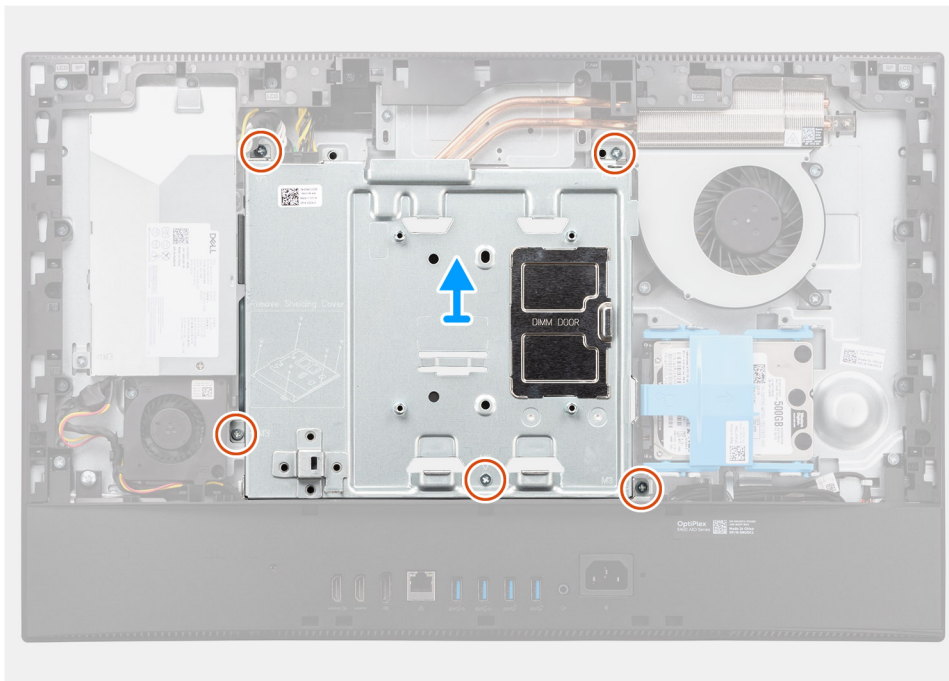
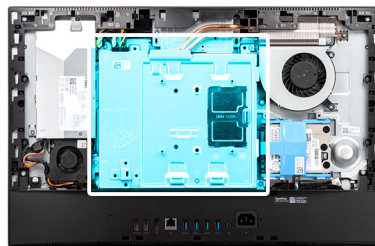

Steps

1. Remove the five screws (M3x5) that secure the system-board shield to the display-assembly base.
2. Lift the system-board shield off the display-assembly base.

Installing the system-board shield

Prerequisites

If you are replacing a component, remove the existing component before performing the installation procedure.

About this task

The following image indicates the location of the system-board shield and provides a visual representation of the installation procedure.



5x
M3x5

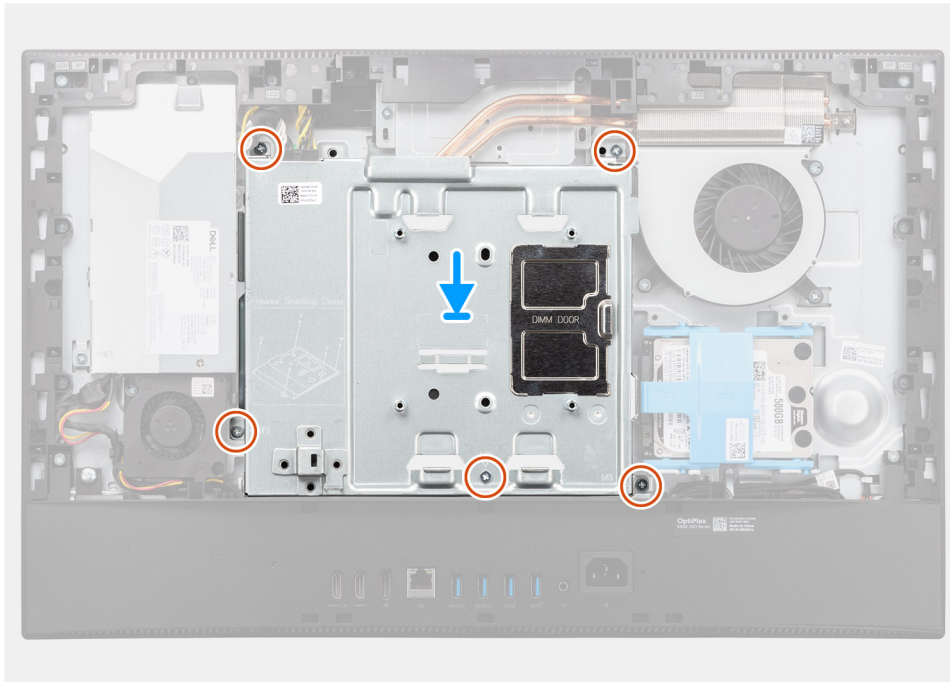
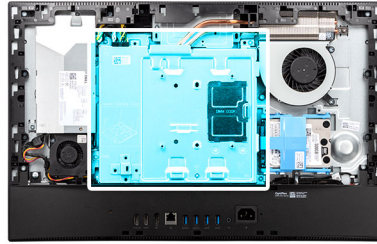

Steps

1. Align the screw holes on the system-board shield with the screw holes on the display-assembly base.
2. Replace the five screws (M3x5) to secure the system-board shield to the display-assembly base.

Next steps

1. Install the [back cover](#).
2. Install the [cable cover](#) (optional).
3. Install the [stand](#).
4. Follow the procedure in [After working inside your computer](#).

Solid-state drive

Removing the M.2 2230 solid-state drive-slot 1

Prerequisites

1. Follow the procedure in [Before working inside your computer](#).
2. Remove the [stand](#).
3. Remove the [cable cover](#) (optional).
4. Remove the [back cover](#).

5. Remove the [system-board shield](#).

About this task

The following image indicates the location of the slot-1 M.2 2230 solid-state drive and provides a visual representation of the removal procedure.



1x
M2x2.5

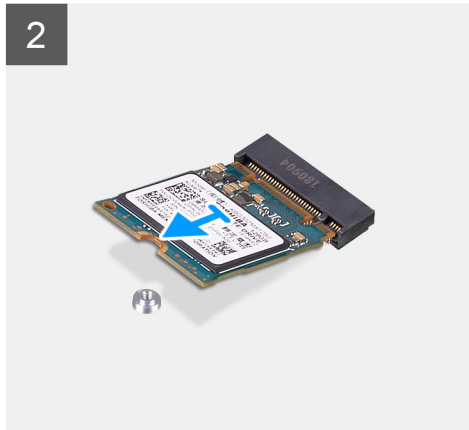
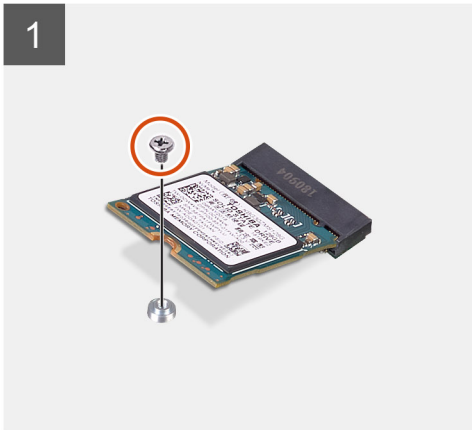
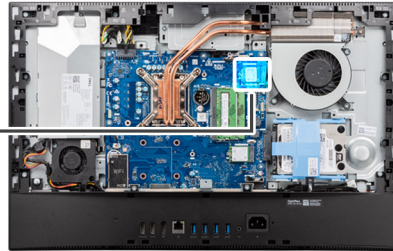

Steps

1. Remove the screw (M2x2.5) that secures the solid-state drive to the system board.
2. Slide and remove the solid-state drive from the M.2 card slot on the system board.

Installing the M.2 2230 solid-state drive-slot 1

Prerequisites

 **CAUTION:** Solid-state drives are fragile. Exercise care when handling the solid-state drive.

If you are replacing a component, remove the existing component before performing the installation procedure.

About this task

The following image indicates the location of the slot-1 M.2 2230 solid-state drive and provides a visual representation of the installation procedure.



1x
M2x2.5

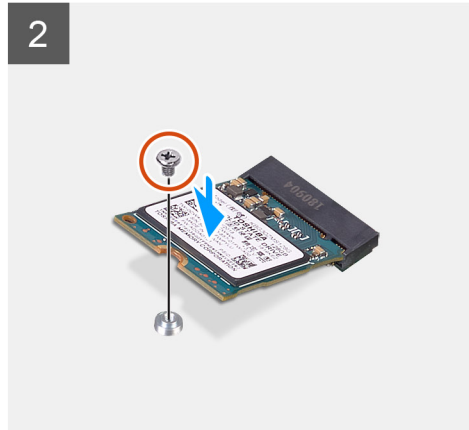
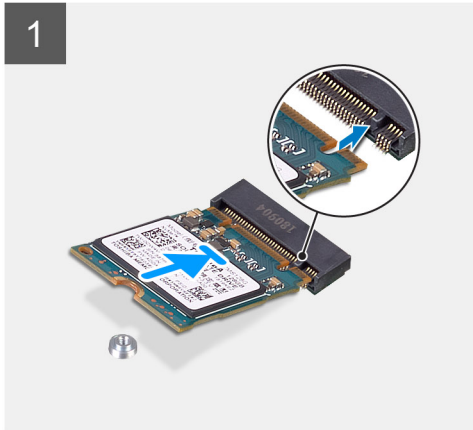

Steps

1. Align the notch on the solid-state drive with the tab on the M.2 card slot.
2. Slide the solid-state drive into the M.2 card slot on the system board.
3. Replace the screw (M2x2.5) to secure the solid-state drive to the system board.

Next steps

1. Install the [system-board shield](#).
2. Install the [back cover](#).
3. Install the [cable cover](#) (optional).
4. Install the [stand](#).
5. Follow the procedure in [After working inside your computer](#).

Removing the M.2 2280 solid-state drive-slot 1

Prerequisites

1. Follow the procedure in [Before working inside your computer](#).
2. Remove the [stand](#).
3. Remove the [cable cover](#) (optional).
4. Remove the [back cover](#).
5. Remove the [system-board shield](#).

About this task

The following image indicates the location of the slot-1 M.2 2280 solid-state drive and provides a visual representation of the removal procedure.



1x
M2x2.5

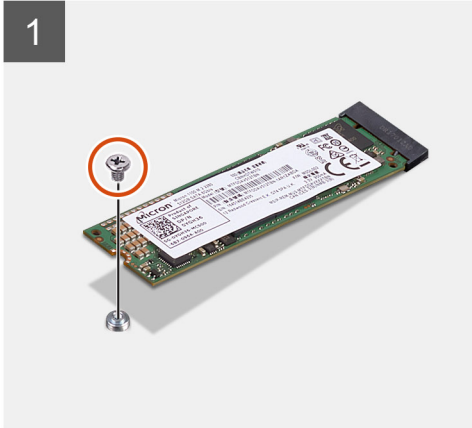
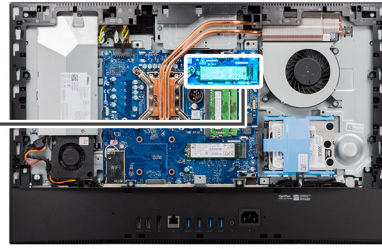

Steps

1. Remove the screw (M2x2.5) that secures the solid-state drive to the system board.
2. Slide and remove the solid-state drive from the M.2 card slot on the system board.

Installing the M.2 2280 solid-state drive-slot 1

Prerequisites

CAUTION: Solid-state drives are fragile. Exercise care when handling the solid-state drive.

If you are replacing a component, remove the existing component before performing the installation procedure.

About this task

The following image indicates the location of the slot-1 M.2 2280 solid-state drive and provides a visual representation of the installation procedure.



1x
M2x2.5

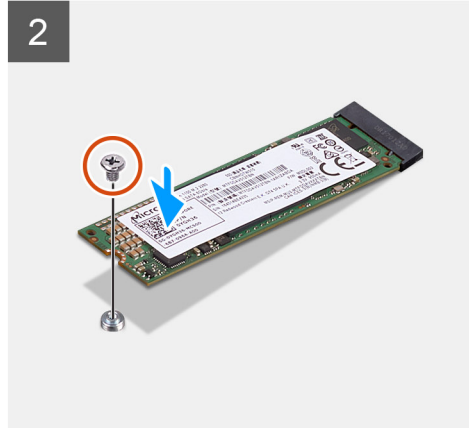
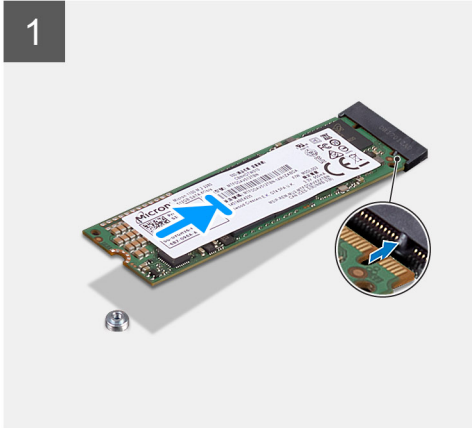
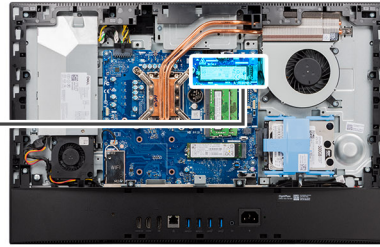

Steps

1. Align the notch on the solid-state drive with the tab on the M.2 card slot.
2. Slide the solid-state drive into the M.2 card slot on the system board.
3. Replace the screw (M2x2.5) to secure the solid-state drive to the system board.

Next steps

1. Install the [system-board shield](#).
2. Install the [back cover](#).
3. Install the [cable cover](#) (optional).
4. Install the [stand](#).
5. Follow the procedure in [After working inside your computer](#).

Removing the M.2 2230 solid-state drive-slot 2

Prerequisites

1. Follow the procedure in [Before working inside your computer](#).
2. Remove the [stand](#).
3. Remove the [cable cover](#) (optional).
4. Remove the [back cover](#).
5. Remove the [system-board shield](#).

About this task

The following image indicates the location of the slot-2 M.2 2230 solid-state drive and provides a visual representation of the removal procedure.



1x
M2x2.5

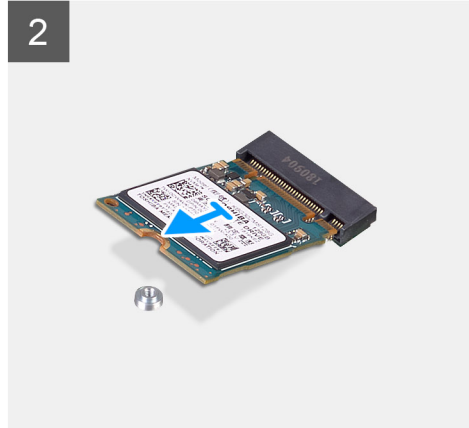
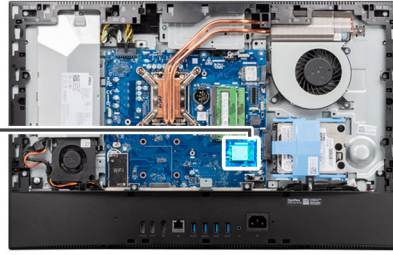

Steps

1. Remove the screw (M2x2.5) that secures the solid-state drive to the system board.
2. Slide and remove the solid-state drive from the M.2 card slot on the system board.

Installing the M.2 2230 solid-state drive-slot 2

Prerequisites

CAUTION: Solid-state drives are fragile. Exercise care when handling the solid-state drive.

If you are replacing a component, remove the existing component before performing the installation procedure.

About this task

The following image indicates the location of the slot-2 M.2 2230 solid-state drive and provides a visual representation of the installation procedure.



1x
M2x2.5

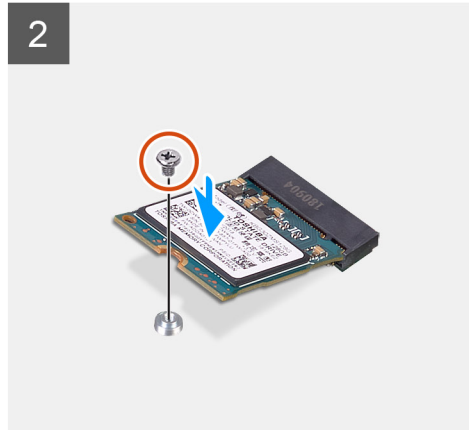
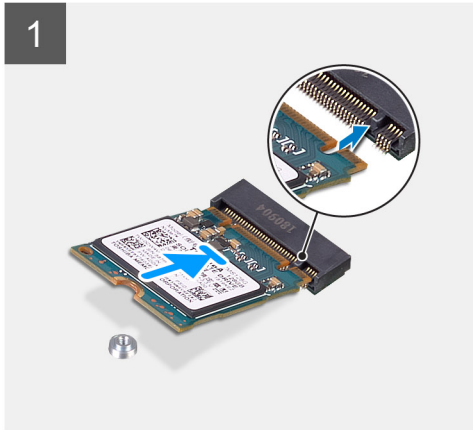
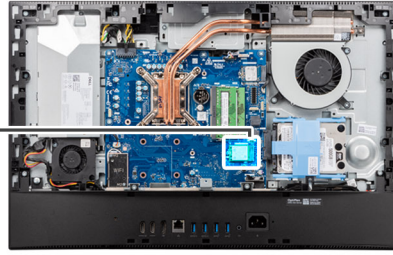

Steps

1. Align the notch on the solid-state drive with the tab on the M.2 card slot.
2. Slide the solid-state drive into the M.2 card slot on the system board.
3. Replace the screw (M2x2.5) to secure the solid-state drive to the system board.

Next steps

1. Install the [system-board shield](#).
2. Install the [back cover](#).
3. Install the [cable cover](#) (optional).
4. Install the [stand](#).
5. Follow the procedure in [After working inside your computer](#).

Removing the M.2 2280 solid-state drive-slot 2

Prerequisites

1. Follow the procedure in [Before working inside your computer](#).
2. Remove the [stand](#).
3. Remove the [cable cover](#) (optional).
4. Remove the [back cover](#).
5. Remove the [system-board shield](#).

About this task

The following image indicates the location of the slot-2 M.2 2280 solid-state drive and provides a visual representation of the removal procedure.



1x
M2x2.5

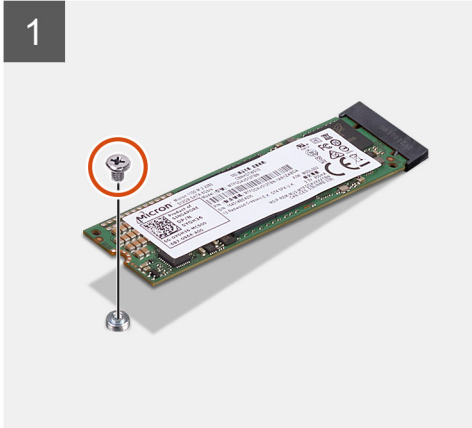
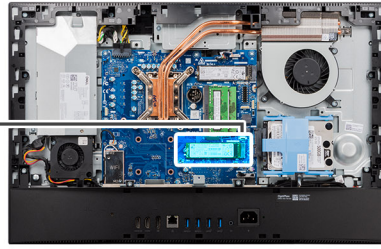

Steps

1. Remove the screw (M2x2.5) that secures the solid-state drive to the system board.
2. Slide and remove the solid-state drive from the M.2 card slot on the system board.

Installing the M.2 2280 solid-state drive-slot 2

Prerequisites

CAUTION: Solid-state drives are fragile. Exercise care when handling the solid-state drive.

If you are replacing a component, remove the existing component before performing the installation procedure.

About this task

The following image indicates the location of the slot-2 M.2 2280 solid-state drive and provides a visual representation of the installation procedure.



1x
M2x2.5

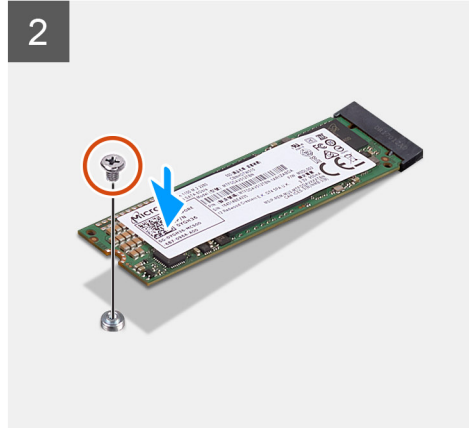
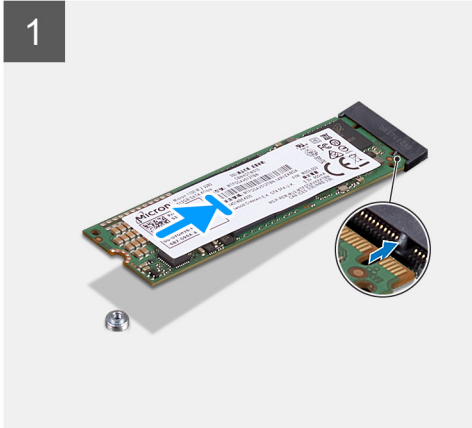
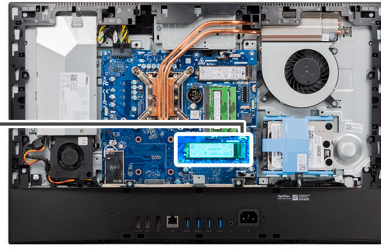

Steps

1. Align the notch on the solid-state drive with the tab on the M.2 card slot.
2. Slide the solid-state drive into the M.2 card slot on the system board.
3. Replace the screw (M2x2.5) to secure the solid-state drive to the system board.

Next steps

1. Install the [system-board shield](#).
2. Install the [back cover](#).
3. Install the [cable cover](#) (optional).
4. Install the [stand](#).
5. Follow the procedure in [After working inside your computer](#).

System fan

Removing the system fan—35 W

Prerequisites

1. Follow the procedure in [Before working inside your computer](#).
2. Remove the [stand](#).
3. Remove the [cable cover](#) (optional).
4. Remove the [back cover](#).
5. Remove the [system-board shield](#).

About this task

The following image indicates the location of the system fan and provides a visual representation of the removal procedure.



3x
M3x5

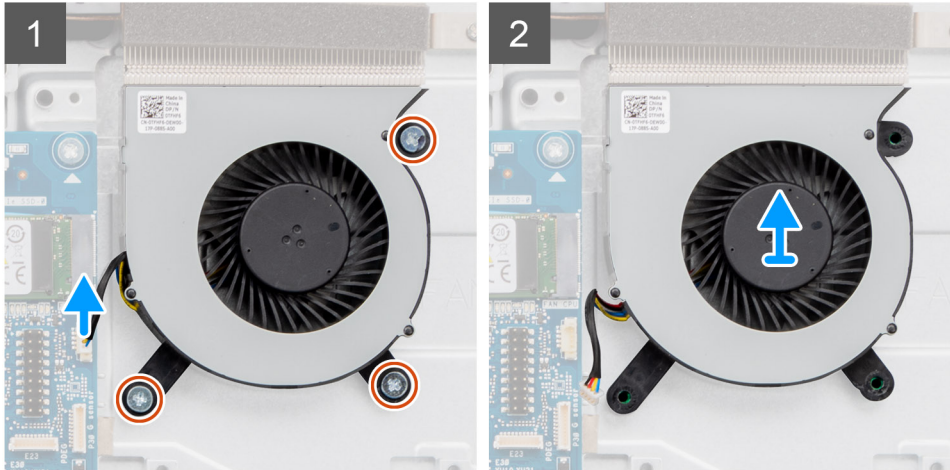
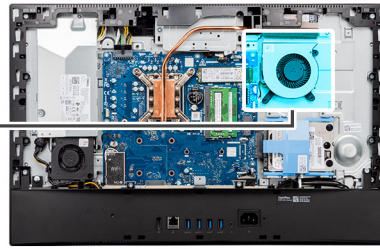
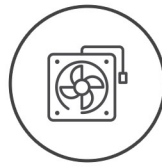

Steps

1. Disconnect the system-fan cable from the system board.
2. Remove the three screws (M3x5) that secure the system fan to the display-assembly base.
3. Lift the system fan, along with its cable, off the display-assembly base.

Installing the system fan—35 W

Prerequisites

If you are replacing a component, remove the existing component before performing the installation procedure.

About this task

The following image indicates the location of the system fan and provides a visual representation of the installation procedure.



3x
M3x5

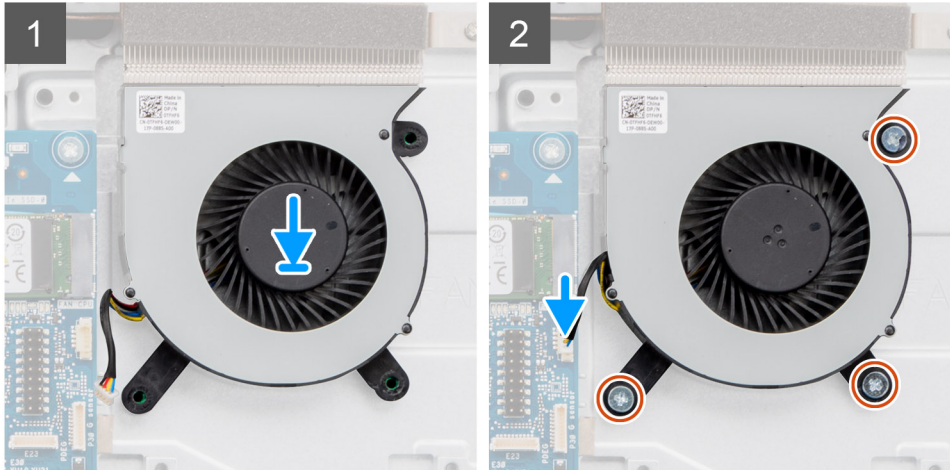
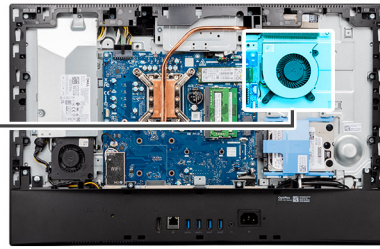
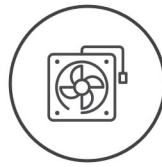

Steps

1. Align the screw holes on the system fan with the screw holes on the display-assembly base.
2. Replace the three screws (M3x5) to secure the system fan to the display-assembly base.
3. Connect the system-fan cable to the connector on the system board.

Next steps

1. Install the [system-board shield](#).
2. Install the [back cover](#).
3. Install the [cable cover](#) (optional).
4. Install the [stand](#).
5. Follow the procedure in [After working inside your computer](#).

Removing the system fan—65 W

Prerequisites

1. Follow the procedure in [Before working inside your computer](#).
2. Remove the [stand](#).
3. Remove the [cable cover](#) (optional).
4. Remove the [back cover](#).
5. Remove the [system-board shield](#).

About this task

The following image indicates the location of the system fan and provides a visual representation of the removal procedure.



3x
M3x5

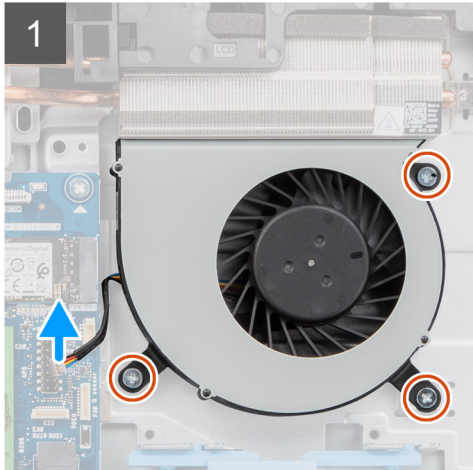
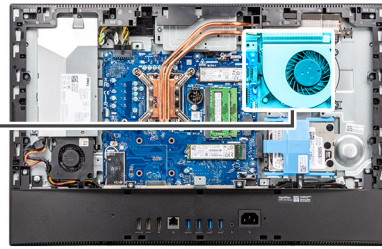
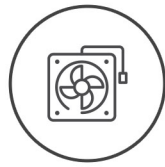

Steps

1. Disconnect the system-fan cable from the system board.
2. Remove the three screws (M3x5) that secure the system fan to the display-assembly base.
3. Lift the system fan, along with its cable, off the display-assembly base.

Installing the system fan—65 W

Prerequisites

If you are replacing a component, remove the existing component before performing the installation procedure.

About this task

The following image indicates the location of the system fan and provides a visual representation of the installation procedure.



3x
M3x5

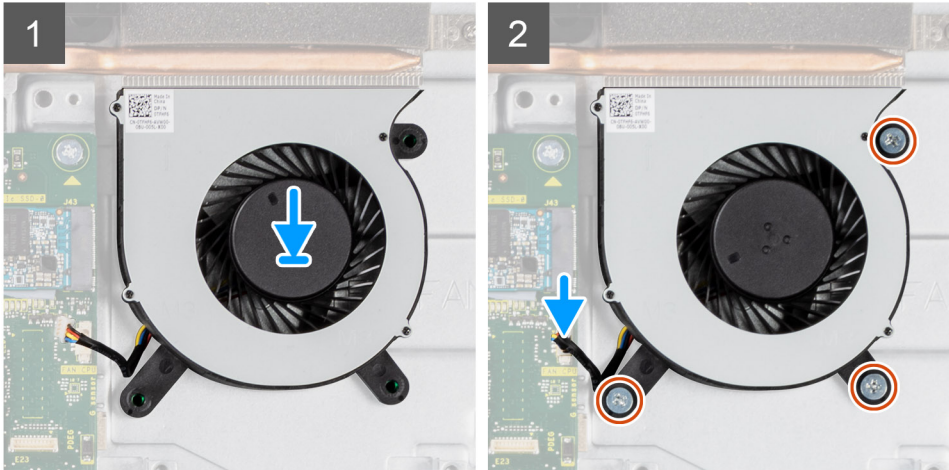
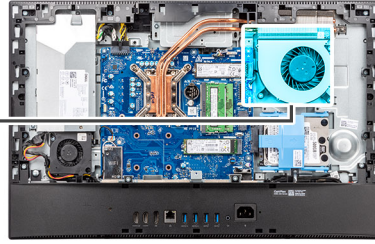
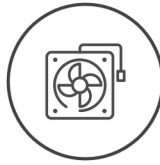

Steps

1. Align the screw holes on the system fan with the screw holes on the display-assembly base.
2. Replace the three screws (M3x5) to secure the system fan to the display-assembly base.
3. Connect the system-fan cable to the connector on the system board.

Next steps

1. Install the [system-board shield](#).
2. Install the [back cover](#).
3. Install the [cable cover](#) (optional).
4. Install the [stand](#).
5. Follow the procedure in [After working inside your computer](#).

Coin-cell battery

Removing the coin-cell battery

Prerequisites

1. Follow the procedure in [Before working inside your computer](#).
2. Remove the [stand](#).
3. Remove the [cable cover](#) (optional).
4. Remove the [back cover](#).
5. Remove the [system-board shield](#).

NOTE: Removing the coin-cell battery resets the CMOS and BIOS settings to default and results in data loss. It is recommended that you note the CMOS and BIOS settings before removing the coin-cell battery.

About this task

The following image indicates the location of the coin-cell battery and provides a visual representation of the removal procedure.

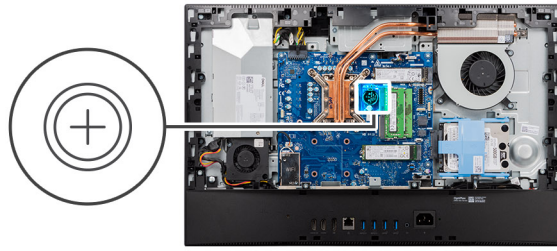

Steps

1. Using the plastic scribe, press on the metal clip to release the coin-cell battery from the coin-cell battery holder.
2. Lift the coin-cell battery from the coin-cell battery holder.

Installing the coin-cell battery

Prerequisites

If you are replacing a component, remove the existing component before performing the installation procedure.

About this task

The following image indicates the location of the coin-cell battery and provides a visual representation of the installation procedure.

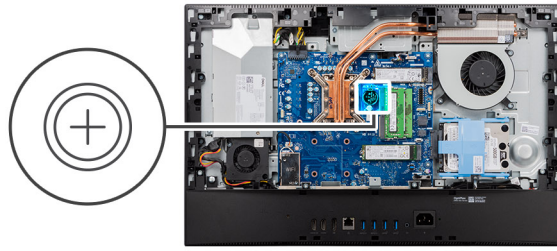

Steps

With the positive-side facing up, insert the coin-cell battery into the battery holder on the system board and gently press the battery until it snaps into place.

Next steps

1. Install the [system-board shield](#).
2. Install the [back cover](#).
3. Install the [cable cover](#) (optional).
4. Install the [stand](#).
5. Follow the procedure in [After working inside your computer](#).

Wireless card

Removing the wireless card

Prerequisites

1. Follow the procedure in [Before working inside your computer](#).
2. Remove the [stand](#).
3. Remove the [cable cover](#) (optional).
4. Remove the [back cover](#).
5. Remove the [system-board shield](#).

About this task

The following image indicates the location of the wireless card and provides a visual representation of the removal procedure.



3x
M2x2.5

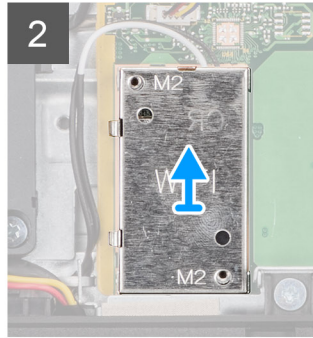

Steps

1. Remove the two screws (M2x2.5) that secure the wireless-card shield to the system board.
2. Unroute the antenna cables from the routing guides on the wireless-card shield.
3. Lift the wireless-card shield out of the system.
4. Remove the screw (M2x2.5) that secures the wireless-card bracket to the wireless card.
5. Slide and remove the wireless-card bracket off the wireless card.
6. Disconnect the antenna cables from the wireless card.

 **NOTE:** The antenna cables are preinstalled in your computer at the point of sale, even if you have obtained the computer without the WLAN card.

7. Slide and remove the wireless card from the wireless-card slot.

Installing the wireless card

Prerequisites

If you are replacing a component, remove the existing component before performing the installation procedure.

 **CAUTION:** To avoid damage to the wireless card, route the antenna cables accurately.

About this task

The following image indicates the location of the wireless card and provides a visual representation of the installation procedure.



3x
M2x2.5

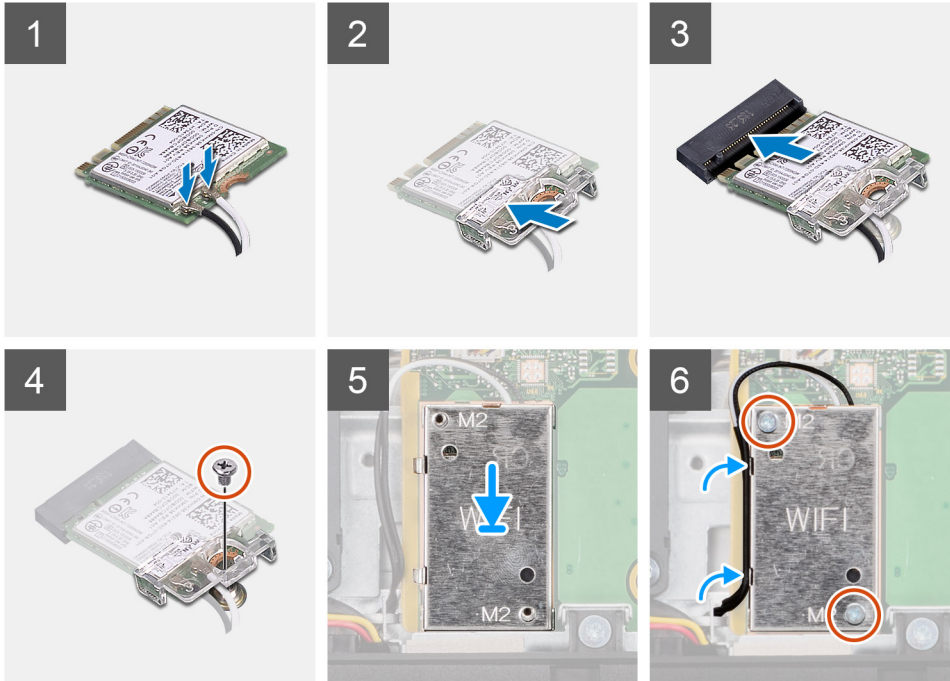

Steps

1. Connect the antenna cables to the wireless card.
The following table provides the antenna-cable color scheme:

Table 2. Antenna-cable color scheme

Connectors on the wireless card	Antenna-cable color	Silkscreen marking	
Main	White	MAIN	△ (white triangle)
Auxiliary	Black	AUX	▲ (black triangle)

i **NOTE:** The antenna cables are preinstalled in your computer at the point of sale, even if you have obtained the computer without the WLAN card.

2. Place the wireless-card bracket on the wireless card.
3. Align the notch on the wireless card with the tab on the wireless-card slot.
4. Slide the wireless card at an angle into the wireless-card slot.
5. Replace the screw (M2x2.5) to secure the wireless card and wireless-card bracket to the display-assembly base.
6. Align and place the wireless-card shield on the system board and wireless card.
7. Replace the two screws (M2x2.5) to secure the wireless-card shield to the system board.
8. Route the antenna cables through the routing guides on the wireless-card shield.

Next steps

1. Install the [system-board shield](#).
2. Install the [back cover](#).

3. Install the [cable cover](#) (optional).
4. Install the [stand](#).
5. Follow the procedure in [After working inside your computer](#).

Camera assembly

Removing the camera assembly

Prerequisites

1. Follow the procedure in [Before working inside your computer](#).
2. Remove the [stand](#).
3. Remove the [cable cover](#) (optional).
4. Remove the [back cover](#).
5. Remove the [system-board shield](#).

About this task

The following image indicates the location of the camera assembly and provides a visual representation of the removal procedure.



4x
M3x5

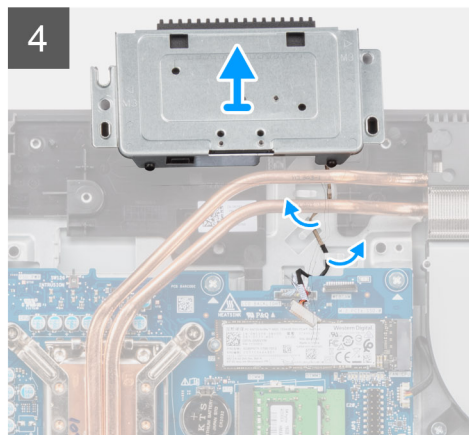
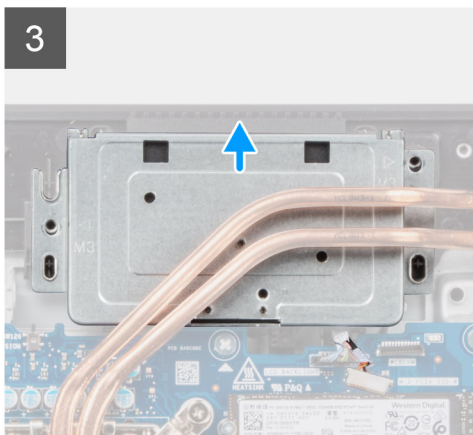
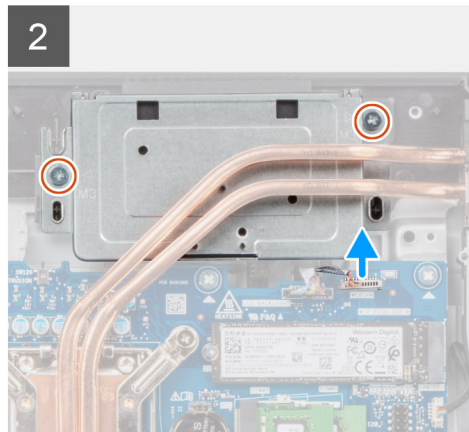
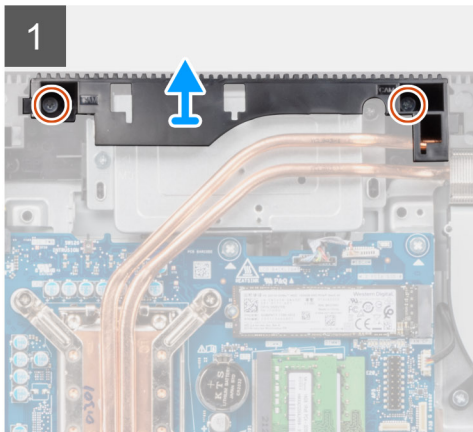
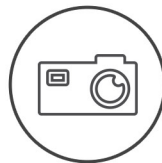

Steps

1. Remove the two screws (M3x5) that secure the camera-assembly door to the display-assembly base.
2. Disconnect the camera cable from the connector on the system board.
3. Remove the two screws (M3x5) that secure the camera assembly to the middle frame.
4. Slide and remove the camera assembly from the middle frame.
5. Unroute the camera cable from the routing guides on the display-assembly base.

Installing the camera assembly

Prerequisites

If you are replacing a component, remove the existing component before performing the installation procedure.

About this task

The following image indicates the location of the camera assembly and provides a visual representation of the installation procedure.



4x
M3x5

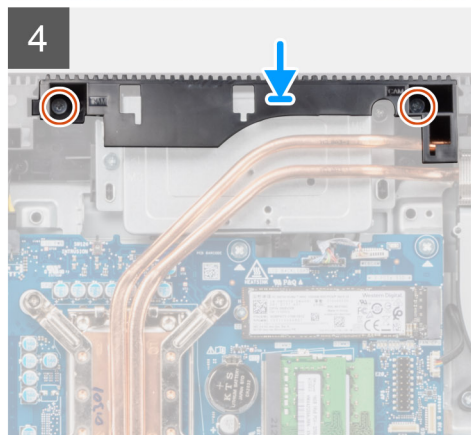
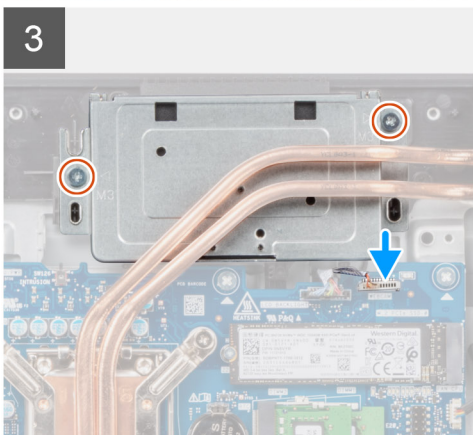
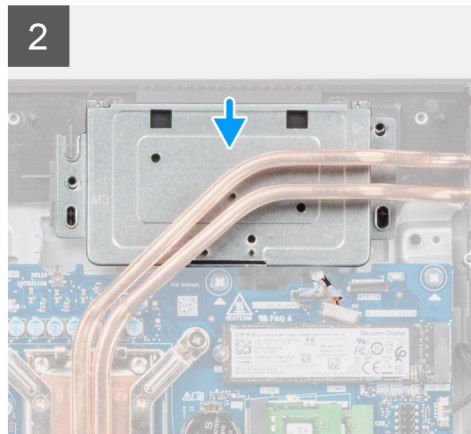
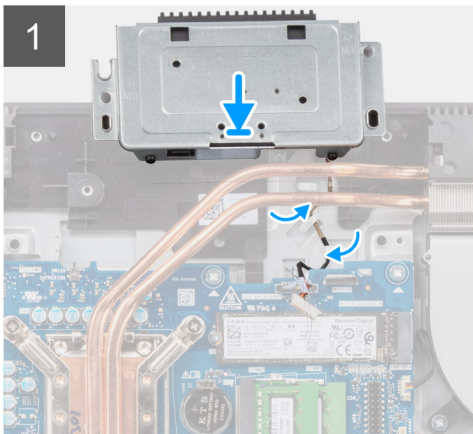

Steps

1. Route the camera cable through the routing guides on the display-assembly base.

2. Slide the camera assembly on the middle frame, and align the screw holes on the camera assembly with the screw holes on the middle frame.
3. Replace the two screws (M3x5) to secure the camera assembly to the middle frame.
4. Connect the camera cable to the system board.
5. Align the screw holes on the camera door with the screw holes on the display-assembly base.
6. Replace the two screws (M3x5) to secure the camera door to the display-assembly base.

Next steps

1. Install the [system-board shield](#).
2. Install the [back cover](#).
3. Install the [cable cover](#) (optional).
4. Install the [stand](#).
5. Follow the procedure in [After working inside your computer](#).

Bottom cover

Removing the bottom cover

Prerequisites

1. Follow the procedure in [Before working inside your computer](#).
2. Remove the [stand](#).
3. Remove the [cable cover](#) (optional).
4. Remove the [back cover](#).
5. Remove the [system-board shield](#).

About this task

The following image indicates the location of the bottom cover and provides a visual representation of the removal procedure.



4x
M3x5

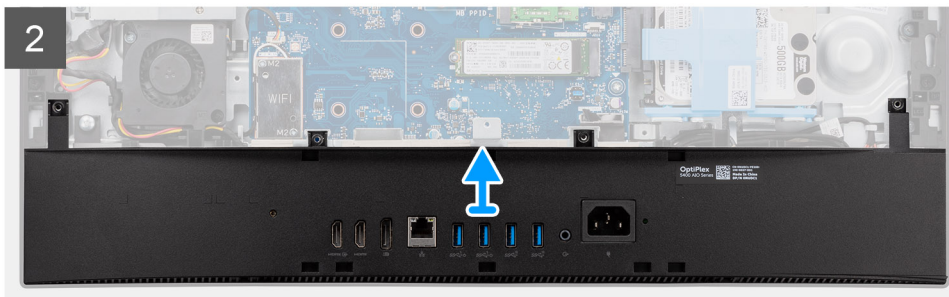
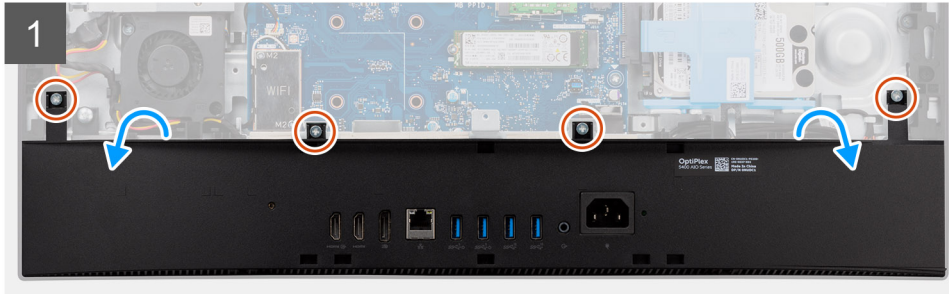
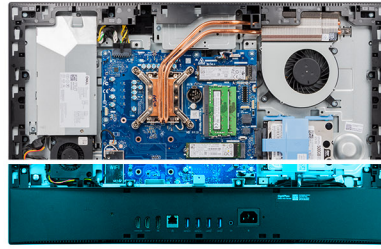

Steps

1. Remove the four screws (M3x5) that secure the bottom cover to the display-assembly base.
2. Pry and lift the bottom cover off the display-assembly base.

Installing the bottom cover

Prerequisites

If you are replacing a component, remove the existing component before performing the installation procedure.

About this task

The following image indicates the location of the bottom cover and provides a visual representation of the installation procedure.



4x
M3x5

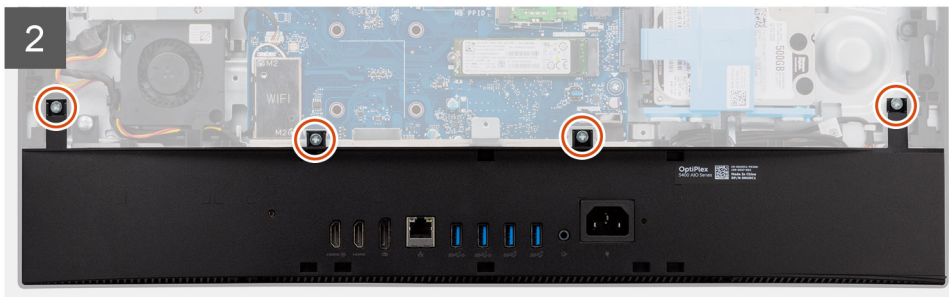
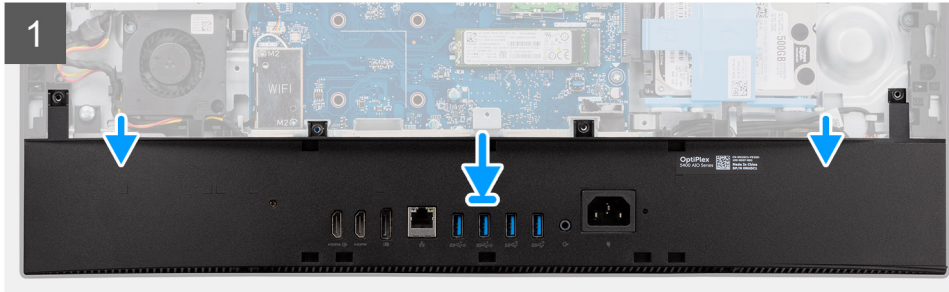
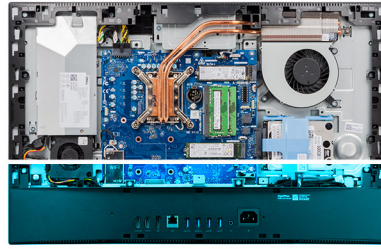

Steps

1. Align the screw holes on the bottom cover with the screw holes on the display-assembly base.
2. Replace the four screws (M3x5) to secure the bottom cover to the display-assembly base.

Next steps

1. Install the [system-board shield](#).
2. Install the [back cover](#).
3. Install the [cable cover](#) (optional).
4. Install the [stand](#).
5. Follow the procedure in [After working inside your computer](#).

Power-supply unit

Removing the power-supply unit (PSU)

Prerequisites

1. Follow the procedure in [Before working inside your computer](#).
2. Remove the [stand](#).
3. Remove the [cable cover](#) (optional).
4. Remove the [back cover](#).
5. Remove the [system-board shield](#).
6. Remove the [bottom cover](#).

About this task

The following image indicates the location of the PSU and provides a visual representation of the PSU removal procedure.



2x
M3x5

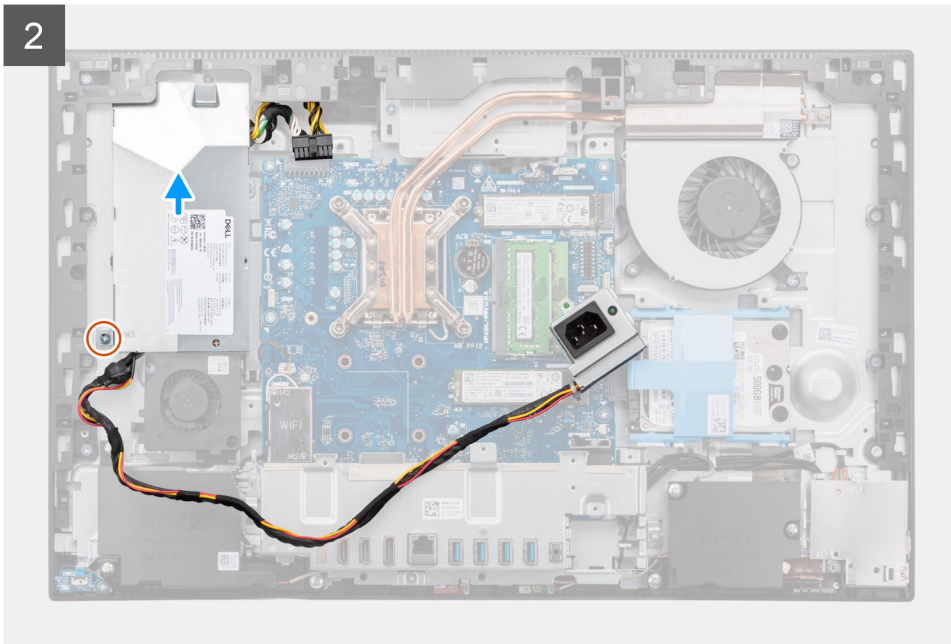
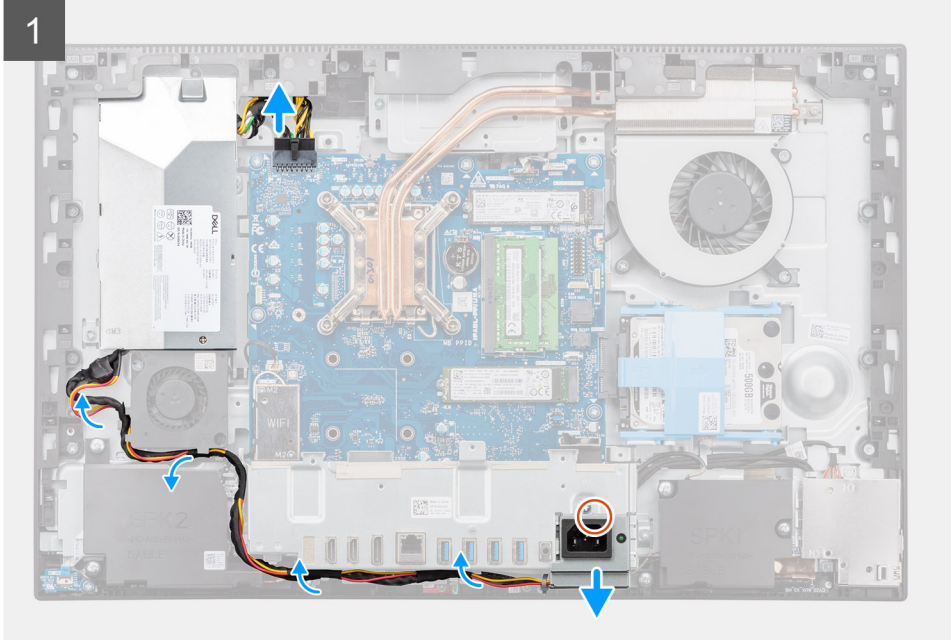

3

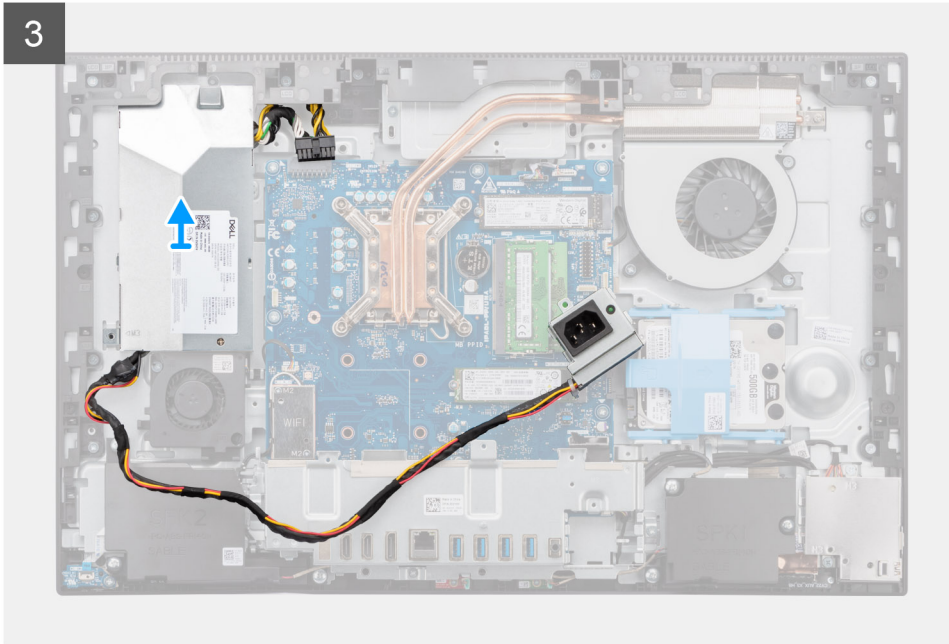

Steps

1. Remove the screw (M3x5) that secures the power-supply socket to the rear-I/O bracket.
2. Slide the power-supply socket out of the rear-I/O bracket.
3. Remove the power-supply cable from the routing guides on the rear-I/O bracket and PSU fan.
4. Disconnect the power-supply cable from the connector on the system board.
5. Remove the screw (M3x5) that secures the PSU to the display-assembly base.
6. Lift the PSU out of the system.

Installing the power-supply unit (PSU)

Prerequisites

If you are replacing a component, remove the existing component before performing the installation procedure.

About this task

The following image indicates the location of the PSU and provides a visual representation of the PSU installation procedure.



2x
M3x5

1

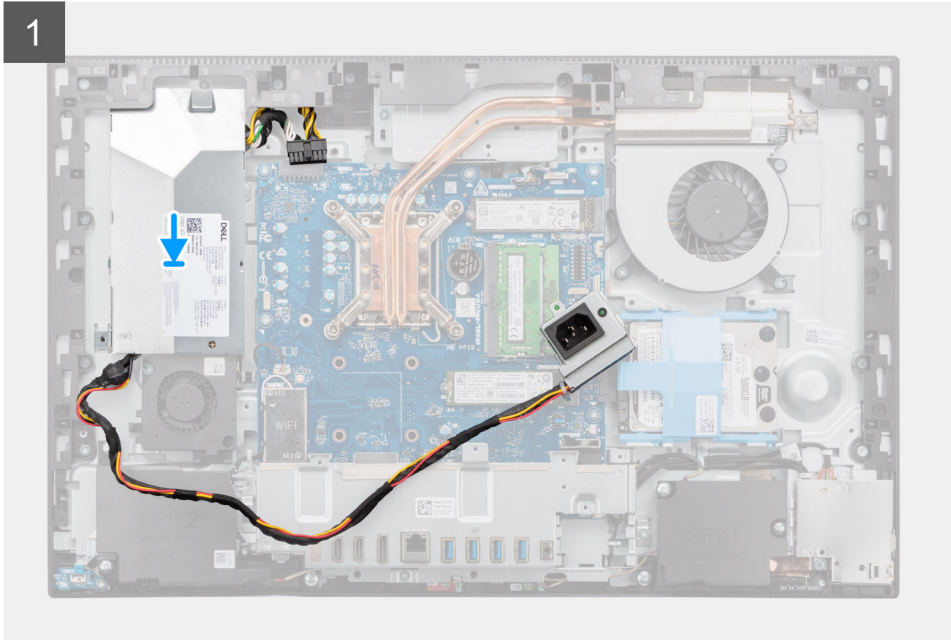

2

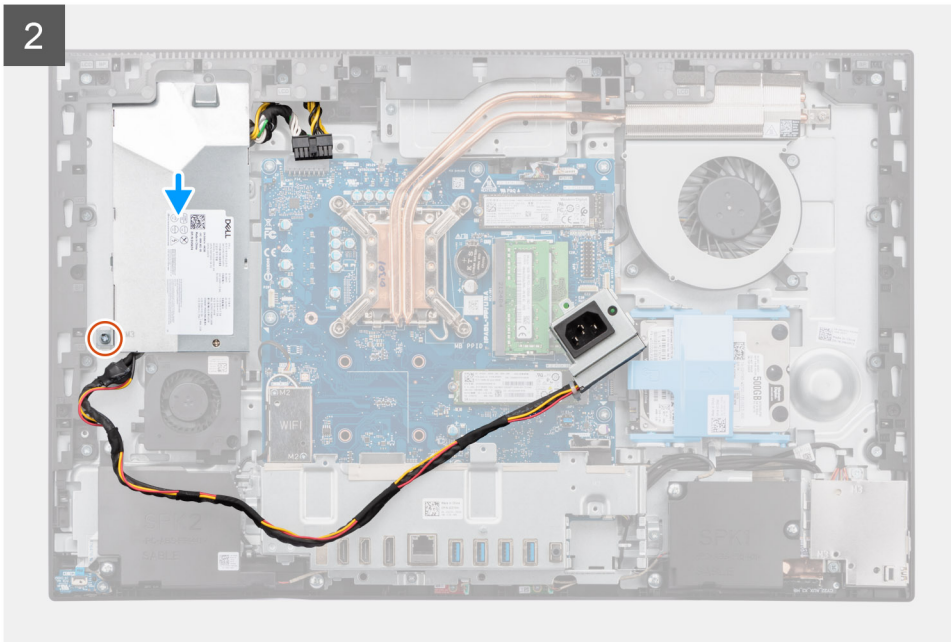

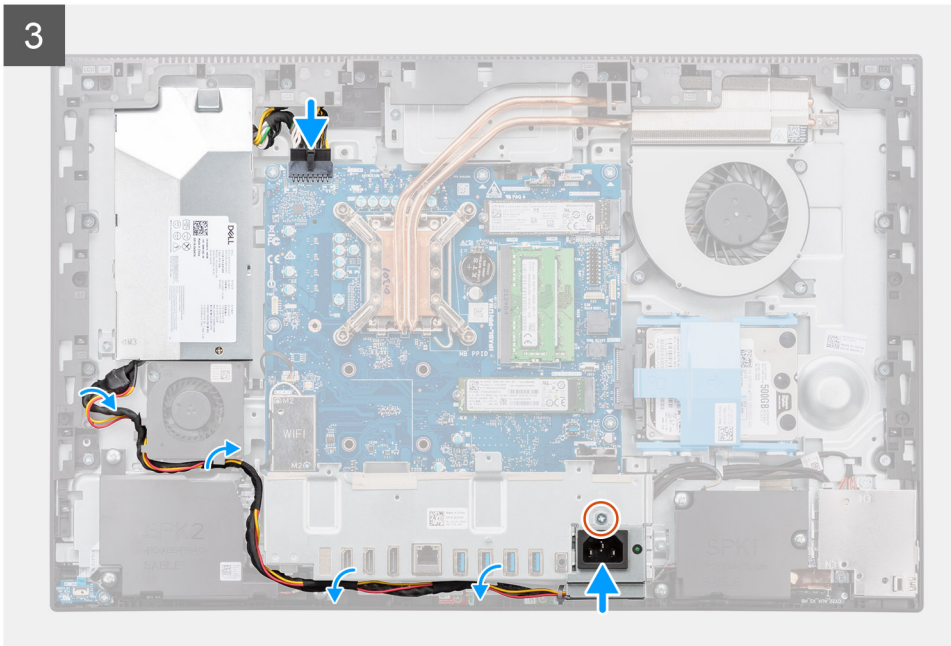

Steps

1. Align and place the PSU in the slot on the display-assembly base.
2. Replace the screw (M3x5) to secure the PSU to the display-assembly base.
3. Connect the power-supply cable to the connector on the system board.
4. Route the power-supply cable through the routing guides on the rear-I/O bracket and PSU fan.
5. Align the screw hole on the power-supply socket with the screw hole on the rear-I/O bracket, and place it in the slot on the rear-I/O bracket.
6. Replace the screw (M3x5) to secure the power-supply socket to the rear-I/O bracket.

Next steps

1. Install the [bottom cover](#).
2. Install the [system-board shield](#).
3. Install the [back cover](#).
4. Install the [cable cover](#) (optional).
5. Install the [stand](#).
6. Follow the procedure in [After working inside your computer](#).

Power-supply fan

Removing the PSU fan

Prerequisites

1. Follow the procedure in [Before working inside your computer](#).
2. Remove the [stand](#).
3. Remove the [cable cover](#) (optional).
4. Remove the [back cover](#).
5. Remove the [system-board shield](#).

About this task

The following image indicates the location of the PSU fan and provides a visual representation of the removal procedure.



2x
M3x5

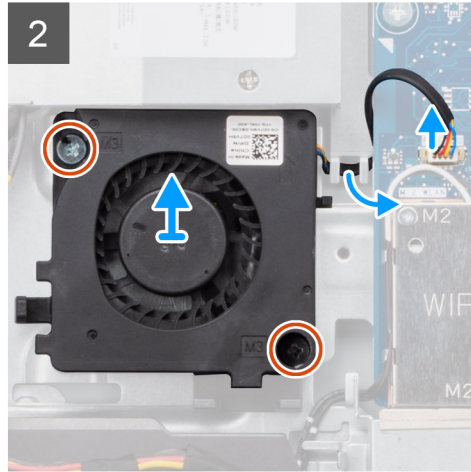
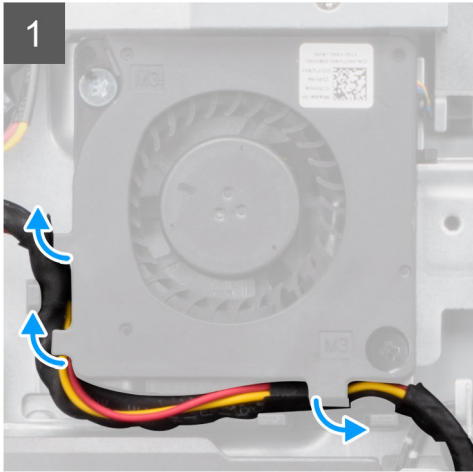
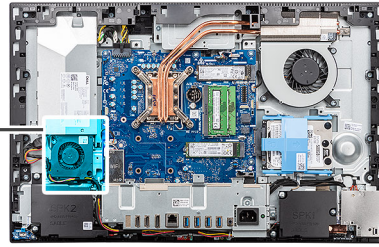
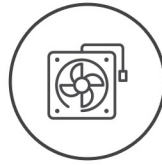

Steps

1. Remove the power-supply cable from the routing guides on the PSU fan.
2. Disconnect the PSU-fan cable from the system board.
3. Remove the two screws (M3x5) that secure the PSU fan to the display-assembly base.
4. Lift the PSU fan from the display-assembly base.

Installing the PSU fan

Prerequisites

If you are replacing a component, remove the existing component before performing the installation procedure.

About this task

The following image indicates the location of the PSU fan and provides a visual representation of the installation procedure.



2x
M3x5

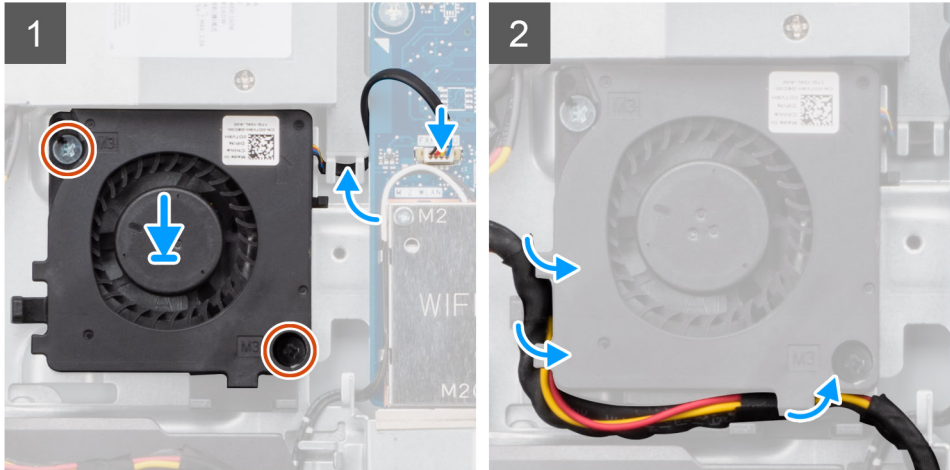
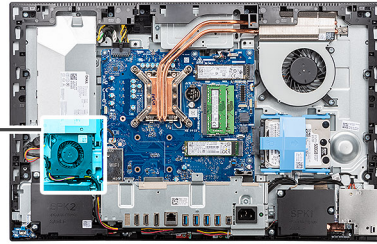
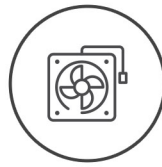

Steps

1. Align the screw holes on the PSU fan with the screw holes on the display-assembly base.
2. Replace the two screws (M3x5) to secure the PSU fan to the display-assembly base.
3. Connect the PSU-fan cable to the connector on the system board.
4. Route the power-supply cable through the routing guides on the PSU fan.

Next steps

1. Install the [system-board shield](#).
2. Install the [back cover](#).
3. Install the [cable cover](#) (optional).
4. Install the [stand](#).
5. Follow the procedure in [After working inside your computer](#).

Heat sink

Removing the heat sink—35 W

Prerequisites

1. Follow the procedure in [Before working inside your computer](#).
2. Remove the [stand](#).
3. Remove the [cable cover](#) (optional).
4. Remove the [back cover](#).
5. Remove the [system-board shield](#).
6. Remove the [system fan](#).

About this task

The following image indicates the location of the heat sink and provides a visual representation of the heat sink removal procedure.



5x

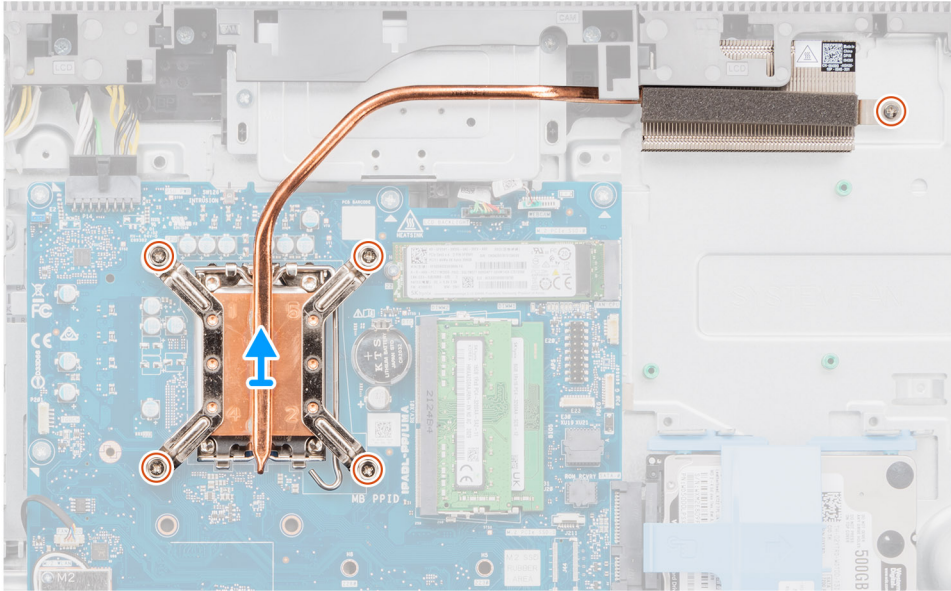
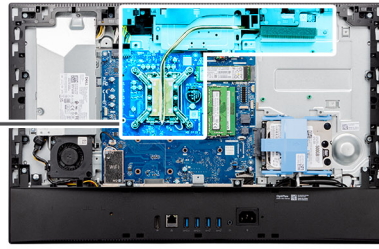

Steps

1. In reverse sequential order (as indicated on the heat sink), loosen the five captive screws that secure the heat sink to the system board and the display-assembly base.
2. Slide and lift the heat sink off the system board and display-assembly base.

Installing the heat sink—35 W

Prerequisites

If you are replacing a component, remove the existing component before performing the installation procedure.

 **NOTE:** If either the system board or the heat sink is replaced, use the thermal pad/paste provided in the kit to ensure that thermal conductivity is achieved.

About this task

The following image indicates the location of the heat sink and provides a visual representation of the installation procedure.



5x

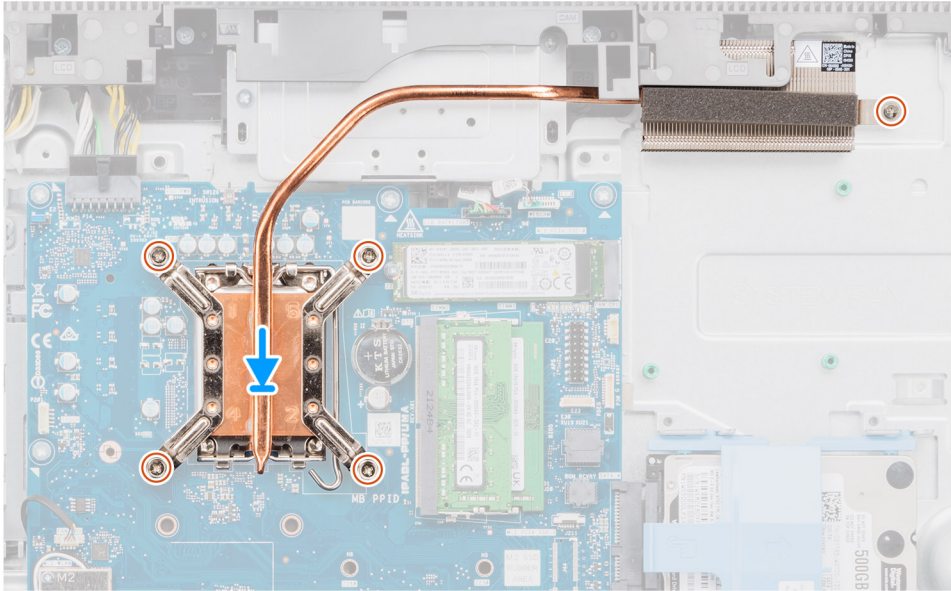
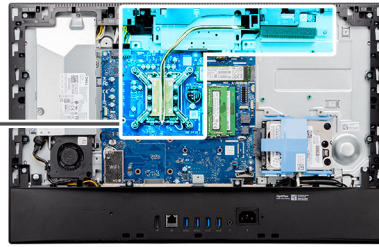

Steps

1. Align the screw holes on the heat sink with the screw holes on the system board and the display-assembly base.
2. In sequential order (as indicated on the heat sink), tighten the five captive screws that secure the heat sink to the system board and display-assembly base.

Next steps

1. Install the [system fan](#).
2. Install the [system-board shield](#).
3. Install the [back cover](#).
4. Install the [cable cover](#) (optional).
5. Install the [stand](#).
6. Follow the procedure in [After working inside your computer](#).

Removing the heat sink—65 W

Prerequisites

1. Follow the procedure in [Before working inside your computer](#).
2. Remove the [stand](#).
3. Remove the [cable cover](#) (optional).
4. Remove the [back cover](#).
5. Remove the [system-board shield](#).
6. Remove the [system fan](#).

About this task

The following image indicates the location of the heat sink and provides a visual representation of the heat sink removal procedure.



5x

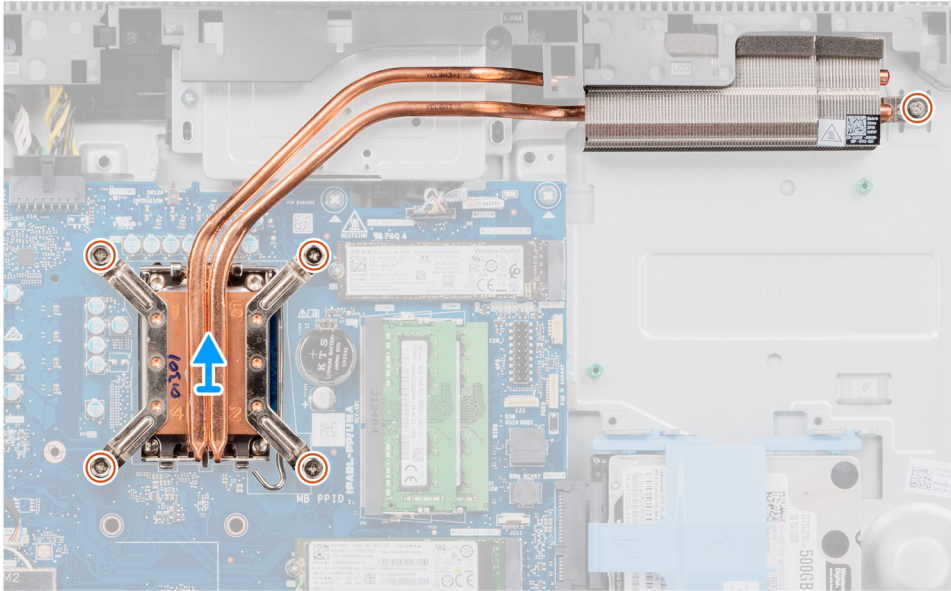
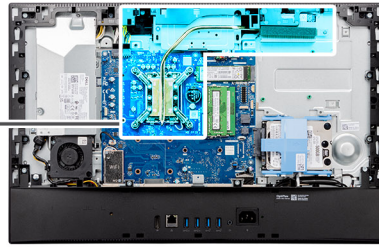

Steps

1. In reverse sequential order (as indicated on the heat sink), loosen the five captive screws that secure the heat sink to the system board and the display-assembly base.
2. Slide and lift the heat sink off the system board and display-assembly base.

Installing the heat sink—65 W

Prerequisites

If you are replacing a component, remove the existing component before performing the installation procedure.

i **NOTE:** If either the system board or the heat sink is replaced, use the thermal pad/paste provided in the kit to ensure that thermal conductivity is achieved.

About this task

The following image indicates the location of the heat sink and provides a visual representation of the installation procedure.



5x

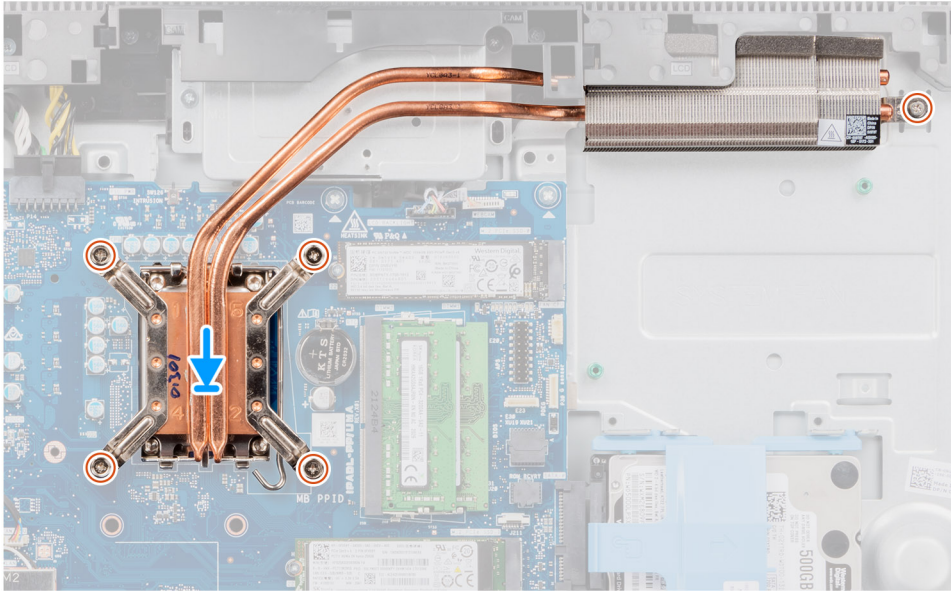

Steps

1. Align the screw holes on the heat sink with the screw holes on the system board and the display-assembly base.
2. In sequential order (as indicated on the heat sink), tighten the five captive screws that secure the heat sink to the system board and display-assembly base.

Next steps

1. Install the [system fan](#).
2. Install the [system-board shield](#).
3. Install the [back cover](#).
4. Install the [cable cover](#) (optional).
5. Install the [stand](#).
6. Follow the procedure in [After working inside your computer](#).

Processor

Removing the processor

Prerequisites

1. Follow the procedure in [Before working inside your computer](#).
2. Remove the [stand](#).
3. Remove the [cable cover](#) (optional).
4. Remove the [back cover](#).
5. Remove the [system-board shield](#).
6. Remove the [heat sink](#).

About this task

The following image indicates the location of the processor and provides a visual representation of the removal procedure.

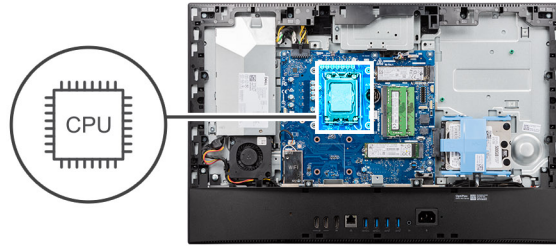

Steps

1. Press the release lever down and then push it away from the processor to release it from the securing tab.
2. Extend the release lever completely, and open the processor cover.

CAUTION: When removing the processor, do not touch any of the pins inside the socket or allow any objects to fall on the pins in the socket.

3. Gently lift the processor from the processor socket.

Installing the processor

Prerequisites

If you are replacing a component, remove the existing component before performing the installation procedure.

About this task

The following image indicates the location of the processor and provides a visual representation of the installation procedure.

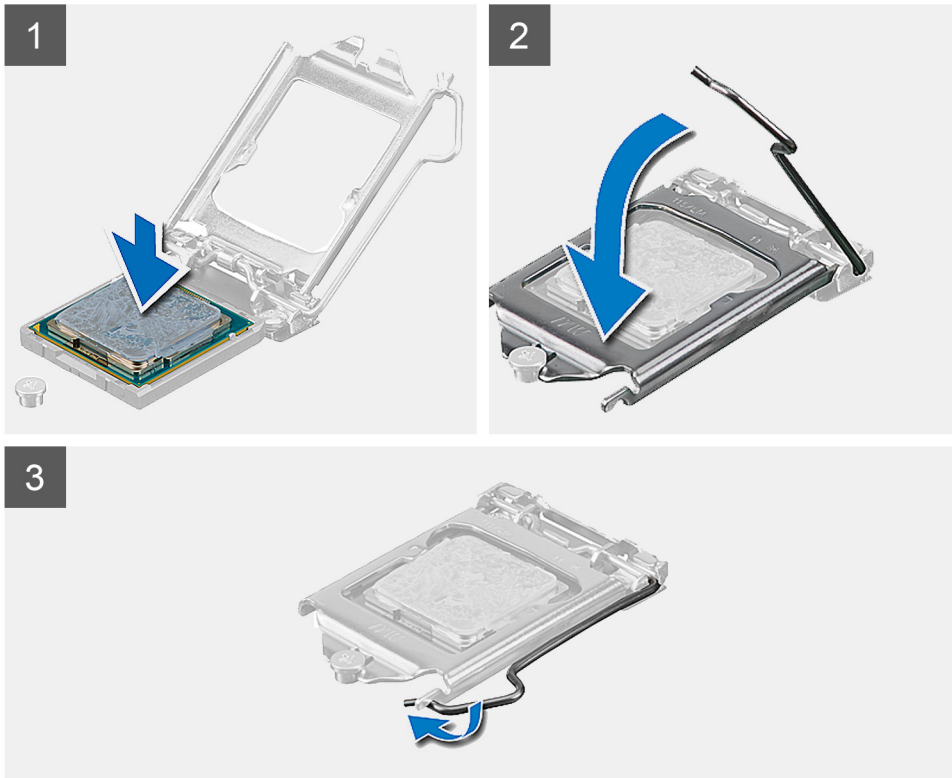
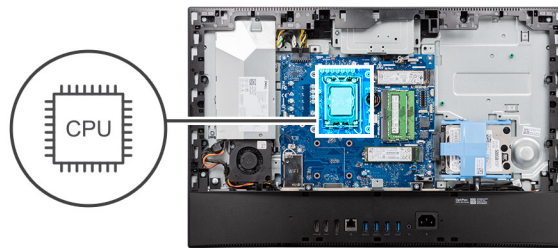

Steps

1. Ensure that the release lever on the processor socket is fully extended in the open position.
 - i** **NOTE:** The pin-1 corner of the processor has a triangle that aligns with the triangle on the pin-1 corner on the processor socket. When the processor is properly seated, all four corners are aligned at the same height. If one or more corners of the processor are higher than the others, the processor is not seated properly.
2. Align the notches on the processor with the tabs on the processor socket and place the processor in the processor socket.
 - ⚠ CAUTION:** Ensure that the processor-cover notch is positioned underneath the alignment post.
3. When the processor is fully seated in the socket, pivot the release-lever down and place it under the tab on the processor cover.

Next steps

1. Install the [heat sink](#).
2. Install the [system-board shield](#).
3. Install the [back cover](#).
4. Install the [cable cover](#) (optional).
5. Install the [stand](#).
6. Follow the procedure in [After working inside your computer](#).

Rear-I/O bracket

Removing the rear-I/O bracket

Prerequisites

1. Follow the procedure in [Before working inside your computer](#).
2. Remove the [stand](#).
3. Remove the [cable cover](#) (optional).
4. Remove the [back cover](#).
5. Remove the [system-board shield](#).
6. Remove the [bottom cover](#).

About this task

The following image indicates the location of the rear-I/O bracket and provides a visual representation of the removal procedure.



4x
M3x5

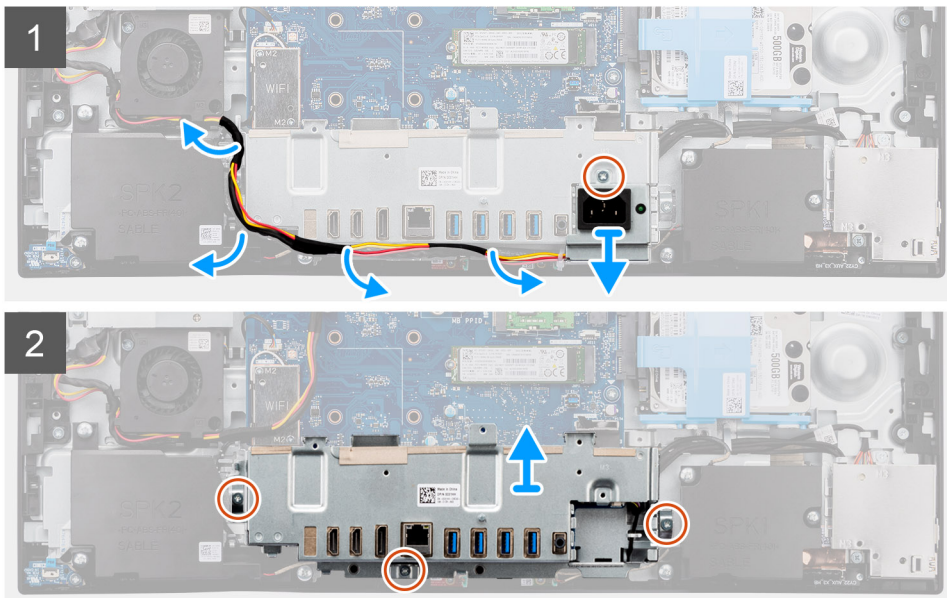
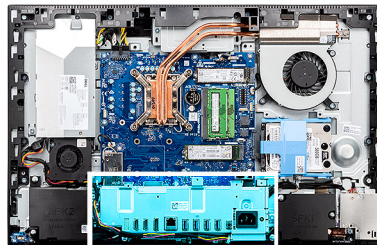

Steps

1. Remove the screw (M3x5) that secures the power-supply socket to the rear-I/O bracket.
2. Remove the power-supply cable from the routing guide on the rear-I/O bracket.
3. Slide and remove the power-supply socket away from the rear-I/O bracket.
4. Remove the three screws (M3x5) that secure the rear-I/O bracket to the display-assembly base.
5. Lift the rear-I/O bracket off the display-assembly base.

Installing the rear-I/O bracket

Prerequisites

If you are replacing a component, remove the existing component before performing the installation procedure.

About this task

The following image indicates the location of the rear-I/O bracket and provides a visual representation of the installation procedure.



4x
M3x5

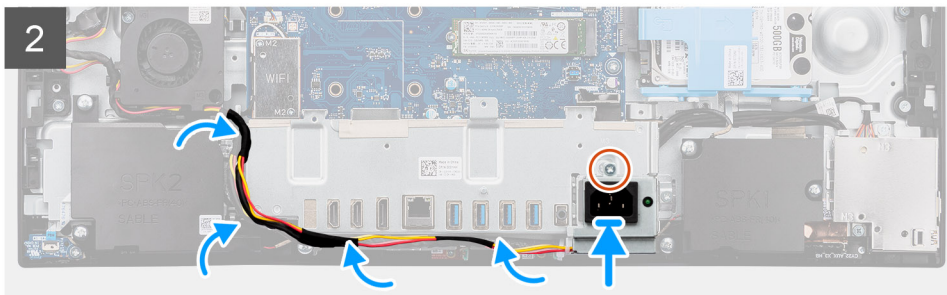
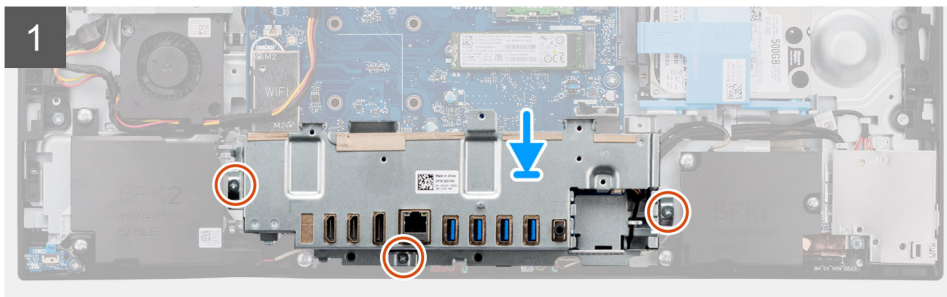
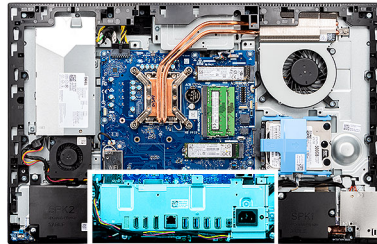

Steps

1. Align the screw holes on the rear-I/O bracket with the screw holes on the display-assembly base.
2. Replace the three screws (M3x5) to secure the rear-I/O bracket to the display-assembly base.
3. Route the power-supply cables through the routing guide on the rear-I/O bracket.
4. Align the screw hole on the power-supply socket with the screw hole on the rear-I/O bracket, and place it in the slot on the rear-I/O bracket.
5. Replace the screw (M3x5) to secure the power-supply socket to the rear-I/O bracket.

Next steps

1. Install the [bottom cover](#).
2. Install the [system-board shield](#).
3. Install the [back cover](#).
4. Install the [cable cover](#) (optional).
5. Install the [stand](#).
6. Follow the procedure in [After working inside your computer](#).

System board

Removing the system board

Prerequisites

1. Follow the procedure in [Before working inside your computer](#).

i **NOTE:** Your computer's Service Tag is stored in the system board. You must enter the Service Tag in the BIOS setup program after you replace the system board.

i **NOTE:** Replacing the system board removes any changes you have made to the BIOS using the BIOS setup program. You must make the appropriate changes again after you replace the system board.

2. Remove the [stand](#).
3. Remove the [cable cover](#) (optional).
4. Remove the [back cover](#).
5. Remove the [hard drive](#).
6. Remove the [system-board shield](#).
7. Remove the [memory modules](#).
8. Remove the [wireless card](#).
9. Remove the [M.2 solid-state drive](#).
10. Remove the [heat sink](#).
11. Remove the [processor](#).
12. Remove the [coin-cell battery](#).
13. Remove the [bottom cover](#).
14. Remove the [rear-I/O bracket](#).

About this task

The following image indicates the connectors on your system board.

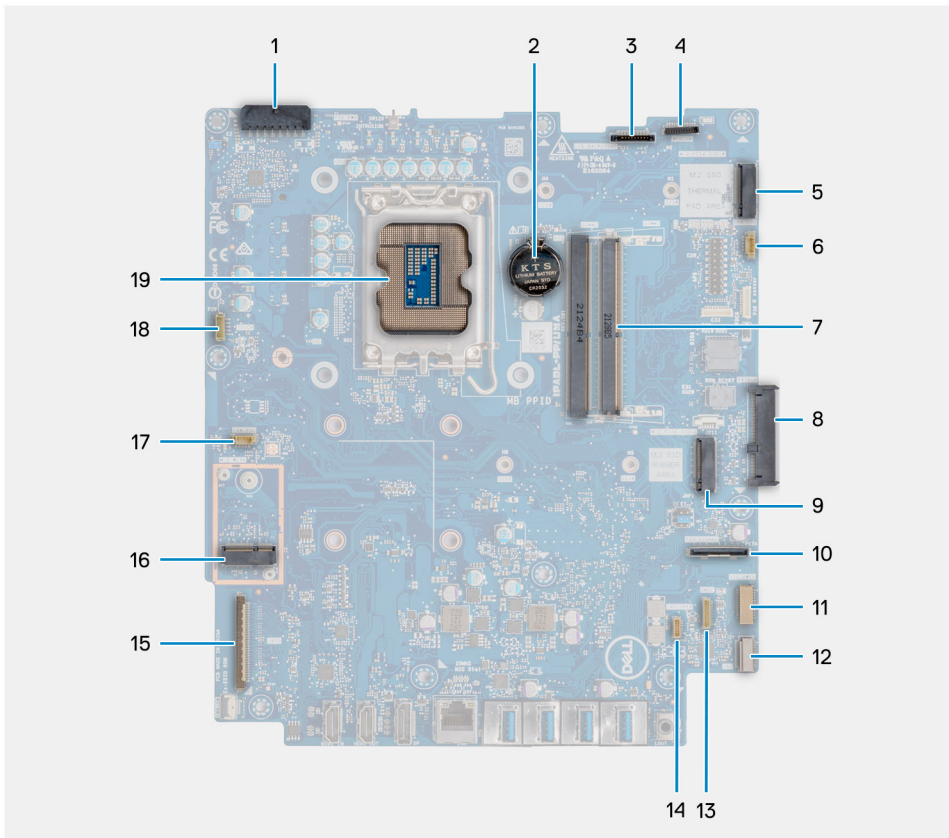

1. Power-supply unit (PSU) cable connector
2. Coin-cell battery
3. Display back-light cable connector
4. Camera cable connector
5. M.2 2230/2280 solid-state drive connector
6. Processor-fan cable connector
7. Memory modules
8. Hard-drive connector
9. M.2 2230/2280 solid-state drive connector
10. Side I/O-signal cable connector
11. Side I/O-power cable connector
12. Audio-board cable connector
13. Microphone-module cable connector
14. Speaker cable connector
15. Display cable connector
16. M.2 WLAN connector
17. PSU-fan cable connector
18. Touchscreen cable connector
19. Processor

The following image indicates the location of the system board and provides a visual representation of the removal procedure.



9x
M3x5

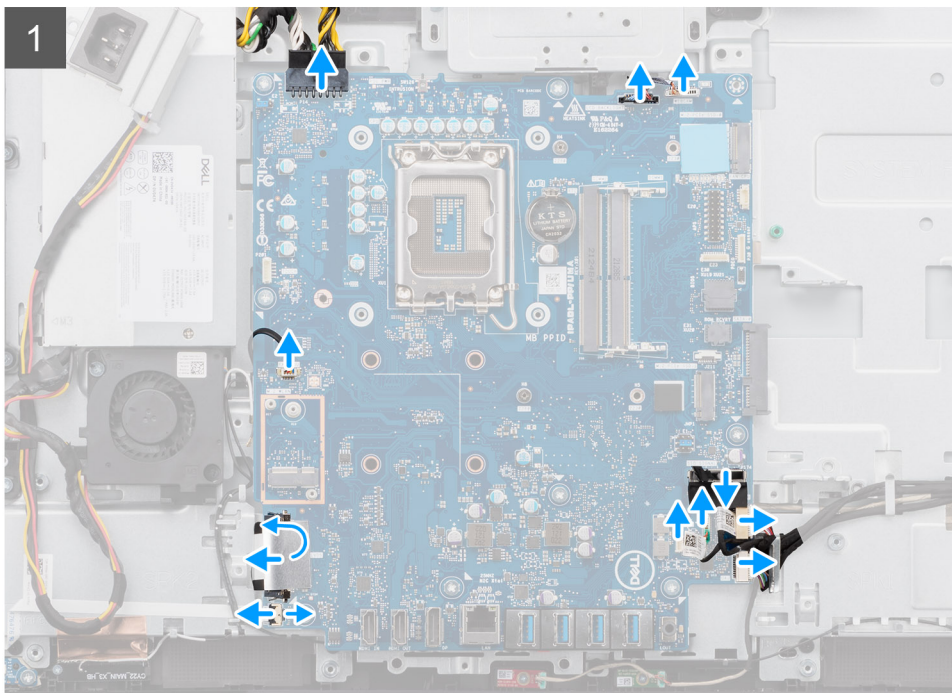
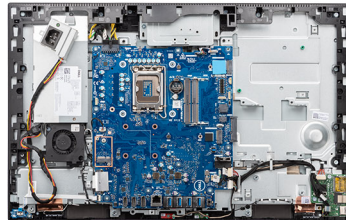

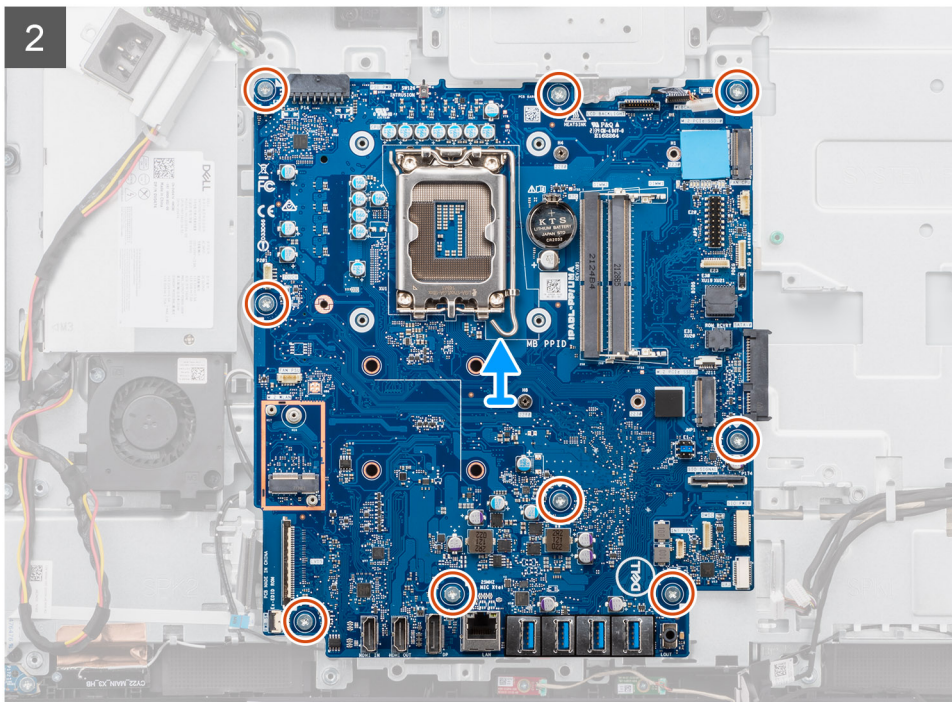

Steps

1. Disconnect the display back-light cable from the connector on the system board.
2. Disconnect the display cable from the connector on the system board.
3. Disconnect the PSU cable from the connector on the system board.
4. Disconnect the PSU fan cable from the connector on the system board.
5. Open the latch and disconnect the power-button board cable from the connector on the system board.
6. Disconnect the speaker cable from the connector on the system board.
7. Disconnect the microphone-module cable from the connector on the system board.
8. Disconnect the SIO-signal cable from the connector on the system board.
9. Disconnect the SIO-power cable from the connector on the system board.
10. Disconnect the audio-board cable from the connector on the system board.
11. Disconnect the system fan cable from the connector on the system board.
12. Disconnect the touchscreen cable from the connector on the system board.
13. Disconnect the camera cable from the connector on the system board.
14. Remove the nine screws (M3x5) that secure the system board to the display-assembly base.
15. Lift and remove the system board from the display-assembly base.

Installing the system board

Prerequisites

If you are replacing a component, remove the existing component before performing the installation procedure.

About this task

The following image indicates the connectors on your system board.

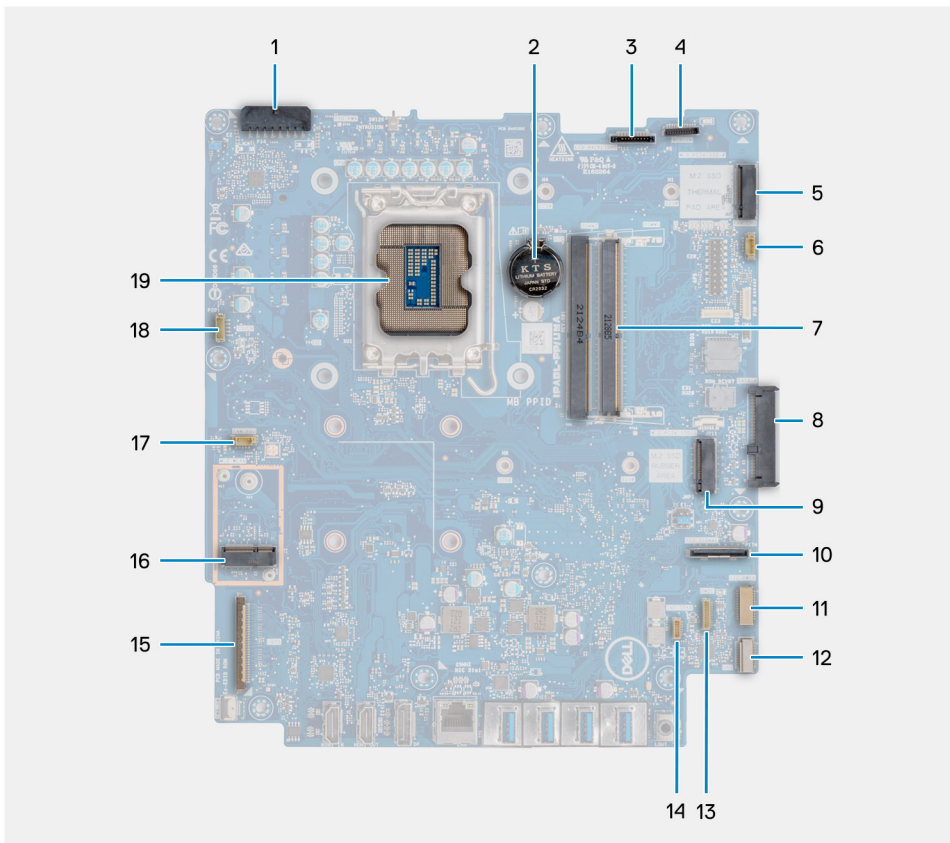

1. Power-supply unit (PSU) cable connector
2. Coin-cell battery
3. Display back-light cable connector
4. Camera cable connector
5. M.2 2230/2280 solid-state drive connector
6. Processor-fan cable connector
7. Memory modules
8. Hard-drive connector
9. M.2 2230/2280 solid-state drive connector
10. Side I/O-signal cable connector
11. Side I/O-power cable connector
12. Audio-board cable connector
13. Microphone-module cable connector
14. Speaker cable connector
15. Display cable connector
16. M.2 WLAN connector
17. PSU-fan cable connector
18. Touchscreen cable connector
19. Processor

The following image indicates the location of the system board and provides a visual representation of the installation procedure.



9x
M3x5

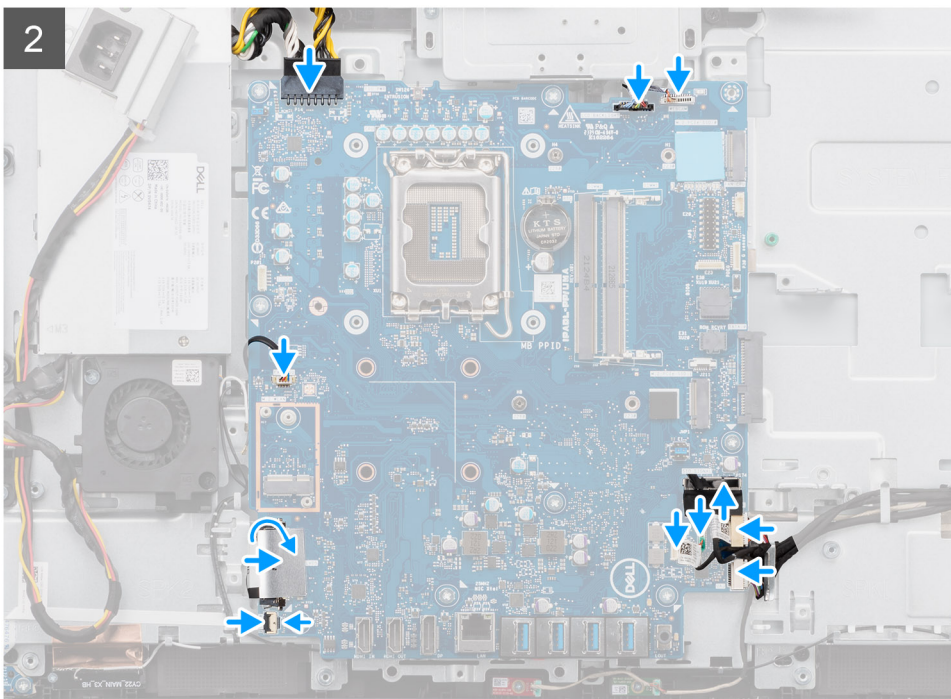
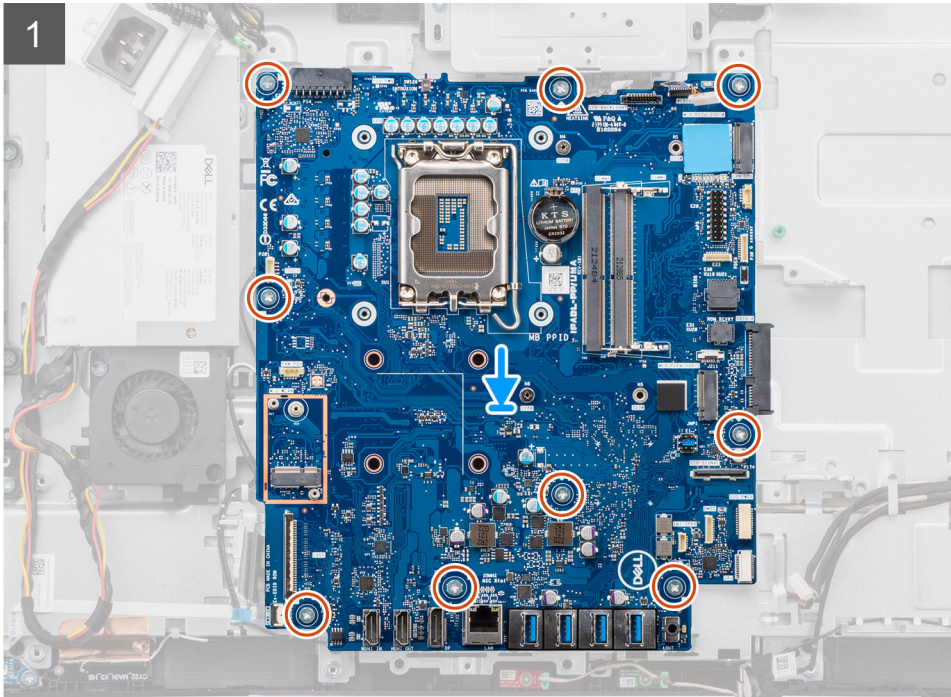
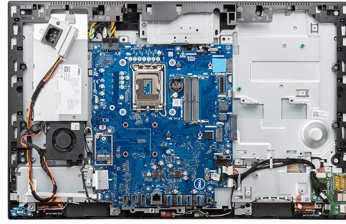

Steps

1. Align the screw holes on the system board with the screw holes on the display-assembly base.
2. Replace the nine screws (M3x5) to secure the system board to the display-assembly base.

3. Connect the camera cable to the connector system board.
4. Connect the touchscreen cable to the system board.
5. Connect the system fan cable to the system board.
6. Connect the audio-board cable to the system board.
7. Connect the SIO-power cable to the system board.
8. Connect the SIO-signal cable to the system board.
9. Connect the microphone-module cable to the system board.
10. Connect the speaker cable to the system board.
11. Connect the power-button board cable to the system board and close the latch to secure the cable.
12. Connect the PSU-fan cable to the system board.
13. Connect the PSU cable to the system board.
14. Connect the display cable to the system board.
15. Connect the display back-light cable to the system board.

NOTE: Ensure the display back-light cable is routed under the system board and not to the side of the system board to avoid the cable getting caught between the system board and the camera. This damages the cable, and the camera may not lock in a closed position.

Next steps

1. Install the [rear-I/O bracket](#).
2. Install the [bottom cover](#).
3. Install the [coin-cell battery](#).
4. Install the [processor](#).
5. Install the [heat sink](#).
6. Install the [M.2 solid-state drive](#).
7. Install the [wireless card](#).
8. Install the [memory modules](#).
9. Install the [system-board shield](#).
10. Install the [hard drive](#).
11. Install the [back cover](#).
12. Install the [cable cover](#) (optional).
13. Install the [stand](#).
14. Follow the procedure in [After working inside your computer](#).

NOTE: Your computer's Service Tag is stored in the system board. You must enter the Service Tag in the BIOS setup program after you replace the system board.

NOTE: Replacing the system board removes any changes you have made to the BIOS using the BIOS setup program. You must make the appropriate changes again after you replace the system board.

Speakers

Removing the speakers

Prerequisites

1. Follow the procedure in [Before working inside your computer](#).
2. Remove the [stand](#).
3. Remove the [cable cover](#) (optional).
4. Remove the [back cover](#).
5. Remove the [system-board shield](#).
6. Remove the [bottom cover](#).
7. Remove the [rear-I/O bracket](#).

About this task

The following image indicates the location of the speakers and provides a visual representation of the removal procedure.

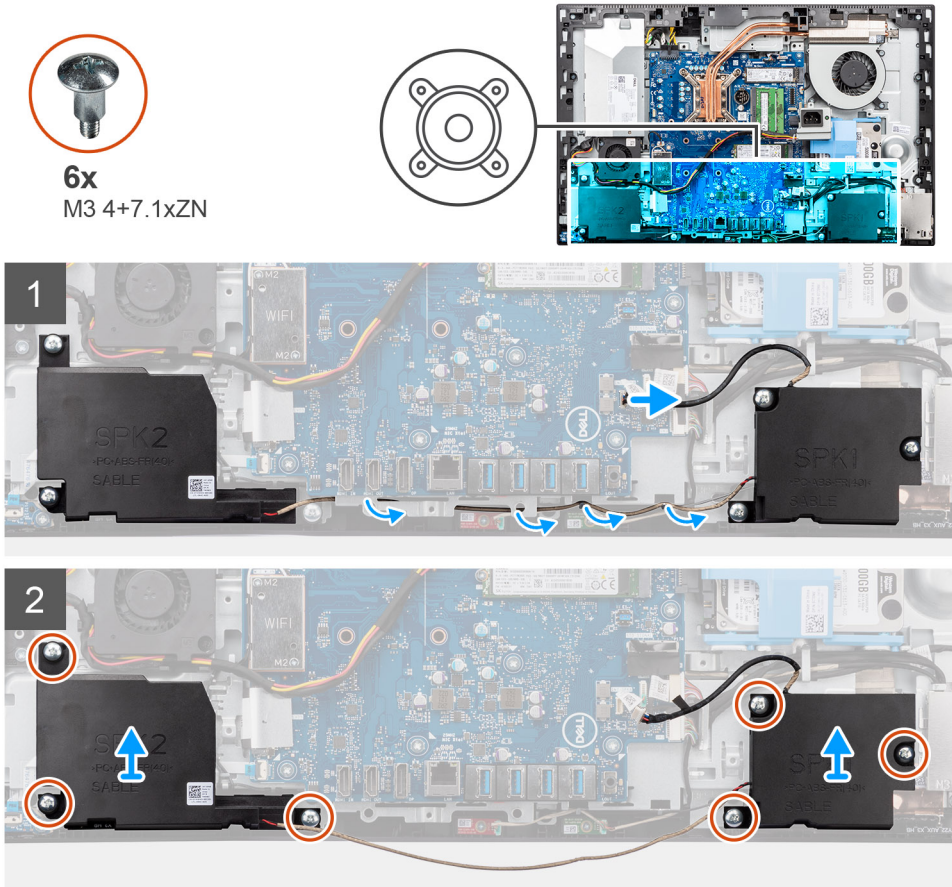

Steps

1. Disconnect the speaker cable from the connector on the system board.
2. Remove the six screws (M3 4+7.1xZN) that secure the speakers to the display-assembly base.
3. Remove the speaker cable from the routing guides on the display-assembly base.
4. Lift the speakers along with the cable off the display-assembly base.

Installing the speakers

Prerequisites

If you are replacing a component, remove the existing component before performing the installation procedure.

About this task

The following image indicates the location of the speakers and provides a visual representation of the installation procedure.



6x
M3 4+7.1xZN

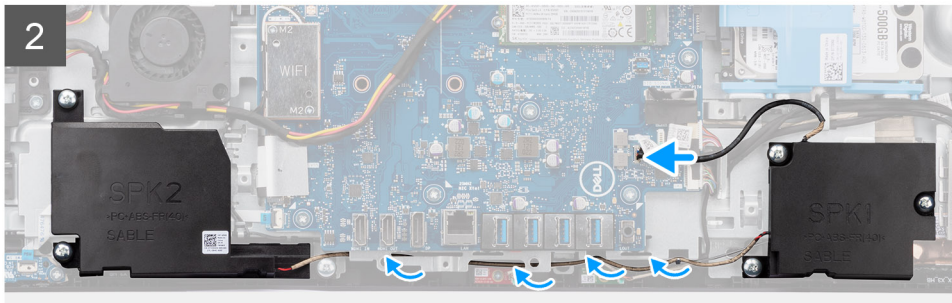
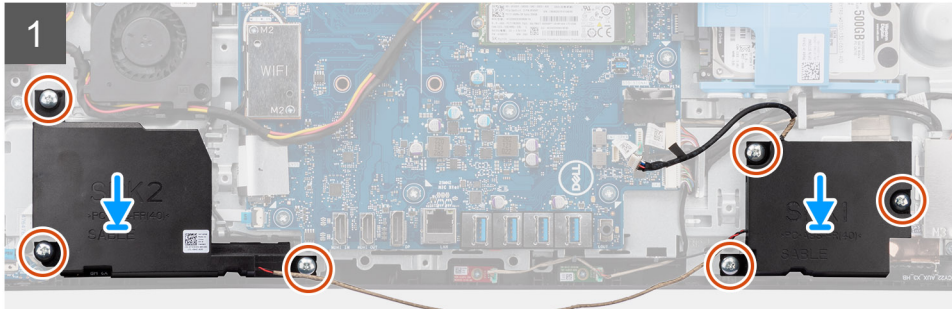
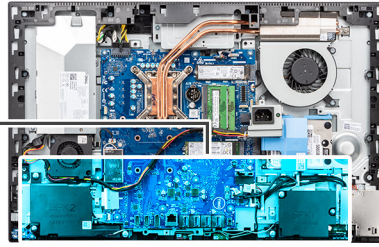
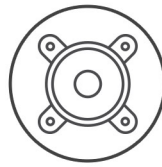

Steps

1. Align the screw holes on the speakers with the screw holes on the display-assembly base.
2. Replace the six screws (M3 4+7.1xZN) to secure the speakers to the display-assembly base.
3. Route the speaker cable through the routing guide on display-assembly base and connect the speaker cable to the system board.

Next steps

1. Install the [rear-I/O bracket](#).
2. Install the [bottom cover](#).
3. Install the [system-board shield](#).
4. Install the [back cover](#).
5. Install the [cable cover](#) (optional).
6. Install the [stand](#).
7. Follow the procedure in [After working inside your computer](#).

Power-button board

Removing the power-button board

Prerequisites

1. Follow the procedure in [Before working inside your computer](#).
2. Remove the [stand](#).
3. Remove the [cable cover](#) (optional).
4. Remove the [back cover](#).

5. Remove the [system-board shield](#).
6. Remove the [bottom cover](#).
7. Remove the [rear-I/O bracket](#).
8. Remove the [speakers](#).

About this task

The following image indicates the location of the power-button board and provides a visual representation of the power-button board removal procedure.



1x
M3x5

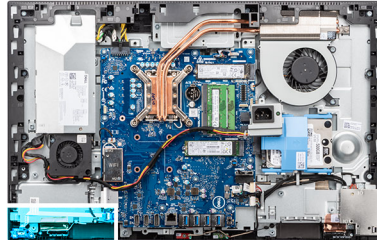

Steps

1. Open the latch and disconnect the power-button cable from the connector on the system board.
2. Remove the screw (M3x5) that secures the power-button board to the middle frame.
3. Lift the power-button board along with cable off the middle frame.

Installing the power-button board

Prerequisites

If you are replacing a component, remove the existing component before performing the installation procedure.

About this task

The following image indicates the location of the power-button board and provides a visual representation of the power-button board installation procedure.



1x
M3x5

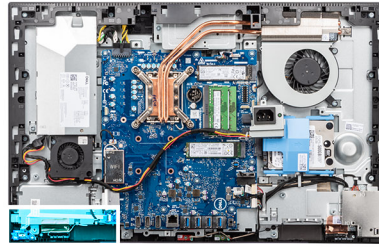

Steps

1. Align and place the power-button board in the slot on the middle frame.
2. Replace the screw (M3x5) to secure the power-button board to the middle frame.
3. Slide the power-button cable into the connector on the system board and close the latch to secure the cable.

Next steps

1. Install the [speakers](#).
2. Install the [rear-I/O bracket](#).
3. Install the [bottom cover](#).
4. Install the [system-board shield](#).
5. Install the [back cover](#).
6. Install the [cable cover](#) (optional).
7. Install the [stand](#).
8. Follow the procedure in [After working inside your computer](#).

Microphones

Removing the microphones

Prerequisites

1. Follow the procedure in [Before working inside your computer](#).
2. Remove the [stand](#).
3. Remove the [cable cover](#) (optional).
4. Remove the [back cover](#).
5. Remove the [system-board shield](#).

6. Remove the [bottom cover](#).
7. Remove the [rear-I/O bracket](#).
8. Remove the [speakers](#).

About this task

The following image indicates the location of the microphones and provides a visual representation of the removal procedure.



2x
M2x2.5

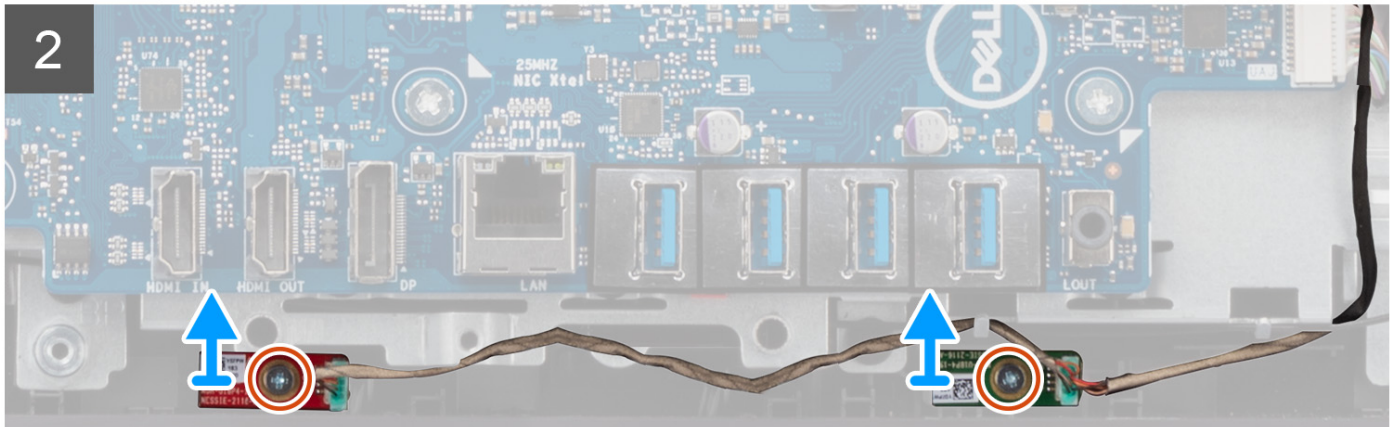
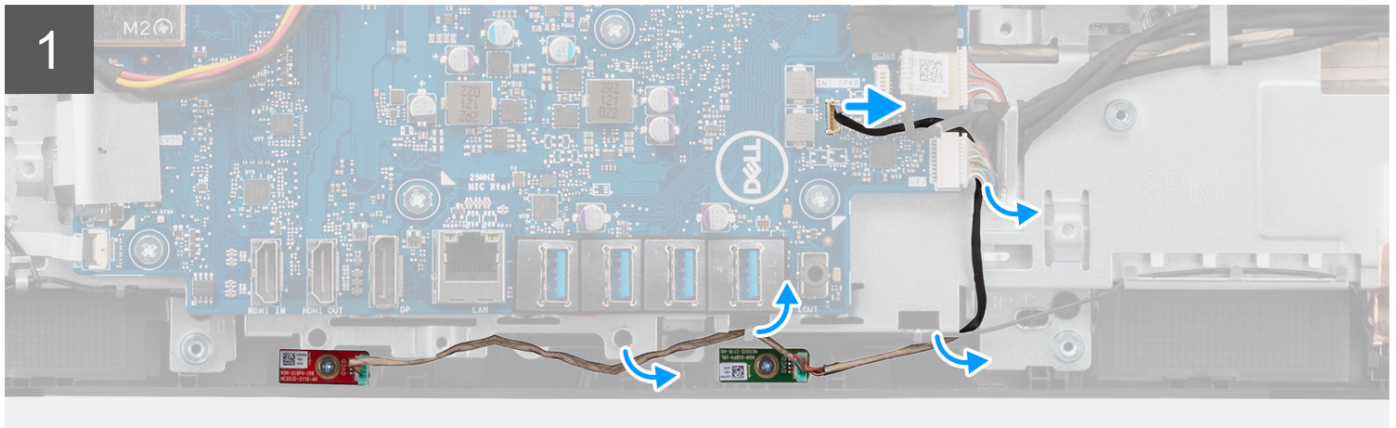
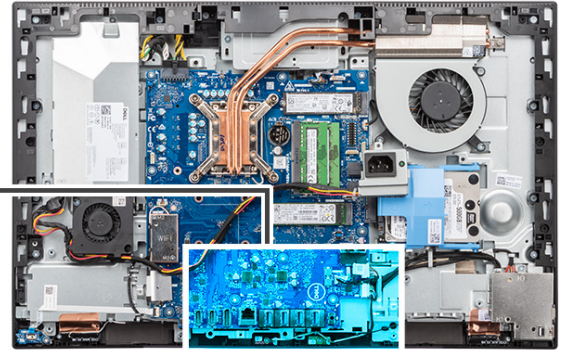

Steps

1. Disconnect the microphone cable from the system board, and unroute it from the routing guides on the display-assembly base.
2. Remove the two screws (M2x2.5) that secure the microphone modules to the middle frame.
3. Lift the microphone modules off the slots on the middle frame.

Installing the microphones

Prerequisites

If you are replacing a component, remove the existing component before performing the installation procedure.

About this task

The following image indicates the location of the microphones and provides a visual representation of the installation procedure.



2x
M2x2.5

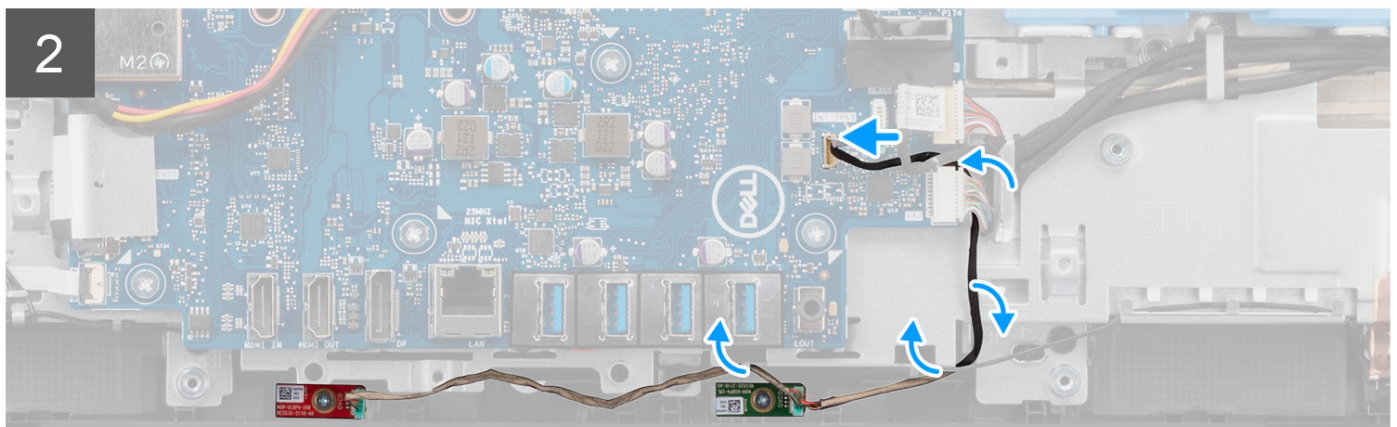
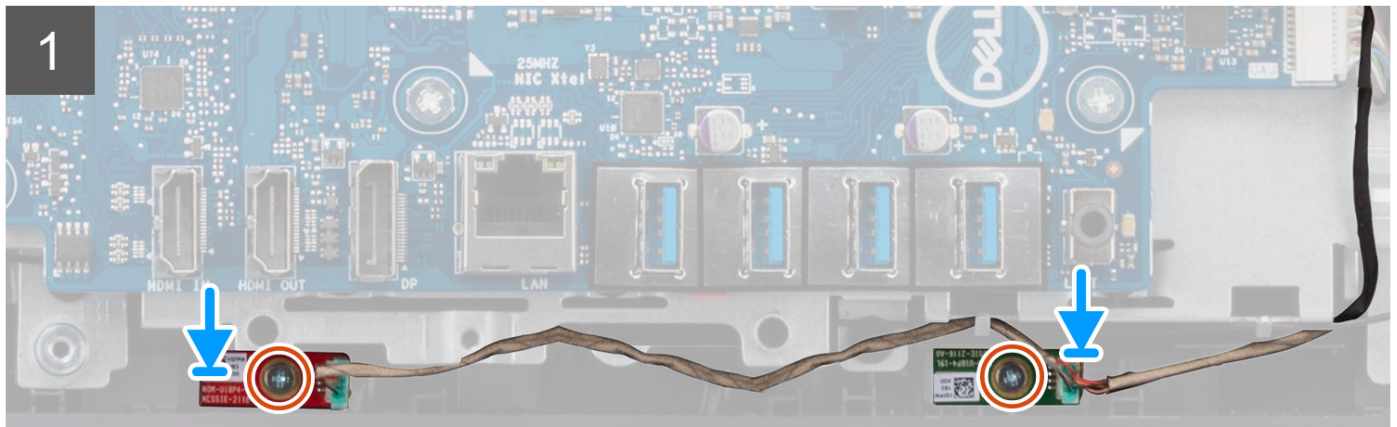
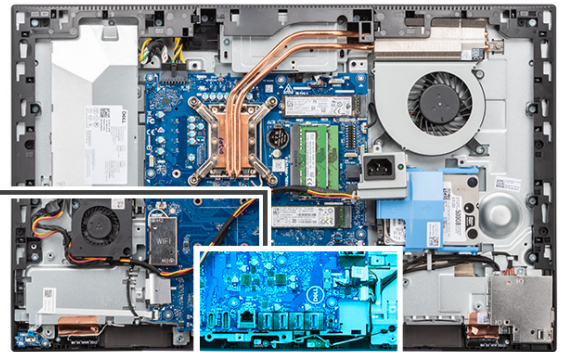

Steps

1. Align the screw holes on the microphone modules with the screw holes on the middle frame.
2. Replace the two screws (M2x2.5) to secure the microphone modules to the middle frame.
3. Route the microphone cable through the routing guides on the display-assembly base and connect the microphone cable to the system board.

Next steps

1. Install the [speakers](#).
2. Install the [rear-I/O bracket](#).
3. Install the [bottom cover](#).
4. Install the [system-board shield](#).
5. Install the [back cover](#).
6. Install the [cable cover](#) (optional).
7. Install the [stand](#).
8. Follow the procedure in [After working inside your computer](#).

Side I/O-board

Removing the side I/O-board

Prerequisites

1. Follow the procedure in [Before working inside your computer](#).
2. Remove the [stand](#).
3. Remove the [cable cover](#) (optional).
4. Remove the [back cover](#).
5. Remove the [system-board shield](#).
6. Remove the [bottom cover](#).
7. Remove the [rear-I/O bracket](#).

About this task

The following image indicates the location of the side I/O-board and provides a visual representation of the removal procedure.

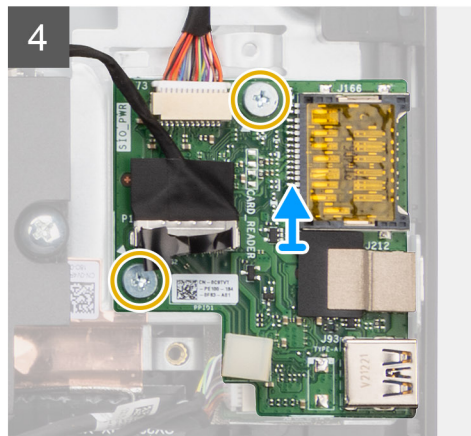
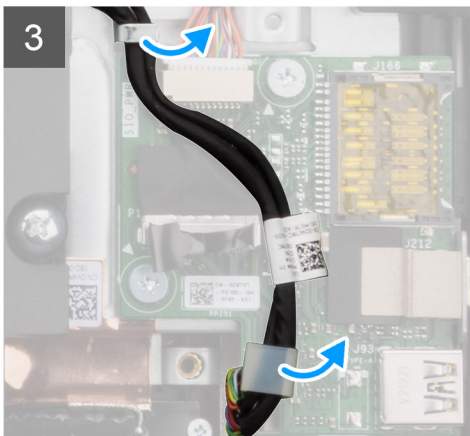
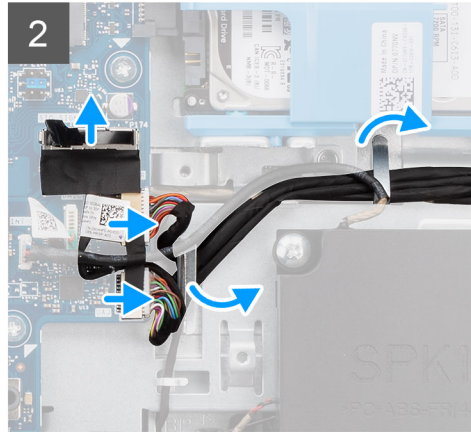
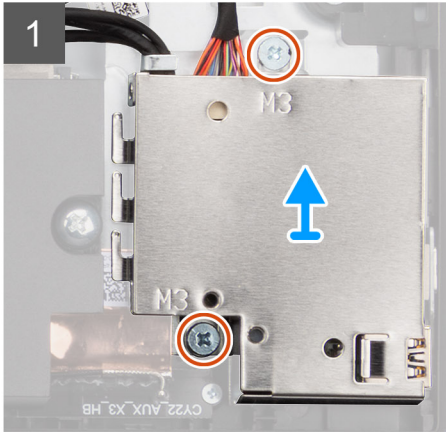
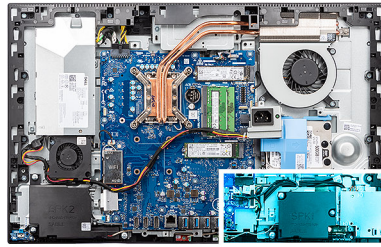
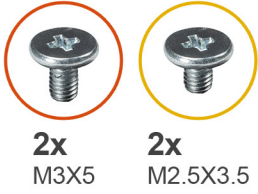

Steps

1. Remove the two screws (M3x5) that secure the side I/O-board shield to the display-assembly base.
2. Lift and remove the side I/O-board shield off the side I/O-board.
3. Disconnect the SIO-signal cable, SIO-power cable, and audio-board cable from the system board.
4. Remove the SIO-signal cable, SIO-power cable, and audio-board cable from the routing guides on the display-assembly base.
5. Remove the two screws (M2.5x3.5) that secure the side I/O-board to the display-assembly base.
6. Lift and remove the side I/O-board with cables off the display-assembly base.

Installing the side I/O-board

Prerequisites

If you are replacing a component, remove the existing component before performing the installation procedure.

About this task

The following image indicates the location of the side I/O-board and provides a visual representation of the installation procedure.

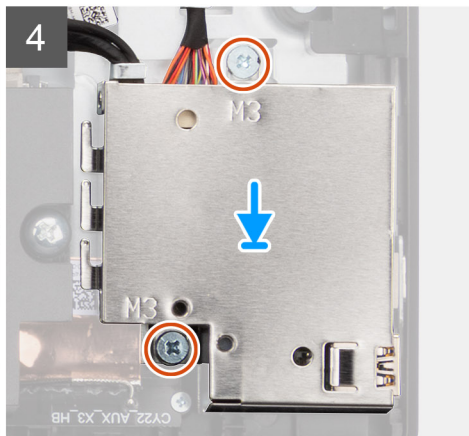
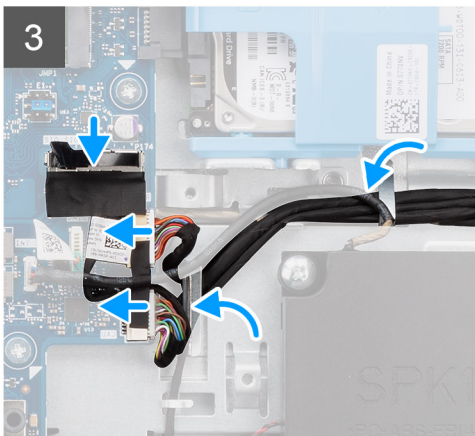
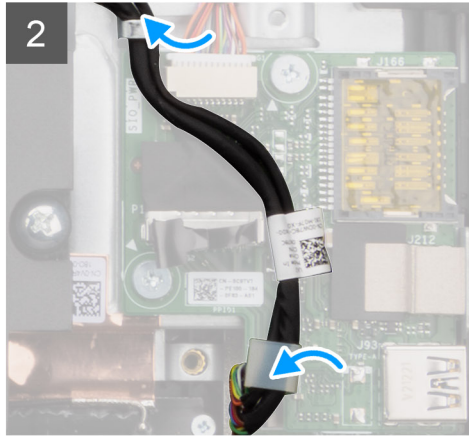
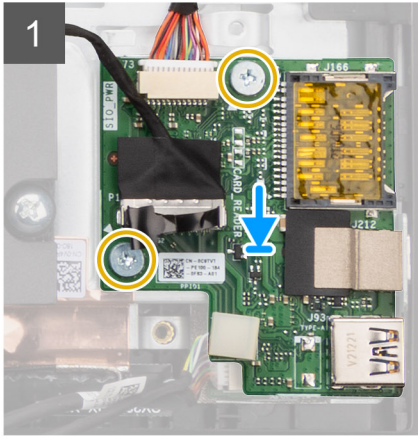
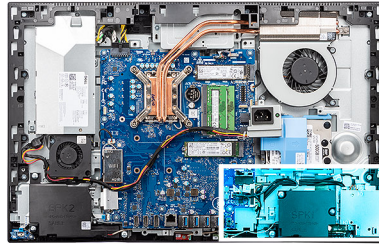

Steps

1. Align the screw holes on the side I/O-board with the screw holes on the display-assembly base.
2. Replace the two screws (M2.5x3.5) to secure the side I/O-board to the display-assembly base.
3. Route the SIO-signal cable, SIO-power cable, and audio-board cable through the routing guides on the display-assembly base.
4. Connect the SIO-signal cable, SIO-power cable, and audio-board cable to the connectors on the system board.
5. Align the screw holes on the side I/O-board shield with the screw holes on the display-assembly base.
6. Replace the two screws (M3x5) to secure the side I/O-board shield to the display-assembly base.

Next steps

1. Install the [rear-I/O bracket](#).
2. Install the [bottom cover](#).
3. Install the [system-board shield](#).
4. Install the [back cover](#).
5. Install the [cable cover](#) (optional).
6. Install the [stand](#).
7. Follow the procedure in [After working inside your computer](#).

Audio board

Removing the audio board

Prerequisites

1. Follow the procedure in [Before working inside your computer](#).
2. Remove the [stand](#).
3. Remove the [cable cover](#) (optional).
4. Remove the [back cover](#).
5. Remove the [system-board shield](#).
6. Remove the [bottom cover](#).
7. Remove the [rear-I/O bracket](#).
8. Remove the [side-I/O board](#).

About this task

The following image indicates the location of the audio board and provides a visual representation of the installation procedure.



1x
M3x5

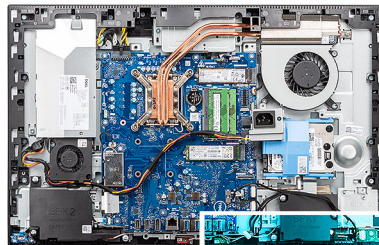

Steps

1. Disconnect the audio-board cable from the connector on the system board.
2. Remove the screw (M3x5) that secure the audio board to the display-assembly base.
3. Lift and remove the audio board with the cable off the display-assembly base.

Installing the audio board

Prerequisites

If you are replacing a component, remove the existing component before performing the installation procedure.

About this task

The following image indicates the location of the audio board and provides a visual representation of the removal procedure.



1x
M3x5

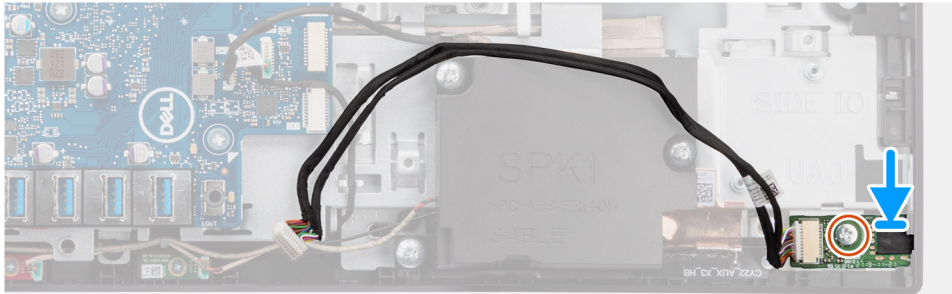
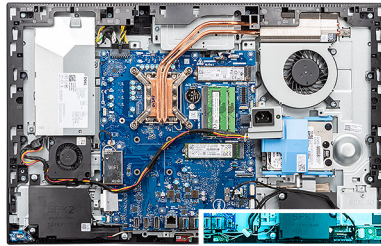

Steps

1. Align the screw hole on the audio board with the screw hole on the display-assembly base.
2. Replace the screw (M3x5) to secure the audio board to the display-assembly base.
3. Connect the audio-board cable to the system board.

Next steps

1. Install the [side-I/O board](#).
2. Install the [rear-I/O bracket](#).
3. Install the [bottom cover](#).
4. Install the [system-board shield](#).
5. Install the [back cover](#).
6. Install the [cable cover](#) (optional).
7. Install the [stand](#).
8. Follow the procedure in [After working inside your computer](#).

Antenna modules

Removing the antenna modules

Prerequisites

1. Follow the procedure in [Before working inside your computer](#).
2. Remove the [stand](#).
3. Remove the [cable cover](#) (optional).
4. Remove the [back cover](#).
5. Remove the [system-board shield](#).
6. Remove the [wireless card](#).
7. Remove the [bottom cover](#).
8. Remove the [rear-I/O bracket](#).
9. Remove the [speakers](#).

About this task

The following image indicates the location of the antenna modules and provides a visual representation removal procedure of the antenna modules.



2x
M2X2.5

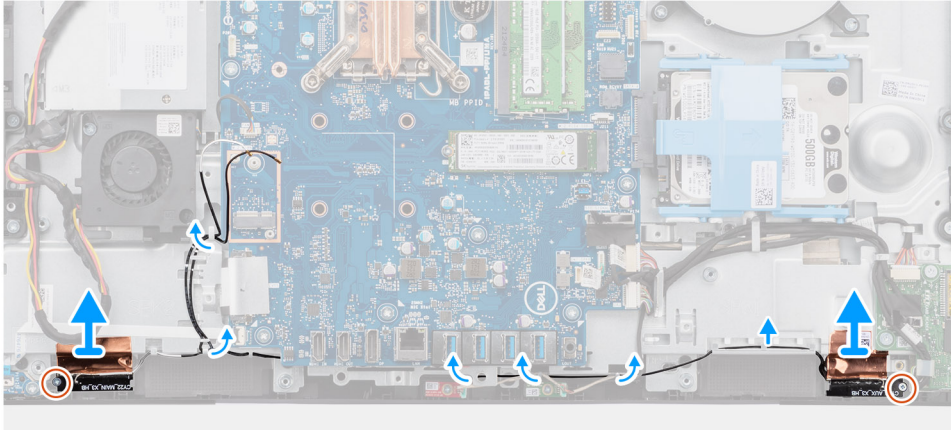
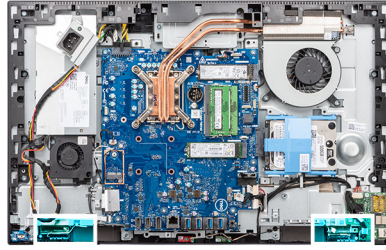

Steps

1. Remove the antenna cables from the routing guides on the display-assembly base.
2. Remove the two screws (M2x2.5) that secure the antenna modules to the middle frame.
3. Carefully peel the copper foil that secures the antenna cables to the middle frame.
4. Lift the antenna modules off the middle frame.

Installing the antenna modules

Prerequisites

If you are replacing a component, remove the existing component before performing the installation procedure.

About this task

The following image indicates the location of the antenna modules and provides a visual representation of the antenna modules installation procedure.



2x
M2X2.5

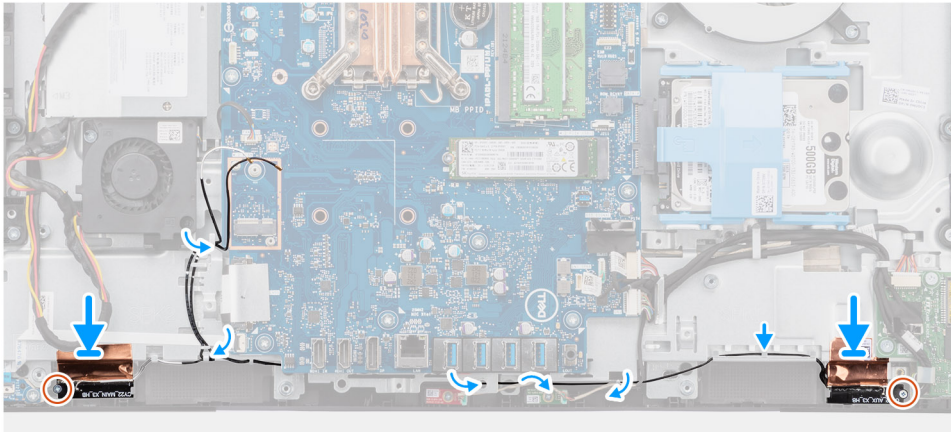
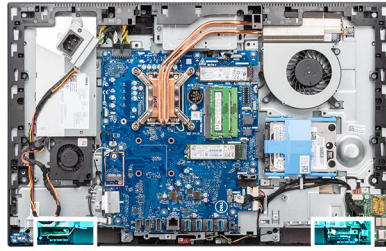

Steps

1. Align and place the antenna modules in the slots on the middle frame.
2. Adhere the copper foil that secures the antenna cables to the middle frame.
3. Replace the two screws (M2x2.5) to secure the antenna modules to the middle frame.
4. Route the antenna cables through the routing guides on the display-assembly base.

Next steps

1. Install the [speakers](#).
2. Install the [rear-I/O bracket](#).
3. Install the [bottom cover](#).
4. Install the [wireless card](#).
5. Install the [system-board shield](#).
6. Install the [back cover](#).
7. Install the [cable cover](#) (optional).
8. Install the [stand](#).
9. Follow the procedure in [After working inside your computer](#).

Display panel

Removing the display panel

Prerequisites

1. Follow the procedure in [Before working inside your computer](#).
2. Remove the [stand](#).
3. Remove the [cable cover](#) (optional).
4. Remove the [back cover](#).
5. Remove the [system-board shield](#).
6. Remove the [hard drive](#).
7. Remove the [bottom cover](#).
8. Remove the [rear-I/O bracket](#).

9. Remove the [speakers](#).
10. Remove the [camera assembly](#).
11. Remove the [system board](#).
12. Remove the [PSU fan](#).
13. Remove the [PSU](#).

About this task

The following image indicates the location of the display panel and provides a visual representation of the display panel removal procedure.



12x
M3x5

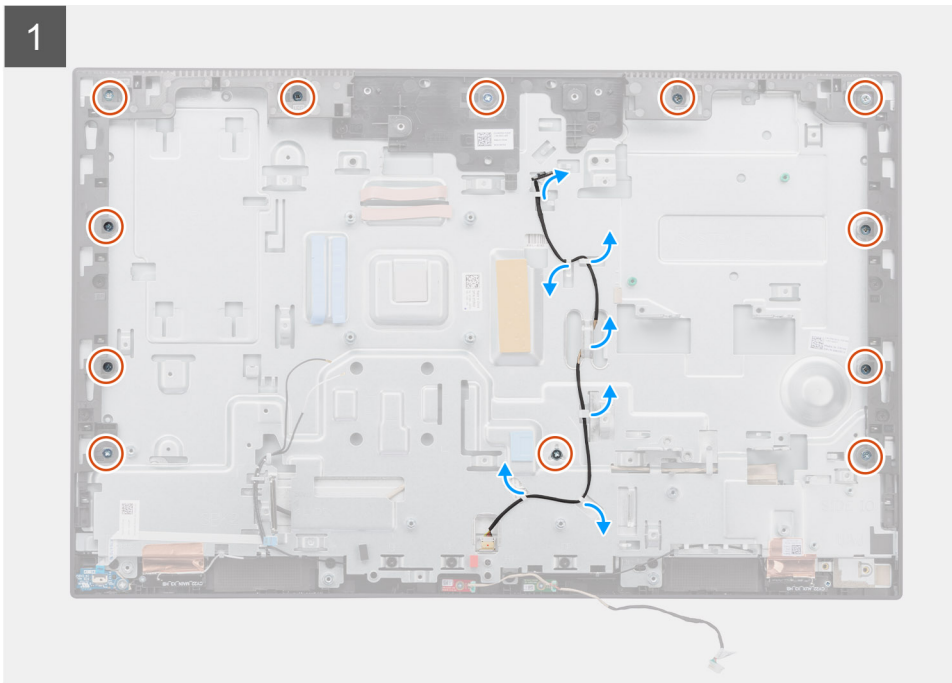

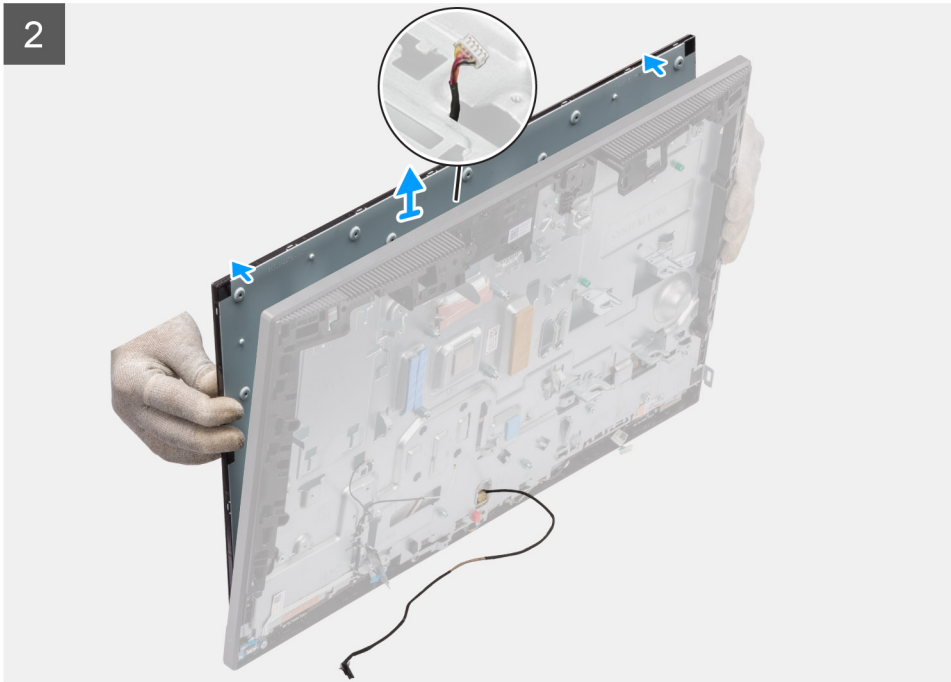

Steps

1. Remove the 11 screws (M3x5) (for touch display) and 12 screws (M3x5) (for non-touch display) that secure the display panel to the middle frame and display-assembly base.
2. Unroute the display back-light cable from the routing guides on the display-assembly base.
3. Place the system in an upright position.
4. Holding the top corner, release the display panel away from the middle frame and display-assembly base.
5. Route the display back-light and display cable through the slots on the display-assembly base.
6. Lift the display panel up from the middle frame and display-assembly base.

Installing the display panel

Prerequisites

If you are replacing a component, remove the existing component before performing the installation procedure.

About this task

The following image indicates the location of the display panel and provides a visual representation of the display panel installation procedure.



12x
M3x5

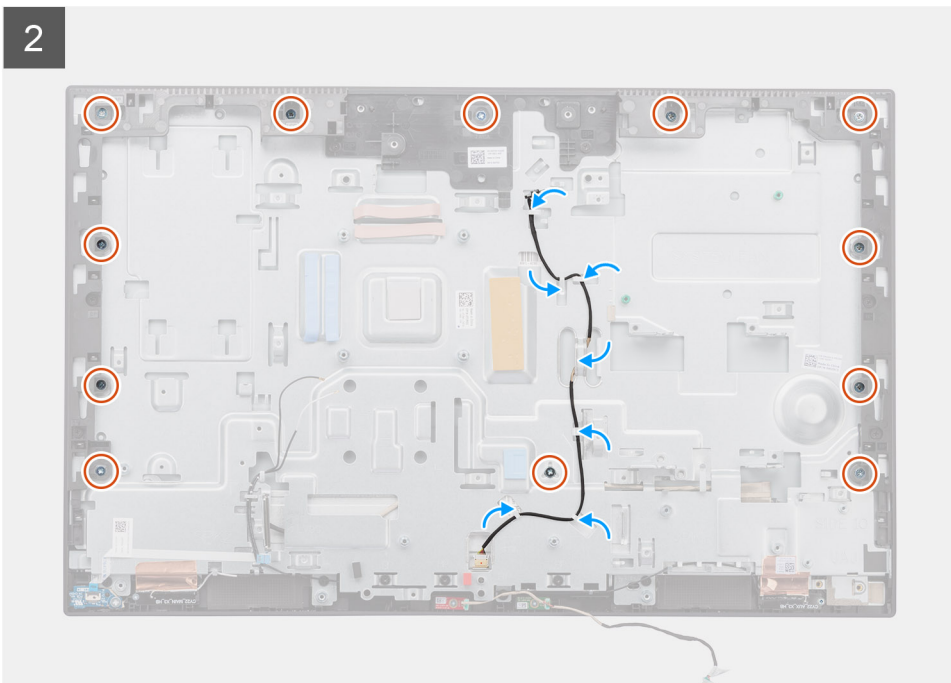
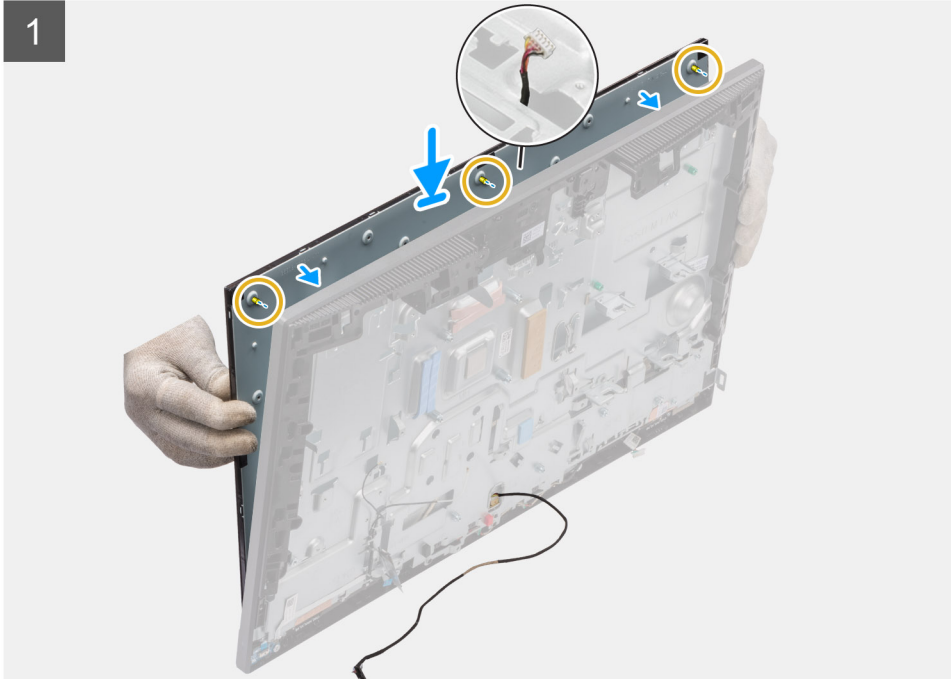

Steps

1. Place the system in an upright position, and slide the display panel on the slots of the display-assembly base.
2. Route the display-backlight, and display cable through the slots on the display-assembly base.
3. Place the display-assembly base on a clean and flat surface with the display panel facing down.

4. Replace the nine screws (M3x5) (for touch display) and ten screws (M3x5) (for non-touch display) to secure the display panel to the middle frame and display-assembly base.
5. Remove the two jig screws from the display panel and replace with two screws (M3x5) to secure the display panel to the middle frame and display assembly base.

 **NOTE:** The jig screw is shipped with the replacement display panel. It is used to align the display panel to the display-assembly base.

6. Route the display back-light cable in the routing guides on the display-assembly base.

Next steps

1. Install the [PSU](#).
2. Install the [PSU fan](#).
3. Install the [system board](#).
4. Install the [camera assembly](#).
5. Install the [speakers](#).
6. Install the [rear-I/O bracket](#).
7. Install the [bottom cover](#).
8. Install the [hard drive](#).
9. Install the [system-board shield](#).
10. Install the [back cover](#).
11. Install the [cable cover](#) (optional).
12. Install the [stand](#).
13. Follow the procedure in [After working inside your computer](#).

Middle frame

Removing the middle frame

Prerequisites

1. Follow the procedure in [Before working inside your computer](#).
2. Remove the [stand](#).
3. Remove the [cable cover](#) (optional).
4. Remove the [back cover](#).
5. Remove the [system-board shield](#).
6. Remove the [hard drive](#).
7. Remove the [bottom cover](#).
8. Remove the [rear-I/O bracket](#).
9. Remove the [speakers](#).
10. Remove the [camera assembly](#).
11. Remove the [system board](#).
12. Remove the [power-button board](#).
13. Remove the [microphones](#).
14. Remove the [PSU fan](#).
15. Remove the [PSU](#).
16. Remove the [side-I/O board](#).
17. Remove the [antenna modules](#).
18. Remove the [display panel](#).

About this task

The following image indicates the location of the middle frame and provides a visual representation of the middle frame removal procedure.



17x
M3x5

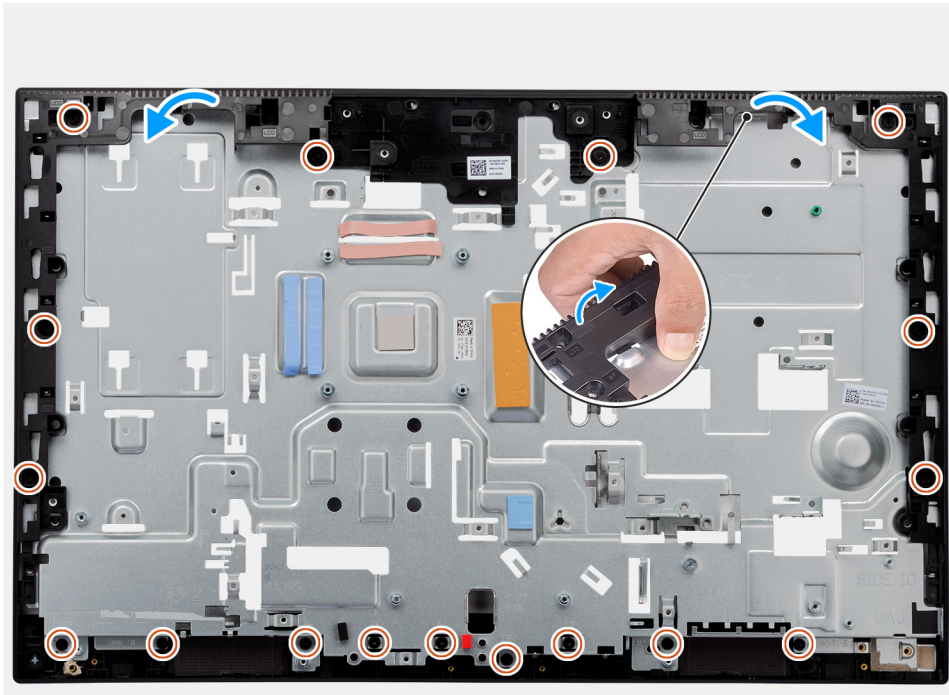

Steps

1. Remove the 17 screws (M3x5) that secure the middle frame to the display-assembly base.
2. Remove the middle frame and lift the middle frame off the display-assembly base.

Installing the middle frame

Prerequisites

If you are replacing a component, remove the existing component before performing the installation procedure.

About this task

The following image indicates the location of the middle frame and provides a visual representation of the middle frame installation procedure.



17x
M3x5

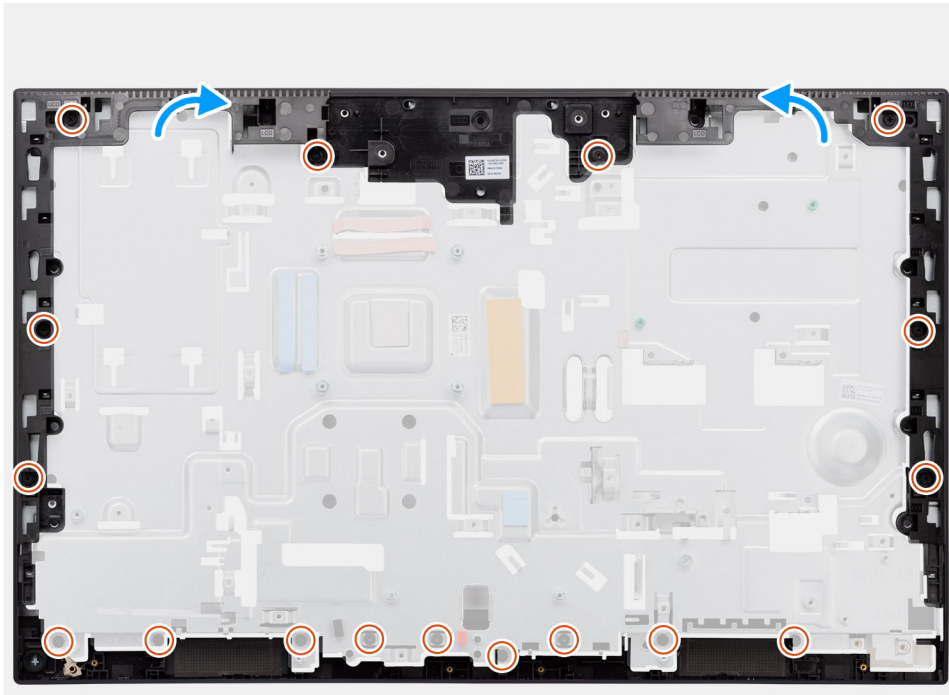

Steps

1. Slide and align the middle frame to the slots on the display-assembly base, then snap the middle frame into place on the display-assembly base.
2. Replace the 17 screws (M3x5) to secure the middle frame to the display-assembly base.

Next steps

1. Install the [display panel](#).
2. Install the [antenna modules](#).
3. Install the [side-I/O board](#).
4. Install the [PSU](#).
5. Install the [PSU fan](#).
6. Install the [microphones](#).
7. Install the [power-button board](#).
8. Install the [system board](#).
9. Install the [camera assembly](#).
10. Install the [speakers](#).
11. Install the [rear-I/O bracket](#).
12. Install the [bottom cover](#).
13. Install the [wireless card](#).
14. Install the [hard drive](#).
15. Install the [system-board shield](#).
16. Install the [back cover](#).
17. Install the [cable cover](#) (optional).
18. Install the [stand](#).
19. Follow the procedure in [After working inside your computer](#).

Drivers and downloads

When troubleshooting, downloading or installing drivers it is recommended that you read the Dell Knowledge Based article, Drivers and Downloads FAQ [000123347](#).

BIOS setup

CAUTION: Unless you are an expert computer user, do not change the settings in the BIOS Setup program. Certain changes can make your computer work incorrectly.

NOTE: Depending on the computer and its installed devices, the items listed in this section may or may not be displayed.

NOTE: Before you change BIOS Setup program, it is recommended that you write down the BIOS Setup program screen information for future reference.

Use the BIOS Setup program for the following purposes:

- Get information about the hardware installed in your computer, such as the amount of RAM and the size of the hard drive.
- Change the system configuration information.
- Set or change a user-selectable option, such as the user password, type of hard drive installed, and enabling or disabling base devices.

Entering BIOS setup program

About this task

Turn on (or restart) your computer and press F2 immediately.

Navigation keys

NOTE: For most of the System Setup options, changes that you make are recorded but do not take effect until you restart the system.

Table 3. Navigation keys

Keys	Navigation
Up arrow	Moves to the previous field.
Down arrow	Moves to the next field.
Enter	Selects a value in the selected field (if applicable) or follow the link in the field.
Spacebar	Expands or collapses a drop-down list, if applicable.
Tab	Moves to the next focus area. NOTE: For the standard graphics browser only.
Esc	Moves to the previous page until you view the main screen. Pressing Esc in the main screen displays a message that prompts you to save any unsaved changes and restarts the system.

One time boot menu

To enter **one time boot menu**, turn on your computer, and then press F12 immediately.

NOTE: It is recommended to shutdown the computer if it is on.

The one-time boot menu displays the devices that you can boot from including the diagnostic option. The boot menu options are:

- Removable Drive (if available)
- STXXXX Drive (if available)
- **i** **NOTE:** XXX denotes the SATA drive number.
- Optical Drive (if available)
- SATA Hard Drive (if available)
- Diagnostics

The boot sequence screen also displays the option to access the System Setup screen.

System setup options

i **NOTE:** Depending on your computer and its installed devices, the items listed in this section may or may not appear.

Table 4. System setup options—System information menu

Overview	
OptiPlex 5400 All-in-One	
BIOS Version	Displays the BIOS version number.
Service Tag	Displays the Service Tag of the computer.
Asset Tag	Displays the Asset Tag of the computer.
Manufacture Date	Displays the manufacture date of the computer.
Ownership Date	Displays the ownership date of the computer.
Express Service Code	Displays the express service code of the computer.
Ownership Tag	Displays the Ownership Tag of the computer.
Signed Firmware Update	Displays whether the Signed Firmware Update is enabled on your computer.
Processor Information	
Processor Type	Displays the processor type.
Maximum Clock Speed	Displays the maximum processor clock speed.
Minimum Clock Speed	Displays the minimum processor clock speed.
Current Clock Speed	Displays the current processor clock speed.
Core Count	Displays the number of cores on the processor.
Processor ID	Displays the processor identification code.
Processor L2 Cache	Displays the processor L2 Cache size.
Processor L3 Cache	Displays the processor L3 Cache size.
Microcode Version	Displays the microcode version.
Intel Hyper-Threading Capable	Displays whether the processor is Hyper-Threading (HT) capable.
64-Bit Technology	Displays whether 64-bit technology is used.
Memory Information	
Memory Installed	Displays the total computer memory installed.
Memory Available	Displays the total computer memory available.
Memory Speed	Displays the memory speed.
Memory Channel Mode	Displays single or dual channel mode.
Memory Technology	Displays the technology used for the memory.

Table 4. System setup options—System information menu (continued)

Overview	
DIMM_SLOT 1	Displays the DIMM 1 memory size.
DIMM_SLOT 2	Displays the DIMM 2 memory size.
Devices Information	
Panel Type	Displays the Panel Type of the computer.
Video Controller	Displays the video controller type of the computer.
Video Memory	Displays the video memory information of the computer.
Wi-Fi Device	Displays the wireless device information of the computer.
Native Resolution	Displays the native resolution of the computer.
Video BIOS Version	Displays the video BIOS version of the computer.
Audio Controller	Displays the audio controller information of the computer.
Bluetooth Device	Displays the Bluetooth device information of the computer.
LOM MAC Address	Displays the LAN On Motherboard (LOM) MAC address of the computer.
Slot 1	Displays the M.2 network information of the computer
SATA 0	Displays the SATA hard drive information of the computer.
Slot 2_M.2	Displays the M.2 PCIe SSD information of the computer.
Slot 3_M.2	Displays the M.2 PCIe SSD information of the computer.

Table 5. System setup options—Boot Configuration menu

Boot Configuration	
Boot Sequence	
Boot mode	Displays the boot mode.
Boot Sequence	Displays the boot sequence.
Secure Digital (SD) Card Boot	Enable or disable the SD card read-only boot. By default, the Secure Digital (SD) Card Boot option is not enabled.
Secure Boot	
Enable Secure Boot	Enable or disable the secure boot feature. By default, the option is not enabled.
Secure Boot Mode	Enable or disable to change the secure boot mode options. By default, the Deployed Mode is enabled.
Expert Key Management	
Enable Custom Mode	Enable or disable custom mode. By default, the custom mode option is not enabled.
Custom Mode Key Management	Select the custom values for expert key management.

Table 6. System setup options—Integrated Devices menu

Integrated Devices	
Date/Time	Displays the current date in MM/DD/YYYY format and current time in HH:MM:SS AM/PM format.
Camera	Enables or disable the camera. By default, the Enable Camera option is selected

Table 6. System setup options—Integrated Devices menu (continued)

Integrated Devices	
Audio	
Enable Audio	Enable or disable the integrated audio controller. By default, all the options are enabled.
USB Configuration	<ul style="list-style-type: none"> Enable or disable booting from USB mass storage devices through the boot sequence or boot menu. By default, all the options are enabled.
Side USB Configuration	Enable or disable the individual side USB ports. By default, the Side USB Port 1 (Bottom) and Side USB Port 2 (Top) option are enabled.
Rear USB Configuration	Enable or disable the individual rear USB ports. By default, all the options are enabled.

Table 7. System setup options—Storage menu

Storage	
SATA Operation	Enable or disable the operating mode of the integrated SATA hard drive controller. By default, the RAID On option is enabled.
Storage Interface	
Port Enablement	Enable or disable the onboard drives. By default, SATA HDD , M.2 PCIe SSD-0 , and M.2 PCIe SSD-1 options are enabled.
SMART Reporting	
Enable SMART Reporting	Enable or disable Self-Monitoring, Analysis, and Reporting Technology (SMART) during computer startup. By default, the Enable SMART Reporting option is not enabled.
Drive Information	
SATA HDD	
Type	Displays the SATA HDD type information of the computer.
Device	Displays the SATA HDD device information of the computer.
M.2 PCIe SSD-0	
Type	Displays the M.2 PCIe SSD-0 type information of the computer.
Device	Displays the M.2 PCIe SSD-0 device information of the computer.
M.2 PCIe SSD-1	
Type	Displays the M.2 PCIe SSD-1 type information of the computer.
Device	Displays the M.2 PCIe SSD-1 device information of the computer.
Enable MediaCard	
Secure Digital (SD) Card	Enable or disable the SD card. By default, the Secure Digital (SD) Card option is enabled.
Secure Digital (SD) Card Read-Only Mode	Enable or disable the SD card read-only mode. By default, the Secure Digital (SD) Card Read-Only Mode option is not enabled.

Table 8. System setup options—Display menu

Display	
OSD Button Management	
Disable OSD Buttons	Enable or disable the OSD (On-Screen Display) buttons on the computer.
Full Screen Logo	
	Enable or disable full screen logo. By default, the option is not enabled.

Table 9. System setup options—Connection menu

Connection	
Network Controller Configuration	
Integrated NIC	Controls the on-board LAN controller. By default, the Enabled with PXE option is enabled.
Wireless Device Enable	
WLAN	Enable or disable the internal WLAN device By default, the option enabled.
Bluetooth	Enable or disable the internal Bluetooth device By default, the option enabled.
Enable UEFI Network Stack	Enable or disable UEFI Network Stack and controls the on-board LAN Controller. By default, the option is enabled.
HTTPs Boot Feature	
HTTPs Boot	Enable or disable the HTTPs Boot feature. By default, the HTTPs Boot option is enabled.
HTTPs Boot Mode	With Auto Mode, the HTTPs Boot extracts Boot URL from the DHCP. With Manual Mode, the HTTPs Boot reads Boot URL from the user-provided data. By default, the Auto Mode option is enabled.

Table 10. System setup options—Power menu

Power	
USB PowerShare	
Enable USB PowerShare	Enable or disable the USB PowerShare. By default, the Enable USB PowerShare option is disabled
USB Wake Support	
Enable USB Wake Support	When enabled, you can use the USB devices like a mouse or keyboard to wake your computer from standby. By default, the option is enabled.
AC Behavior	
AC Recovery	Enables the system to turn on automatically, when AC is inserted. By default, the Power Off option is enabled.
Block Sleep	
	Enables to block entering sleep (S3) mode in the operating system. By default, the Block Sleep option is disabled.
Deep Sleep Control	
	Enable or disable the Deep Sleep mode support.

Table 10. System setup options—Power menu (continued)

Power	
Fan Control Override	<p>By default, the Enabled in S4 and S5 option is enabled.</p> <p>Enable or disable the fan control override feature.</p> <p>By default, the option is disabled.</p>
Intel Speed Shift Technology	<p>Enable or disable the Intel speed shift technology support.</p> <p>By default, the Intel Speed Shift Technology option is enabled.</p>

Table 11. System setup options—Security menu

Security	
TPM 2.0 Security	
TPM 2.0 Security On	<p>Enable or disable TPM 2.0 security options.</p> <p>By default, the TPM 2.0 Security On option is enabled.</p>
Attestation Enable	<p>Enables to control whether the Trusted Platform Module (TPM) Endorsement Hierarchy is available to the operating system.</p> <p>By default, the Attestation Enable option is enabled.</p>
Key Storage Enable	<p>Enables to control whether the Trusted Platform Module (TPM) Storage Hierarchy is available to the operating system.</p> <p>By default, the Key Storage Enable option is enabled.</p>
SHA-256	<p>BIOS and the TPM will use the SHA-256 hash algorithm to extend measurements into the TPM PCRs during BIOS boot.</p> <p>By default, the SHA-256 option is enabled.</p>
Clear	<p>Enables to clear the TPM owner information and returns the TPM to the default state.</p> <p>By default, the Clear option is disabled.</p>
PPI ByPass for Clear Commands	<p>Controls the TPM Physical Presence Interface (PPI).</p> <p>By default, the PPI ByPass for clear Commands option is disabled.</p>
Chassis intrusion	<p>Controls the chassis intrusion feature.</p> <p>By default, the option is disabled.</p>
SMM Security Mitigation	<p>Enable or disable SMM Security Mitigation.</p> <p>By default, the option is enabled.</p>
Data Wipe on Next Boot	
Start Data Wipe	<p>Enable or disable the data wipe on next boot.</p> <p>By default, the option is disabled.</p>
Absolute	<p>Enable or disable or permanently disable the BIOS module interface of the optional Absolute Persistence Module service from Absolute software.</p> <p>By default, the option is enabled.</p>
UEFI Boot Path Security	<p>Controls whether or not the computer will prompt the user to enter the admin password (if set) when booting to a UEFI boot device from the F12 boot menu.</p> <p>By default, the Always Except Internal HDD option is enabled.</p>

Table 12. System setup options—Passwords menu

Passwords	
Admin Password	Set, change, or delete the administrator password.
System Password	Set, change, or delete the computer password.
NVMe SSD0	Set, change, or delete the NVMe SSD0 password.
Password Configuration	
Upper Case Letter	Reinforces password must have at least one upper case letter. By default, the option is disabled.
Lower Case Letter	Reinforces password must have at least one lower case letter. By default, the option is disabled.
Digit	Reinforces password must have at least one digit. By default, the option is disabled.
Special Character	Reinforces password must have at least one special character. By default, the option is disabled.
Minimum Characters	Set the minimum characters allowed for password.
Password Bypass	When enabled, this always prompts for computer and internal hard drive passwords when powered on from the off state. By default, the Disabled option is enabled.
Password Changes	
Enable Non-Admin Password Changes	Enable or disable to change computer and hard drive password without the need for admin password. By default, the option is enabled.
Admin Setup Lockout	
Enable Admin Setup Lockout	Enables administrators control over how their users can or cannot access BIOS setup. By default, the option is disabled.
Master Password Lockout	
Enable Master Password Lockout	When enabled, this will disable the master password support. By default, the option is disabled.
Allow Non-Admin PSID Revert	
Enable Allow Non-Admin PSID Revert	Controls access to the Physical Security ID (PSID) revert of NVMe hard-drives from the Dell Security Manager prompt. By default, the option is disabled.

Table 13. System setup options—Update, Recovery menu

Update, Recovery	
UEFI Capsule Firmware Updates	Enable or disable BIOS updates through UEFI capsule update packages. By default, the option is enabled.
BIOS Recovery from Hard Drive	Enables the user to recover from certain corrupted BIOS conditions from a recovery file on the user primary hard drive or an external USB key. By default, the option is enabled.
BIOS Downgrade	

Table 13. System setup options—Update, Recovery menu (continued)

Update, Recovery	
Allow BIOS Downgrade	<p>Enable or disable the flashing of the computer firmware to previous revision is blocked.</p> <p>By default, the option is enabled.</p>
SupportAssist OS Recovery	<p>Enable or disable the boot flow for SupportAssist OS Recovery tool in the event of certain computer errors.</p> <p>By default, the option is enabled.</p>
BIOSConnect	<p>Enable or disable cloud Service OS recovery if the main operating system fails to boot with the number of failures equal to or greater than the value specified by the Auto OS Recovery Threshold setup option and local Service OS does not boot or is not installed.</p> <p>By default, the option is enabled.</p>
Dell Auto OS Recovery Threshold	<p>Controls the automatic boot flow for SupportAssist System Resolution Console and for Dell OS Recovery Tool.</p> <p>By default, the threshold value is set to 2.</p>

Table 14. System setup options—System Management menu

System Management	
Service Tag	Display the Service Tag of the computer.
Asset Tag	Create a computer Asset Tag.
Wake on LAN/WLAN	<p>Enable or disable the computer to power on by special LAN signals when it receives a wakeup signal from the WLAN.</p> <p>By default, the Disabled option is selected.</p>
Auto on Time	<p>Enable to set the computer to turn on automatically every day or on a preselected date and time. This option can be configured only if the Auto On Time is set to Everyday, Weekdays, or Selected Days.</p> <p>By default, the option is disabled.</p>
Intel AMT Capability	<p>Enable or disable the Intel AMT capability.</p> <p>By default, the Restrict MEBx Access option is enabled.</p>
MEBx Hotkey	<p>Enable or disable MEBx hotkey.</p> <p>By default, the option is disabled.</p>
USB Provision	<p>Enable or disable the Intel AMT provisioning using the local provisioning file through a USB storage device.</p> <p>By default, the option is disabled.</p>
SERR Messages	<p>Enable or disable SERR messages.</p> <p>By default, the option is enabled.</p>
Keyboard Errors	<p>Enable Keyboard Error Detection</p>
Numlock LED	<p>Enable or disable Numlock LED.</p> <p>By default, the option is enabled.</p>

Table 15. System setup options—Keyboard menu

Keyboard	
Keyboard Errors	
Enable Keyboard Error Detection	Enable or disable the keyboard error detection. By default, the option is enabled.
Numlock LED	
Enable Numlock LED	Enable or disable Numlock LED. By default, the option is enabled.

Table 16. System setup options—Pre-boot Behavior menu

Pre-boot Behavior	
Warning and Errors	Enable or disable the action to be done when a warning or error is encountered. By default, the Prompt on Warnings and Errors option is enabled.
Fastboot	Enable to set the speed of the boot process. By default, the Thorough option is enabled.
Extend BIOS POST Time	Set the BIOS POST time. By default, the 0 seconds option is enabled.

Table 17. System setup options—Virtualization menu

Virtualization	
Intel Virtualization Technology	
Enable Intel Virtualization Technology (VT)	Specify whether a Virtual Machine Monitor (VMM) can utilize the additional hardware capabilities provided by Intel Virtualization Technology. By default, the option is enabled.
VT for Direct I/O	Specify whether a Virtual Machine Monitor (VMM) can utilize the additional hardware capabilities provided by Intel Virtualization Technology for Direct I/O. By default, the option is enabled.
Intel Trusted Execution Technology (TXT)	
Enable Intel Trusted Execution Technology (TXT)	Specifies whether a measured Virtual Machine Monitor (MVMM) can utilize the additional hardware capabilities provided by Intel Trusted Execution Technology. By default, the option is disabled.

Table 18. System setup options—Performance menu

Performance	
Multi Core Support	
Active Cores	Enables to change the number of CPU cores available to the operating system. By default, the All Cores options is enabled.
Intel SpeedStep	
Enable Intel SpeedStep Technology	Enables the computer to dynamically adjust processor voltage and core frequency, decreasing average power consumption and heat production. By default, the option is enabled.
C-States Control	

Table 18. System setup options—Performance menu (continued)

Performance	
Enable C-State Control	Enable or disable additional processor sleep states. By default, the option is enabled.
Intel Turbo Boost Technology	
Enable Intel Turbo Boost Technology	Enable or disable Intel TurboBoost mode of the processor. By default, the option is enabled.
Intel Hyper-Threading Technology	
Enable Intel Hyper-Threading Technology	Enable or disable Hyper-Threading in the processor. By default, the option is enabled.

Table 19. System setup options—System Logs menu

System Logs	
BIOS Event Log	
Clear BIOS Event Log	Display BIOS events. By default, the Keep option is enabled.

Updating the BIOS

Updating the BIOS in Windows

About this task

CAUTION: If BitLocker is not suspended before updating the BIOS, the next time you reboot the system it will not recognize the BitLocker key. You will then be prompted to enter the recovery key to progress and the system will ask for this on each reboot. If the recovery key is not known this can result in data loss or an unnecessary operating system re-install. For more information on this subject, see Knowledge Article: <https://www.dell.com/support/article/sln153694>

Steps

- Go to www.dell.com/support.
- Click **Product support**. In the **Search support** box, enter the Service Tag of your computer, and then click **Search**.
 **NOTE:** If you do not have the Service Tag, use the SupportAssist feature to automatically identify your computer. You can also use the product ID or manually browse for your computer model.
- Click **Drivers & Downloads**. Expand **Find drivers**.
- Select the operating system installed on your computer.
- In the **Category** drop-down list, select **BIOS**.
- Select the latest version of BIOS, and click **Download** to download the BIOS file for your computer.
- After the download is complete, browse the folder where you saved the BIOS update file.
- Double-click the BIOS update file icon and follow the on-screen instructions.
For more information, see knowledge base article [000124211](https://www.dell.com/support/article/000124211) at www.dell.com/support.

Updating the BIOS in Linux and Ubuntu

To update the system BIOS on a computer that is installed with Linux or Ubuntu, see the knowledge base article [000131486](https://www.dell.com/support/article/000131486) at www.dell.com/support.

Updating the BIOS using the USB drive in Windows

About this task

 **CAUTION:** If BitLocker is not suspended before updating the BIOS, the next time you reboot the system it will not recognize the BitLocker key. You will then be prompted to enter the recovery key to progress and the system will ask for this on each reboot. If the recovery key is not known this can result in data loss or an unnecessary operating system re-install. For more information on this subject, see Knowledge Article: <https://www.dell.com/support/article/sln153694>

Steps

1. Follow the procedure from step 1 to step 6 in [Updating the BIOS in Windows](#) to download the latest BIOS setup program file.
2. Create a bootable USB drive. For more information, see the knowledge base article [000145519](#) at www.dell.com/support.
3. Copy the BIOS setup program file to the bootable USB drive.
4. Connect the bootable USB drive to the computer that needs the BIOS update.
5. Restart the computer and press **F12**.
6. Select the USB drive from the **One Time Boot Menu**.
7. Type the BIOS setup program filename and press **Enter**.
The **BIOS Update Utility** appears.
8. Follow the on-screen instructions to complete the BIOS update.

Updating the BIOS from the F12 One-Time boot menu

Update your computer BIOS using the BIOS update.exe file that is copied to a FAT32 USB drive and booting from the F12 One-Time boot menu.

About this task

 **CAUTION:** If BitLocker is not suspended before updating the BIOS, the next time you reboot the system it will not recognize the BitLocker key. You will then be prompted to enter the recovery key to progress and the system will ask for this on each reboot. If the recovery key is not known this can result in data loss or an unnecessary operating system re-install. For more information on this subject, see Knowledge Article: <https://www.dell.com/support/article/sln153694>

BIOS Update

You can run the BIOS update file from Windows using a bootable USB drive or you can also update the BIOS from the F12 One-Time boot menu on the computer.

Most of the Dell computers built after 2012 have this capability, and you can confirm by booting your computer to the F12 One-Time Boot Menu to see if BIOS FLASH UPDATE is listed as a boot option for your computer. If the option is listed, then the BIOS supports this BIOS update option.

 **NOTE:** Only computers with BIOS Flash Update option in the F12 One-Time boot menu can use this function.

Updating from the One-Time boot menu

To update your BIOS from the F12 One-Time boot menu, you need the following:

- USB drive formatted to the FAT32 file system (key does not have to be bootable)
- BIOS executable file that you downloaded from the Dell Support website and copied to the root of the USB drive
- AC power adapter that is connected to the computer
- Functional computer battery to flash the BIOS

Perform the following steps to perform the BIOS update flash process from the F12 menu:

 **CAUTION:** Do not turn off the computer during the BIOS update process. The computer may not boot if you turn off your computer.

Steps

1. From a turn off state, insert the USB drive where you copied the flash into a USB port of the computer.
2. Turn on the computer and press F12 to access the One-Time Boot Menu, select BIOS Update using the mouse or arrow keys then press Enter.
The flash BIOS menu is displayed.
3. Click **Flash from file**.
4. Select external USB device.
5. Select the file and double-click the flash target file, and then click **Submit**.
6. Click **Update BIOS**. The computer restarts to flash the BIOS.
7. The computer will restart after the BIOS update is completed.

System and setup password

Table 20. System and setup password

Password type	Description
System password	Password that you must enter to log in to your system.
Setup password	Password that you must enter to access and make changes to the BIOS settings of your computer.

You can create a system password and a setup password to secure your computer.

 **CAUTION:** The password features provide a basic level of security for the data on your computer.

 **CAUTION:** Anyone can access the data that is stored on your computer if it is not locked and left unattended.

 **NOTE:** System and setup password feature is disabled.

Assigning a system setup password

Prerequisites

You can assign a new **System or Admin Password** only when the status is in **Not Set**.

About this task

To enter the system setup, press F12 immediately after a power-on or reboot.

Steps

1. In the **System BIOS** or **System Setup** screen, select **Security** and press Enter.
The **Security** screen is displayed.
2. Select **System/Admin Password** and create a password in the **Enter the new password** field.
Use the following guidelines to assign the system password:
 - A password can have up to 32 characters.
 - At least one special character: ! " # \$ % & ' () * + , - . / : ; < = > ? @ [\] ^ _ ` { | }
 - Numbers 0 through 9.
 - Upper case letters from A to Z.
 - Lower case letters from a to z.
3. Type the system password that you entered earlier in the **Confirm new password** field and click **OK**.
4. Press Esc and save the changes as prompted by the pop-up message.
5. Press Y to save the changes.
The computer restarts.

Deleting or changing an existing system setup password

Prerequisites

Ensure that the **Password Status** is Unlocked (in the System Setup) before attempting to delete or change the existing System and/or Setup password. You cannot delete or change an existing System or Setup password, if the **Password Status** is Locked.

About this task

To enter the System Setup, press F12 immediately after a power-on or reboot.

Steps

1. In the **System BIOS** or **System Setup** screen, select **System Security** and press Enter.
The **System Security** screen is displayed.
2. In the **System Security** screen, verify that **Password Status** is **Unlocked**.
3. Select **System Password**, update, or delete the existing system password, and press Enter or Tab.
4. Select **Setup Password**, update, or delete the existing setup password, and press Enter or Tab.
 **NOTE:** If you change the System and/or Setup password, reenter the new password when prompted. If you delete the System and/or Setup password, confirm the deletion when prompted.
5. Press Esc and a message prompts you to save the changes.
6. Press Y to save the changes and exit from System Setup.
The computer restarts.

Clearing CMOS settings

About this task

 **CAUTION:** Clearing CMOS settings will reset the BIOS settings on your computer.

Steps

1. Turn off your computer.
2. Press and hold the power button for 30 seconds to reset the coin-cell battery.
3. Turn on your computer.

Clearing BIOS (System Setup) and System passwords

About this task

To clear the system or BIOS passwords, contact Dell technical support as described at www.dell.com/contactdell.

 **NOTE:** For information on how to reset Windows or application passwords, refer to the documentation accompanying Windows or your application.

Troubleshooting

Dell SupportAssist Pre-boot System Performance Check diagnostics

About this task

SupportAssist diagnostics (also known as system diagnostics) performs a complete check of your hardware. The Dell SupportAssist Pre-boot System Performance Check diagnostics is embedded with the BIOS and is launched by the BIOS internally. The embedded system diagnostics provides a set of options for particular devices or device groups allowing you to:

- Run tests automatically or in an interactive mode
- Repeat tests
- Display or save test results
- Run thorough tests to introduce additional test options to provide extra information about the failed device(s)
- View status messages that inform you if tests are completed successfully
- View error messages that inform you of problems encountered during testing

 **NOTE:** Some tests for specific devices require user interaction. Always ensure that you are present at the computer terminal when the diagnostic tests are performed.

For more information, see <https://www.dell.com/support/kbdoc/000180971>.

Running the SupportAssist Pre-Boot System Performance Check

Steps

1. Turn on your computer.
2. As the computer boots, press the F12 key as the Dell logo appears.
3. On the boot menu screen, select the **Diagnostics** option.
4. Click the arrow at the bottom left corner.
Diagnostics front page is displayed.
5. Click the arrow in the lower-right corner to go to the page listing.
The items detected are listed.
6. To run a diagnostic test on a specific device, press Esc and click **Yes** to stop the diagnostic test.
7. Select the device from the left pane and click **Run Tests**.
8. If there are any issues, error codes are displayed.
Note the error code and validation number and contact Dell.

Display built-in self test

About this task

The following procedure provides the instructions on how to run the built-in self test for the display:

Steps

1. Turn off your computer.
2. Press and hold the display built-in self test button.
3. Press and hold the power button.
4. Release the power button.

5. Hold the display built-in self test button until the test starts.

Power-Supply Unit Built-in Self-Test

Built-in Self-Test (BIST) helps determine if the power-supply unit is working. To run self-test diagnostics on the power-supply unit of a desktop or all-in-one computer, see the knowledge base article [000125179](https://www.dell.com/support/article/000125179) at www.dell.com/support.

System-diagnostic lights

This section lists the system-diagnostic lights of your OptiPlex 5400 All-in-One.

Table 21. System-diagnostic lights

Blinking pattern		Problem description	Suggested resolution
Amber	White		
1	1	TPM detection failure	Replace the system board.
1	2	Unrecoverable SPI Flash Failure	Replace the system board.
1	5	EC unable to program i-Fuse	Replace the system board.
1	6	Generic catch-all for ungraceful EC code flow errors	Disconnect all power source (AC, battery, coin cell) and drain flea power by pressing and holding down power button for 3~5 seconds.
2	1	CPU failure	<ul style="list-style-type: none"> Run the Dell Support Assist/Dell Diagnostics tool. If problem persists, replace the system board.
2	2	System board failure (included BIOS corruption or ROM error)	<ul style="list-style-type: none"> Flash latest BIOS version If problem persists, replace the system board.
2	3	No memory/RAM detected	<ul style="list-style-type: none"> Confirm that the memory module is installed properly. If problem persists, replace the memory module.
2	4	Memory/RAM failure	<ul style="list-style-type: none"> Reset and swap memory modules among the slots. If problem persists, replace the memory module.
2	5	Invalid memory installed	<ul style="list-style-type: none"> Reset and swap memory modules among the slots. If problem persists, replace the memory module.
2	6	System board/Chipset Error	Replace the system board.
2	7	LCD failure (SBIOS message)	Replace the LCD module.

Table 21. System-diagnostic lights (continued)

Blinking pattern		Problem description	Suggested resolution
Amber	White		
2	8	LCD failure (EC detection of power rail failure)	Replace the system board.
3	1	CMOS battery failure	<ul style="list-style-type: none"> Reset the main battery connection. If problem persists, replace the main battery.
3	2	PCI or Video card/chip failure	Replace the system board.
3	3	BIOS Recovery image not found	<ul style="list-style-type: none"> Flash latest BIOS version If problem persists, replace the system board.
3	4	BIOS Recovery image found but invalid	<ul style="list-style-type: none"> Flash latest BIOS version If problem persists, replace the system board.
3	5	Power rail failure	Replace the system board.
3	6	Flash corruption detected by SBIOS.	<ul style="list-style-type: none"> Press power button for over 25 seconds to do RTC reset. If problem persists, replace the system board. Disconnect all power source (AC, battery, coin cell) and drain flea power by pressing and holding down power button 3~5 seconds to ensure all power are drained. Run "BIOS recovery from USB", and the instructions are in the website Dell support. If problem persists, replace the system board.
3	7	Timeout waiting on ME to reply to HECI message.	Replace the system board.

Recovering the operating system

When your computer is unable to boot to the operating system even after repeated attempts, it automatically starts Dell SupportAssist OS Recovery.

Dell SupportAssist OS Recovery is a standalone tool that is preinstalled in all Dell computers installed with Windows operating system. It consists of tools to diagnose and troubleshoot issues that may occur before your computer boots to the operating system. It enables you to diagnose hardware issues, repair your computer, back up your files, or restore your computer to its factory state.

You can also download it from the Dell Support website to troubleshoot and fix your computer when it fails to boot into their primary operating system due to software or hardware failures.

For more information about the Dell SupportAssist OS Recovery, see *Dell SupportAssist OS Recovery User's Guide* at www.dell.com/serviceabilitytools. Click **SupportAssist** and then, click **SupportAssist OS Recovery**.

Real Time Clock—RTC reset

The Real Time Clock (RTC) reset function allows you or the service technician to recover the recently launched model Dell Latitude and Precision systems from **No POST/No Boot/No Power** situations. You can initiate the RTC reset on the system from a power-off state only if it is connected to AC power. Press and hold the power button for 25 seconds. The system RTC reset occurs after you release the power button.

 **NOTE:** If AC power is disconnected from the system during the process or the power button is held longer than 40 seconds, the RTC reset process gets aborted.

The RTC reset will reset the BIOS to Defaults, un-provision Intel vPro and reset the system date and time. The following items are unaffected by the RTC reset:

- Service Tag
- Asset Tag
- Ownership Tag
- Admin Password
- System Password
- HDD Password
- Key Databases
- System Logs

 **NOTE:** The IT administrator's vPro account and password on the system will be un-provisioned. The system needs to go through the setup and configuration process again to reconnect it to the vPro server.

The below items may or may not reset based on your custom BIOS setting selections:

- Boot List
- Enable Legacy Option ROMs
- Secure Boot Enable
- Allow BIOS Downgrade

Backup media and recovery options

It is recommended to create a recovery drive to troubleshoot and fix problems that may occur with Windows. Dell proposes multiple options for recovering Windows operating system on your Dell PC. For more information, see [Dell Windows Backup Media and Recovery Options](#).

WiFi power cycle

About this task

If your computer is unable to access the internet due to WiFi connectivity issues a WiFi power cycle procedure may be performed. The following procedure provides the instructions on how to conduct a WiFi power cycle:

 **NOTE:** Some ISPs (Internet Service Providers) provide a modem/router combo device.

Steps



1. Turn off your computer.
2. Turn off the modem.
3. Turn off the wireless router.
4. Wait for 30 seconds.
5. Turn on the wireless router.
6. Turn on the modem.
7. Turn on your computer.

Getting help and contacting Dell

Self-help resources

You can get information and help on Dell products and services using these self-help resources:

Table 22. Self-help resources

Self-help resources	Resource location
Information about Dell products and services	www.dell.com
My Dell app	
Tips	
Contact Support	In Windows search, type <code>Contact Support</code> , and press Enter.
Online help for operating system	www.dell.com/support/windows www.dell.com/support/linux
Access top solutions, diagnostics, drivers and downloads, and learn more about your computer through videos, manuals and documents.	Your Dell computer is uniquely identified by a Service Tag or Express Service Code. To view relevant support resources for your Dell computer, enter the Service Tag or Express Service Code at www.dell.com/support . For more information on how to find the Service Tag for your computer, see Locate the Service Tag on your computer .
Dell knowledge base articles for a variety of computer concerns	<ol style="list-style-type: none"> 1. Go to www.dell.com/support. 2. On the menu bar at the top of the Support page, select Support > Knowledge Base. 3. In the Search field on the Knowledge Base page, type the keyword, topic, or model number, and then click or tap the search icon to view the related articles.

Contacting Dell

To contact Dell for sales, technical support, or customer service issues, see www.dell.com/contactdell.

 **NOTE:** Availability varies by country/region and product, and some services may not be available in your country/region.

 **NOTE:** If you do not have an active Internet connection, you can find contact information about your purchase invoice, packing slip, bill, or Dell product catalog.