

Nio Color 8MP

32-inch diagnostic display

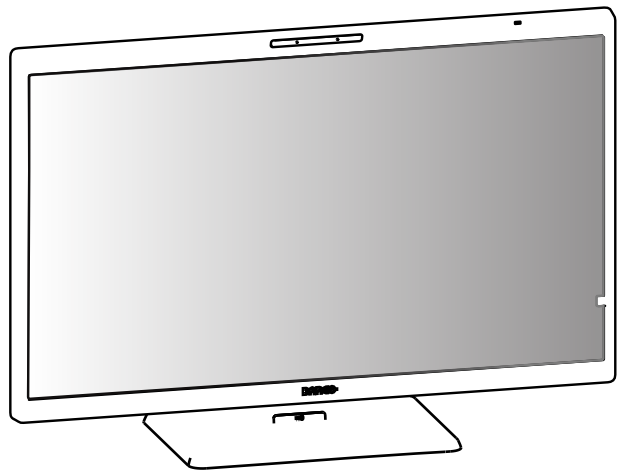

User guide

MDNC-8132 SNES

Barco NV
Beneluxpark 21, 8500 Kortrijk, Belgium

Registered office: Barco NV
President Kennedypark 35, 8500 Kortrijk, Belgium

Copyright notice

This document is copyrighted. All rights are reserved. Neither this document, nor any part of it, may be reproduced or copied in any form or by any means - graphical, electronic, or mechanical including photocopying, taping or information storage and retrieval systems - without written permission of Barco.

© 2024 Barco NV all rights reserved.

Disclaimer notice

Although every attempt has been made to achieve technical accuracy in this document, we assume no responsibility for errors that may be found. Our goal is to provide you with the most accurate and usable documentation possible; if you discover errors, please let us know.

Barco software products are the property of Barco. They are distributed under copyright by Barco NV or Barco Inc., for use only under the specific terms of a software license agreement between Barco NV or Barco Inc. and the licensee. No other use, duplication, or disclosure of a Barco software product, in any form, is authorized.

The specifications of Barco products are subject to change without notice.

Trademarks

All trademarks and registered trademarks are property of their respective owners.

DisplayPort™ and the DisplayPort™ logo are trademarks owned by the Video Electronics Standards Association (VESA®) in the United States and other countries.

Patent protection

Please refer to www.barco.com/about-barco/legal/patents.

Product Security Incident Response

As a global technology leader, Barco is committed to deliver secure solutions and services to our customers, while protecting Barco's intellectual property.

When product security concerns are received, the product security incident response process will be triggered immediately. To address specific security concerns or to report security issues with Barco products, please inform us via contact details mentioned on <https://www.barco.com/psirt>.

To protect our customers, Barco does not publicly disclose or confirm security vulnerabilities until Barco has conducted an analysis of the product and issued fixes and/or mitigations.

Table of contents

| | | |
|----------|--|-----------|
| 1 | Welcome | 7 |
| 1.1 | What's in the box | 8 |
| 1.2 | At a glance | 8 |
| 1.3 | Compatible Barco system components | 11 |
| 2 | Installation and setup | 13 |
| 2.1 | Single workstation setup | 14 |
| 2.2 | Dual workstation setup with KVM switch | 15 |
| 2.3 | QAWeb registration | 18 |
| 2.4 | VESA-mount installation | 18 |
| 3 | Daily Operation | 21 |
| 3.1 | Recommendations for daily operation | 22 |
| 3.2 | Shortcut bar | 22 |
| 3.3 | On/Off switching | 23 |
| 3.4 | KVM input switching | 23 |
| 3.5 | OSD menu access and use | 23 |
| 3.6 | Use of Multimedia Features | 24 |
| 4 | Advanced operation | 25 |
| 4.1 | OSD menu language | 26 |
| 4.2 | OSD menu position | 26 |
| 4.3 | OSD menu timeout | 26 |
| 4.4 | Power lock function | 26 |
| 4.5 | DPMS mode | 27 |
| 4.6 | Hibernate | 27 |
| 4.7 | Presence sensor | 28 |
| 4.8 | Luminance target | 28 |
| 4.9 | Color temperature/white tint | 29 |
| 4.9.1 | Color temperature | 29 |
| 4.9.2 | Color coordinates | 29 |
| 4.10 | Display function | 30 |
| 4.11 | Ambient Light Compensation (ALC) | 31 |
| 4.12 | Reading room | 31 |
| 4.13 | Embedded QA | 32 |
| 4.13.1 | DICOM status report | 32 |

| | | |
|----------|---|-----------|
| 4.13.2 | DICOM compliance check | 32 |
| 4.13.3 | DICOM calibration | 33 |
| 4.13.4 | DICOM error threshold..... | 33 |
| 4.13.5 | Reset DICOM calibration..... | 33 |
| 4.14 | Image source..... | 33 |
| 4.15 | KVM switch..... | 34 |
| 4.16 | System info..... | 35 |
| 4.17 | Calibration status | 35 |
| 4.18 | Maximum luminance demo | 35 |
| 4.19 | DisplayPort MST | 35 |
| 5 | Cleaning the display | 37 |
| 5.1 | Cleaning instructions..... | 38 |
| 6 | Repacking instructions | 39 |
| 6.1 | Repacking instructions..... | 40 |
| 7 | Important information | 43 |
| 7.1 | Safety information..... | 44 |
| 7.2 | Cybersecurity | 46 |
| 7.3 | Environmental information | 47 |
| 7.4 | Regulatory compliance information | 49 |
| 7.5 | EMC notice | 50 |
| 7.6 | Explanation of symbols..... | 52 |
| 7.7 | Open source license information | 56 |
| 7.8 | Technical specifications..... | 56 |

Welcome

1

Warnings, cautions, notes and tips

There are four levels of precautionary or advisory statements that may be used in this user guide. In descending order of importance, they are:



WARNING: A situation which could result in death or serious injury. It may also describe potential serious adverse reactions and safety hazards.



CAUTION: A situation which may result in minor or moderate injury to the user or patient or damage to the equipment or other property.



Gives additional information about the described subject.



Gives extra advice about the described subject.

1.1 What's in the box

Overview

- MDNC-8132 Display
- Quick install sheet
- Printed user guide
- Documentation disc, containing different languages of this user guide.
- Cables for mains, video and USB
- External power supply

If you ordered a Barco MXRT display controller, it is also in the box together with its accessories. The user guide is available at www.barco.com/support/intuitive-workflow-tools/documentation



Keep your original packaging. It is designed for this display and is the ideal protection during transport and storage.



The user guides are also available on www.barco.com/support



If your product arrived with shipping damage or missing parts, please refer to the instructions in our knowledge base article '3727' at www.barco.com/support/knowledge-base/3727 for further assistance.

1.2 At a glance

Product overview

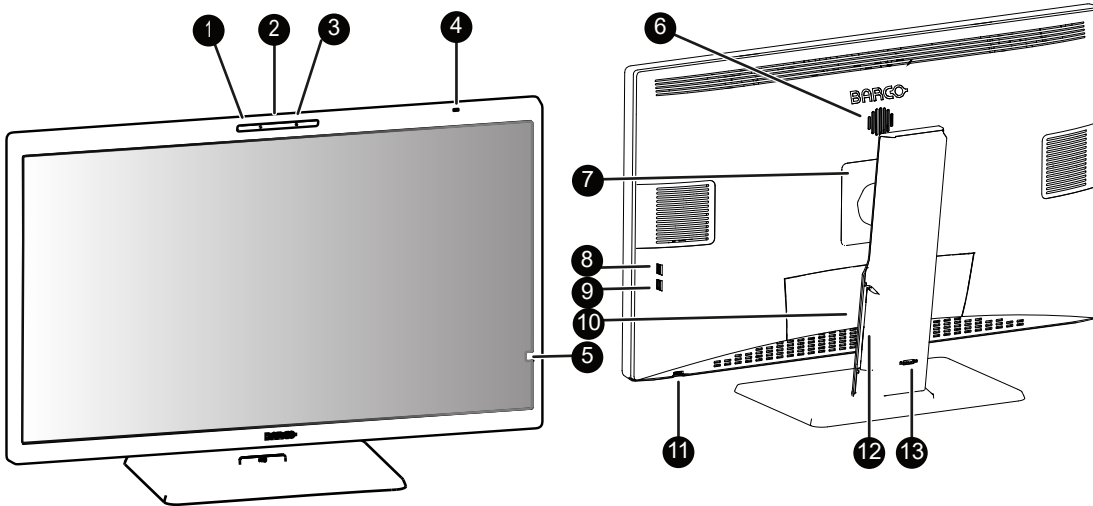

Image 1-1

1. Built-in camera
2. Built-in microphone
3. Presence sensor

The presence sensor detects if somebody is present in front of the display (within a range of approximately 90 cm) and will set the backlight to a minimum if nobody is present after a time-out (configurable in the OSD menu). When a person is detected, the display will switch to normal operation again. See [“Presence sensor”](#), page 28 for more information.

4. Ambient light sensor and status LED
 - Off: Display not powered (mains cable unplugged), or display is in normal operation
 - Fast blinking amber: Display is in suspend mode
 - Slow blinking amber: Display is in standby mode

- Steady amber: Display is in hibernate mode
 - Heartbeat amber: Display manually switched off via the jog dial
5. Front sensor
 - CAUTION:** To avoid permanent damage to the product, never use the front sensor to hold a paper, radiological film or any other object.
 6. Built-in speaker
 7. VESA mount cover
 8. Side USB-A 2.0 downstream connector
 9. Side USB-A 2.0 downstream connector (chargeable)¹
 10. Connector cover
 11. Jog dial
 - **Press:** Switch on the display, activate shortcut bar, go into (sub)menus, confirm adjustments and selections
 - **Turn left/right:** Switch on the display, activate shortcut bar, scroll through (sub)menus, change values, make selections
 - **Press and hold** for approximately 3 seconds: Switch off the display while no OSD menu is on the screen, abort DICOM compliance check/DICOM calibration
 12. Cable routing channels
 13. Stand locking mechanism

Connectors

Two USB connectors are available on the side of the display. To access the bottom connectors, gently pull the bottom of the connector cover away from the display.

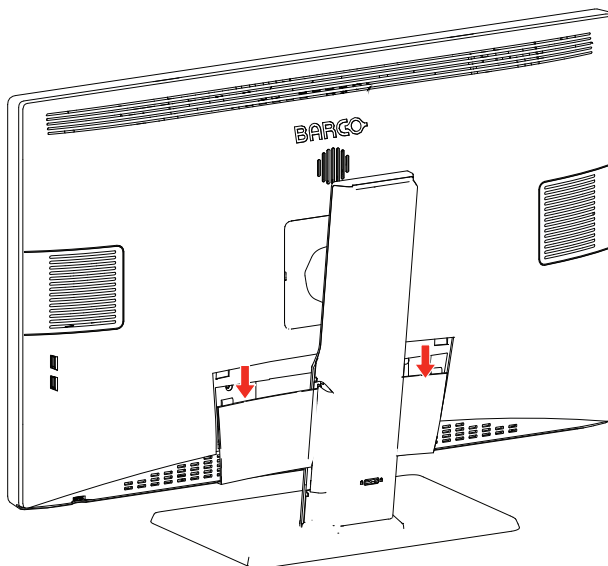

Image 1–2

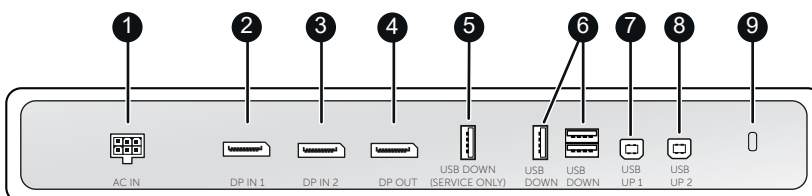

Image 1–3

1. Charging is only possible when DPMS mode **with** USB charging is enabled, or when DPMS is completely disabled (see “DPMS mode”, page 27).

Following connectors are available:

1. +24V DC mains power input
2. DisplayPort IN 1 (also main for KVM switching)
3. DisplayPort IN 2 (also secondary for KVM switching)
4. DisplayPort OUT (MST)
5. USB-A 2.0 downstream connectors (Service Only)
6. USB-A 2.0 downstream connectors (3x)
7. USB-B 2.0 upstream connector 1 (Main)
8. USB-B 2.0 upstream connector 2 (Secondary)
9. Kensington security slot

Display position adjustment

After unpacking, you can safely tilt and swivel the display to your preferred position.

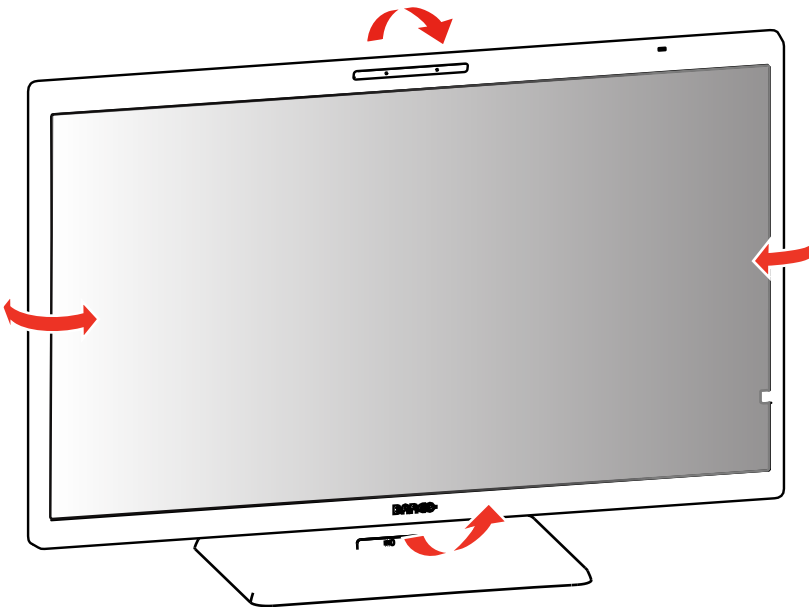

Image 1-4

To adjust the height of the display, first move the slider at the back of the stand to the **unlock** position. Then you can raise or lower the display as desired.

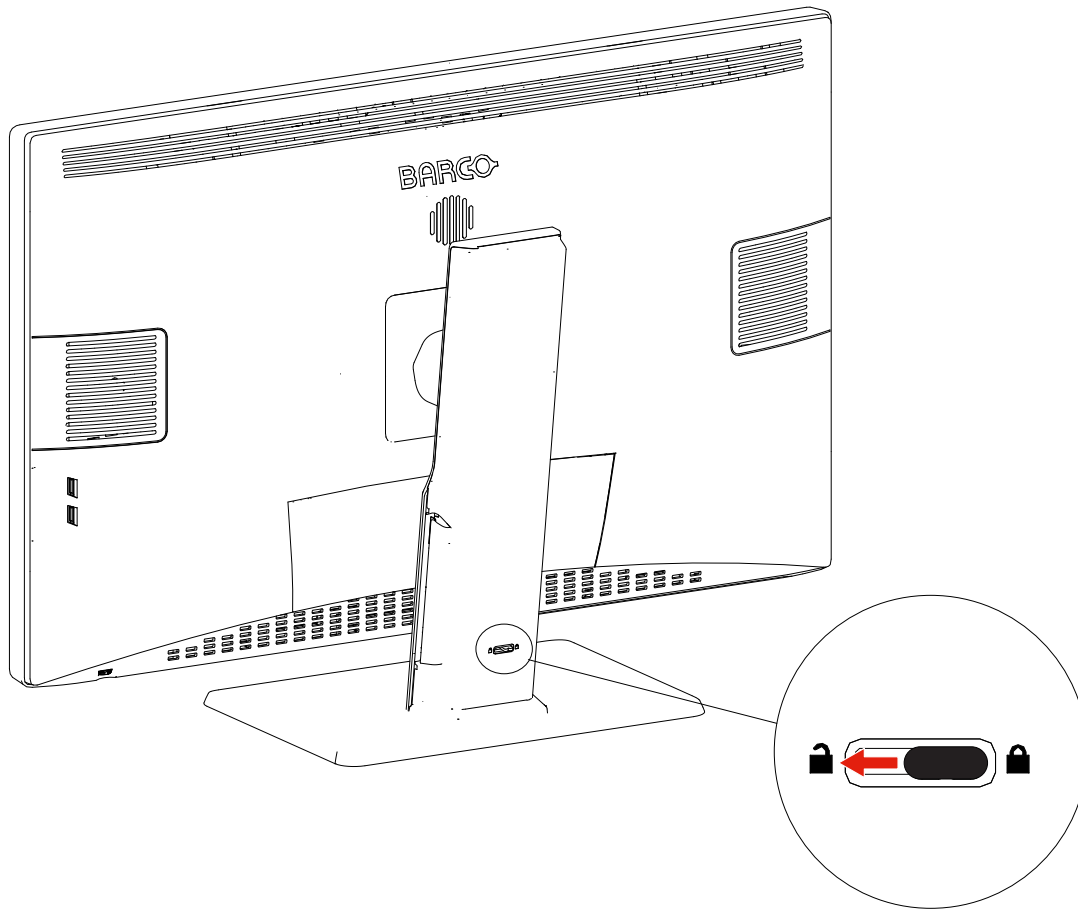

Image 1–5



The height can be locked only in the lowest position, even though the slider at the back of the stand can be moved to the lock position at any height of the display.

1.3 Compatible Barco system components

Overview

Following Barco components are compatible with your MDNC-8132 Display:

- QAWeb Agent version 2.15 or later.
- QAWeb for DIN 6868-157-1.3.4 or later.
- MXRT-x700 generation display controllers.
The previous generation MXRT-x600 display controllers are also supported.
- Barco SW Package 2024.1 or later.

Installation and setup

2

2.1 Single workstation setup

About

In this setup, the display is connected to a single workstation with a DisplayPort cable. When connecting a USB cable from your display to the workstation, you can control the workstation with a keyboard and mouse connected to the display.

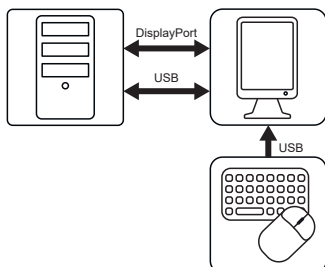

Image 2-1

Install the display controller

Before you connect your display with the workstation, make sure to have a suitable display controller installed in the workstation. For a list of compatible display controllers, please refer to the compatibility matrix available at <https://www.barco.com/support/docs/TDE12111>



The MDNC-8132 operates at its full specifications when driven by a Barco **MXRT display controller** and **MXRT driver**. These high-performing graphics cards have the power and features necessary to meet most diagnostic imaging needs. Moreover, Barco MXRT display controllers enable the use of Barco's **Intuitive Workflow Tools** that are designed to increase visibility of subtle details, improve focus during reading sessions, and accelerate workflow. Please visit www.barco.com/product/intuitive-workflow-tools for more information.

Connect the cables

1. Remove the connector cover.
2. Connect the DisplayPort input (DP IN 1 or DP IN 2) with a DisplayPort output on the workstation.
3. The DisplayPort OUT allows you to daisy-chain your display to another display using DisplayPort Multi-Stream Transport (MST).
4. Connect the main USB upstream connector (USB UP 1) with a USB host on the workstation.

This enables:

- Use of Built-in camera, speaker and microphone (see "Use of Multimedia Features", page 24)
 - QAWeb Enterprise Registration of the display (see "QAWeb registration", page 18)
 - Connection of a peripheral (keyboard, mouse, touchpad, etc.) to one of the display's USB downstream connectors.
5. Connect a keyboard and mouse (or another peripheral used to control the workstations) with the USB downstream connectors of the display.
 - Note:** When DPMS mode **with** USB charging is enabled (see "DPMS mode", page 27) and hibernate is enabled (see "Hibernate", page 27), you can easily awaken your system from hibernate with a mouse/keyboard connected to the display. When DPMS mode **without** USB charging is enabled (see "DPMS mode", page 27) and hibernate is enabled (see "Hibernate", page 27), you can only awaken your system from hibernate by pressing the jog dial, or with a mouse/keyboard connected to the workstation (and not to the display).
 6. Connect the supplied external DC power supply to the power input on the display.
 7. Route all cables through the cable clips in the connector compartment.

8. Re-install the connector cover: slide the top of the cover in the available recesses, then push the bottom of the cover back into position.
9. Route all cables through the routing channels in the stand of your display.
10. Connect the external DC power supply to a grounded power outlet by using one of the power cables included with the display.

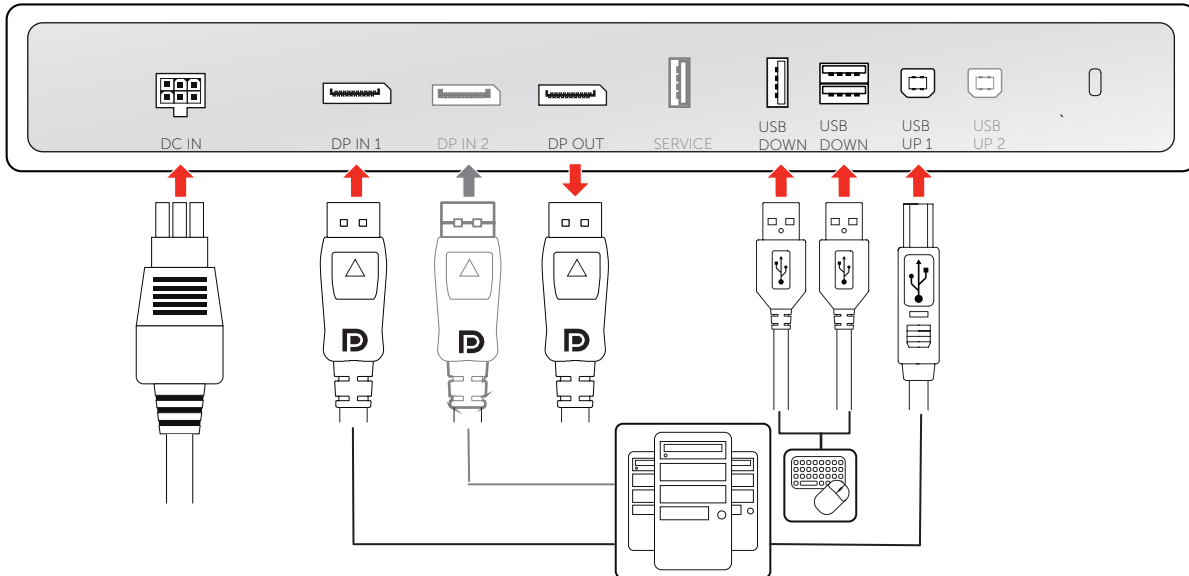

Image 2-2



To switch between different image sources, see “[Image source](#)”, page 33 for more information.

Power on the display system

1. Press the jog dial to activate your display.
2. Switch on the workstations connected to your display.

Your display will be running in a basic video mode at a default refresh rate when first time starting up.

Install the Barco SW Package

The MDNC-8132 operates at its full specifications when driven by a Barco **MXRT display controller** and **MXRT driver**. These high-performing graphics cards have the power and features necessary to meet most diagnostic imaging needs. Moreover, Barco MXRT display controllers enable the use of Barco’s **Intuitive Workflow Tools** that are designed to increase visibility of subtle details, improve focus during reading sessions, and accelerate workflow. Please visit www.barco.com/product/intuitive-workflow-tools for more information.

2.2 Dual workstation setup with KVM switch

About

In this setup, the display is connected to two different workstations, each with one DisplayPort cable. When connecting a USB cable from your display to each of the two workstations, you can control both workstations with a single keyboard and mouse connected to the display. Switching the video and controls signals between the two workstations is done with the KVM switch operated via the OSD menu.

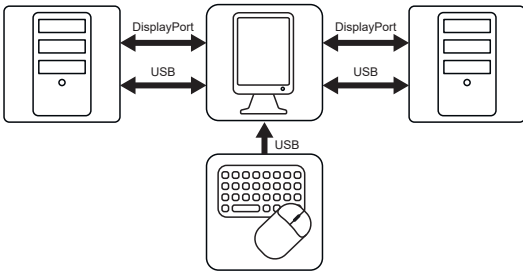

Image 2-3



Barco suggests to have QAWeb installed on only one of both workstations. When both workstation would have QAWeb installed, switching KVM inputs would trigger a Configuration Change event, causing the display to disappear from the workstation in QAWeb.

Install the display controller

Before you connect your display with the workstation, make sure to have a suitable display controller installed in the workstation. For a list of compatible display controllers, please refer to the compatibility matrix available at <https://www.barco.com/support/docs/TDE12111>



The MDNC-8132 operates at its full specifications when driven by a Barco **MXRT display controller** and **MXRT driver**. These high-performing graphics cards have the power and features necessary to meet most diagnostic imaging needs. Moreover, Barco MXRT display controllers enable the use of Barco's **Intuitive Workflow Tools** that are designed to increase visibility of subtle details, improve focus during reading sessions, and accelerate workflow. Please visit www.barco.com/product/intuitive-workflow-tools for more information.

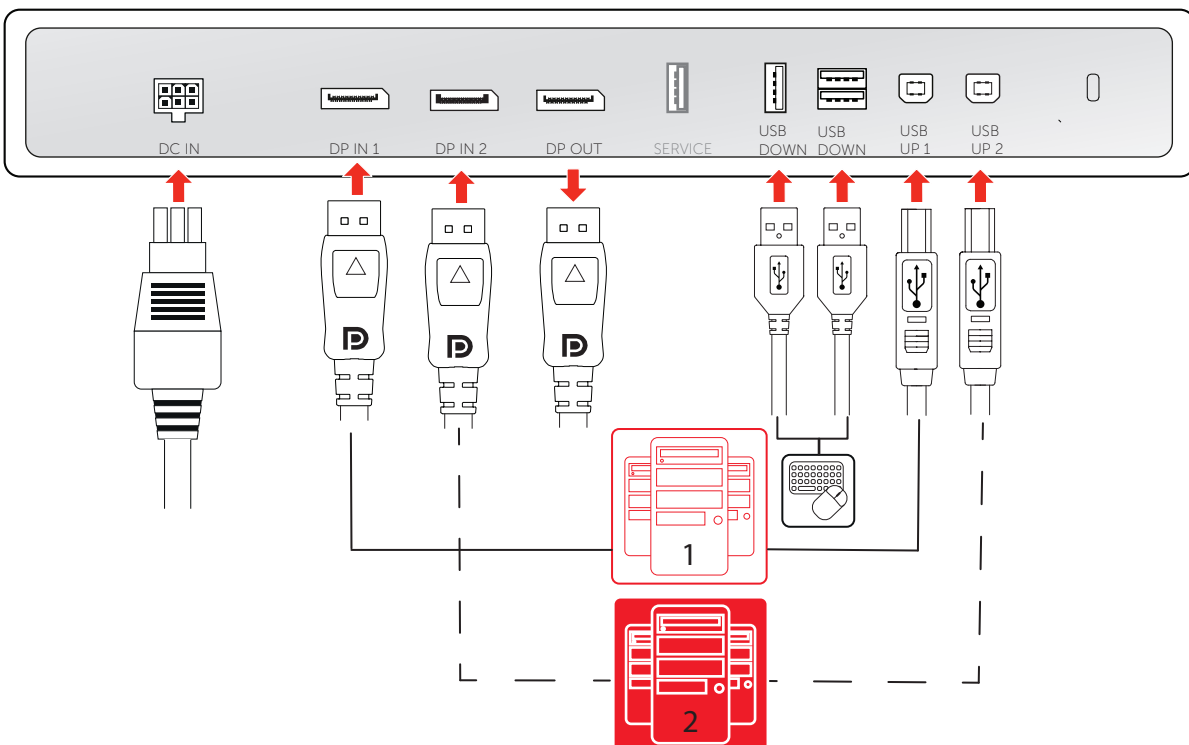

Image 2-4

Connect the cables

1. Remove the connector cover.
2. Connect DisplayPort input 1 (DP IN 1) with the DisplayPort output on workstation 1.
3. Connect the main USB upstream connector (USB UP 1) with a USB host on workstation 1.
4. Connect DisplayPort input 2 (DP IN 2) with the DisplayPort output on workstation 2.
5. Connect the secondary USB upstream connector (USB UP 2) with a USB host on workstation 2.
6. Connect a keyboard and mouse (or another peripheral used to control the workstations) with the USB downstream connectors of the display.



Note: When DPMS mode **with** USB charging is enabled (see “DPMS mode”, page 27) and hibernate is enabled (see “Hibernate”, page 27), you can easily awaken your system from hibernate with a mouse/keyboard connected to the display.

When DPMS mode **without** USB charging is enabled (see “DPMS mode”, page 27) and hibernate is enabled (see “Hibernate”, page 27), you can only awaken your system from hibernate by pressing the jog dial, or with a mouse/keyboard connected to the workstation (and not to the display).

7. Connect the supplied external DC power supply to the power input on the display.
8. Route all cables through the cable clips in the connector compartment.
9. Re-install the connector cover: slide the top of the cover in the available recesses, then push the bottom of the cover back into position.
10. Route some or all cables through the routing channels in the stand of your display.
11. Connect the external DC power supply to a grounded power outlet by using one of the power cables included with the display.

Power on the display system

1. Press/Turn the jog dial to activate your display.
2. Switch on the workstations connected to your display.

Your display will be running in a basic video mode at a default refresh rate when first time starting up

Install the Barco SW Package

The MDNC-8132 operates at its full specifications when driven by a Barco **MXRT display controller** and **MXRT driver**. These high-performing graphics cards have the power and features necessary to meet most diagnostic imaging needs. Moreover, Barco MXRT display controllers enable the use of Barco’s **Intuitive Workflow Tools** that are designed to increase visibility of subtle details, improve focus during reading sessions, and accelerate workflow. Please visit www.barco.com/product/intuitive-workflow-tools for more information.

Enable the KVM switch

1. Bring up the OSD main menu.
2. Navigate to the *Image Settings* menu.
3. Enter the *KVM Switch* submenu.
4. Select *Enabled* and confirm.



When enabling the KVM switch, the *Image Source* menu will be inaccessible.

To switch KVM inputs

1. Press or turn the jog dial to activate the shortcut bar. The KVM switch icon () is now selected by default because the KVM switch is enabled.

2. Press the jog dial again to switch KVM inputs.



During normal operation, double-press the jogdial to switch KVM inputs more quickly. A first click will make the shortcut bar pop up, a second click will switch inputs (since the KVM switch icon is selected by default when the KVM switch is enabled).



When switching KVM inputs, the video is switched instantly while switching the USB signal might take a little longer (up to 2 seconds).

2.3 QAWeb registration

About

QAWeb helps you manage quality and assure compliance of your expanding healthcare enterprise with less effort, lower cost, and complete confidence. This fully automated and secure system supports a consistent image quality and uptime for all registered imaging display systems within your facility and across your enterprise. Learn more at www.barco.com/qaweb.

To register your display system to your QAWeb organization, the QAWeb Agent must be installed and running on your workstation and it must be able to communicate with the QAWeb cloud service.

For more information and installation instructions, please check the QAWeb user guide on www.barco.com/support.

2.4 VESA-mount installation



CAUTION: Use a mount that is compliant with the VESA 100 mm standard.



WARNING: Use a mount that can support the weight of the display. Refer to the technical specifications of this display for the applicable weight.

Overview

The panel, standard attached to a stand, is compatible with the VESA 100 mm standard. Thus, it can be used with a mount that is compliant to the VESA 100 mm standard. This chapter shows you how to release the panel from the stand and how to attach it to a VESA mount. If you're not using a mount, you can skip this chapter.

1. Unlock the stand locking mechanism and put the display in the highest position.
2. Put the display face down on a clean and soft horizontal surface. Be careful not to damage the panel screen.
3. Push a flathead screwdriver into the right VESA mount cover hole to unlock the cover, then lift the cover with the flathead screwdriver.

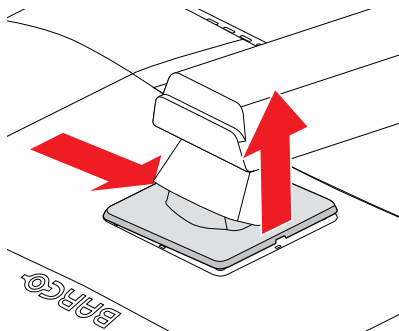

Image 2-5

4. Push a flathead screwdriver into the left VESA mount cover hole to unlock the cover, then lift the cover with the flathead screwdriver.

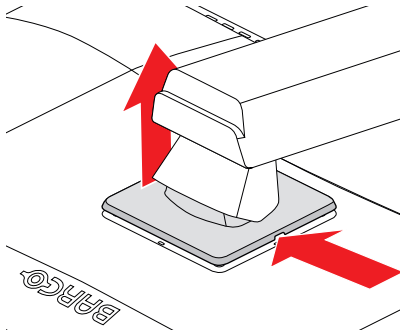

Image 2-6

5. Rotate the VESA mount cover to uncover the screws fixing the panel to the stand.

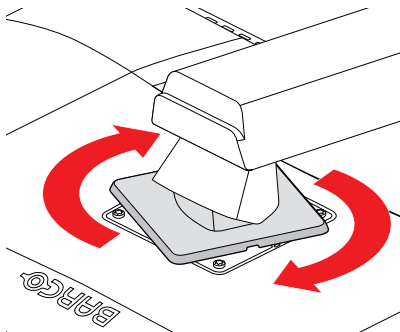

Image 2-7

6. Unscrew the 4 fixation screws while supporting the stand.

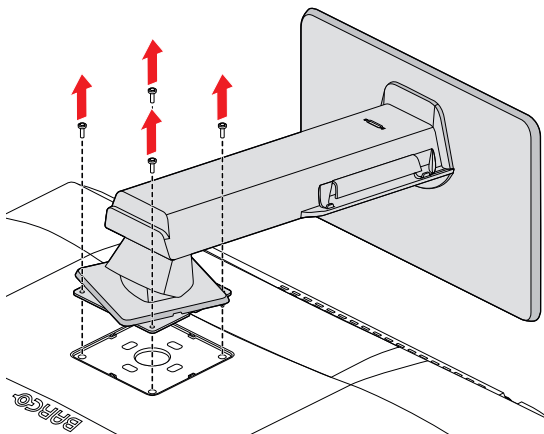

Image 2-8

7. Attach the panel **firmly** to the VESA mount using 4 M4 screws.
Respect the following rule to select an appropriate screw length:
 - $L_{\min} = T + W + 8 \text{ mm}$
 - $L_{\max} = T + W + 10,5 \text{ mm}$

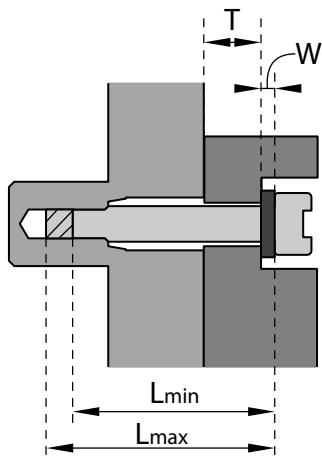

Image 2-9



WARNING: Never move a display attached to a wall mount by pulling or pushing the display itself. Instead, make sure that the wall mount is equipped with a VESA compliant handle and use this to move the display. Please refer to the instruction manual of the wall mount for more information and instructions.

Daily Operation

3

| | | |
|-----|---|----|
| 3.1 | Recommendations for daily operation | 22 |
| 3.2 | Shortcut bar | 22 |
| 3.3 | On/Off switching | 23 |
| 3.4 | KVM input switching | 23 |
| 3.5 | OSD menu access and use | 23 |
| 3.6 | Use of Multimedia Features | 24 |

3.1 Recommendations for daily operation

Optimize the lifetime of your display

Enabling the Display Power Management System (DPMS) of your display will optimize its diagnostic lifetime by automatically switching off the backlight when the display is not used for a specified period of time. By default, DPMS is enabled on your display, but it also needs to be activated on your workstation. To do this, go to the “Power Options” of your workstation.



Barco recommends setting DPMS activation after 30 minutes of non-usage.

Use a screen saver to avoid image retention

Prolonged operation of an LCD with the same content on the same screen area may result in a form of image retention.

You can avoid or significantly reduce the occurrence of this phenomenon by using a screen saver. You can activate a screen saver in the “Display properties” window of your workstation.



Barco recommends setting screen saver activation after 5 minutes of non-usage. A good screen saver displays moving content.

In case you are working with the same image or an application with static image elements for several hours continuously (so that the screen saver is not activated), change the image content regularly to avoid image retention of the static elements.

Understand pixel technology

LCD displays use technology based on pixels. As a normal tolerance in the manufacturing of the LCD, a limited number of these pixels may remain either dark or permanently lit, without affecting the diagnostic performance of the product. To ensure optimal product quality, Barco applies strict selection criteria for its LCD panels.

Maximize quality assurance

QAWeb helps you manage quality and assure compliance of your expanding healthcare enterprise with less effort, lower cost, and complete confidence. This fully automated and secure system supports a consistent image quality and uptime for all registered PACS display systems within your facility and across your enterprise.



Barco highly recommends to use QAWeb. Learn more at www.barco.com/qaweb.

3.2 Shortcut bar

About the shortcut bar

The shortcut bar gives direct access to a number of OSD menu functions without having to browse the OSD menu.

- “KVM input switching”, page 23
- “OSD menu access and use”, page 23
- “On/Off switching”, page 23



Image 3-1

To activate a shortcut bar function

1. During normal operation, press or turn the jog dial. The shortcut bar is activated.
2. Turn the jog dial left or right to select a function.
3. Press the jog dial to confirm your selection and to activate the function.

3.3 On/Off switching

To switch on your display

Press/Turn the jog dial to activate your display.

To switch off your display

1. Press/Turn the jog dial to activate the shortcut bar.
2. Turn the jog dial and select the standby icon ().
3. Press the jog dial to confirm your selection.
4. Press the jog dial again to switch off the display.

3.4 KVM input switching

About the KVM switch

The MDNC-8132 can be used in dual workstation setup with KVM switch. This allows the display to be connected to two different workstations and control both with a single keyboard and mouse connected to the display. Switching the video and control signals between the two workstations is done with the KVM switch operated via the OSD menu.



Your display system must be specifically set up and configured for KVM input switching. For instructions, see [“Dual workstation setup with KVM switch”, page 15](#).

To switch KVM inputs

1. Press or turn the jog dial to activate the shortcut bar. The KVM switch icon () is selected by default when the KVM switch is enabled.
2. Press the jog dial again to switch KVM inputs.



During normal operation, double-press the jogdial to switch KVM inputs more quickly. A first click will make the shortcut bar pop up, a second click will switch inputs (since the KVM switch icon is selected by default when the KVM switch is enabled).



When switching KVM inputs, the video is switched instantly while switching the USB signal might take a little longer (up to 2 seconds).

3.5 OSD menu access and use

About the OSD menu

The OSD menu allows you to configure different settings to make your MDNC-8132 fit your needs within your working environment. Also, you can retrieve general information about your display and its current configuration settings through the OSD menu.

To access the OSD menu

1. Press/Turn the jog dial to activate the shortcut bar.
2. Turn the jog dial and select the OSD menu icon ()
3. Press the jog dial to enter the OSD menu.

To navigate through the OSD menus

- Turn the jog dial left/right to scroll through the (sub)menus, to change values or to make selections.
- Press the jog dial to go into a submenu or confirm adjustments and selections.
- Press and hold the jog dial for approximately 3 seconds to switch off the display while no OSD menu is on the screen or to abort DICOM compliance check/DICOM calibration.
- Turn the jog dial on *Back/Exit* and press to exit the (sub)menu.

3.6 Use of Multimedia Features

This display comes with a built-in camera, a speaker and a microphone.

To use the features simply connect the display to your workstation with a USB cable.

The rest is Plug & Play: Windows will detect the features and install the driver for these functions.

Advanced operation

4

| | | |
|------|--|----|
| 4.1 | OSD menu language | 26 |
| 4.2 | OSD menu position..... | 26 |
| 4.3 | OSD menu timeout | 26 |
| 4.4 | Power lock function..... | 26 |
| 4.5 | DPMS mode..... | 27 |
| 4.6 | Hibernate | 27 |
| 4.7 | Presence sensor | 28 |
| 4.8 | Luminance target..... | 28 |
| 4.9 | Color temperature/white tint..... | 29 |
| 4.10 | Display function | 30 |
| 4.11 | Ambient Light Compensation (ALC) | 31 |
| 4.12 | Reading room | 31 |
| 4.13 | Embedded QA..... | 32 |
| 4.14 | Image source | 33 |
| 4.15 | KVM switch | 34 |
| 4.16 | System info | 35 |
| 4.17 | Calibration status..... | 35 |
| 4.18 | Maximum luminance demo..... | 35 |
| 4.19 | DisplayPort MST | 35 |

About

This section describes all settings available in the OSD menu and how to change and configure them.



Certain OSD menu settings affecting calibration can be managed by QAWeb. Manually changing these settings in the OSD menu is still possible but the changes will be overwritten at each sync with QAWeb.

4.1 OSD menu language

About OSD menu language

By default, the OSD menu comes up in English. However, there's a wide range of other languages available for the OSD menu of your MDNC-8132 Display.

To change the OSD menu language

1. Bring up the OSD main menu.
2. Navigate to the *Language* menu.
3. Select a desired language and confirm.

4.2 OSD menu position

About OSD menu position

The available OSD menu position for your display are:

- Center
- Up left
- Up right
- Bottom left
- Bottom right

To adjust the OSD menu position

1. Bring up the OSD main menu.
2. Navigate to the *OSD Settings* menu.
3. Enter the *OSD Position* submenu.
4. Select a desired OSD position and confirm.

4.3 OSD menu timeout

About OSD menu timeout

The OSD menu will disappear automatically after approximately 15secs (default), 30secs or 60secs of inactivity. However, this function can also be disabled so that the OSD menu remains on the screen until manually closed.

To set the OSD menu timeout

1. Bring up the OSD main menu.
2. Navigate to the *OSD Settings* menu.
3. Enter the *OSD Timeout* submenu.
4. Select *15sec*, *30sec*, *60sec* or *Disabled* and confirm.

4.4 Power lock function

About power lock function

When the power lock function is enabled, it is no longer possible to switch off your display via the jog dial as described in [“On/Off switching”, page 23](#). DPMS mode is not affected by this setting.

To enable/disable the power lock function

1. Bring up the OSD main menu.
2. Navigate to the *Power Management* menu.
3. Enter *Power Lock* submenu.
4. Select *Enabled/Disabled* as desired and confirm.

4.5 DPMS mode

About DPMS mode

Enabling the Display Power Management System (DPMS) mode on your display will optimize its diagnostic lifetime by automatically switching off the backlight when the display is not used for a specified period of time. By default, DPMS mode is enabled on your display, but it also needs to be activated on your workstation. To do this, go to the “Power options” of your workstation.



Barco recommends setting DPMS on your workstation to activate after 30 minutes of non-usage.



When DPMS mode is enabled, two additional functions become available: hibernate and presence sensor. See “[Hibernate](#)”, [page 27](#), “[Presence sensor](#)”, [page 28](#) for more information.



When DPMS mode **with** USB charging is enabled (see “[DPMS mode](#)”, [page 27](#)) and hibernate is enabled (see “[Hibernate](#)”, [page 27](#)), you can easily awaken your system from hibernate with a mouse/keyboard connected to the display.

When DPMS mode **without** USB charging is enabled (see “[DPMS mode](#)”, [page 27](#)) and hibernate is enabled (see “[Hibernate](#)”, [page 27](#)), you can only awaken your system from hibernate by pressing the jog dial, or with a mouse/keyboard connected to the workstation (and not to the display).

To enable/disable DPMS mode on your display

1. Bring up the OSD main menu.
2. Navigate to the *Power Management* menu.
3. Enter the *DPMS Mode* submenu.
4. Select *Disabled, USB Charging Enabled or USB Charging Disabled* as desired and confirm.

4.6 Hibernate

About hibernate

When hibernate is enabled, not only the backlight, but also other functions will be disabled to reduce power consumption to a minimum. This happens after an adjustable time-out.



DPMS mode must be enabled before hibernate can be enabled. See “[DPMS mode](#)”, [page 27](#).



When DPMS mode **with** USB charging is enabled (see “[DPMS mode](#)”, [page 27](#)) and hibernate is enabled (see “[Hibernate](#)”, [page 27](#)), you can easily awaken your system from hibernate with a mouse/keyboard connected to the display.

When DPMS mode **without** USB charging is enabled (see “[DPMS mode](#)”, [page 27](#)) and hibernate is enabled (see “[Hibernate](#)”, [page 27](#)), you can only awaken your system from hibernate by pressing the jog dial, or with a mouse/keyboard connected to the workstation (and not to the display).

To enable/disable hibernate

1. Bring up the OSD main menu.
2. Navigate to the *Power Management* menu.
3. Enter the *Hibernate* submenu.
4. Select *Enabled/Disabled* as desired and confirm.

To adjust the hibernate time-out

1. Bring up the OSD menu.
2. Navigate to the *Power Management* menu.
3. Enter the *Hibernate Timeout* submenu.
4. Set the time-out value as desired and confirm.

4.7 Presence sensor

About presence sensor

The presence sensor detects if somebody is present in front of the display (within a range of approximately 90 cm) and will set the backlight to a minimum if nobody is present after a time-out (configurable in the OSD menu by the presence sensor timer). When a person is detected, the display will switch to normal operation again.



The presence sensor cannot distinguish the difference between a person and an object. This means that for instance, a high chair might also be detected and could prevent the backlight to be set to a minimum.



Changing the display position (height, tilt, swivel or pivot) might influence the detection range of the presence sensor.



DPMS mode must be enabled before presence sensor can be enabled. See “DPMS mode”, page 27.

To enable/disable the presence sensor

1. Bring up the OSD main menu.
2. Navigate to the *Power Management* menu.
3. Enter the *Presence Sensor(PS)* submenu.
4. Select *Enabled/Disabled* as desired and confirm.

To adjust the presence sensor timer

1. Bring up the OSD main menu.
2. Navigate to the *Power Management* menu.
3. Enter the *PS Timer* submenu.
4. Set the presence sensor timer value as desired and confirm.

4.8 Luminance target

About luminance target

The luminance target of your MDNC-8132 is adjustable over a predefined range. When you change the luminance target, the display will adjust its backlight to reach the target.

To set the luminance target

1. Bring up the OSD main menu.
2. Navigate to the *Image Settings* menu.
3. Enter the *Luminance Target* submenu.
4. Set the luminance target value as desired and confirm.



The default, factory calibrated luminance value is available in the technical specifications table. The guaranteed backlight lifetime is valid for this setting.

4.9 Color temperature/white tint

About color temperature/white tint

The available color temperature/white tint settings for your display are:

- **Native White:** The native, unmodified color temperature of the LCD panel
- **Clear base:** Simulation of the clearbase film color temperature
- **Blue base:** Simulation of the bluebase film color temperature
- **6500K:** Corresponds to a color temperature of 6500 Kelvin (D65)
- **User:** When selecting the User color preset, you will be able to manually define:
 - Color temperature (Kelvin)
 - Color coordinates (x, y)

To select a color temperature/white tint

1. Bring up the OSD main menu.
2. Navigate to the *Image Settings* menu.
3. Enter the *Color Temperature/White Tint* submenu.
4. Select a desired color temperature/white tint and confirm.

4.9.1 Color temperature

About color temperature

It is possible to change the color temperature of your display.



Color temperature can only be changed when the color temperature/white tint is set to *User*.

To change the color temperature

1. Bring up the OSD main menu.
2. Navigate to the *Image Settings* menu.
3. Enter the *Color Temperature/White Tint* submenu.
4. Select *User* and confirm.
5. Enter ... to bring up the color definition menu.
6. Enter the *Color Definition* menu, select *Color Temperature* and confirm.
7. Return to the *Color Temperature* menu.
8. Enter the *Color Temperature* menu.
9. Enter the *Color Temperature* submenu, set the value as desired and confirm.

4.9.2 Color coordinates

About color coordinates

It is possible to change the color coordinates of your display.



Color coordinates can only be changed when the color temperature/white tint is set to *User*.

To change the color coordinates

1. Bring up the OSD main menu.
2. Navigate to the *Image Settings* menu.
3. Enter the *Color Temperature/White Tint* submenu.
4. Select *User* and confirm.
5. Enter ... to bring up the color definition menu.
6. Enter the *Color Definition* menu, select *Color Coordinates* and confirm.
7. Return to the *Color Coordinates* menu.
8. Enter the *Color Coordinates* menu.
9. Enter the x and y submenus, set the values as desired and confirm.

4.10 Display function

About display function

Native, uncorrected panels will display all grayscale/color levels with luminance increments that are not optimal for crucial diagnostic information. Studies have shown however, that in medical images certain grayscale/color parts contain more diagnostic information than others. To respond to these conclusions, display functions have been defined. These functions emphasize on these parts containing crucial diagnostic information by correcting the native panel behavior.

The available display functions for your display are:

- **Native:** The native display panel behavior will not be corrected.
- **sRGB:** The sRGB display function is designed to match typical home and office viewing conditions. It is widely used in most computer applications.
- **Dynamic Gamma 1.8 or 2.2:** These are gamma functions that are shifted to take into account the non-zero luminance of an LCD panel when driven with a “black” signal. They are especially useful in CT applications to improve the perception of low Hounsfield values.
- **DICOM:** DICOM (Digital Imaging and Communications in Medicine) is an international standard that was developed to improve the quality and communication of digital images in radiology. In short, the DICOM display function results in more visible grayscales in the images. Barco recommends selecting the DICOM display function for most medical viewing applications.
- **User Calibration:** This display function will be automatically selected when display functions are defined by QAWeb.
- **Gamma 1.8 or 2.2:** Select one of these display functions in case the display is to replace a CRT display with a gamma of 1.8 or 2.2 respectively.
- **Test:** For Barco service purposes only.



The settings of the display must be adapted to suit the requirements of the visualization software. In case of doubt, please contact the vendor of the visualization software.

To select a display function

1. Bring up the OSD main menu.
2. Navigate to the *Image Settings* menu.
3. Enter the *Display Function* submenu.
4. Select a desired display function and confirm.

4.11 Ambient Light Compensation (ALC)

About ALC



Ambient Light Compensation (ALC) can only be enabled on your display when the display function is set to DICOM. Please refer to [“Display function”, page 30](#).

When ALC is enabled, the DICOM display function will be recalculated taking a preset ambient light correction value into account. This value is determined by the selected reading room. Therefore, it is also important to select a realistic reading room when enabling ALC. This can be done by following the instructions in [“Reading room”, page 31](#).

To enable/disable ALC

1. Bring up the OSD main menu.
2. Navigate to the *Embedded QA/Calibration Status* menu.
3. Enter the *Ambient Light Compensation* submenu.
4. Select *Enabled/Disabled* as desired and confirm.

4.12 Reading room

About reading room



Reading rooms can only be selected on your display when the display function is set to DICOM. Please refer to [“Display function”, page 30](#)

The American Association of Physicists in Medicine (AAPM) composed a list of pre-defined reading rooms. Each of these reading rooms are defined by following parameters:

- the maximum light allowed in this type of room
- the preset ambient light correction value for this reading room

These parameters are stored in your display and determine the preset ambient light correction value to take into account to recalculate the DICOM display function when Ambient Light Compensation (ALC) is enabled. Please refer to [“Ambient Light Compensation \(ALC\)”, page 31](#) to enable ALC.

The available reading rooms for your MDNC-8132 are:

- **CR/DR/ MAMMO:** Corresponds to light conditions in diagnostic reading rooms for computed radiology, digital radiology or mammography. This setting has the lowest maximum ambient light.
- **CT/MR/NM:** Corresponds to light conditions in diagnostic reading rooms for computed tomography, magnetic resonance or nuclear medicine scans.
- **Staff Office:** Corresponds to light conditions in office rooms.
- **Clinical Viewing Room:** Corresponds to light conditions in diagnostic reading rooms for clinical viewing.
- **Emergency Room:** Corresponds to light conditions in emergency rooms.
- **Operating Room:** Corresponds to light conditions in operating rooms. This setting has the highest maximum ambient light.

To select a reading room

1. Bring up the OSD main menu.
2. Navigate to the *Embedded QA* menu.
3. Enter the *Reading Room* submenu.
4. Select a desired reading room and confirm.

4.13 Embedded QA

About Embedded QA

Embedded QA allows you to run a display calibration or compliance test directly from the display using the OSD menus described in the next sections. Embedded QA will use the front sensor / I-Guard to measure the necessary luminance levels for either a calibration or compliance test. Various settings for both actions can be selected from the display's OSD menu. The last results of both actions can be consulted from the OSD.

Embedded QA or QAWeb?

Embedded QA is not a replacement for the Barco QAWeb solution.

Although Embedded QA is a reliable option to perform a simple calibration or compliance test, Barco still highly recommends QAWeb as the solution of choice for calibration and QA. QAWeb brings many benefits such as centralized asset management, the ability to schedule tasks, remote management, automated reporting, alerting and specific support of regional QA standards such as DIN 6868-57, JESRA and AAPM TG18. That's why QAWeb Agent acts as the master for all supported displays from the moment it is installed and running. QAWeb Agent will take over from Embedded QA and overwrite any settings which were applied by Embedded QA.

4.13.1 DICOM status report

About DICOM status report

- **DICOM Compliance status:** Shows if the current DICOM curve is compliant or not.
- **Maximum error:** Shows the maximum error of the current DICOM curve. This is the deviation compared to a perfect DICOM.
- **Luminance:** Shows the measured luminance.
- **Black luminance:** Shows the measured black luminance.
- **Time elapsed since latest compliance check:** Shows the backlight runtime since last compliance check.
- **DICOM Calibration Status**
 - **Not executed:** No other information is visible.
 - **Calibration executed:** When the calibration is executed, the time elapsed since latest calibration is shown.
- **Time elapsed since latest calibration:** Shows the backlight runtime since last calibration check.
- **DICOM compliance check:** Measures the DICOM curve of your display in different steps.
- **DICOM calibration:** Adds a correction to the current DICOM curve to approach the perfect DICOM curve as well as possible.
- **DICOM Error threshold:** Sets the error threshold. This is the maximum error allowed before a DICOM calibration is required.
- **Ambient Light Compensation:** Disables/Enables the ambient light compensation function.
- **Reading Room:** Selects a reading room.
- **Reset DICOM Calibration:** Restores the original (factory default) DICOM curve.

To retrieve the DICOM status report

1. Bring up the OSD main menu.
2. Navigate to the *Embedded QA* menu to make the information visible on the screen.

4.13.2 DICOM compliance check

About DICOM compliance check

The DICOM compliance check will measure the DICOM curve of your display in different steps. After measurement, the DICOM status report is shown.

To start DICOM compliance check

1. Bring up the OSD main menu.
2. Navigate to the *Embedded QA* menu.

3. Select *DICOM Compliance Check* to start the compliance check.



Warning: Press and hold the jog dial for approximately 3 seconds during the compliance check will abort the check.

4.13.3 DICOM calibration

About DICOM calibration

The DICOM calibration will add a correction to the current DICOM curve to approach the perfect DICOM curve as well as possible.

To start DICOM calibration

1. Bring up the OSD main menu.
2. Navigate to the *Embedded QA* menu.
3. Select *DICOM Calibration* to start the calibration.



Warning: Press and hold the jog dial for approximately 3 seconds during calibration will abort the calibration, previous values will be restored.



Note: After calibration, the compliance check will start automatically.

4.13.4 DICOM error threshold

About DICOM error threshold

The threshold to define the DICOM compliance can be modified in steps of 5% starting from 5 to 30%. When the maximum deviation is not bigger than the selected threshold, the compliance check will be OK.

To set the DICOM error threshold:

1. Bring up the OSD menu.
2. Navigate to the *Embedded QA* menu.
3. Enter the *DICOM Error Threshold* submenu.
4. Set *DICOM error threshold* as desired and confirm.

4.13.5 Reset DICOM calibration

About reset DICOM calibration

It is possible to restore the original (factory default) DICOM curve.

To reset the DICOM calibration:

1. Bring up the OSD main menu.
2. Navigate to the *Embedded QA* menu.
3. Enter the *Reset DICOM Calibration* submenu.
4. Select *Confirm* to restore the original (not corrected) DICOM curve.

4.14 Image source

About the image source

By default, your MDNC-8132 automatically detects the connected image sources. You can also manually select the image sources via the OSD menu.



The *Image Source* menu is not available when the *KVM switch* is enabled. (to disable, see "[KVM switch](#)", page 34)

To automatically select image sources

1. Bring up the OSD main menu.
2. Navigate to the *Image Settings* menu.
3. Enter the *Image source* submenu
4. Select *Auto* and confirm.

To manually select image sources

1. Bring up the OSD main menu.
2. Navigate to the *Image Settings* menu.
3. Enter the *Image source* submenu
4. Select *DisplayPort 1* or *DisplayPort 2 as desired* and confirm.

4.15 KVM switch

About KVM switch

The MDNC-8132 can be used in dual workstation setup with KVM switch. This allows the display to be connected to two different workstations and control both with a single keyboard and mouse connected to the display. Switching the video and control signals between the two workstations is done with the KVM switch, which must be enabled as explained below.



Your display system must be specifically set up and configured for KVM input switching. For instructions, see "[Dual workstation setup with KVM switch](#)", page 15.

To enable/disable the KVM switch

1. Bring up the OSD main menu.
2. Navigate to the *Image Settings* menu.
3. Enter the *KVM Switch* submenu.
4. Select *Enabled/Disabled* as desired and confirm.



When enabling the KVM switch, the *Image Source* menu will be inaccessible.

To switch KVM inputs

1. Bring up the OSD main menu.
2. Navigate to the *Image Settings* menu.
3. Enter the *KVM Input Selection* submenu.
4. Select *input 1* or *input 2* as desired and confirm.



When switching KVM inputs, the video is switched instantly while switching the USB signal might take a little longer (up to 2 seconds).



KVM input switching can also be done more quickly via the shortcut bar. See "[KVM input switching](#)", page 23.

4.16 System info

About system info

Your display serial number, native resolution, firmware version, etc. are available in a dedicated submenu of the OSD menu.

To retrieve info. about your display

1. Bring up the OSD main menu.
2. Navigate to the *System Info* menu to make the information visible on the screen.

4.17 Calibration status

About calibration status

The calibration status menu not only provides the current calibration status of the display (display function, luminance, ALC, etc.) but also provides a shortcut to *Display Function*, *Luminance Target*, *Color Temperature/White Tint*, *Reading Room* and *Ambient Light Compensation* submenus.

To retrieve/set the calibration status of your display

1. Bring up the OSD main menu.
2. Navigate to the *Calibration Status* menu to display the calibration status.
3. Enter an accessible submenu.
4. Set the calibration status as desired and confirm.

4.18 Maximum luminance demo

About maximum luminance demo

The maximum luminance demo sets the luminance of the LCD panel to its maximum value for 60 seconds, or until the demo is manually cancelled. The actual measured luminance is shown on-screen.



While activated, the maximum luminance demo disables the display's backlight stabilizer and sets the *Color Temperature/White Tint* to *Native White*. When the maximum luminance demo is cancelled, the original settings are restored.

To activate the maximum luminance demo

1. Bring up the OSD main menu.
2. Navigate to *Service Mode* submenu.
3. Enter the keycode: 5-0-4-0 to bring up the service mode menu.
4. Navigate to the *Maximum Luminance Demonstration* submenu.
5. Select *Enabled* to activate the maximum luminance demonstration.
6. Select *Disabled* to manually cancel the maximum luminance demonstration, or wait for 60 seconds after which the demonstration is automatically cancelled.

4.19 DisplayPort MST

About DisplayPort MST

The DisplayPort OUT connector of your MDNC-8132 supports Multi-Stream Transport (MST).

MST is a technology introduced for the DisplayPort 1.2 standard that enables the transmission of multiple video and audio streams over a single DisplayPort.

This allows the creation of daisy-chaining setups, where multiple monitors can be connected in a series using a single cable from the source device.

The primary advantage of MST is its ability to simplify cable management and reduce the number of cables required to connect multiple displays.

This technology is commonly used in scenarios where a user needs to extend their desktop across multiple monitors or set up a video wall.

MST technology offers a convenient solution for users seeking an extended and efficient display configuration without the clutter of multiple cables.

Multi-Stream Transport key points

Daisy Chaining — With MST, monitors can be daisy-chained, meaning that one monitor is connected to another in sequence, forming a chain.

The last monitor in the chain is connected to the video source, such as a computer or graphics card.

Extended Desktop — MST allows users to extend their desktop across multiple monitors as if they were a single, large display.

This is particularly useful for tasks that require a larger workspace, such as diagnostic viewing.

Resolution and Refresh Rates — MST supports high resolutions and refresh rates, making it suitable for demanding applications.

It ensures that each monitor in the chain receives the necessary signals for optimal display quality.

What will you need?

- Graphics card (GPU) supporting DisplayPort (1.2 or better) MST.
- DisplayPort 1.2 MST-capable monitor with MST mode enabled.
- A DP-to-DP cable for each monitor in the chain. Cables between monitors should not be that long to avoid cable clutter.
- Operating system should have proper driver support. While Microsoft Windows environments have full support for it, Apple operating systems currently do not support MST hubs or DisplayPort daisy-chaining as of macOS 10.15 ("Catalina").

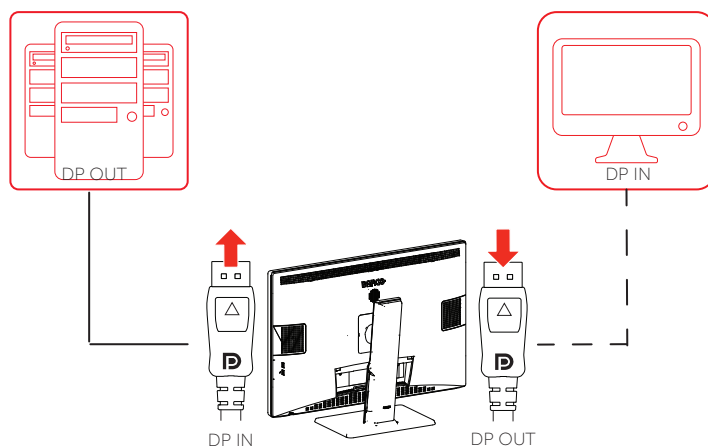

Cleaning the display

5

5.1 Cleaning instructions



CAUTION: Read and follow all instructions on the label of the cleaning product.



CAUTION: Take care not to damage or scratch the front glass or LCD. Do not use abrasive cleaning material (e.g., abrasive sponge or cloth) for cleaning the protective cover of the display. Be careful with rings or other jewelry and do not apply excessive pressure on the front glass or LCD.

To clean the display

Apply a cleaning/disinfecting product to a soft lint-free cloth, such as a microfiber or gauze and rub the display surface thoroughly. In order to be effective, all surfaces must be cleaned for a certain amount of time (ranging from 30 seconds to 2 minutes).

Use a cleaning/disinfecting product that is alcohol-, alkali-, water- or chlorine-based. Common examples are:

- Isopropanol 100%
- Ethanol 70%
- 0.5% Chlorhexidine in 70% ethanol/isopropanol
- Ortho-Phthalaldehyde (OPA) 0.55%
- Haemo-sol, 1% in water
- 250 ppm Chlorine solution
- 1.0% Iodine in 70% ethanol
- 1.6% aqueous ammonia
- "Green soap" (USP)
- 0.5% Chlorhexidine in 70% isopropyl alcohol
- Products similar to optical cleaning liquid
- Bacillol AF
- Flux
- Sodium hypochlorite 10%

When selecting an alternative cleaning/disinfecting product, it is recommended to always identify the active ingredients. In case of doubt about a certain cleaning product, use plain water.

Do not use any of the following products:

- Alcohol in concentrations > 70%
- Strong alkalis lye, strong solvents
- Acetone
- Toluene
- Acids
- Detergents containing fluoride
- Detergents containing ammonia
- Detergents containing abrasives
- Steel wool
- Sponge with abrasives
- Steel blades
- Cloths with steel thread
- Paper-based cloths (e.g. paper towels, facial tissues, toilet paper)



CAUTION: Do not apply or spray liquid directly to the display as excess liquid may cause damage to internal electronics. Instead, apply the liquid to a cleaning cloth.

Repacking instructions

6

6.1 Repacking instructions

To repack your display

1. Place the empty box on a stable surface.
2. Place the bottom buffer in the box.
3. Put the display in its original bag.
4. Put the display in the bottom buffer.

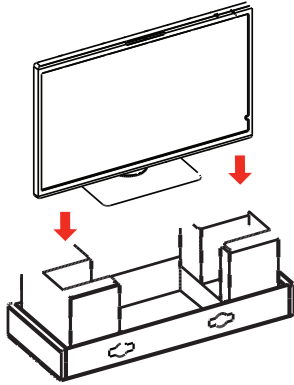

Image 6-1

5. Put the top buffer on top of the display.

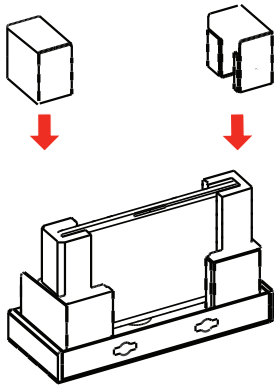

Image 6-2

6. Put the box with power supply and cables in the dedicated cavity of the top buffer. When applicable do the same with the display controller box.

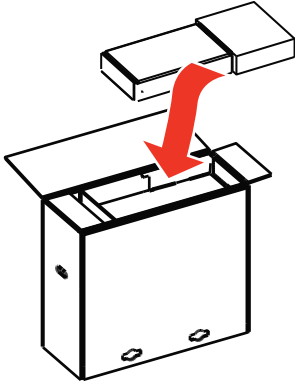

Image 6-3

7. Close the box.

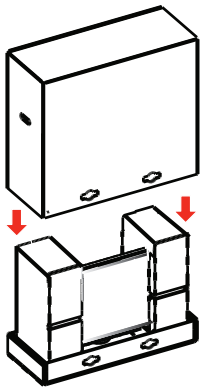

Image 6-4

8. Close the locks.

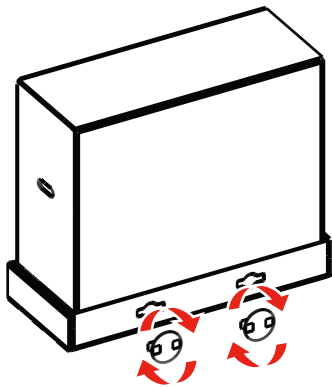

Image 6-5

Important information

7

| | | |
|-----|--|----|
| 7.1 | Safety information..... | 44 |
| 7.2 | Cybersecurity..... | 46 |
| 7.3 | Environmental information..... | 47 |
| 7.4 | Regulatory compliance information..... | 49 |
| 7.5 | EMC notice..... | 50 |
| 7.6 | Explanation of symbols..... | 52 |
| 7.7 | Open source license information..... | 56 |
| 7.8 | Technical specifications..... | 56 |

7.1 Safety information

General recommendations

Read the safety and operating instructions before operating the device.
Retain safety and operating instructions for future reference.
Adhere to all warnings on the device and in the operating instructions manual.
Follow all instructions for operation and use.

Electrical shock or fire hazard

To prevent electric shock or fire hazard, do not remove cover.
No serviceable parts inside. Refer servicing to qualified personnel.
Do not expose this apparatus to rain or moisture.

Modifications to the unit

Do not modify this equipment without authorization of the manufacturer.

Type of protection (Electrical)

Equipment with external power supply: Class I equipment

Degree of safety (flammable anesthetic mixture)

Equipment not suitable for use in the presence of a flammable anesthetic mixture with air or with oxygen or nitrous oxide.



Non-patient care equipment

Equipment primarily for use in a health care facility that is intended for use where contact with a patient is unlikely (no applied part).
The equipment shall not be used with life support equipment.
The user should not touch the equipment, nor its signal input ports (SIP)/signal output ports (SOP) and the patient at the same time.

Child safety

Equipment not suitable for use in locations where children are likely to be present.

Power connection – Equipment with external 24 VDC power supply

- Power requirements: The equipment must be powered using the delivered medical approved 24 VDC () SELV power supply.
- The medical approved DC () power supply must be powered by the AC mains voltage.
- The power supply is specified as a part of the ME equipment or combination is specified as a ME system.
- To avoid the risk of electric shock, this equipment must only be connected to a supply mains with protective earth.
- The equipment should be installed near an easily accessible outlet.
- The equipment is intended for continuous operation.

Transient over-voltage

If the device is not used for a long time, disconnect it from the AC inlet to avoid damage by transient over-voltage.

To fully disengage the power to the device, please disconnect the power cord from the AC inlet.

High magnetic environment

- The device shall not be used in the high magnetic environment of an MRI scanner.
- The installer shall assess the magnetic environment before installation or use of the device.

Power cords

- Do not overload wall outlets and extension cords as this may result in fire or electric shock.
- Mains lead protection (U.S.: Power cord): Power cords should be routed so that they are not likely to be walked upon or pinched by items placed upon or against them, paying particular attention to cords at plugs and receptacles.
- Use a power cord that matches the voltage of the power outlet, which has been approved and complies with the safety standard of your particular country.
- Korea: Use KC certified products; Plug: 250 V~, 16 A; Power cord: 60227 IEC 53, 3G0.75 mm² / 60227 IEC 53, 3G1.0 mm²; Connector: 250 V~, 10 A

Accessory equipment

Accessory equipment connected to the analog and digital interfaces must be in compliance with the respective nationally harmonized IEC standards (i. e. IEC 60950 for data processing equipment, IEC 60065 for video equipment, IEC 61010-1 for laboratory equipment, and IEC 60601-1 for medical equipment.) Furthermore all configurations shall comply with the system standard IEC 60601-1-1. Anyone who connects additional equipment to the signal input part or signal output part is configuring a medical system, and is therefore, responsible that the system complies with the requirements of the system standard IEC 60601-1-1. If in doubt, consult the technical services department or your local representative.

Water and moisture

Never expose the device to rain or moisture.

Never use the device near water - e.g. near a bathtub, washbasin, swimming pool, kitchen sink, laundry tub or in a wet basement.

High temperature

In case the monitor was exposed to high temperatures, the unit must be stored at room temp for at least 24 hours.

Ventilation

Do not cover or block any ventilation openings in the cover of the set. When installing the device in a cupboard or another enclosed location, heed the necessary space between the set and the sides of the cupboard.

Installation

Place the device on a flat, solid and stable surface that can support the weight of at least 3 devices. If you use an unstable cart or stand, the device may fall, causing serious injury to a child or adult, and serious damage to the device.

Malfunctions

Disconnect the equipment's power cord from the AC inlet and refer servicing to qualified service technicians under the following conditions:

- If the power cord or plug is damaged or frayed.
- If liquid has been spilled into the equipment.
- If the equipment has been exposed to rain or water.
- If the equipment does not operate normally when the operating instructions are followed. Adjust only those controls that are covered by the operating instructions since improper adjustment of other controls may result in damage and will often require extensive work by a qualified technician to restore the product to normal operation.
- If the equipment has been dropped or the cabinet has been damaged.
- If the product exhibits a distinct change in performance, indicating a need for service.

Medical electrical equipment

Medical - General medical equipment. As to electrical shock, fire and mechanical hazards only. In accordance with: AAMI ES60601-1 (2005) + AMD 1 (2012) + AMD 2 (2021) and CAN/CSA-C22.2 No. 60601-1:14 (Reaffirmed 2022).

National Scandinavian Deviations for CL. 1.7.2

Finland: "Laitte on liitettävä suojavaadoituskoskettimilla varustettuun pistorasiaan"

Norway: "Apparatet må tilkoples jordet stikkontakt"

Sweden: "Apparaten skall anslutas till jordat uttag"

7.2 Cybersecurity

Security objectives

The MDNC-8132 will be used for displaying and viewing digital images. Therefore, ensuring the availability of the digital images has been identified as the primary security objective of this product.

Nevertheless, the availability, integrity, and confidentiality of information processed by the product relies on the non-mandatory security recommendations described below.

The lack of storage or processing of patient or personal information, combined with the limited (network) connectivity, results in the MDNC-8132 entailing a low cybersecurity risk profile.

Security recommendations

The security measures listed below should be considered as a non-exhaustive list of possible security controls for the operating environment. The operating environment must not hinder the application of security measures on the product or force the device to operate in a lower security setting.

The operator shall maintain the necessary state-of-the-art policies, processes, standards and other security controls to incorporate, support and protect the product. This shall include the application of risk management (e.g. by implementing relevant standards).

The operating environment should provide physical security via security measures such as:

- Regulated and authenticated physical access enforced via suitable technical measures (e.g. badges)
- Physical security policy defining roles and access rights, including for physical access to the product
- Use of segregated, secure areas with appropriate access controls

The operating environment should include appropriate security controls such as:

- User access management (credentials for accessing software applications or devices, user access policy, etc.)
- Antivirus / anti-malware software
- Firewall
- Application whitelisting / system hardening
- Exclusive use of genuine software and ban of all illegitimate software and applications
- Session management measures (e.g. session timeouts)

The operating environment should provide control and security of network traffic via appropriate measures, such as:

- Network segmentation & network access control
- Traffic filtering
- Encrypted communication

Specifically for workstations connected to the product, appropriate security measures include:

- Operating system hardening and application whitelisting
- Use of strong passwords
- Install only software necessary for the intended use of the operating environment.

To ensure that the security posture of the operating environment and of the product itself remain at a suitable level, appropriate provisions regarding patch management should be in place, such as:

- The operating environment should support patching without compromising interoperability/compatibility
- The operator should have appropriate patch management processes to ensure that security patches for the product are deployed in a timely manner
- The operator should have appropriate patch management processes to ensure that the operating environment (e.g. operating systems, applications) is up-to-date in terms of security

7.3 Environmental information

Disposal Information



Waste Electrical and Electronic Equipment (WEEE)

This symbol on the product indicates that, under the European Directive 2012/19/EU governing waste from electrical and electronic equipment, this product must not be disposed of with other municipal waste. Please dispose of your waste equipment by handing it over to a designated collection point for the recycling of waste electrical and electronic equipment. To prevent possible harm to the environment or human health from uncontrolled waste disposal, please separate these items from other types of waste and recycle them responsibly to promote the sustainable reuse of material resources.

For more information about recycling of this product, please contact your local city office or your municipal waste disposal service. For details, please visit the Barco website at: <https://www.barco.com/about/sustainability/waste-of-electronic-equipment-customers>

Turkey RoHS compliance



Türkiye Cumhuriyeti: AEEE Yönetmeliğine Uygundur.

[Republic of Turkey: In conformity with the WEEE Regulation]

中国大陆 RoHS

Chinese Mainland RoHS

根据中国大陆《电器电子产品有害物质限制使用管理办法》（也称为中国大陆RoHS），以下部分列出了Barco产品中可能包含的有毒和/或有害物质的名称和含量。中国大陆RoHS指令包含在中国信息产业部MCV标准：“电子信息产品中有毒物质的限量要求”中。

According to the “Management Methods for the Restriction of the Use of Hazardous Substances in Electrical and Electronic Products ” (Also called RoHS of Chinese Mainland), the table below lists the names and contents of toxic and/or hazardous substances that Barco’s product may contain. The RoHS of Chinese Mainland is included in the MCV standard of the Ministry of Information Industry of China, in the section “Limit Requirements of toxic substances in Electronic Information Products”.

| 零件项目(名称) Component name | 有毒有害物质或元素 Hazardous substances and elements | | | | | |
|--------------------------------------|--|---------|---------|-------------|-------------|---------------|
| | 铅 Pb | 汞 Hg | 镉 Cd | 六价铬 Cr6+ | 多溴联苯 PBB | 多溴二苯醚 PBDE |
| 印制电路配件 Printed Circuit Assemblies | X | O | O | O | O | O |
| 液晶面板 LCD panel | X | O | O | O | O | O |
| 外接电(线)缆 External Cables | X | O | O | O | O | O |
| 内部线路 Internal wiring | O | O | O | O | O | O |

| 零件项目(名称) Component name | 有毒有害物质或元素 Hazardous substances and elements | | | | | |
|--|--|---------|---------|-------------|-------------|---------------|
| | 铅 Pb | 汞 Hg | 镉 Cd | 六价铬 Cr6+ | 多溴联苯 PBB | 多溴二苯醚 PBDE |
| 金属外壳 Metal enclosure | O | O | O | O | O | O |
| 塑胶外壳 Plastic enclosure | O | O | O | O | O | O |
| 散热片(器) Heatsinks | O | O | O | O | O | O |
| 风扇 Fan | O | O | O | O | O | O |
| 电源供应器 Power Supply Unit | X | O | O | O | O | O |
| 文件说明书 Paper Manuals | O | O | O | O | O | O |
| 光盘说明书 CD manual | O | O | O | O | O | O |
| 本表格依据SJ/T 11364的规定编制 This table is prepared in accordance with the provisions of SJ/T 11364. O: 表示该有毒有害物质在该部件所有均质材料中的含量均在 GB/T 26572 标准规定的限量要求以下。 O: Indicates that this toxic or hazardous substance contained in all of the homogeneous materials for this part is below the limit requirement in GB/T 26572. X: 表示该有毒有害物质至少在该部件的某一均质材料中的含量超出 GB/T 26572 标准规定的限量要求。 X: Indicates that this toxic or hazardous substance contained in at least one of the homogeneous materials used for this part is above the limit requirement in GB/T 26572. | | | | | | |

在中国大陆销售的相应电子信息产品（EIP）都必须遵照中国大陆《电子电气产品有害物质限制使用标识要求》标准贴上环保使用期限（EFUP）标签。Barco产品所采用的EFUP标签（请参阅实例，徽标内部的编号用于指定产品）基于中国大陆的《电子信息产品环保使用期限通则》标准。

All Electronic Information Products (EIP) that are sold within Chinese Mainland must comply with the “Marking for the restriction of the use of hazardous substances in electrical and electronic product” of Chinese Mainland, marked with the Environmental Friendly Use Period (EFUP) logo. The number inside the EFUP logo that Barco uses (please refer to the photo) is based on the “General guidelines of environment-friendly use period of electronic information products” of Chinese Mainland.



中国RoHS自我声明符合性标志 / China RoHS – SDoC mark

本产品符合《电器电子产品有害物质限制使用管理办法》和《电器电子产品有害物质限制使用达标管理目录》的要求。

This product meets the requirements of the “Management Rule on the Use Restriction of Hazardous Substances in Electrical and Electronic Products” and the “Management Catalogue for the Use Restriction of Hazardous Substances in Electrical and Electronic Products”.



绿色自我声明符合性标志可参见电子档文件

The green SDoC mark is visible in the digital version of this document.

7.4 Regulatory compliance information

Indications for use

The display is intended to be used for displaying and viewing digital images (excluding digital mammography) for review and analysis by trained medical practitioners.

Intended usage environment

- The display is not in contact nor in the same environment (within 1.5m) as a person actively undergoing a medical, surgical or dental procedure.
- The device is intended to be used in a healthcare facility or a medical professional's workplace.

Caution (USA): Federal law restricts this device to sale by or on the order of a physician. (Details & exemptions are in the Code of Federal Regulations Title 21, 801 Part D).

Contra-indications

- The device is not intended for digital mammography.
- The device is not intended to be used in conjunction with high powered medical equipment (HF surgical equipment, short-wave therapy equipment, equipment inside the RF shielded room for magnetic resonance imaging).

Intended users

Barco diagnostic displays are intended to be used for primary diagnosis by trained medical practitioners. The device is initially set up by professional integrators or medical staff.

Notice to the user and/or patient

Any serious incident that has occurred in relation to the device should be reported to the manufacturer and the competent authority of the Member State in which the user and/or patient is established.

Factory addresses

- **Barco NV**, President Kennedypark 35, 8500 Kortrijk, Belgium
- **Fimi S.r.l.**, Via Saul Banfi 1, 21047 Saronno, VA, Italy
- **巴可 (苏州) 医疗科技有限公司**, 苏州工业园区苏桐路111号
Barco (Suzhou) Healthcare Technology Co., Ltd., No.111, Sutong Road, Suzhou Industrial Park, 215021 Suzhou China

Manufacturing country

The manufacturing country of the product is indicated on the product label (“**Made in ...**”).

Importers contact information

To find your local importer, contact one of Barco’s regional offices via the contact information provided on our website (www.barco.com).

FCC class B

This device complies with Part 15 of the FCC Rules. Operation is subject to the following two conditions: (1) this device may not cause harmful interference, and (2) this device must accept any interference received, including interference that may cause undesired operation.

This device has been tested and found to comply with the limits for a Class B digital device, pursuant to Part 15 of the FCC Rules. These limits are designed to provide reasonable protection against harmful interference in a residential installation. This device generates, uses and can radiate radio frequency energy and, if not installed and used in accordance with the instructions, may cause harmful interference to radio communications. However, there is no guarantee that interference will not occur in a particular installation. If this device does cause harmful interference to radio or television reception, which can be determined by

turning the device off and on, the user is encouraged to try to correct the interference by one or more of the following measures:

- Reorient or relocate the receiving antenna.
- Increase the separation between the device and receiver.
- Connect the device into an outlet on a circuit different from that to which the receiver is connected.
- Consult the dealer or an experienced radio/TV technician for help.

Changes or modifications not expressly approved by the party responsible for compliance could void the user's authority to operate the equipment.

FCC responsible: Barco Inc., 3059 Premiere Parkway Suite 400, 30097 Duluth GA, United States, Tel: +1 678 475 8000

Canadian notice

CAN ICES-001(B) / NMB-001(B)

Brazilian local representative

Barco Ltda, Av. Ibirapuera, 2332 - Andar 8 - Bloco 2 - Conj 82, Bairro:Ibirapuera, Distrito:Moema, 4028-002, São Paulo, Brasil

7.5 EMC notice

General information

This device is for use in professional healthcare facility environments only.

With the installation of the device, use only the delivered external cables and power supply or a spare part provided by the legal manufacturer. Using another can result in a decrease of the immunity level of the device.



WARNING: Use of this equipment adjacent to or stacked with other equipment should be avoided because it could result in improper operation. If such use is necessary, this equipment and the other equipment should be observed to verify that they are operating normally.



WARNING: Use of accessories, transducers and cables other than those specified or provided by the manufacturer of this equipment could result in increased electromagnetic emissions or decreased electromagnetic immunity of this equipment and result in improper operation.



WARNING: Portable RF communications equipment (including peripherals such as antenna cables and external antennas) should be used no closer than 30 cm (12 inches) to any part of the MDNC-8132, including cables specified by the manufacturer. Otherwise, degradation of the performance of this equipment could result.

Electromagnetic emissions

| Emissions test | Compliance |
|---|------------|
| RF emissions (CISPR 11) | Group 1 |
| RF emissions (CISPR 11) | Class B |
| Harmonic emissions (IEC 61000-3-2) | Class D |
| Voltage fluctuations/ flicker emissions (IEC 61000-3-3) | Complies |

This MDNC-8132 complies with appropriate medical EMC standards on emissions to, and interference from surrounding equipment. Operation is subject to the following two conditions: (1) this device may not cause harmful interference, and (2) this device must accept any interference received, including interference that may cause undesired operation.

Interference can be determined by turning the equipment off and on.

If this equipment does cause harmful interference to, or suffer from harmful interference of, surrounding equipment, the user is encouraged to try to correct the interference by one or more of the following measures:

- Reorient or relocate the receiving antenna or equipment.
- Increase the separation between the equipment and receiver.
- Connect the equipment into an outlet on a circuit different from that to which the receiver is connected.
- Consult the dealer or an experienced technician for help.

Electromagnetic immunity

| Test | 60601-1-2 Test level | Compliance level according TR 60601-4-2 |
|--|--|---|
| Electrostatic discharge Immunity (IEC 61000-4-2) | ± 8 kV contact ± 2 kV, ± 4 kV, ± 8 kV, ± 15 kV air | ± 4 kV contact ± 2 kV, ± 4 kV, ± 8 kV air |
| Electrical fast transient/burst Immunity (IEC 61000-4-4) | ± 2 kV/100kHz (power) ± 1 kV/100kHz (signal) All cables >3m | ±2kV (5kHz or 100kHz power) ±0.5kV (5kHz or 100kHz signal) All cables >3m |
| Surge Immunity (IEC61000-4-5) | ±0,5kV, ±1kV line-to-line ±0,5kV, ±1kV, 2kV line-to-ground | ±0,5kV, ±1kV line-to-line ±0,5kV, ±1kV, 2kV line-to-ground |
| Voltage dips, short interruptions and voltage Variations Immunity (IEC 61000-4-11) | 0% UT 0,5 cycle at 0°, 45°, 90°, 135°, 180°, 225°, 270° and 315° 0% UT 1 cycle 70% UT 25/30 cycles at 0° 0% UT 250/300 cycles | 0% UT 0,5 cycle at 0°, 180° 70% UT 25/30 cycles at 0° 0% UT 250/300 |
| Power frequency magnetic field Immunity (IEC 61000-4-8) | 30 A/m 50Hz or 60Hz | 3 A/m 50Hz or 60Hz |
| Immunity to conducted disturbances induced by RF fields (IEC 61000-4-6) | 3V/ 150kHz-80MHz 6V in ISM bands 80% AM 1kHz All cables >1m | 3V/ 150kHz-80MHz (ISM bands N.A.) 80% AM 1kHz All cables >3m |
| Radiated RF electromagnetic field Immunity (IEC 61000-4-3) | 3V/m 80MHz-2,7GHz 80% AM 1kHz | 3V/m 80MHz-2,7GHz 80% AM 1kHz |
| Immunity to proximity fields from RF wireless communications equipment (IEC 61000-4-3) | 385 MHz 18Hz PM 27V/m 450 MHz 1kHz FM 28V/m 710 MHz 217Hz PM 9V/m 745 MHz 217Hz PM 9V/m 780 MHz 217Hz PM 9V/m 810 MHz 18Hz PM 28V/m 870 MHz 18Hz PM 28V/m 930 MHz 18Hz PM 28V/m 1720 MHz 217Hz PM 28V/m 1845 MHz 217Hz PM 28V/m 1970 MHz 217Hz PM 28V/m 2450 MHz 217Hz PM 28V/m 5240 MHz 217Hz PM 9V/m 5500 MHz 217Hz PM 9V/m 5785 MHz 217Hz PM 9V/m | 385 MHz 18Hz PM 6V/m 450 MHz 1kHz FM 9V/m 710 MHz 217Hz PM 3V/m 745 MHz 217Hz PM 3V/m 780 MHz 217Hz PM 3V/m 810 MHz 18Hz PM 9V/m 870 MHz 18Hz PM 9V/m 930 MHz 18Hz PM 9V/m 1720 MHz 217Hz PM 9V/m 1845 MHz 217Hz PM 9V/m 1970 MHz 217Hz PM 9V/m 2450 MHz 217Hz PM 9V/m 5240 MHz 217Hz PM 6V/m 5500 MHz 217Hz PM 6V/m 5785 MHz 217Hz PM 6V/m |



Immunity to RF wireless communications equipment















| Test frequency (MHz) | Band (MHz) | Service | Modulation | Maximum power (W) | Distance (m) | Immunity test level (V/m) |
|----------------------|-------------|--|---|-------------------|--------------|---------------------------|
| 385 | 380 – 390 | TETRA 400 | Pulse modulation 18 Hz | 1.8 | 0.3 | 27 |
| 450 | 430 – 470 | GMRS 460, FRS 460 | FM \pm 5 kHz deviation 1 kHz sine | 2 | 0.3 | 28 |
| 710 | 704 – 787 | LTE Band 13, 17 | Pulse modulation 217 Hz | 0.2 | 0.3 | 9 |
| 745 | | | | | | |
| 780 | | | | | | |
| 810 | 800 – 960 | GSM 800/ 900, TETRA 800, iDEN 820, CDMA 850, LTE Band 5 | Pulse modulation 18 Hz | 2 | 0.3 | 28 |
| 870 | | | | | | |
| 930 | | | | | | |
| 1720 | 1700 – 1990 | GSM 1800, CDMA 1900, GSM 1900, DECT, LTE Band 1/3/4/ 25, UMTS | Pulse modulation 217 Hz | 2 | 0.3 | 28 |
| 1845 | | | | | | |
| 1970 | | | | | | |
| 2450 | 2400 – 2570 | Bluetooth, WLAN, 802.11 b/g/n, RFID 2450, LTE Band 7 | Pulse modulation 217 Hz | 2 | 0.3 | 28 |
| 5240 | 5100 – 5800 | WLAN 802.11 a/n | Pulse modulation 217 Hz | 0.2 | 0.3 | 9 |
| 5500 | | | | | | |
| 5785 | | | | | | |

















7.6 Explanation of symbols

Symbols on the device



On the device or power supply, you may find the following symbols (nonrestrictive list):

| | |
|---|--|
|  0123 | Indicates the device meets the requirements of the applicable EC directives/ regulations. |
|  | Indicates compliance with Part 15 of the FCC rules (Class A or Class B). |

| | |
|--|---|
|  | Indicates the device is approved according to the UL regulations for Canada and US. |
|  | Indicates the device is approved according to the UL Demko regulations. |
|  | Indicates the device is approved according to the CCC regulations. |
|  | Indicates the device is approved according to the VCCI regulations. |
|  | Indicates the device is approved according to the KC regulations. |
|  | Indicates the device is approved according to the BSMI regulations. |
|  | Indicates the device is approved according to the PSE regulations. |
|  | Indicates the device is approved according to the RCM regulations. |
|  | Indicates the device is approved according to the EAC regulations. |
|  | Caution: Federal law (United States of America) restricts this device to sale by or on the order of a licensed healthcare practitioner. |
| <p data-bbox="183 1512 295 1556">IS 13252 (Part 1) IEC 60950-1</p>  <p data-bbox="183 1653 295 1684">R-xxxxxxx www.bis.gov.in</p> | Indicates the device is approved according to the BIS regulations. |
|  | Indicates the device is approved according to the INMETRO regulations. |
|  | Indicates the USB connectors on the device. |
|  | Indicates the DisplayPort connectors on the device. |





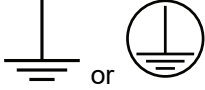

| | |
|---|---|
|  | Indicates the legal manufacturer. |
|  | Indicates the manufacturing date. |
|  | Indicates the entity importing the medical device into the locale. |
|  | Indicates the temperature limitations ² for the device to safely operate within specs. |
|  | Indicates that the device is a Medical Device. |
|  | Indicates the device Serial Number. |
|  | Indicates the device part number or catalogue number. |
|  | Indicates the Unique Device Identifier. |
|  | Indicates the Authorised Representative for the European Union. |
|  | Indicates the Authorised Representative for Switzerland. |
|  | Warning: dangerous voltage |
|  | Caution |
|  | Consult the Instructions For Use. |
|  | Consult the Instruction For Use on the website address that is provided as eIFU indicator. |
|  | Indicates this device must not be thrown in the trash but must be recycled, according to the European WEEE (Waste Electrical and Electronic Equipment) directive. |
|  | Indicates Direct Current (DC). |

2. Values for xx and yy can be found in the technical specifications paragraph.

| | |
|---|-------------------------------------|
|  | Indicates Alternating Current (AC). |
|  | Stand-by |
|  | Equipotentiality |
|  | Protective earth (ground) |

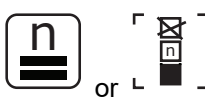
Symbols on the box

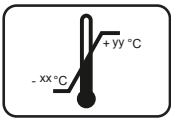
On the box of the device, you may find the following symbols (nonrestrictive list):

| | |
|---|---|
|  | Indicates a device that can be broken or damaged if not handled carefully when being stored. |
|  | Indicates a device that needs to be protected from moisture when being stored. |
|  | Indicates the storage direction of the box. The box must be transported, handled and stored in such a way that the arrows always point upwards. |
|  | Indicates the maximum number of identical boxes which may be stacked on each other, where “n” is the limiting number. |
|  | Indicates the weight of the box and that it should be carried with two persons. |
|  | Indicates that the box should not be cut with a knife, a cutter or any other sharp object. |
|  | Indicates the temperature limits ³ to which the device can be safely exposed when being stored. |
|  | Indicates the range ³ of humidity to which the device can be safely exposed when being stored. |
|  | Indicates the range ³ of atmospheric pressure to which the device can be safely exposed when being stored. |

3. Values for xx and yy can be found in the technical specifications paragraph.

7.7 Open source license information

Open source license information

This product contains software components released under an Open Source license. You acknowledge living up to the conditions of each separate Open Source Software license.

A list of the Open Source Software components used is available in the applicable EULA, through the “My Barco” section of the Barco website or through other (online) means.

Copyright on each Open Source Software component belongs to the respective initial copyright holder, each additional contributor and/or their respective assignee(s), as may be identified in the respective Open Source Software documentation, source code, README file, or otherwise. You shall not remove or obscure or otherwise alter the respective copyrights.

EACH SEPARATE OPEN SOURCE SOFTWARE COMPONENT AND ANY RELATED DOCUMENTATION ARE PROVIDED "AS IS" WITHOUT EXPRESS OR IMPLIED WARRANTY INCLUDING, BUT NOT LIMITED TO, THE IMPLIED WARRANTIES OF MERCHANTABILITY AND FITNESS FOR A PARTICULAR PURPOSE. IN NO EVENT SHALL THE COPYRIGHTHOLDER OR ANY OTHER CONTRIBUTOR BE LIABLE FOR DIRECT, INCIDENTAL, SPECIAL, EXEMPLARY OR CONSEQUENTIAL DAMAGES, EVEN IF ADVISED OF THE POSSIBILITY OF SUCH DAMAGES, HOWEVER CAUSED AND ON ANY THEORY OF LIABILITY. MORE INFORMATION/DETAILS IS TO BE FOUND IN EACH SPECIFIC OPEN SOURCE LICENSE.

With respect to GPL, LGPL or similar licenses with regard to corresponding source code access and automatic license terms applicability:

- You acknowledge living up to the conditions of each such specific applicable Open Source Software license. You are responsible for your own additions, changes or modifications without any recourse or claim towards Barco whatsoever. You further acknowledge that any such additions, changes or modifications may impair the ability of Barco – at Barco’s sole discretion - to continue to provide service, warranties, software updates, fixes, maintenance, access or such similar abilities, without any recourse or claim towards Barco whatsoever.
- Barco offers to provide the corresponding source code, and shall make the corresponding source code available to you via email or download link, except where the applicable license entitles you to require Barco to provide you the corresponding source code on a tangible medium, in which case Barco will charge you for the actual costs of performing such distribution, such as the cost of media, shipping and handling. You may exercise this option upon written request to Barco N.V, attn. legal department, Beneluxpark 21, 8500 Kortrijk (Belgium). This offer is valid for a period of three (3) years from the date of the distribution of this product by Barco.

7.8 Technical specifications

| | |
|--------------------------------------|-----------------------------------|
| Screen technology | IPS |
| Active screen size (diagonal) | 812.80 mm (32.0") |
| Active screen size (H x V) | 708.48 x 398.52 mm (27.9 x 15.7") |
| Aspect ratio (H:V) | 16:9 |
| Resolution | 8MP (3840 x 2160 pixels @ 60 Hz) |
| Pixel pitch | 0.1845 mm |
| Color imaging | Yes |
| Gray imaging | Yes |
| Bit depth | 30 Bit |
| Viewing angle (H, V) | 178° |
| Uniformity correction | ULT |

| | |
|--|--|
| SteadyGray | Yes |
| SteadyColor | Yes (in MXRT Display Controller), when used as a system with MXRT Display Controller & QAWeb Enterprise |
| Color gamut NTSC | 94% |
| Color gamut sRGB | 132% |
| sRGB Delta E2000 (typical) | Average: < x Max: < x |
| RapidFrame | Yes |
| Ambient light presets | Yes, reading room selection |
| Ambient light sensor | Yes |
| Front sensor | Yes, I-Guard |
| Presence sensor | Yes |
| Maximum luminance (panel typical) | 850 cd/m ² |
| DICOM calibrated luminance | 420 cd/m ² |
| Contrast ratio (panel typical) | 1350:1 |
| Response time ((Tr + Tf)/2) (typical) | 12.7 ms |
| Housing color | Black (RAL 9004) / White (RAL 9003) |
| Video input signals | 2x DisplayPort 1.4 |
| Video output signals | 1x DisplayPort (MST) |
| USB ports | 2x USB-B 2.0 upstream (endpoint) 5x USB-A 2.0 downstream (of which 1 charge port) |
| KVM switch | Yes |
| Power rating | 24 Vdc, 8.3 A |
| Power requirements | This device shall only be powered by the medical approved power supply of Adapter Tech., type ATM200T-P240: <ul style="list-style-type: none"> • Input: 100-240 Vac, 50-60 Hz, 2.5-0.9 A • Output: 24 Vdc, 8.3 A |
| Power consumption | 60 W (nominal) < 0.35 W (hibernate) < 0.35 W (switched off) |
| Dimensions with stand (W x H x D) | 743 x 518~618 x 238 mm |
| Dimensions w/o stand (W x H x D) | 743 x 459 x 63 mm |
| Dimensions packaged (W x H x D) | 898 x 752 x 358 mm |
| Net weight with stand | 13 kg |
| Net weight w/o stand | 8.4 kg |
| Net weight packaged | 21 kg (without optional accessories) |

| | |
|--------------------------------|--|
| Tilt | -5° to +25° |
| Swivel | -30° to +30° |
| Pivot | N/A |
| Height adjustment range | 100 mm |
| Mounting standard | VESA (100 mm) |
| Screen protection | N/A |
| Recommended modalities | All digital images, except digital mammography. |
| Certifications* | <p>CE0123 (Medical Device) FDA 510(k) K233693 CCC (China), KC (Korea), INMETRO (Brazil), BIS (India), EAC (Russia)</p> <p>Safety specific: IEC 60950-1:2005 + A1:2009 + A2:2013 EN 60950-1:2006 + A1:2010 + A11:2009 + A12:2011 + A2:2013 IEC 62368-1:2018 EN IEC 62368-1:2020 + A11:2020 IEC 60601-1:2005 + A1:2012 + A2:2020 EN 60601-1:2006 + A1:2013 + A12:2014 + A2:2021 AAMI ES 60601-1:2005 + A1:2012 + A2:2021 CAN/CSA C22.2 No. 60601-1:2014 (Reaffirmed 2022)</p> <p>EMI specific: IEC 60601-1-2:2014+A1:2020 (ed4.1) EN 60601-1-2:2015 + A1:2021 (ed4.1) FCC part 15 Class B ICES-001 Level B VCCI (Japan)</p> <p>Environmental: EU RoHS, China RoHS, REACH, Canada Health, WEEE, Packaging Directive</p> <p>*Some of the listed certifications may still be pending. For the actual list of applicable certifications, please refer to the product page on www.barco.com or see the certification marks on the product label of your display.</p> |
| Supplied accessories | <p>User Guide Quick Install Sheet Documentation disc System sheet Video cables Mains cables USB cable External power supply</p> |
| Optional accessories | <p>Display controller Touch pad</p> |
| QA software | QAWeb Enterprise |
| Warranty | 5 years, including 20000 hours backlight warranty |
| Operating temperature | 0 °C to 35 °C (20 °C to 30 °C within specs) |
| Storage temperature | -20 °C to +60 °C |

| | |
|---------------------------|------------------------------|
| Operating humidity | 8 % to 70 % (non-condensing) |
| Storage humidity | 5 % to 70 % (non-condensing) |
| Operating pressure | 70 kPa |
| Storage pressure | 50 to 106 kPa |

CE
0123



Barco NV
President Kennedypark 35
8500 Kortrijk
Belgium



R5917119 /02 | 2024-06-17

www.barco.com