



User Guide

© 2015 HP Development Company, L.P.

HDMI, the HDMI Logo and High-Definition Multimedia Interface are trademarks or registered trademarks of HDMI Licensing LLC.

The information contained herein is subject to change without notice. The only warranties for HP products and services are set forth in the express warranty statements accompanying such products and services. Nothing herein should be construed as constituting an additional warranty. HP shall not be liable for technical or editorial errors or omissions contained herein.

Product notice





This guide describes features that are common to most models. Some features may not be available on your product. Some features may not be available on your product. To access the latest user guide, go to <http://www.hp.com/support>, and select your country. Select **Drivers & Downloads**, and then follow the on-screen instructions.

First Edition: November 2015

Document Part Number: 827618-001

About This Guide

This guide provides information on monitor features, setting up the monitor, and technical specifications.

-
-  **WARNING!** Indicates a hazardous situation that, if not avoided, **could** result in death or serious injury.
 -  **CAUTION:** Indicates a hazardous situation that, if not avoided, **could** result in minor or moderate injury.
 -  **NOTE:** Contains additional information to emphasize or supplement important points of the main text.
 -  **TIP:** Provides helpful hints for completing a task.
-



This product incorporates HDMI technology.

Table of contents

1 Getting Started	1
Important safety information	1
Product features and components	2
Features	2
Rear components	3
Front bezel controls	4
Setting up the monitor	5
Installing the monitor stand	5
Connecting the cables	6
Adjusting the monitor	9
Turning on the monitor	11
HP watermark and image retention policy	11
Removing the monitor stand	12
Mounting the display head	12
Installing a security cable	14
2 Using the monitor	15
Software and utilities	15
The Information file	15
The Image Color Matching file	15
Installing the .INF and .ICM files	15
Installing from the optical disc	15
Downloading from the Web	16
Using the On-Screen Display (OSD) menu	17
Assigning the Function buttons	18
Using Auto-Sleep Mode	19
3 Support and troubleshooting	20
Solving common problems	20
Using the auto-adjustment function (analog input)	21
Optimizing image performance (analog input)	22
Button lockouts	23
Product support	23
Preparing to call technical support	23
Locating the serial number and product number	24

4 Maintaining the monitor	25
Maintenance guidelines	25
Cleaning the monitor	25
Shipping the monitor	25
Appendix A Technical specifications	26
54.61 cm/21.5-inch model	26
58 cm/23-inch model	27
Preset display resolutions	28
54.61 cm/21.5-inch and 58 cm/23-inch models	28
Entering user modes	28
Energy saver feature	29
Appendix B Accessibility	30
Supported assistive technologies	30
Contacting support	30

1 Getting Started

Important safety information

An AC power cord is included with the monitor. If another cord is used, use only a power source and connection appropriate for this monitor. For information on the correct power cord set to use with the monitor, refer to the *Product Notices* provided on the optical disc or in your documentation kit.

 **WARNING!** To reduce the risk of electric shock or damage to the equipment:

- Plug the power cord into an AC outlet that is easily accessible at all times.
- Disconnect power from the computer by unplugging the power cord from the AC outlet.
- If provided with a 3-pin attachment plug on the power cord, plug the cord into a grounded (earthed) 3-pin outlet. Do not disable the power cord grounding pin, for example, by attaching a 2-pin adapter. The grounding pin is an important safety feature.

For your safety, do not place anything on power cords or cables. Arrange them so that no one may accidentally step on or trip over them.

To reduce the risk of serious injury, read the *Safety and Comfort Guide*. It describes proper workstation, setup, posture, and health and work habits for computer users, and provides important electrical and mechanical safety information. This guide is located on the Web at <http://www.hp.com/ergo>.

 **CAUTION:** For the protection of the monitor, as well as the computer, connect all power cords for the computer and its peripheral devices (such as a monitor, printer, scanner) to some form of surge protection device such as a power strip or Uninterruptible Power Supply (UPS). Not all power strips provide surge protection; the power strips must be specifically labeled as having this ability. Use a power strip whose manufacturer offers a Damage Replacement Policy so you can replace the equipment, if surge protection fails.

Use the appropriate and correctly sized furniture designed to properly support your HP LCD monitor.

 **WARNING!** LCD monitors that are inappropriately situated on dressers, bookcases, shelves, desks, speakers, chests, or carts may fall over and cause personal injury.

Care should be taken to route all cords and cables connected to the LCD monitor so that they cannot be pulled, grabbed, or tripped over.

Be sure that the total ampere rating of the products connected to the AC outlet does not exceed the current rating of the outlet, and that the total ampere rating of the products connected to the cord does not exceed the rating of the cord. Look on the power label to determine the ampere rating (AMPS or A) for each device.

Install the monitor near an AC outlet that you can easily reach. Disconnect the monitor by grasping the plug firmly and pulling it from the AC outlet. Never disconnect the monitor by pulling the cord.

Do not drop the monitor or place it on an unstable surface.

 **NOTE:** This product is suitable for entertainment purposes. Consider placing the monitor in a controlled luminous environment to avoid interference from surrounding light and bright surfaces that may cause disturbing reflections from the screen.

Product features and components

Features

The monitor features include the following:

- 54.61 cm (21.5-inch) diagonal viewable screen area with 1920 x 1080 resolution, plus full-screen support for lower resolutions; includes custom scaling for maximum image size while preserving original aspect ratio
- 58 cm (23-inch) diagonal viewable screen area with 1920 x 1080 resolution, plus full-screen support for lower resolutions; includes custom scaling for maximum image size while preserving original aspect ratio
- Nonglare panel with an LED backlight
- Wide viewing angle to allow viewing from a sitting or standing position, or when moving from side to side
- Tilt capability
- Pivot capability to rotate the display head from landscape to portrait mode
- Swivel and height adjustment capabilities
- Removable stand for flexible display head mounting solutions
- DisplayPort and VGA video inputs (cables provided)
- One HDMI (High-Definition Multimedia Interface) video input (cable not provided)
- USB 2.0 hub with one upstream port (connects to the computer) and two downstream ports (connects to USB devices)
- USB cable provided to connect the monitor's USB hub to the USB connector on the computer
- Plug-and-play capability if supported by your operating system
- Security cable slot provision on rear of monitor for optional security cable
- On-Screen Display (OSD) adjustments in several languages for easy setup and screen optimization
- HP Display Assistant software for adjusting monitor settings and enabling the theft deterrence features (refer to the *HP Display Assistant User Guide* on the optical disc included with your monitor)
- HDCP (High-Bandwidth Digital Content Protection) copy protection on all digital inputs
- Software and documentation optical disc that includes monitor drivers and product documentation
- Energy saver feature to meet requirements for reduced power consumption



NOTE: For safety and regulatory information, refer to the *Product Notices* provided on your optical disc or in your documentation kit. To locate updates to the user guide for your product, go to <http://www.hp.com/support>, and select your country. Select **Drivers & Downloads**, and then follow the on-screen instructions.

Rear components

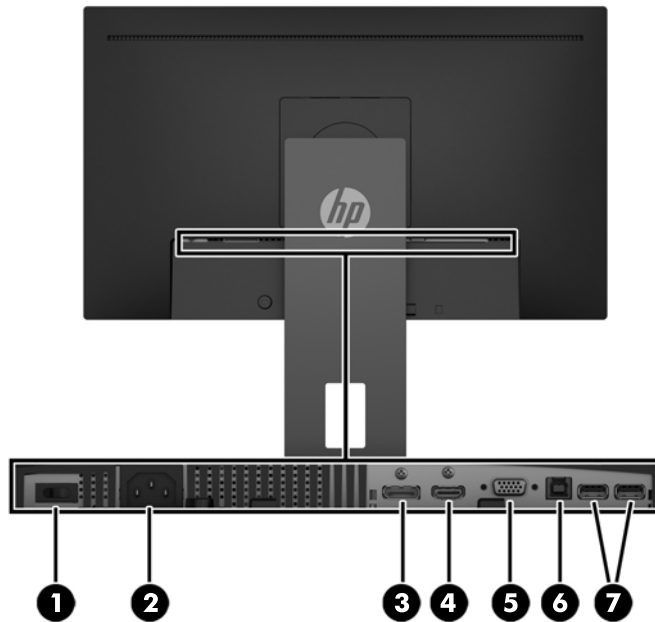

Component	Function
1 Master power switch	Turns off all power to the monitor. NOTE: Putting the switch in the Off position will yield the lowest power state for the monitor when not in use.
2 Power connector	Connects the AC power cord to the monitor.
3 DisplayPort connector	Connects the DisplayPort cable to the monitor.
4 HDMI connector	Connects the HDMI cable to the monitor.
5 VGA connector	Connects the VGA cable to the monitor.
6 USB 2.0 upstream connector	Connects the USB hub cable from the source device to the monitor.
7 USB connectors	Connects USB devices to the monitor.

Front bezel controls

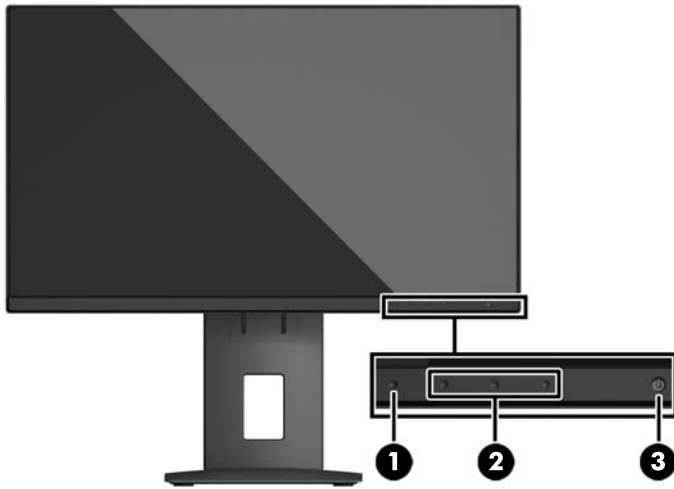

Control	Function
1	Menu button Opens and closes the OSD menu. NOTE: To activate the Menu button and the Function buttons, press any of the buttons so that the button labels appear on the screen.
2	Function buttons Use these buttons to navigate through the OSD menu based on the indicators next to the buttons that are activated while the OSD menu is open. NOTE: You can reconfigure the Function buttons in the OSD menu to quickly select the most commonly used operations. See Assigning the Function buttons on page 18 for more information.
3	Power button Turns the monitor on or off.

 **NOTE:** To view an OSD menu simulator, visit the HP Customer Self Repair Services Media Library at <http://www.hp.com/go/sml>.

Setting up the monitor

Installing the monitor stand

⚠ CAUTION: Do not touch the surface of the LCD panel. Pressure on the panel may cause non-uniformity of color or disorientation of the liquid crystals. If this occurs, the screen will not recover to its normal condition.

1. Lay the display head face down on a flat surface covered by a clean, dry cloth.
2. Slide the top of the mounting plate **(1)** on the stand under the upper lip of the recess in the back of the panel.
3. Lower the bottom of the stand's mounting plate **(2)** into the recess until it snaps into place.
4. The latch **(3)** pops up when the stand is locked in place.



Connecting the cables

 **NOTE:** The monitor ships with select cables. Not all cables shown in this section are included with the monitor.

1. Place the monitor in a convenient, well-ventilated location near the computer.
2. Before connecting the cables, route the cables through the cable routing hole in the center of the stand.

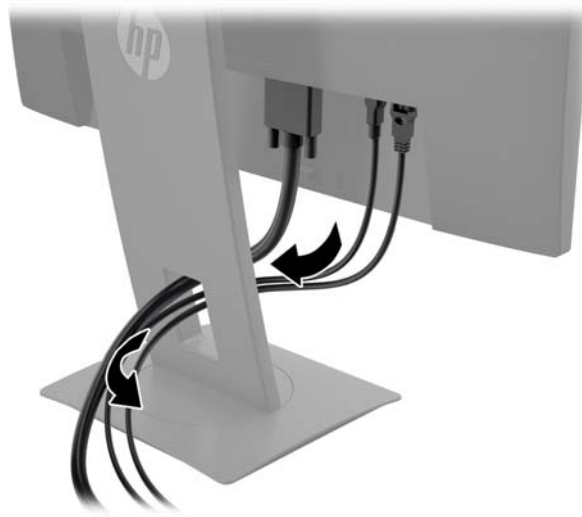

3. Connect a video cable.

 **NOTE:** The monitor will automatically determine which inputs have valid video signals. The inputs can be selected by pressing the Menu button to access the On-Screen Display (OSD) menu and selecting **Input Control**.

- Connect a VGA cable to the VGA connector on the rear of the monitor and the other end to the VGA connector on the source device.

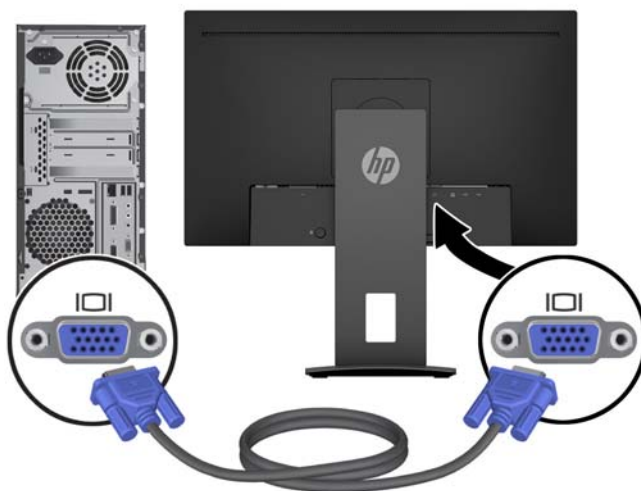

- Connect a DisplayPort cable to the DisplayPort connector on the rear of the monitor and the other end to the DisplayPort connector on the source device.

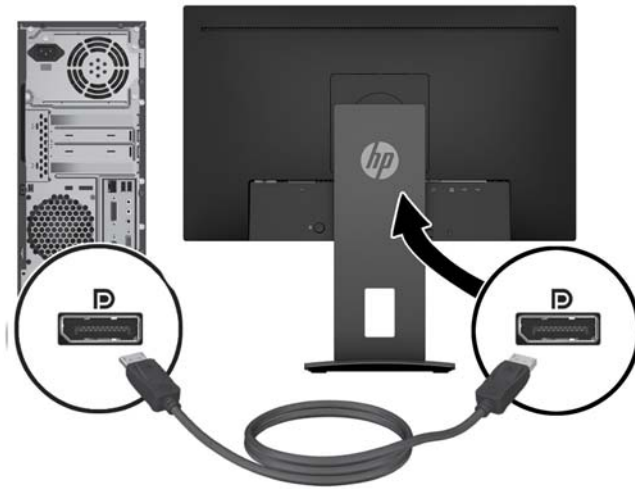

- Connect an HDMI cable to the HDMI connector on the rear of the monitor and the other end to the HDMI connector on the source device.

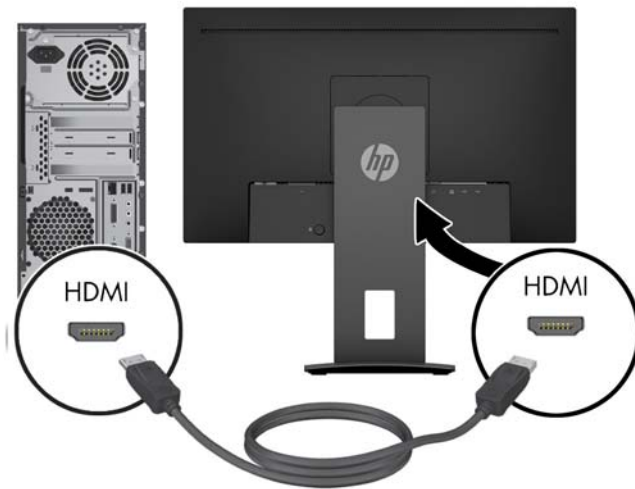

4. Connect the Type B connector of the USB upstream cable to the USB upstream port on the rear of the monitor. Then connect the cable's Type A connector to the USB downstream port on the source device.

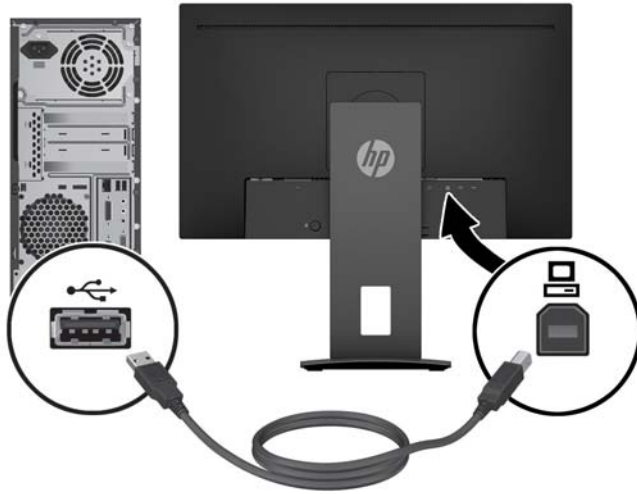

5. Connect one end of the AC power cord to the power connector on the rear of the monitor, and the other end to an AC outlet.

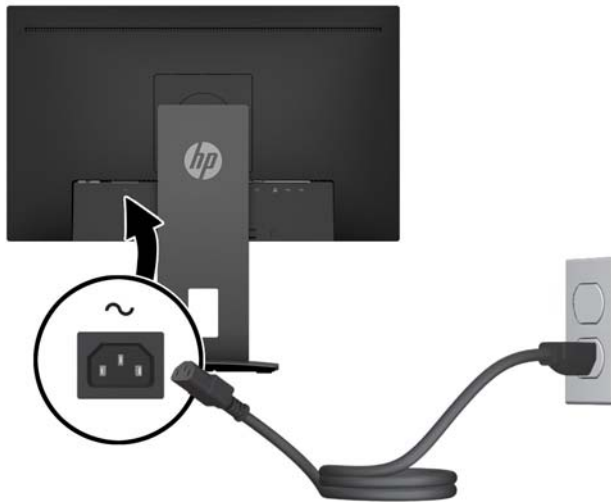

⚠ WARNING! To reduce the risk of electric shock or damage to the equipment:

Do not disable the power cord grounding plug. The grounding plug is an important safety feature.

Plug the power cord into a grounded (earthed) AC outlet that is easily accessible at all times.

Disconnect power from the equipment by unplugging the power cord from the AC outlet.

For your safety, do not place anything on power cords or cables. Arrange them so that no one may accidentally step on or trip over them. Do not pull on a cord or cable. When unplugging the power cord from the AC outlet, grasp the cord by the plug.

Adjusting the monitor

1. Tilt the display head forward or backward to set it to a comfortable eye level.

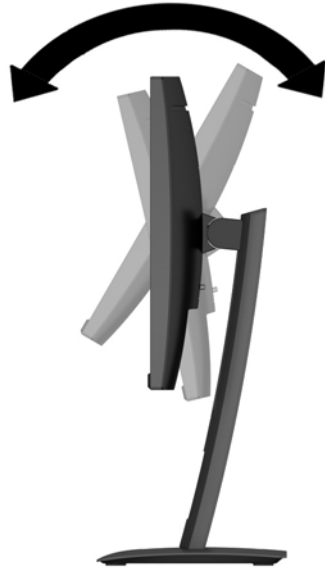

2. Swivel the display head to the left or right for the best viewing angle.

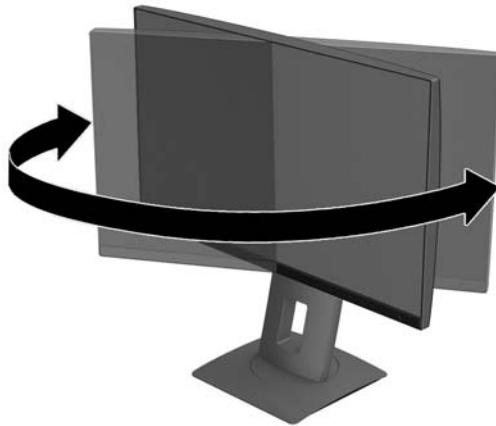

3. Adjust the monitor's height to a comfortable position for your individual workstation. The monitor's top bezel edge should not exceed a height that is parallel to your eye height. A monitor that is positioned low and reclined may be more comfortable for users with corrective lenses. The monitor should be repositioned as you adjust your working posture throughout the work day.



4. You can pivot the display head from landscape to portrait orientation viewing to adapt to your application.
 - a. Adjust the monitor to full height position and tilt the display head back to full tilt position **(1)**.
 - b. Pivot the display head clockwise/counterclockwise 90° from landscape to portrait orientation **(2)**.

CAUTION: If the monitor is not in full-height and full-tilt position when pivoting, the bottom right corner of the display head will come in contact with the base and potentially cause damage to the monitor.

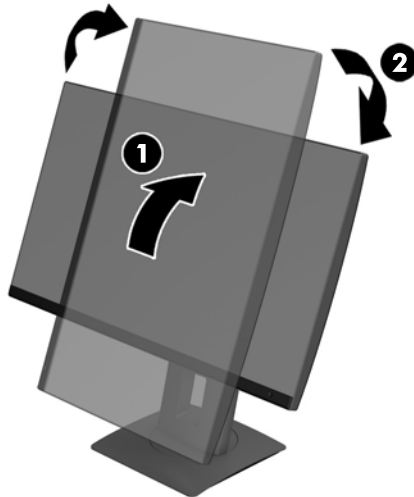

NOTE: To view information on the screen in portrait mode, you can install the HP Display Assistant software included on the software and documentation optical disc. The position of the OSD menu can also be rotated to portrait mode. To rotate the OSD menu, access the OSD menu by pressing the Menu button on the front bezel, select **OSD Control** from the menu, and then select **OSD Rotation**.

Turning on the monitor

1. Set the master power switch on the rear of the monitor to the On position.
2. Press the Power button on the computer to turn it on.
3. Press the Power button on the front of the monitor to turn it on.



CAUTION: Burn-in image damage may occur on monitors that display the same static image on the screen for 12 or more consecutive hours of nonuse. To avoid burn-in image damage on the monitor screen, you should always activate a screen saver application or turn off the monitor when it is not in use for a prolonged period of time. Image retention is a condition that may occur on all LCD screens. Monitors with a “burned-in image” are not covered under the HP warranty.

NOTE: If pressing the Power button has no effect, the Power Button Lockout feature may be enabled. To disable this feature, press and hold the monitor Power button for 10 seconds.

NOTE: You can disable the power LED in the OSD menu. Press the Menu button on the front of the monitor, and then select **Power Control > Power LED > Off**.

When the monitor is powered on, a Monitor Status message is displayed for five seconds. The message shows which input is the current active signal, the status of the auto-switch source setting (On or Off; default setting is On), the current preset screen resolution, and the recommended preset screen resolution.

The monitor automatically scans the signal inputs for an active input and uses that input for the screen.

HP watermark and image retention policy

The IPS monitor models are designed with IPS (In-Plane Switching) display technology which provides ultra-wide viewing angles and advanced image quality. IPS monitors are suitable for a wide variety of advanced image quality applications. This panel technology, however, is not suitable for applications that exhibit static, stationary or fixed images for long periods of time without the use of screen savers. These types of applications may include camera surveillance, video games, marketing logos, and templates that are displayed on the screen for a prolonged period of time. Static images may cause image retention damage that could look like stains or watermarks on the monitor's screen.

Monitors in use for 24 hours per day that result in image retention damage are not covered under the HP warranty. To avoid image retention damage, always turn off the monitor when it is not in use or use the power management setting, if supported on your system, to turn off the display when the system is idle.

Removing the monitor stand

You can remove the display head from the stand to install the display head on a wall, a swing arm, or other mounting fixture.

CAUTION: Before beginning to disassemble the monitor, be sure that the monitor is turned off and all cables are disconnected.

1. Disconnect and remove all cables from the monitor.
2. Lay the monitor face down on a flat surface covered by a clean, dry cloth.
3. Push up on the latch near the bottom center of the monitor **(1)**.
4. Swing the bottom of the stand up until the mounting plate clears the recess in the panel **(2)**.
5. Slide the stand out of the recess **(3)**.

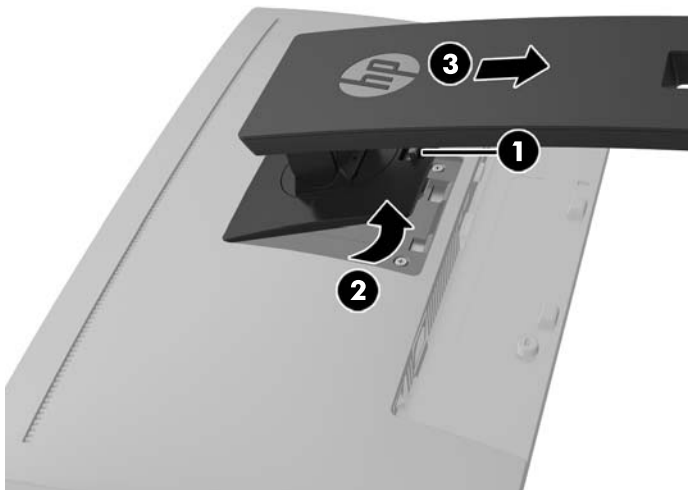

Mounting the display head

The display head can be attached to a wall, swing arm, or other mounting fixture.

NOTE: This apparatus is intended to be supported by a UL or CSA Listed wall-mount bracket.

If the monitor is TCO certified, the power cord plugged into the display head must be a shielded power cable. The use of a shielded power cable meets the TCO Certified criteria for display products. For information on TCO requirements, go to www.tcodevelopment.com.

CAUTION: This monitor supports the VESA industry standard 100 mm mounting holes. To attach a third-party mounting solution to the display head, four 4 mm, 0.7 pitch, and 10 mm long screws are required. Longer screws must not be used because they may damage the display head. It is important to verify that the manufacturer's mounting solution is compliant with the VESA standard and is rated to support the weight of the display head. For best performance, it is important to use the power and video cables provided with the monitor.

1. Remove the display head from the stand. [Removing the monitor stand on page 12.](#)

2. Remove the four screws from the VESA holes located on the rear of the display head.

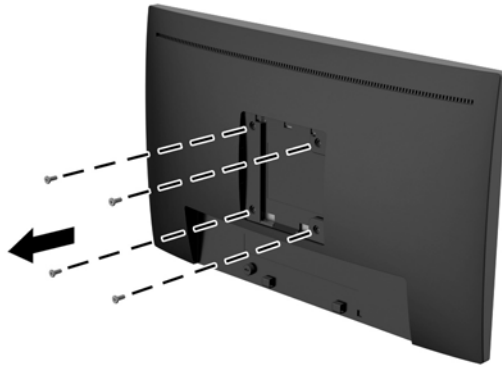

3. Install the mounting plate to the wall or swing arm of your choice using the four screws that were removed from the VESA holes on the rear of the display head.

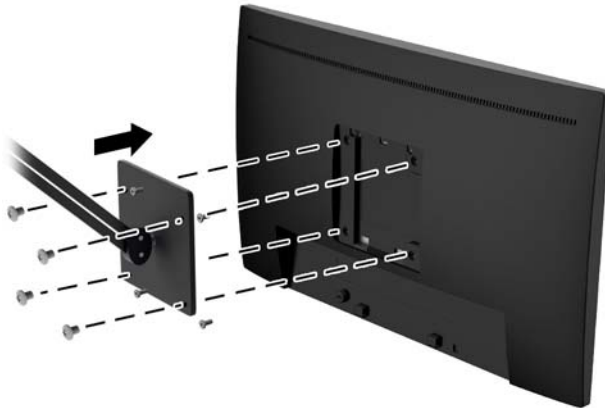

Installing a security cable

You can secure the monitor to a fixed object with an optional cable lock available from HP.

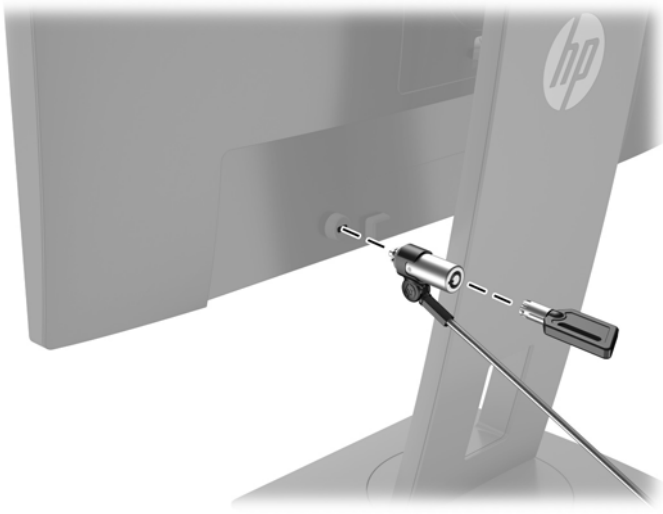

2 Using the monitor

Software and utilities

The optical disc that comes with the monitor contains files you can install on the computer:

- an .INF (Information) file
- .ICM (Image Color Matching) files (one for each calibrated color space)

The Information file

The .INF file defines monitor resources used by Microsoft Windows operating systems to ensure monitor compatibility with the computer's graphics adapter.

This monitor is Microsoft Windows Plug and Play-compatible and the monitor will work correctly without installing the .INF file. Monitor Plug and Play compatibility requires that the computer's graphic card is VESA DDC2-compliant and that the monitor connects directly to the graphics card. Plug and Play does not work through separate BNC type connectors or through distribution buffers/boxes.

The Image Color Matching file

The .ICM files are data files that are used in conjunction with graphics programs to provide consistent color matching from monitor screen to printer, or from scanner to monitor screen. This file is activated from within graphics programs that support this feature.



NOTE: The ICM color profile is written in accordance with the International Color Consortium (ICC) Profile Format specification.

Installing the .INF and .ICM files

After you determine that you need to update, you can install the .INF and .ICM files from the optical disc or download them.

Installing from the optical disc

To install the .INF and .ICM files on the computer from the optical disc:

1. Insert the optical disc in the computer optical drive. The optical disc menu is displayed.
2. View the **HP Monitor Software Information** file.
3. Select **Install Monitor Driver Software**.
4. Follow the on-screen instructions.
5. Ensure that the proper resolution and refresh rates appear in the Windows Display control panel.



NOTE: You may need to install the digitally signed monitor .INF and .ICM files manually from the optical disc in the event of an installation error. Refer to the HP Monitor Software Information file on the optical disc.

Downloading from the Web

If you do not have a computer or source device with an optical drive, you can download the latest version of .INF and .ICM files from the HP monitors support Web site.

1. Go to <http://www.hp.com/support> and select the appropriate country and language.
2. Select **Drivers & Downloads**, type your monitor model in the **Find my product** search field, and click **Go**.
3. If necessary, select your monitor from the list.
4. Select your operating system, and then click **Next**.
5. Click **Driver - Display/Monitor** to open the list of drivers.
6. Click on the driver.
7. Click the **System Requirements** tab, and then verify that your system meets the program minimum requirements.
8. Click **Download** and follow the on-screen instructions to download the software.

Using the On-Screen Display (OSD) menu

Use the On-Screen Display (OSD) menu to adjust the monitor screen image based on your preferences. You can access and make adjustments in the OSD menu using the buttons on the monitor's front bezel.

To access the OSD menu and make adjustments, do the following:

1. If the monitor is not already on, press the Power button to turn on the monitor.
2. To access the OSD menu, press one of the four front bezel buttons to activate the buttons, and then press the Menu button to open the OSD.
3. Use the three Function buttons to navigate, select, and adjust the menu choices. The button labels are variable depending on the menu or submenu that is active.

The following table lists the menu selections in the OSD menu.

Main Menu	Description
Brightness	Adjusts the brightness level of the screen.
Contrast	Adjusts the screen contrast.
Color Control	Selects and adjusts the screen color.
Input Control	Selects the video input signal.
Image Control	Adjusts the screen image.
Power Control	Adjusts the power settings.
Menu Control	Adjusts the on-screen display (OSD) and Function button controls.
Management	Enables/disables DDC/CI support and returns all OSD menu settings to the factory default settings.
Language	Selects the language in which the OSD menu is displayed. The factory default is English.
Information	Displays important information about the monitor.
Exit	Exits the OSD menu screen.

Assigning the Function buttons

Pressing one of the four front bezel buttons activates the buttons and displays the icons above the buttons. The factory default button icons and functions are shown below.

The following are the default button icons and functions for a VGA (analog) active input.

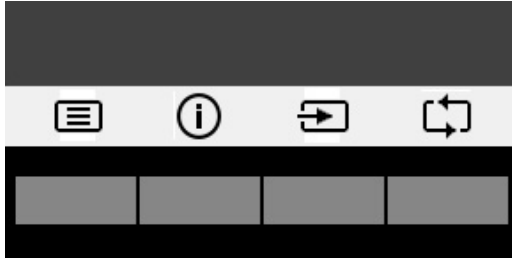

Button	Function
1 Menu	Opens the OSD (On-Screen Display) menu.
2 Information (Function button 1 - assignable)	Opens the Information menu.
3 Next Active Input (Function button 2 - assignable)	Switches the monitor's input source to the next active input.
4 Auto-Adjustment (Function button 3 - assignable)	Performs the Auto-Adjustment function.

The following are the default button icons and functions for digital active inputs.



Button	Function
1 Menu	Opens the OSD (On-Screen Display) menu.
2 Information (Function button 1 - assignable)	Opens the Information menu.
3 Next Active Input (Function button 2 - assignable)	Switches the monitor's input source to the next active input.
4 Brightness	Opens the Brightness adjustment scale.

Button	Function
(Function button 3 - assignable)	

You can change the Function buttons from their default values so that when the buttons are activated you can quickly access commonly used menu items.

To assign the Function buttons:

1. Press one of the four front bezel buttons to activate the buttons, and then press the Menu button to open the OSD.
2. In the OSD menu, select **Menu Control > Assign Buttons** and then select one of the available options for the button you want to assign.



NOTE: You can only assign the three Function buttons. You can not reassign the Menu button or the Power button.

Using Auto-Sleep Mode

The monitor supports an OSD (On-Screen Display) menu option called **Auto-Sleep Mode** that allows you to enable or disable a reduced power state for the monitor. When Auto-Sleep Mode is enabled (enabled by default), the monitor will enter a reduced power state when the host PC signals low power mode (absence of either horizontal or vertical sync signal).

Upon entering this reduced power state (sleep mode), the monitor screen is blanked, the backlight is turned off and the power LED indicator turns amber. The monitor draws less than 0.5 W of power when in this reduced power state. The monitor will wake from the sleep mode when the host PC sends an active signal to the monitor (for example, if you activate the mouse or keyboard).

You can disable Auto-Sleep Mode in the OSD. Press one of the four front bezel buttons to activate the buttons, and then press the Menu button to open the OSD. In the OSD menu select **Power Control > Auto-Sleep Mode > Off**.

3 Support and troubleshooting

Solving common problems

The following table lists possible problems, the possible cause of each problem, and the recommended solutions.

Problem	Possible Cause	Solution
Screen is blank or video is flashing.	Power cord is disconnected.	Connect the power cord.
	Power button is turned off.	Press the front bezel Power button. NOTE: If pressing the Power button has no effect, press and hold the Power button for 10 seconds to disable the Power button lockout feature.
	Master power switch is turned off.	Set the master power switch on the rear of the monitor to the On position.
	Video cable is improperly connected.	Connect the video cable properly. See Connecting the cables on page 6 for more information.
Image appears blurred, indistinct, or too dark.	System is in sleep mode.	Press any key on the keyboard or move the mouse to exit sleep mode.
	Video card is incompatible.	Open the OSD menu and select the Input Control menu. Set Auto-Switch Input to Off and manually select the input.
Input Signal Not Found is displayed on screen.	Brightness is too low.	Open the OSD menu and select Brightness to adjust the brightness scale as needed.
	Monitor video cable is disconnected.	Connect the appropriate video signal cable between the computer and monitor. Be sure that the computer power is off while you connect the video cable.
Input Signal Out of Range is displayed on screen.	No video signal.	Be sure the computer has sent out a video signal.
	Video resolution and/or refresh rate are set higher than what the monitor supports.	Change the settings to a supported setting. See Preset display resolutions on page 28 for more information.
The monitor is off but it did not seem to enter into sleep mode.	The monitor's power saving control is disabled.	Open the OSD menu and select Power Control > Auto-Sleep Mode and set auto-sleep to On .
OSD Lockout is displayed.	The monitor's OSD Lockout function is enabled.	Press and hold the Menu button on the front bezel for 10 seconds to disable the OSD Lockout function.
Power Button Lockout is displayed.	The monitor's Power Button Lockout function is enabled.	Press and hold the Power button for 10 seconds to disable the Power Button Lockout function.

Using the auto-adjustment function (analog input)

When you first set up the monitor, conduct a Factory Reset of the computer, or change the resolution of the monitor, the Auto-Adjustment feature automatically engages, and attempts to optimize your screen for you.

You may also optimize the screen performance for the VGA (analog) input at any time by using the auto-adjustment button on the monitor and the auto-adjustment pattern software utility on the optical disc provided (select models only).

Do not use this procedure if the monitor is using an input other than VGA. If the monitor is using a VGA (analog) input, this procedure can correct the following image quality conditions:

- Fuzzy or unclear focus
- Ghosting, streaking or shadowing effects
- Faint vertical bars
- Thin, horizontal scrolling lines
- An off-center picture

To use the auto-adjustment feature:

1. Allow the monitor to warm up for 20 minutes before adjusting.
2. Press the auto-adjustment button on the monitor front bezel.
 - You can also press the Menu button, and then select **Image Control > Auto-Adjustment** from the OSD menu.
 - If the result is not satisfactory, continue with the procedure.
3. Insert the optical disc into the optical drive. The optical disc menu is displayed.
4. Select **Open Auto-Adjustment Utility**. The setup test pattern is displayed.
5. Press the auto button on the monitor front bezel to produce a stable, centered image.
6. Press the **ESC** key or any other key on the keyboard to exit the test pattern.

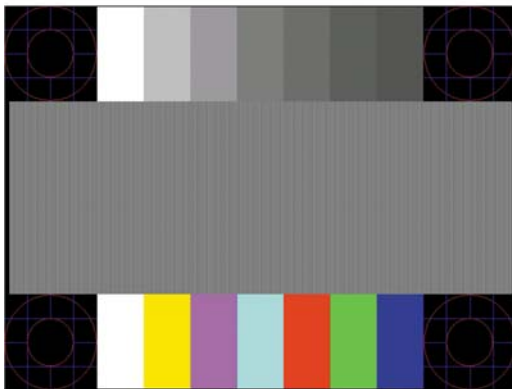

NOTE: The auto-adjustment test pattern utility can be downloaded from <http://www.hp.com/support>.

Optimizing image performance (analog input)

Two controls in the on-screen display can be adjusted to improve image performance: Clock and Phase (available in the OSD menu).

 **NOTE:** The Clock and Phase controls are adjustable only when using an analog (VGA) input. These controls are not adjustable for digital inputs.

The Clock must first be set correctly since the Phase settings are dependent on the main Clock setting. Use these controls only when the auto-adjustment function does not provide a satisfactory image.

- **Clock**—Increases/decreases the value to minimize any vertical bars or stripes visible on the screen background.
- **Phase**—Increases/decreases the value to minimize video flickering or blurring.

 **NOTE:** When using the controls, you will obtain the best results by using the auto-adjustment pattern software utility provided on the optical disc.

When adjusting the Clock and Phase values, if the monitor images become distorted, continue adjusting the values until the distortion disappears. To restore the factory settings, select **Yes** from the **Factory Reset** menu in the on-screen display.

To eliminate vertical bars (Clock):

1. Press the Menu button on the monitor front bezel to open the OSD menu, and then select **Image Control > Clock and Phase**.
2. Use the Function buttons on the monitor front bezel that display up and down arrow icons to eliminate vertical bars. Press the buttons slowly so that you do not miss the optimum adjustment point.



3. After adjusting the Clock, if blurring, flickering, or bars appear on the screen, proceed to adjust the Phase.

To remove flickering or blurring (Phase):

1. Press the Menu button on the monitor front bezel to open the OSD menu, and then select **Image Control > Clock and Phase**.
2. Press the Function buttons on the monitor front bezel that display up and down arrow icons to eliminate flickering or blurring. Flickering or blurring may not be eliminated, depending on the computer or graphics controller card installed.



To correct screen position (Horizontal Position or Vertical Position):

1. Press the Menu button on the monitor's front bezel to open the OSD menu, and then select **Image Position**.

2. Press the Function buttons on the monitor front bezel that display up and down arrow icons to properly adjust the position of the image in the display area of the monitor. The Horizontal Position shifts the image left or right; the Vertical Position shifts the image up and down.

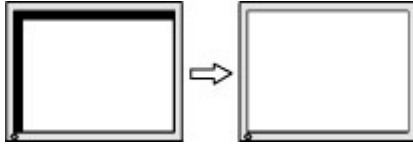

Button lockouts

Holding down the Power button or Menu button for ten seconds will lock out the functionality of that button. You can restore the functionality by holding the button down again for ten seconds. This functionality is only available when the monitor is powered on, displaying an active signal, and the OSD is not active.

Product support

For additional information on using your monitor, go to <http://www.hp.com/support>. Select your country or region, select **Troubleshooting**, and then enter your model in the search window and click the **Go** button.

 **NOTE:** The monitor user guide, reference material, and drivers are available at <http://www.hp.com/support>.

If the information provided in the guide does not address your questions, you can contact support. For U.S. support, go to <http://www.hp.com/go/contactHP>. For worldwide support, go to http://welcome.hp.com/country/us/en/wwcontact_us.html.

Here you can:

- Chat online with an HP technician

 **NOTE:** When support chat is not available in a particular language, it is available in English.

- Find support telephone numbers
- Locate an HP service center

Preparing to call technical support

If you cannot solve a problem using the troubleshooting tips in this section, you may need to call technical support. Have the following information available when you call:

- Monitor model number
- Monitor serial number
- Purchase date on invoice
- Conditions under which the problem occurred
- Error messages received
- Hardware configuration
- Name and version of the hardware and software you are using

Locating the serial number and product number

The serial number and product number are located on a label on the rear of the display head. You may need these numbers when contacting HP about the monitor model.



NOTE: You may need to partially pivot the display head to read the label.



4 Maintaining the monitor

Maintenance guidelines

- Do not open the monitor cabinet or attempt to service this product yourself. Adjust only those controls that are covered in the operating instructions. If the monitor is not operating properly or has been dropped or damaged, contact an authorized HP dealer, reseller, or service provider.
- Use only a power source and connection appropriate for this monitor, as indicated on the label/back plate of the monitor.
- Turn the monitor off when not in use. You can substantially increase the life expectancy of the monitor by using a screen saver program and turning off the monitor when not in use.



NOTE: Monitors with a “burned-in image” are not covered under the HP warranty.

- Slots and openings in the cabinet are provided for ventilation. These openings must not be blocked or covered. Never push objects of any kind into cabinet slots or other openings.
- Keep the monitor in a well-ventilated area, away from excessive light, heat, or moisture.
- When removing the monitor stand, you must lay the monitor facedown on a soft area to prevent it from getting scratched, defaced, or broken.

Cleaning the monitor

1. Turn off the monitor and disconnect power from the computer by unplugging the power cord from the AC outlet.
2. Dust the monitor by wiping the screen and the cabinet with a soft, clean antistatic cloth.
3. For more difficult cleaning situations, use a 50/50 mix of water and isopropyl alcohol.

CAUTION: Spray the cleaner onto a cloth and use the damp cloth to gently wipe the screen surface. Never spray the cleaner directly on the screen surface. It may run behind the bezel and damage the electronics.

CAUTION: Do not use cleaners that contain any petroleum-based materials such as benzene, thinner, or any volatile substance to clean the monitor screen or cabinet. These chemicals may damage the monitor.

Shipping the monitor

Keep the original packing box in a storage area. You may need it later if you move or ship the monitor.

A Technical specifications



NOTE: The product specifications provided in the user guide might have changed between the time of manufacturing and delivery of your product.

For the latest specifications or additional specifications on this product, go to [http://www.hp.com/go/quickspecs/](http://www.hp.com/go/quickspecs) and search for your specific monitor model to find the model-specific QuickSpecs.

54.61 cm/21.5-inch model

Display	54.61 cm wide screen	21.5-inch wide screen
Type	IPS LCD	
Viewable Image Size	54.61 cm diagonal	21.5-inch diagonal
Maximum Weight (Unpacked)	4.75 kg	10.47 lbs
Dimensions (include base)		
Height (highest position)	47.74 cm	18.8 inches
Height (lowest position)	31.88 cm	12.55 inches
Depth	18.9 cm	7.44 inches
Width	48.81 cm	19.23 inches
Maximum Graphic Resolution	1920 x 1080	
Optimum Graphic Resolution	1920 x 1080	
Environmental Requirements Temperature		
Operating Temperature	5 to 35° C	41 to 95° F
Storage Temperature	-20 to 60° C	-4 to 140° F
Power Source	100–240 VAC 50/60 Hz	
Input Terminal	One HDMI connector, one DisplayPort connector, one VGA connector	

58 cm/23-inch model

Display	58 cm wide screen	23-inch wide screen
Type	IPS LCD	
Viewable Image Size	58 cm diagonal	23-inch diagonal
Maximum Weight (Unpacked)	5.0 kg	11.02 lbs
Dimensions (include base)		
Height (highest position)	48.66 cm	19.16 inches
Height (lowest position)	32.8 cm	12.92 inches
Depth	18.9 cm	7.44 inches
Width	52.08 cm	20.5 inches
Maximum Graphic Resolution	1920 x 1080	
Optimum Graphic Resolution	1920 x 1080	
Environmental Requirements Temperature		
Operating Temperature	5 to 35° C	41 to 95° F
Storage Temperature	-20 to 60° C	-4 to 140° F
Power Source	100–240 VAC 50/60 Hz	
Input Terminal	One HDMI connector, one DisplayPort connector, one VGA connector	

Preset display resolutions

The display resolutions listed below are the most commonly used modes and are set as factory defaults. The monitor automatically recognizes these preset modes and they will appear properly sized and centered on the screen.

54.61 cm/21.5-inch and 58 cm/23-inch models

Preset	Pixel Format	Horz Freq (kHz)	Vert Freq (Hz)
1	640 × 480	31.469	59.940
2	800 × 600	37.879	60.317
3	1024 × 768	48.363	60.004
4	1280 × 720	45.000	60.000
5	1280 × 800	49.702	59.810
6	1280 × 1024	63.981	60.020
7	1440 × 900	55.935	59.887
8	1600 × 900	60.000	60.000
9	1680 × 1050	65.290	59.954
10	1920 × 1080	67.500	60.000

Entering user modes

The video controller signal may occasionally call for a mode that is not preset if:

- You are not using a standard graphics adapter.
- You are not using a preset mode.

If this occurs, you may need to readjust the parameters of the monitor screen by using the on-screen display. Your changes can be made to any or all of these modes and saved in memory. The monitor automatically stores the new setting, and then recognizes the new mode just as it does a preset mode. In addition to the factory preset modes, there are at least 10 user modes that can be entered and stored.

Energy saver feature

The monitors support a reduced power state. The reduced power state will be entered into if the monitor detects the absence of either the horizontal sync signal or the vertical sync signal. Upon detecting the absence of these signals, the monitor screen is blanked, the backlight is turned off, and the power light is turned amber. When the monitor is in the reduced power state, the monitor will utilize 0.5 watts of power. There is a brief warm-up period before the monitor will return to its normal operating mode.

Refer to the computer manual for instructions on setting energy saver features (sometimes called power management features).



NOTE: The above power saver feature only works when the monitor is connected to a computer that has energy saver features.

By selecting the settings in the monitor's Energy Saver utility, you can also program the monitor to enter into the reduced power state at a predetermined time. When the monitor's Energy Saver utility causes the monitor to enter the reduced power state, the power light blinks amber.

B Accessibility

HP designs, produces, and markets products and services that can be used by everyone, including people with disabilities, either on a stand-alone basis or with appropriate assistive devices.

Supported assistive technologies

HP products support a wide variety of operating system assistive technologies and can be configured to work with additional assistive technologies. Use the Search feature on your source device that is connected to the monitor to locate more information about assistive features.



NOTE: For additional information about a particular assistive technology product, contact customer support for that product.

Contacting support

We are constantly refining the accessibility of our products and services and welcome feedback from users. If you have an issue with a product or would like to tell us about accessibility features that have helped you, please contact us at (888) 259-5707, Monday through Friday, 6 a.m. to 9 p.m. Mountain Time. If you are deaf or hard-of-hearing and use TRS/VRS/WebCapTel, contact us if you require technical support or have accessibility questions by calling (877) 656-7058, Monday through Friday, 6 a.m. to 9 p.m. Mountain Time.