

**SAMSUNG**

# User guide

HW-B630F

Thank you for purchasing this Samsung product.

To receive more complete service, please register your product at [www.samsung.com](http://www.samsung.com)

# SAFETY INFORMATION

- The following also applies to the Subwoofer (PS-WF75B).

## SAFETY WARNINGS

TO REDUCE THE RISK OF ELECTRIC SHOCK, DO NOT REMOVE THE COVER (OR BACK).

NO USER-SERVICEABLE PARTS ARE INSIDE.

REFER SERVICING TO QUALIFIED SERVICE PERSONNEL.

Refer to the table below for an explanation of symbols which may be on your Samsung product.

	<b>CAUTION</b> <b>RISK OF ELECTRIC SHOCK.</b> <b>DO NOT OPEN.</b>	
	This symbol indicates that high voltage is present inside. It is dangerous to make any kind of contact with any internal part of this product.	
	This symbol indicates that this product has included important literature concerning operation and maintenance.	
	Class II product : This symbol indicates that a safety connection to electrical earth (ground) is not required. If this symbol is not present on a product with a power cord, the product MUST have a reliable connection to protective earth (ground).	
	AC voltage : Rated voltage marked with this symbol is AC voltage.	
	DC voltage : Rated voltage marked with this symbol is DC voltage.	
	Caution. Consult Instructions for use : This symbol instructs the user to consult the user manual for further safety related information.	

## WARNING

- To reduce the risk of fire or electric shock, do not expose this appliance to rain or moisture.
- To prevent injury, this apparatus must be securely attached to the floor/wall in accordance with the installation instructions.
- This product contains chemicals known to the State of California to cause cancer and birth defects or other reproductive harm.

## CAUTION

- Do not expose this apparatus to dripping or splashing. Do not put objects filled with liquids, such as vases, on the apparatus.
- To turn this apparatus off completely, you must pull the power plug out of the wall socket. Consequently, the power plug must be easily and readily accessible at all times.

## FCC NOTE (for U.S.A):

### **FCC Supplier's Declaration of Conformity**

#### **Responsible Party - U.S. Contact Information:**

Samsung Electronics America, Inc.  
700 Sylvan Avenue, Englewood Cliffs, NJ 07632  
Phone: 1-800-SAMSUNG (726-7864)

### **FCC Compliance Statement :**

This device complies with Part 15 of the FCC Rules. Operation is subject to the following two conditions:

(1) This device may not cause harmful interference, and (2) this device must accept any interference received, including interference that may cause undesired operation.

### **FCC Caution :**

- Any changes or modifications not expressly approved by the party responsible for compliance could void the user's authority to operate this equipment.

- This product satisfies FCC regulations when shielded cables and connectors are used to connect the unit to other equipment. To prevent electromagnetic interference with electric appliances, such as radios and televisions, use shielded cables and connectors for connections.

### **Class B FCC Statement**

This equipment has been tested and found to comply with the limits for a Class B digital device, pursuant to Part 15 of the FCC Rules. These limits are designed to provide reasonable protection against harmful interference in a residential installation. This equipment generates, uses and can radiate radio frequency energy and, if not installed and used in accordance with the instructions, may cause harmful interference to radio communications. However, there is no guarantee that interference will not occur in a particular installation. If this equipment does cause harmful interference to radio or television reception, which can be determined by turning the equipment off and on, the user is encouraged to try to correct the interference by one of the following measures:

- Reorienting or relocating the receiving antenna.
- Increasing the separation between the equipment and receiver.
- Connecting the equipment to an outlet that is on a different circuit than the radio or TV.
- Consulting the dealer or an experienced radio/TV technician for help.

### **FCC Radiation Exposure Statement :**

This equipment complies with FCC radiation exposure limits set forth for an uncontrolled environment. This equipment should be installed and operated so there is at least 8 inches (20 cm) between the radiator and your body. This device and its antenna(s) must not be co-located or operated in conjunction with any other antenna or transmitter.

### **CALIFORNIA USA ONLY (Applicable for networking models only.)**

This Perchlorate warning applies only to primary CR(Manganese Dioxide) Lithium coin cells in the product sold or distributed ONLY in California USA "Perchlorate Material - special handling may apply, See [www.dtsc.ca.gov/hazardouswaste/perchlorate](http://www.dtsc.ca.gov/hazardouswaste/perchlorate)."

 **WARNING: Cancer and Reproductive Harm**  
- [www.P65warnings.ca.gov](http://www.P65warnings.ca.gov)

### **Samsung products and recycling**

- Dispose unwanted electronics through an approved recycler. To find the nearest recycling location, go to our website: [www.samsung.com/recycling](http://www.samsung.com/recycling) Or call, 1-800-SAMSUNG
- **WARNING!** Never dispose of batteries in a fire because they may explode. Do not disassemble, crush, puncture, heat, burn or reuse batteries. For more information, visit [call2recycle.org](http://call2recycle.org) or call 1-800-822-8837. Alternatively, visit: [www.samsung.com/recycling](http://www.samsung.com/recycling) or call 1-800-SAMSUNG.

### **Important Safety Instructions**

Read these operating instructions carefully before using the unit. Follow all the safety instructions listed below. Keep these operating instructions handy for future reference.

1. Read these instructions.
2. Keep these Instructions.
3. Heed all warnings.
4. Follow all instructions.
5. Do not use this apparatus near water.
6. Clean only with dry cloth.
7. Do not block any ventilation openings. Install in accordance with the manufacturer's instructions.

8. Do not install near any heat sources such as radiators, heat registers, stoves, or other apparatus (including amplifiers) that produce heat.
9. Do not hinder the safety purpose of the polarized or grounding-type plug.  
A polarized plug has two blades with one wider than the other. A grounding type plug has two blades and a third grounding prong. The wide blade or the third prong are provided for your safety. If the provided plug does not fit into your outlet, consult an electrician for replacement of the obsolete outlet.
10. Protect the power cord from being walked on or pinched particularly at plugs, convenience receptacles, and the point where they exit from the apparatus.
11. Only use attachments/accessories specified by the manufacturer.
12. Use only with the cart, stand, tripod, bracket, or table specified by the manufacturer, or sold with the apparatus.  
When a cart is used, use caution when moving the cart/apparatus combination to avoid injury from tip-over.
13. Unplug this apparatus during lightning storms or when unused for long periods of time.
14. Refer all servicing to qualified service personnel. Servicing is required when the apparatus has been damaged in any way, such as power-supply cord or plug is damaged, liquid has been spilled or objects have fallen into the apparatus, the apparatus has been exposed to rain or moisture, does not operate normally, or has been dropped.



## PRECAUTIONS

1. Ensure that the AC power supply in your house complies with the power requirements listed on the identification sticker located on the bottom of your product. Install your product horizontally, on a suitable base (furniture), with enough space around it for ventilation (3~4 inches). Make sure the ventilation slots are not covered. Do not place the unit on amplifiers or other equipment which may become hot. This unit is designed for continuous use. To fully turn off the unit, disconnect the AC plug from the wall outlet. Unplug the unit if you intend to leave it unused for a long period of time.
2. During thunderstorms, disconnect the AC plug from the wall outlet. Voltage peaks due to lightning could damage the unit.
3. Do not expose the unit to direct sunlight or other heat sources. This could lead to overheating and cause the unit to malfunction.
4. Protect the product from moisture (i.e. vases), and excess heat (e.g. a fireplace) or equipment creating strong magnetic or electric fields. Unplug the power cable from the AC wall socket if the unit malfunctions. Your product is not intended for industrial use. It is for personal use only. Condensation may occur if your product has been stored in cold temperatures. If transporting the unit during the winter, wait approximately 2 hours or until the unit has reached room temperature before using.
5. The battery used with this product contains chemicals that are harmful to the environment. Do not dispose of the battery in the general household trash. Do not expose the battery to excess heat, direct sunlight, or fire. Do not short circuit, disassemble, or overheat the battery.  
**CAUTION** : Danger of explosion if the battery is replaced incorrectly. Replace only with the same or equivalent type.

# CONTENTS

<b>01</b>	<b>Checking the Components</b>	<b>7</b>
<b>02</b>	<b>Product Overview</b>	<b>8</b>
	Front Panel / Top Panel of the Soundbar	8
	Bottom Panel of the Soundbar	9
<b>03</b>	<b>Using the Remote Control</b>	<b>10</b>
	Inserting Batteries before using the Remote Control (AAA batteries X 2)	10
	How to Use the Remote Control	10
	Using the Hidden Buttons (Buttons with more than one function)	14
	Output specifications for the different sound effect modes	14
	Adjusting the Soundbar volume with a TV remote control	15
<b>04</b>	<b>Connecting the Soundbar</b>	<b>16</b>
	Connecting Electrical Power	16
	Connecting the Samsung Wireless Rear Kit to your Soundbar	19
<b>05</b>	<b>Using a wired connection to the TV</b>	<b>20</b>
	Method 1. Connecting using an Optical Cable	20
	Method 2. Connecting a TV using an HDMI Cable	21
<b>06</b>	<b>Using a wireless connection to the TV</b>	<b>23</b>
	Connecting a TV via Bluetooth	23
<b>07</b>	<b>Connecting an External Device</b>	<b>25</b>
	Method 1. Connecting using an Optical Cable	25
	Method 2. Connecting using an HDMI Cable	26

<b>08</b>	<b>Connecting a USB Storage Device</b>	<b>27</b>
<b>09</b>	<b>Connecting a Mobile Device</b>	<b>28</b>
	Connecting via Bluetooth	28
<b>10</b>	<b>Installing the Wall Mount</b>	<b>32</b>
	Installation Precautions	32
	Wallmount Components	32
<b>11</b>	<b>Placing the Soundbar on a TV stand</b>	<b>34</b>
<b>12</b>	<b>Software Update</b>	<b>35</b>
	How to check the Firmware version	35
	Update Procedure	35
	If UPGR is not displayed	36
<b>13</b>	<b>Troubleshooting</b>	<b>37</b>
<b>14</b>	<b>License</b>	<b>39</b>
<b>15</b>	<b>Open Source License Notice</b>	<b>40</b>
<b>16</b>	<b>Important Notes About Service</b>	<b>40</b>
<b>17</b>	<b>Specifications and Guide</b>	<b>41</b>
	Specifications	41

# 01 CHECKING THE COMPONENTS

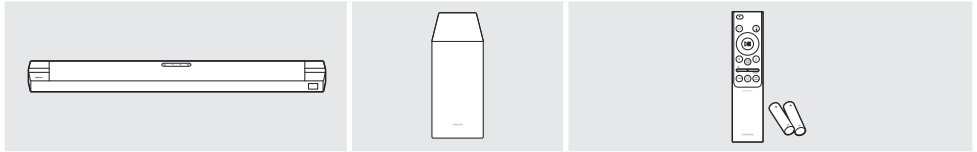

**Soundbar Main Unit**

**Subwoofer**

**Remote Control (AH81-15340A) / Batteries**

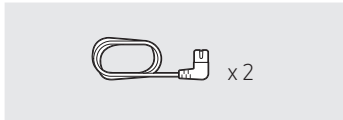

**Power Cord  
(Subwoofer, Soundbar)  
(AH81-17835A)**

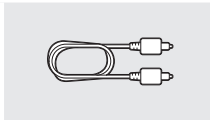

**Optical Cable  
(AH81-09790A)**

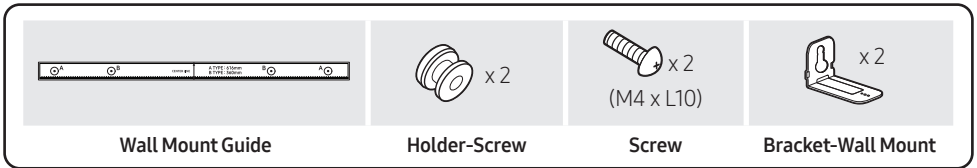

**Wall Mount Guide**

**Holder-Screw**

**Screw**

**Bracket-Wall Mount**

**(AH81-17927A)**

- For more information about the power supply and power consumption, refer to the label attached to the product. (Label: Bottom or back of the product.)
- To purchase additional components or optional cables, contact a Samsung Service Center or Samsung Customer Care.
- The appearance of the accessories may differ slightly from the illustrations above.
- Design and specifications are subject to change without prior notice.

# 02 PRODUCT OVERVIEW

## Front Panel / Top Panel of the Soundbar

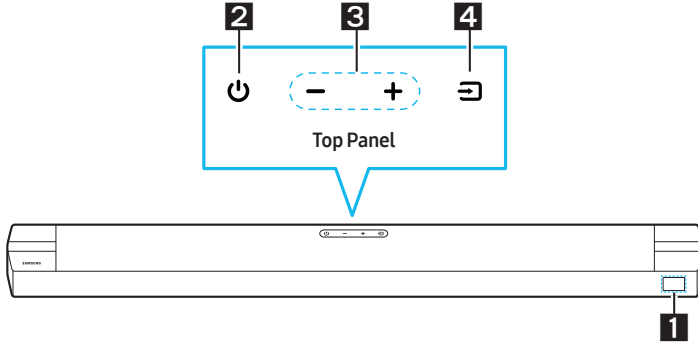

<b>1</b>	<p><b>Display</b> Displays the product's status and current mode.</p>												
<b>2</b>	<p><b>⏻ (Power) Button</b> Turns the power on and off.</p> <ul style="list-style-type: none"> <li>• <b>Auto Power Down Function</b> The unit turns off automatically in the following situations: <ul style="list-style-type: none"> <li>– In <b>TV ARC / HDMI / BT / USB / D.IN</b> Mode : If there is no audio signal for 18 minutes.</li> </ul> </li> </ul>												
<b>3</b>	<p><b>– + (Volume) Button</b> Adjusts the volume.</p> <ul style="list-style-type: none"> <li>• When adjusted, the volume level appears on the Soundbar's front display.</li> </ul>												
<b>4</b>	<p><b>📺 (Source) Button</b> Selects the source input mode.</p> <table border="1" style="width: 100%; border-collapse: collapse;"> <thead> <tr> <th style="text-align: center;">Input mode</th> <th style="text-align: center;">Display</th> </tr> </thead> <tbody> <tr> <td style="text-align: center;">ARC (HDMI OUT) input</td> <td style="text-align: center;">TV ARC</td> </tr> <tr> <td style="text-align: center;">HDMI input</td> <td style="text-align: center;">HDMI</td> </tr> <tr> <td style="text-align: center;">BLUETOOTH mode</td> <td style="text-align: center;">BT</td> </tr> <tr> <td style="text-align: center;">USB mode</td> <td style="text-align: center;">USB</td> </tr> <tr> <td style="text-align: center;">Optical Digital input</td> <td style="text-align: center;">D.IN</td> </tr> </tbody> </table> <ul style="list-style-type: none"> <li>• To turn on "<b>BT PAIRING</b>" mode, change the source to "<b>BT</b>" mode, and then press and hold the <b>📺 (Source)</b> button for more than 5 seconds.</li> </ul>	Input mode	Display	ARC (HDMI OUT) input	TV ARC	HDMI input	HDMI	BLUETOOTH mode	BT	USB mode	USB	Optical Digital input	D.IN
Input mode	Display												
ARC (HDMI OUT) input	TV ARC												
HDMI input	HDMI												
BLUETOOTH mode	BT												
USB mode	USB												
Optical Digital input	D.IN												

- When you plug in the Power cord, the power button will begin working in 4 to 6 seconds.
- When you turn on this unit, there will be a 4 to 5 second delay before it produces sound.
- If you want to enjoy sound only from the Soundbar, you must turn off the TV's speakers in the Audio Setup menu of your TV. Refer to the owner's manual supplied with your TV.

# Bottom Panel of the Soundbar

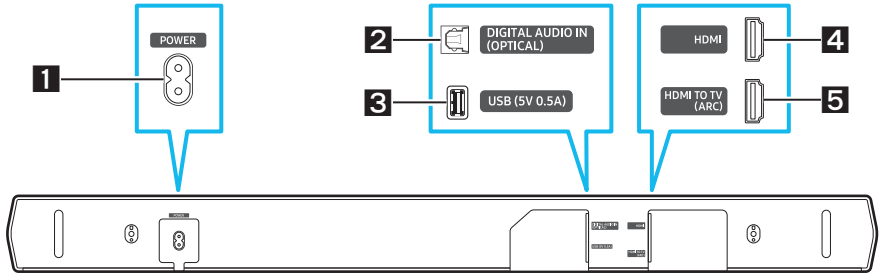

<b>1</b>	<b>POWER</b> Connect the Soundbar's power cord.
<b>2</b>	<b>DIGITAL AUDIO IN (OPTICAL)</b> Connect to the digital (optical) output of an external device.
<b>3</b>	<b>USB (5V 0.5A)</b> Connect a USB device here to play music files stored on the USB device through the Soundbar.
<b>4</b>	<b>HDMI</b> Inputs digital video and audio signals simultaneously using an HDMI cable (not supplied). Connect to the HDMI output of an external device.
<b>5</b>	<b>HDMI TO TV (ARC)</b> Connect to the HDMI (ARC) port on a TV.

- Do not connect this unit or other components to an AC outlet until all connections between components are complete.

# 03 USING THE REMOTE CONTROL



## Inserting Batteries before using the Remote Control (AAA batteries X 2)

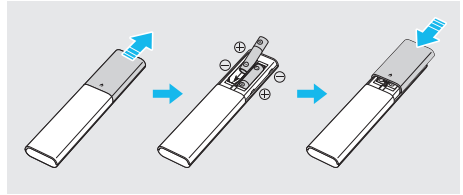

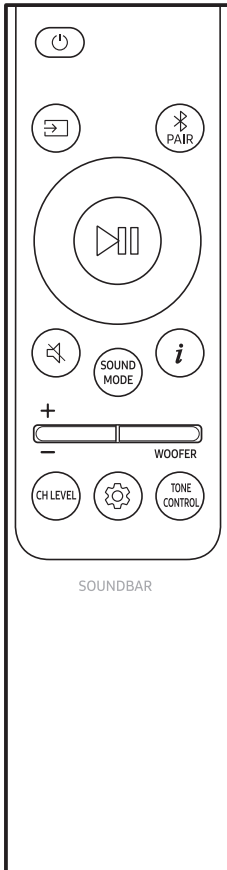

Slide the back cover in the direction of the arrow until it is completely removed.  
 Insert 2 AAA batteries (1.5V) so that their orientation is correct. Slide the back cover back into position.



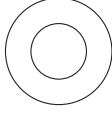
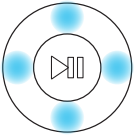





## How to Use the Remote Control

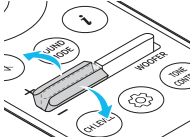
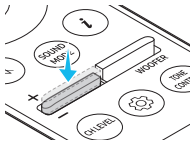

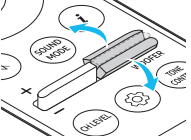
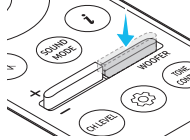
 <b>Power</b>	Turns the Soundbar on and off.
 <b>Source</b>	Press to select a source connected to the Soundbar.
 <b>Bluetooth PAIR</b>	Switch the Soundbar to Bluetooth pairing mode. Press the <b>PAIR</b> button and wait for the “ <b>BT PAIRING</b> ” screen to connect to a new Bluetooth device.
 <b>Up/Down/Left/Right</b>	<div style="display: flex; align-items: center;">  <div style="margin-left: 20px;"> <p><b>Press the indicated areas to select Up/Down/Left/Right.</b></p> <p>Press Up/Down/Left/Right on the button to select or set functions.</p> <ul style="list-style-type: none"> <li>• <b>Repeat</b>              To use the Repeat function in “<b>USB</b>” mode, press the <b>Up</b> button.</li> <li>• <b>Music Skip</b>              Press the <b>Right</b> button to select the next music file.              Press the <b>Left</b> button to select the previous music file.</li> <li>• <b>ID SET</b>              Press and hold the <b>Up</b> button for 5 seconds to complete <b>ID SET</b> (when connecting to a wireless Subwoofer or wireless Rear Speakers).</li> </ul> </div> </div>

 <p><b>Play / Pause</b></p>	<p>Press the <b>▶  </b> button to pause a music file temporarily. When you press the button again, the music file will resume playing.</p>
 <p><b>Mute</b></p>	<p>Press the <b>🔇 (Mute)</b> button to mute the sound. Press it again to unmute the sound.</p>
 <p><b>SOUND MODE</b></p>	<p>By pressing the button, you can select the desired sound mode.</p> <p><b>SURROUND SOUND → BASS BOOST → GAME → ADAPTIVE SOUND → DTS VIRTUAL:X → STANDARD</b></p> <ul style="list-style-type: none"> <li>– <b>SURROUND SOUND</b> Provides a wider sound field than standard.</li> <li>– <b>BASS BOOST</b> Sound field mode with emphasis on bass sound.</li> <li>– <b>GAME</b> Provides stereoscopic sound to immerse you in the action while gaming.</li> <li>– <b>ADAPTIVE SOUND</b> Analyzes the content in real time and automatically provides an optimal sound field based on the characteristics of the content.</li> <li>– <b>DTS VIRTUAL:X</b> Immersive 3D sound from any content.</li> <li>– <b>STANDARD</b> Outputs the original sound.</li> </ul> <ul style="list-style-type: none"> <li>• <b>DRC (Dynamic Range Control)</b> You can apply the DRC function when playing Dolby Digital Audio or DTS Audio. Press and hold the <b>SOUND MODE</b> button for more than 5 seconds while the Soundbar is powered off to turn DRC (Dynamic Range Control) on or off. With the DRC turned on, loud sound is reduced. (The sound may be distorted.)</li> <li>• <b>Bluetooth Power</b> This feature automatically turns the Soundbar on when it receives a connection request from a previously connected TV or Bluetooth device. The setting is On by default. <ul style="list-style-type: none"> <li>– Press and hold the <b>SOUND MODE</b> button for more than 5 seconds while the soundbar is powered on to turn off the Bluetooth Power function.</li> </ul> </li> </ul>
 <p><b>Info</b></p>	<p>Press to display information about the active function or the codec available.</p>

 <p><b>Volume</b></p>	<p>Push the button up or down to adjust the volume.</p>  <ul style="list-style-type: none"> <li>• <b>Mute</b> Press the <b>Volume</b> button in to mute the sound. Press it in again to unmute the sound.</li> </ul> 
 <p><b>WOOFER WOOFER (BASS) LEVEL</b></p>	  <p>Push the button up or down to adjust the level of the woofer (bass) to -12 or between -6 to +6. To set the woofer (bass) volume level to 0 (Default), press the button.</p>
 <p><b>CH LEVEL</b></p>	<p>By pressing the button, you can adjust the volume of each speaker.</p> <ul style="list-style-type: none"> <li>• Press the button to select <b>CENTER LEVEL</b> and then adjust the volume between -6 to +6 by using the <b>Up/Down</b> buttons.</li> <li>• If the Rear Speakers (sold separately) are connected, the setting <b>REAR LEVEL</b> is supported. To adjust the volume of the <b>REAR LEVEL</b> between -6 to +6, use the <b>Up/Down</b> buttons.</li> </ul>
 <p><b>Sound Control</b></p>	<p>By pressing the button, you can set the audio function. The desired settings can be adjusted using the <b>Up/Down</b> buttons.</p> <p><b>VOICE ENHANCE → NIGHT MODE → SYNC → SOUND GROUPING → PRIVATE REAR</b></p> <ul style="list-style-type: none"> <li>– <b>VOICE ENHANCE</b> This mode is makes it easier to hear spoken dialog in movies and TV.</li> <li>– <b>NIGHT MODE</b> This mode is optimized for nighttime viewing with the settings adjusted to bring the volume down but keep the dialog clear.</li> <li>– <b>SYNC</b> If the video on the TV and audio from the Soundbar are not synchronized, press the  (<b>Sound Control</b>) button to select <b>SYNC</b> and then set the audio delay between 0~300 milliseconds by using the <b>Up/Down</b> buttons. (Not available in “USB” or “BT” mode.)</li> </ul>



## Sound Control

### – SOUND GROUPING

The Soundbar main unit and the Rear Speakers (sold separately) play the entire sound instead of surround sound, making it ideal for large groups of people listening to music in a large space.

- This menu is initially activated when the Rear Speakers are connected, and then the menu remains activated regardless of the connection of the Rear Speakers.
- If you enable the Sound Grouping, there are no differences in sounds between the Sound modes.
- Sound does not come out from all speaker units of the Soundbar main unit and the Rear Speakers, but only from certain predetermined units, which vary by model.

### – PRIVATE REAR SOUND

This mode sets the sound to come out from the Rear Speakers (sold separately) only, allowing you to listen without being disturbed by others.

- If you enable this mode, sound does not come out from the Soundbar main unit and the Subwoofer. Sound only comes out from the front channel of the Rear Speakers.
- If you enable the Private Rear Sound, there are no differences in sounds between the Sound modes.
- The function turns off when the power turns off or the Rear Speakers connection is lost.
- The menu is activated only when the Rear Speakers are connected.
- The **NIGHT MODE**, and **VOICE ENHANCE** audio function can be turned **ON/OFF** by using the **Up/Down** buttons.
- Press and hold the  (**Sound Control**) button for about 5 seconds to adjust the sound for each frequency band. 150Hz, 300Hz, 600Hz, 1.2kHz, 2.5kHz, 5kHz, and 10kHz are selectable using the **Left/Right** buttons and each can be adjusted to a setting between -6 to +6 using the **Up/Down** buttons. (Make sure the Sound mode is set to “**STANDARD**”.)





## TONE CONTROL

By pressing the button, you can adjust the volume of the treble or bass sound.

- Press the button to select **TREBLE** or **BASS** and then adjust the volume between -6~+6 by using the **Up/Down** buttons. Once the bass level is changed, the woofer level will be also adjusted accordingly.

## Using the Hidden Buttons (Buttons with more than one function)

Hidden Button		Reference page
Remote Control Button	Function	
WOOFER (Up)	TV remote control On/Off (Standby)	page 15
Left	TV Auto connect On/Off (BT Ready)	page 24
Up	ID SET	page 10
 (Sound Control)	7 Band EQ	page 13
SOUND MODE	DRC ON/OFF (Standby)	page 11
	Bluetooth Power On/Off	page 11
 PAIR	Bluetooth Multi-connection On/Off (Standby)	page 31

## Output specifications for the different sound effect modes

Effect		Input	Output	
			Without Wireless Rear Speaker Kit	With Wireless Rear Speaker Kit
 <b>SOUND MODE</b>	SURROUND SOUND	2.0 ch	3.1 ch	5.1 ch
		5.1 ch	3.1 ch	5.1 ch
	BASS BOOST	2.0 ch	3.1 ch	5.1 ch
		5.1 ch	3.1 ch	5.1 ch
	GAME	2.0 ch	3.1 ch	5.1 ch
		5.1 ch	3.1 ch	5.1 ch
	ADAPTIVE SOUND	2.0 ch	3.1 ch	5.1 ch
		5.1 ch	3.1 ch	5.1 ch
	DTS VIRTUAL:X	2.0 ch	3.1 ch	5.1 ch
		5.1 ch	3.1 ch	5.1 ch
	STANDARD	2.0 ch	2.1 ch	2.1 ch
		5.1 ch	3.1 ch	5.1 ch







- The Samsung Wireless Rear Speaker Kit can be purchased separately. To purchase a Kit, contact the vendor you purchased the Soundbar from.
- The Rear Speakers will not produce sounds for 2 channel output while **STANDARD** mode is in use. To enable sound for the Rear Speakers, change the effect mode to **SURROUND SOUND**.

# Adjusting the Soundbar volume with a TV remote control

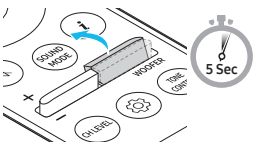
Adjust the Soundbar volume using the TV's remote control.

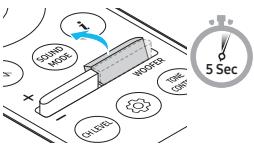
- This function can be used with IR remote controls only. Bluetooth remote controls (remote controls that require pairing) are not supported.
- Set the TV speaker to **External Speaker** to use this function.
- Manufacturers supporting this function:  
Samsung, VIZIO, LG, Sony, Sharp, PHILIPS, PANASONIC, TOSHIBA, Hisense, RCA

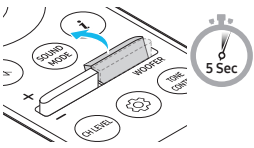
1. Turn Off the Soundbar.
2. Push up and hold the **WOOFER** button for 5 seconds.  
Each time you push the **WOOFER** button up and hold it for 5 seconds, the mode switches in the following order: "OFF-TV REMOTE" (Default mode), "SAMSUNG-TV REMOTE", "ALL-TV REMOTE".

Remote Control Button	Display	Status
	(Default mode) <b>OFF-TV REMOTE</b> 	Disable the TV remote control.
	<b>SAMSUNG-TV REMOTE</b> 	Enable a Samsung TV's IR remote control.
	<b>ALL-TV REMOTE</b> 	Enable a third-party TV's IR remote control.

# 04 CONNECTING THE SOUNDBAR

## Connecting Electrical Power

Use the power components to connect the Subwoofer and Soundbar to an electrical outlet in the following order:

1. Connect power cord End **A** to Subwoofer and End **B** to wall socket.
2. Connect power cord End **A** to Soundbar and End **B** to wall socket.

See the illustrations below.

- For more information about the required electrical power and power consumption, refer to the label attached to the product. (Label: Bottom or back of the product.)

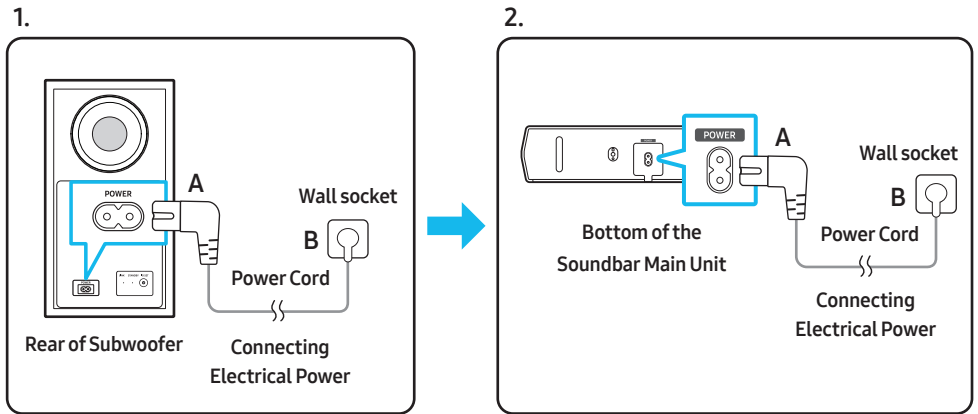

- Connect power to the Subwoofer first. The Subwoofer will be automatically connected when turning on the Soundbar.
- If you unplug and reconnect the power cord when the product is turned on, the Soundbar turns on automatically.

# Manually connecting the Subwoofer if automatic connection fails

## Before performing the manual connection procedure below:

- Check whether the power cables for the Soundbar and subwoofer are connected properly.
- Make sure that the Soundbar is turned on.

1. Press and hold **ID SET** on the rear of the subwoofer for at least 5 seconds.
  - The red indicator on the rear of the subwoofer turns off and the blue indicator blinks.

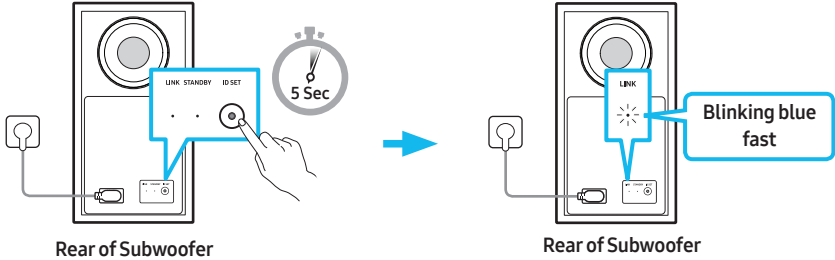

2. First, press the button on the remote control to turn on the display.  
Press and hold the **Up** button on the remote control for at least 5 seconds.
  - The **ID SET** message appears on the display of the Soundbar for a moment, and then it disappears.
  - The Soundbar will automatically power on when **ID SET** is complete.

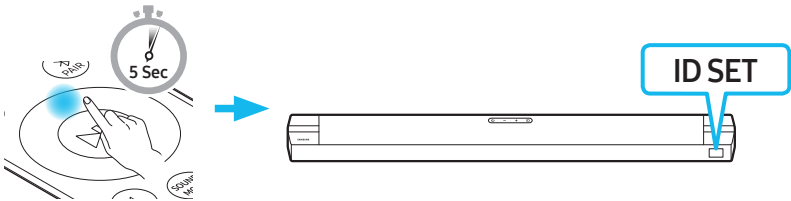

3. Check if the LINK LED is solid blue (connection complete).

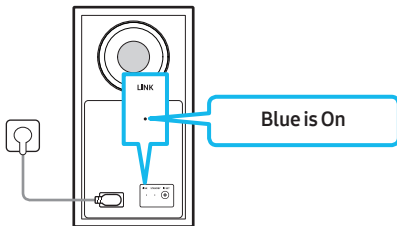

The LINK LED indicator stops blinking and glows a solid blue when a connection is established between the Soundbar and the Wireless Subwoofer.

## LED Indicator Lights on the Rear of Subwoofer

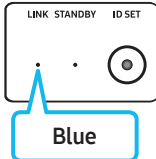
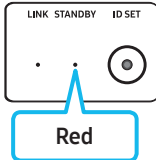
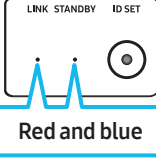
LED	Status	Description	Resolution
	On	Successfully connected (normal operation)	-
	Blinking	Recovering the connection	Check if the power cable attached to the main Soundbar unit is connected properly or wait about 5 minutes. If blinking persists, try manually connecting the subwoofer. See page 17.
	On	Standby (with the Soundbar main unit turned off)	Check if the power cable attached to the main Soundbar unit is connected properly.
		Connection failed	Connect again. See the instructions for manual connection on page 17.
	Blinking	Malfunction	See the contact information for the Samsung Service Center in this manual.

### NOTES

- Do not connect the power cord of this product or your TV to a wall outlet until all connections between components are complete.
- Before moving or installing this product, be sure to turn off the power and disconnect the power cord.
- If the main unit is powered off, the wireless subwoofer will go into stand-by mode and the STANDBY LED on the rear of the Subwoofer will turn red after blinking blue several times.
- If you use a device that uses the same frequency as the Soundbar near the Soundbar, interference may cause some sound interruption.
- The maximum transmission distance of the main unit's wireless signal is about 32.8 ft (10 m), but may vary depending on your operating environment. If a steel-concrete or metallic wall is between the main unit and the wireless subwoofer, the system may not operate at all because the wireless signal cannot penetrate metal.

## **PRECAUTIONS**

- Wireless receiving antennas are built into the wireless subwoofer. Keep the unit away from water and moisture.
- For optimal listening performance, make sure that the area around the wireless subwoofer and the Wireless Receiver Module (sold separately) is clear of any obstacles.

## **Connecting the Samsung Wireless Rear Kit to your Soundbar**

Expand to true wireless surround sound by connecting the Samsung Wireless Rear Speaker Kit (SWA-9250S sold separately) to your Soundbar.

For detailed information on connections, see the Samsung Wireless Rear Speaker Kit manual.

# 05 USING A WIRED CONNECTION TO THE TV

Hear TV sound from your Soundbar through wired or wireless connections.

- When the Soundbar is connected to selected Samsung TVs, the Soundbar can be controlled using the TV's remote control.
  - This feature is supported by 2017 and later Samsung Smart TVs that support Bluetooth when you connect the Soundbar to the TV using an optical cable.
  - This function also allows you to use the TV menu to adjust the sound field and various settings as well as the volume and mute.

## Method 1. Connecting using an Optical Cable

### Pre-connection Checklist

- When both the HDMI cable and optical cable are connected, the HDMI signal is received first.
- When you use an optical cable and the terminals have covers, be sure to remove the covers.



- When using an optical cable, it must be set to “D.IN” mode.

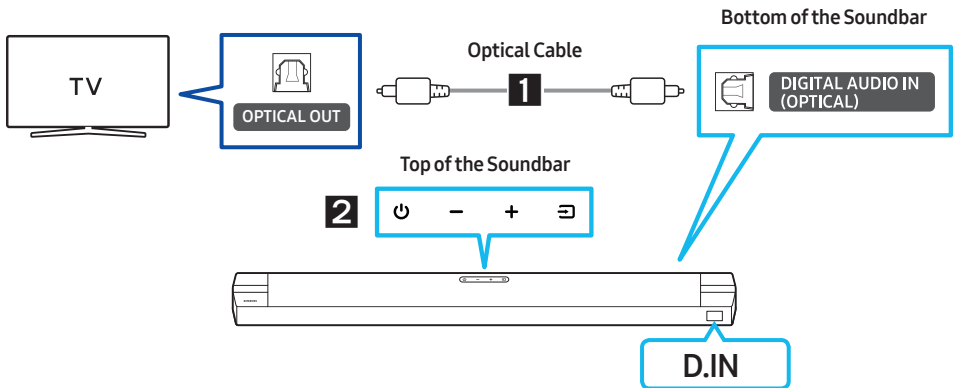



1. Connect the **DIGITAL AUDIO IN (OPTICAL)** port on the Soundbar to the OPTICAL OUT port of the TV with a digital optical cable.
2. Press the  (**Source**) button on the top panel or remote control, and then select the “D.IN” mode.
3. The TV sound is played from the Soundbar.

## Method 2. Connecting a TV using an HDMI Cable

### CAUTION

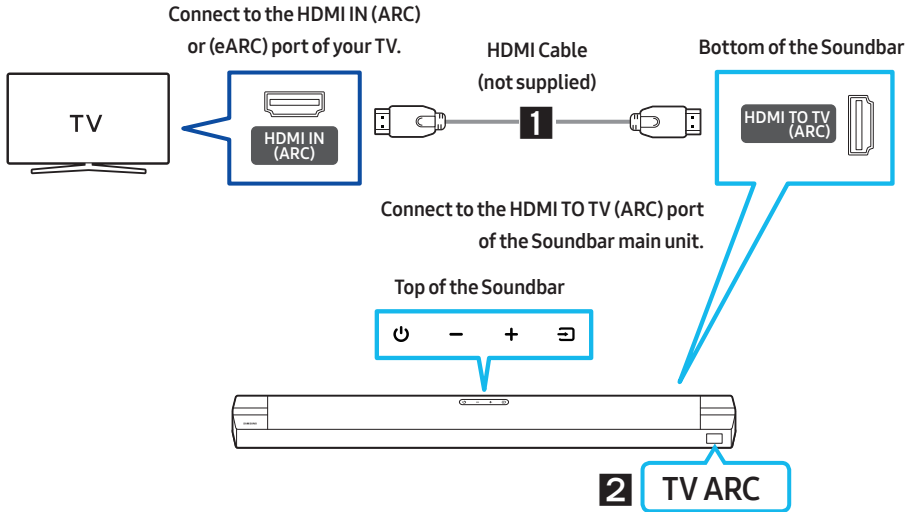
- When both the HDMI cable and optical cable are connected, the HDMI signal is received first.
- To connect the HDMI cable between the TV and Soundbar, be sure to connect the terminals marked ARC. Otherwise, the TV sound may not be output.
- The recommended cable is an HDMI cable certified by HDMI.org.



1. With the Soundbar and TV turned on, connect the HDMI cable (not supplied) as shown in the figure.
2. “TV ARC” appears in the display window of the Soundbar main unit and the Soundbar plays TV sound.
  - If TV sound is inaudible, press the  (Source) button on the remote control or on the top of the Soundbar to switch to “TV ARC” mode. The screen display “TV ARC”, and TV sound is played.
  - If “TV ARC” does not appear in the display window of the Soundbar main unit, confirm that the HDMI cable (not supplied) is connected to the correct port.
  - Use the volume buttons on the TV’s remote control to change the volume on the Soundbar.

## NOTES

- HDMI is an interface that enables the digital transmission of video and audio data with just a single connector.
- If the TV provides an ARC port, connect the HDMI cable to the HDMI IN (ARC) port.
- We recommend you use a coreless HDMI cable if possible. If you use a cored HDMI cable, use one with a diameter that is less than 0.55 inches (14 mm).
- This function is not available if the HDMI cable does not support ARC.
- When the audio in a broadcast is encoded in Dolby Digital and the “Digital Output Audio Format” on your TV is set to PCM, we recommend that you change the setting to Dolby Digital. When the setting on the TV is changed, you will experience better sound quality. (The TV menu may use different words for Dolby Digital and PCM depending on the TV manufacturer.)

# 06 USING A WIRELESS CONNECTION TO THE TV

## Connecting a TV via Bluetooth

When a TV is connected using Bluetooth, you can hear stereo sound without the hassle of cabling.

- Only one TV can be connected at a time.

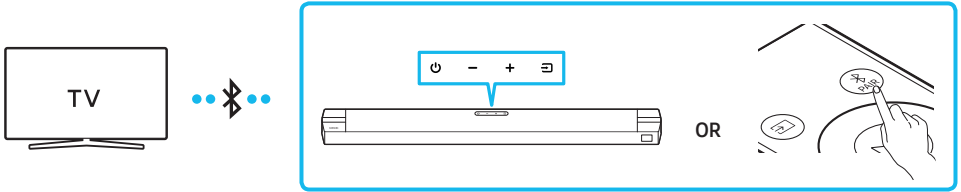

### The initial connection

1. Press the **PAIR** button on the remote control to enter the “**BT PAIRING**” mode.

(OR) a. Press the **(Source)** button on the top panel and then select “**BT**”.

“**BT**” changes to “**BT PAIRING**” in a few seconds automatically or changes to “**BT READY**” if there is a connect record.

- b. When “**BT READY**” appears, press and hold the **(Source)** button on the top panel of the Soundbar for more than 5 seconds to display “**BT PAIRING**”.

2. Select Bluetooth mode on the TV. (For more information, see the TV’s manual.)

3. Select “[AV] B-Series Soundbar” from the list on TV’s screen.

An available Soundbar is indicated with “**Needs Pairing**” or “**Paired**” on the TV’s Bluetooth device list. To connect the TV to the Soundbar, select the message, and then establish a connection.

- When the TV is connected, [TV Name] → “**BT**” appears on the Soundbar’s front display.

4. You can now hear TV sound from the Soundbar.

### If the device fails to connect

- If a previously connected Soundbar listing (e.g. “[AV] B-Series Soundbar”) appears in the list, delete it.
- Then repeat steps 1 through 3.

### NOTE



- After you have connected the Soundbar to your TV the first time, use the “**BT READY**” mode to reconnect.

## Disconnecting the Soundbar from the TV

Press the  (**Source**) button on the top panel or on the remote control and switch to any mode but “**BT**”.

- Disconnecting takes time because the TV must receive a response from the Soundbar. (The time required may differ, depending on the TV model.)
- To cancel the automatic Bluetooth connection between the Soundbar and TV, press the **Left** button on the remote control for 5 seconds with the Soundbar in “**BT READY**” status. (Toggle On → Off)

## What is the difference between BT READY and BT PAIRING?

- **BT READY** : In this mode, you can search for previously connected TVs or connect a previously connected mobile device to the Soundbar.
- **BT PAIRING** : In this mode, you can connect a new device to the Soundbar. (Press the  **PAIR** button on the remote control or press and hold the  (**Source**) button on the top of the Soundbar for more than 5 seconds while the Soundbar is in “**BT**” mode.)

## NOTES

- If asked for a PIN code when connecting a Bluetooth device, enter <0000>.
- In Bluetooth connection mode, the Bluetooth connection will be lost if the distance between the Soundbar and the Bluetooth device exceeds 32.8 ft (10 meters).
- The Soundbar automatically turns off after 18 minutes in the Ready state.
- The Soundbar may not perform Bluetooth search or connection correctly under the following circumstances:
  - If there is a strong electrical field around the Soundbar.
  - If several Bluetooth devices are simultaneously paired with the Soundbar.
  - If the Bluetooth device is turned off, not in place, or malfunctions.
- Electronic devices may cause radio interference. Devices that generate electromagnetic waves must be kept away from the Soundbar main unit - e.g., microwaves, wireless LAN devices, etc.

# 07 CONNECTING AN EXTERNAL DEVICE

Connect to an external device via a wired connection or Bluetooth connection to play the external device's sound through the Soundbar.

## Method 1. Connecting using an Optical Cable

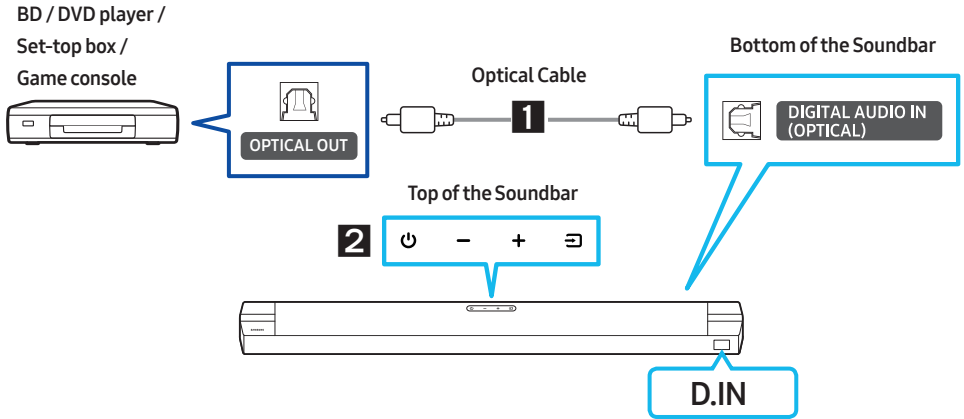

1. Connect **DIGITAL AUDIO IN (OPTICAL)** on the main unit to the **OPTICAL OUT** port of the Source Device using a digital optical cable.
2. Select "**D.IN**" mode by pressing the  (**Source**) button on the top panel or on the remote control.
3. The external device sound is output from the Soundbar.

## Method 2. Connecting using an HDMI Cable

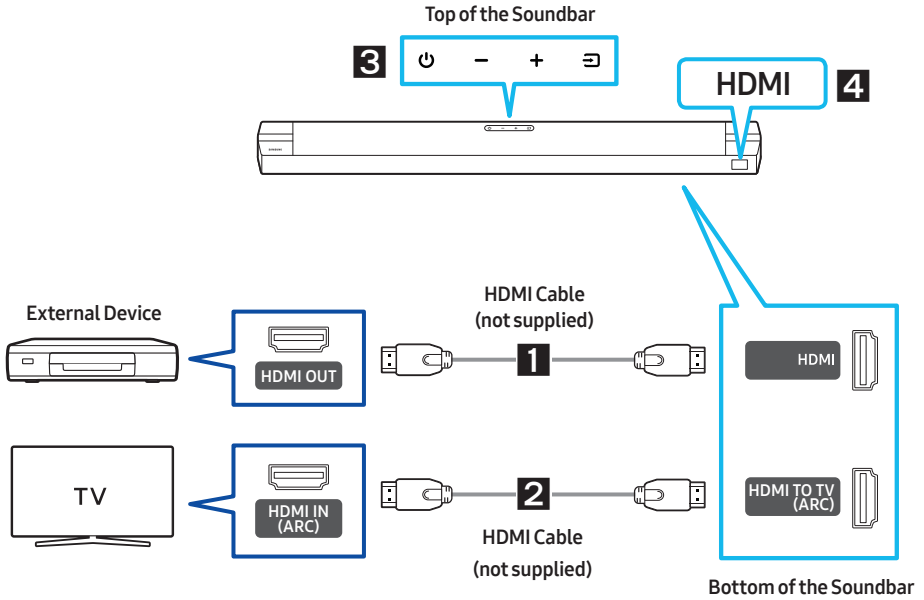

1. Connect an HDMI cable (not supplied) from the **HDMI** port on the bottom of the Soundbar to the HDMI OUT port on your digital device.
2. Connect an HDMI cable (not supplied) from the **HDMI TO TV (ARC)** port on the bottom of the Soundbar to the HDMI IN port on your TV.
3. Press the  (**Source**) button on the top panel or on the remote control, and then select “**HDMI**”.
4. “**HDMI**” mode is displayed on the Soundbar display panel and sound plays.

# 08 CONNECTING A USB STORAGE DEVICE

You can play music files located on USB storage devices through the Soundbar.

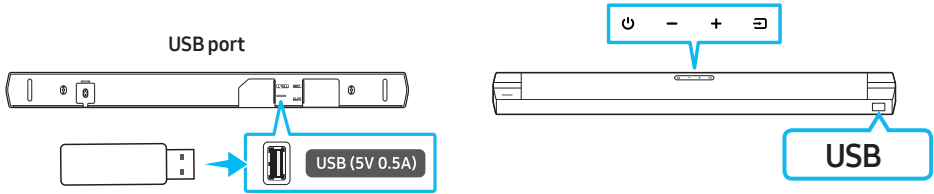

1. Connect the USB device to the USB port on the bottom of the product.
2. Press the  (**Source**) button on the top panel or on the remote control, and then select “USB”.
3. “USB” appears in the display screen.
4. Play music files from the USB storage device through the Soundbar.
  - The Soundbar automatically turns off (Auto Power Down) if no USB device has been connected for more than 18 minutes.

## File Format Type Compatibility list

Extension	Codec	Sampling Rate	Bitrate
*.mp3	MPEG1 Layer2	32kHz ~ 48kHz	32kbps ~ 320kbps
	MPEG1 Layer3	32kHz ~ 48kHz	32kbps ~ 320kbps
	MPEG2 Layer3	16kHz ~ 24kHz	8kbps ~ 160kbps
	MPEG2.5 Layer3	8kHz ~ 12kHz	8kbps ~ 160kbps
*.ogg	Vorbis	32kHz ~ 48kHz	45kbps ~ 500kbps
*.aac *.m4a *.mp4 (Audio Only)	AAC-LC (MPEG2/MPEG4)	32kHz ~ 48kHz	32kbps ~ 320kbps
*.wav	LPCM	32kHz ~ 192kHz	1,024kbps ~ 9,216kbps
*.flac	FLAC	32kHz ~ 192kHz	162kbps ~ 8,100kbps
*.aiff	AIFF	32kHz ~ 192kHz	1,024kbps ~ 9,216kbps

- If there are too many folders (about 200) and files (about 2000) stored on the USB device, it may take the Soundbar some time to access and play files.
- Supported USB file system : FAT16, FAT32, NTFS

# 09 CONNECTING A MOBILE DEVICE

## Connecting via Bluetooth

When a mobile device is connected using Bluetooth, you can hear stereo sound without the hassle of cabling.

- When you connect a paired Bluetooth device with the Soundbar off, the Soundbar automatically turns on.
- The connection is limited to one TV or two Bluetooth devices at the same time.

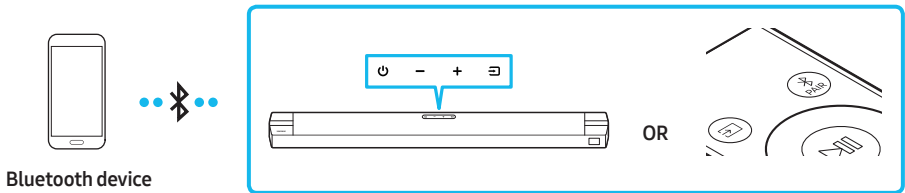

### The initial connection

- When connecting to a new Bluetooth device, make sure the device is within 3.28 ft (1 m) distance.
1. Press the **PAIR** button on the remote control to enter the “**BT PAIRING**” mode.  
**(OR)** a. Press the **(Source)** button on the top panel and then select “**BT**”.  
“**BT**” changes to “**BT PAIRING**” in a few seconds automatically or changes to “**BT READY**” if there is a connect record.  
b. When “**BT READY**” appears, press and hold the **(Source)** button on the top panel of the Soundbar for more than 5 seconds to display “**BT PAIRING**”.
  2. On your device, select “[**AV**] **B-Series Soundbar**” from the list that appears.
    - When the Soundbar is connected to the Bluetooth device, [**Bluetooth Device Name**] → “**BT**” appears in the front display.
  3. Play music files from the device connected via Bluetooth through the Soundbar.



### If the device fails to connect

- If a previously connected Soundbar listing (e.g. “[**AV**] **B-Series Soundbar**”) appears in the list, delete it.
- Then repeat steps 1 and 2.

### NOTE

- After you have connected the Soundbar to your mobile device the first time, use the “**BT READY**” mode to reconnect.

## What is the difference between BT READY and BT PAIRING?

- **BT READY** : In this mode, you can search for previously connected TVs or connect a previously connected mobile device to the Soundbar.
- **BT PAIRING** : In this mode, you can connect a new device to the Soundbar. (Press the  **PAIR** button on the remote control or press and hold the  (**Source**) button on the top of the Soundbar for more than 5 seconds while the Soundbar is in “BT” mode.)

## NOTES

- If asked for a PIN code when connecting a Bluetooth device, enter <0000>.
- In Bluetooth connection mode, the Bluetooth connection will be lost if the distance between the Soundbar and the Bluetooth device exceeds 32.8 ft (10 m).
- The Soundbar automatically turns off after 18 minutes in the Ready state.
- The Soundbar may not perform Bluetooth search or connection correctly under the following circumstances:
  - If there is a strong electrical field around the Soundbar.
  - If several Bluetooth devices are simultaneously paired with the Soundbar.
  - If the Bluetooth device is turned off, not in place, or malfunctions.
- Electronic devices may cause radio interference. Devices that generate electromagnetic waves must be kept away from the Soundbar main unit - e.g., microwaves, wireless LAN devices, etc.
- The Soundbar supports SBC data (44.1kHz, 48kHz).
- Connect only to a Bluetooth device that supports the A2DP (AV) function.

## Bluetooth Power On (SOUND MODE)

If a previously paired Bluetooth device tries to pair with the Soundbar when the Bluetooth Power On function is on and the Soundbar is turned off, the Soundbar turns on automatically.

1. Press and hold the **SOUND MODE** button for more than 5 seconds on the remote while the Soundbar is turned on.
2. “**ON-BLUETOOTH POWER**” appears on the Soundbar’s display.

## Disconnecting the Bluetooth device from a Soundbar

You can disconnect a Bluetooth device from the Soundbar. For instructions, see the Bluetooth device's user manual.

- The Soundbar will be disconnected.
- When the Soundbar is disconnected from the Bluetooth device, the Soundbar will display **"BT DISCONNECTED"** on the front display.

## Disconnecting the Soundbar from the Bluetooth device

Press the  (**Source**) button on the top panel or on the remote control, and then change to any mode except **"BT"**.

- Disconnecting takes time because the Bluetooth device must receive a response from the Soundbar. (Disconnection time may differ, depending on the Bluetooth device)
- When the Soundbar is disconnected from the Bluetooth device, the Soundbar will display **"BT DISCONNECTED"** on the front display.

## **More About Bluetooth**

Bluetooth is a technology that enables Bluetooth-compliant devices to interconnect easily with each other using a short wireless connection.

- A Bluetooth device may cause noise or malfunction, depending on usage, if:
  - A part of your body is in contact with the receiving/transmitting system of the Bluetooth device or the Soundbar.
  - It is subject to electrical variation from obstacles caused by a wall, corner, or office partition.
  - It is exposed to electrical interference from same frequency-band devices including medical equipment, microwave ovens, and wireless LANs.
- Pair the Soundbar with the Bluetooth device while they are close together.
- The further the distance between the Soundbar and Bluetooth device, the worse the quality is. If the distance exceeds the Bluetooth operational range, the connection is lost.
- In poor reception areas, the Bluetooth connection may not work properly.
- The Bluetooth connection only works when it is close to the unit. The connection will be automatically cut off if the Bluetooth device is out of range. Even within range, the sound quality may be degraded by obstacles such as walls or doors.
- This wireless device may cause electric interference during its operation.

## Bluetooth Multi connection

The Soundbar can be connected to 2 Bluetooth devices at the same time.

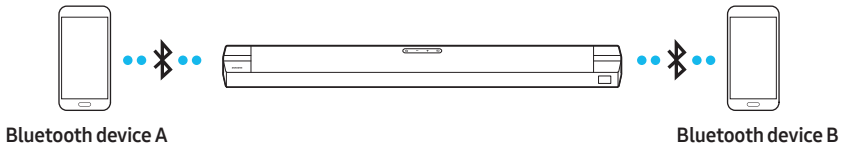

1. Connect the Soundbar to up to two Bluetooth devices. (See page 28)
2. Play music from one of the connected Bluetooth devices while two devices are connected.
3. If music is played from the Bluetooth device "B" while playing from the device "A", the music is started playing on the device "B" and automatically being stopped/paused playback on the device "A".
4. In versions prior to AVRCP V1.4, the switching time of the device playing music may be delayed.

## Bluetooth Multi Pairing

### How to pair multiple devices to the Soundbar

1. Turn on the Soundbar.
2. Only in "BT" mode, press and hold the  (Source) button on the top of the Soundbar for more than 5 seconds for the Soundbar to go into "BT PAIRING" mode, then on the Bluetooth device side, switch Bluetooth on, and select the Soundbar from the list of available devices, the Soundbar will automatically connect to the Bluetooth device.
3. A 2nd Bluetooth device can be paired and connected to the Soundbar using the same method. If you attempt to connect a 3rd device, a connected device that is not playing audio will lose its Bluetooth connection, but will still be paired with the Soundbar.
4. Using the same method, you can pair up to 8 Bluetooth devices, but only the last 2 will stay connected to the Soundbar at the same time.

### NOTES

- Only 1 Samsung TV, or 2 Bluetooth devices can be connected to the Soundbar at one time.
- The Soundbar will be disconnected from Bluetooth devices when it receives a connection request from a Samsung TV.
- The default of Soundbar is "ON-BT MULTI CONNECTION", but for restoration to non-multi connection mode from another mode, press and hold the  PAIR button on the remote control for more than 5 seconds in standby mode, until "OFF-BT MULTI CONNECTION" appears in the display.

# 10 INSTALLING THE WALL MOUNT

## Installation Precautions

- Install on a vertical wall only.
- Do not install in a place with high temperature or humidity.
- Verify whether the wall is strong enough to support the product's weight. If not, reinforce the wall or choose another installation point.
- Purchase and use the fixing screws or anchors appropriate for the kind of wall you have (plaster board, iron board, wood, etc.). If possible, fix the support screws into wall studs.
- Purchase wall mounting screws according to the type and thickness of the wall you want to mount the Soundbar on.
  - Diameter: M5
  - Length: 1 3/8 inches (35 mm) or longer recommended.
- Connect cables from the unit to external devices before you install the Soundbar on the wall.
- Make sure the unit is turned off and unplugged from the power source before you install it. Otherwise, it may cause an electric shock.

## Wallmount Components

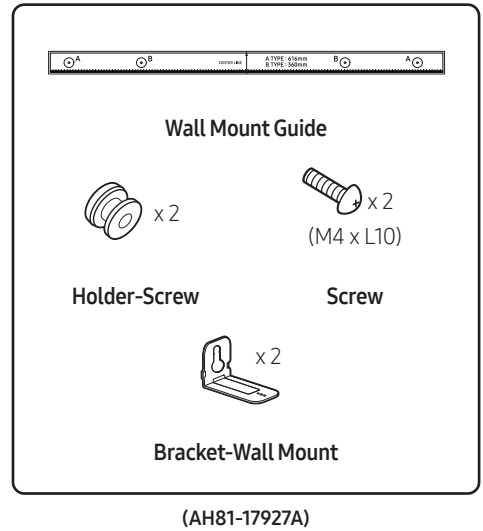

1. Place the **Wall Mount Guide** against the wall surface.
  - The **Wall Mount Guide** must be level.
  - If your TV is mounted on the wall, install the Soundbar at least 2 inches (5 cm) below the TV.

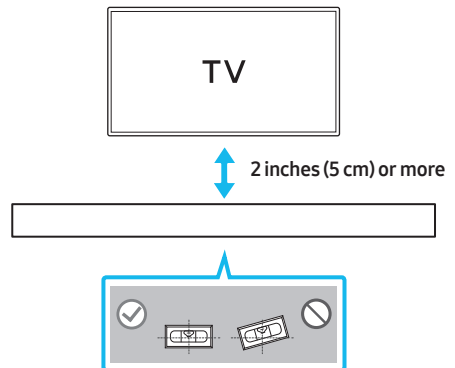

- Align the **Wall Mount Guide's Center Line** with the center of your TV (if you are mounting the Soundbar below your TV), and then fix the **Wall Mount Guide** to the wall using tape.
  - If you are not mounting below a TV, place the **Center Line** in the center of the installation area.

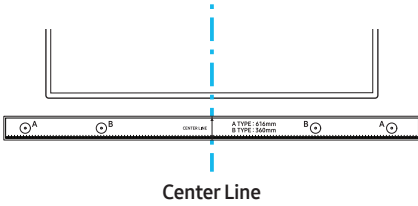

- Push a pen tip or sharpened pencil tip through the center of the **A-TYPE** images on each end of the Guide to mark the holes for the supporting screws, and then remove the **Wall Mount Guide**.

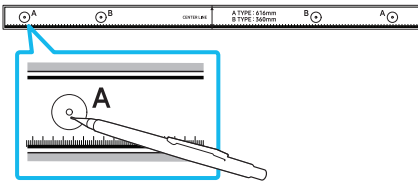

- Using an appropriately sized drill bit, drill a hole in the wall at each marking.
  - If the markings do not correspond to the positions of studs, make sure you insert appropriate anchors into the holes before you insert the support screws. If you use anchors, make sure the holes you drill are large enough for the anchors you use.

- Push a screw (not supplied) through each **Holder-Screw**, and then screw each screw firmly into a support screw hole.

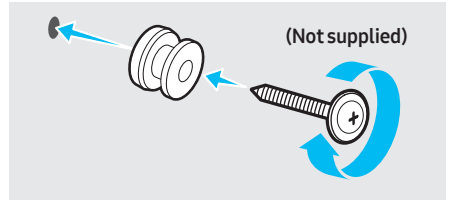

- Install the 2 **Bracket-Wall Mounts** in the correct orientation on the bottom of the Soundbar using 2 **Screws**.

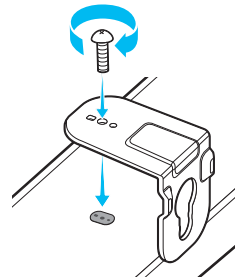

- When assembling, make sure the hanger part of the **Bracket-Wall Mounts** is located behind the rear of the Soundbar.

**Rear of Soundbar**

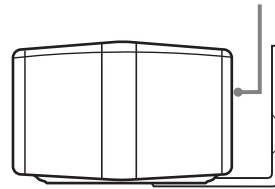

**Right end of Soundbar**

7. Install the Soundbar with the attached **Bracket-Wall Mounts** by hanging the **Bracket-Wall Mounts** on the **Holder-Screws** on the wall.

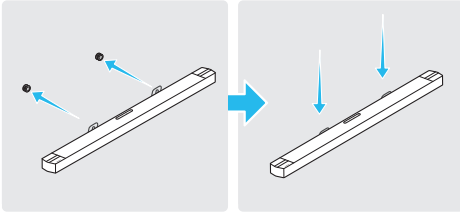

8. Slide the Soundbar down as shown below so that the **Bracket-Wall Mounts** rest securely on the **Holder-Screws**.
- Insert the **Holder-Screws** into the wide (bottom) part of the **Bracket-Wall Mounts**, and then slide the **Bracket-Wall Mounts** down so that the **Bracket-Wall Mounts** rest securely on the **Holder-Screws**.

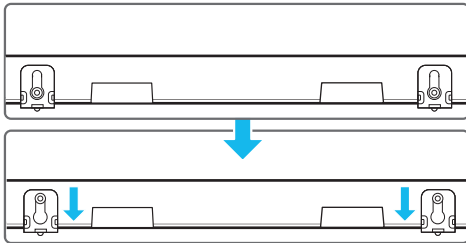

## 11 PLACING THE SOUNDBAR ON A TV STAND

Place the Soundbar on a TV stand.

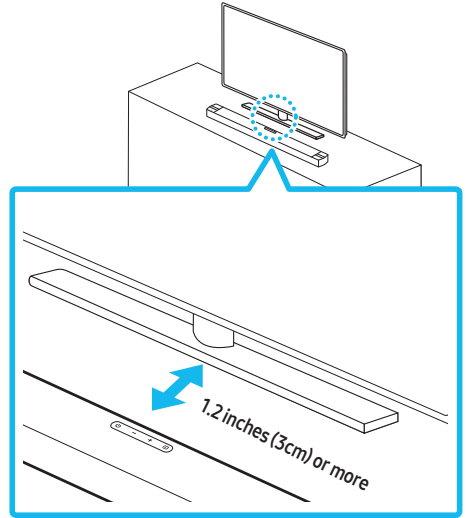

As illustrated in the image, align the center of the Soundbar with the center of the TV, carefully place the Soundbar onto the TV stand.

For optimal sound quality, position the Soundbar at least 1.2 inches (3 cm) away from the TV front.

### NOTE

- Make sure the Soundbar is placed on a flat and solid surface.

# 12 SOFTWARE UPDATE

Samsung may offer updates for the Soundbar's system firmware in the future.

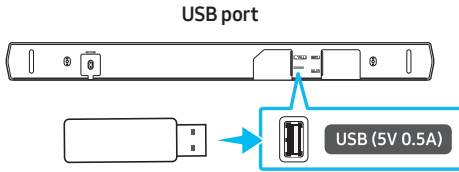

If an update is offered, you can update the firmware by connecting a USB device with the firmware update stored on it to the USB port on your Soundbar. For more information about how to download update files, go to the Samsung Electronics website at <https://www.samsung.com/us/support/downloads/>. Then, select the product type or enter the model number of your Soundbar, and then download the firmware. Note that the option names can vary.



## How to check the Firmware version

1. Turn off the Soundbar.
2. Press and hold the  (Sound Control) button for about 5 seconds on the remote control.
3. Each version appears in the following order on the Soundbar display.  
(Software version → HDMI → T → R → R2)
  - T : Wireless Tx module in the Soundbar.
  - R : Wireless Rx module in the Subwoofer.
  - R2 : Version of the Rear Speakers.
    - Not connected Rear : R2---
    - Connected Rear : R2xxx

## Update Procedure

**Important:** The update function erases all user settings. We recommend you write down your settings so that you can easily reset them after the update. Note that updating the firmware resets the subwoofer connection too.

1. Connect a USB thumb drive to the USB port on your computer.

**Important:** Make sure there are no music files on the USB thumb drive. This may cause the firmware update to fail.
2. Go to <https://www.samsung.com/us/support/downloads/> on your computer → select Enter Model Number and enter the model of your Soundbar. Select manuals and downloads and download the latest software file.
3. Save the downloaded software to a USB stick and select "Extract Here" to unzip the folder.
4. Turn off the Soundbar and connect the USB stick containing the software update to the USB port.
5. Turn on the Soundbar and change the source to "USB" mode. Within 3 minutes, "UPGR" is displayed and the update begins. When the update is complete, the Soundbar turns off and then turns on automatically.
6. Press the   (Volume) button on the top panel for 5 seconds. "INIT" → "OK" appears on the display and then the Soundbar turns off. The update is complete.
  - This product has a DUAL BOOT function. If the firmware fails to update, you can update the firmware again.
7. Restore your settings on the Soundbar.

## If UPGR is not displayed

1. Turn off the Soundbar, disconnect and then reconnect the USB storage device that contains the update files to the Soundbar's USB port.
2. Disconnect the Soundbar's power cord, reconnect it, and then turn on the Soundbar.

### NOTES

- The firmware update may not work properly if audio files supported by the Soundbar are stored in the USB storage device.
- Do not disconnect the power or remove the USB device while updates are being applied. The main unit will turn off automatically after completing the firmware update.
- After the update is completed, the user setup in the Soundbar maybe will be initialized. So we recommend you write down your settings so that you can easily reset them after the update. Note that updating firmware resets the subwoofer connection too.  
If the connection to the subwoofer is not re-established automatically after the update, refer to page 17.  
If the software update fails, check if the USB stick is defective.
- Mac OS users should use MS-DOS (FAT) as the USB format.
- Updating via USB may not be available, depending on the USB storage device manufacturer.
- When the latest version is installed, no update is performed.

# 13 TROUBLESHOOTING

Refer to the instructions below if this product does not function properly. If the problem you are experiencing is not listed below or if the instructions below do not help, turn off the product, disconnect the power cord, and contact Samsung Electronics at 1-800-SAMSUNG (1-800-726-7864).

## Soundbar does not turn on.

- Check whether the power cord of the Soundbar is correctly inserted into the outlet.

## Soundbar works erratically.

- After removing the power cord, insert it again.
- Power the external device off/on and try again.
- If there is no signal, the Soundbar automatically turns off after a certain period of time. Turn on the power. (See page 8.)

## If the remote control does not work.

- Point the remote directly at the Soundbar.
- Replace the batteries with new ones.

## Soundbar does not output any sound.

- The volume of the Soundbar is too low or muted. Adjust the volume.
- When any external device (STB, Bluetooth device, mobile device, etc.) is connected, adjust the volume of the external device.
- For sound output of the TV, select Soundbar. (Samsung TV: Home (🏠) → Menu → Settings (⚙️) → All Settings (⚙️) → Sound → Sound Output → Select Soundbar)
- The cable connection to the Soundbar may be loose. Remove the cable and connect again.
- Remove the power cord completely, reconnect, and turn the power on.
- Reset the product and try again. (See page 35.)

## Subwoofer does not output any sound.

- Check whether the LED indicator on the rear of the Subwoofer is on in blue. Reconnect the Soundbar and Subwoofer if the indicator is blinking in blue or turned red. (See page 17.)
- You may experience an issue if there is an obstacle between the Soundbar and Subwoofer. Move devices to an area away from obstacles.
- Other devices sending radio frequency signals in proximity may interrupt the connection. Keep your speaker away from such devices.
- Remove and reconnect the power plug.

## The Subwoofer volume is too low.

- The original volume of the content you are playing may be low. Try adjusting the Subwoofer level. (See page 12.)
- Bring the Subwoofer speaker closer to you.

## In case there is sound jitter, delays, or noise from the Subwoofer.

- If there are any objects between the Soundbar and Subwoofer speaker, this could cause a problem. Please reposition these to a place without interference from that object.
- There may be sound jitter or delays when the Subwoofer is far from the Soundbar. Please place it near the Soundbar.
- There may be sound jitter or delays when the Soundbar is near an instrument or electrical device that can cause radio interference. Place the Soundbar far from such devices that can cause radio interference. (E.g., wireless router)
- Change the TV network connection status from wireless to wired.



### If the TV is not connected via HDMI TO TV (ARC).

- Check whether the HDMI cable is correctly connected to the ARC terminal.  
(See page 21.)
- Connection may not be possible due to the connected external device (set-top box, game machine, etc.). Directly connect the Soundbar.
- HDMI-CEC may not be activated on the TV. Turn on the CEC on the TV menu. (Samsung TV: Home (🏠) → Menu → Settings (⚙️) → All Settings (⚙️) → Connection → External Device Manager → Anynet+ (HDMI-CEC) ON)

### There is no sound in when connecting to the TV in HDMI TO TV (ARC) mode.

- Your device is unable to play the input signal. Change the TV's audio output to PCM or AUTO.  
(For a Samsung TV: Home (🏠) → Menu → Settings (⚙️) → All Settings (⚙️) → Sound → Expert Settings → Digital Output Audio Format)

### Soundbar does not connect via Bluetooth.

- When connecting a new device, switch to **"BT PAIRING"** for connection. (Press the  **PAIR** button on the remote control or press and hold the  (**Source**) button on the top of the Soundbar for more than 5 seconds while the Soundbar is in **"BT"** mode.)
- If the Soundbar is connected to another device, disconnect that device first to switch the device.
- Reconnect it after removing the Bluetooth speaker list on the device to connect. (Samsung TV: Home (🏠) → Menu → Settings (⚙️) → All Settings (⚙️) → Sound → Sound Output → Bluetooth Speaker List)
- The automatic TV connection may be disabled. While the Soundbar is in **"BT READY"**, press and hold the **Left** button on the Soundbar remote control for 5 seconds to select **ON-TV CONNECT**. If you see **OFF-TV CONNECT**, press and hold **Left** button again for 5 seconds to switch the selection.
- Remove and reconnect the power plug, then try again.
- Reset the product and try again.  
(See page 35.)

### Sound drops out when connected via Bluetooth.

- Some devices can cause radio interference if they are located too close to the Soundbar. (e. g. microwaves, wireless routers, etc.)
- If your device that is connected via Bluetooth moves too far away from the Soundbar, it may cause the sound to drop out. Move the device closer to the Soundbar.
- If a part of your body is in contact with the Bluetooth transceiver or the product is installed on metal furniture, sound may drop out. Check the installation environment and conditions for use.

### Bluetooth multi connection does not work.

- When the TV is connected to the soundbar, Bluetooth multi connection may not operate. Disconnect the Soundbar from the TV and try again.
- Check whether the Bluetooth Multi connection setting is turned on. (Refer to the “**Soundbar does not connect via Bluetooth.**” section.)
- Disconnect the device currently playing, pair with the device that you want to connect, and reconnect the previous device.
- If the sound is inaudible even after connecting properly, refer to the “**Sound drops out when connected via Bluetooth.**” section.

### Soundbar does not turn on automatically with the TV.

- When you turn off the Soundbar while watching TV, power synchronization with the TV is disabled. First turn off the TV.

## 14 LICENSE



Manufactured under license from Dolby Laboratories. Dolby, Dolby Audio, and the double-D symbol are trademarks of Dolby Laboratories Licensing Corporation.



FOR DTS PATENTS, SEE [HTTP://XPERI.COM/DTS-PATENTS/](http://xperi.com/DTS-PATENTS/). MANUFACTURED UNDER LICENSE FROM DTS, INC. AND ITS AFFILIATES. DTS, THE DTS LOGO, DIGITAL SURROUND, VIRTUAL:X, AND THE DTS VIRTUAL:X LOGO ARE REGISTERED TRADEMARKS OR TRADEMARKS OF DTS, INC. AND ITS AFFILIATES IN THE UNITED STATES AND/OR OTHER COUNTRIES. © DTS, INC. AND ITS AFFILIATES. ALL RIGHTS RESERVED.



The terms HDMI, HDMI High-Definition Multimedia Interface, HDMI Trade dress and the HDMI Logos are trademarks or registered trademarks of HDMI Licensing Administrator, Inc.



The Bluetooth® word mark and logos are registered trademarks owned by Bluetooth SIG, Inc. and any use of such marks by Samsung Electronics Co., Ltd. is under license. Other trademarks and trade names are those of their respective owners.

---

# 15 OPEN SOURCE LICENSE NOTICE

Open Source used in this product can be found on the following webpage (<http://opensource.samsung.com>).

# 16 IMPORTANT NOTES ABOUT SERVICE

- Figures and illustrations in this Web User Guide are provided for reference only and may differ from actual product appearance.
- An administration fee may be charged if either:
  - a. An engineer is called out to your home at your request and there is no defect in the product.
  - b. You bring the unit to a repair center and there is no defect in the product.
- You will be advised of the amount of the administration fee before any work is done or a home visit is made.
- If you have a problem with this product, we strongly recommend you read the appropriate section of this manual, visit the Support page for your product at [www.samsung.com](http://www.samsung.com), or call Samsung Product Support (1-800-726-7864) to find an answer before you contact a service center for a repair

# 17 SPECIFICATIONS AND GUIDE

## Specifications

Model Name	HW-B630F
USB	5V/0.5A
Weight	4.9 lbs (2.2 kg)
Dimensions (W x H x D)	33.9 x 2.3 x 3.0 inches (860.0 x 59.4 x 75.0 mm)
Operating Temperature Range	+50°F to +104°F (+10°C to + 40°C)
Operating Humidity Range	10 % to 80 %, non-condensing
Storage Temperature Range	-4°F to +113°F (-20°C to +45°C)
Storage Humidity Range	5% to 95%, non-condensing
Supported play formats	LPCM 2ch, Dolby Audio™ (supporting Dolby® Digital), DTS, DTS Virtual:X

Subwoofer Name	PS-WF75B
Weight	11.0 lbs (5.0 kg)
Dimensions (W x H x D)	7.2 x 13.5 x 11.6 inches (184.0 x 343.0 x 295.0 mm)

## NOTES

- Samsung Electronics Co., Ltd reserves the right to change the specifications without notice.
- Weight and dimensions are approximate.

## LIMITED WARRANTY TO ORIGINAL CONSUMER PURCHASER WITH PROOF OF PURCHASE AND/OR PROOF OF DELIVERY

This SAMSUNG brand product, as supplied and distributed by SAMSUNG and delivered new, in the original carton to the original consumer purchaser, is warranted by SAMSUNG against manufacturing defects in materials and workmanship for a limited warranty period of:

### **One (1) Year Parts and Labor\*** **(\*90 Days Parts and Labor for Commercial Use)**

This limited warranty begins on the date of delivery to the original consumer purchaser, and is valid only on products purchased and used in the United States. To receive warranty service, the purchaser must contact SAMSUNG for problem determination and service procedures. Warranty service can only be performed by a SAMSUNG authorized service center. The original dated bill of sale and/or proof of delivery must be presented upon request to SAMSUNG or SAMSUNG'S authorized service center. Transportation of the product to and from the service center is the responsibility of the purchaser.

SAMSUNG will repair or replace this product, at our option and at no charge as stipulated herein, with new or reconditioned parts or products if found to be defective during the limited warranty period specified above. All replaced parts and products become the property of SAMSUNG and must be returned to SAMSUNG. Replacement parts and products assume the remaining original warranty, or ninety (90) days, whichever is longer. SAMSUNG'S obligations with respect to software products distributed by SAMSUNG under the SAMSUNG brand name are set forth in the applicable end user license agreement. Non-SAMSUNG hardware and software products, if provided, are on an "AS IS" basis.

Non-SAMSUNG manufacturers, suppliers, publishers, and service providers may provide their own warranties. This limited warranty covers manufacturing defects in materials and workmanship encountered in normal, and except to the extent otherwise expressly provided for in this statement, noncommercial use of this product, and shall not apply to the following, including, but not limited to: damage which occurs in shipment; delivery and installation; applications and uses for which this product was not intended; altered product or serial numbers; cosmetic damage or exterior finish; accidents, abuse, neglect, fire, water, lightning or other acts of nature; use of products, equipment, systems, utilities, services, parts, supplies, accessories, applications, installations, repairs, external wiring or connectors not supplied and authorized by SAMSUNG, or which damage this product or result in service problems; incorrect electrical line voltage, fluctuations and surges; customer adjustments and failure to follow operating instructions, cleaning, maintenance and environmental instructions that are covered and prescribed in the instruction book; product removal or reinstallation; reception problems and distortion related to noise, echo, interference or other signal transmission and delivery problems. SAMSUNG does not warrant uninterrupted or error-free operation of the product.

THERE ARE NO EXPRESS WARRANTIES OTHER THAN THOSE LISTED AND DESCRIBED ABOVE, AND NO WARRANTIES WHETHER EXPRESS OR IMPLIED, INCLUDING, BUT NOT LIMITED TO, ANY IMPLIED WARRANTIES OF MERCHANTABILITY OR FITNESS FOR A PARTICULAR PURPOSE, SHALL APPLY AFTER THE EXPRESS WARRANTY PERIODS STATED ABOVE, AND NO OTHER EXPRESS WARRANTY OR GUARANTY GIVEN BY ANY PERSON, FIRM OR CORPORATION WITH RESPECT TO THIS PRODUCT SHALL BE BINDING ON SAMSUNG. SAMSUNG SHALL NOT BE LIABLE FOR LOSS OF REVENUE OR PROFITS, FAILURE TO REALIZE SAVINGS OR OTHER BENEFITS, OR ANY OTHER SPECIAL, INCIDENTAL OR CONSEQUENTIAL DAMAGES CAUSED BY THE USE, MISUSE OR INABILITY TO USE THIS PRODUCT, REGARDLESS OF THE LEGAL THEORY ON WHICH THE CLAIM IS BASED, AND EVEN IF SAMSUNG HAS BEEN ADVISED OF THE POSSIBILITY OF SUCH DAMAGES. NOR SHALL RECOVERY OF ANY KIND AGAINST SAMSUNG BE GREATER IN AMOUNT THAN THE PURCHASE PRICE OF THE PRODUCT SOLD BY SAMSUNG AND CAUSING THE ALLEGED DAMAGE. WITHOUT LIMITING THE FOREGOING, PURCHASER ASSUMES ALL RISK AND LIABILITY FOR LOSS, DAMAGE OR INJURY TO PURCHASER AND PURCHASER'S PROPERTY AND TO OTHERS AND THEIR PROPERTY ARISING OUT OF THE USE, MISUSE OR INABILITY TO USE THIS PRODUCT SOLD BY SAMSUNG NOT CAUSED DIRECTLY BY THE NEGLIGENCE OF SAMSUNG. THIS LIMITED WARRANTY SHALL NOT EXTEND TO ANYONE OTHER THAN THE ORIGINAL PURCHASER OF THIS PRODUCT, IS NONTRANSFERABLE AND STATES YOUR EXCLUSIVE REMEDY.

Some states do not allow limitations on how long an implied warranty lasts, or the exclusion or limitation of incidental or consequential damages, so the above limitations or exclusions may not apply to you. This warranty gives you specific legal rights, and you may also have other rights which vary from state to state.

To obtain warranty service, please contact SAMSUNG customer care center.

The benefits of this Limited Warranty extend only to the original purchaser of Samsung products from an authorized Samsung reseller. THIS LIMITED WARRANTY SHALL NOT APPLY TO ANY SAMSUNG PRODUCTS PURCHASED FROM UNAUTHORIZED RESELLERS OR RETAILERS, EXCEPT IN STATES WHERE SUCH RESTRICTION MAY BE PROHIBITED. For a list of Samsung authorized retailers, please go to:

[http://www.samsung.com/us/peaceofmind/authorized\\_resellers.html](http://www.samsung.com/us/peaceofmind/authorized_resellers.html)

## QUESTIONS OR COMMENTS?

Samsung Service Center 	Website
1-800-SAMSUNG (726-7864)	<a href="http://www.samsung.com/us/support">www.samsung.com/us/support</a>