

hp LaserJet 4250/4350
series printers



i n v e n t

use



HP LaserJet 4250 or 4350 series printer

User Guide _____

Copyright and License

© 2004 Copyright Hewlett-Packard Development Company, L.P.

Reproduction, adaptation, or translation without prior written permission is prohibited, except as allowed under the copyright laws.

The information contained in this document is subject to change without notice.

The only warranties for HP products and services are set forth in the express warranty statements accompanying such products and services. Nothing herein should be construed as constituting an additional warranty. HP shall not be liable for technical or editorial errors or omissions contained herein.

Part number Q5400-90933

Edition 1, 11/2004

Trademark Credits

Adobe® and PostScript® are trademarks of Adobe Systems Incorporated.

Linux is a U.S. registered trademark of Linus Torvalds.

Microsoft®, Windows®, and Windows NT® are U.S. registered trademarks of Microsoft Corporation.

UNIX® is a registered trademark of The Open Group.

ENERGY STAR® and the ENERGY STAR logo® are U.S. registered marks of the United States Environmental Protection Agency.



HP customer care

Online services

For 24-hour access to information by using a modem or Internet connection

World Wide Web: Updated HP printer software, product and support information, and printer drivers in several languages can be obtained from <http://www.hp.com/support/lj4250> or <http://www.hp.com/support/lj4350>. (The site is in English.)

Online troubleshooting tools

HP Instant Support Professional Edition (ISPE) is a suite of Web-based troubleshooting tools for desktop computing and printing products. ISPE helps you quickly identify, diagnose, and resolve computing and printing problems. The ISPE tools are available at <http://instantsupport.hp.com>.

Telephone support

Hewlett-Packard Company provides free telephone support during the warranty period. When you call, you will be connected to a responsive team that is waiting to help you. For the telephone number for your country/region, see the flyer that came in the box with the product, or visit <http://www.hp.com/support/callcenters>. Before calling HP, have the following information ready: the product name and serial number, the date of purchase, and a description of the problem.

You can also find support on the Internet at <http://www.hp.com>. Click the **support & drivers** block.

Software utilities, drivers, and electronic information

Go to http://www.hp.com/go/lj4250_software or http://www.hp.com/go/lj4350_software. (The site is in English, but printer drivers can be downloaded in several languages.)

For information over the telephone, see the flyer that came in the box with the printer.

HP direct ordering for accessories or supplies

Order supplies from the following Web sites:

United States: <http://www.hp.com/sbso/product/supplies>

Canada: <http://www.hp.ca/catalog/supplies>

Europe: <http://www.hp.com/go/supplies>

Asia-Pacific: <http://www.hp.com/paper/>

Order accessories from <http://www.hp.com/support/lj4250> or <http://www.hp.com/support/lj4350>. For more information, see [Ordering parts, accessories, and supplies](#).

To order supplies or accessories over the telephone, call the following numbers:

United States businesses: 800-282-6672

United States small and medium businesses: 800-888-9909

United States home and home offices: 800-752-0900

Canada: 800-387-3154

To find the phone numbers for other countries/regions, see the flyer that came in the box with the printer.

HP service information

To locate HP-Authorized Dealers in the United States or Canada, call 800-243-9816 (United States) or 800-387-3867 (Canada). Or, go to <http://www.hp.com/go/cposupportguide>.

For service for your HP product in other countries/regions, call the customer support number for your country/region. See the flyer that came in the box with the printer.

HP service agreements

Call: 800-HPINVENT [800-474-6836 (U.S.)] or 800-268-1221 (Canada).

Out-of-Warranty Service: 800-633-3600.

Extended Service: Call: 800-HPINVENT [800-474-6836 (U.S.)] or 800-268-1221 (Canada).

Or, go to the HP Care Pack Services Web site at <http://www.hpexpress-services.com>.

HP Toolbox

To check the printer status and settings and to view troubleshooting information and online documentation, use the HP Toolbox software. You can view the HP Toolbox when the printer is directly connected to your computer or when it is connected to a network. You must have performed a complete software installation to use the HP Toolbox. See [Using the HP Toolbox](#).

HP support and information for Macintosh computers

Visit: <http://www.hp.com/go/macosex> for Macintosh OS X support information and HP subscription service for driver updates.

Visit: <http://www.hp.com/go/mac-connect> for products designed specifically for the Macintosh user.

Table of contents

1 Printer basics

Quick access to printer information	2
User guide links	2
Where to look for more information	2
Printer configurations	3
Feature designations for the HP LaserJet 4250 or 4350 series printer	3
Printer features	5
Printer parts	8
Accessories and supplies	8
Interface ports	10
Accessory lights	10
Moving the printer	11
Control panel	12
Control-panel layout	12
Control-panel buttons	13
Control-panel lights	13
Printing control-panel menus	14
Using the printer Help system	14
Changing printer-control-panel configuration settings	15
Software	26
Operating systems and printer components	26
Printer drivers	27
Software for Macintosh computers	30
Installing the printing system software	31
Uninstalling the software	36
Selecting print media	37
Supported sizes of print media	38

2 Printing tasks

Selecting which tray is used for printing	44
Understanding tray order	44
Customizing tray 1 operation	44
Printing by type and size of media (locking trays)	45
Manually feeding media from tray 1	46
Selecting the correct fuser mode	47
Stapling documents	48
To select the stapler in the software (Windows)	48
To select the stapler in the software (Mac)	48
To select the stapler at the control panel	48
Loading staples	49
Loading trays	50
Loading tray 1	50
Loading tray 2 or an optional 500-sheet tray	51
Loading an optional 1,500-sheet tray	53
Understanding media output options	56

Printing to the top (standard) output bin	56
Printing to the rear output bin	56
Printing to the optional stacker or stapler/stacker	57
Orientation of paper when a stapler is installed	58
Printing envelopes	59
Loading envelopes in tray 1	59
Feeding envelopes automatically (optional envelope feeder)	60
Installing the optional envelope feeder	60
Removing the optional envelope feeder	61
Loading envelopes in the optional envelope feeder	62
Printing on special media	64
Printing on labels	64
Printing on transparencies	65
Printing on letterhead, prepunched, or preprinted paper (single-sided)	65
Printing on paper that has a special finish	67
Printing on small sizes, custom sizes, or heavy paper	68
Setting custom paper sizes	69
Printing on both sides of paper (optional duplexer)	71
Guidelines for printing on both sides of paper	71
Orientation of paper for duplexing	72
Layout options for printing on both sides of paper	73
To duplex with the optional duplex-printing accessory	73
To duplex manually	74
Canceling a print job	75
Using the printer driver	76
Changing the settings for a print job	76
Changing default settings	76
Using printer-driver features	79
Printing watermarks	79
Printing multiple pages on one sheet of paper	80
Setting a custom paper size	80
Using EconoMode (draft) printing	81
Selecting print-quality settings	81
Using reduce/enlarge options	82
Selecting a paper source	82
Printing a cover, a different first or last page, or a blank page	83
Using job-storage features	84
Quick copying a job	84
Deleting a quick copy job	85
Proofing and holding a job	85
Deleting a held job	86
Printing a private job	86
Deleting a private job	87
Storing a print job	87

3 Managing and maintaining the printer

Using the embedded Web server	90
Opening the embedded Web server	90
Information tab	91
Settings tab	91
Networking tab	92
Other links	92
Using HP Web Jetadmin software	93
Using the HP Toolbox	94
Supported operating systems	94

Supported browsers	94
To view the HP Toolbox	95
Status tab	95
Troubleshooting tab	95
Alerts tab	96
Documentation tab	96
Device Settings window	96
Toolbox links	97
Other links	97
Uninstalling the HP Toolbox	98
To uninstall the HP Toolbox by using the Windows desktop shortcut	98
To uninstall the HP Toolbox by using Add/Remove Programs in the Windows control panel.....	98
Managing and configuring printer drivers	99
HP Web Jetadmin software plug-in	99
Customization utility	100
Configuring e-mail alerts	101
Setting the real-time clock	102
Setting the date and time	102
Checking the printer configuration	105
Menu map	105
Configuration page	105
Supplies status page	107
PS or PCL font list	107
Managing the print cartridge	109
HP print cartridges	109
Non-HP print cartridges	109
Print-cartridge authentication	109
Print-cartridge storage	109
Print-cartridge life expectancy	110
Checking the supply level	110
Cartridge-low and cartridge-out conditions	110
Cleaning the printer	112
Cleaning the inside of the printer	112
Cleaning the fuser	113
Performing preventive maintenance	115
To reset the maintenance-kit counter	115
Replacing the stapler unit	116
To remove and replace the stapler unit	116

4 Problem solving

Troubleshooting flowchart	120
1 Does the control panel display read READY?	120
2 Can you print a configuration page?	121
3 Can you print from a program?	122
4 Does the job print as expected?	124
5 Does the printer select the proper trays and paper-handling accessories?	126
Solving general printing problems	128
Guidelines for using paper	132
Printing special pages	133
Clearing jams	134
Jam locations	134
Clearing jams from the top-cover and print-cartridge areas	134
Clearing jams from the optional envelope feeder	136
Clearing jams from the trays	137

Clearing jams from the optional duplexer	140
Clearing jams from the output areas	141
Clearing jams from the fuser area	142
Clearing jams from the optional stacker or stapler/stacker	144
Solving repeated jams	146
Understanding printer messages	148
Using the printer online Help system	148
Resolving persistent messages	148
Understanding accessory lights for the stacker and stapler/stacker	169
Accessory lights	169
Replacing accessories or accessory components	171
Correcting print-quality problems	172
Print-quality checklist	172
Image defect examples	172
Light print (partial page)	174
Light print (entire page)	174
Specks	174
Dropouts	175
Lines	175
Gray background	176
Toner smear	176
Loose toner	177
Repeating defects	177
Repeating image	178
Misformed characters	178
Page skew	178
Curl or wave	179
Wrinkles or creases	179
Vertical white lines	180
Tire tracks	180
White spots on black	180
Scattered lines	181
Blurred print	181
Random image repetition	182
Troubleshooting network printing problems	183
Troubleshooting common Windows problems	184
Troubleshooting common Macintosh problems	185
Troubleshooting common PostScript problems	191
General problems	191
Specific errors	191
Troubleshooting the optional hard disk	193

Appendix A Supplies and accessories

Ordering parts, accessories, and supplies	196
Ordering directly from HP	196
Ordering through service or support providers	196
Ordering directly through the embedded Web server (for printers that are connected to a network)	196
Ordering directly through the HP Toolbox software (for printers that are directly connected to a computer)	197
Part numbers	198
Paper-handling accessories	198
Print cartridges	199
Maintenance kits	199
Memory	199

Cables and interfaces	200
Print media	200

Appendix B Control panel menus

Retrieve Job menu	206
Information menu	208
Paper Handling menu	209
Configure Device menu	213
Printing submenu	213
Print Quality submenu	216
System Setup submenu	220
Stapler/stacker submenu	224
I/O submenu	225
Resets submenu	226
Diagnostics menu	228
Service menu	229

Appendix C Specifications

HP LaserJet 4250 or 4350 series physical specifications	231
Electrical specifications	233
Acoustic emissions	234
Operating environment	235
Paper specifications	236
Printing and paper storage environment	236
Envelopes	237
Labels	239
Transparencies	239

Appendix D Printer memory and expansion

Overview	242
Printer memory	243
To install printer memory	243
Installing CompactFlash cards	246
To install a CompactFlash card	246
Checking memory installation	249
To verify that DIMMs or CompactFlash cards are installed correctly	249
Saving resources (permanent resources)	250
Installing EIO cards or mass storage devices	251
To install EIO cards or mass storage devices	251
To remove an installed EIO card or mass storage device (optional hard disk)	251

Appendix E Printer commands

Understanding PCL 6 and PCL 5e printer command syntax	254
Combining escape sequences	254
Using escape characters	255
Selecting PCL 6 and PCL 5 fonts	255
Common PCL 6 and PCL 5 printer commands	256

Appendix F Regulatory information

Introduction	261
FCC regulations	262
Environmental Product Stewardship program	263

Protecting the environment	263
Ozone production	263
Energy consumption	263
HP LaserJet printing supplies	263
Material safety data sheet	264
For more information	265
Declaration of conformity	266
Country-/region-specific safety statements	267
Laser safety statement	267
Canadian DOC statement	267
Japanese VCCI statement	267
Korean EMI statement	267
Finnish laser statement	268

Appendix G Service and support

Hewlett-Packard limited warranty statement	269
Print Cartridge Limited Warranty Statement	271
Availability of support and service	272
HP maintenance agreements	272
Onsite service agreements	272
HP Express Exchange (U.S. and Canada only)	273
To use HP Express Exchange	273
Repacking the printer	274
To repack the printer	274
Service information form	275

Index

1

Printer basics

Thank you for purchasing an HP LaserJet 4250 or 4350 series printer. If you have not done so, see the getting started guide (**start**) provided with the printer for setup instructions.

Now that the printer is set up and ready to use, take a few moments to familiarize yourself with the printer. This section provides information about the following topics:

- [Quick access to printer information](#)
- [Printer configurations](#)
- [Printer features](#)
- [Printer parts](#)
- [Control panel](#)
- [Software](#)
- [Selecting print media](#)

Quick access to printer information

This section summarizes the resources that are available to learn more about setting up and using the printer.

User guide links

- [Printer parts](#)
- [Control-panel layout](#)
- [Troubleshooting flowchart](#)

Where to look for more information

Several references are available for use with this printer. See <http://www.hp.com/support/lj4250> or <http://www.hp.com/support/lj4350>.

Setting up the printer

Getting started guide—Provides step-by-step instructions for installing and setting up the printer. This hard-copy guide is included with each printer.

HP Jetdirect Embedded Print Server Administrator's Guide—Contains information for configuring and troubleshooting an HP Jetdirect embedded print server. You can print a copy from the CD-ROM that came with the printer. (Available with models that include an HP Jetdirect embedded print server.)

Accessory installation guides—Provides step-by-step instructions for installing accessories, such as an optional tray. A hard-copy guide is supplied with each accessory.

Using the printer

User guide—Contains detailed information for using the printer and for troubleshooting problems. This guide is available on the CD-ROM that came with the printer. It is also available through the HP Toolbox software.

Online Help—Contains information about the printer options that are available from within the printer drivers. To view a Help file, open the online Help through the printer driver.

HTML (online) user guide—Contains detailed information for using the printer and for troubleshooting problems. Go to <http://www.hp.com/support/lj4250> or <http://www.hp.com/support/lj4350>. After connecting, click **Manuals**.

Printer control-panel Help—This printer features a Help system at the control panel that provides instructions for resolving most printer errors. To view Help for a message (if available), press ? (**HELP** button).

Printer configurations

The HP LaserJet 4250 or 4350 series printer is available in several configurations. The letters that follow the printer name indicate the differences between the configurations. Each letter refers to a specific feature. Use the information in this section to determine which features your model has.

NOTE

Not all models are available in all configurations.

Feature designations for the HP LaserJet 4250 or 4350 series printer

Letter	Description
no letter	This is the base model.
d	Models with this designation include a duplexing unit for automatic two-sided printing.
n	Models with this designation include an embedded HP Jetdirect print server for connecting to a 10/100Base-T network.
t	Models with this designation include an additional paper tray.
sl	Models with this designation include a stapler/stacker.

Model descriptions

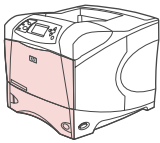
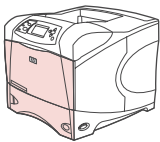
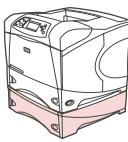
Printer model	HP LaserJet 4250 series	HP LaserJet 4350 series
Base model 	<ul style="list-style-type: none"> 48 MB RAM, expandable up to 512 MB one 100-sheet tray and one 500-sheet tray 	
n model 	<ul style="list-style-type: none"> 64 MB RAM, expandable up to 512 MB one 100-sheet tray and one 500-sheet tray HP Jetdirect embedded print server for connecting to a 10/100Base-TX network 	<ul style="list-style-type: none"> 80 MB RAM, expandable up to 512 MB one 100-sheet tray and one 500-sheet tray HP Jetdirect embedded print server for connecting to a 10/100Base-TX network
tn model 	<ul style="list-style-type: none"> 64 MB RAM, expandable up to 512 MB one 100-sheet tray and two 500-sheet trays HP Jetdirect embedded print server for connecting to a 10/100Base-TX network 	<ul style="list-style-type: none"> 80 MB RAM, expandable up to 512 MB one 100-sheet tray and two 500-sheet trays HP Jetdirect embedded print server for connecting to a 10/100Base-TX network

Model descriptions (continued)

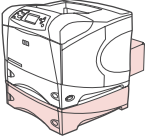
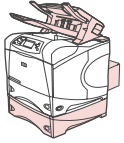
Printer model	HP LaserJet 4250 series	HP LaserJet 4350 series
<p>dtn model</p> 	<ul style="list-style-type: none"> ● 64 MB RAM, expandable up to 512 MB ● one 100-sheet tray and two 500-sheet trays ● HP Jetdirect embedded print server for connecting to a 10/100Base-TX network ● duplexer for automatic two-sided printing 	<ul style="list-style-type: none"> ● 80 MB RAM, expandable up to 512 MB ● one 100-sheet tray and two 500-sheet trays ● HP Jetdirect embedded print server for connecting to a 10/100Base-TX network ● duplexer for automatic two-sided printing
<p>dtntl model</p> 	<ul style="list-style-type: none"> ● 64 MB RAM, expandable up to 512 MB ● one 100-sheet tray and two 500-sheet trays ● HP Jetdirect embedded print server for connecting to a 10/100Base-TX network ● duplexer for automatic two-sided printing ● 500-sheet stapler/stacker output accessory 	<ul style="list-style-type: none"> ● 80 MB RAM, expandable up to 512 MB ● one 100-sheet tray and two 500-sheet trays ● HP Jetdirect embedded print server for connecting to a 10/100Base-TX network ● duplexer for automatic two-sided printing ● 500-sheet stapler/stacker output accessory

Printer features

The following tables describe the features for the HP LaserJet 4250 or 4350 series printers.

Speed

HP LaserJet 4250 series printer	HP LaserJet 4350 series printer
Prints on letter-size paper at 45 pages per minute (ppm).	Prints on letter-size paper at 55 pages per minute (ppm).
Prints on A4-size paper at 43 ppm.	Prints on A4-size paper at 52 ppm.

Resolution

HP LaserJet 4250 series printer	HP LaserJet 4350 series printer
FastRes 1200—produces 1200-dpi print quality for fast, high-quality printing of business text and graphics.	FastRes 1200—produces 1200-dpi print quality for fast, high-quality printing of business text and graphics.
ProRes 1200—produces 1200-dpi printing for the best quality in line art and graphic images.	ProRes 1200—produces 1200-dpi printing for the best quality in line art and graphic images.
HP LaserJet cartridges for crisp, sharp output.	HP LaserJet cartridges for crisp, sharp output.

Paper handling

HP LaserJet 4250 series printer	HP LaserJet 4350 series printer
HP LaserJet 4250tn, dtn, and dtntl models hold up to 1,100 sheets of paper. All other models hold 600 sheets of paper.	HP LaserJet 4350tn, dtn, and dtntl models hold up to 1,100 sheets of paper. All other models hold 600 sheets of paper.
All models are compatible with additional 500-sheet paper feeders and an optional 1,500-sheet high-capacity input tray. When the maximum number of trays are installed, all models can hold up to 3,100 sheets of paper.	All models are compatible with additional 500-sheet paper feeders and an optional 1,500-sheet high-capacity input tray. When the maximum number of trays are installed, all models can hold up to 3,100 sheets of paper.
HP LaserJet 4250dtn and dtntl models include a duplex printing accessory for automatic two-sided printing. All other models are compatible with the optional duplex printing accessory.	HP LaserJet 4350dtn and dtntl models include a duplex printing accessory for automatic two-sided printing. All other models are compatible with the optional duplex printing accessory.
HP LaserJet 4250dtntl model includes a stapler/stacker that staples up to 15 sheets of paper and stacks up to 500 sheets of paper. All other models are compatible with the optional stapler/stacker.	HP LaserJet 4350dtntl model includes a stapler/stacker that staples up to 15 sheets of paper and stacks up to 500 sheets of paper. All other models are compatible with the optional stapler/stacker.
All models are compatible with an optional 500-sheet stacking accessory.	All models are compatible with an optional 500-sheet stacking accessory.
All models are compatible with the optional envelope feeder that can feed up to 75 envelopes	All models are compatible with the optional envelope feeder that can feed up to 75 envelopes

Memory and processor

HP LaserJet 4250 series printer	HP LaserJet 4350 series printer
<p>The HP LaserJet 4250 model includes 48 MB of random-access memory (RAM). The HP LaserJet 4250n and tn models include 64 MB of RAM. The HP LaserJet 4250dtn and dtntl models include 80 MB RAM.</p> <p>All models are expandable up to 512 MB maximum memory</p> <p>460-megahertz (MHz) processor speed</p> <p>All models are compatible with an optional EIO hard disk.</p>	<p>The HP LaserJet 4350n and tn models include 80 MB of random-access memory (RAM). The HP LaserJet 4350dtn and dtntl models include 96 MB RAM.</p> <p>All models are expandable up to 512 MB maximum memory</p> <p>460-megahertz (MHz) processor speed</p> <p>All models are compatible with an optional EIO hard disk.</p>

Interface connections and networking

HP LaserJet 4250 series printer	HP LaserJet 4350 series printer
<p>All models include a bidirectional, extended capabilities port (ECP) type-B (IEEE 1284-compliant) parallel connection</p> <p>All models include a Universal Serial Bus (USB) 2.0 connection</p> <p>All models include two PCI-based enhanced input/output (EIO) expansion slots</p> <p>All models include an HP Jetlink port for connecting to optional paper-handling devices</p> <p>HP LaserJet 4250n, tn, dtn, and dtntl models include an HP Jetdirect embedded print server for connecting to a 10/100Base-TX network.</p> <p>All models are compatible with an optional 802.11b wireless network card.</p>	<p>All models include a bidirectional, ECP type-B (IEEE 1284-compliant) parallel connection</p> <p>All models include a USB 2.0 connection</p> <p>All models include two PCI-based enhanced input/output (EIO) expansion slots</p> <p>All models include an HP Jetlink port for connecting to optional paper-handling devices</p> <p>HP LaserJet 4350n, tn, dtn, and dtntl models include an HP Jetdirect embedded print server for connecting to a 10/100Base-TX network.</p> <p>All models are compatible with an optional 802.11b wireless network card.</p>

Language and fonts

HP LaserJet 4250 series printer	HP LaserJet 4350 series printer
<p>HP PCL6, PCL 5, and HP PostScript® (PS) 3 emulation</p> <p>80 fonts for Microsoft® Windows®</p> <p>Additional fonts can be added by installing a CompactFlash font card.</p>	<p>HP PCL6, PCL 5, and PostScript® (PS) 3 emulation</p> <p>80 fonts for Microsoft® Windows®</p> <p>Additional fonts can be added by installing a CompactFlash font card.</p>

Print cartridge

HP LaserJet 4250 series printer	HP LaserJet 4350 series printer
Standard print cartridge prints up to 10,000 pages. All models accept a high-capacity print cartridge that prints up to 20,000 pages. HP smart printing supplies program automatically alerts when toner is low.	Standard print cartridge prints up to 10,000 pages. All models accept a high-capacity print cartridge that prints up to 20,000 pages. HP smart printing supplies program automatically alerts when toner is low.

Energy savings

HP LaserJet 4250 series printer	HP LaserJet 4350 series printer
The printer automatically conserves electricity by reducing power consumption when it is not printing. As an ENERGY STAR® partner, Hewlett-Packard Company has determined that this product meets ENERGY STAR® guidelines for energy efficiency.	The printer automatically conserves electricity by reducing power consumption when it is not printing. As an ENERGY STAR® partner, Hewlett-Packard Company has determined that this product meets ENERGY STAR® guidelines for energy efficiency.

Economical printing

HP LaserJet 4250 series printer	HP LaserJet 4350 series printer
N-up printing (multiple pages on one sheet) saves paper. Duplex printing (automatic or manual) saves paper. Printing in EconoMode saves toner.	N-up printing (multiple pages on one sheet) saves paper. Duplex printing (automatic or manual) saves paper. Printing in EconoMode saves toner.

Accessibility

HP LaserJet 4250 series printer	HP LaserJet 4350 series printer
The online user guide is compatible with text screen-readers. The print cartridge can be inserted and removed by using one hand. All doors and covers can be opened by using one hand. All media-width guides can be adjusted by using one hand.	The online user guide is compatible with text screen-readers. The print cartridge can be inserted and removed by using one hand. All doors and covers can be opened by using one hand. All media-width guides can be adjusted by using one hand.

Printer parts

Before using the printer, familiarize yourself with the parts of the printer.

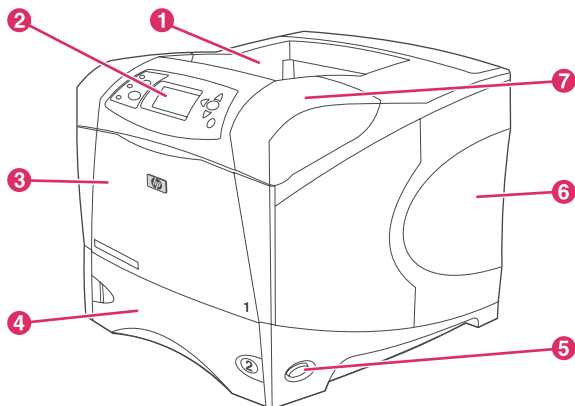

- 1 Top output bin
- 2 Control panel
- 3 Tray 1 (pull to open)
- 4 Tray 2
- 5 On/off switch
- 6 Right-side panel (provides access to DIMMs and CompactFlash cards)
- 7 Top cover (provides access to the print cartridge)

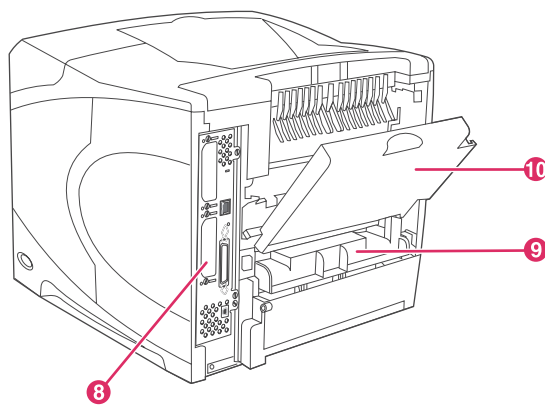

- 8 Interface ports (see [Interface ports](#))
- 9 Slot for optional duplexer
- 10 Rear output bin (pull to open)

Accessories and supplies

You can increase the capabilities of the printer by adding optional accessories. For information about ordering accessories and supplies, see [Ordering parts, accessories, and supplies](#).

NOTE

Use the accessories and supplies that have been specifically designed for the printer in order to ensure optimum performance. The printer supports two EIO cards.

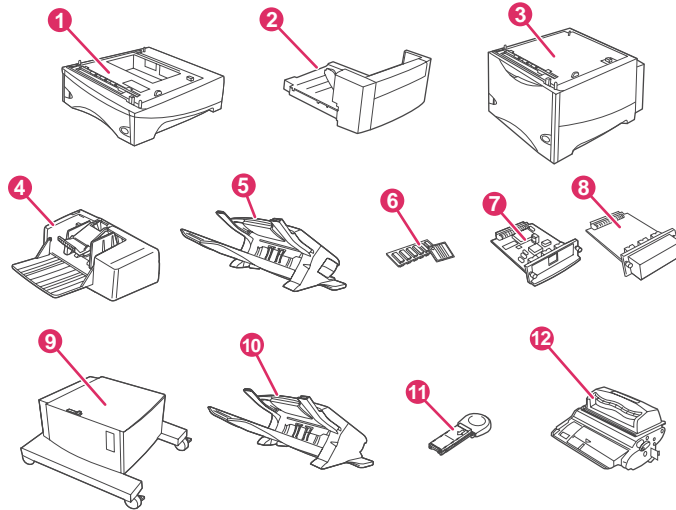

- 1 500-sheet tray and feeder* (Q2440B)
- 2 Duplexer (duplex printing accessory) for two-sided printing (Q2439B)
- 3 1,500-sheet tray and feeder* (Q2444B)
- 4 Envelope feeder (Q2438B)
- 5 Stapler/stacker accessory (Q2443B)
- 6 Dual inline memory module (DIMM) or CompactFlash font card
- 7 HP Jetdirect print server (EIO card)
- 8 Hard disk accessory (EIO card) (J6054B)
- 9 Storage cabinet for the printer (Q2445B)
- 10 Stacker accessory (Q2442B)
- 11 Staple cartridge (Q3216A)
- 12 Print cartridge (Q5942A: 10,000-page cartridge or Q5942X: 20,000-page cartridge)

* The paper capacity of any HP LaserJet 4250 or 4350 series printer can be expanded to a maximum of 3,100 sheets, achieved by installing up to two additional 500-sheet feeders and one optional 1,500-sheet feeder.

NOTE

The printer can accept up to three optional trays in either of the following configurations: three 500-sheet feeders or two 500-sheet feeders and one 1,500-sheet input tray.

Interface ports

The printer has five ports: two EIO slots and three ports for connecting to a computer or a network.

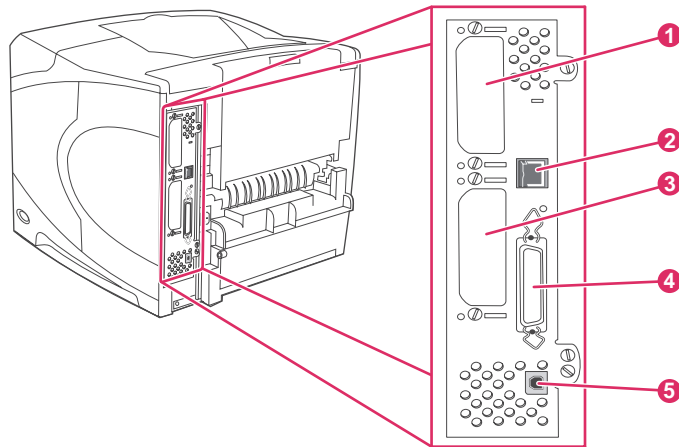

- 1 EIO slot 2
- 2 Network connection (for models that include an embedded HP Jetdirect print server)
- 3 EIO slot 1
- 4 IEEE 1284B-compliant parallel port
- 5 USB port (compatible with USB 2.0 full- and high-speed devices)

Accessory lights

Use the following table to interpret the status lights on the optional 500-sheet stacker or 500-sheet stapler/stacker accessory.

Light	Meaning for accessory
Solid green	<ul style="list-style-type: none">• The accessory is on and ready.
Solid amber	<ul style="list-style-type: none">• The accessory is experiencing a hardware malfunction. (See Understanding accessory lights for the stacker and stapler/stacker.)
Blinking amber	<ul style="list-style-type: none">• The accessory has an error condition that needs attention. (See Understanding accessory lights for the stacker and stapler/stacker.)
Off	<ul style="list-style-type: none">• The printer might be in PowerSave mode. Press any button on the printer control panel.• The accessory has an error condition that needs attention. (See Understanding accessory lights for the stacker and stapler/stacker.)

Moving the printer

The printer is heavy and should be lifted by two people. One person should stand at the front of the printer, and the other person should stand at the back of the printer. To lift the printer, grip the lift handles that are on the sides of the printer. Do not attempt to lift the printer by gripping any other part of the printer. If the bottom of the printer is attached to an optional accessory (such as a 500-sheet feeder, a 1,500-sheet feeder, or a storage cabinet), the accessory latches must be unlocked before moving the printer.

WARNING!

To prevent possible injury to yourself or damage to the printer, separate the printer from any currently installed optional accessories (for example, an optional feeder or a stapler/stacker) before lifting the printer.

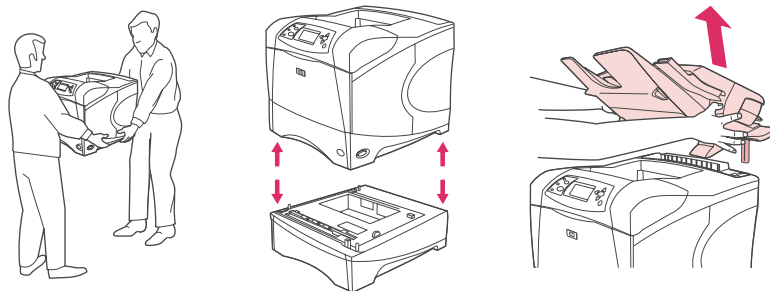

Locking and unlocking optional accessories

For more stability to prevent the printer from tipping over, the optional 500-sheet feeders, the optional 1,500-sheet tray, and the cabinet can be locked to the bottom of the printer.

To lock the accessories, locate the lever on the upper left side of the optional feeder, and rotate the lever to the rear (locked) position.

To unlock the accessories, rotate the lever to the forward (unlocked) position.

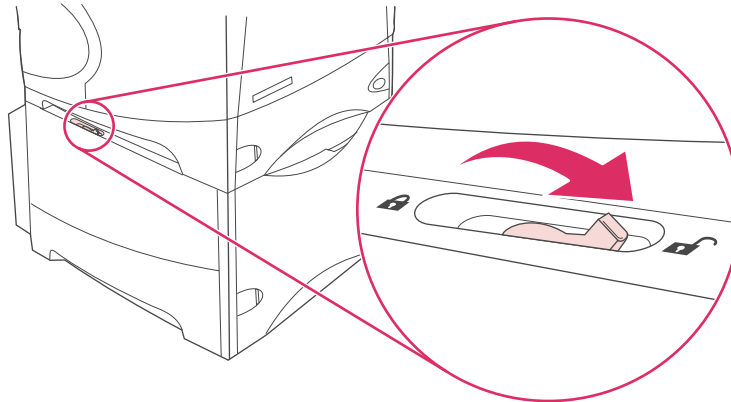

Control panel

This section provides information about the control panel and its features:

- [Control-panel layout](#)
- [Control-panel buttons](#)
- [Control-panel lights](#)
- [Printing control-panel menus](#)
- [Changing printer-control-panel configuration settings](#)
- [Using the printer Help system](#)

The control panel is located on the front of the printer.

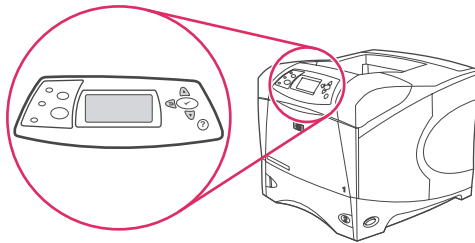

See [Interpreting control-panel messages](#) to identify and troubleshoot control-panel messages.

Control-panel layout

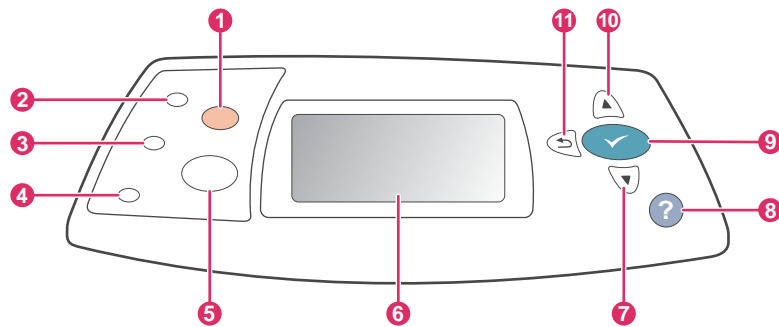

- 1 **STOP** button
- 2 Ready light
- 3 Data light
- 4 Attention light
- 5 **MENU** button
- 6 Graphical display
- 7 **DOWN** button
- 8 **HELP** button
- 9 **SELECT** button
- 10 **UP** button
- 11 **BACK** button

Control-panel buttons

Button	Function
? (HELP)	<ul style="list-style-type: none"> Provides information about the message on the graphical display.
↶ (BACK)	<ul style="list-style-type: none"> Backs up one level in the menu tree or backs up one numeric entry. Exits menus if held down for more than 1 second.
MENU	<ul style="list-style-type: none"> Enters and exits the menus.
▲ (UP)	<ul style="list-style-type: none"> Navigates to the previous item in the list, or increases the value of items that are numerical in nature.
✓ (SELECT)	<ul style="list-style-type: none"> Clears an error condition when the condition is clearable. Saves the selected value for an item. Performs the action that is associated with the item that is highlighted on the graphical display.
▼ (DOWN)	<ul style="list-style-type: none"> Navigates to the next item in the list, or decreases the value of items that are numerical in nature.
STOP	<ul style="list-style-type: none"> Cancels the current print job in process and expels all of the active pages from the paper path. The time that it takes to cancel the job depends on the size of the print job. (Press the button only once.) Also clears continuable errors that are associated with the canceled job. <hr/> <p>NOTE</p> <p>The control panel lights cycle while the print job is cleared from both the printer and the computer, and then the printer returns to the ready state (Ready light on).</p> <hr/>

Control-panel lights

Light	State	Indication
Ready	On	The printer is online and ready to accept data to print.
	Off	The printer cannot accept data because it is offline (paused) or has experienced an error.
	Blinking	The printer is going offline. The printer stops processing the current print job and expels all of the active pages from the paper path.

Light	State	Indication
Data	On	The printer has data to print, but is waiting to receive all of the data.
	Off	The printer has no data to print.
	Blinking	The printer is processing or printing the data.
Attention	On	The printer has experienced a problem. Note the message on the control-panel display, and then turn the printer off and on. See Interpreting control-panel messages for help in resolving problems.
	Off	The printer is functioning without error.
	Blinking	Action is required. See the control-panel display.

Printing control-panel menus

To see the current settings for the menus and items that are available at the control panel, print a control-panel menu map. You might want to store the menu map near the printer for reference.

NOTE

For a complete list of the items that are available in the control-panel menus, see [Control panel menus](#).

To print a control-panel menu map

1. Press **MENU** to open the menus.
2. Use ▲ (**UP** button) or ▼ (**DOWN** button) to scroll to **INFORMATION**, and then press ✓ (**SELECT** button).
3. Use ▲ (**UP** button) or ▼ (**DOWN** button) to scroll to **PRINT MENU MAP**, and then press ✓ (**SELECT** button).

Using the printer Help system

This printer features a Help system at the control panel that provides instructions for resolving most printer errors.

To view Help for a message (if available), press ? (**HELP** button). If the Help topic is longer than four lines, use the ▲ (**UP** button) or ▼ (**DOWN** button) to scroll through the entire topic.

To exit the Help system, press ? (**HELP** button) again.

Changing printer-control-panel configuration settings

By using the printer control panel, you can make changes to general printer configuration default settings such as tray size and type, sleep delay, printer personality (language), and jam recovery.

The printer-control-panel settings can also be changed from a computer by using the setting page of the embedded Web server. The computer shows the same information that the control panel shows. For more information, see [Using the embedded Web server](#).

CAUTION

Configuration settings seldom need to be changed. Hewlett-Packard Company recommends that only the system administrator change configuration settings.

Changing control-panel settings

For a complete list of menu items and possible values, see [Control panel menus](#). Certain menu options appear only if the associated tray or accessory is installed. For example, the **EIO** menu appears only if an EIO card is installed.

To change a control-panel setting

1. Press **MENU** to open the menu.
2. Use ▲ (**UP** button) or ▼ (**DOWN** button) to scroll to the menu that you want, and then press ✓ (**SELECT** button).
3. Some menus might have several submenus. Use ▲ (**UP** button) or ▼ (**DOWN** button) to scroll to the submenu item that you want, and then press ✓ (**SELECT** button).
4. Use ▲ (**UP** button) or ▼ (**DOWN** button) to scroll to the setting, and then press ✓ (**SELECT** button). Some settings change rapidly if ▲ (**UP** button) or ▼ (**DOWN** button) is held down. An asterisk (*) appears next to the selection on the display, indicating that it is now the default.
5. Press **MENU** to exit the menu.

NOTE

Printer-driver settings override control-panel settings. Software program settings override both printer-driver settings and control-panel settings. If you cannot gain access to a menu or item, it is either not an option for the printer or you have not turned on the associated higher-level option. See your network administrator if a function has been locked (**Access denied menus locked** appears on the printer control-panel display).

Job storage limit

This option sets the limit for the maximum number of jobs that can be stored on the hard drive at the printer. The maximum number allowed is 100, and the default value is 32.

NOTE

This option is only available if a hard drive is installed.

To set the job storage limit

1. Press **MENU** to open the menus.
2. Press ▼ (**DOWN** button) to highlight **CONFIGURE DEVICE**.
3. Press ✓ (**SELECT** button) to select **CONFIGURE DEVICE**.
4. Press ▼ (**DOWN** button) to highlight **SYSTEM SETUP**.
5. Press ✓ (**SELECT** button) to select **SYSTEM SETUP**.
6. Press ✓ (**SELECT** button) to select **JOB STORAGE LIMIT**.
7. Press ▲ (**UP** button) or ▼ (**DOWN** button) to change the value.
8. Press ✓ (**SELECT** button) to set the value.
9. Press **MENU** to exit the menu.

Job held timeout

This option sets the period of time that the system keeps files in job storage before deleting them from the queue. The default setting for this option is **OFF**; the other available settings are **1 HOUR**, **4 HOURS**, **1 DAY**, and **1 WEEK**.

NOTE

This option is only available if a hard drive is installed.

To set the job held timeout

1. Press **MENU** to open the menus.
2. Press ▼ (**DOWN** button) to highlight **CONFIGURE DEVICE**.
3. Press ✓ (**SELECT** button) to select **CONFIGURE DEVICE**.
4. Press ▼ (**DOWN** button) to highlight **SYSTEM SETUP**.
5. Press ✓ (**SELECT** button) to select **SYSTEM SETUP**.
6. Press ▼ (**DOWN** button) to highlight **JOB HELD TIMEOUT**.
7. Press ✓ (**SELECT** button) to select **JOB HELD TIMEOUT**.
8. Press ▲ (**UP** button) or ▼ (**DOWN** button) to select the appropriate time period.
9. Press ✓ (**SELECT** button) to set the time period.
10. Press **MENU** to exit the menu.

Show address

This item determines whether the printer's IP address appears on the display with the **Ready** message. If more than one EIO card is installed, the IP address of the card that is installed in the first slot appears.

To show the IP address

1. Press **MENU** to open the menu.
2. Press **▼** (**DOWN** button) to highlight **CONFIGURE DEVICE**.
3. Press **✓** (**SELECT** button) to select **CONFIGURE DEVICE**.
4. Press **▼** (**DOWN** button) to highlight **SYSTEM SETUP**.
5. Press **✓** (**SELECT** button) to select **SYSTEM SETUP**.
6. Press **▼** (**DOWN** button) to highlight **SHOW ADDRESS**.
7. Press **✓** (**SELECT** button) to select **SHOW ADDRESS**.
8. Press **▲** (**UP** button) or **▼** (**DOWN** button) to select the desired option.
9. Press **✓** (**SELECT** button) to select the option.
10. Press **MENU** to exit the menu.

Tray behavior options

Four user-defined options are available for tray behavior:

- **USE REQUESTED TRAY.** Selecting **EXCLUSIVELY** ensures that the printer does not automatically select another tray when you indicate that a specific tray should be used. Selecting **FIRST** allows the printer to pull from a second tray if the specified tray is empty. **EXCLUSIVELY** is the default setting.
- **MANUALLY FEED PROMPT.** If you select **ALWAYS** (the default value), the system always shows a prompt before pulling from the multipurpose tray. If you select **UNLESS LOADED**, the system displays the prompt only if the multipurpose tray is empty.
- **PS DEFER MEDIA.** This setting affects how non-HP PostScript drivers behave with the printer. You do not need to change this setting if you use the drivers that HP supplies. If set to **ENABLED**, non-HP PostScript drivers use the same HP tray selection method as the HP drivers. If set to **DISABLED**, some non-HP PostScript drivers use the PostScript tray selection method instead of the HP method.
- **SIZE/TYPE PROMPT.** Use this item to control whether the tray configuration message and its corresponding prompts are shown whenever a tray is opened and closed. These prompts instruct you to change the type or size if the tray is configured for a different type or size than is loaded in the tray.

To set Use Requested Tray

1. Press **MENU** to open the menus.
2. Press ▼ (**DOWN** button) to highlight **CONFIGURE DEVICE**.
3. Press ✓ (**SELECT** button) to select **CONFIGURE DEVICE**.
4. Press ▼ (**DOWN** button) to highlight **SYSTEM SETUP**.
5. Press ✓ (**SELECT** button) to select **SYSTEM SETUP**.
6. Press ▼ (**DOWN** button) to highlight **TRAY BEHAVIOR**.
7. Press ✓ (**SELECT** button) to select **TRAY BEHAVIOR**.
8. Press ✓ (**SELECT** button) to select **USE REQUESTED TRAY**.
9. Press ▲ (**UP** button) or ▼ (**DOWN** button) to select **EXCLUSIVELY** or **FIRST**.
10. Press ✓ (**SELECT** button) to set the behavior.
11. Press **MENU** to exit the menu.

To set Manually Feed Prompt

1. Press **MENU** to open the menus.
2. Press ▼ (**DOWN** button) to highlight **CONFIGURE DEVICE**.
3. Press ✓ (**SELECT** button) to select **CONFIGURE DEVICE**.
4. Press ▼ (**DOWN** button) to highlight **SYSTEM SETUP**.
5. Press ✓ (**SELECT** button) to select **SYSTEM SETUP**.
6. Press ▼ (**DOWN** button) to highlight **TRAY BEHAVIOR**.
7. Press ✓ (**SELECT** button) to select **TRAY BEHAVIOR**.
8. Press ▼ (**DOWN** button) to highlight **MANUALLY FEED PROMPT**.
9. Press ✓ (**SELECT** button) to select **MANUALLY FEED PROMPT**.
10. Press ▲ (**UP** button) or ▼ (**DOWN** button) to select **ALWAYS** or **UNLESS LOADED**.
11. Press ✓ (**SELECT** button) to set the behavior.
12. Press **MENU** to exit the menu.

To set the printer default for PS Defer Media

1. Press **MENU** to open the menus.
2. Press ▼ (**DOWN** button) to highlight **CONFIGURE DEVICE**.
3. Press ✓ (**SELECT** button) to select **CONFIGURE DEVICE**.
4. Press ▼ (**DOWN** button) to highlight **SYSTEM SETUP**.
5. Press ✓ (**SELECT** button) to select **SYSTEM SETUP**.
6. Press ▼ (**DOWN** button) to highlight **TRAY BEHAVIOR**.
7. Press ✓ (**SELECT** button) to select **TRAY BEHAVIOR**.
8. Press ✓ (**SELECT** button) to select **PS DEFER MEDIA**.
9. Press ▲ (**UP** button) or ▼ (**DOWN** button) to select **ENABLED** or **DISABLED**.
10. Press ✓ (**SELECT** button) to set the behavior.
11. Press **MENU** to exit the menu.

To set Size/type prompt

1. Press **MENU** to open the menus.
2. Press ▼ (**DOWN** button) to highlight **CONFIGURE DEVICE**.
3. Press ✓ (**SELECT** button) to select **CONFIGURE DEVICE**.
4. Press ▼ (**DOWN** button) to highlight **SYSTEM SETUP**.
5. Press ✓ (**SELECT** button) to select **SYSTEM SETUP**.
6. Press ▼ (**DOWN** button) to highlight **TRAY BEHAVIOR**.
7. Press ✓ (**SELECT** button) to select **TRAY BEHAVIOR**.
8. Press ✓ (**SELECT** button) to select **SIZE/TYPE PROMPT**.
9. Press ▲ (**UP** button) or ▼ (**DOWN** button) to select **DISPLAY** or **DO NOT DISPLAY**.
10. Press ✓ (**SELECT** button) to set the behavior.
11. Press **MENU** to exit the menu.

Sleep Delay

The adjustable Sleep Delay feature reduces power consumption when the printer has been inactive for an extended period. You can set the length of time before the printer goes into sleep mode to **1 MINUTE**, **15 MINUTES**, **30 MINUTES**, or to **60 MINUTES**, **90 MINUTES**, **2 HOURS**, or **4 HOURS**. The default setting is **30 MINUTES**.

NOTE

The printer control-panel display dims when the printer is in sleep mode. Sleep mode does not affect printer warm-up time unless the printer was in sleep mode for more than 8 hours.

To set the Sleep Delay

1. Press **MENU** to open the menus.
2. Press ▼ (**DOWN** button) to highlight **CONFIGURE DEVICE**.
3. Press ✓ (**SELECT** button) to select **CONFIGURE DEVICE**.
4. Press ▼ (**DOWN** button) to highlight **SYSTEM SETUP**.
5. Press ✓ (**SELECT** button) to select **SYSTEM SETUP**.
6. Press ▼ (**DOWN** button) to highlight **SLEEP DELAY**.
7. Press ✓ (**SELECT** button) to select **SLEEP DELAY**.
8. Press ▲ (**UP** button) or ▼ (**DOWN** button) to select the appropriate time period.
9. Press ✓ (**SELECT** button) to set the time period.
10. Press **MENU** to exit the menu.

To turn the Sleep Mode on or off

1. Press **MENU** to open the menus.
2. Press ▼ (**DOWN** button) to highlight **CONFIGURE DEVICE**.
3. Press ✓ (**SELECT** button) to select **CONFIGURE DEVICE**.
4. Press ▼ (**DOWN** button) to highlight **RESETS**.
5. Press ✓ (**SELECT** button) to select **RESETS**.
6. Press ▼ (**DOWN** button) to highlight **SLEEP MODE**.
7. Press ✓ (**SELECT** button) to select **SLEEP MODE**.
8. Press ▲ (**UP** button) or ▼ (**DOWN** button) to select **ON** or **OFF**.
9. Press ✓ (**SELECT** button) to set the selection.
10. Press **MENU** to exit the menu.

Personality

This printer features automatic personality (printer language) switching.

- **AUTO** configures the printer to automatically detect the type of print job and configure its personality to accommodate that job. This is the default setting. Use this setting unless you are experiencing problems.
- **PCL** configures the printer to use Printer Control Language.
- **PDF** configures the printer to print .PDF files. (This option is only available the printer has sufficient memory.)
- **PS** configures the printer to use PostScript emulation.

To set the personality

1. Press **MENU** to open the menu.
2. Press ▼ (**DOWN** button) to highlight **CONFIGURE DEVICE**.
3. Press ✓ (**SELECT** button) to select **CONFIGURE DEVICE**.
4. Press ▼ (**DOWN** button) to highlight **SYSTEM SETUP**.
5. Press ✓ (**SELECT** button) to select **SYSTEM SETUP**.
6. Press ▼ (**DOWN** button) to highlight **PERSONALITY**.
7. Press ✓ (**SELECT** button) to select **PERSONALITY**.
8. Press ▲ (**UP** button) or ▼ (**DOWN** button) to select the appropriate personality (**AUTO**, **PS**, **PCL**, or **PDF**).
9. Press ✓ (**SELECT** button) to set the personality.
10. Press **MENU** to exit the menu.

Clearable warnings

You can determine the display time for control-panel clearable warnings with this option by selecting **ON** or **JOB**. The default value is **JOB**.

- Select **ON** to show clearable warnings until you press ✓ (**SELECT** button).
- Select **JOB** to show clearable warnings until the end of the job in which they were generated.

To set the clearable warnings

1. Press **MENU** to open the menu.
2. Press ▼ (**DOWN** button) to highlight **CONFIGURE DEVICE**.
3. Press ✓ (**SELECT** button) to select **CONFIGURE DEVICE**.
4. Press ✓ (**SELECT** button) to highlight **SYSTEM SETUP**.
5. Press ✓ (**SELECT** button) to select **SYSTEM SETUP**.
6. Press ▼ (**DOWN** button) to highlight **CLEARABLE WARNINGS**.
7. Press ✓ (**SELECT** button) to select **CLEARABLE WARNINGS**.
8. Press ▲ (**UP** button) or ▼ (**DOWN** button) to select the appropriate setting.
9. Press ✓ (**SELECT** button) to set the selection.
10. Press **MENU** to exit the menu.

Auto continue

You can determine printer behavior when the system generates an Auto Continuable error. **ON** is the default setting.

- Select **ON** if you want an error message to appear for ten seconds before the printer automatically continues to print.
- Select **OFF** to pause printing any time an error message appears and until you press ✓ (**SELECT** button).

To set the auto continue

1. Press **MENU** to open the menus.
2. Press ▼ (**DOWN** button) to highlight **CONFIGURE DEVICE**.
3. Press ✓ (**SELECT** button) to select **CONFIGURE DEVICE**.
4. Press ▼ (**DOWN** button) to highlight **SYSTEM SETUP**.
5. Press ✓ (**SELECT** button) to select **SYSTEM SETUP**.
6. Press ▼ (**DOWN** button) to highlight **AUTO CONTINUE**.
7. Press ✓ (**SELECT** button) to select **AUTO CONTINUE**.
8. Press ▲ (**UP** button) or ▼ (**DOWN** button) to select the appropriate setting.
9. Press ✓ (**SELECT** button) to set the selection.
10. Press **MENU** to exit the menu.

Cartridge low

The printer has two options for reporting that print cartridge life is low: **CONTINUE** is the default value.

- Select **CONTINUE** to allow the printer to continue printing while a warning appears and until the print cartridge is replaced.
- Select **STOP** if you want the printer to pause printing until you replace the used print cartridge or press ✓ (**SELECT** button), which allows the printer to print while the warning appears.

To set supplies-low reporting

1. Press **MENU** to open the menus.
2. Press ▼ (**DOWN** button) to highlight **CONFIGURE DEVICE**.
3. Press ✓ (**SELECT** button) to select **CONFIGURE DEVICE**.
4. Press ▼ (**DOWN** button) to highlight **SYSTEM SETUP**.
5. Press ✓ (**SELECT** button) to select **SYSTEM SETUP**.
6. Press ▼ (**DOWN** button) to highlight **CARTRIDGE LOW**.
7. Press ✓ (**SELECT** button) to select **CARTRIDGE LOW**.
8. Press ▲ (**UP** button) or ▼ (**DOWN** button) to select the appropriate setting.
9. Press ✓ (**SELECT** button) to set the selection.
10. Press **MENU** to exit the menu.

Cartridge out

The printer has two options for this menu item.

- Select **CONTINUE** to allow the printer to continue printing. A **REPLACE CARTRIDGE** warning message appears until the print cartridge is replaced. Printing in this mode can continue only for a specific number of pages. After that, the printer stops printing until you replace the empty print cartridge. This is the default setting.
- Select **STOP** if you want the printer to stop printing until the empty print cartridge is replaced.

To set the cartridge-out response

1. Press **MENU** to open the menus.
2. Press **▼** (**DOWN** button) to highlight **CONFIGURE DEVICE**.
3. Press **✓** (**SELECT** button) to select **CONFIGURE DEVICE**.
4. Press **▼** (**DOWN** button) to highlight **SYSTEM SETUP**.
5. Press **✓** (**SELECT** button) to select **SYSTEM SETUP**.
6. Press **▼** (**DOWN** button) to highlight **CARTRIDGE OUT**.
7. Press **✓** (**SELECT** button) to select **CARTRIDGE OUT**.
8. Press **▲** (**UP** button) or **▼** (**DOWN** button) to select the appropriate setting.
9. Press **✓** (**SELECT** button) to set the selection.
10. Press **MENU** to exit the menu.

Jam recovery

Use this option to configure the printer response to jams, including how the printer handles the pages involved. **AUTO** is the default value.

- **AUTO**. The printer automatically turns jam recovery on when sufficient memory is available.
- **ON**. The printer reprints any page that is involved in a jam. Additional memory is allocated to store the last few pages that were printed, and this might cause overall printer performance to suffer.
- **OFF**. The printer does not reprint any page that was involved in a jam. Because no memory is used to store the most recent pages, overall printer performance might be optimized.

To set the jam-recovery response

1. Press **MENU** to open the menus.
2. Press ▼ (**DOWN** button) to highlight **CONFIGURE DEVICE**.
3. Press ✓ (**SELECT** button) to select **CONFIGURE DEVICE**.
4. Press ▼ (**DOWN** button) to highlight **SYSTEM SETUP**.
5. Press ✓ (**SELECT** button) to select **SYSTEM SETUP**.
6. Press ▼ (**DOWN** button) to highlight **JAM RECOVERY**.
7. Press ✓ (**SELECT** button) to select **JAM RECOVERY**.
8. Press ▲ (**UP** button) or ▼ (**DOWN** button) to select the appropriate setting.
9. Press ✓ (**SELECT** button) to set the selection.
10. Press **MENU** to exit the menu.

RAM disk

This option determines how the RAM disk feature is configured. This option is only available if no hard disk is installed and the printer has at least 8 MB of free memory. The default is **AUTO**.

- **AUTO**. The printer determines the optimal RAM disk size based on the amount of available memory.
- **OFF**. The RAM disk is disabled, but a minimal RAM disk is still active (sufficient to scan one page).

To set the RAM disk

1. Press **MENU** to open the menus.
2. Press ▼ (**DOWN** button) to highlight **CONFIGURE DEVICE**.
3. Press ✓ (**SELECT** button) to select **CONFIGURE DEVICE**.
4. Press ▼ (**DOWN** button) to highlight **SYSTEM SETUP**.
5. Press ✓ (**SELECT** button) to select **SYSTEM SETUP**.
6. Press ▼ (**DOWN** button) to highlight **RAM DISK**.
7. Press ✓ (**SELECT** button) to select **RAM DISK**.
8. Press ▲ (**UP** button) or ▼ (**DOWN** button) to select the appropriate setting.
9. Press ✓ (**SELECT** button) to set the selection.
10. Press **MENU** to exit the menu.

Language

If **LANGUAGE** appears in English on the control panel, use the following procedure. Otherwise, turn the printer off and then on again. When **XXX MB** appears, press and hold ✓ (**SELECT** button). When all three control panel lights are lit, release ✓ (**SELECT** button) and use the following procedure to set the language.

To select the language

1. When **SELECT LANGUAGE** appears in English, press ✓ (**SELECT** button), and wait until **LANGUAGE** appears in English.
2. Press ▼ (**DOWN** button) until the preferred language appears.
3. Press ✓ (**SELECT** button) to save the preferred language.

Software

The printer comes with helpful software, including printer drivers and optional software. For easy printer setup and access to the full range of printer features, HP recommends that you install the software that is provided.

Check the installation notes and Readme files on the printer CD-ROM for additional software and languages. HP software is not available in all languages.

Operating systems and printer components

The printer CD-ROM contains the software components and drivers for users and network administrators. The printer drivers that are provided on the CD-ROM must be installed in order to take full advantage of printer features. The other programs are recommended, but are not required for operation. Check the installation notes and Readme files on the printer CD-ROM for more information.

The CD-ROM includes software that is designed for users and network administrators who are operating in the following environments:

- Microsoft® Windows® 98 and Windows Millennium Edition (Me)
- Microsoft Windows NT® 4.0 (parallel and network connections only)
- Microsoft Windows 2000, Windows XP, and Windows Server 2003
- Apple Mac OS version 9.1 and later, and OS X version 10.1 or later

The most recent printer drivers for all supported operating systems are available at http://www.hp.com/go/lj4250_software or http://www.hp.com/go/lj4350_software. If you do not have access to the Internet, see the support flyer that came in the printer box for information about obtaining the most recent software.

The following table lists the available software for the printer.

Software	Windows 98/Me	Windows NT 4.0	Windows 2000/XP/Server 2003	Mac OS	UNIX®/Linux	OS/2
Windows Installer	x	x	x			
PCL 6	x	x	x			
PCL 5	x	x	x			
PostScript emulation	x	x	x			
HP Web Jetadmin*		x	x		x	
Macintosh Installer				x		
Macintosh PostScript Printer Description (PPD) files				x		
IBM drivers*						x
Model scripts*					x	

*Available only on the World Wide Web.

Printer drivers

Printer drivers provide access to the printer features and allow the computer to communicate with the printer (by using a printer language). Check the install notes, Readme, and late-breaking Readme files on the printer CD-ROM for additional software and languages.

The following printer drivers are included with the printer. The most recent drivers are available at http://www.hp.com/go/lj4250_software or http://www.hp.com/go/lj4350_software. Depending on the configuration of Windows-based computers, the installation program for the printer software automatically checks the computer for Internet access to obtain the latest drivers.

Operating system ¹	PCL 6	PCL 5	PS	PPD ²
Windows 98, Me	x	x	x	x
Windows NT 4.0	x	x	x	x
Windows 2000, XP, Server 2003	x	x	x	x
Macintosh OS			x	x

¹ Not all printer features are available from all drivers or operating systems. See the context-sensitive help in the printer driver for available features.

² PostScript (PS) Printer Description files (PPDs)

NOTE

If your system did not automatically check the Internet for the latest drivers during software installation, download them from http://www.hp.com/go/lj4250_software or http://www.hp.com/go/lj4350_software. After you are connected, click **Downloads and Drivers** to find the driver that you want to download.

You can obtain Model Scripts for UNIX and Linux by downloading them from the Internet or by requesting them from an HP-authorized service or support provider. For Linux support see <http://www.hp.com/go/linux>. For UNIX support see http://www.hp.com/go/jetdirectunix_software. For additional information see the support flyer that came in the printer box.

NOTE

If the printer driver that you want is not on the printer CD-ROM or is not listed here, check the install notes, Readme, and late-breaking Readme files to see if the printer driver is supported. If it is not supported, contact the manufacturer or distributor of the program that you are using and request a driver for the printer.

Additional drivers

The following drivers are not included on the CD-ROM, but are available from the Internet.

- OS/2 PCL 5 or PCL 6 printer driver.
- OS/2 PS printer driver.
- UNIX model scripts.
- Linux drivers.
- HP OpenVMS drivers.

NOTE

The OS/2 drivers are available from IBM and are packaged with OS/2. They are not available for Simplified Chinese, Korean, Japanese, or Traditional Chinese.

Select the correct printer driver for your needs

Select a printer driver based on the way that you use the printer. Certain printer features are available only in the PCL 6 drivers. See the printer driver Help for available features.

- Use the PCL 6 driver to take full advantage of printer features. For general office printing, the PCL 6 driver is recommended to provide optimum performance and print quality.
- Use the PCL 5 driver if backward compatibility with previous PCL printer drivers or older printers is necessary.
- Use the PS driver if you are printing primarily from PostScript-specific programs such as Adobe® and Corel, for compatibility with PostScript Level 3 needs, or for PS CompactFlash font support.

NOTE

The printer automatically switches between PS and PCL printer languages.

Printer driver Help

Each printer driver has Help screens that can be activated by using the Help button, the F1 button on the computer keyboard, or a question-mark symbol in the upper-right corner of the printer driver (depending on the Windows operating system that you are using). You can also open printer-driver Help by right-clicking any item in the driver, and then clicking **What's This?** These Help screens give detailed information about the specific driver. Printer driver Help is separate from your program Help.

Using the printer drivers

Use one of the following methods to open the printer drivers from your computer:

Operating System	To change the settings for all print jobs until the software program is closed	To change the print job default settings (for example, turn on Print on Both Sides by default)	To change the configuration settings (for example, add a physical option such as a tray or enable/disable a driver feature such as Allow Manual Duplexing)
Windows 98, NT 4.0, and ME	On the File menu in the software program, click Print . Select the printer, and then click Properties . The steps can vary; this procedure is most common.	Click Start , click Settings , and then click Printers . Right-click the printer icon, and then select Properties (Windows 98 and ME) or Document Defaults (Windows NT 4.0).	Click Start , click Settings , and then click Printers . Right-click the printer icon, and then select Properties . Click the Configure tab.

Operating System	To change the settings for all print jobs until the software program is closed	To change the print job default settings (for example, turn on Print on Both Sides by default)	To change the configuration settings (for example, add a physical option such as a tray or enable/disable a driver feature such as Allow Manual Duplexing)
Windows 2000, XP, and Server 2003	<p>On the File menu in the software program, click Print. Select the printer, and then click Properties or Preferences.</p> <p>The steps can vary; this procedure is most common.</p>	<p>Click Start, click Settings, and then click Printers or Printers and Faxes. Right-click the printer icon, and then select Printing Preferences.</p>	<p>Click Start, click Settings, and then click Printers or Printers and Faxes. Right-click the printer icon, and then select Properties. Click the Device Settings tab.</p>
Macintosh OS V9.1	<p>On the File menu, click Print. Change the settings that you want on the various pop-up menus.</p>	<p>On the File menu, click Print. As you change settings on the pop-up menu, click Save Settings.</p>	<p>Click the desktop printer icon. From the Printing menu, click Change Setup.</p>
Macintosh OS X V10.1	<p>On the File menu, click Print. Change the settings that you want on the various pop-up menus.</p>	<p>On the File menu, click Print. Change the settings that you want on the various pop-up menus, and then on the main pop-up menu, click Save Custom Setting. These settings are saved as the Custom option. To use the new settings, you must select the Custom option every time that you open a program and print.</p>	<p>Delete the printer and reinstall it. The driver will be auto-configured with the new options when it is reinstalled.</p> <hr/> <p>NOTE</p> <p>Use this procedure for AppleTalk connections only. Configuration settings might not be available in Classic mode.</p> <hr/>
Macintosh OS X V10.2	<p>On the File menu, click Print. Change the settings that you want on the various pop-up menus.</p>	<p>On the File menu, click Print. Change the settings that you want on the various pop-up menus, and then, on the Presets pop-up menu, click Save as and type a name for the preset. These settings are saved in the Presets menu. To use the new settings, you must select the saved preset option every time you open a program and print.</p>	<p>Open Print Center by selecting the hard drive, clicking Applications, clicking Utilities, then double-clicking Print Center. Click on the print queue. On the Printers menu, click Show Info. Click the Installable Options menu.</p> <hr/> <p>NOTE</p> <p>Configuration settings might not be available in Classic mode.</p> <hr/>

Operating System	To change the settings for all print jobs until the software program is closed	To change the print job default settings (for example, turn on Print on Both Sides by default)	To change the configuration settings (for example, add a physical option such as a tray or enable/disable a driver feature such as Allow Manual Duplexing)
Macintosh OS X V10.3	On the File menu, click Print . Change the settings that you want on the various pop-up menus.	On the File menu, click Print . Change the settings that you want on the various pop-up menus, and then, on the Presets pop-up menu, click Save as and type a name for the preset. These settings are saved in the Presets menu. To use the new settings, you must select the saved preset option every time that you open a program and print.	Open Printer Setup Utility by selecting the hard drive, clicking Applications , clicking Utilities , then double-clicking Printer Setup Utility . Click on the print queue. On the Printers menu, click Show Info . Click the Installable Options menu.

Software for Macintosh computers

The HP installer provides PostScript Printer Description (PPD) files, Printer Dialog Extensions (PDEs), and the HP LaserJet Utility for use with Macintosh computers.

The embedded Web server can be used with Macintosh computers if the printer is connected to a network. See [Using the embedded Web server](#) for more information.

PPDs

Use PPDs in combination with the Apple PostScript drivers to gain access to the printer features and to allow the computer to communicate with the printer. An installation program for the PPDs, PDEs, and other software is provided on the CD-ROM. Use the appropriate PS driver that comes with the operating system.

HP LaserJet Utility

Use the HP LaserJet Utility to control features that are not available in the driver. The illustrated screens make selecting printer features easy. Use the HP LaserJet Utility to perform the following tasks:

- Name the printer, assign it to a zone on the network, and download files and fonts.
- Configure and set the printer for Internet protocol (IP) printing.

NOTE

The HP LaserJet Utility is not currently supported for OS X, but the utility is supported for the Classic environment.

Installing the printing system software

The printer comes with printing system software and printer drivers on a CD-ROM. The printing system software on the CD-ROM must be installed in order to take full advantage of the printer features.

If you do not have access to a CD-ROM drive, you can download the printing system software from the Internet at http://www.hp.com/go/lj4250_software or http://www.hp.com/go/lj4350_software.

NOTE

Sample model scripts for UNIX (HP-UX®, Sun Solaris) and Linux networks are available for download from the World Wide Web. For Linux support see <http://www.hp.com/go/linux>. For UNIX support see http://www.hp.com/go/jetdirectunix_software.

You can download the latest software free of charge at http://www.hp.com/go/lj4250_software or http://www.hp.com/go/lj4350_software.

After you have followed the installation instructions and loaded the software, see [Using printer-driver features](#) to get the most out of your printer.

Printer driver Help

Each printer driver has Help screens that can be activated by using either the **Help** button, the **F1** button on the computer keyboard, or a question-mark symbol in the upper-right corner of the printer driver (depending on the Windows operating system that you are using). These Help screens give detailed information about the specific driver. Printer driver Help is separate from your program Help.

Installing Windows printing system software for direct connections

This section explains how to install the printing system software for Microsoft Windows 98, Windows Me, Windows NT 4.0, Windows 2000, Windows XP, and Windows Server 2003.

When installing the printing software in a direct-connect environment, always install the software before connecting the parallel or USB cable. If the parallel or USB cable was connected before the software installation, see [Installing the software after the parallel or USB cable has been connected](#).

Either a parallel or USB cable can be used for the direct connection. Use an IEEE 1284-compatible cable or a standard 2-meter USB cable.

CAUTION

Do not connect parallel and USB cables at the same time.

NOTE

Windows NT 4.0 does not support USB cable connections.

To install the printing system software

1. Close all software programs that are open or running.
2. Insert the printer CD-ROM into the CD-ROM drive.
If the welcome screen does not open, start it by using the following procedure:
 1. On the **Start** menu, click **Run**.
 2. Type the following (where X is the letter of the CD-ROM drive): `X:\setup`
 3. Click **OK**.
3. When prompted, click **Install Printer** and follow the instructions on the computer screen.

4. Click **Finish** when the installation has completed.
5. Restart the computer.
6. Print a page from any software program to make sure that the software is correctly installed.

If installation fails, reinstall the software. If this fails, check the installation notes and Readme files on the printer CD-ROM or the flyer that came in the printer box, or go to http://www.hp.com/go/lj4250_software or http://www.hp.com/go/lj4350_software for help or more information.

Installing Windows printing system software for networks

The software on the printer CD-ROM supports network installation with a Microsoft network (except Windows 3.1x). For network installation on other operating systems, go to http://www.hp.com/go/lj4250_software or http://www.hp.com/go/lj4350_software.

NOTE

Windows NT 4.0 drivers must be installed through the Windows Add-Printer Wizard.

The HP Jetdirect print server that is included with printer models that feature the letter "n" in the model name has a 10/100Base-TX network port. For other options, see [Ordering parts, accessories, and supplies](#) or contact your local HP dealer. See [HP customer care](#).

The installer does not support printer installation or printer object creation on Novell servers. It supports only direct-mode network installations between Windows computers and a printer. To install your printer and create objects on a Novell server, use an HP utility, such as HP Web Jetadmin, or a Novell utility, such as NWadmin.

To install the printing system software

1. If you are installing the software on Windows NT 4.0, Windows 2000, Windows XP, or Windows Server 2003 make sure that you have administrator privileges.

Print a configuration page to make sure that the HP Jetdirect print server is configured correctly for the network. See [Configuration page](#). On the second page, locate the printer IP address. You might need this address to complete network installation.
2. Close all software programs that are open or running.
3. Insert the printer CD-ROM into the CD-ROM drive.
4. If the welcome screen does not open, start it by using the following procedure:
 1. On the **Start** menu, click **Run**.
 2. Type the following (where X is the letter of the CD-ROM drive): `X:\setup`
 3. Click **OK**.
5. When prompted, click **Install Printer** and follow the instructions on the computer screen.
6. Click **Finish** when the installation is complete.
7. Restart the computer.
8. Print a page from any software program to make sure that the software is correctly installed.

If installation fails, reinstall the software. If this fails, check the installation notes and Readme files on the printer CD-ROM or the flyer that came in the printer box, or go to http://www.hp.com/go/lj4250_software or http://www.hp.com/go/lj4350_software for help or more information.

To set up a Windows computer to use the network printer with Windows-sharing

You can share the printer on the network so that other network users can print to it.

See your Windows documentation to set up Windows-sharing. After the printer is shared, install the printer software on all computers that share the printer.

Installing Macintosh printing system software for networks

This section describes how to install Macintosh printing system software. The printing system software supports Apple Mac OS 9.x and later and OS X V10.1 and later.

The printing system software includes the following components:

- **PostScript Printer Description files.** The PostScript (PS) Printer Description files (PPDs), in combination with the Apple LaserWriter 8 printer driver, provide access to the printer features and allow the computer to communicate with the printer. An installation program for the PPDs and other software is provided on the CD-ROM that came with the printer. In addition, use the Apple LaserWriter 8 printer driver that comes with the computer.
- **HP LaserJet Utility.** The HP LaserJet Utility provides access to features that are not available in the printer driver. Use the illustrated screens to select printer features and complete tasks with the printer:
 - Name the printer, assign it to a zone on the network, download files and fonts, and change many of the printer settings.
 - Set a password for the printer.
 - Check the levels of printer consumables.
 - Configure and set the printer for Internet Protocol (IP) or AppleTalk printing.

To install printer drivers in Mac OS 9.x

1. Connect the network cable between the HP Jetdirect print server and a network port.
2. Insert the CD-ROM into the CD-ROM drive. The CD-ROM menu runs automatically. If the CD-ROM menu does not run automatically, double-click the CD-ROM icon on the desktop, and then double-click the **Installer** icon. This icon is located in the Installer/ <language> folder of the Starter CD-ROM, where <language> is your language preference. For example, the Installer/English folder contains the Installer icon for the English printer software.
3. Follow the instructions on the screen.
4. From **HD**, click **Applications**, click **Utilities**, and then open the Apple Desktop Printer Utility.
5. Double click **Printer (AppleTalk)**.
6. Next to AppleTalk Printer Selection, click **Change**.
7. Select the printer, click **Auto Setup**, and then click **Create**.
8. On the **Printing** menu, click **Set Default Printer**.

To install printer drivers in Mac OS X V10.1 and later

1. Connect the network cable between the HP Jetdirect print server and a network port.

2. Insert the CD-ROM into the CD-ROM drive. The CD-ROM menu runs automatically. If the CD-ROM menu does not run automatically, double-click the CD-ROM icon on the desktop, and then double-click the **Installer** icon. This icon is located in the Installer/<language> folder of the Starter CD-ROM, where <language> is your language preference. For example, the Installer/English folder contains the Installer icon for the English printer software.
3. Double-click the **HP LaserJet Installers** folder.
4. Follow the instructions on the computer screen.
5. Double-click the **Installer** icon for the appropriate language.

NOTE

If OS X and OS 9.x (Classic) are installed on the same computer, the installer will show both the Classic and the OS X installation options.

6. On your computer hard drive, double-click **Applications**, double-click **Utilities**, and then double-click **Print Center** or **Print Setup Utility**.

NOTE

If you are using OS X V10.3, "Print Setup Utility" has replaced "Print Center".

7. Click **Add Printer**.
8. Select your connection type.
9. Select the printer name.
10. Click **Add Printer**.
11. Close the Print Center or the Print Setup Utility by clicking the **close** button in the upper-left corner.

NOTE

Macintosh computers cannot be connected directly to the printer with a parallel port.

Installing Macintosh printing system software for direct connections

NOTE

Macintosh computers do not support parallel port connections.

This section explains how to install the printing system software for OS 9.x and later and OS X V10.1 and later.

The Apple LaserWriter driver must be installed in order to use the PPD files. Use the Apple LaserWriter 8 driver that came with your Macintosh computer.

To install the printing system software

1. Connect a USB cable between the USB port on the printer and the USB port on the computer. Use a standard 2-meter USB cable.
2. Close all software programs that are open or running.
3. Insert the printer CD-ROM into the CD-ROM drive and run the installer.

The CD-ROM menu runs automatically. If the CD-ROM menu does not run automatically, double-click the CD-ROM icon on the desktop, and then double-click the **Installer** icon. This icon is located in the Installer/<language> folder of the Starter CD-ROM, where <language> is your language preference.

4. Follow the instructions on the computer screen.
5. Restart the computer.
6. **For Mac OS 9.x:**

1. From **HD**, click **Applications**, click **Utilities**, and then open the Apple Desktop Printer Utility.
2. Double-click **Printer (USB)**, and then click **OK**.
3. Next to **USB Printer Selection**, click **Change**.
4. Select the printer, and then click **OK**.
5. Next to **Postscript Printer Description (PPD) File**, click **Auto Setup**, and then click **Create**.
6. On the **Printing** menu, click **Set Default Printer**.

For Mac OS X:

1. From **HD**, click **Applications**, then click **Utilities**, and then click **Print Center** or **Printer Setup Utility** to start the Print Center or Printer Setup Utility.
2. If the printer appears in the Printer list, delete the printer.
3. Click **Add**.
4. On the drop-down menu at the top, click **USB**.
5. In the **Printer Model List**, click **HP**.
6. Under **Model Name**, click **HP LaserJet 4250 or 4350 series**, and then click **Add**.
7. Print a page from any software program to make sure that the software is correctly installed.

If installation fails, reinstall the software. If this fails, see the installation notes or Readme files on the printer CD-ROM or the flyer that came in the printer box, or go to http://www.hp.com/go/lj4250_software or http://www.hp.com/go/lj4350_software for help or more information.

Installing the software after the parallel or USB cable has been connected

If you have already connected a parallel or USB cable to a Windows computer, the **New Hardware Found** dialog box appears when you turn on the computer.

To install the software for Windows 98 or Windows Me

1. In the **New Hardware Found** dialog box, click **Search CD-ROM drive**.
2. Click **Next**.
3. Follow the instructions on the computer screen.
4. Print a page from any software program to make sure that the printer software is correctly installed.

If installation fails, reinstall the software. If this fails, check the installation notes and Readme files on the printer CD-ROM or the flyer that came in the printer box, or go to http://www.hp.com/go/lj4250_software or http://www.hp.com/go/lj4350_software for help or more information.

To install the software for Windows 2000, Windows XP, or Windows Server 2003

1. In the **New Hardware Found** dialog box, click **Search**.
2. On the **Locate Driver Files** screen, select the **Specify a Location** check box, clear all other check boxes, and then click **Next**.
3. Type the following text, where X is the letter of the CD-ROM drive: X:\2000XP

4. Click **Next**.
5. Follow the instructions on the computer screen.
6. Click **Finish** when installation is complete.
7. Select a language and follow the instructions on the computer screen.
8. Print a page from any software program to make sure that the software is correctly installed.

If installation fails, reinstall the software. If this fails, check the installation notes and Readme files on the printer CD-ROM or the flyer that came in the printer box, or go to http://www.hp.com/go/lj4250_software or http://www.hp.com/go/lj4350_software for help or more information.

Uninstalling the software

This section explains how to uninstall the printing system software.

To remove software from Windows operating systems

Use the Uninstaller to select and remove any or all of the Windows HP printing-system components.

1. Click **Start** and then point to **Programs**.
2. Point to **HP LaserJet 4250 or 4350 series**, and then click **Uninstaller**.
3. Click **Next**.
4. Select the HP printing-system components that you want to uninstall.
5. Click **OK**.
6. Follow the instructions on the computer screen to complete the uninstallation.

To remove software from Macintosh operating systems

Drag the HP LaserJet folder and PPDs to the trash can:

- **For Mac OS 9**, the folders are in hard drive/HP LaserJet and in hard drive/system folder/extensions/printer descriptions.
- **For Mac OS X**, the folders are in hard drive/Library/Printers/PPDs/Contents/Resources/EN.lproj.

Selecting print media

This printer accepts a variety of media, such as cut-sheet paper, including up to 100% recycled fiber content paper; envelopes; labels; transparencies; and custom-size paper. Properties such as weight, composition, grain, and moisture content are important factors that affect printer performance and output quality. Paper that does not meet the guidelines that are outlined in this manual can cause the following problems:

- Poor print quality
- Increased jams
- Premature wear on the printer, requiring repair

NOTE

Some paper might meet all of the guidelines in this manual and still not produce satisfactory results. This might be the result of improper handling, unacceptable temperature and humidity levels, or other variables over which Hewlett-Packard has no control. Before purchasing large quantities of media, make sure that it meets the requirements that are specified in this User guide and in the *HP LaserJet Printer Family Print Media Guide*, which is available for download at <http://www.hp.com/support/ljpaperguide>. Always test paper before buying large quantities.

CAUTION

Using media that does not meet HP specifications can cause problems for the printer, requiring repair. This repair is not covered by the HP warranty or service agreements.

Supported sizes of print media

Tray 1 supported sizes and weights

Size	Dimensions ¹	Weight	Capacity ²
Letter	216 x 279 mm (8.5 x 11 inches)	60 to 200 g/m ² (16 to 53 lb)	100 sheets of 75 g/m ² (20 lb) paper
A4	210 x 297 mm (8.3 x 11.7 inches)		
Legal	216 x 356 mm (8.5 x 14 inches)		
Executive	184 x 267 mm (7.3 x 10.5 inches)		
A5	148 x 210 mm (5.8 x 8.3 inches)		
8.5 x 13	216 x 330 mm (8.5 x 13 inches)		
B5 (JIS)	182 x 257 mm (7.2 x 10.1 inches)		
Executive (JIS)	216 x 330 mm (8.5 x 13 inches)		
Double postcard (JIS)	148 x 200 mm (5.8 x 7.9 inches)		
16K	197 x 273 mm (7.8 x 10.8 inches)		
Custom ³	Minimum: 76 x 127 mm (3 x 5 inches) Maximum: 216 x 356 mm (8.5 x 14 inches)		
Envelope Commercial #10	105 x 241 mm (4.1 x 9.5 inches)	75 to 105 g/m ² (20 to 28 lb)	10 envelopes
EnvelopeDL ISO	110 x 220 mm (4.3 x 8.7 inches)		
EnvelopeC5 ISO	162 x 229 mm (6.4 x 9.0 inches)		
EnvelopeB5 ISO	176 x 250 mm (6.9 x 9.8 inches)		
EnvelopeMonarch #7-3/4	98 x 191 mm (3.9 x 7.5 inches)		

¹The printer supports a wide range of sizes. Check the printer software for supported sizes.

²Capacity can vary depending on paper weight and thickness, as well as environmental conditions.

³To print on custom-size paper, see [Printing on small sizes, custom sizes, or heavy paper](#).

Tray 2 and optional 500-sheet tray supported sizes and weights

Size	Dimensions ¹	Weight	Capacity ²
Letter	216 x 279 mm (8.5 x 11 inches)	60 to 120 g/m ² (16 to 32 lb)	500 sheets of 75 g/m ² (20 lb) paper
A4	210 x 297 mm (8.3 x 11.7 inches)		
Executive	184 x 267 mm (7.3 x 10.5 inches)		
Legal	216 x 356 mm (8.5 x 14 inches)		
8.5 x 13	216 x 330 mm (8.5 x 13 inches)		
Executive (JIS)	216 x 330 mm (8.5 x 13 inches)		
B5 (JIS)	182 x 257 mm (7.2 x 10.1 inches)		
A5	148 x 210 mm (5.8 x 8.3 inches)		
16K	197 x 273 mm (7.8 x 10.8 inches)		
Custom ³	Minimum: 148 x 210 mm (5.8 x 8.3 inches) Maximum: 216 x 356 mm (8.5 x 14 inches)		

¹The printer supports a wide range of sizes. Check the printer software for supported sizes.

²Capacity can vary depending on paper weight and thickness, as well as environmental conditions.

³To print on custom-size paper, see [Printing on small sizes, custom sizes, or heavy paper](#).

Optional 1,500-sheet tray supported sizes and weights

Size	Dimensions	Weight	Capacity ¹
Letter	216 x 279 mm (8.5 x 11 inches)	60 to 120 g/m ² (16 to 32 lb)	1,500 sheets of 75 g/ m ² (20 lb) paper
A4	210 x 297 mm (8.3 x 11.7 inches)		
Legal	216 x 356 mm (8.5 x 14 inches)		

¹Capacity can vary depending on paper weight and thickness, as well as environmental conditions.

Optional duplexer supported sizes and weights

Size	Dimensions	Weight
Letter	216 x 279 mm (8.5 x 11 inches)	60 to 120 g/m ² (16 to 32 lb)
A4	210 x 297 mm (8.3 x 11.7 inches)	
Executive	184 x 267 mm (7.3 x 10.5 inches)	
Legal	216 x 356 mm (8.5 x 14 inches)	
B5 (JIS)	182 x 257 mm (7.2 x 10.1 inches)	
A5	148 x 210 mm (5.8 x 8.3 inches)	

Optional envelope feeder supported sizes and weights

Size	Dimensions	Weight	Capacity
Monarch #7-3/4	98 x 191 mm (3.9 x 7.5 inches)	75 to 105 g/m ² (20 to 28 lb)	75 envelopes
Commercial#10	105 x 241 mm (4.1 x 9.5 inches)		
DL ISO	110 x 220 mm (4.3 x 8.7 inches)		
C5 ISO	162 x 229 mm (6.4 x 9.0 inches)		

Optional stacker or stapler/stacker supported sizes and weights

Size	Dimensions ¹	Weight	Capacity ²
Stacker or stacker part of stapler/stacker only			

Optional stacker or stapler/stacker supported sizes and weights (continued)

Size	Dimensions ¹	Weight	Capacity ²
Letter	216 x 279 mm (8.5 x 11 inches)	60 to 120 g/m ² (16 to 32 lb)	500 sheets of 75 g/m ² (20 lb) paper
A4	210 x 297 mm (8.3 x 11.7 inches)		
Executive	184 x 267 mm (7.3 x 10.5 inches)		
Legal	216 x 356 mm (8.5 x 14 inches)		
B5 (JIS)	182 x 257 mm (7.2 x 10.1 inches)		
A5	148 x 210 mm (5.8 x 8.3 inches)		
Custom ³	Minimum: 148 x 210 mm (5.8 x 8.3 inches) Maximum: 216 x 356 mm (8.5 x 14 inches)		
Stapler part of stapler/stacker only ⁴			
Letter	216 x 279 mm (8.5 x 11 inches)	60 to 120 g/m ² (16 to 32 lb)	15 sheets of 75 g/m ² (20 lb) paper
A4	210 x 297 mm (8.3 x 11.7 inches)		
Legal	216 x 356 mm (8.5 x 14 inches)		

¹The printer supports a wide range of sizes. Check the printer software for supported sizes.

²Capacity can vary depending on paper weight and thickness, as well as environmental conditions.

³To print on custom-size paper, see [Printing on small sizes, custom sizes, or heavy paper](#).

⁴All sizes can be stacked, but only letter, legal, and A4 can be stapled.

2

Printing tasks

This section provides information about common printing tasks.

- [Selecting which tray is used for printing](#)
- [Selecting the correct fuser mode](#)
- [Stapling documents](#)
- [Loading trays](#)
- [Understanding media output options](#)
- [Printing envelopes](#)
- [Printing on special media](#)
- [Printing on both sides of paper \(optional duplex\)](#)
- [Canceling a print job](#)
- [Using the printer driver](#)
- [Using printer-driver features](#)
- [Using job-storage features](#)

Selecting which tray is used for printing

You can select how the printer pulls media from the trays. The following sections provide information about configuring the printer to pull media from specific trays.

[Understanding tray order](#)

[Customizing tray 1 operation](#)

[Printing by type and size of media \(locking trays\)](#)

[Manually feeding media from tray 1](#)

Understanding tray order

When the printer receives a print job, it selects the tray by trying to match the requested paper type and size with what has been loaded in the trays. Using an "autoselect" process, it searches all available trays for the paper that satisfies the request, starting with the bottom tray and ending with the top tray (tray 1). The printer begins printing the job as soon as it finds the correct type and size.

NOTE

The "autoselect" process occurs only if no specific tray is requested for the job. If a specific tray is requested, the job prints from the requested tray.

- If media is loaded in tray 1 and tray 1 is set **TRAY 1 TYPE=ANY** and **TRAY 1 SIZE=ANY** on the **PAPER HANDLING** menu, the printer will always pull media from tray 1 first. See [Customizing tray 1 operation](#) for more information.
- If the search fails, a message appears on the printer control-panel display requesting that you load the correct media type and size. You can load that media type and size, or you can override the request by selecting a different type and size at the printer control panel.
- If a tray runs out of media during a print job, the printer automatically switches to any tray that contains the same media type and size.

The autoselect process changes somewhat if you customize tray 1 operation (as explained in [Customizing tray 1 operation](#)) or if you set tray 1 for manual feed (as explained in [Manually feeding media from tray 1](#)).

Customizing tray 1 operation

The printer can be set to print from tray 1 if it is loaded, or to print only from tray 1 if the type of media that is loaded is specifically requested. See [Paper Handling menu](#).

Setting	Explanation
TRAY 1 TYPE=ANY TRAY 1 SIZE=ANY	The printer usually pulls media from tray 1 first unless it is empty or closed. If you do not keep media in tray 1 all the time, or if you use tray 1 only to manually feed media, keep the default setting of TRAY 1 TYPE=ANY and TRAY 1 SIZE=ANY on the Paper Handling menu.

Setting	Explanation
TRAY 1 TYPE= or TRAY 1 SIZE= a type other than ANY	<p>The printer treats tray 1 like the other trays. Instead of looking for media in tray 1 first, the printer pulls media from the tray that matches type and size settings that are selected in the software.</p> <p>In the printer driver, you can select media from any tray (including tray 1) by type, size, or source. To print by type and size of paper, see Printing by type and size of media (locking trays).</p>

You can also determine whether the printer shows a prompt to ask if it can pull media from tray 1 if it cannot find the type and size that you requested in another tray. You can set the printer to always prompt you before pulling from tray 1 or only prompt you if tray 1 is empty. Set the **USE REQUESTED TRAY** setting on the **System Setup** submenu of the **Configure Device** menu.

Printing by type and size of media (locking trays)

Printing by type and size is a way to be sure that print jobs always print on the media that you want. You can configure the trays for the type, such as plain or letterhead, and size, such as letter or A4, that is loaded in them.

If you configure the trays this way and then select a certain type and size in the printer driver, the printer automatically selects the tray that is loaded with that type or size. You do not have to select a specific tray (selecting by source). Configuring the printer this way is especially helpful if the printer is shared, and more than one person loads or removes media frequently.

Some older model printers have a feature that "locks out" trays to prevent printing on the wrong media. Printing by type and size eliminates the need to lock trays. For more information about the types and sizes that each tray supports, see [Supported sizes of print media](#).

NOTE

To print by type and size from tray 2, the optional trays, or the optional envelope feeder, you might have to unload tray 1 and close it, or set **TRAY 1 TYPE** and **TRAY 1 SIZE** to types other than **ANY** on the PAPER HANDLING menu at the printer control panel. For more information, see [Customizing tray 1 operation](#). Settings in a program or the printer driver override control-panel settings. (Program settings generally override printer-driver settings.)

To print by type and size of paper

1. Be sure to load the trays correctly. See [Loading trays.](#))
2. At the printer control panel, open the PAPER HANDLING menu. Select the paper type for each tray. If you are unsure which type you are loading, such as bond or recycled, check the label on the media package.
3. Select the paper-size settings at the printer control panel.
 - **Tray 1:** Set the paper size on the PAPER HANDLING menu if the printer is set to **TRAY 1 TYPE=** a type other than **ANY**. If custom paper is loaded, also set the custom-paper size on the PAPER HANDLING menu. For more information, see [Printing on small sizes, custom sizes, or heavy paper.](#)
 - **Tray 2 and optional 500-sheet trays:** Standard paper sizes are automatically detected if the media is loaded correctly in the tray and the guides are adjusted correctly. See [Loading trays](#) for information about tray adjustments. If custom paper is loaded, set the knob in the tray to "Custom" and set the custom-paper size on the PAPER HANDLING menu. For more information, see [Printing on small sizes, custom sizes, or heavy paper.](#)
 - **Optional 1,500-sheet tray:** Standard paper sizes are automatically detected if the media is loaded in the tray correctly and the guides are adjusted correctly. See [Loading trays](#) for information about tray adjustments. Custom-size media is not supported.
 - **Optional envelope feeder:** Set the size on the PAPER HANDLING menu.
4. In the program or printer driver, select a type other than **Auto Select**.

NOTE

The type and size settings can also be configured in the HP Web Jetadmin software for networked printers.

Manually feeding media from tray 1

The manual feed feature is another way of printing on special media from tray 1. Setting **MANUAL FEED** to **ON** either in the printer driver or at the printer control panel stops the printer after each job is sent, allowing you time to load special paper or other print media in tray 1. Press ✓ (**SELECT** button) to continue printing.

If tray 1 contains media when you send the print job, and the printer control panel has **TRAY 1 TYPE=ANY** and **TRAY 1 SIZE=ANY** as the default configuration for tray 1 operation, the printer will **not** stop and wait for media to be loaded. To have the printer wait, set **TRAY 1 TYPE** and **TRAY 1 SIZE** to types other than **ANY** on the PAPER HANDLING menu.

NOTE

If the **SIZE** and **TYPE** are set to **ANY**, and **MANUAL FEED PROMPT** is set to **UNLESS LOADED**, then the media will be pulled from tray 1 without prompting. If **MANUAL FEED PROMPT** is set to **ALWAYS**, then the printer will prompt you to load media, even if tray 1 is set to **TYPE=ANY** and **SIZE=ANY**.

If you have selected **MANUAL FEED=ON** at the printer control panel, this setting will override the printer driver, and all print jobs that you send to the printer will request manually fed paper in tray 1 unless a specific tray has been selected in the printer driver. If this feature is to be used only occasionally, it is best to set **MANUAL FEED=OFF** at the printer control panel and to select the manual feed option in the printer driver on a job-by-job basis.

Selecting the correct fuser mode

The printer automatically adjusts the fuser mode based on the media type to which the tray is set. For example, heavy paper, such as card stock, might need a higher fuser-mode setting in order to make the toner adhere better to the page, but transparencies need the LOW fuser-mode setting to avoid damage to the printer. The default setting generally provides the best performance for most print-media types.

The fuser mode can be changed only if the media type has been set for the tray that you are using. (See [Printing by type and size of media \(locking trays\)](#).) After the media type has been set for the tray, then the fuser mode for that type can be changed on the **CONFIGURE DEVICE** menu in the **PRINT QUALITY** submenu at the printer control panel. (See [Print Quality submenu](#).)

NOTE

Using a higher fuser mode, such as HIGH 1 or HIGH 2, improves the ability of the toner to adhere to paper, but it might cause other problems, such as excessive curl. The printer might print at a slower speed when the fuser mode is set to HIGH 1 or HIGH 2.

To reset the fuser modes to the default settings, open the **CONFIGURE DEVICE** menu at the printer control panel. On the **PRINT QUALITY** submenu, select **FUSER MODES**, and then select **RESTORE MODES**.

Stapling documents

The optional stapler/stacker can staple jobs of up to 15 sheets of 75 g/m² (20 lb) paper. The stapler can staple letter-size, A4-size, or legal-size paper.

- Paper weight can range from 60 to 120 g/m² (16 to 32 lb). Heavier paper might have a stapling limit of fewer than 15 sheets.
- If the job consists of only one sheet, or if it consists of more than 15 sheets, the printer will print the job to the bin, but the printer will not staple the job.
- The stapler supports paper only. Do not try to staple other types of print media, such as transparencies or labels.

When you are ready to have the printer staple a document, select stapling in the software. You can usually select the stapler in your program or printer driver, although some options might be available only in the printer driver. Where and how you make selections depends on your program or printer driver.

If you cannot select the stapler in the program or printer driver, select the stapler at the printer control panel.

You might need to configure the printer driver to recognize the optional stapler/stacker. You need to set this setting only once. See the printer driver online Help for details.

The stapler accepts print jobs if it is out of staples, but it does not staple the pages. The printer driver can be configured to disable the staple option if the staple cartridge is empty.

To select the stapler in the software (Windows)

1. On the **File** menu, click **Print**, and then click **Properties**.
2. On the **Output** tab, click the drop-down list under **Staple**, and click **One Staple Angled**.

To select the stapler in the software (Mac)

1. On the **File** menu, click **Print**, and then select **Finishing** from the selectable print options.
2. In the **Output Destination** dialog box, select the **Stapler** option.
3. In the **Stapler** dialog box, select the stapler style.

To select the stapler at the control panel

1. Press **MENU** to open the menus.
2. Use **▲** (**UP** button) or **▼** (**DOWN** button) to scroll to **CONFIGURE DEVICE**, and then press **✓** (**SELECT** button).
3. Use **▲** (**UP** button) or **▼** (**DOWN** button) to scroll to **STAPLER/STACKER**, and then press **✓** (**SELECT** button).
4. Use **▲** (**UP** button) or **▼** (**DOWN** button) to scroll to **ONE**, and then press **✓** (**SELECT** button).

NOTE

Selecting the stapler at the printer control panel changes the default setting to **STAPLE**. It is possible that all print jobs will be stapled. However, settings that are changed in the printer driver override settings that are changed at the control panel.

Loading staples

Load staples if the printer control-panel display prompts you with a **STAPLER LOW ON STAPLES** message (the stapler has fewer than 70 staples left) or a **STAPLER OUT OF STAPLES** message (the stapler is empty). If the stapler runs out of staples, jobs continue to print to the stapler/stacker, but they are not stapled.

To load staples

1. On the right side of the stapler/stacker, turn the stapler unit toward the front of the printer until the unit clicks into the open position. Grasp the blue staple-cartridge handle and pull the cartridge out of the stapler unit.

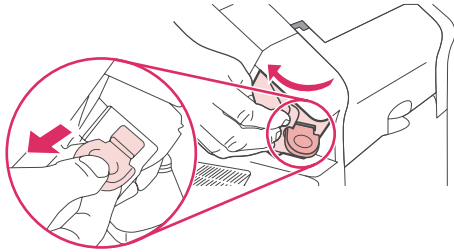

2. Insert the new staple cartridge into the stapler unit and rotate the stapler unit toward the rear of the printer until the unit snaps into place.

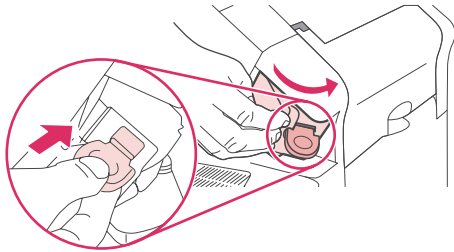

Loading trays

This section describes how to load the standard and optional printer trays.

Loading tray 1

Tray 1 is a multipurpose tray that holds up to 100 sheets of paper, 50 transparencies or sheets of labels, 10 envelopes, or 20 index cards. The printer default is to pull media from tray 1 first, if it is loaded. To change this behavior, see [Customizing tray 1 operation](#).

Tray 1 provides a convenient way to print on envelopes, transparencies, custom-size paper, or other types of media without having to unload the other trays. It can also be used just as a convenient additional tray. For supported media sizes, see [Supported sizes of print media](#).

If an optional stapler/stacker is installed, the printer automatically rotates the printed images 180° on all media sizes, even if the job is not stapled. If you are printing on paper that requires a specific orientation, such as letterhead, preprinted paper, prepunched paper, and paper with watermarks, make sure that the paper is loaded correctly in the tray. See [Orientation of paper when a stapler is installed](#).

NOTE

The printer might print at a slower speed when using tray 1.

CAUTION

To avoid jams, do not load trays while the printer is printing. Do not fan the paper. Fanning can cause misfeeds.

To load tray 1

1. Open tray 1.

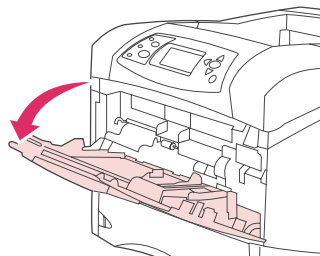

2. Pull out the tray extension.

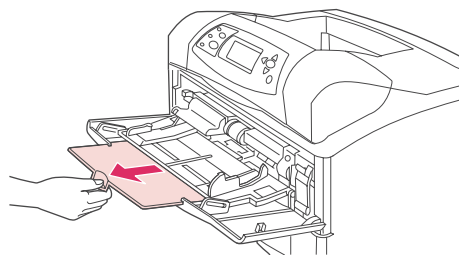

3. Set the side guides to the correct width.

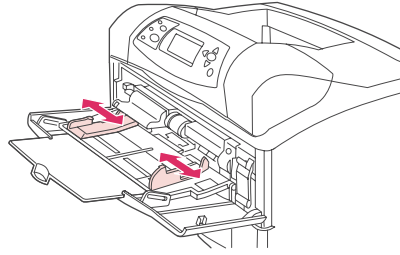

4. Load the media in the tray. Make sure that the media fits under the tabs and below the maximum-height indicators.

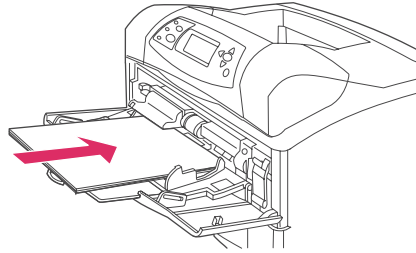

NOTE

Load media with the front side facing up and the top, short edge toward the printer. For information about loading special media, see [Printing on small sizes, custom sizes, or heavy paper](#).

5. Adjust the side guides so that they lightly touch the media stack but do not bend the media.

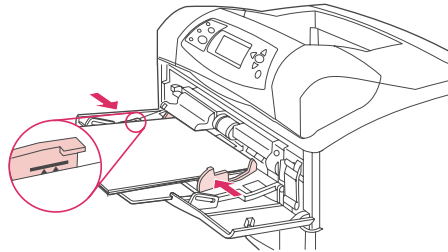

Loading tray 2 or an optional 500-sheet tray

The 500-sheet tray adjusts for six standard sizes (letter, A4, legal, executive, A5, and B5 JIS), and for many custom sizes. See [Supported sizes of print media](#). The printer senses standard sizes if you set the tray guides to a standard size and turn the media knob to Standard.

If an optional stapler/stacker is installed, the printer automatically rotates the printed images 180° on all media sizes, even if the job is not stapled. If you are printing on media that requires a specific orientation, such as letterhead, preprinted media, prepunched media, and media with watermarks, make sure that the media is loaded correctly in the tray. See [Orientation of paper when a stapler is installed](#).

CAUTION

To avoid jams, do not load trays while the printer is printing.

To load tray 2 or an optional 500-sheet tray

1. Pull the tray out and lift up slightly to remove it from the printer.

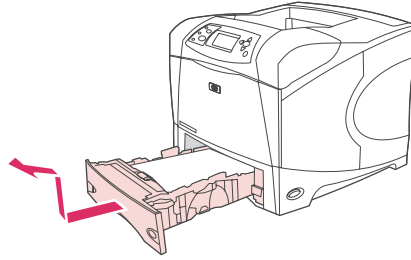

2. Pinch the release that is located on the left guide and slide the side guides to the correct paper size.

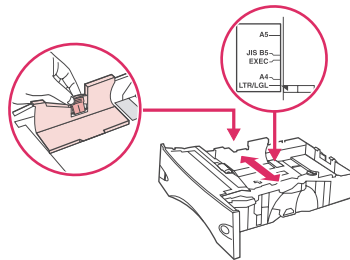

3. Pinch the release that is located on the rear paper guide and slide it to the correct media size.

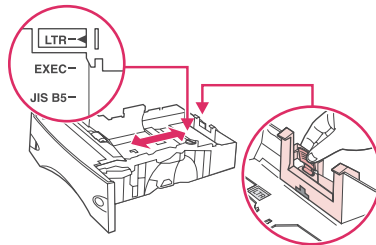

4. On the right side of the tray, turn the knob to Standard for LTR (letter), A4, LGL (legal), EXEC (executive), A5, or JIS B5 paper. Turn the knob to Custom for supported custom paper sizes.

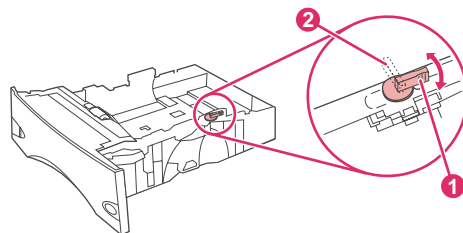

- 1 Standard position
- 2 Custom position

5. Load the paper with the front side facing down and the top edge toward the front of the tray.

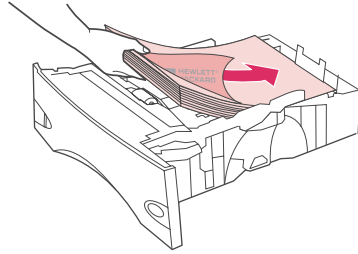

CAUTION

Do not fan the paper. Fanning can cause misfeeds.

6. Make sure that the stack is flat at all four corners and that the top of the stack is below the maximum-height indicators.

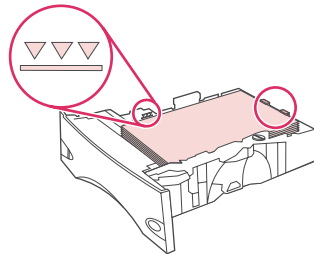

7. Slide the tray completely into the printer.

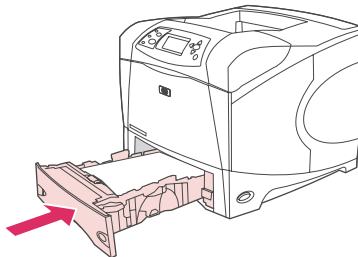

Loading an optional 1,500-sheet tray

The optional 1,500 sheet tray adjusts for letter, A4, and legal sizes. The printer automatically senses which size is loaded if the tray guides are properly adjusted.

If an optional stapler/stacker is installed, the printer automatically rotates the printed images 180° on all paper sizes, even if the job is not stapled. If you are printing on media that requires a specific orientation, such as letterhead, preprinted media, prepunched media, and media with watermarks, make sure that the media is loaded correctly in the tray. (See [Orientation of paper when a stapler is installed.](#))

CAUTION

To avoid jams, do not load trays while the printer is printing.

To load an optional 1,500-sheet tray

1. Open the door of the 1,500-sheet tray.

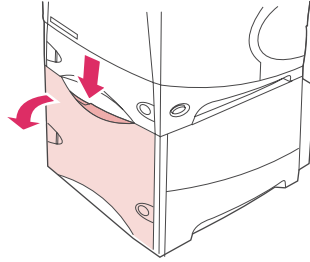

2. If media is in the tray, remove it. When media is in the tray, the guides cannot be adjusted.

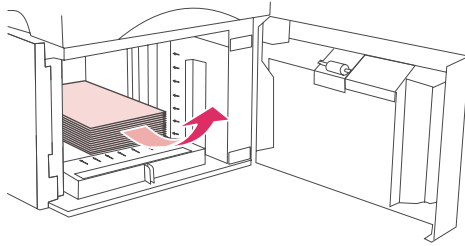

3. Pinch the guides at the front of the tray and slide them to the correct media size.

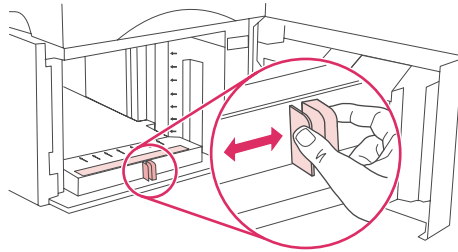

4. Load the media with the front side facing down and the top edge toward the front of the tray.

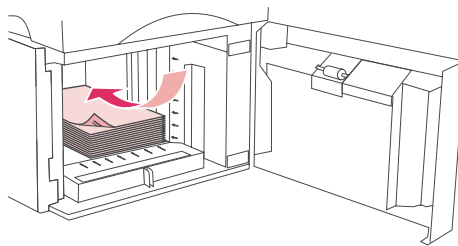

CAUTION

Do not fan the media. Fanning can cause misfeeds.

5. Make sure that the height of the stack does not exceed the maximum-height indicators on the guides and that the front edge of the stack is aligned with the arrows.

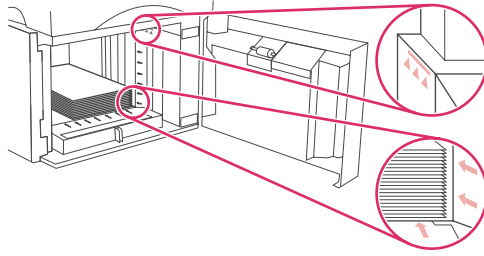

6. Close the door on the tray.

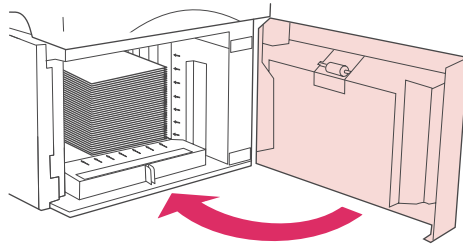

Understanding media output options

The printer has three output locations: the top (standard) output bin, the rear output bin, and the optional stacker or stapler/stacker.

[Printing to the top \(standard\) output bin](#)

[Printing to the rear output bin](#)

[Printing to the optional stacker or stapler/stacker](#)

[Orientation of paper when a stapler is installed](#)

Printing to the top (standard) output bin

The top output bin collects paper face-down, in the correct order. The top output bin should be used for most print jobs, including transparencies. To use the top output bin, be sure that the rear output bin is closed. To avoid jams, do not open or close the rear output bin while the printer is printing.

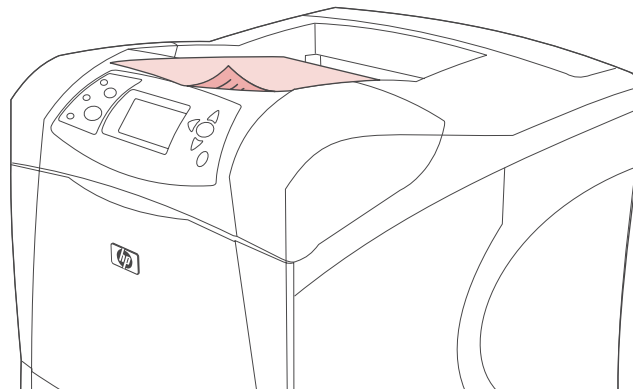

Printing to the rear output bin

The printer always prints to the rear output bin if it is open. Media that is printed to this bin will exit face-up, with the last page on top (reverse order).

Printing from tray 1 to the rear output bin provides the straightest path. Opening the rear output bin might improve performance with the following items:

- Envelopes
- Labels
- Small custom-size paper
- Postcards
- Paper heavier than 120 g/m² (32 lb)

To open the rear output bin, grasp the handle at the top of the bin. Pull the bin down, and slide out the extension.

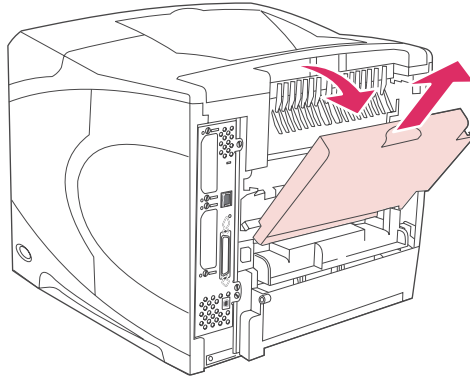

Opening the rear output bin makes the duplexer (if installed) and the top output bin unavailable. To avoid jams, do not open or close the rear output bin while the printer is printing.

Printing to the optional stacker or stapler/stacker

The optional stacker or optional stapler/stacker can hold up to 500 sheets of paper (20-lb paper). The stacker accepts standard and custom paper sizes. The stapler/stacker accepts standard and custom paper sizes, but only letter, legal, and A4 sizes can be stapled. Do not try to send other types of print media, such as labels or envelopes.

When a stapler/stacker is installed, the printer automatically rotates the printed images 180° on all paper sizes, regardless of whether the job is stapled. Paper types that must be printed in the correct orientation, such as letterhead or prepunched paper, might need to be loaded in a different direction. See [Orientation of paper when a stapler is installed](#).

To print to the optional stacker or optional stapler/stacker, select the option in the program, in the printer driver, or at the printer control panel.

Before you use the optional stacker or optional stapler/stacker, ensure that the printer driver is set to recognize it. You need to set this setting only once. See the printer driver online Help for details.

For more information about supported paper, see [Supported sizes of print media](#). For more information about stapling, see [Stapling documents](#).

Orientation of paper when a stapler is installed

When an optional stapler/stacker is installed, the printer automatically rotates the printed images 180° on all paper sizes, even if the job is not stapled. If you are printing on paper that requires a specific orientation, such as letterhead, preprinted paper, prepunched paper, and paper with watermarks, make sure that the paper is loaded correctly in the tray. The correct orientation of the paper in the trays is shown below.

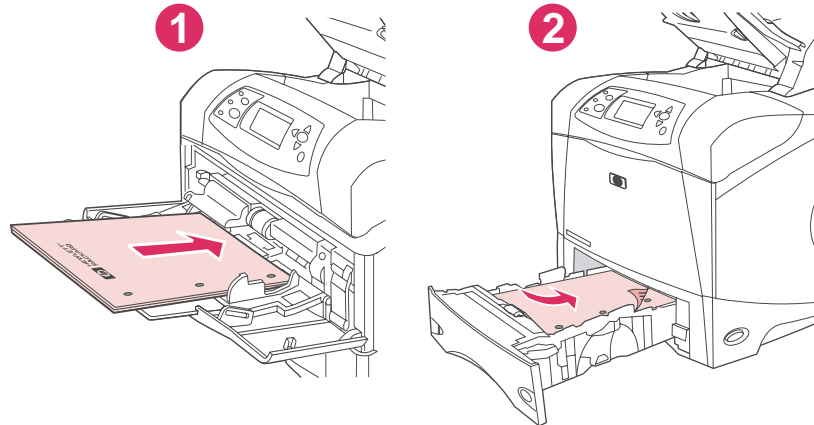

- 1 Tray 1, single-sided print jobs
- 2 All other trays, single-sided print jobs

For single-sided printing and stapling from tray 1, load the paper with the front side facing up and the top edge toward you. For single-sided printing and stapling from all other trays, load the paper with the front side facing down and the top edge toward the printer.

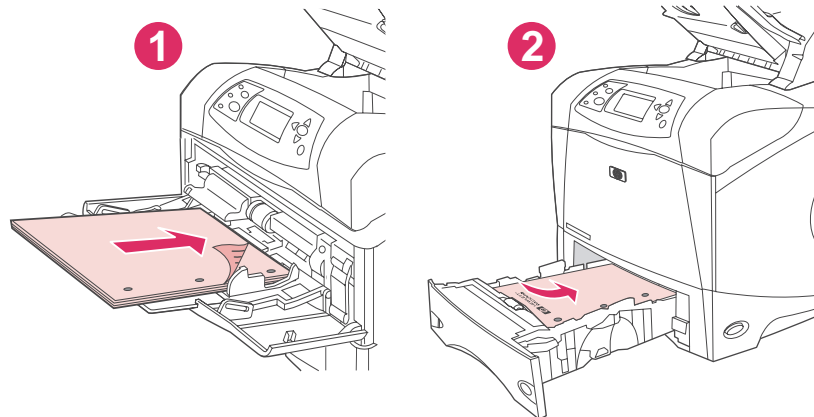

- 1 Tray 1, duplex print jobs
- 2 All other trays, duplex print jobs

For duplex (two-sided) printing and stapling from tray 1, load the paper with the front side facing down and the top edge toward the printer. For duplex printing and stapling from all other trays, load the paper with the front side facing up and the top edge toward you.

Printing envelopes

You can print on envelopes from tray 1 or the optional envelope feeder. Tray 1 holds up to 10 envelopes and supports standard or custom sizes. The optional envelope feeder holds up to 75 envelopes and supports only standard envelope sizes.

For printing on any size of envelope, make sure to set the margins in your program at least 15 mm (0.6 inch) from the edge of the envelope.

Printing performance depends on the construction of the envelope. Always test a few sample envelopes before purchasing a large quantity. For envelope specifications, see [Envelopes](#).

WARNING!

Never use envelopes that contain coated linings, exposed self-stick adhesives, or other synthetic materials. These items can emit noxious fumes.

CAUTION

Envelopes that contain -or- have clasps, snaps, windows, coated linings, exposed self-stick adhesives, or other synthetic materials can severely damage the printer. To avoid jamming and possible printer damage, never try to print on both sides of an envelope. Before you load envelopes, make that sure they are flat and are not damaged or stuck together. Do not use envelopes that have pressure-sensitive adhesive.

NOTE

The printer might print at a slower speed when printing envelopes.

Loading envelopes in tray 1

Many types of envelopes can be printed on from tray 1. Up to 10 can be stacked in the tray. See [Envelopes](#) for specifications.

To load envelopes in tray 1

1. Open tray 1, but do not pull out the extension. Most envelopes feed best without the extension. However, oversize envelopes might need the extension.

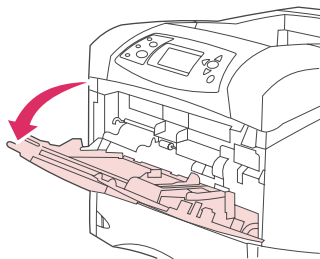

2. Load up to 10 envelopes in the center of tray 1 with the front side facing up, and the postage-end toward the printer. Slide the envelopes into the printer as far as they will go without forcing them.

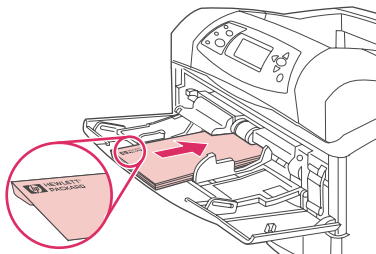

3. Adjust the guides to touch the envelope stack without bending the envelopes. Make sure that the envelopes fit under the tabs and maximum-height indicators on the guides.

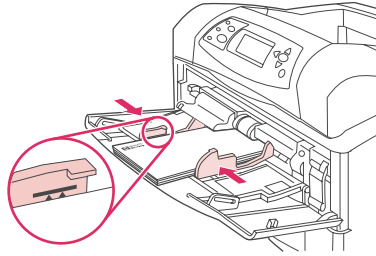

4. To reduce curl and jams, open the rear output bin to use the straight-through paper path.

Feeding envelopes automatically (optional envelope feeder)

With the optional envelope feeder, the printer will automatically feed up to 75 standard-size envelopes. To order an optional envelope feeder, see [Ordering parts, accessories, and supplies](#).

- Print only on envelopes that are approved for use in the printer. See [Envelopes](#) .)
- Before you use the optional envelope feeder, ensure that the printer driver is set to recognize it. You need to set this setting only once. See the printer driver online Help for details.
- Ensure that you are familiar with the parts of the optional envelope feeder.

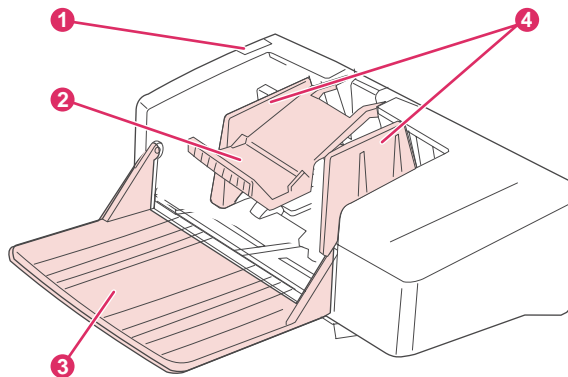

- 1 Release lever
- 2 Envelope weight
- 3 Tray extension
- 4 Guides

Installing the optional envelope feeder

Use these steps to install the optional envelope feeder onto the printer.

To install the optional envelope feeder

1. Open tray 1.

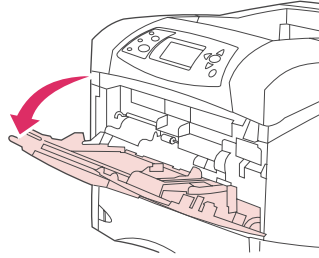

2. Remove the plastic envelope-entrance cover from the printer.

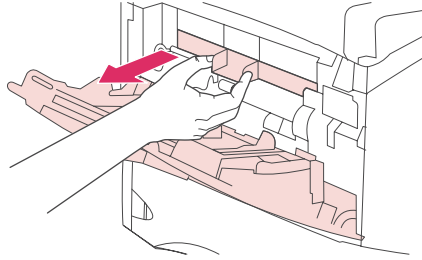

3. Insert the optional envelope feeder firmly into the printer until it latches into position. Pull outward on the optional envelope feeder to be sure that it is securely in place.

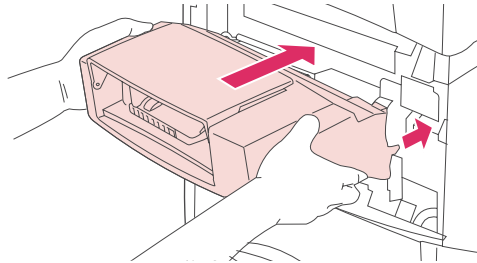

Removing the optional envelope feeder

Use these steps to remove the optional envelope feeder from the printer.

To remove the optional envelope feeder

1. Press the release button that is located on the left side and pull the optional envelope feeder away from the printer.

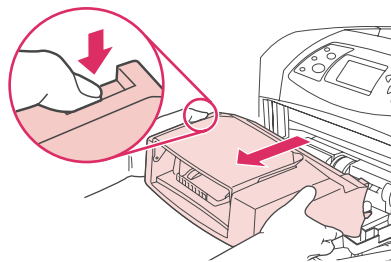

2. Replace the plastic envelope-entrance cover in the printer and close tray 1.

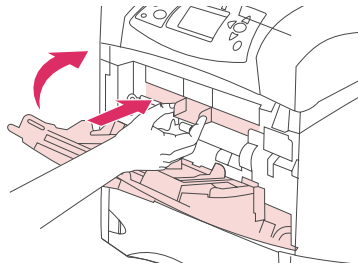

Loading envelopes in the optional envelope feeder

Use these steps to load envelopes in the optional envelope feeder.

To load envelopes in the optional envelope feeder

1. Fold down the envelope-feeder tray. Lift the envelope weight.

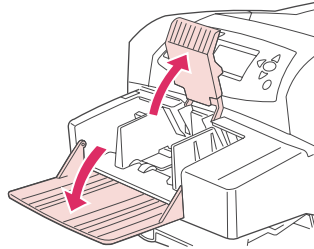

2. Squeeze the release lever that is located on the left envelope guide and slide the guides apart.

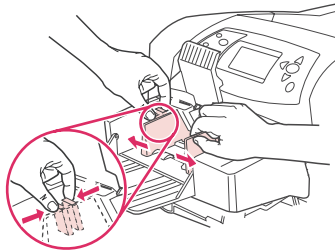

3. Load envelopes with the front side facing up, and the postage-end toward the printer. Stack envelopes no higher than the arrows on the guides. Slide the envelopes into the printer as far as they will go without forcing them. The envelopes at the bottom of the stack should slide in slightly farther than the envelopes at the top of the stack.

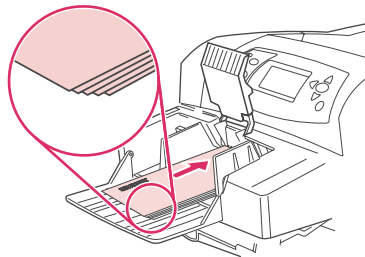

4. Adjust the guides to touch the envelopes without bending them.

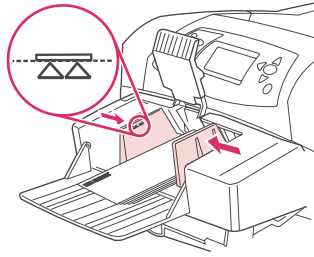

5. Lower the envelope weight onto the envelopes.

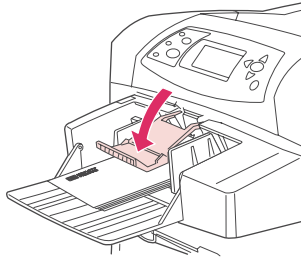

6. To reduce curl and jams, open the rear output bin to use the straight-through paper path.

NOTE

Select the envelope size in one of these locations, trying them in this order: in the program, in the printer driver, or on the Paper Handling menu at the printer control panel. See [Paper Handling menu](#).

Printing on special media

This section discusses printing on types of media that require special handling:

- [Printing on labels](#)
- [Printing on transparencies](#)
- [Printing on letterhead, prepunched, or preprinted paper \(single-sided\)](#)
- [Printing on paper that has a special finish](#)
- [Printing on small sizes, custom sizes, or heavy paper](#)
- [Setting custom paper sizes](#)

Printing on labels

Use only labels that are recommended for use in laser printers. Make sure that labels meet the correct specifications. See [Labels](#).

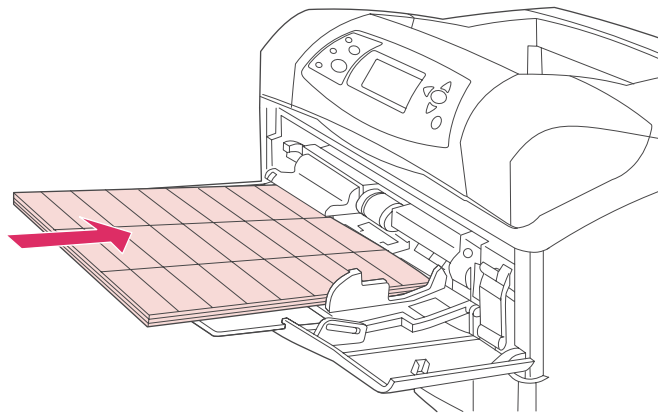

Follow these guidelines when printing on labels:

- Print on a stack of up to 50 label sheets from tray 1 or a stack of up to 100 label sheets from other trays.
- Load labels in tray 1 with the front side facing up, and the top, short edge toward the printer. For other trays, load media with the front side facing down, and the top edge toward you.
- Try opening the rear output bin to reduce curl and other problems.

Do not load or print on labels in the following ways:

CAUTION

Failure to follow these instructions can damage the printer.

- Do not load the trays to maximum capacity, because labels are heavier than paper.
- Do not use labels that are separating from the backing sheet, wrinkled, or damaged in any way.
- Do not use labels that have the backing sheet exposed. (Labels must cover the entire backing sheet, leaving no exposed spaces.)
- Do not feed a sheet of labels through the printer more than once. The adhesive backing is designed for only one pass through the printer.

- Do not print on both sides of labels.
- Do not print on sheets from which labels have been removed.

Printing on transparencies

Use only transparencies that are recommended for use in laser printers. For transparency specifications, see [Transparencies](#).

- At the printer control panel, open the **CONFIGURE DEVICE** menu. On the **PRINT QUALITY** submenu, select **FUSER MODES**. Make sure that the fuser mode is set to **TRANSPARENCY=LOW**.

CAUTION

Failure to set the fuser mode to LOW can permanently damage the printer and fuser.

- In the printer driver, set the paper type to **Transparency**.
- At the printer control panel, open the **PAPER HANDLING** menu. Set the tray type to **TRANSPARENCY** for the tray that you are using.
- Load transparencies face up in tray 1 with the top toward the printer. Up to 50 transparencies can be loaded in tray 1. A stack of up to 100 transparencies can be printed from tray 2 and the optional trays (although stacking more than 50 at a time is not recommended). Because transparencies are heavier than paper, do not load trays to maximum capacity. Load them with the side to be printed on facing down, and the top, short edge toward you.
- To prevent transparencies from becoming too hot or from sticking together, use the top output bin and remove each transparency from the output bin before printing another.
- Print only on one side of a transparency.
- Place transparencies on a flat surface to cool after removing them from the printer.
- If two or more transparencies feed at the same time, try fanning the stack.
- Do not feed transparencies through the printer more than once.

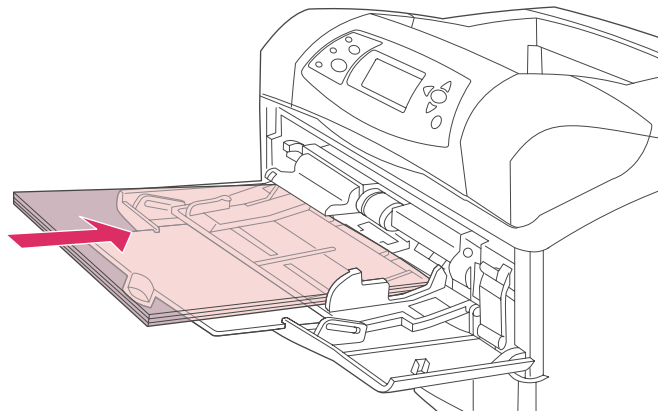

Printing on letterhead, prepunched, or preprinted paper (single-sided)

When printing on letterhead, prepunched, or preprinted paper, it is important to orient the paper correctly. Follow the guidelines in this section for printing on one side only. For duplexing guidelines, see [Printing on both sides of paper \(optional duplexer\)](#).

NOTE

For more information about paper that has a special finish, such as laid or bond paper, see [Printing on paper that has a special finish](#).

For tray 1, load the paper with the front side facing up, and the top, short edge toward the printer.

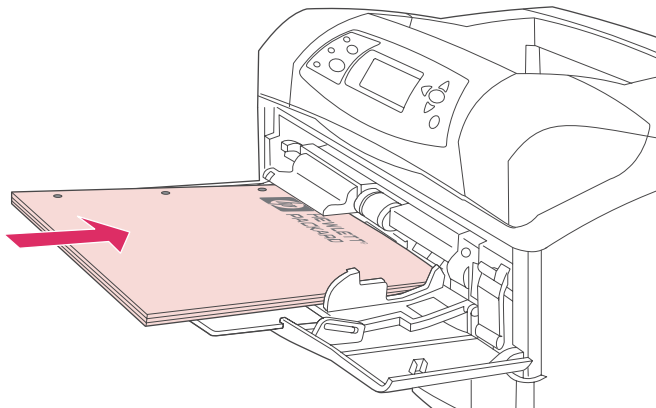

For tray 2, optional 500-sheet trays, and the optional 1,500-sheet tray, load the paper with the front side facing down, and the top, short edge toward you.

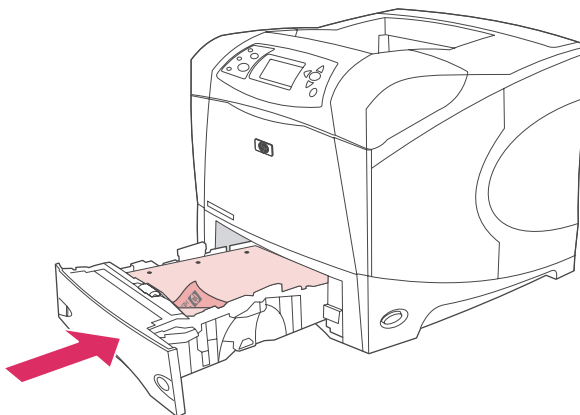

NOTE

When **Alternative Letterhead** mode is enabled in the printer driver, and **Letterhead** or **Preprinted** is selected as the media type, you must orient the media for two-sided (duplex) printing.

Guidelines for printing on letterhead or preprinted forms

- Do not use letterhead paper that is printed with low-temperature inks, such as those used in some types of thermography.
- Do not use raised or embossed letterhead.
- The printer uses heat and pressure to fuse toner to the paper. Make sure that any colored paper or preprinted forms use inks that are compatible with this fusing temperature (200°C or 392°F for .01 second).

Printing on paper that has a special finish

Some paper has a special finish, such as laid paper, bond paper, and cockled paper. These types of paper can cause issues in regard to toner adhesion and print quality. Follow these guidelines when printing on paper that has a special finish.

- At the printer control panel, open the **CONFIGURE DEVICE** menu. On the **PRINT QUALITY** submenu, select **FUSER MODES**, and then select the paper type that you are using (such as **BOND**). Set the fuser mode to **HIGH 1** or **HIGH 2**. **HIGH 2** provides better toner adhesion and optimal print quality for paper that has a highly textured finish. Open the **PAPER HANDLING** menu and set **TRAY TYPE** to the type of paper that you are using (such as **BOND**) to turn on the appropriate fuser mode.

NOTE

The printer might print at a slower speed when set at **HIGH 1** or **HIGH 2**. Use the **HIGH 1** and **HIGH 2** settings only if you are experiencing toner-adhesion problems. The **HIGH 1** and **HIGH 2** settings might increase problems with curl and jams.

- Some makers of these types of paper are now coating one side of the paper to enhance toner adhesion and print quality. To take advantage of this feature, make sure to load the paper correctly. The side on which you can read the watermark correctly is the front side, or the side to be printed on.

For tray 1, load paper with the front side facing up, and the top, short edge toward the printer.

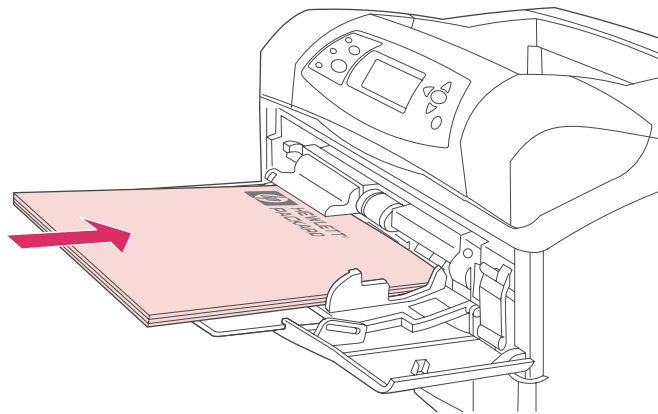

For tray 2, optional 500-sheet trays, and the optional 1,500-sheet tray, load paper with the front side facing down, and the top, short edge toward you.

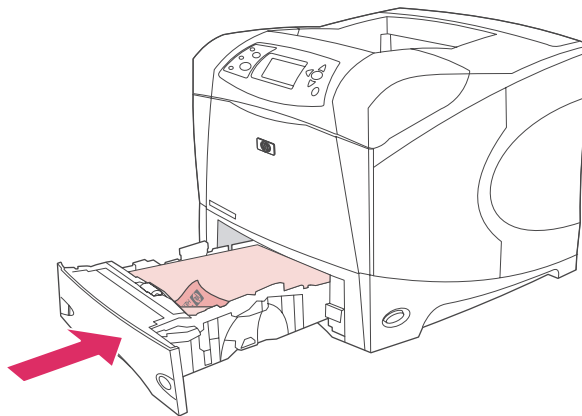

Printing on small sizes, custom sizes, or heavy paper

Custom-size paper can be printed from tray 1, tray 2, or an optional 500-sheet tray.

NOTE

The printer might print at a slower speed when printing on small sizes, custom sizes, and heavy paper. For more information about paper that have a special finish, such as laid or bond paper, see [Printing on paper that has a special finish](#).

Weight and sizes

See the following table for specifications when printing on custom or heavy paper. For more information, see [Paper specifications](#).

Tray	Minimum size	Maximum size	Supported weights
Tray 1	76 x 127 mm (3 x 5 inches)	216 x 356 mm (8.5 x 14 inches)	60 to 200 g/m ² (16 to 53 lb)
Tray 2 and optional 500-sheet tray	148 x 210 mm (5.8 x 8.2 inches)	216 x 356 mm (8.5 x 14 inches)	60 to 120 g/m ² (16 to 32 lb)

Guidelines for heavy paper

Follow these guidelines when printing on heavy paper:

- Paper heavier than 120 g/m² (32 lb) should be printed only from tray 1. To reduce curl and other problems, print heavy paper from tray 1 to the rear output bin.
- To help prevent toner from rubbing off of the paper, some heavier paper types should be printed using a higher fuser mode. At the printer control panel, open the **CONFIGURE DEVICE** menu. On the **PRINT QUALITY** submenu, select **FUSER MODES**, and then select the media type that you want to modify. Select either **HIGH 1** or **HIGH 2** as the fuser mode. Using these modes helps prevent toner from rubbing off the page, but using them might slow the printer speed or create other problems, such as increased curl.

Guidelines for custom-size paper

Follow these guidelines when printing on any custom-size paper:

- Feed the paper short-edge first.
- In your program, set page margins at least 4.23 mm (0.17 inch) away from the edges.
- Set the custom size in the program, in the printer driver, or at the printer control panel. Make sure that you set the switch in the tray to **Custom**. See [Setting custom paper sizes](#).

Additional guidelines for small or narrow paper

Follow these additional guidelines when printing on small or narrow paper:

- Do not attempt to print on paper smaller than 76 mm (3 inches) wide or 127 mm (5 inches) long.
- To reduce curl and other problems, print very small custom-size paper from tray 1 to the rear output bin.
- HP does not recommend printing large quantities of small or narrow paper. Printing large quantities of small or narrow paper can cause excessive wear on the print cartridge components that might result in toner leaking into the printer or might cause print-quality problems.

Setting custom paper sizes

When custom paper is loaded, size settings need to be selected in the program (the preferred method), in the printer driver, or at the printer control panel. To reduce curl and other problems, heavy paper and very small custom-size paper should be printed from tray 1 to the rear output bin.

Feed the paper into the printer short-edge first.

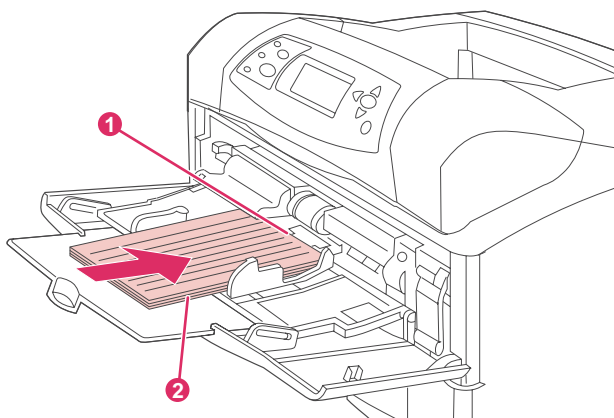

- 1 X dimension (front edge)
- 2 Y dimension (side edge)

If the settings are not available in your program, set the custom paper size at the printer control panel.

To set custom paper sizes

1. If you loaded a 500-sheet tray with custom paper, be sure that the knob is set to **Custom**. (See [Loading tray 2 or an optional 500-sheet tray.](#))
2. Press ✓ (**SELECT** button) to open the menus.
3. Use ▲ (**UP** button) or ▼ (**DOWN** button) to scroll to **PAPER HANDLING**, and then press ✓ (**SELECT** button).
4. Use ▲ (**UP** button) or ▼ (**DOWN** button) to scroll to **TRAY 1 SIZE** or **TRAY [N] SIZE** (where [N] is the number of the tray), and then press ✓ (**SELECT** button).
5. Use ▲ (**UP** button) or ▼ (**DOWN** button) to scroll to **CUSTOM**, and then press ✓ (**SELECT** button).
6. Use ▲ (**UP** button) or ▼ (**DOWN** button) to scroll to **INCHES** or **MILLIMETERS**, and then press ✓ (**SELECT** button). This selects the measurement units for determining the size of your custom paper.
7. Use ▲ (**UP** button) or ▼ (**DOWN** button) to scroll to the correct dimension, and then press ✓ (**SELECT** button) to set the X dimension (the front edge of the paper, as shown in the preceding figure). The X dimension can range from 76 to 216 mm (3 to 8.5 inches).
8. Use ▲ (**UP** button) or ▼ (**DOWN** button) to scroll to the proper dimension, and then press ✓ (**SELECT** button) to set the Y dimension (the side edge of the paper, as shown in the preceding figure). The Y dimension can range from 127 to 356 mm (5 to 14 inches). For example, if the custom paper is 203 x 254 mm, set X=203 mm and Y=254 mm.

Printing on both sides of paper (optional duplexer)

The printer can automatically print on both sides of paper when an automatic duplexer is installed. This is called duplexing. The duplexer supports the following paper sizes: letter, legal, executive, A4, A5, and JIS B5.

NOTE

The automatic duplexer is included with the HP LaserJet 4250dtn, 4250dtnsl, 4350dtn, and 4350dtnsl printers.

For models that do not include an automatic duplexer, you can print on both sides manually. See [To duplex manually](#). You can also order the duplexer as an accessory. See [Ordering parts, accessories, and supplies](#).

The duplex slot cover that is located at the rear of the printer must be removed when the duplexer is installed. See the documentation that is included with the duplexer for installation instructions. When duplexing very complex pages, additional memory might be required. See [Printer memory](#).

When the printer prints by using the duplexer, the page partially protrudes into the top output bin, and then reverses to print on the second side.

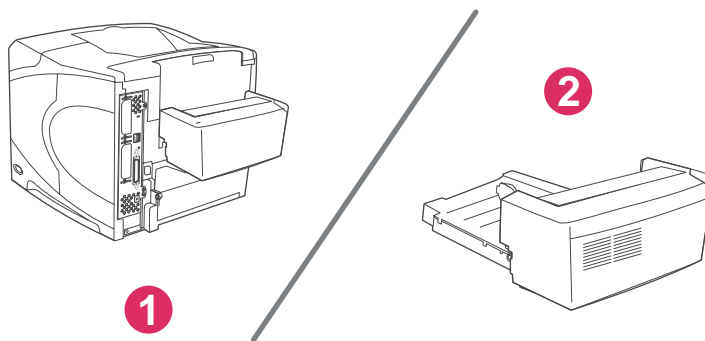

- 1 Duplexer installed
- 2 Duplexer removed

[Guidelines for printing on both sides of paper](#)

[Orientation of paper for duplexing](#)

[Layout options for printing on both sides of paper](#)

[To duplex with the optional duplex-printing accessory](#)

[To duplex manually](#)

Guidelines for printing on both sides of paper

CAUTION

Do not print on both sides of labels, transparencies, envelopes, vellum, custom sizes, or paper heavier than 28 lb (105 g/m²) because jams or damage to the printer might occur.

Note the following guidelines:

- Before using the duplexer, ensure that the printer driver is set to recognize it. The procedure varies according to the operating system that you are using. For details, see [Using the printer drivers](#). Look for the instructions in the column labeled "To change configuration settings."
- To print on both sides of paper, make the selection in your program or the printer driver. (See the printer driver online Help.)
- If you do not use the printer driver that came with the printer, you might need to change the duplex setting at the printer control panel, set **DUPLEX=ON** on the **CONFIGURE DEVICE** menu in the **PRINTING** submenu. Also on the **PRINTING** submenu, set **DUPLEX BINDING** to **LONG EDGE** or **SHORT EDGE**. (For more information, see [Layout options for printing on both sides of paper.](#))
- The rear output bin must be closed to use the duplexer. Opening the rear output bin disables the duplexer.

Orientation of paper for duplexing

Several kinds of paper (such as letterhead, preprinted paper, prepunched paper, and paper with watermarks) require a specific orientation for duplex printing. The duplexer prints the second side of paper first. The proper orientation of the paper in the trays is shown below.

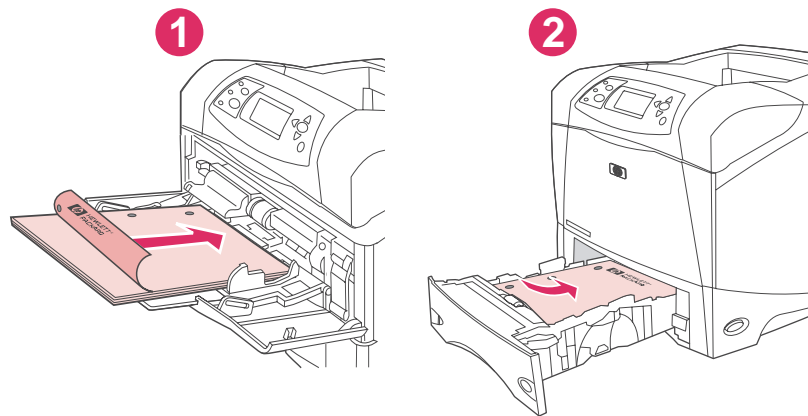

- 1 Tray 1
- 2 All other trays

For tray 1, load the front side facing down and the top edge toward you. For all other trays, load the front side facing up and the top edge toward the printer.

Layout options for printing on both sides of paper

The four duplex orientation options are shown below. These options can be selected in the printer driver (the preferred method) or at the printer control panel. (If you use the printer control panel, go to Configure Device menu, then the Printing submenu. Select DUPLEX BINDING. On the PCL submenu, select a setting for ORIENTATION.)

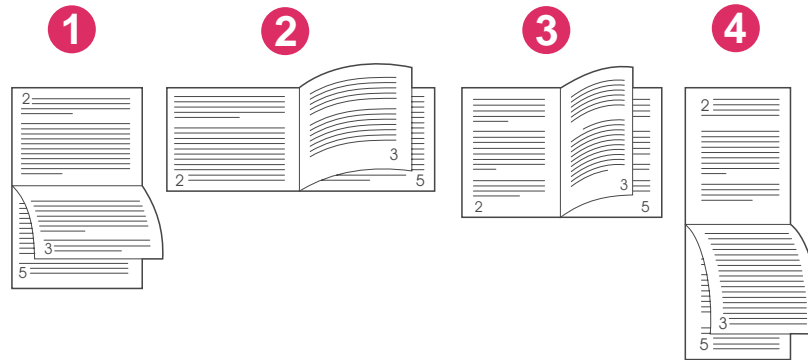

1. Long-edge landscape*	This layout is often used in accounting, data processing, and spreadsheet programs. Every other printed image is oriented upside-down. Facing pages are read continuously from top to bottom.
2. Short-edge landscape	Each printed image is oriented right-side-up. Facing pages are read from top to bottom on the left page, then from top to bottom on the right page.
3. Long-edge portrait	This is the default printer setting, and the most common layout used, with every printed image oriented right-side-up. Facing pages are read from top to bottom on the left page, then from top to bottom on the right page.
4. Short-edge portrait*	This layout is often used with clipboards. Every other printed image is oriented upside-down. Facing pages are read continuously from top to bottom.

* When using Windows drivers, select **Flip Pages Up** to get the designated binding options.

To duplex with the optional duplex-printing accessory

1. Insert enough paper into one of the trays to accommodate the print job. If you are loading special paper such as letterhead, load it in one of the following ways:
 - For tray 1, load the letterhead paper with the front side down, bottom-edge first.
 - For all other trays, load the letterhead paper with front side up, and the top edge toward the back of the tray.

CAUTION

Do not load paper that is heavier than 105 g/m² (28 lb bond). Jamming could result.

2. Open the printer driver (see [Changing the settings for a print job](#)).
3. On the **Finishing** tab, click **Print on Both Sides**. For Macintosh, click **File**, click **Print**, and then click **Layout**.

4. Click **OK**.
5. Send the print job to the printer.

NOTE

The paper that you are printing on will partially come out of the top output bin during duplexing. Do not pull on the paper until duplexing is complete. During duplexing, the duplexer will not function if the rear output bin is open.

To duplex manually

If the printer does not have a duplexer installed, follow these instructions to manually print on both sides. Before attempting to duplex manually, ensure that the printer driver is set to enable manual duplexing. The procedure varies according to the operating system that you are using. For details, see [Using the printer drivers](#). Look for the instructions in the column labeled "To change configuration settings."

NOTE

These instructions are for Windows. To duplex manually with Mac OS 9, perform a custom software installation and load the plug-in for booklet or manual duplex printing. Manual duplexing is not supported for Mac OS X.

1. Insert enough paper into one of the trays to accommodate the print job. If you are loading special paper such as letterhead, load it in one of the following ways:
 - For tray 1, load the letterhead paper with the front side down, bottom-edge first.
 - For all other trays, load the letterhead paper with front side up, and the top edge toward the back of the tray.
2. Open the printer driver (see [Changing the settings for a print job](#)).
3. On the **Finishing** tab, select **Print on Both Sides (Manually)**.
4. Click **OK**.
5. Send the print job to the printer.
6. Go to the printer. After the first sides have finished printing, remove any blank paper that is remaining in tray 1. Insert the printed stack with the blank side up, top-edge **first**. You **must** print the second side from tray 1.
7. If prompted by a message at the control-panel display, press ✓ (**SELECT** button).

NOTE

If the number of total sheets exceeds the tray 1 capacity for manual duplex jobs, you must repeat steps 6 and 7 each time paper is inserted until the duplexing job is complete.

Canceling a print job

You can cancel a print job from a software program or a print queue, or by pressing the **STOP** button on the printer control panel.

- If the printer has not started printing, first try to cancel the job within the software program that sent the print job.
- If the print job is waiting in a print queue or print spooler such as the Printers group on a Windows computer or Print Monitor on a Macintosh computer, delete the job there.
- If the print job is already printing, press the **STOP** button. The printer will finish printing any pages that are already moving through the printer and delete the rest of the print job.

If the control-panel status lights continue to cycle after a job has been canceled, the computer is still sending the job to the printer. Either delete the job from the print queue or wait until the computer has finished sending data (the printer will return to the ready state, with the Ready light on).

Pressing **STOP** cancels only the current job in the printer. If more than one print job is in printer memory, **STOP** must be pressed once for each job.

Using the printer driver

The printer driver provides access to the printer features and allows the computer to communicate with the printer. This section provides instructions for printing when setting options are set from the printer driver.

If possible, try to set printing features from the software program in which you are working or from the Print dialog box. You can set the printer features this way for most Windows and Macintosh software programs. If a setting is not available in the software program or printer driver, you must set it at the printer control panel.

For more information about printer-driver features, see the printer-driver online Help. For more information about printing from a specific software program, see the documentation for the program.

NOTE

Printer-driver settings override control panel settings. Software program settings override both printer-driver settings and control panel settings.

Changing the settings for a print job

If you want printing settings to be used only in the software program you are using, change the settings from the program. After you quit the program, the printer settings return to the defaults that are configured in the printer driver.

To change print settings for a print job on Windows computers

1. In the software program, click **File**.
2. Click **Print**.
3. Click **Setup** or click **Properties**. (The options might be different for your program.)
4. Change the print settings.
5. When you are finished, click **OK**.

To change print settings for a print job on Macintosh computers

1. In the software program, click **File**.
2. Click **Print**.
3. In the dialog box that appears, select the print settings that you want to change and make the changes.
4. When you are finished, click **OK**.

Changing default settings

If you want printing settings to be used in all software programs you use on the computer, change the default settings in the printer driver.

Choose the procedure for your operating system:

- [To change default settings in Windows 98 and Windows Me](#)
- [To change default settings in Windows NT 4.0](#)

- [To change default settings in Windows 2000, Windows XP, and Windows Server 2003](#)
- [To change default settings in Macintosh operating systems](#)

To change default settings in Windows 98 and Windows Me

1. Click the **Start** button.
2. Click **Settings**.
3. Click **Printers**.
4. Right-click the HP LaserJet 4250 or 4350 series printer icon.
5. Click **Properties**.
6. Change any of the settings on the tabs. These settings are now the defaults for the printer.
7. Click **OK** to save your settings and to close the printer driver.

To change default settings in Windows NT 4.0

1. Click the **Start** button.
2. Click **Settings**.
3. Click **Printers**.
4. Right-click the HP LaserJet 4250 or 4350 series series printer icon.
5. Click **Document Defaults**.
6. Change any of the settings on the tabs. These settings are now the defaults for the printer.
7. Click **OK** to save your settings and to close the printer driver.

To change default settings in Windows 2000, Windows XP, and Windows Server 2003

1. Click the **Start** button.
2. Click **Settings**.
3. Click **Printers** (Windows 2000) or **Printers and Faxes** (Windows XP and Windows Server 2003).
4. Right-click the HP LaserJet 4250 or 4350 series printer icon.
5. Click **Properties**.
6. On the **Advanced** tab, click **Printing Defaults**.
7. Change any of the settings on the tabs. These settings are now the defaults for the printer.
8. Click **OK** to return to the **Advanced** tab.
9. Click **OK** to save your settings and to close the printer driver.

To change default settings in Macintosh operating systems

Depending on the Macintosh operating system version that you have, use either the Apple Desktop Printer Utility, the Print Center, or the Print Setup Utility to change printer driver defaults.

Using printer-driver features

This section provides instructions for common printing features that are controlled through the printer driver.

- [Printing watermarks](#)
- [Printing multiple pages on one sheet of paper](#)
- [Setting a custom paper size](#)
- [Using EconoMode \(draft\) printing](#)
- [Selecting print-quality settings](#)
- [Using reduce/enlarge options](#)
- [Selecting a paper source](#)
- [Printing a cover, a different first or last page, or a blank page](#)

Printing watermarks

A watermark is a marking, such as "Top Secret," "Draft," or someone's name, printed in the background of selected pages in a document.

NOTE

If you are using Windows NT 4.0, Windows 2000, Windows XP, or Windows Server 2003 you must have administrator privileges to create watermarks.

To print a watermark on Windows computers (all versions)

1. Open the printer driver (see [Changing the settings for a print job](#)).
2. On the **Effects** tab, select a watermark from the **Watermarks** drop-down list. To edit or create a watermark, click **Edit**.
3. Click **OK**.

To print a watermark on Macintosh computers

Select **Custom** and specify the text that you want, depending on your printer-driver version.

NOTE

Watermarks are supported only for Mac OS 9.x. Watermarks are not supported for Mac OS X V10.1 and later.

Printing multiple pages on one sheet of paper

You can print more than one document page on a single sheet of paper (this is sometimes called 2-up, 4-up, or n-up printing). The pages will appear decreased in size and arranged on the sheet. You can specify that up to 16 pages are to be printed on a single sheet. This feature provides a cost-effective and environmentally friendly way to print draft pages, especially when combined with duplex printing (see [Printing on both sides of paper \(optional duplexer\)](#)).

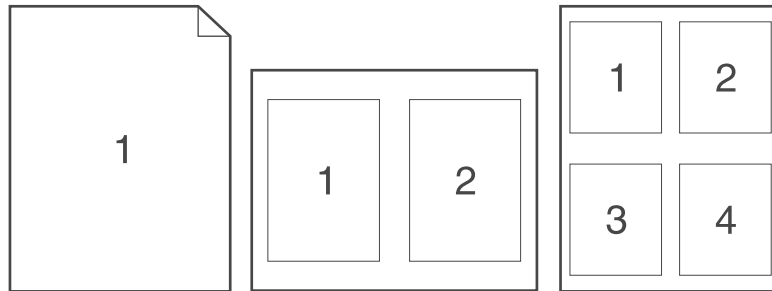

To print multiple pages on one side of a sheet of paper on Windows computers (all versions)

1. Open the printer driver (see [Changing the settings for a print job](#)).
2. On the **Finishing** tab, select the number of pages per sheet from the **Pages per sheet** drop-down menu.
3. If you want borders around the pages, click **Print Page Borders**.
4. Select the page order from the **Page Order** drop-down list.
5. Click **OK**.

Setting a custom paper size

Use the custom paper feature to print on paper sizes other than standard sizes.

To set a custom paper size on Windows computers

1. Open the printer driver (see [Changing the settings for a print job](#)).
2. On the **Paper/Quality** tab, click **Custom**.
3. Specify the custom width and height.
4. Click **Close**.
5. Click **OK**.

To set a custom paper size on Macintosh computers

For Mac OS 9

1. On the **File** menu, select **Page Setup**.
2. From the **Page Attributes** drop-down menu, select **Custom Page Size**.
3. Click **New** to create a named custom page size. The new custom page is automatically added to the **Page Size** menu in **Page Setup**.

For Mac OS X

1. On the **File** menu, select **Page Setup**.
2. On the **Settings** drop-down menu, click **Page Attributes**, and then click **Custom Paper Size**.
3. Click **New**, and type in a name for the custom paper size.
4. Type the height and width for the custom paper size. Click **Save**.
5. On the **Settings** drop-down menu, click **Page Attributes**. Make sure that the **Format for** drop-down menu is set for **Any Printer**.
6. In the **Page Attributes** window, click **Paper Size**, and then select the new custom paper size. Verify that the dimensions are correct.
7. Click **OK**.

Using EconoMode (draft) printing

Use EconoMode (draft) printing to print with less toner on each page. Selecting this option might extend the life of your print cartridge and reduce your cost per page, but will reduce print quality.

HP does not recommend full-time use of EconoMode. If Economode is used full-time when the average toner coverage is significantly less than five percent, it is possible that the toner supply will outlast the mechanical parts in the print cartridge. If print quality begins to degrade under these circumstances, you will need to install a new print cartridge, even if toner remains in the cartridge,

To use EconoMode (draft) printing on Windows computers

1. Open the printer driver (see [Changing the settings for a print job](#)).
2. On the **Paper/Quality** tab, click **EconoMode**.
3. Click **OK**.

Selecting print-quality settings

If you need advanced print quality, you can select from custom settings.

Resolution options

- **Best Quality** - use ProRes 1200 for the best print quality.
- **Faster Printing** - use FastRes 1200 as an alternative resolution for complex graphics or faster output.
- **Custom** - use this option to specify print-quality settings.

NOTE

Changing resolution can change the formatting of your text.

To select print-quality settings on Windows computers

1. Open the printer driver. See [Changing the settings for a print job](#).
2. On the **Paper/Quality** tab, select the resolution or print-quality settings that you want from the **Print Quality** drop-down menu.
3. Click **OK**.

Using reduce/enlarge options

Use the reduce/enlarge options to scale your document to a percentage of its normal size. You can also choose to scale your document to fit on any size of paper that the printer supports.

To set reduce/enlarge options on Windows computers

1. Open the printer driver. See [Changing the settings for a print job](#).
2. On the **Effects** tab, click **% of Normal Size**.
3. Use the number box or slider scale to reduce or enlarge the scale.
4. Click **OK**.

Selecting a paper source

If your software program supports printing paper by source, make the selections from the program. Program settings override printer-driver settings.

To select a paper source on Windows computers

1. Open the printer driver. See [Changing the settings for a print job](#).
2. On the **Paper/Quality** tab, select the source from the **Source is** drop-down list.
3. Click **OK**.

To select a paper source on Macintosh computers

For Mac OS 9: Select a paper source from the **General** options in the printer driver.

For Mac OS X: Click **File**, then click **Print**, and then click **Paper Feed**.

Printing a cover, a different first or last page, or a blank page

Use the following procedure to print the covers of a document on a different media type than the rest of the document or to print the first or last page of a document on different media. For example, to print the first page of a document on letterhead paper and the rest on plain paper, or to print a cover on card stock and the subsequent pages on plain paper. You can also use this feature to insert blank pages between documents when printing several copies.

This option might not be available in all printer drivers.

To print covers or different pages on Windows computers

NOTE

This procedure changes the printer's settings for one print job. To change the printer's default settings, see [Changing default settings](#).

1. Open the printer driver (see [Changing the settings for a print job](#)).
2. On the **Paper/Quality** tab, click **Use different paper/Covers**.
3. To print covers or to insert a blank page between documents, select **Front Cover** or **Back Cover** from the drop-down list. Click **Add a Blank or Preprinted Cover**. Select the **Source is** and **Type is** for the cover or blank page. The blank page can be either a front cover or a back cover. Click **OK**.
4. To print a different first or last page, select **First Page**, **Other Pages**, or **Last Page** from the drop-down list. Select the **Source is** and **Type is** for the different pages. Click **OK**.

To print covers or different pages on Macintosh computers

For Mac OS 9: In the **Print** dialog box, select **First from** and **Remaining from**.

For Mac OS X: Click **File**, then click **Print**, and then click **Paper Feed**.

Using job-storage features

The printer supports four distinct job-storage features that you can use to initiate printing from the printer control panel after the print job is sent from the computer:

- Quick copy jobs
- Proof and hold jobs
- Private jobs
- Stored jobs

Some features are available without an optional hard disk installed, but to use all of the job-storage features, you must install an optional hard disk accessory in the printer and then properly configure the drivers. To support job-storage features for complex jobs, HP recommends that you install additional memory. For information about ordering an optional hard disk or more memory, see [Part numbers](#).

Make sure that you identify your jobs in the printer driver before printing. Using default names might overwrite previous jobs that have the same default name or cause the job to be deleted.

NOTE

If you turn the printer power off, all quick copy, proof and hold, and private jobs are deleted. A job can also be deleted at the printer control panel.

Quick copying a job

The quick copy feature prints the requested number of copies of a job and stores a copy on the optional hard disk or, if a hard disk is not installed, it stores the copy on the RAM disk. Additional copies of the job can be printed later. This feature can be turned off in the printer driver.

For more information about specifying the number of quick copy jobs that can be stored, see [Changing printer-control-panel configuration settings](#).

NOTE

If you turn the printer power off, all quick copy, proof and hold, and private jobs are deleted. A job can also be deleted at the printer control panel.

To print copies of a stored job

1. Press **MENU** to enter the menus.
2. Use ▲ (**UP** button) or ▼ (**DOWN** button) to scroll to **RETRIEVE JOB**, and then press ✓ (**SELECT** button).
3. Use ▲ (**UP** button) or ▼ (**DOWN** button) to scroll to the user name, and then press ✓ (**SELECT** button).
4. Use ▲ (**UP** button) or ▼ (**DOWN** button) to scroll to the user or job name, and then press ✓ (**SELECT** button).
5. Use ▲ (**UP** button) or ▼ (**DOWN** button) to scroll to **PRINT**, and then press ✓ (**SELECT** button).
6. Use ▲ (**UP** button) or ▼ (**DOWN** button) to select the number of copies, and then press ✓ (**SELECT** button).

Deleting a quick copy job

When you send a quick copy job, the printer overwrites any previous jobs that have the same user and job name. If no quick copy job is already stored under the same user and job name, and the printer needs additional space, the printer might delete other quick copy jobs, starting with the oldest job. The default number of quick copy jobs that can be stored is 32. You can change the number of quick copy jobs that can be stored at the printer control panel. See [Changing printer-control-panel configuration settings](#).

NOTE

If you turn the printer power off, all quick copy, proof and hold, and private jobs are deleted. A job can also be deleted at the printer control panel.

To delete a quick copy job

1. Press **MENU** to enter the menus.
2. Use ▲ (**UP** button) or ▼ (**DOWN** button) to scroll to **RETRIEVE JOB**, and then press ✓ (**SELECT** button).
3. Use ▲ (**UP** button) or ▼ (**DOWN** button) to scroll to the user name, and then press ✓ (**SELECT** button).
4. Use ▲ (**UP** button) or ▼ (**DOWN** button) to scroll to the user or job name, and then press ✓ (**SELECT** button).
5. Use ▲ (**UP** button) or ▼ (**DOWN** button) to scroll to **DELETE**, and then press ✓ (**SELECT** button).

Proofing and holding a job

The proof and hold feature provides a quick and easy way to print one copy of a job for proofing before printing the additional copies.

NOTE

If you turn the printer power off, all quick copy, proof and hold, and private jobs are deleted.

To print the remaining copies of a held job

1. Press ✓ (**SELECT** button) to open the menus.
2. Use ▲ (**UP** button) or ▼ (**DOWN** button) to scroll to **RETRIEVE JOB**, and then press ✓ (**SELECT** button).
3. Use ▲ (**UP** button) or ▼ (**DOWN** button) to scroll to the user name, and then press ✓ (**SELECT** button).
4. Use ▲ (**UP** button) or ▼ (**DOWN** button) to scroll to the user or job name, and then press ✓ (**SELECT** button).
5. Use ▲ (**UP** button) or ▼ (**DOWN** button) to scroll to **PRINT**, and then press ✓ (**SELECT** button).
6. Use ▲ (**UP** button) or ▼ (**DOWN** button) to scroll to the number of copies, and then press ✓ (**SELECT** button).

Deleting a held job

When you send a proof and hold job, the printer automatically deletes your previous proof and hold job. If no proof and hold job already exists with that job name, and the printer needs additional space, the printer might delete other proof and hold jobs starting with the oldest one.

NOTE

If you turn the printer power off, all quick copy, proof and hold, and private jobs are deleted. A held job can also be deleted at the printer control panel.

To delete a held job

1. Press ✓ (**SELECT** button) to open the menus.
2. Use ▲ (**UP** button) or ▼ (**DOWN** button) to scroll to **RETRIEVE JOB**, and then press ✓ (**SELECT** button).
3. Use ▲ (**UP** button) or ▼ (**DOWN** button) to scroll to the user name, and then press ✓ (**SELECT** button).
4. Use ▲ (**UP** button) or ▼ (**DOWN** button) to scroll to the user or job name, and then press ✓ (**SELECT** button).
5. Use ▲ (**UP** button) or ▼ (**DOWN** button) to scroll to **DELETE**, and then press ✓ (**SELECT** button).

Printing a private job

Use the private printing feature to specify that a job is not printed until you release it by typing a four-digit personal identification number (PIN) at the printer control panel. You specify the PIN in the printer driver, and it is sent to the printer as part of the print job.

To specify a private job

To specify in the driver that a job is private, select the **Private Job** option and type a 4-digit PIN.

To print a private job

1. Press ✓ (**SELECT** button) to open the menus.
2. Use ▲ (**UP** button) or ▼ (**DOWN** button) to scroll to **RETRIEVE JOB**, and then press ✓ (**SELECT** button).
3. Use ▲ (**UP** button) or ▼ (**DOWN** button) to scroll to the user name, and then press ✓ (**SELECT** button).
4. Use ▲ (**UP** button) or ▼ (**DOWN** button) to scroll to the user or job name, and then press ✓ (**SELECT** button).
5. Use ▲ (**UP** button) or ▼ (**DOWN** button) to scroll to **PRINT**. A lock symbol appears next to **PRINT**. Press ✓ (**SELECT** button).
6. You are prompted to type the PIN number. Use ▲ (**UP** button) or ▼ (**DOWN** button) to change the first number of the PIN, and then press ✓ (**SELECT** button). An **asterisk (*)** appears in place of the number. Repeat these steps to change the remaining three numbers of the PIN.

7. Use ▲ (UP button) or ▼ (DOWN button) to scroll to the number of copies, and then press ✓ (SELECT button).

Deleting a private job

A private job is automatically deleted after the user releases it for printing, unless the user selects the **Stored Job** option in the printer driver.

NOTE

If you turn the printer power off, all quick copy, proof and hold, and private jobs are deleted. A private job can also be deleted at the printer control panel before it is ever printed.

To delete a private job

1. Press ✓ (SELECT button) to open the menus.
2. Use ▲ (UP button) or ▼ (DOWN button) to scroll to **RETRIEVE JOB**, and then press ✓ (SELECT button).
3. Use ▲ (UP button) or ▼ (DOWN button) to scroll to the user name, and then press ✓ (SELECT button).
4. Use ▲ (UP button) or ▼ (DOWN button) to scroll to the user or job name, and then press ✓ (SELECT button).
5. Use ▲ (UP button) or ▼ (DOWN button) to scroll to **DELETE**, and then press ✓ (SELECT button). (A lock symbol appears next to **DELETE**.)
6. You are prompted to type the PIN number. Use ▲ (UP button) or ▼ (DOWN button) to change the first number of the PIN, and then press ✓ (SELECT button). An **asterisk (*)** appears in place of the number. Repeat these steps to change the remaining three numbers of the PIN.

Storing a print job

You can download a print job to the optional hard disk without printing it. You can then print the job at any time at the printer control panel. For example, you might want to download a personnel form, a calendar, a time sheet, or an accounting form that other users can gain access to and print.

To store a print job

To store a print job permanently on the optional hard disk, select the **Stored Job** option in the printer driver when you print the job.

To print a stored job

1. Press ✓ (**SELECT** button) to open the menus.
2. Use ▲ (**UP** button) or ▼ (**DOWN** button) to scroll to **RETRIEVE JOB**, and then press ✓ (**SELECT** button).
3. Use ▲ (**UP** button) or ▼ (**DOWN** button) to scroll to the user name, and then press ✓ (**SELECT** button).
4. Use ▲ (**UP** button) or ▼ (**DOWN** button) to scroll to the user or job name, and then press ✓ (**SELECT** button).
5. Use ▲ (**UP** button) or ▼ (**DOWN** button) to scroll to **PRINT**, and then press ✓ (**SELECT** button).
6. Use ▲ (**UP** button) or ▼ (**DOWN** button) to scroll to the number of copies, and then press ✓ (**SELECT** button).

To delete a stored job

1. Press ✓ (**SELECT** button) to open the menus.
2. Use ▲ (**UP** button) or ▼ (**DOWN** button) to scroll to **RETRIEVE JOB**, and then press ✓ (**SELECT** button).
3. Use ▲ (**UP** button) or ▼ (**DOWN** button) to scroll to the user name, and then press ✓ (**SELECT** button).
4. Use ▲ (**UP** button) or ▼ (**DOWN** button) to scroll to the user or job name, and then press ✓ (**SELECT** button).
5. Use ▲ (**UP** button) or ▼ (**DOWN** button) to scroll to **DELETE**, and then press ✓ (**SELECT** button).

3

Managing and maintaining the printer

This chapter contains information about these topics:

- [Using the embedded Web server](#)
- [Using HP Web Jetadmin software](#)
- [Using the HP Toolbox](#)
- [Uninstalling the HP Toolbox](#)
- [Managing and configuring printer drivers](#)
- [Configuring e-mail alerts](#)
- [Setting the real-time clock](#)
- [Checking the printer configuration](#)
- [Managing the print cartridge](#)
- [Cleaning the printer](#)
- [Performing preventive maintenance](#)
- [Replacing the stapler unit](#)

Using the embedded Web server

Use the embedded Web server to view printer and network status and to manage printing functions from your computer instead of from the printer control panel. The following are examples of what you can do using the embedded Web server:

- View printer-control status information.
- Set the type of media that is loaded in each tray.
- Determine the remaining life for all supplies and order new ones.
- View and change tray configurations.
- View and change the printer control-panel menu configuration.
- View and print internal pages.
- Receive notification of printer and supplies events.
- View and change network configuration.

The embedded Web server feature requires at least 48 MB of RAM and an HP Jetdirect print server in order to connect to your network.

To use the embedded Web server, you must have Microsoft Internet Explorer 5.01 or later or Netscape 6.2 or later for Windows, Mac OS, and Linux (Netscape only). Netscape Navigator 4.7 is required for HP-UX 10 and HP-UX 11. The embedded Web server works when the printer is connected to an IP-based network. The embedded Web server does not support IPX-based printer connections. You do not have to have Internet access to open and use the embedded Web server.

When the printer is directly connected to a computer, the embedded Web server is supported for Windows 98 and later. In order to use the embedded Web server with a direct connection, you must select the Custom installation option when you install the printer driver. Select the option to load the HP Toolbox. The proxy server is installed as part of the HP Toolbox software.

When the printer is connected to the network, the embedded Web server is automatically available.

Another option for access to the embedded Web server is the HP Printer Access Tool. The HP Printer Access Tool software provides a single point of access to the embedded Web server (EWS) for all of the networked printers in each user's local Printers folder. By using a Web browser, users can view the supplies-status information, control print jobs, and manage product configuration through the EWS.

Opening the embedded Web server

1. In a supported Web browser on your computer, type the IP address for the printer. To find the IP address, print a configuration page. For more information about printing a configuration page, see [Configuration page](#).

NOTE

After you open the URL, you can bookmark it so that you can return to it quickly in the future.

2. The embedded Web server has three tabs that contain settings and information about the printer: the **Information** tab, the **Settings** tab, and the **Networking** tab. Click the tab that you want to view.
3. See the following sections for more information about each tab.

Information tab

The Information pages group consists of the following pages.

- **Device Status.** This page shows the printer status and shows the life remaining of HP supplies, with 0% representing that a supply is empty. The page also shows the type and size of print media set for each tray. To change the default settings, click **Change Settings**.
- **Configuration page.** This page shows the information that is found on the printer configuration page.
- **Supplies Status.** This page shows the life remaining of HP supplies, with 0% representing that a supply is empty. This page also provides supplies part numbers. To order new supplies, click **Order Supplies** in the **Other Links** area of the window. To visit any Web site, you must have Internet access.
- **Event log.** This page shows a list of all printer events and errors.
- **Device information.** This page also shows the printer network name, address, and model information. To change these entries, click **Device Information** on the **Settings** tab.
- **Control panel.** Click this button to view the current status of the printer control panel.

Settings tab

Use this tab to configure the printer from your computer. The **Settings** tab can be password protected. If this printer is networked, always consult with the printer administrator before changing settings on this tab.

The **Settings** tab contains the following pages.

- **Configure Device.** Configure all printer settings from this page. This page contains the traditional menus found on printers that use a control-panel display. These menus include **Information**, **Paper Handling**, and **Configure Device**.
- **Alerts.** Network only. Set up to receive e-mail alerts for various printer and supplies events.
- **Email.** Network only. Used in conjunction with the Alerts page to set up incoming and outgoing e-mail.
- **Security.** Set a password that must be typed in order to gain access to the **Settings** and **Networking** tabs. Turn on and off certain features of the EWS.
- **Other Links.** Add or customize a link to another Web site. This link is shown in the **Other Links** area on all embedded Web server pages. These permanent links always appear in the **Other Links** area: **HP Instant Support**, **Order Supplies**, and **Product Support**.
- **Device Information.** Name the printer and assign an asset number to it. Type the name and e-mail address for the primary contact who will receive information about the printer.
- **Language.** Determine the language in which to show the embedded Web server information.
- **Time Services.** Set the printer to retrieve the date and time from a network server at regular intervals.

Networking tab

The network administrator can use this tab to control network-related settings for the printer when it is connected to an IP-based network. This tab will not appear if the printer is directly connected to a computer, or if the printer is connected to a network with anything other than an HP Jetdirect print server.

Other links

This section contains links that connect you to the Internet. You must have Internet access in order to use any of these links. If you use a dial-up connection and did not connect when you first opened the embedded Web server, you must connect before you can visit these Web sites. Connecting might require that you close the embedded Web server and reopen it.

- **HP Instant Support.** Connects you to the HP Web site to help you find solutions. This service analyzes your printer error log and configuration information to provide diagnostic and support information specific to your printer.
- **Order Supplies.** Click this link to connect to an ordering Web site and order genuine HP supplies, such as print cartridges and media.
- **Product Support.** Connects to the support site for the HP LaserJet 4250 or 4350 series printer. Then, you can search for help regarding general topics.

Using HP Web Jetadmin software

HP Web Jetadmin is a Web-based software solution for remotely installing, monitoring, and troubleshooting network-connected peripherals. The intuitive browser interface simplifies cross-platform management of a wide range of devices, including HP and non-HP printers. Management is proactive, allowing network administrators the ability to resolve printer issues before users are affected. Download this free, enhanced-management software at http://www.hp.com/go/webjetadmin_software.

To obtain plug-ins to HP Web Jetadmin, click **plug-ins**, and then click the **download** link that is next to the name of the plug-in that you want. The HP Web Jetadmin software can automatically notify you when new plug-ins are available. On the **Product Update** page, follow the directions to automatically connect to the HP Web site.

If installed on a host server, HP Web Jetadmin is available to any client through a supported Web browser, such as Microsoft Internet Explorer 6.0 for Windows or Netscape Navigator 7.1 for Linux. Browse to the HP Web Jetadmin host.

NOTE

Browsers must be Java-enabled. Browsing from an Apple PC is not supported.

Using the HP Toolbox

HP Toolbox is a Web application that you can use for the following tasks:

- Check the printer status.
- Configure the printer settings.
- View troubleshooting information.
- View online documentation.

You can view the HP Toolbox when the printer is directly connected to your computer or when it is connected to the network. You must perform a complete software installation in order to use the HP Toolbox.

NOTE

You do not have to have Internet access to open and use the HP Toolbox. However, if you click a link in the **Other Links** area, you must have Internet access to go to the site that is associated with the link. See [Other links](#) for more information.

Supported operating systems

The HP Toolbox is supported for the following operating systems:

- Windows 98, 2000, Me, XP, and Server 2003
- Mac OS X, Version 10.2 or higher

Supported browsers

To use the HP Toolbox, you must have one of the following browsers:

Windows

- Microsoft Internet Explorer 5.5 or higher
- Netscape Navigator 7.0 or higher
- Opera Software ASA Opera 6.05 or higher

Macintosh (OS X only)

- Microsoft Internet Explorer 5.1 or higher
- Netscape Navigator 7.0 or higher

All pages can be printed from the browser.

To view the HP Toolbox

1. Open the HP Toolbox in one of these ways:
 - On the Windows desktop, double-click the HP Toolbox icon.
 - From the Windows **Start** menu, click **Programs**, and then click **HP Toolbox**.
 - For Macintosh OS X, on the hard drive, click **Applications**, and then click the **Utilities** folder. Double-click the **HP Toolbox icon**.

NOTE

After you open the URL, you can bookmark it so that you can return to it quickly in the future.

2. The HP Toolbox opens in a Web browser. The HP Toolbox software contains the following sections:
 - [Status tab](#)
 - [Troubleshooting tab](#)
 - [Alerts tab](#)
 - [Documentation tab](#)
 - [Device Settings window](#)
 - [Toolbox links](#)
 - [Other links](#)

Status tab

The **Status** tab has links to the following main pages:

- **Device Status.** View printer status information. This page indicates printer conditions such as a jam or an empty tray. After you correct a problem with the printer, click the **Refresh** button to update the device status.
- **Supplies Status.** View detailed supplies status such as the percent of life remaining in the print cartridge and the number of pages that have been printed with the current print cartridge. This page also has links to order supplies and to find recycling information.
- **Print Info.** Print the configuration page and various other information pages that are available for the printer, such as the supplies status page, the demo page, and the menu map.

Troubleshooting tab

The **Troubleshooting** tab has links to the following main pages:

- **Print Quality Tools.** View general troubleshooting information, view information about troubleshooting print-quality problems, and calibrate the printer to maintain color print quality.
- **Maintenance.** View information about managing printer supplies, view information about replacing the print cartridges, and view information about replacing other printer supplies.
- **Error Messages.** View information about error messages.
- **Paper Jams.** View information on locating and clearing jams.

- **Supported Media.** View information about media that the printer supports, view information about configuring the trays, and view information about solving problems that are related to print media.
- **Printer Pages.** Print various pages that are useful for troubleshooting printer problems including the configuration page, the supplies page, the event log page, and the usage page.

Alerts tab

Use the **Alerts** tab to configure the printer to automatically notify you of printer alerts. The **Alerts** tab has links to the following main pages:

- Set up status alerts
- Administrative settings

Set up status alerts page

On the Set up status alerts page, you can choose to turn alerts on or off, specify when the printer should send an alert, and select from two different types of alerts:

- Pop-up message
- System tray icon

Click **Apply** to activate the settings.

Administrative settings page

On the Administrative settings page, you can set the frequency of how often the HP Toolbox checks for printer alerts. Three settings are available:

- **Less Often.** The HP Toolbox checks for alerts once per minute (every 60 seconds).
- **Normal.** The HP Toolbox checks for alerts twice per minute (every 30 seconds).
- **More Often.** The HP Toolbox checks for alerts twenty times per minute (every 3 seconds).

NOTE

If you want to reduce network input/output (I/O) traffic, reduce the frequency at which the printer checks for alerts.

Documentation tab

The **Documentation** tab contains links to these information sources:

- **Install Notes.** Provides specific installation instructions and information regarding your product before you install and use the printing system.
- **User Guide.** Contains the information about the printer usage, warranty, specifications, and support that you are currently reading. The user guide is available in both HTML and PDF format.

Device Settings window

When you click the **Device Settings** button, the embedded Web server opens in a new window. See [Using the embedded Web server](#).

Toolbox links

The **toolbox Links** item at the left of the screen provides links to the following options:

- **Select a device.** Select from all of the HP Toolbox-enabled devices.
- **View current alerts.** View the current alerts for all printers that have been set up. (You must be printing to view the current alerts.)
- **Text only page.** View HP Toolbox as a site map with links to all of the individual pages within HP Toolbox and the **Device Settings** window.

Other links

This section contains links that connect you to the Internet. You must have Internet access in order to use any of these links. If you use a dial-up connection and did not connect when you first opened the HP Toolbox, you must connect before you can visit these Web sites. Connecting might require that you close the HP Toolbox and reopen it.

- **HP instant support.** Connects to the HP instant support page for the product.
- **Product Registration.** Connects to the HP product registration Web site.
- **Product Support.** Connects to the support site for the printer. Then, you can search for help with a specific problem.

Uninstalling the HP Toolbox

This section explains how to uninstall the HP Toolbox.

To uninstall the HP Toolbox by using the Windows desktop shortcut

1. Click **Start**.
2. Point to **Programs**.
3. Point to **Hewlett-Packard** or to the HP LaserJet 4250 or 4350 series program group, and then click **Uninstall hp LaserJet Toolbox**.
4. Follow the onscreen instructions.

To uninstall the HP Toolbox by using Add/Remove Programs in the Windows control panel

1. Click **Start**.
2. Click **Control Panel**.

NOTE

In some versions of Windows, point to **Settings**, and then click **Control Panel**.

3. Double-click **Add or Remove Programs**.
4. Select **hp LaserJet Toolbox** from the list of programs, and then follow the onscreen instructions.

Managing and configuring printer drivers

Your system or network administrator can use the driver management and configuration solution to configure printer drivers before you install and deploy them within your environment. This is helpful when you configure printer drivers for multiple workstations or printers that share the same configuration.

When you preconfigure your printer driver to match the printer hardware, you can gain access to all of the printer accessories through the driver. You can also configure most driver feature settings. Five of the driver features can be "locked." This means that you can choose not to allow users to change the duplex, print color as gray, input tray, output tray, and media type settings. (Some features might not apply to all printers. For example, some printers do not include color printing or duplexing.)

The driver management and configuration solution saves time and reduces management costs. Previously, if an administrator wanted to configure printer drivers, the configuration had to be completed at each client workstation. Because the driver management and configuration solution offers multiple configuration options, administrators can create a single configuration, in a central location, that best fits their software installation and deployment strategy.

The driver management and configuration solution also gives administrators more control over their printing environment, because they can deploy drivers that share the same configuration across an entire organization. They can use the "lock" feature to support organization initiatives. For example, if a printer includes a duplexer, locking the duplex setting ensures that all print jobs are printed on two sides to save paper. All of the controls can be deployed from a single computer.

Two methods are available:

- HP Web Jetadmin software plug-in
- Customization utility

Regardless of the configuration method that is used, one configuration can be shared by all printer drivers for a given printer model with one pass through either the plug-in or the utility. The single configuration provides support for multiple operating systems, printer driver languages, and localized language versions.

A single configuration file is associated with all supported drivers, and can be modified by using either the plug-in or the utility.

HP Web Jetadmin software plug-in

A driver management and configuration plug-in is available for the HP Web Jetadmin software. You can use the plug-in to configure the printer drivers before installation and deployment. This method for managing and controlling printer drivers provides a complete, end-to-end solution that you can use to set up and configure the printer, the print path (queue), and the client computers or workstations. The following activities are included in the workflow:

- Discover and configure the printer(s).
- Discover and configure the print path on the server(s). You can have multiple servers configured in a batch, or multiple printers (of the same model type) using a single server.
- Obtain the printer driver(s). You can install multiple drivers for each print queue that is connected to a server in environments that support multiple operating systems.
- Run the configuration editor (the editor is not supported for some older drivers).

- Deploy the configured printer drivers to the server(s).
- Instruct the end-users to connect to the print server. The configured driver for their operating system is automatically deployed to their computer.

Administrators can use the HP Web Jetadmin software plug-in to deploy configured printer drivers using a silent, batch, or remote process. Obtain the HP Web Jetadmin software plug-in from http://www.hp.com/go/webjetadmin_software.

Customization utility

Administrators can use a customization utility to create a custom installation package that includes only the components that are needed within a specific organization or operating environment. The customization utility is available in two places:

- On the CD-ROM that comes with the printer (the utility is one of the installer options)
- In the printing system software that is available for downloading from the HP Web site for the printer model.

The installation procedure prompts the administrator to select components from the contents of the printing system. During this process, the administrator is prompted to configure the printer driver settings, if the selected drivers support preconfiguration. The process yields a customized installation package that the administrator can deploy to install the configured printer drivers on the client computers and workstations. The customization utility supports silent and batch operations.

Configuring e-mail alerts

You can use HP Web Jetadmin or the embedded Web server to configure the system to alert you to problems with the printer. The alerts take the form of e-mail messages to the e-mail account or accounts that you specify.

You can configure the following information:

- The device that you want to monitor (in this case, the printer)
- What alerts are to be received (for example, alerts for jams, paper out, **ORDER CARTRIDGE, REPLACE CARTRIDGE**, and **cover open**)
- The e-mail account to which the alerts should be forwarded

Utility	Information source
HP Web Jetadmin	<ul style="list-style-type: none">• See Using HP Web Jetadmin software for general information about HP Web Jetadmin.• See HP Web Jetadmin online Help for details about alerts and how to set them up.
Embedded Web server	<ul style="list-style-type: none">• See Using the embedded Web server for general information about the embedded Web server.• See the Embedded Web server online Help for details about alerts and how to set them up.

Setting the real-time clock

Use the real-time clock feature to set the date and time settings. The date and time information is attached to stored print jobs, so you can identify the most recent versions of stored print jobs.

Setting the date and time

When setting the date and time you can set the date format, date, time format, and time.

Setting the date format

1. Press **MENU** to open the menu.
2. Use ▲ (**UP** button) or ▼ (**DOWN** button) to scroll to **CONFIGURE DEVICE**, and then press ✓ (**SELECT** button).
3. Use ▲ (**UP** button) or ▼ (**DOWN** button) to scroll to **SYSTEM SETUP**, and then press ✓ (**SELECT** button).
4. Use ▲ (**UP** button) or ▼ (**DOWN** button) to scroll to **DATE/TIME**, and then press ✓ (**SELECT** button).
5. Use ▲ (**UP** button) or ▼ (**DOWN** button) to scroll to **DATE FORMAT**, and then press ✓ (**SELECT** button).
6. Use ▲ (**UP** button) or ▼ (**DOWN** button) to scroll to the desired format, and then press ✓ (**SELECT** button).
7. The settings are saved and the control panel returns to the **DATE/TIME** submenu.
8. Press **MENU** to exit the menu.

Setting the date

1. Press **MENU** to open the menus.
2. Use ▲ (**UP** button) or ▼ (**DOWN** button) to scroll to **CONFIGURE DEVICE**, and then press ✓ (**SELECT** button).
3. Use ▲ (**UP** button) or ▼ (**DOWN** button) to scroll to **SYSTEM SETUP**, and then press ✓ (**SELECT** button).
4. Use ▲ (**UP** button) or ▼ (**DOWN** button) to scroll to **DATE/TIME**, and then press ✓ (**SELECT** button).
5. Use ▲ (**UP** button) or ▼ (**DOWN** button) to scroll to **DATE**, and then press ✓ (**SELECT** button).
6. Use ▲ (**UP** button) or ▼ (**DOWN** button) to scroll to the appropriate year, and then press ✓ (**SELECT** button).

NOTE

The order of modifying the **YEAR**, **MONTH**, and **DAY** depends upon the date format setting. **YEAR**, **MONTH**, or **DAY** could be the first selection.

7. Use ▲ (**UP** button) or ▼ (**DOWN** button) to scroll to the appropriate month and then press ✓ (**SELECT** button).
8. Use ▲ (**UP** button) or ▼ (**DOWN** button) to scroll to the appropriate day and then press ✓ (**SELECT** button).
9. The settings are saved and the control panel returns to the **DATE/TIME** submenu.
10. Press **MENU** to exit the menu.

Setting the time format

1. Press **MENU** to open the menus.
2. Use ▲ (**UP** button) or ▼ (**DOWN** button) to scroll to **CONFIGURE DEVICE**, and then press ✓ (**SELECT** button).
3. Use ▲ (**UP** button) or ▼ (**DOWN** button) to scroll to **SYSTEM SETUP**, and then press ✓ (**SELECT** button).
4. Use ▲ (**UP** button) or ▼ (**DOWN** button) to scroll to **DATE/TIME**, and then press ✓ (**SELECT** button).
5. Use ▲ (**UP** button) or ▼ (**DOWN** button) to scroll to **TIME FORMAT**, and then press ✓ (**SELECT** button).
6. Use ▲ (**UP** button) or ▼ (**DOWN** button) to scroll to the desired time format, and then press ✓ (**SELECT** button).
7. The settings are saved and the control panel returns to the **DATE/TIME** submenu.
8. Press **MENU** to exit the menu.

Setting the time

1. Press **MENU** to open the menus.
2. Use ▲ (**UP** button) or ▼ (**DOWN** button) to scroll to **CONFIGURE DEVICE**, and then press ✓ (**SELECT** button).
3. Use ▲ (**UP** button) or ▼ (**DOWN** button) to scroll to **SYSTEM SETUP**, and then press ✓ (**SELECT** button).
4. Use ▲ (**UP** button) or ▼ (**DOWN** button) to scroll to **DATE/TIME**, and then press ✓ (**SELECT** button).
5. Use ▲ (**UP** button) or ▼ (**DOWN** button) to scroll to **TIME**, and then press ✓ (**SELECT** button).
6. Use ▲ (**UP** button) or ▼ (**DOWN** button) to scroll to the appropriate hour, and then press ✓ (**SELECT** button).
7. Use ▲ (**UP** button) or ▼ (**DOWN** button) to scroll to the appropriate minute, and then press ✓ (**SELECT** button).
8. The settings are saved and the control panel returns to the **DATE/TIME** submenu.
9. Press **MENU** to exit the menu.

Checking the printer configuration

At the printer control panel, you can print pages that give details about the printer and its current configuration. The following information pages are described here:

- [Menu map](#)
- [Configuration page](#)
- [Supplies status page](#)
- [PS or PCL font list](#)

For a complete list of printer information pages, see the **INFORMATION** menu at the printer control panel (see [Information menu](#)).

Keep these pages nearby for troubleshooting. They are also useful if you contact HP Customer Care.

Menu map

Print the menu map to see the current settings for the menus and items that are available at the printer control panel.

To print a menu map

1. Press ✓ (**SELECT** button) to open the menus.
2. Use ▲ (**UP** button) or ▼ (**DOWN** button) to scroll to **INFORMATION**, and then press ✓ (**SELECT** button).
3. Use ▲ (**UP** button) or ▼ (**DOWN** button) to scroll to **PRINT MENU MAP**, and then press ✓ (**SELECT** button).

You might want to store the menu map near the printer for reference. The content of the menu map varies, depending on the options currently installed in the printer. (Many of these values can be overridden in the program or printer driver.)

For a complete list of control panel items and possible values, see [Control panel menus](#). To change a control panel setting, see [Changing printer-control-panel configuration settings](#).

Configuration page

Use the configuration page to view current printer settings, to help troubleshoot printer problems, or to verify installation of optional accessories, such as memory (DIMMs), trays, and printer languages.

NOTE

If an HP Jetdirect print server is installed, an HP Jetdirect configuration page prints as well. The IP address of the HP Jetdirect print server appears on this page.

To print a configuration page at the control panel

1. Press ✓ (**SELECT** button) to open the menus.
2. Use ▲ (**UP** button) or ▼ (**DOWN** button) to scroll to **INFORMATION**, and then press ✓ (**SELECT** button).

- Use ▲ (UP button) or ▼ (DOWN button) to scroll to **PRINT CONFIGURATION**, and then press ✓ (SELECT button).

An example of the configuration page follows. The content of the configuration page varies, depending on the options currently installed in the printer.

NOTE

You can also obtain configuration information in the embedded Web server or the HP Toolbox. For details, see [Using the embedded Web server](#) or see [Using the HP Toolbox](#).

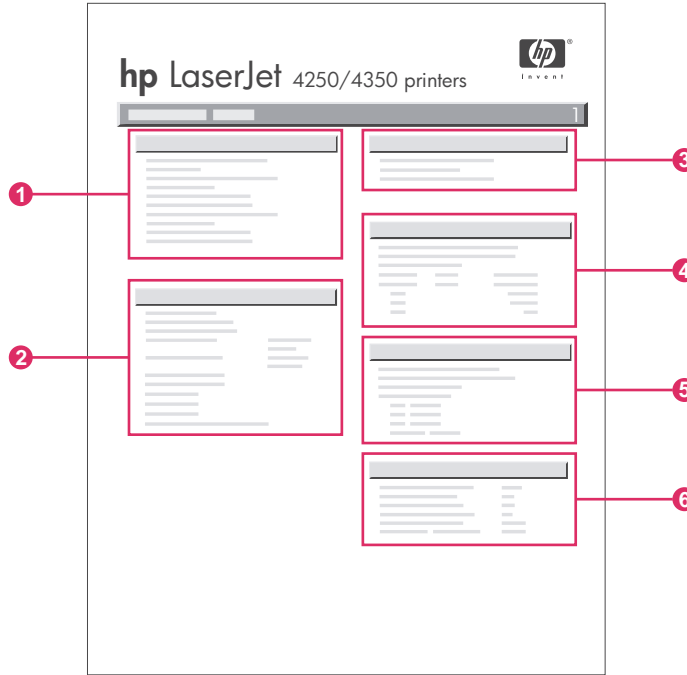

1	Printer Information	Lists the model, serial number, page counts, and other information for the printer.
2	Installed Personalities and Options	Lists all printer languages that are installed (such as PS and PCL) and lists options that are installed in each DIMM slot and EIO slot.
3	Memory	Lists printer memory, PCL Driver Work Space (DWS), and resource saving information.
4	Event Log	Lists the number of entries in the event log, the maximum number of entries viewable, and the last three entries.
5	Security	Lists the status of the printer control panel lock, control panel password, and disk drive (if one is installed in the printer).
6	Paper Trays and Options	Lists the size settings for all trays and lists optional paper-handling accessories that are installed.

Supplies status page

Use the supplies status page to obtain information about the print cartridge that is installed in the printer, the amount of life left in the print cartridge, and the number of pages and jobs that have been processed.

NOTE

You can also obtain configuration information in the embedded Web server or the HP Toolbox. For details, see [Using the embedded Web server](#) or see [Using the HP Toolbox](#).

To print a supplies status page at the control panel

1. Press \checkmark (**SELECT** button) to open the menus.
2. Use \blacktriangle (**UP** button) or \blacktriangledown (**DOWN** button) to scroll to **INFORMATION**, and then press \checkmark (**SELECT** button).
3. Use \blacktriangle (**UP** button) or \blacktriangledown (**DOWN** button) to scroll to **PRINT SUPPLIES STATUS PAGE**, and then press \checkmark (**SELECT** button).



- 1 Information about the print cartridge, including estimated pages remaining
- 2 Information about the remaining life for the maintenance kit
- 3 Information about ordering replacement supplies
- 4 Information about recycling supplies

PS or PCL font list

Use the font lists to see which fonts are currently installed in the printer. The font lists also show which fonts are resident on an optional hard disk accessory or flash DIMM.

To print a PS or PCL font list

1. Press \checkmark (**SELECT** button) to open the menus.

2. Use ▲ (UP button) or ▼ (DOWN button) to scroll to **INFORMATION**, and then press ✓ (SELECT button).
3. Use ▲ (UP button) or ▼ (DOWN button) to scroll to **PRINT PS FONT LIST** or **PRINT PCL FONT LIST**, and then press ✓ (SELECT button).

The PS font list shows the PS fonts that are installed, and gives a sample of those fonts. The following information can be found on the PCL font list:

- **Font** gives the font names and samples.
- **Pitch/Point** indicates the pitch and point size of the font.
- **Escape Sequence** (a PCL programming command) is used to select the designated font. (See the legend at the bottom of the font list page.)

NOTE

For information about using printer commands to select a font with MS-DOS® programs, see [Selecting PCL 6 and PCL 5 fonts](#).

- **Font #** is the number used to select fonts at the printer control panel (not in the program). Do not confuse the font # with the font ID. The number indicates the CompactFlash slot where the font is stored.
 - **SOFT**: Downloaded fonts, which stay resident in the printer until other fonts are downloaded to replace them, or until the printer power is turned off.
 - **INTERNAL**: Fonts that permanently reside in the printer.
- **Font ID** is the number you assign to soft fonts when you download them through software.

Managing the print cartridge

This section provides information about HP print cartridges, their life expectancies, how to store them, and how to identify genuine HP supplies. Information also appears about non-HP print cartridges.

- [HP print cartridges](#)
- [Non-HP print cartridges](#)
- [Print-cartridge authentication](#)
- [Print-cartridge storage](#)
- [Print-cartridge life expectancy](#)
- [Checking the supply level](#)
- [Cartridge-low and cartridge-out conditions](#)

HP print cartridges

When you use a genuine HP print cartridge, you can obtain several types of information, such as the following:

- Amount of toner remaining
- Estimated number of pages remaining
- Number of pages printed

Non-HP print cartridges

Hewlett-Packard Company cannot recommend use of non-HP print cartridges, either new or remanufactured. Because they are not HP products, HP cannot influence their design or control their quality. Service or repair required as a result of using a non-HP print cartridge will **not** be covered under the printer warranty.

Using genuine HP supplies ensures the availability of all HP printing features.

Print-cartridge authentication

The printer will let you know if a print cartridge is not a genuine HP print cartridge when you insert it into the printer. If you believe that you purchased a genuine HP supply, visit us at <http://www.hp.com/go/anticounterfeit>.

Print-cartridge storage

Do not remove the print cartridge from its package until you are ready to use it.

Always store the print cartridge in the proper environment. The temperature should be between -20°C and 40°C (-4°F to 104°F). The relative humidity should be between 10% and 90%.

CAUTION

To prevent damage to the print cartridge, do not expose it to light for more than a few minutes.

Print-cartridge life expectancy

The life of the print cartridge depends on the amount of toner that print jobs require and the length of life for the components inside the cartridge. When printing text at 5% coverage (typical for a business letter), the HP print cartridge lasts an average of 10,000 (Q5942A) or 20,000 (Q5942X) pages.

At any time, you can verify life expectancy by checking the supply level, as described in [Checking the supply level](#).

Checking the supply level

You can check the supply (toner) level by using the printer control panel, the embedded Web server, HP Toolbox software, or HP Web Jetadmin.

To check the supply level by using the control panel

1. Press **MENU** to open the menu.
2. Use **▲** (**UP** button) or **▼** (**DOWN** button) to scroll to **INFORMATION**, and then press **✓** (**SELECT** button).
3. Use **▲** (**UP** button) or **▼** (**DOWN** button) to scroll to **PRINT SUPPLIES STATUS PAGE**, and then press **✓** (**SELECT** button). See [Supplies status page](#) for information about the supplies status page.

To check the supply level by using the embedded Web server

1. In your Web browser, type the IP address for the printer home page. This takes you to the printer status page. (See [Opening the embedded Web server](#).)
2. On the left side of the screen, click **Supplies Status**. This takes you to the supplies status page, which provides supply level information. (See [Supplies status page](#) for information about the supplies status page.)

To check the supply level by using the HP Toolbox software

You can configure HP Toolbox to notify you when the print cartridge is low. You can choose to receive alerts by e-mail or as a pop-up message or taskbar icon. To check the supplies status by using the HP Toolbox software, click the **Status** tab, then click **Supplies Status**.

To check the supply levels by using HP Web Jetadmin

In HP Web Jetadmin, select the printer device. The device status page shows supply-level information.

Cartridge-low and cartridge-out conditions

The printer alerts you if the print cartridge is low on toner or out of toner.

When the cartridge is low on toner or drum life

When the cartridge is low, the printer control panel shows the **ORDER CARTRIDGE** message. For the HP LaserJet 4250 series, the message first appears when about 15% (10,000-page cartridge) or about 8% (20,000-page cartridge) of the life remains in the print cartridge. For the HP LaserJet 4350 series, the message first appears when about 25% (10,000-page cartridge) or about 15% (20,000-page cartridge) of the life remains in the print cartridge. This percentage is set with the intent of providing approximately 2 weeks of typical use before the cartridge is depleted. You should have time to purchase a new cartridge before the old cartridge is depleted.

The default is for the printer to continue printing until the cartridge runs out, but you might prefer to have the printer stop instead of continuing when the **ORDER CARTRIDGE** message first appears—for example, if you want print quality to remain consistently high during print jobs, or if you do not want the cartridge to run out during a long print job. To configure the printer to stop, in the **CONFIGURE DEVICE** menu, under **SYSTEM SETUP**, set **CARTRIDGE LOW** to **STOP**. Then, when **REPLACE CARTRIDGE** appears, the printer will stop printing. You can resume printing by pressing ✓ (**SELECT** button) for each print job.

When the cartridge is out of toner or drum life

The **REPLACE CARTRIDGE** message appears in one of these situations:

- **When the print cartridge is out of toner.** If **CARTRIDGE OUT** is set to **CONTINUE** (in the **SYSTEM SETUP** submenu of the **CONFIGURE DEVICE** menu), the printer continues printing without interaction until the cartridge reaches the end of drum life. HP does not guarantee print quality after the **REPLACE CARTRIDGE** message first appears. Replace the print cartridge as soon as possible. (See [Ordering parts, accessories, and supplies](#).) The **REPLACE CARTRIDGE** message remains until you replace the print cartridge. If **CARTRIDGE OUT** is set to **STOP**, the printer stops printing until you replace the print cartridge or resume printing by configuring the printer to continue: In the **CONFIGURE DEVICE** menu, under **SYSTEM SETUP**, set **CARTRIDGE OUT** to **CONTINUE**.
- **When the drum life of the print cartridge is out.** You must replace the print cartridge to continue printing. No override is possible, even if toner remains in the cartridge. (See [Ordering parts, accessories, and supplies](#).) This situation occurs to protect the printer.

Cleaning the printer

Use the cleaning procedure on the following page every time you change the print cartridge or whenever print-quality problems occur. As much as possible, keep the printer free from dust and debris.

- Clean the outside of the printer with a slightly water-dampened cloth.
- Clean the inside with a dry, lint-free cloth.

CAUTION

Do not use ammonia-based cleaners on or around the printer. While cleaning the printer, be careful not to touch the transfer roller (the black, rubber roller located underneath the print cartridge). Skin oils on the roller can cause print-quality problems.

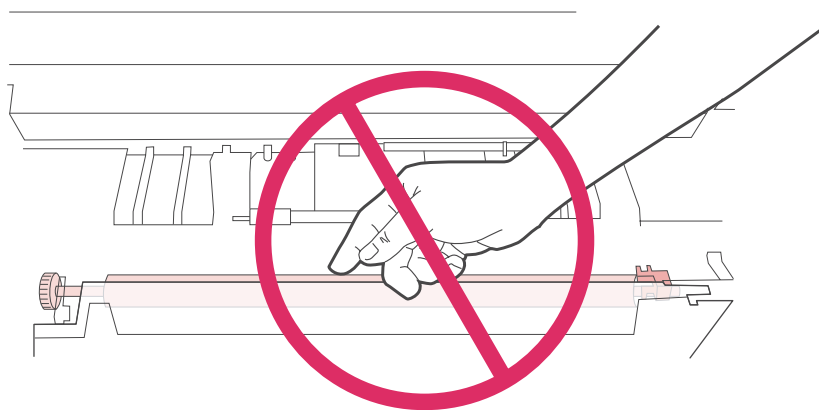

Cleaning the inside of the printer

Use these steps to clean dust and residue from the inside of the printer.

To clean the inside of the printer

1. Turn the printer power off and unplug the power cord.

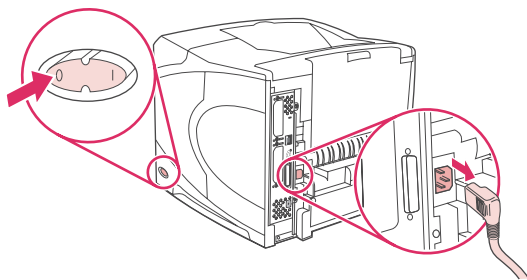

2. Open the top cover and remove the print cartridge.

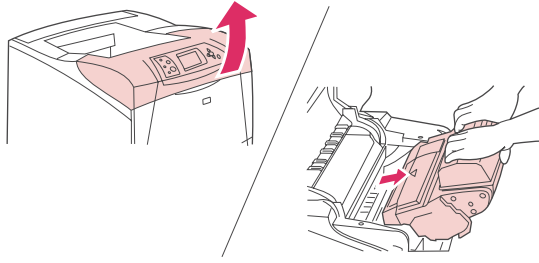

WARNING!

Avoid reaching too far into the printer. The adjacent fusing area might be hot.

CAUTION

To prevent damage to the print cartridge, do not expose it to light for more than a few minutes. Cover the print cartridge with a sheet of paper while it is outside of the printer.

3. Wipe any dust or dirt off the paper feed guides (shaded areas) with a dry, lint-free cloth.

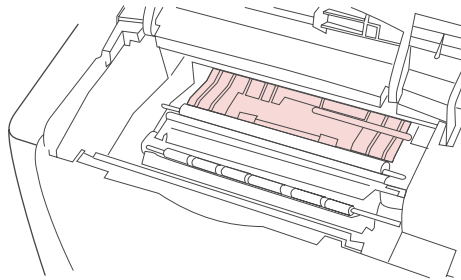

NOTE

If toner gets on your clothing, wipe it off with a dry cloth and wash clothing in cold water. (Hot water sets toner into fabric.)

4. Using the green handle, lift the paper-access plate and wipe off any residue with a dry, lint-free cloth.

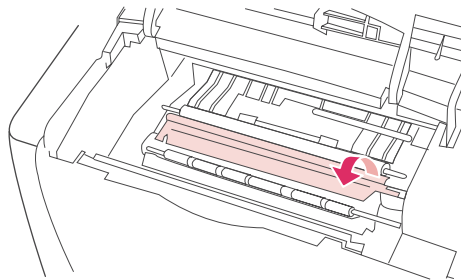

5. Reinstall the print cartridge, close the top cover, plug in the power cord, and turn the printer power on.

Cleaning the fuser

Run the printer cleaning page to keep the fuser free of toner and paper particles that can sometimes accumulate. Accumulation of toner and particles can cause specks to appear on the front or back side of your print jobs.

To ensure optimum print quality, HP recommends that you use the cleaning page every time you replace the print cartridge or on an automatic interval that you can set up. If you have an optional duplexer installed, you must run cleaning pages manually.

The cleaning procedure takes about 2.5 minutes to complete. A **CLEANING** message appears on the printer control panel display while the cleaning is taking place.

Running the cleaning page manually

In order for the cleaning page to work properly, print the page on copier-grade paper (not bond, heavy, or rough paper).

To run the cleaning page manually

1. If a duplexer is installed, open the rear output bin.
2. Press **MENU** to open the menus.
3. Use ▲ (**UP** button) or ▼ (**DOWN** button) to scroll to **CONFIGURE DEVICE**, and then press ✓ (**SELECT** button).
4. Use ▲ (**UP** button) or ▼ (**DOWN** button) to scroll to **PRINT QUALITY**, and then press ✓ (**SELECT** button).
5. Use ▲ (**UP** button) or ▼ (**DOWN** button) to scroll to **PROCESS CLEANING PAGE**, and then press ✓ (**SELECT** button).
6. If a duplexer is installed, close the rear output bin.

Running the cleaning page automatically

Using the procedure below, you can set the printer to print cleaning pages automatically at an interval that you select. In order for the cleaning page to run without intervention, you must keep the selected size and plain paper type available in the printer. The printer will not interrupt a printing job in process.

To run the cleaning page automatically

1. Press **MENU** to open the menus.
2. Use ▲ (**UP** button) or ▼ (**DOWN** button) to scroll to **CONFIGURE DEVICE**, and then press ✓ (**SELECT** button).
3. Use ▲ (**UP** button) or ▼ (**DOWN** button) to scroll to **PRINT QUALITY**, and then press ✓ (**SELECT** button).
4. Use ▲ (**UP** button) or ▼ (**DOWN** button) to scroll to **AUTO CLEANING**, and then press ✓ (**SELECT** button).
5. Use ▲ (**UP** button) or ▼ (**DOWN** button) to scroll to **ON**, and then press ✓ (**SELECT** button).
6. Use ▲ (**UP** button) or ▼ (**DOWN** button) to scroll to **CLEANING INTERVAL**, and then press ✓ (**SELECT** button).
7. Use ▲ (**UP** button) or ▼ (**DOWN** button) to scroll to the desired interval between 1,000 and 20,000 pages, and then press ✓ (**SELECT** button) to save your selection.
8. Use ▲ (**UP** button) or ▼ (**DOWN** button) to scroll to **AUTO CLEANING SIZE**, and then press ✓ (**SELECT** button).
9. Use ▲ (**UP** button) or ▼ (**DOWN** button) to scroll to the paper size that you want the printer to use for cleaning pages (**A4** or **LETTER**), and then press ✓ (**SELECT** button) to save your selection.

The printer automatically prints a cleaning page at the interval and page size that you selected. You can discard the output page created by the cleaning process.

Performing preventive maintenance

You should replace certain parts when the **PERFORM PRINTER MAINTENANCE** message appears on the printer control panel display. This will help ensure that your printer maintains optimum performance.

The maintenance message will appear every 200,000 pages. The message can be temporarily cleared for approximately 10,000 pages by using the **CLEAR MAINTENANCE MESSAGE** item on the Resets submenu. (See [Resets submenu](#).) To check the number of pages the printer has printed since new maintenance-kit components were installed, print either a configuration page or a supplies status page. (See [Configuration page](#) or [Supplies status page](#) for details.)

To order the printer maintenance kit, see [Part numbers](#). The kit includes:

- fuser
- rollers (transfer, pickup, and feed)
- installation instructions

NOTE

The printer maintenance kit is a consumable item and is not covered under the original printer warranty or under most extended warranties.

After a maintenance kit is installed, the maintenance-kit counter must be reset.

To reset the maintenance-kit counter

1. Turn the printer power off and then on.
2. When XXX appears on the control-panel display, press and hold down \checkmark (**SELECT** button). Continue holding down \checkmark (**SELECT** button) until all three printer control panel lights flash once, and then stay on. This might take up to 10 seconds.
3. Release \checkmark (**SELECT** button) and press \blacktriangle (**UP** button) to scroll to **NEW MAINTENANCE KIT**.
4. Press \checkmark (**SELECT** button) to reset the maintenance-kit counter.

NOTE

Perform this procedure only after a maintenance kit has been installed. Do not use this procedure to temporarily clear the **PERFORM PRINTER MAINTENANCE** message.

Replacing the stapler unit

Use these steps to replace a defective stapler unit in the optional stapler/stacker.

To remove and replace the stapler unit

1. Locate the stapler unit on the right side of the stapler/stacker.

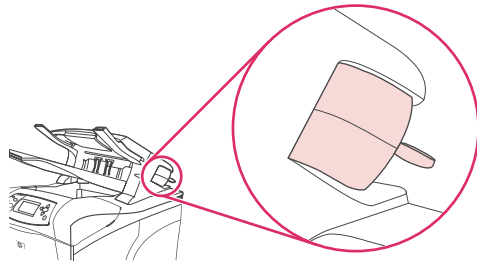

2. Rotate the stapler unit toward the front of the printer until the unit clicks. Hold the stapler unit in this open position.

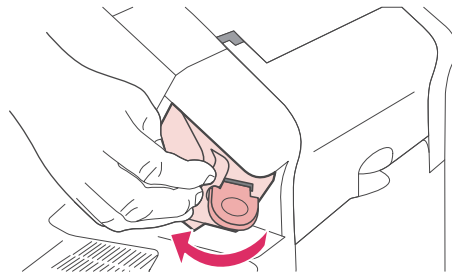

3. Push down on the tab at the top of the stapler unit.

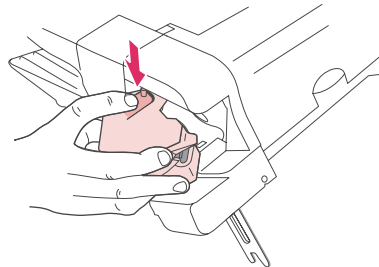

4. Hold the tab down and pull the stapler unit up and out of the stapler/stacker.

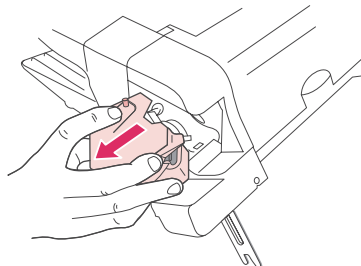

5. Disconnect cable that connects the stapler unit to the stapler/stacker. (Only the blue part detaches.) Release the white tab that contains the blue cable connector by opening the tab to the left.

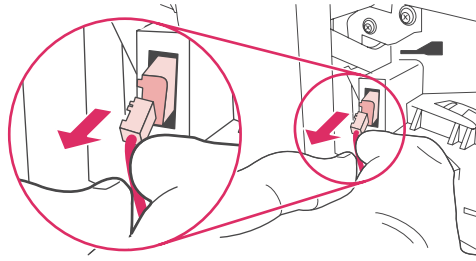

6. Remove the new stapler unit from its packaging.

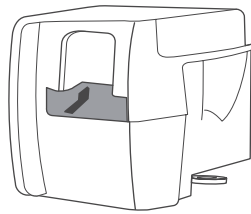

7. Connect the cable on the new stapler unit to the stapler/stacker.

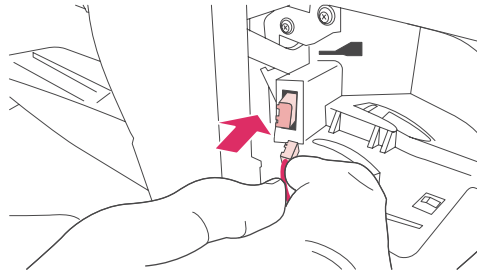

8. Place the peg that is located on the bottom of the new stapler unit into the hole in the stapler/stacker.

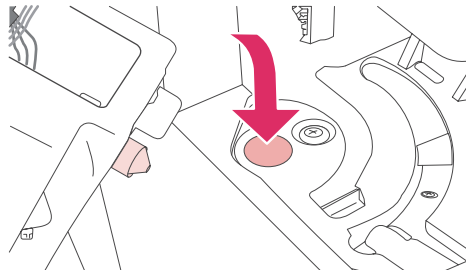

9. Press down on the tab at the top of the stapler unit and push the unit into the stapler/stacker.

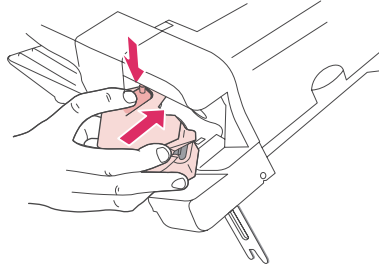

10. Rotate the stapler unit toward the rear of the printer until the unit clicks into place.

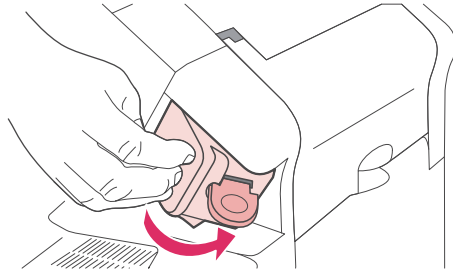

11. If the stapler cartridge is not installed in the stapler unit, install it now. (See [Loading staples.](#))

4

Problem solving

This troubleshooting information is organized to help you resolve printing problems. Choose the general topic or type of problem from the following list.

- [Troubleshooting flowchart](#)
- [Solving general printing problems](#)
- [Guidelines for using paper](#)
- [Printing special pages](#)
- [Clearing jams](#)
- [Understanding printer messages](#)
- [Understanding accessory lights for the stacker and stapler/stacker](#)
- [Correcting print-quality problems](#)
- [Troubleshooting network printing problems](#)
- [Troubleshooting common Windows problems](#)
- [Troubleshooting common Macintosh problems](#)
- [Troubleshooting common PostScript problems](#)
- [Troubleshooting the optional hard disk](#)

Troubleshooting flowchart

If the printer is not responding properly, use the flowchart to determine the problem. If the printer does not pass a step, follow the corresponding troubleshooting suggestions.

If you cannot resolve the problem after following the suggestions in this guide, contact an HP-authorized service or support provider. (See [HP customer care](#).)

NOTE

Macintosh users: For more troubleshooting information, see [Troubleshooting common Macintosh problems](#).

1 Does the control panel display read READY?

YES →	Go to step 2.			
NO ↓				
The display is blank, and the printer fan is off.	The display is blank, but the printer fan is on.	The display is in the wrong language.	The display shows garbled or unfamiliar characters.	A message other than READY appears on the printer control panel display.

<ul style="list-style-type: none"> • Turn the printer off then on. • Check the power cord connections and the power switch. • Plug the printer into a different outlet. • Check that the power supplied to the printer is steady, and meets printer specifications. (See Electrical specifications.) 	<ul style="list-style-type: none"> • Press a printer control panel button to see if the printer responds. • Turn the printer power off, and then turn the printer power on. 	<ul style="list-style-type: none"> • Turn the printer power off and then on. When XXX MB appears on the control-panel display, press and hold down ✓ (SELECT button) until all three lights stay on. This could take up to 10 seconds. Then, release ✓ (SELECT button). Press ▼ (DOWN button) to scroll through the available languages. Press ✓ (SELECT button) to save the desired language as the new default. 	<ul style="list-style-type: none"> • Make sure that the desired language is selected at the printer control panel. • Turn the printer power off, and then turn the printer power on. 	<ul style="list-style-type: none"> • Go to Interpreting control-panel messages.
--	---	--	--	--

2 Can you print a configuration page?

(See [Configuration page](#).)

YES →	Go to step 3.	
NO ↓		
A configuration page does not print.	A blank page prints.	A message other than READY or PRINTING CONFIGURATION appears on the printer control panel display.

<ul style="list-style-type: none"> • Check that all trays are properly loaded, adjusted, and installed in the printer. • Using the computer, check the print queue or print spooler to see if the printer has been paused. If there are problems with the current print job, or if the printer is paused, a configuration page will not print. (Press STOP and try step 2 in the troubleshooting flowchart again.) 	<ul style="list-style-type: none"> • Check that the sealing tape is not still in the print cartridge. (See the getting started [start] guide or the instructions that came with the print cartridge.) • The print cartridge might be empty. Install a new print cartridge. 	<ul style="list-style-type: none"> • Go to Interpreting control-panel messages.
---	--	--

3 Can you print from a program?

YES →	Go to step 4.
NO ↓	
The job will not print.	A PS error page or list of commands prints.

<ul style="list-style-type: none"> ● If the job will not print, and a message appears on the printer control panel display, see Interpreting control-panel messages. ● Using the computer, check to see if the printer has been paused. Press STOP to continue. ● If the printer is on a network, check that you are printing to the correct printer. To verify that it is not a network problem, connect the computer directly to the printer with a parallel or USB cable, change the port to LPT1, and try to print. ● Check the interface cable connections. Disconnect and reconnect the cable at the computer and the printer. ● Test the cable by trying it on another computer. ● If you are using a parallel connection, make sure that the cable is IEEE-1284 compliant. ● If the printer is on a network, print a configuration page. (See Configuration page.) If an HP Jetdirect print server is installed, a Jetdirect page also prints. Check the Jetdirect configuration page to verify that the network protocol status and settings are correct for the printer. ● To verify that it is not a computer problem, print from another computer (if possible). ● Make sure that the print job is being sent to the correct port (LPT1 or network printer port, for example). ● Check that you are using the proper printer driver. (See Using the printer driver.) ● Reinstall the printer driver. (See the getting started [start] guide.) ● Check that the computer port is configured and working properly. (Try connecting another printer to that port and printing.) ● If printing with the PS driver, on the Printing submenu (on the Configure Device menu) at the printer control panel, set PRINT PS ERRORS=ON, and then print the job again. If an error page prints, see the instructions in the next column. ● On the System Setup submenu (on the Configure Device menu) at the printer control panel, make sure that PERSONALITY=AUTO. ● You might be missing a printer message that could help you solve the problem. On the System Setup submenu (on the Configure Device menu) at the printer control panel, temporarily turn the Clearable Warnings and Auto Continue settings off. Then, print the job again. 	<ul style="list-style-type: none"> ● The printer might have received a nonstandard PS code. On the System Setup submenu (on the Configure Device menu) at the printer control panel, set PERSONALITY=PS for this print job only. After the job has printed, return the setting to AUTO. ● Make sure that the print job is a PS job, and that you are using the PS driver. ● The printer might have received PS code although it is set to PCL. On the System Setup submenu (on the Configure Device menu), set PERSONALITY=AUTO.
---	---

4 Does the job print as expected?

YES →	Go to step 5.		
NO ↓			
Print is garbled, or only a portion of the page prints.	Printing stops in the middle of the job.	Print speed is slower than expected.	A printer control panel setting is not taking effect.

<ul style="list-style-type: none"> • Check that you are using the proper printer driver. (See Using the printer driver.) • The data file sent to the printer might be corrupt. To test, try printing it on another printer (if possible), or try a different file. • Check the interface cable connections. Test the cable by trying it on another computer (if possible). • Replace the interface cable with a high-quality cable (see Part numbers). • Simplify the print job, print at a lower resolution, or install more printer memory. (See Printer memory.) • You might be missing a printer message that could help you solve the problem. On the System Setup submenu (on the Configure Device menu) at the printer control panel, temporarily turn the Clearable Warnings and Auto Continue settings off. Then print the job again. 	<ul style="list-style-type: none"> • STOP might have been pressed. • Check that the power supplied to the printer is steady, and that it meets printer specifications. (See Electrical specifications.) 	<ul style="list-style-type: none"> • Simplify the print job. • Add more memory to the printer. (See Printer memory.) • Turn banner pages off. (See your network administrator.) • Note that slower speeds should be expected if you are printing narrow paper, printing from tray 1, using the HIGH 2 fuser mode, or have set Small Paper Speed to SLOW. 	<ul style="list-style-type: none"> • Check settings in the printer driver or program. (The printer driver and program settings override printer control panel settings.)
<p>The print job is not formatted correctly.</p>	<p>Paper is not fed correctly or is damaged.</p>	<p>There are print-quality problems.</p>	

<ul style="list-style-type: none"> • Check that you are using the proper printer driver. (See Using the printer driver.) • Check the program settings. (See the program online Help.) • Try a different font. • Downloaded resources might have been lost. You might need to download them again. 	<ul style="list-style-type: none"> • Make sure that the paper is loaded correctly and that the guides are not too tight or too loose against the paper stack. • If you are having problems printing custom-size paper, see Printing on small sizes, custom sizes, or heavy paper. • If pages are wrinkled or curled, or if the image is skewed on the page, see Correcting print-quality problems. 	<ul style="list-style-type: none"> • Adjust the print resolution. (See Print Quality submenu.) • Check that RET is on. (See Print Quality submenu.) • Go to Correcting print-quality problems.
---	---	---

5 Does the printer select the proper trays and paper-handling accessories?

YES →	For other problems, check the Contents, the Index, or the printer driver online Help.	
NO ↓		
The printer pulls paper from the wrong tray.	An optional accessory is not working properly.	A message other than READY appears on the printer control panel display.

<ul style="list-style-type: none"> • Make sure that you have selected the correct tray. (See Selecting a paper source.) • Make sure that trays are correctly configured for paper size and type. (See Loading trays.) Print a configuration page to see current tray settings. (See Configuration page.) • Make sure that the tray selection (Source) or Type in the printer driver or program is set correctly. (The printer driver and program settings override the printer control panel settings.) • By default, paper loaded in tray 1 will be printed first. If you do not want to print from tray 1, remove any paper loaded in the tray or change the USE REQUESTED TRAY setting. (See Customizing tray 1 operation.) Change TRAY 1 SIZE and TRAY 1 TYPE to a setting other than ANY. • If you want to print from tray 1, but cannot select the tray in a program, see Customizing tray 1 operation. 	<ul style="list-style-type: none"> • Print a configuration page to verify that the accessory is installed properly and is functional. (See Configuration page.) • Configure the printer driver to recognize the installed accessories (including trays). (See the printer driver online Help.) • Turn the printer power off, and then turn the printer power on. • Verify that you are using the correct optional accessory for the printer. • If the duplexer will not duplex, check that the rear output bin is closed. • If the duplexer will not duplex, you might need to install more memory. (See Printer memory.) <hr/> <p>NOTE</p> <p>The duplexer is included for models that have "d" in the product name. It is optional for all other models.</p> <hr/> <ul style="list-style-type: none"> • If the optional stacker or stapler/stacker is not working properly, check the accessory lights. (See Accessory lights.) • If the optional stacker or stapler/stacker is not working properly, check to see if a message appears on the printer control panel display. (See Interpreting control-panel messages.) • If the optional stapler/stacker is not stapling, but the accessory light is solid green, and neither TOO MANY PAGES IN JOB nor DIFFERENT PAPER SIZES IN JOB appears on the printer control panel display, call for support. (See HP customer care.) 	<ul style="list-style-type: none"> • Go to Interpreting control-panel messages.
---	--	--

Solving general printing problems

In addition to the issues and solutions that are listed in this section, see [Troubleshooting common Macintosh problems](#) if you are using a Macintosh computer, and see [Troubleshooting common PostScript problems](#) if you are using the PS driver.

Printer selects media from the wrong tray.

Cause	Solution
The tray selection in the software program might be incorrect.	For many software programs, the paper tray selection is found on the Page Setup menu within the program. Remove any media in other trays to make the printer select from the correct tray. For Macintosh computers, use the HP LaserJet Utility to change the priority of the tray.
The configured size does not match the size of the media that is loaded in the tray.	Through the control panel, change the configured size to match the size of the media that is loaded in the tray.

Printer does not pull paper from tray.

Cause	Solution
The tray is empty.	Load paper in the tray.
The paper guides are set incorrectly.	To set the guides correctly, see Loading trays . For the 500-sheet paper tray, make sure that the leading edge of the paper stack is even. An uneven edge can prevent the lift plate from rising.

Paper curls when it exits the printer.

Cause	Solution
The paper curls when it exits to the top output bin.	Open the rear output bin to allow the paper to exit in a straight path through the printer. Turn over the paper that you are printing on. Reduce the fusing temperature to reduce the curling. (See Selecting the correct fuser mode .)

First sheet of media jams in the print-cartridge area.

Cause	Solution
A combination of high humidity and high temperature is affecting the media.	Adjust the printer for high humidity and high temperature conditions.

Print job is extremely slow.

Cause	Solution
<p>The job might be very complex.</p> <p>The maximum speed of the printer cannot be exceeded even when more memory is added.</p> <p>Printing speeds might be automatically reduced when printing on custom-sized media.</p> <p>Note: Slower speeds are expected when printing on narrow paper, when printing from tray 1, or when using the HIGH 2 fuser mode.</p>	<p>Reduce the complexity of the page or try adjusting the print-quality settings. If this problem occurs frequently, add memory to the printer.</p>
<p>You are printing a PDF or PostScript (PS) file but are using a PCL printer driver.</p>	<p>Try using the PS printer driver rather than the PCL printer driver. (You can usually do this from a software program.)</p>
<p>In the printer driver, Optimize for: is set to cardstock, heavy, rough, or bond paper.</p>	<p>In the printer driver, set the type to plain paper (see Printing by type and size of media (locking trays)).</p> <p>Note: If you change the setting to plain paper, the print job will print faster. However, if you are using heavy media, for best results leave the printer driver set to heavy even though printing might be slower.</p>

Print job prints on both sides of the paper.

Cause	Solution
<p>The printer is set for duplexing.</p>	<p>See Changing the settings for a print job to change the setting, or see the online Help.</p>

Print job contains only one page but the printer processes the back side of the page as well (the page comes part of the way out, and then goes back into the printer).

Cause	Solution
<p>The printer is set for duplexing. Even if the print job contains only one page, the printer also processes the back side.</p>	<p>See Changing the settings for a print job to change the setting, or see the online Help.</p> <p>Do not try to pull the page out of the printer before duplexing is complete. Jamming might result.</p>

Pages print, but are totally blank.

Cause	Solution
<p>The sealing tape might still be in the print cartridge.</p>	<p>Remove the print cartridge and pull out the sealing tape. Reinstall the print cartridge.</p>
<p>The file might have blank pages.</p>	<p>Check the file to make sure that it does not contain blank pages.</p>

The printer prints, but the text is wrong, garbled, or incomplete.

Cause	Solution
The printer cable is loose or defective.	Disconnect the printer cable and reconnect it. Try a print job that you know works. If possible, attach the cable and printer to another computer and try a print job that you know works. Finally, try a new cable.
The printer is on a network or sharing device and is not receiving a clear signal.	Disconnect the printer from the network and use a parallel or USB cable to attach it directly to a computer. Print a job that you know works.
The wrong driver was selected in the software.	Check the software's printer selection menu to make sure that an HP LaserJet 4250 or 4350 series printer is selected.
The software program is malfunctioning.	Try printing a job from another program.

The printer does not respond when you select Print in the software.

Cause	Solution
The printer is out of media.	Add media.
The printer might be in the manual feed mode.	Change the printer from manual-feed mode.
The cable between the computer and the printer is not connected properly.	Disconnect and reconnect the cable.
The printer cable is defective.	If possible, attach the cable to another computer and print a job that you know works. You might also try using a different cable.
The wrong printer was selected in the software.	Check the software printer selection menu to make sure that an HP LaserJet 4250 or 4350 series printer is selected.
The printer might have a jam.	Clear any jams, paying careful attention to the duplexer area (if your model has a duplexer). See Clearing jams .
The software for the printer is not configured for the printer port.	Check the software's printer selection menu to make sure that it is using the correct port. If the computer has more than one port, make sure that the printer is attached to the correct one.
The printer is on a network and is not receiving a signal.	Disconnect the printer from the network and use a parallel or USB cable to attach it directly to a computer. Reinstall the printing software. Print a job that you know works. Clear any stopped jobs from the print queue.
The printer is not receiving power.	If no lights are on, check the power cord connections. Check the power switch. Check the power source.

The printer does not respond when you select Print in the software.

Cause	Solution
The printer is malfunctioning.	Check the control-panel display for messages and lights to determine if the printer is indicating an error. Note any message and see Interpreting control-panel messages .

Guidelines for using paper

For best results, make sure the paper is of good quality, and free of cuts, nicks, tears, spots, loose particles, dust, wrinkles, voids, and curled or bent edges.

If you are unsure what type of paper you are loading (such as bond or recycled), check the label on the package of paper.

For a complete list of supported media, see [Supported sizes of print media](#).

The following problems with paper cause print quality deviations, jamming, or even damage to the printer.

Symptom	Problem with paper	Solution
Poor print quality or toner adhesion	The paper is too moist, too rough, too heavy, too smooth, or it is embossed or from a faulty paper lot.	Try another kind of paper, between 100 and 250 Sheffield, and with 4 to 6% moisture content.
Dropouts, jamming, curl	The paper has been stored improperly. The paper varies from side to side.	Store paper flat in its moisture-proof wrapping. Turn the paper over.
Excessive curl	The paper is too moist, has the wrong grain direction, or is of short-grain construction. The paper varies from side to side.	Open the rear output bin, or use long-grain paper. Turn the paper over.
Jamming, damage to printer	The paper has cutouts or perforations.	Use paper that is free of cutouts or perforations.
Problems with feeding	The paper has ragged edges, or it is from a faulty paper lot. The paper varies from side to side. The paper is too moist, too rough, too heavy, or too smooth. It has the wrong grain direction, is of short-grain construction, or it is embossed.	Use high-quality paper that is made for laser printers. Turn the paper over. Try another kind of paper, between 100 and 250 Sheffield, and with 4 to 6% moisture content. Open the rear output bin, or use long-grain paper.

NOTE

Do not use letterhead paper that is printed with low-temperature inks, such as those used in some types of thermography. Do not use raised or embossed letterhead. The printer uses heat and pressure to fuse toner to the paper. Make sure that any colored paper or preprinted forms use inks that are compatible with this fusing temperature (200°C or 392°F for 0.1 second).

CAUTION

Failure to follow these guidelines could cause jams or damage to the printer.

Printing special pages

Special pages within the memory of the printer can help you to diagnose and learn about problems with your printer.

- **Configuration page**

The configuration page lists many of the current settings and properties of the printer. For information about how to print the configuration page, see [Configuration page](#). If you have an HP Jetdirect print server installed, a second page prints that lists all of the HP Jetdirect information.

- **Font list**

You can print a font list using the control panel (see [PS or PCL font list](#)) or (for Macintosh computers) the HP LaserJet Utility (see [HP LaserJet Utility](#)).

- **Supplies status page**

Use the supplies status page to obtain information about the print cartridge that is installed in the printer, the amount of life that is left in the print cartridge, and the number of pages and jobs that have been processed (see [Supplies status page](#)).

Clearing jams

If a jam message appears on the printer control-panel display, look for jammed paper or other print media in the locations that are indicated in the figure below. Then see the procedure for clearing the jam. You might need to look for media in other locations than those that are indicated in the jam message. If the location of the jam is not obvious, look first in the top-cover area underneath the print cartridge.

When clearing jams, be very careful not to tear jammed media. If a small piece of media is left in the printer, it could cause additional jams. If jams are a recurring problem, see [Solving repeated jams](#).

Jam locations

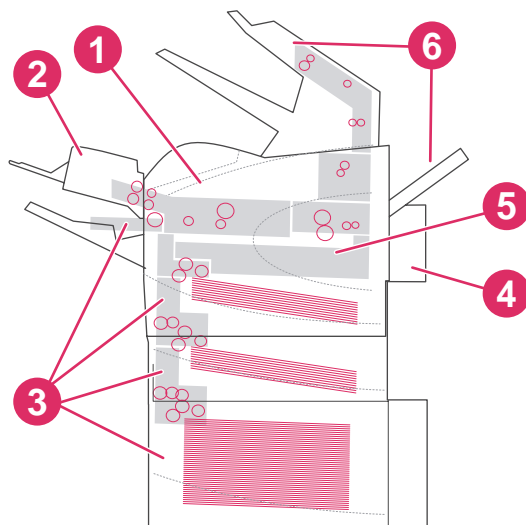

- 1 Top-cover and print-cartridge areas
- 2 Optional envelope feeder
- 3 Tray areas (tray 1, tray 2, and optional trays)
- 4 Optional duplexer
- 5 Fuser area
- 6 Output areas (top bin, rear bin, and optional stacker or stapler/stacker)

NOTE

Loose toner might remain in the printer after a jam and cause temporary print-quality problems. These problems should clear up within a few pages.

Clearing jams from the top-cover and print-cartridge areas

Clear jams that occur during the printing process by using this procedure.

To clear jams from the top-cover and print-cartridge areas

1. Open the top cover and remove the print cartridge.

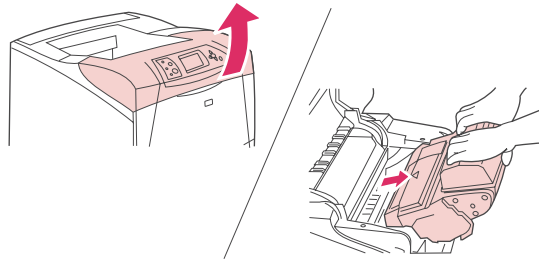

CAUTION

To prevent damage to the print cartridge, do not expose it to light for more than a few minutes. Cover the print cartridge with a sheet of paper while it is outside of the printer.

2. Use the green handle to lift the paper-access plate.

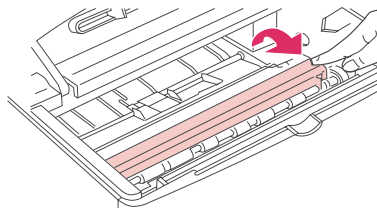

3. Slowly pull the jammed media out of the printer. Do not tear the media. If media is difficult to remove, try clearing it from the tray area. (See [Clearing jams from the trays.](#))

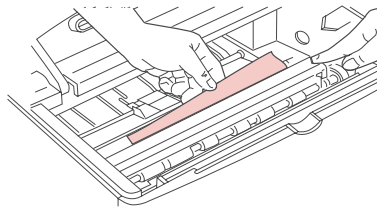

NOTE

Avoid spilling loose toner. Using a dry, lint-free cloth, clean any loose toner that might have fallen into the printer. If loose toner falls into the printer, it might cause temporary problems with print quality. Loose toner should clear from the printer after a few pages are printed. If toner gets on your clothing, wipe it off with a dry cloth and wash clothing in cold water. (Hot water sets toner into fabric.)

4. Open tray 1 and remove the entrance cover. If media is present, remove it.

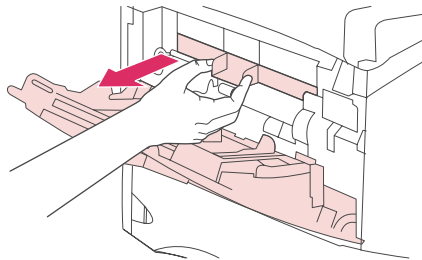

5. Rotate the paper guide to check for additional jammed media underneath. If jammed media is present, remove it.

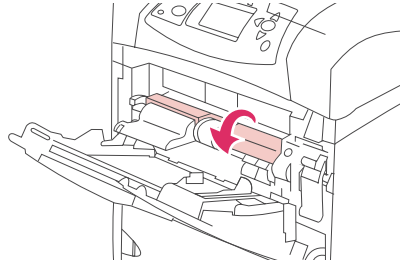

6. Replace the entrance cover and close tray 1.

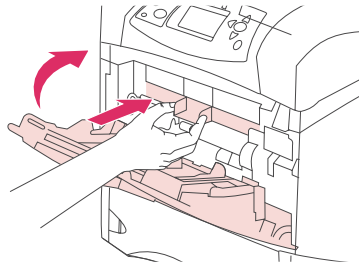

7. Reinstall the print cartridge and close the top cover.

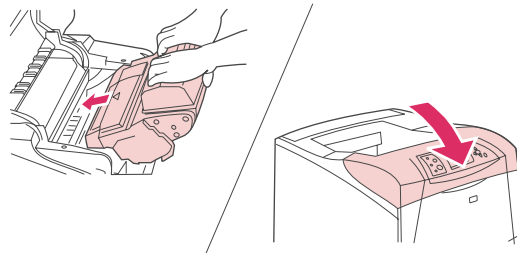

8. If a jam message persists, jammed media is still in the printer. Look for the jam in another location. (See [Jam locations.](#))

If you are using a non-HP print cartridge, the message **NON HP SUPPLY INSTALLED** might appear on the printer control panel display. Press ✓ (**SELECT** button) to continue.

Clearing jams from the optional envelope feeder

This section applies only to jams that occur when you are using an optional envelope feeder.

To clear jams from the optional envelope feeder

1. Remove any envelopes that are loaded in the optional envelope feeder. Lower the envelope weight and lift the tray extension up, to the closed position.

2. Press and hold the release button on the left side of the optional envelope feeder. Grasp both sides of the optional envelope feeder and carefully pull it out of the printer.

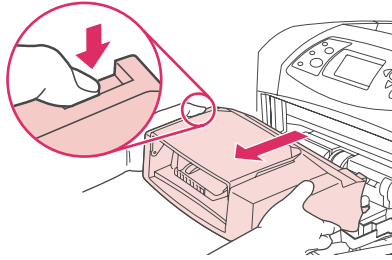

3. Slowly remove any jammed envelopes from the optional envelope feeder and the printer.

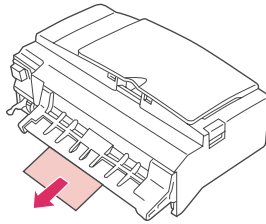

4. Insert the optional envelope feeder into the printer until it locks into place. (The connector on the top, right side of the optional envelope feeder fits into the plug in the printer.) Pull gently on the optional envelope feeder to be sure that it is securely in place.

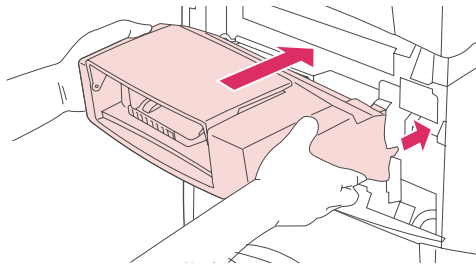

5. Press (**SELECT** button) to clear the jam message.
6. If a jam message persists, an envelope is still jammed in the printer. Look for the jam in another location. (See [Jam locations.](#))
7. Reload the envelopes, making sure that you push the bottom envelopes in slightly further than the top envelopes. (See [Loading envelopes in the optional envelope feeder.](#))

Clearing jams from the trays

This section describes how to clear jams from the trays. Also see [Clearing jams from the optional envelope feeder.](#)

To clear jams from tray 1

Slowly pull the jammed paper or other print media out of the printer. If part of the paper has already been pulled into the printer, follow the steps under [To clear jams from the top-cover and print-cartridge areas.](#)

To clear jams from tray 2 or an optional 500-sheet tray

1. Slide the tray out of the printer, lift it slightly, and remove any damaged media from the tray.
2. If the edge of the jammed media is visible in the feed area, slowly pull the media down and out of the printer. (Do not pull the media straight out, or it will tear.) If the media is not visible, look in the next tray or in the top-cover area. (See [To clear jams from the top-cover and print-cartridge areas.](#))

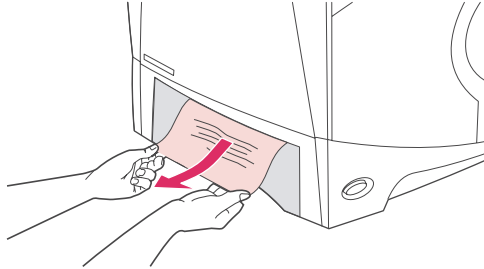

NOTE

Do not force the media if it will not move easily. If the media is stuck in a tray, try removing it through the tray above (if applicable) or through the top-cover area.

3. Make sure that the media is flat in the tray at all four corners and below the maximum-height indicators.

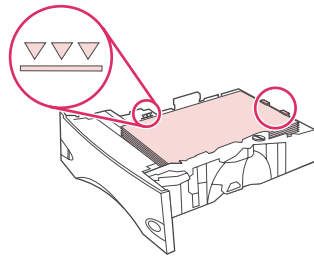

4. Slide the tray back into the printer.

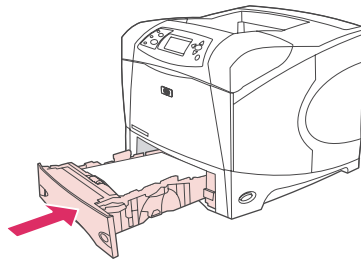

5. Press ✓ (**SELECT** button) to clear the jam message.
6. If a jam message persists, a sheet is still jammed in the printer. Look for the jam in another location. (See [Jam locations.](#))

To clear jams from the optional 1,500-sheet tray

1. Open the front door of the tray.

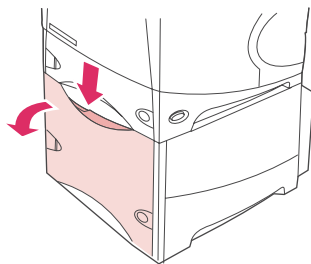

2. If the edge of the jammed paper is visible in the feed area, slowly pull the paper down and out of the printer. (Do not pull the paper straight out, or it will tear.) If the paper is not visible, look in the top-cover area. (See [To clear jams from the top-cover and print-cartridge areas.](#))

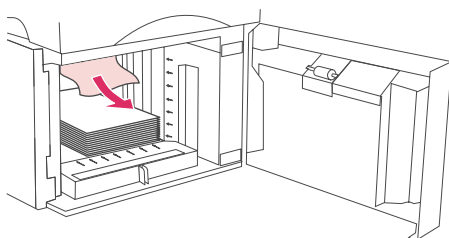

3. Make sure that the paper does not exceed the fill marks on the paper guides, and that the front edge of the stack is aligned with the arrows.

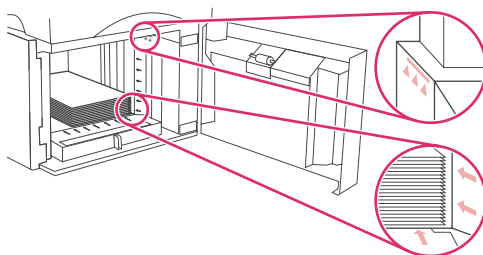

4. Close the front door of the tray.

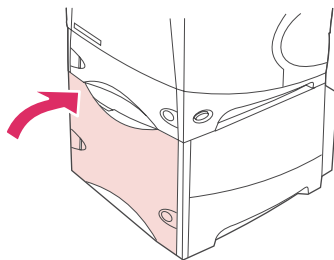

5. Press ✓ (**SELECT** button) to clear the jam message.
6. If a jam message persists, a sheet is still jammed in the printer. Look for the jam in another location. (See [Jam locations.](#))

Clearing jams from the optional duplexer

If you are duplexing a print job and experience a jam, use this procedure to check for the jam and to clear it.

To clear jams from the optional duplexer

1. Lift the optional duplexer up and then pull it out to remove it.

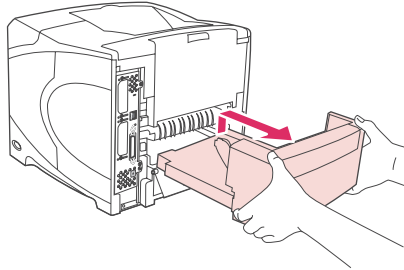

2. Remove any paper that is on top of tray 2. (You might need to reach inside the printer.)

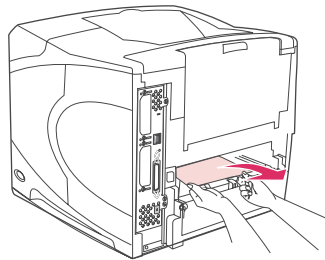

3. Slowly pull any paper out of the optional duplexer.

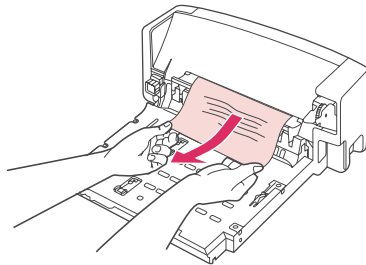

4. Insert the optional duplexer into the printer.

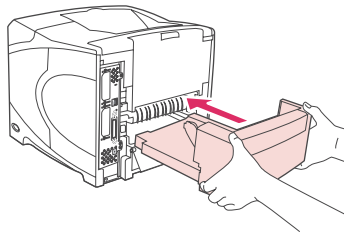

5. If a jam message persists, a sheet is still jammed in the printer. Look for jam in another location. (See [Jam locations](#).)

Clearing jams from the output areas

Use the procedures in this section to clear jams that occur in the rear output bin or in the optional stacker or stapler/stacker.

To clear jams from the rear output bin

1. Open the rear output bin. If most of the media is still inside the printer, it might be easier to remove it through the top-cover area. (See [To clear jams from the top-cover and print-cartridge areas.](#))
2. Grasp both sides of the media, and slowly pull the media out of the printer. (Loose toner might be on the sheet. Be careful not to spill it on yourself or into the printer.)

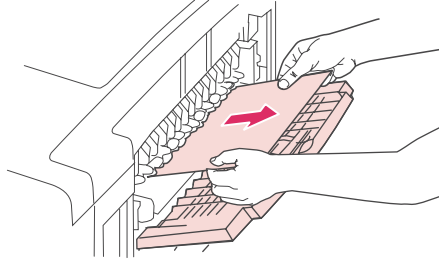

NOTE

If the jammed media is difficult to remove, try opening the top cover all the way to release pressure on the paper. If the sheet has torn, or if you still cannot remove it, see [Clearing jams from the fuser area.](#)

3. Close the rear output bin.

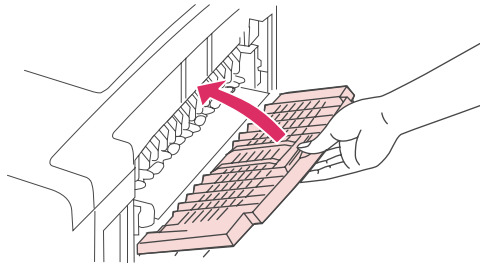

4. Open and close the top cover to clear the jam message.

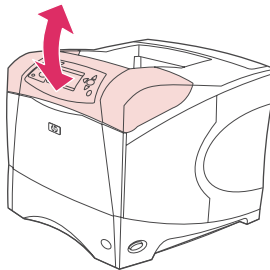

5. If a jam message persists, a sheet is still jammed in the printer. Look for the jam in another location. (See [Jam locations.](#))

Clearing jams from the fuser area

Use this procedure only in these situations:

- Media has jammed inside the fuser and cannot be removed from the top-cover area or the rear-output area.
- A sheet of media has torn while you were trying to clear a jam from the fuser.

To clear jams from the fuser area

1. Turn the printer power off and unplug the power cord from the printer.

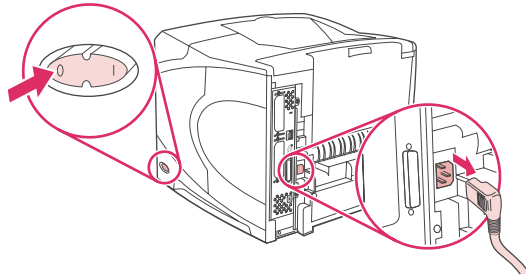

WARNING!

The fuser is very hot. To avoid minor burns, wait 30 minutes for the fuser to cool before removing it from the printer.

2. Turn the printer so that its rear cover faces you. If it is installed, remove the optional duplexer by lifting it up and then pulling it out.

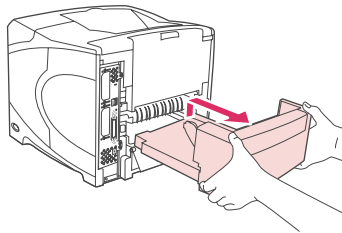

3. Open the rear output bin and pull the extension outward until it stops.

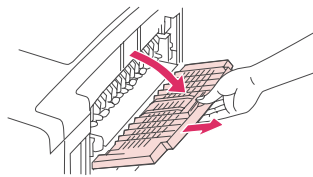

4. Remove the rear output bin and extension by bending the middle of the bin down and releasing the two hinge pins.

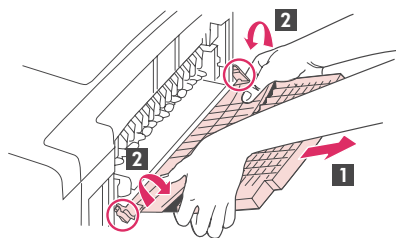

5. Firmly grasp each side of the fuser. Push the blue levers upward and pull the fuser straight out of the printer.

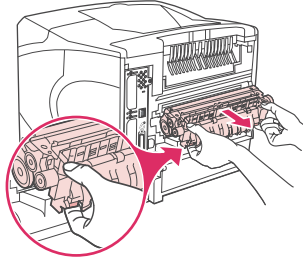

6. Remove the jammed media. If necessary, lift the black plastic guide that is located on the top of the fuser to gain access to the jammed sheet. You can also turn the jam-clearing wheel that is located on the side of the fuser to attempt to eject the jammed sheet.

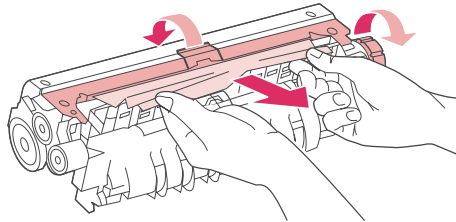

CAUTION

Do not use a sharp object to clear media from the fuser area. You might damage the fuser.

7. Push the fuser firmly into the printer until the blue levers on both sides click into place.

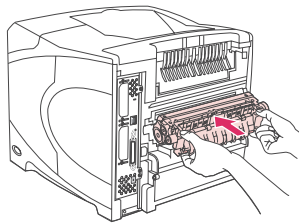

8. Install the rear output bin. Pull gently on the bin to make sure that the hinge pins are fully inserted.

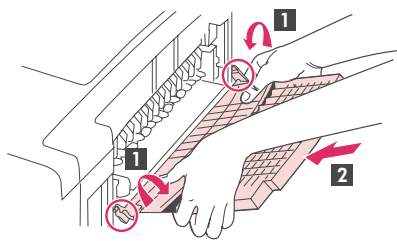

9. Plug the power cord into the printer.

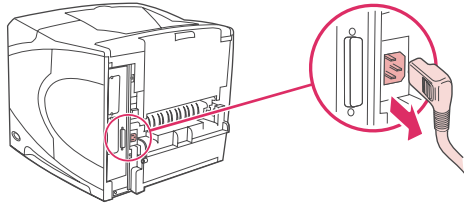

10. Replace the optional duplexer, if it was removed.

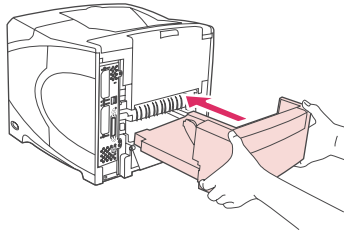

11. Turn the printer power on.

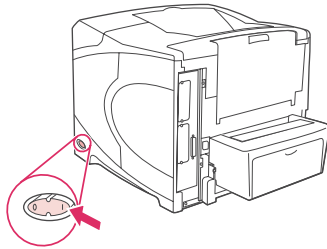

12. If a jam message persists, a sheet is still jammed in the printer. Look for the jam in another location. (See [Jam locations.](#))

After clearing all jams, you need to send the print job again because the printer power has been turned off.

Clearing jams from the optional stacker or stapler/stacker

Paper jams can occur in the optional stacker or the optional stapler/stacker. Staple jams can occur only in the optional stapler/stacker.

To clear paper jams from the optional stacker or stapler/stacker

1. At the back of the printer, open the door on the stacker or stapler/stacker.

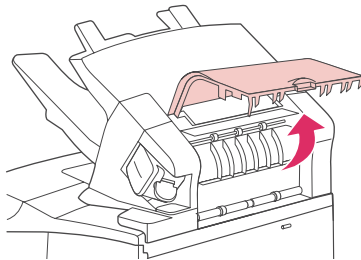

2. Carefully remove any jammed paper.

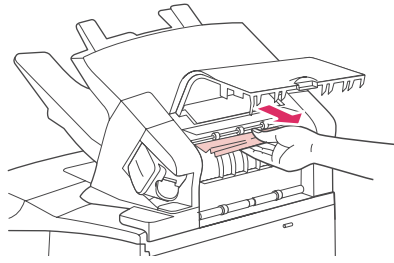

3. Close the door on the stapler or stapler/stacker.

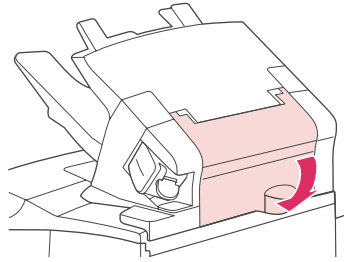

4. If a jam message persists, a sheet is still jammed. Look for it in another location. Check the front of the accessory and carefully remove any jammed paper. (See [Jam locations.](#))

NOTE

The output bin must be pushed down into the lowest position for printing to continue.

To clear staple jams from the optional stapler/stacker

NOTE

Clear staple jams when the message **JAM IN STAPLER** appears on the printer control-panel display.

1. On the right side of the stapler/stacker, turn the stapler unit toward the front of the printer until the unit clicks into the open position. Pull outward on the blue staple cartridge to remove it.

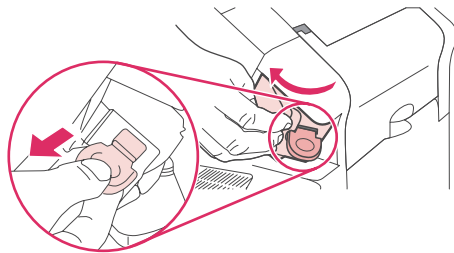

2. Rotate the green cover on the end of the staple cartridge upward, and remove the jammed staple.

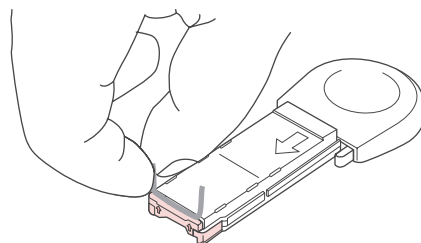

3. Insert the staple cartridge into the stapler unit, and rotate the stapler unit toward the rear of the printer until the unit snaps into place.

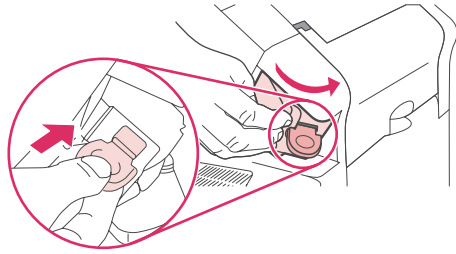

The stapler needs to reload after clearing a staple jam, so the first few documents (up to five) might not be stapled. If a print job is sent and the stapler is jammed or is out of staples, the job will still print as long as the path to the stacker bin is not blocked.

Solving repeated jams

If paper jams occur frequently, try the following:

- Check all the jam locations. (See [Clearing jams.](#)) A piece of media might be stuck somewhere in the printer. Even a small torn piece of media in the printer path can cause repeated jams.
- Check that the trays are properly adjusted. (See [Loading trays.](#)) The guides should click into place without being too tight against the media.
- Check that media is correctly loaded in the trays and that the trays are not overfilled. Make sure that the stack is under the tabs and below the maximum-height indicators. See [Loading trays.](#)
- Check that all trays and paper-handling accessories are completely inserted into the printer. (If a tray is opened during a print job, this might cause a jam.)
- Check that all covers and doors are closed. (If a cover or door is opened during a print job, this might cause a jam.)
- Try printing to a different output bin. (See [Understanding media output options.](#))
- The sheets might be sticking together. Try bending the stack to separate each sheet. Do not fan the stack.
- If you are printing from tray 1, try reducing the size of the stack.
- If you are printing from the optional envelope feeder, make sure that it is loaded correctly (with the bottom envelopes in slightly farther than the top envelopes). (See [Loading envelopes in the optional envelope feeder.](#))
- If you are printing small sizes, feed the media with the short-edge first. (See [Guidelines for custom-size paper.](#))
- Turn over the stack of media in the tray. Also try rotating the paper 180 degrees.
- Check the characteristics of the paper or other print media that you are using. Use only media that meets HP specifications. (See [Paper specifications.](#)) Try using different media to see if the problem goes away. Do not use curled, deformed, damaged, or irregular media.
- Check that the environmental conditions for the printer are met. (See [Operating environment.](#))
- Avoid using paper that has already been used in a printer or copier.
- Try using paper from a freshly opened ream.

- Try a different brand of paper.
- Do not print on both sides of envelopes or transparencies. (See [Printing envelopes](#) or [Printing on transparencies](#).)
- Print only on full sheets of labels and do not print on both sides of label sheets. (See [Printing on labels](#).)
- Check that the power supplied to the printer is steady and meets printer specifications. (See [Electrical specifications](#).)
- Clean the printer. (See [Cleaning the printer](#).)
- Perform preventive printer maintenance if maintenance is due. See [Loading staples](#).

Understanding printer messages

Printer messages appear on the printer control panel display to relay the normal status of the printer (such as **Processing...**) or an error condition (such as **CLOSE TOP COVER**) that needs attention. [Interpreting control-panel messages](#) lists the most common messages that require attention or that might raise questions. Messages are listed in alphabetical order first, with numeric messages at the end of the list.

Using the printer online Help system

This printer features an online Help system on the control panel that provides instructions for resolving most printer errors. Certain control panel messages alternate with instructions about gaining access to the online Help system.

Whenever a message alternates with **For help press**, press ? (**HELP** button) to view the help and use ▲ (**UP** button) and ▼ (**DOWN** button) to scroll through the message.

To exit the online Help system, press **MENU**.

Resolving persistent messages

Some messages (for example, requests to load a tray or a message that a previous print job is still in the printer memory) allow you to press ✓ (**SELECT** button) to print, or to press **STOP** to clear the job and eliminate the message.

If a message persists after performing all of the recommended actions, contact an HP-authorized service or support provider. (See [HP customer care](#) or go to <http://www.hp.com/support/lj4250> or <http://www.hp.com/support/lj4350>.)

Interpreting control-panel messages

Control panel message	Description	Recommended action
10.XX.YY SUPPLY MEMORY ERROR For help press ?	An error has occurred in one or more of the printer's supplies. Values of XX and YY are listed below: XX00 = memory is defective XX01 = memory is missing YY00 = black print cartridge	<ol style="list-style-type: none">1. Turn the printer power off, and then turn the printer power on to clear the message.2. If the message persists, contact an HP-authorized service or support provider (see HP customer care).
10.32.00 UNAUTHORIZED SUPPLY For help press ?	The printer has detected that a printer supply is not a genuine HP supply.	This message is displayed until you install an HP supply or press the override button ✓ (SELECT button), (which may void the printer warranty). If you believe you purchased an HP supply, go to http://www.hp.com/go/anticounterfeit . Any printer repair required as a result of using non-HP supplies or unauthorized supplies is not covered under the printer warranty.

Interpreting control-panel messages (continued)

Control panel message	Description	Recommended action
13.XX.YY JAM IN <Location>	A jam has occurred in the specified location.	Remove jammed media from the specified location. See Clearing jams . If the message persists after all jams have been cleared, a sensor might be stuck or broken. Contact an HP-authorized service or support provider (see HP customer care).
20 INSUFFICIENT MEMORY For help press ? alternates with 20 INSUFFICIENT MEMORY To continue press ✓	The printer received more data than can fit in its available memory. You might have tried to transfer too many macros, soft fonts, or complex graphics.	Press ✓ (SELECT button) to print the transferred data (some data might be lost), and then simplify the print job or install additional memory. (See Printer memory .)
21 PAGE TOO COMPLEX For help press ? alternates with 21 PAGE TOO COMPLEX To continue press ✓	The data (dense text, rules, raster or vector graphics) sent to the printer was too complex.	<ol style="list-style-type: none"> Press ✓ (SELECT button) to print the transferred data (some data might be lost). If this message appears often, simplify the print job or install additional memory. (See Printer memory.)
22 EIO X BUFFER OVERFLOW To continue press ✓	Too much data was sent to the EIO card in the specified slot [X]. An improper communications protocol might be in use. Note: EIO 0 is reserved for the HP Jetdirect embedded print server.	<ol style="list-style-type: none"> Press ✓ (SELECT button) to clear the message. (The job will not be printed.) Check the host configuration. If the message persists, contact an HP-authorized service or support provider (see HP customer care).
22 PARALLEL I/O BUFFER OVERFLOW For help press ? alternates with 22 PARALLEL I/O BUFFER OVERFLOW To continue press ✓	Too much data was sent to the parallel port.	<ol style="list-style-type: none"> Check for a loose cable connection and be sure to use a high-quality cable. Some non-HP parallel cables might be missing pin connections or might otherwise not conform to the IEEE-1284 specification. (See Ordering parts, accessories, and supplies.) This error can occur if the driver you are using is not IEEE-1284 compliant. For best results, use an HP driver that came with the printer. (See Software.) Press ✓ (SELECT button) to clear the error message. (The job will not be printed.) If the message persists, contact an HP-authorized service or support provider (see HP customer care).

Interpreting control-panel messages (continued)

Control panel message	Description	Recommended action
22 USB I/O BUFFER OVERFLOW To continue press ✓	Too much data was sent to the USB port.	Press ✓ (SELECT button) to clear the error message. (The job will not be printed.)
40 EIO X BAD TRANSMISSION To continue press ✓	The connection has been broken between the printer and the EIO card in the specified slot [X]. Note: EIO 0 is reserved for the HP Jetdirect embedded print server.	Press ✓ (SELECT button) to clear the error message and continue printing.
41.3 UNEXPECTED SIZE IN TRAY X For help press ? alternates with LOAD TRAY XX [TYPE][SIZE] To use another tray press ✓ or For help press ?	This is typically caused if two or more sheets stick together in the printer or if the tray is not properly adjusted.	<ol style="list-style-type: none"> 1. Reload the tray with the correct paper size. 2. Press ✓ (SELECT button) to scroll to TRAY XX SIZE=. Reconfigure the size in a tray so that the printer will use a tray that contains the size required for the print job. 3. If the error does not clear, turn the printer power off, then turn the printer power on. 4. If the message persists, contact an HP-authorized service or support provider (see HP customer care).
41.X ERROR For help press ? alternates with 41.X ERROR To continue press ✓	A temporary printing error occurred.	<ol style="list-style-type: none"> 1. Press ✓ (SELECT button). The page containing the error automatically reprints if jam recovery is enabled. 2. Turn the printer power off, and then turn the printer power on. 3. If the message persists, contact an HP-authorized service or support provider (see HP customer care).
49.XXXXX ERROR To continue turn off then on	A critical firmware error has occurred.	<ol style="list-style-type: none"> 1. Turn the printer power off, leave it off for 20 minutes, and then turn the printer power on. 2. If the message persists, contact an HP-authorized service or support provider (see HP customer care).
50.X FUSER ERROR For help press ?	A fuser error has occurred.	<ol style="list-style-type: none"> 1. Turn the printer power off and then on. 2. If the message persists, contact an HP-authorized service or support provider (see HP customer care).

Interpreting control-panel messages (continued)

Control panel message	Description	Recommended action
51.XY ERROR For help press ? alternates with 51.XY ERROR To continue turn off then on	A temporary printing error occurred.	1. Turn the printer power off and then on. 2. If the message persists, contact an HP-authorized service or support provider (see HP customer care).
52.XY ERROR For help press ? alternates with 52.XY ERROR To continue turn off then on	A temporary printing error occurred.	1. Turn the printer power off and then on. 2. If the message persists, contact an HP-authorized service or support provider (see HP customer care).
53.XY.ZZ CHECK RAM DIMM SLOT <X> To continue press ✓	There is a problem with the printer memory. The DIMM that caused the error will not be used.	You will be prompted to press ✓ (SELECT button) to continue in the following cases: <ul style="list-style-type: none"> • 1 or 2 DIMMs where the only error is ZZ=04 • 2 DIMMs where one is good and the other has an error with ZZ=01, 02, 03, or 05 • 2 DIMMs where one has an error with ZZ=04 and the other has an error with ZZ=01, 02, 03, or 05 Values of X and Y are as follows: <ul style="list-style-type: none"> • X = DIMM type, 0 = ROM, 1 = RAM • Y = Device location, 0 = Internal memory (ROM or RAM), 1 or 2 = DIMM slot 1 or 2 If the message continues, you might need to replace the specified DIMM. Turn the printer power off, and then replace the DIMM that caused the error.
54.XX ERROR To continue turn off then on	This message is typically related to a sensor issue.	Turn the printer power off and then on. If error reappears, record message and contact an HP-authorized service or support provider (see HP customer care).

Interpreting control-panel messages (continued)

Control panel message	Description	Recommended action
<p>55.XX.YY DC CONTROLLER ERROR For help press ? alternates with 55.XX.YY DC CONTROLLER ERROR To continue turn off then on</p>	<p>A temporary printing error occurred.</p>	<ol style="list-style-type: none"> 1. Turn the printer power off and then on. 2. If the message persists, contact an HP-authorized service or support provider (see HP customer care).
<p>56.XX ERROR For help press ? alternates with 56.XX ERROR To continue turn off then on</p>	<p>A temporary printing error occurred as a result of an incorrect input or output request.</p>	<ol style="list-style-type: none"> 1. Turn the printer power off and then on. 2. If the message persists, contact an HP-authorized service or support provider (see HP customer care).
<p>57.XX ERROR For help press ? alternates with 57.XX ERROR To continue turn off then on</p>	<p>A temporary printing error occurred in one of the printer fans.</p>	<ol style="list-style-type: none"> 1. Turn the printer power off and then on. 2. If the message persists, contact an HP-authorized service or support provider (see HP customer care).
<p>58.XX ERROR For help press ? alternates with 58.XX ERROR To continue turn off then on</p>	<p>A printer error has occurred where a memory tag CPU error was detected, or there is a problem with the air sensor or power supply.</p>	<p>To resolve problems with the power supply:</p> <ol style="list-style-type: none"> 1. Remove the printer from any UPS supplies, additional power supplies, or power strips. Plug the printer into a wall outlet and see if this resolves the problem. 2. If the printer is already plugged into a wall outlet, try another power source in the building that is independent of the one currently being used. <p>The line voltage and current source at the printer location might need to be inspected to ensure that they meet the electrical specifications for the printer. (See Electrical specifications.)</p> <p>If the message persists, contact an HP-authorized service or support provider (see HP customer care).</p>

Interpreting control-panel messages (continued)

Control panel message	Description	Recommended action
59.XY ERROR For help press ? alternates with 59.XY ERROR To continue turn off then on	A temporary printing error occurred.	<ol style="list-style-type: none"> 1. Turn the printer power off and then on. 2. If the message persists, contact an HP-authorized service or support provider (see HP customer care).
62 NO SYSTEM To continue turn off then on	This message indicates that no system was found. The printer software system is corrupt.	<ol style="list-style-type: none"> 1. Turn the printer power off and then on. 2. If the message persists, contact an HP-authorized service or support provider (see HP customer care).
64 ERROR For help press ? alternates with 64 ERROR To continue turn off then on	A temporary printing error occurred in the scan buffer.	<ol style="list-style-type: none"> 1. Turn the printer power off and then on. 2. If the message persists, contact an HP-authorized service or support provider (see HP customer care).
66.XY.ZZ EXTERNAL DEVICE FAILURE For help press ?	An error occurred between the printer and an external paper-handling accessory.	<ol style="list-style-type: none"> 1. Turn the printer power off. 2. Check that the accessory is properly seated on and connected to the printer, without any gaps between the printer and the accessory. If the accessory uses cables, disconnect and reconnect them. 3. Turn the printer power on. 4. If the error reappears, record the message, and contact HP Customer Support. (See HP customer care.)
66.XY.ZZ INPUT DEVICE FAILURE	An error occurred in an external paper-handling accessory.	<ol style="list-style-type: none"> 1. Turn the printer power off. 2. Check that the accessory is properly seated on and connected to the printer, without any gaps between the printer and the accessory. If the accessory uses cables, disconnect and reconnect them. 3. Turn the printer power on. 4. If the error reappears, record the message, and contact HP Customer Support. (See HP customer care.)

Interpreting control-panel messages (continued)

Control panel message	Description	Recommended action
<p>66.XY.ZZ OUTPUT DEVICE FAILURE</p>	<p>An error occurred in an external paper-handling accessory.</p>	<ol style="list-style-type: none"> 1. Turn the printer power off. 2. Check that the accessory is properly seated on and connected to the printer, without any gaps between the printer and the accessory. If the accessory uses cables, disconnect and reconnect them. 3. Turn the printer power on. 4. If the error reappears, record the message, and contact HP Customer Support. (See HP customer care.)
<p>68.X PERMANENT STORAGE FULL</p> <p>For help press ?</p> <p>alternates with</p> <p>68.X PERMANENT STORAGE FULL</p> <p>To continue press ✓</p>	<p>The printer permanent storage is full. Some settings might have been reset to the factory defaults.</p>	<ol style="list-style-type: none"> 1. If the error does not clear, turn printer off then on. 2. Print a configuration page and check the printer settings to determine which values have changed. See Configuration page. 3. Turn the printer power off, then press and hold MENU while turning the printer on to clean up permanent storage. 4. If the error reappears, record the message and contact an HP-authorized service or support provider (see HP customer care).
<p>68.X PERMANENT STORAGE WRITE FAIL</p> <p>To continue press ✓</p>	<p>The storage device is failing to write. Printing can continue, but there might be some unexpected behaviors because an error occurred in permanent storage.</p>	<p>Press ✓ (SELECT button) to continue.</p> <p>If the error does not clear, turn the printer off then on. If error reappears, record the message and contact an HP-authorized service or support provider (see HP customer care).</p>
<p>68.X STORAGE ERROR SETTINGS CHANGED</p> <p>For help press ?</p> <p>alternates with</p> <p>68.X STORAGE ERROR SETTINGS CHANGED</p> <p>To continue press ✓</p>	<p>An error occurred in the printer permanent storage and one or more printer settings has been reset to its factory default.</p>	<p>Press ✓ (SELECT button) to clear the message, and press ✓ (SELECT button) to resume printing.</p> <p>Print a configuration page and check the printer settings to determine which values have changed. See Configuration page.</p> <p>If the error does not clear, turn printer off then on. If the error reappears, record the message and contact an HP-authorized service or support provider (see HP customer care).</p>

Interpreting control-panel messages (continued)

Control panel message	Description	Recommended action
<p>69.X ERROR</p> <p>For help press ?</p> <p>alternates with</p> <p>69.X ERROR</p> <p>To continue</p> <p>turn off then on</p>	<p>A printing error occurred.</p>	<ol style="list-style-type: none"> 1. Turn the printer power off and then on. 2. If the message persists, contact an HP-authorized service or support provider (see HP customer care).
<p>79.XXXX ERROR</p> <p>To continue</p> <p>turn off then on</p>	<p>The printer detected a critical hardware error.</p>	<ol style="list-style-type: none"> 1. Press STOP to clear the print job from the printer memory. Turn the printer power off and then on. 2. Try printing a job from a different program. If the job prints, go back to the first program and try printing a different file. If the message appears only with a certain program or print job, contact the software vendor for assistance. <p>If the message persists with different programs and print jobs, try these steps.</p> <ol style="list-style-type: none"> 1. Turn the printer power off. 2. Disconnect all cables to the printer that connect it to the network or computer. 3. Remove all the memory DIMMs or third-party DIMMs from the printer. Then reinstall at least one memory DIMM . (See Printer memory.) 4. Remove all EIO devices and CompactFlash cards from the printer. 5. Turn the printer power on. <p>If the error no longer exists, follow these steps.</p> <ol style="list-style-type: none"> 1. Install each DIMM and EIO device one at a time, making sure to turn the printer power off and back on as you install each device. 2. Replace a DIMM or EIO device if you determine that it causes the error. 3. Reconnect all cables that connect the printer to the network or computer.

Interpreting control-panel messages (continued)

Control panel message	Description	Recommended action
8X.YYYY EIO ERROR	The EIO accessory card in slot [X] has encountered a critical error.	<ol style="list-style-type: none"> 1. Turn the printer power off and then on. 2. Turn the printer power off, reseal the EIO accessory in slot [X], and then turn the printer power on. 3. Turn the printer power off, remove the EIO accessory from slot [X], install it in a different EIO slot, and then turn the printer power on. 4. Replace the EIO accessory in slot [X].
8X.YYYY EMBEDDED JETDIRECT ERROR	The embedded HP Jetdirect print server has encountered a critical error.	<ol style="list-style-type: none"> 1. Turn the printer power off and then on. 2. If the message persists, contact an HP-authorized service or support provider (see HP customer care).
<BINNAME> FULL Remove all paper from bin	The indicated output bin [BINNAME] is full, and printing cannot continue.	Empty the bin so that the current print job can finish.
<BINNAME> FULL Remove all paper from bin alternates with <current status message>	The indicated output bin [BINNAME] is full, but it is not needed for the current print job.	Empty the bin before sending a job to that bin.
Access denied MENUS LOCKED	The printer control panel function you are trying to use has been locked to prevent unauthorized access.	See your network administrator.
BAD DUPLEXER CONNECTION For help press ?	The optional duplexer is not properly connected to the printer.	<ol style="list-style-type: none"> 1. Make sure that you are using the right-angle power cord that came with the printer. 2. Try removing and reinstalling the optional duplexer. Then turn the printer power off and back on.
BAD ENV FEEDER CONNECTION	The optional envelope feeder is not connected properly to the printer.	Try removing and reinstalling the optional envelope feeder. Then, turn the printer power off and back on.
Canceling...	The printer is canceling a job. The message continues while the job is stopped, the paper path is cleared, and any remaining incoming data on the active data channel is received and discarded.	No action necessary.

Interpreting control-panel messages (continued)

Control panel message	Description	Recommended action
<p>CARD SLOT <X> NOT FUNCTIONAL</p> <p>For help press ? alternates with <current status message></p>	<p>The CompactFlash card in slot X is not working correctly.</p>	<ol style="list-style-type: none"> 1. Turn the printer power off. 2. Make sure the card is inserted correctly. 3. If the printer control panel message continues to appear, the card needs to be replaced.
<p>CARD SLOT X DEVICE FAILURE</p> <p>To clear press ✓ alternates with <current status message></p>	<p>The CompactFlash card in slot X had a critical failure and can no longer be used.</p>	<p>Remove the card and replace it with a new one. (See Printer memory.)</p>
<p>CARD SLOT X FILE OPERATION FAILED</p> <p>To clear press ✓ alternates with <current status message></p>	<p>The requested operation could not be performed. You might have attempted an illegal operation, such as trying to download a file to a non-existent folder.</p>	<p>Try printing again to an existing folder.</p>
<p>CARD SLOT X FILE SYSTEM IS FULL</p> <p>To clear press ✓ alternates with <current status message></p>	<p>The CompactFlash card in slot X is full.</p>	<p>Delete files from the CompactFlash card and then try again. Use the Device Storage Manager in HP Web Jetadmin to download or delete files and fonts. (See the HP Web Jetadmin software Help for more information.)</p>
<p>CARD SLOT X IS WRITE PROTECTED</p> <p>To clear press ✓ alternates with <current status message></p>	<p>The CompactFlash card in slot X is protected, and no new files can be written to it.</p>	<p>Use the Device Storage Manager in HP Web Jetadmin to disable the write protection.</p>
<p>CARD SLOT X NOT INITIALIZED</p> <p>To clear press ✓ alternates with <current status message></p>	<p>The file system has not been initialized.</p>	<p>Use HP Web Jetadmin to initialize the file system.</p>

Interpreting control-panel messages (continued)

Control panel message	Description	Recommended action
Checking paper path	The printer is checking for possible jams or paper that was not cleared from the printer.	No action necessary.
Checking printer	The printer is checking for possible jams or paper that was not cleared from the printer.	No action necessary.
CHOSEN PERSONALITY NOT AVAILABLE To continue press ✓ alternates with CHOSEN PERSONALITY NOT AVAILABLE For help press ✓	The printer received a request for a personality (printer language) that does not exist in the printer. The print job is canceled.	Print the job using a printer driver for a different printer language, or add the requested language to the printer (if available). To see a list of available personalities, print a configuration page. (See Configuration page)
CLEANING DISK <X>% COMPLETE Do not power off alternates with CLEANING DISK <X>% COMPLETE For help press ?	Storage device being sanitized or cleaned. Do not turn off. Product functions are unavailable. The printer will automatically restart when finished.	No action necessary.
CLEANING PAGE ERROR Open rear bin	You have attempted to create or process a cleaning page when a duplexer is present and the rear door is closed.	Open the rear output bin to begin creating or processing the cleaning page.
Clearing paper path	The printer jammed or the printer was turned on and media was detected in a wrong location. The printer is automatically attempting to eject the pages.	Wait for the printer to finish trying to clear the pages. If it cannot, a jam message will appear on the control panel display.
CORRUPT FIRMWARE IN EXTERNAL ACCESSORY For help press ?	The printer detected corrupt firmware in an input or output accessory.	Printing can continue, but jams might occur. To view instructions for upgrading the firmware and to download the firmware upgrade, go to http://www.hp.com/support/lj4250 or http://www.hp.com/support/lj4350 .
DATA RECEIVED To print last page press ✓ alternates with <current status message>	The printer is waiting for the command to print (such as waiting for a form feed, or when the print job is paused).	Press ✓ (SELECT button) to continue.

Interpreting control-panel messages (continued)

Control panel message	Description	Recommended action
DIFFERENT PAPER SIZES IN JOB	The stapler cannot align the paper for stapling if different paper sizes are in the job. Printing continues but the job is not stapled.	If stapling is required, modify the job.
DUPLEXER ERROR REMOVE DUPLEXER Install duplexer with power off	The optional duplexer has an error.	Turn off the printer power and reattach the optional duplexer. (Any print jobs at the printer might be lost.)
EIO X disk spinning up	The disk accessory in EIO slot [X] is initializing.	No action necessary.
EIO X DISK NOT FUNCTIONAL For help press ?	The EIO disk in slot X is not working correctly.	<ol style="list-style-type: none"> 1. Turn the printer power off. 2. Make sure the EIO disk is inserted correctly and securely fastened. 3. If the printer control panel message continues to appear, the optional hard disk needs to be replaced.
EIO X DISK DEVICE FAILURE To clear press ✓ alternates with <current status message>	The EIO disk had a critical failure and can no longer be used.	Remove the EIO disk and replace it with a new one.
EIO X DISK FILE OPERATION FAILED To clear press ✓ alternates with <current status message>	The requested operation could not be performed. You might have attempted an illegal operation, such as trying to download a file to a non-existent folder.	Try printing again to an existing folder.
EIO X DISK FILE SYSTEM IS FULL To clear press ✓ alternates with <current status message>	The EIO disk is full.	Delete files from the EIO disk and then try again. Use the Device Storage Manager in HP Web Jetadmin to download or delete files and fonts.

Interpreting control-panel messages (continued)

Control panel message	Description	Recommended action
<p>EIO X DISK IS WRITE PROTECTED</p> <p>To clear press ✓ alternates with <current status message></p>	<p>The EIO disk is protected, and no new files can be written to it.</p>	<p>Use the Device Storage Manager in HP Web Jetadmin to disable the write protection.</p>
<p>EIO X DISK NOT INITIALIZED</p> <p>To clear press ✓ alternates with <current status message></p>	<p>The file system has not been initialized.</p>	<p>Use HP Web Jetadmin to initialize the file system.</p>
<p>ENVELOPE FEEDER EMPTY</p> <p>alternates with <current status message></p>	<p>The envelope feeder is empty.</p>	<p>Load envelopes in the envelope feeder.</p>
<p>Event log empty</p>	<p>You are attempting to view an empty event log by selecting SHOW EVENT LOG from the control panel.</p>	<p>No action necessary.</p>
<p>INSERT OR CLOSE TRAY XX</p> <p>For help press ?</p>	<p>The specified tray is open or missing.</p>	<p>Insert or close the tray for printing to continue.</p>
<p>INSTALL CARTRIDGE</p> <p>For help press ?</p>	<p>The print cartridge is missing and must be reinstalled for printing to continue.</p>	<p>Replace or correctly reinstall the print cartridge.</p>
<p>INSUFFICIENT MEMORY TO LOAD FONTS/DATA .</p> <p>For help press ? alternates with <DEVICE> To continue press ✓</p>	<p>The printer received more data than can fit in its available memory. You might have tried to transfer too many macros, soft fonts, or complex graphics.</p>	<p>Press ✓ (SELECT button) to print the transferred data (some data might be lost).</p> <p>To solve this problem, simplify the print job or install additional memory.</p>
<p>INTERNAL DISK DEVICE FAILURE</p> <p>To clear press ✓ alternates with <current status message></p>	<p>The disk had a critical failure and can no longer be used.</p>	<p>Contact an HP-authorized service or support provider.</p>

Interpreting control-panel messages (continued)

Control panel message	Description	Recommended action
<p>INTERNAL DISK FILE OPERATION FAILED</p> <p>To clear press ✓</p> <p>alternates with</p> <p><current status message></p>	<p>The requested operation could not be performed. You might have attempted an illegal operation, such as trying to download a file to a non-existent folder.</p>	<p>Try printing again to an existing folder.</p>
<p>INTERNAL DISK FILE SYSTEM IS FULL</p> <p>To clear press ✓</p> <p>alternates with</p> <p><current status message></p>	<p>The Internal disk is full.</p>	<p>Delete files from the disk and then try again. Use the Device Storage Manager in HP Web Jetadmin to download or delete files and fonts.</p>
<p>INTERNAL DISK IS WRITE PROTECTED</p> <p>To clear press ✓</p> <p>alternates with</p> <p><current status message></p>	<p>The disk is protected, and no new files can be written to it.</p>	<p>Use the Device Storage Manager in HP Web Jetadmin to disable the write protection.</p>
<p>INTERNAL DISK NOT INITIALIZED</p> <p>To clear press ✓</p> <p>alternates with</p> <p><current status message></p>	<p>The file system has not been initialized.</p>	<p>Use HP Web Jetadmin to initialize the file system.</p>
<p>LOAD TRAY XX [TYPE][SIZE]</p> <p>For help press ?</p>	<p>The tray that is indicated is configured for a specific type and size of media needed by a print job, but the tray is empty. All other trays are also empty.</p>	<p>Load the requested media in the tray that is indicated.</p>
<p>LOAD TRAY XX [TYPE][SIZE]</p> <p>To continue press ✓</p> <p>alternates with</p> <p>LOAD TRAY XX [TYPE][SIZE]</p> <p>For help press ?</p>	<p>A job is sent that requires a specific type and size that is not available in the tray that is indicated.</p>	<p>Load the requested media into the indicated tray and press ✓ (SELECT button).</p>

Interpreting control-panel messages (continued)

Control panel message	Description	Recommended action
LOAD TRAY XX [TYPE][SIZE] To continue press ✓ alternates with Move tray switch to CUSTOM	A job is sent that requires a specific type and size that is not available in the tray that is indicated.	Move the tray switch to the CUSTOM position if another tray is available.
LOAD TRAY XX [TYPE][SIZE] To continue press ✓ alternates with Recommend move tray switch to STANDARD	A job is sent that requires a specific type and size that is not available in the tray that is indicated.	If the size is detectable and another tray is available, move the switch to the STANDARD position.
LOAD TRAY XX [TYPE][SIZE] To continue press ✓ alternates with To use another tray press ✓	A job is sent that requires a specific type and size that is not available in the tray that is indicated.	Press ✓ (SELECT button) to use a type and size that are available in another tray.
MANUALLY FEED [TYPE][SIZE] To continue press ✓ alternates with MANUALLY FEED [TYPE][SIZE] For help press ?	The printer is waiting for media to be loaded in tray 1 for manual feed.	Load the requested media into tray 1 and press ✓ (SELECT button).
MANUALLY FEED [TYPE][SIZE] To use another tray press ✓	The printer is waiting for media to be loaded in tray 1 for manual feed.	Press ✓ (SELECT button) to use a type and size that are available in another tray.
MANUALLY FEED OUTPUT STACK Then press ✓ to print second sides	The first side of a manual duplex job has been printed and the device is waiting for you to insert the output stack to complete the second side.	1. Load the output stack into tray 1, maintaining the same orientation with printed side down. 2. To continue printing, press ✓ (SELECT button) to exit the printer message and then press ✓ (SELECT button) to print.

Interpreting control-panel messages (continued)

Control panel message	Description	Recommended action
No job to cancel	The STOP button was pressed, but there is no active job or buffered data to cancel. The message is displayed for approximately 2 seconds before the printer returns to the ready state.	No action necessary.
NON HP SUPPLY INSTALLED Economode disabled	The printer has detected that the print cartridge is not a genuine HP supply.	This message is displayed until you install an HP cartridge or press the override button ✓ (SELECT button). If you believe you purchased a genuine HP supply, go to http://www.hp.com/go/anticounterfeit . Any printer repair required as a result of using non-HP supplies or unauthorized supplies is not covered under the printer warranty.
NON HP SUPPLY INSTALLED For help press ?	The printer has detected that the print cartridge is not a genuine HP supply.	This message is displayed until you install an HP cartridge or press the override button ✓ (SELECT button). If you believe you purchased a genuine HP supply, go to http://www.hp.com/go/anticounterfeit . Any printer repair required as a result of using non-HP supplies or unauthorized supplies is not covered under the printer warranty.
ORDER CARTRIDGE LESS THAN XXXX PAGES For help press ? alternates with <current status message>	For the HP LaserJet 4250 series, the message first appears when about 15% (10,000-page cartridge) or about 8% (20,000-page cartridge) of the life remains in the print cartridge. For the HP LaserJet 4350 series, the message first appears when about 25% (10,000-page cartridge) or about 15% (20,000-page cartridge) of the life remains in the print cartridge.	Make sure that you have a new cartridge ready (see Ordering parts, accessories, and supplies).
OUTPUT PAPER PATH OPEN For help press ?	The paper path between the printer and the output device is open and must be closed before printing can continue.	<ol style="list-style-type: none"> 1. Make sure the jam-access door on the optional stacker or stapler/stacker is closed. 2. If the accessory is a stapler/stacker, make sure that the stapler unit is snapped into the closed position.
Paused To return to ready press STOP	The printer is paused but continues to receive data until the memory is full. The printer is not experiencing an error.	Press STOP .

Interpreting control-panel messages (continued)

Control panel message	Description	Recommended action
<p>RAM DISK DEVICE FAILURE</p> <p>To clear press ✓ alternates with <current status message></p>	<p>The RAM disk had a critical failure and can no longer be used.</p>	<p>Contact an HP-authorized service or support provider.</p>
<p>RAM DISK FILE OPERATION FAILED</p> <p>To clear press ✓ alternates with <current status message></p>	<p>The requested operation could not be performed. You might have attempted an illegal operation, such as trying to download a file to a non-existent folder.</p>	<p>Try printing again to an existing folder.</p>
<p>RAM DISK FILE SYSTEM IS FULL</p> <p>To clear press ✓ alternates with <current status message></p>	<p>The RAM disk is full.</p>	<ol style="list-style-type: none"> 1. Delete files and then try again, or turn the printer power off, and then turn the printer power on to delete all files on the device. (Use Device Storage Manager in HP Web Jetadmin or another software utility to delete the files.) 2. If the message persists, increase the size of the RAM disk. Change the RAM disk size on the System Setup submenu (on the Configure Device menu) at the printer control panel. See the description of the RAM disk menu items in System Setup submenu.
<p>RAM DISK IS WRITE PROTECTED</p> <p>To clear press ✓ alternates with <current status message></p>	<p>The RAM disk is protected, and no new files can be written to it.</p>	<p>Use the Device Storage Manager in HP Web Jetadmin to disable the write protection.</p>
<p>RAM DISK NOT INITIALIZED</p> <p>To clear press ✓ alternates with <current status message></p>	<p>The file system has not been initialized.</p>	<p>Use HP Web Jetadmin to initialize the file system.</p>
<p>REINSERT DUPLEXER</p>	<p>The duplexer has been removed.</p>	<p>Reinsert the duplexer.</p>

Interpreting control-panel messages (continued)

Control panel message	Description	Recommended action
<p>REPLACE CARTRIDGE</p> <p>For help press ?</p> <p>alternates with</p> <p><current status message></p>	<p>Pages remaining for this supply has reached the low threshold. The printer was set to stop printing when a supply needs to be ordered.</p>	<p>To continue printing, press ✓ (SELECT button) to exit the printer message then press ✓ (SELECT button). The message becomes ORDER CARTRIDGE LESS THAN XXXX PAGES (warning).</p> <p>Follow the next steps to replace the supply.</p> <ol style="list-style-type: none"> 1. Open the top cover. 2. Remove print cartridge. 3. Install new print cartridge. 4. Close the top cover.
<p>REPLACE CARTRIDGE</p> <p>To continue press ✓</p>	<p>Pages remaining for this supply has reached the low threshold. The printer was set to continue printing when a supply needs to be ordered.</p>	<p>Press ✓ (SELECT button) to continue printing the current job.</p> <p>Follow the next steps to replace the supply.</p> <ol style="list-style-type: none"> 1. Open the top cover. 2. Remove print cartridge. 3. Install new print cartridge. 4. Close the top cover.
<p>ROM DISK DEVICE FAILURE</p> <p>To clear press ✓</p> <p>alternates with</p> <p><current status message></p>	<p>The ROM disk had a critical failure and can no longer be used.</p>	<p>Contact an HP authorized service or support provider.</p>
<p>ROM DISK FILE OPERATION FAILED</p> <p>To clear press ✓</p> <p>alternates with</p> <p><current status message></p>	<p>The requested operation could not be performed. You might have attempted an illegal operation, such as trying to download a file to a non-existent folder.</p>	<p>Try printing again to an existing folder.</p>
<p>ROM DISK FILE SYSTEM IS FULL</p> <p>To clear press ✓</p> <p>alternates with</p> <p><current status message></p>	<p>The ROM disk is full.</p>	<p>Delete files from the disk and then try again. Use the Device Storage Manager in HP Web Jetadmin to download or delete files and fonts.</p>

Interpreting control-panel messages (continued)

Control panel message	Description	Recommended action
<p>ROM DISK IS WRITE PROTECTED</p> <p>To clear press ✓ alternates with <current status message></p>	<p>The disk is protected, and no new files can be written to it.</p>	<p>Use the Device Storage Manager in HP Web Jetadmin to disable the write protection.</p>
<p>ROM DISK NOT INITIALIZED</p> <p>To clear press ✓ alternates with <current status message></p>	<p>The file system has not been initialized.</p>	<p>Use HP Web Jetadmin to initialize the file system.</p>
<p>SANITIZING DISK <X>% COMPLETE</p> <p>Do not power off alternates with CLEANING DISK <X>% COMPLETE</p> <p>For help press ?</p>	<p>A hard disk or a CompactFlash card is being sanitized.</p>	<p>No action necessary.</p>
<p>SIZE MISMATCH IN TRAY XX</p> <p>For help press ? alternates with <current status message></p>	<p>The tray indicated is loaded with a different size of paper than the size configured for the tray.</p>	<p>Load the tray with the size configured for the tray.</p> <p>Make sure that the guides are positioned correctly in the tray, and then make sure that the knob is set correctly to Standard or Custom.</p>
<p>STAPLER LOW ON STAPLES</p>	<p>Fewer than 70 staples remain in the optional stapler/stacker cartridge. Printing continues until the cartridge runs out of staples, and the STAPLER OUT OF STAPLES message appears on the printer control panel display.</p>	<p>Replace the staple cartridge. For information about replacing the staple cartridge, see Loading staples. For information about ordering a new staple cartridge, see Part numbers.</p>

Interpreting control-panel messages (continued)

Control panel message	Description	Recommended action
STAPLER OUT OF STAPLES	<p>The stapler in the optional stapler/stacker is out of staples. The printer behavior depends on how STAPLES OUT is configured in the Output Setup submenu.</p>	<ul style="list-style-type: none"> • If STAPLES OUT=STOP, the printer stops printing until you refill the stapler or press Select. This is the default setting. • If STAPLES OUT=CONTINUE, printing continues, but the job is not stapled. <p>Replace the staple cartridge. For information about replacing the staple cartridge, see Loading staples. For information about ordering a new staple cartridge, see Part numbers.</p>
TOO MANY PAGES IN JOB TO STAPLE	<p>The maximum number of sheets the stapler can staple is 15. The print job finishes printing but is not stapled.</p>	<p>For print jobs that have more than 15 pages, staple them manually.</p>
TRAY XX [TYPE][SIZE] To change size or type press ✓ alternates with TRAY XX [TYPE][SIZE] To accept settings press ⇨	<p>This message states the current type and size configuration of the paper tray, and allows you to change the configuration.</p>	<p>To change the paper size or type press ✓ (SELECT button) while the message is present. To clear the message, press the ⇨ (BACK button) while the message is present.</p> <ul style="list-style-type: none"> • Set size and type to ANY if the tray is used frequently for different sizes or types. • Set size and type to a specific setting if printing with only one type of paper.
TRAY XX EMPTY [TYPE][SIZE] alternates with <current status message>	<p>The specified paper tray is empty.</p>	<p>Load paper in the empty tray [XX] to clear the message.</p> <p>If you do not load the specified tray, the printer will continue printing from the next tray with the same paper size and type, and the message will continue to appear.</p>
TRAY XX OPEN For help press ? alternates with <current status message>	<p>The tray cannot feed paper to the printer because tray [X] is open and must be closed for printing to continue.</p>	<p>Check the trays and close any that are open.</p>
Unable to mopy job <JOBNAME> alternates with <current status message>	<p>Memory or file system failures would not allow a mopy job to occur. Only one copy will be produced.</p>	<p>Correct the error and then try again to store the job.</p>

Interpreting control-panel messages (continued)

Control panel message	Description	Recommended action
Unable to store job <JOBNAME> alternates with <current status message>	The print job named cannot be stored due to a memory, disk, or configuration problem.	Correct the error and then try again to store the job.
UNSUPPORTED DATA ON [FS] DIMM IN SLOT X To clear press ✓	The data on the DIMM is not supported. [FS] stands for either ROM or FLASH.	The DIMM may need to be replaced. Turn the printer power off before removing it. Press ✓ (SELECT button) to continue.
USE TRAY XX [TYPE][SIZE] To change press ▲ / ▼ To use press ✓	The printer did not detect the type and size of media requested. The message shows the most likely type and size available and the tray in which they are available.	Press ✓ (SELECT button) to accept the values in the message, or use ▲ (UP button) and ▼ (DOWN button) to scroll through the available choices.
WAITING FOR TRAY XX TO LIFT alternates with <current status message>	The specified tray is in the process of lifting the paper to the top of the tray for proper feeding.	No action necessary.
WARMING UP alternates with <current status message>	The printer is coming out of powersave mode. Printing will continue as soon as it is done.	No action necessary.

Understanding accessory lights for the stacker and stapler/stacker

The following table lists errors that can occur in an accessory (such as the stacker or stapler/stacker) and that are reported by the accessory lights and on the printer control panel display.

Accessory lights

Light	Explanation and solution
Solid green	<ul style="list-style-type: none">• The accessory is receiving power and is ready.• The stapler is low on staples. STAPLER LOW ON STAPLES appears on the printer control-panel display. Fewer than 70 staples remain in the staple cartridge. Replace the staple cartridge. See Loading staples.• The number of pages in the job exceeds the 15-page limit for stapling. TOO MANY PAGES IN JOB TO STAPLE appears on the printer control-panel display. For jobs that have more than 15 pages, staple the pages manually.• The job contains different paper sizes. DIFFERENT PAPER SIZES IN JOB appears on the printer control-panel display. The stapler cannot align the paper for stapling if different paper sizes are in the job. If stapling is required, modify the job.
Solid amber	<ul style="list-style-type: none">• The accessory is experiencing a hardware malfunction. 66.XY.ZZ OUTPUT DEVICE FAILURE appears on the printer control-panel display. (See the section for this message in Interpreting control-panel messages.)

Light	Explanation and solution
Blinking amber	<ul style="list-style-type: none"> • The accessory has a staple jam. 13.XX.YY JAM IN STAPLER appears on the printer control-panel display. (See the section for this message in Interpreting control-panel messages.) • The accessory has a paper jam, or a sheet needs to be removed from the unit, even if the sheet is not jammed. 13.XX.YY JAM IN OUTPUT DEVICE appears on the printer control-panel display. (See the section for this message in Interpreting control-panel messages.) • The bin is full. STACKER BIN FULL appears on the printer control-panel display. (See the section for <BINNAME> FULL in Interpreting control-panel messages.) • The stapler is out of staples. STAPLER OUT OF STAPLES appears on the printer control-panel display. (See the section for this message in Interpreting control-panel messages.) • The bin is in the up position. LOWER THE STACKER BIN appears on the printer control-panel display. (See the section for this message in Interpreting control-panel messages.) • The jam-access door is open. OUTPUT PAPER PATH OPEN appears on the printer control-panel display. (See the section for this message in Interpreting control-panel messages.) • The stapler unit is open. OUTPUT PAPER PATH OPEN appears on the printer control-panel display. (See the section for this message in Interpreting control-panel messages.) • The firmware is corrupt. CORRUPT FIRMWARE IN EXTERNAL ACCESSORY appears on the control-panel display. (See the section for this message in Interpreting control-panel messages.)

Light	Explanation and solution
Off	<ul style="list-style-type: none"> • The printer might be in PowerSave mode. Press any button on the printer control panel. • The accessory is not receiving power. Turn the printer power off. Check that the accessory is properly seated on and connected to the printer, without any gaps between the printer and the accessory. Turn the printer power on. • The accessory might have been disconnected and reconnected while the printer power was on. 66.XY.ZZ EXTERNAL DEVICE FAILURE appears on the printer control panel display. See the section for this message in Interpreting control-panel messages.) • The job might have stalled between the printer and the accessory. PROCESSING JOB appears on the printer control-panel display. Turn the printer power off, and then turn the printer power on.

Replacing accessories or accessory components

If you are unable to resolve problems that are indicated by the stacker or stapler/stacker accessory lights, contact the HP Customer Care Center. (See [HP customer care.](#)) If an HP Customer Care Center representative recommends replacement of the stacker, stapler/stacker, or stapler/stacker components, you can either perform the replacement procedure yourself or have an HP-authorized dealer replace it.

- For the steps to replace the entire stacker accessory or the entire stapler/stacker accessory, see the install guide that came with the accessory.
- For the steps to replace the stapler unit, see [Replacing the stapler unit.](#)
- For the steps to replace the staple cartridge, see [Loading staples.](#)

For more details about ordering replacement parts or supplies, see [Ordering parts, accessories, and supplies](#) and [Part numbers.](#)

Correcting print-quality problems

This section helps you define print-quality problems and what to do to correct them. Often print-quality problems can be handled easily by making sure that the printer is properly maintained, using print media that meets HP specifications, or running a cleaning page.

Print-quality checklist

General print-quality problems can be solved by following the checklist below.

- Check the printer driver to make sure that you are using the best available print quality option (see [Selecting print-quality settings](#)).
- Try printing with one of the alternative printer drivers. The most recent printer drivers are available for download from http://www.hp.com/go/lj4250_software or http://www.hp.com/go/lj4350_software.
- Clean the inside of the printer (see [Cleaning the printer](#)).
- Check the paper type and quality (see [Paper specifications](#)).
- Check to make sure that EconoMode is off in the software (see [Using EconoMode \(draft\) printing](#)).
- Troubleshoot general printing problems (see [Solving general printing problems](#)).
- Install a new HP print cartridge, and then check the print quality again. (See the instructions provided with the print cartridge.)

NOTE

If the page is totally blank (all white) check to make sure that the sealing tape is removed from the print cartridge and ensure that the print cartridge is installed correctly. Newer printers have been optimized to print characters more accurately. This might result in characters that look lighter or thinner than you are used to from your older printer. If the page is printing images darker than those from an older printer, and you want the images to match the older printer, make these changes in your printer driver: on the **Finishing** tab, select **Print Quality**, select **Custom**, click **Details**, and click the check box for **Print Images Lighter**.

Image defect examples

Use the examples in this image-defect table to determine which print-quality problem you are experiencing, and then see the corresponding reference pages to troubleshoot. These examples identify the most common print-quality problems. If you still have problems after trying the suggested remedies, contact HP Customer Support. (See [HP customer care](#).)

NOTE

The examples below depict letter-size paper that has passed through the printer short-edge first.

<p>See Light print (partial page)</p>	<p>See Light print (entire page)</p>	<p>See Specks</p>	<p>See Specks</p>	<p>See Dropouts</p>
<p>See Dropouts</p>	<p>See Dropouts</p>	<p>See Lines</p>	<p>See Gray background</p>	<p>See Toner smear</p>
<p>See Loose toner</p>	<p>See Repeating defects</p>	<p>See Repeating image</p>	<p>See Misformed characters</p>	<p>See Page skew</p>
<p>See Curl or wave</p>	<p>See Wrinkles or creases</p>	<p>See Vertical white lines</p>	<p>See Tire tracks</p>	<p>See White spots on black</p>
<p>See Scattered lines.</p>	<p>See Blurred print.</p>	<p>See Random image repetition (dark)</p>	<p>See Random image repetition (light)</p>	

Light print (partial page)

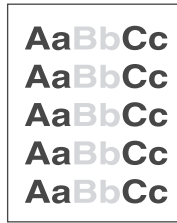

1. Make sure that the print cartridge is fully installed.
2. The toner level in the print cartridge might be low. Replace the print cartridge.
3. The media might not meet HP specifications (for example, the paper is too moist or too rough). See [Paper specifications](#).
4. The printer might be due for maintenance. Check this by printing a copy of the supplies status page. (See [Supplies status page](#).) If maintenance is due, order and install the printer maintenance kit. (See [Performing preventive maintenance](#).)

Light print (entire page)



1. Make sure that the print cartridge is fully installed.
2. Make sure that the EconoMode setting is turned off at the control panel and in the printer driver.
3. Open the Configure Device menu at the printer control panel. Open the Print Quality submenu and increase the TONER DENSITY setting. See [Print Quality submenu](#).
4. Try using a different type of paper.
5. The print cartridge might be almost empty. Replace the print cartridge.

Specks

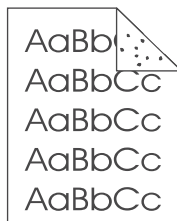

Specks might appear on a page after a jam has been cleared.

1. Print a few more pages to see if the problem corrects itself.

2. Clean the inside of the printer and run a cleaning page to clean the fuser. (See [Cleaning the printer.](#))
3. Try using a different type of paper.
4. Check the print cartridge for leaks. If the print cartridge is leaking, replace it.

Dropouts



1. Make sure that the environmental specifications for the printer are being met. (See [Operating environment.](#))
2. If the paper is rough, and the toner easily rubs off, open the Configure Device menu at the printer control panel. Open the Print Quality submenu, select **FUSER MODES**, and then select the paper type you are using. Change the setting to HIGH 1 or HIGH 2, which helps the toner fuse more completely onto the paper. (See [Print Quality submenu.](#))
3. Try using a smoother paper.

Lines

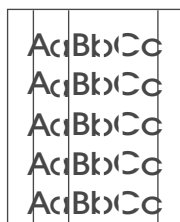

1. Print a few more pages to see if the problem corrects itself.
2. Clean the inside of the printer and run a cleaning page to clean the fuser. (See [Cleaning the printer.](#))
3. Replace the print cartridge.
4. The printer might be due for maintenance. Check this by printing a copy of the supplies status page. (See [Supplies status page.](#)) If maintenance is due, order and install the printer maintenance kit. (See [Performing preventive maintenance.](#))

Gray background

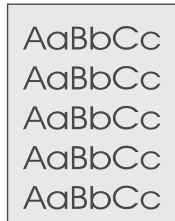

1. Do not use paper that has already been run through the printer.
2. Try using a different type of paper.
3. Print a few more pages to see if the problem corrects itself.
4. Turn over the stack of paper in the tray. Also, try rotating the paper 180°.
5. Open the Configure Device menu at the printer control panel. On the Print Quality submenu, increase the **TONER DENSITY** setting. See [Print Quality submenu](#).
6. Make sure that the environmental specifications for the printer are being met. (See [Operating environment](#).)
7. Replace the print cartridge.

Toner smear

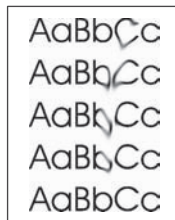

1. Print a few more pages to see if the problem corrects itself.
2. Try using a different type of paper.
3. Make sure that the environmental specifications for the printer are being met. (See [Operating environment](#).)
4. Clean the inside of the printer and run a cleaning page to clean the fuser. (See [Cleaning the printer](#).)
5. The printer might be due for maintenance. Check this by printing a copy of the supplies status page. (See [Supplies status page](#).) If maintenance is due, order and install the printer maintenance kit. (See [Performing preventive maintenance](#).)
6. Replace the print cartridge.

Also see [Loose toner](#).

Loose toner

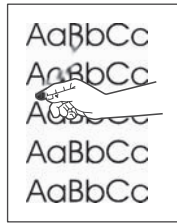

Loose toner, in this context, is defined as toner that can be rubbed off the page.

1. If paper is heavy or rough, open the Configure Device menu at the printer control panel. On the Print Quality submenu, select **FUSER MODES**, and then select the paper type you are using. Change the setting to HIGH 1 or HIGH 2, which helps the toner fuse more completely onto the paper. (See [Print Quality submenu](#).) You must also set the type of paper for the tray you are using. (See [Printing by type and size of media \(locking trays\)](#).)
2. If you have observed a rougher texture on one side of your paper, try printing on the smoother side.
3. Make sure that the environmental specifications for the printer are being met. (See [Operating environment](#).)
4. Make sure that type and quality of the paper you are using meet HP specifications. (See [Paper specifications](#).)
5. The printer might be due for maintenance. Check this by printing a copy of the supplies status page. (See [Supplies status page](#).) If maintenance is due, order and install the printer maintenance kit. (See [Performing preventive maintenance](#).)

Repeating defects

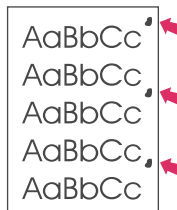

1. Print a few more pages to see if the problem corrects itself.
2. If the distance between defects is 38 mm (1.5 inches), 55 mm (2.2 inches), or 94 mm (3.7 inches), the print cartridge might need to be replaced.
3. Clean the inside of the printer and run a cleaning page to clean the fuser. (See [Cleaning the printer](#).)
4. The printer might be due for maintenance. Check this by printing a copy of the supplies status page. (See [Supplies status page](#).) If maintenance is due, order and install the printer maintenance kit. (See [Performing preventive maintenance](#).)

Also see [Repeating image](#).

Repeating image

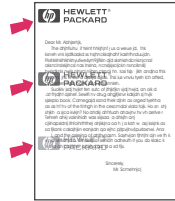

This type of defect might occur when using preprinted forms or a large quantity of narrow paper.

1. Print a few more pages to see if the problem corrects itself.
2. Make sure that type and quality of the paper you are using meet HP specifications. (See [Paper specifications](#).)
3. The printer might be due for maintenance. Check this by printing a copy of the supplies status page. (See [Supplies status page](#).) If maintenance is due, order and install the printer maintenance kit. (See [Performing preventive maintenance](#).)
4. If the distance between defects is 38 mm (1.5 inches), 55 mm (2.2 inches), or 94 mm (3.7 inches), the print cartridge might need to be replaced.

Misformed characters

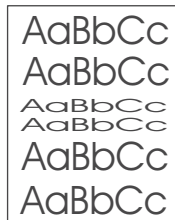

1. Print a few more pages to see if the problem corrects itself.
2. Make sure that the environmental specifications for the printer are being met. (See [Operating environment](#).)
3. The printer might be due for maintenance. Check this by printing a copy of the supplies status page. (See [Supplies status page](#).) If maintenance is due, order and install the printer maintenance kit. (See [Performing preventive maintenance](#).)

Page skew

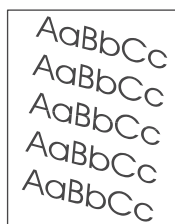

1. Print a few more pages to see if the problem corrects itself.
2. Verify that there are no torn pieces of paper inside the printer.

3. Make sure that paper is loaded correctly and that all adjustments have been made. (See [Loading trays](#).) Make sure that the guides in the tray are not too tight or too loose against the paper.
4. Turn over the stack of paper in the tray. Also, try rotating the paper 180°.
5. Make sure that the type and quality of the paper you are using meet HP specifications. (See [Paper specifications](#).)
6. Make sure that the environmental specifications for the printer are being met. (See [Operating environment](#).)

Curl or wave

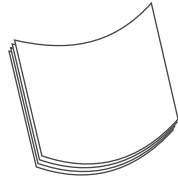

1. Turn over the stack of paper in the tray. Also, try rotating the paper 180°.
2. Make sure that the type and quality of the paper you are using meet HP specifications. (See [Paper specifications](#).)
3. Make sure that the environmental specifications for the printer are being met. (See [Operating environment](#).)
4. Try printing to a different output bin.
5. If paper is lightweight and smooth, open the Configure Device menu at the printer control panel. On the Print Quality submenu, select **FUSER MODES**, and then select the paper type you are using. Change the setting to **LOW**, which helps reduce the heat in the fusing process. (See [Print Quality submenu](#).) You must also set the type of paper for the tray you are using. (See [Printing by type and size of media \(locking trays\)](#).)

Wrinkles or creases

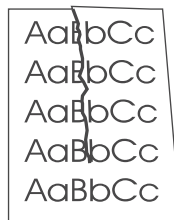

1. Print a few more pages to see if the problem corrects itself.
2. Make sure that the environmental specifications for the printer are being met. (See [Operating environment](#).)
3. Turn over the stack of paper in the tray. Also, try rotating the paper 180°.
4. Make sure that paper is loaded correctly and all adjustments have been made. (See [Loading trays](#).)
5. Make sure that the type and quality of the paper you are using meet HP specifications. (See [Paper specifications](#).)

6. If envelopes are creasing, try storing envelopes so that they lie flat.

Vertical white lines

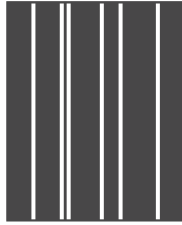

1. Print a few more pages to see if the problem corrects itself.
2. Make sure that the type and quality of the paper you are using meet HP specifications. (See [Paper specifications](#).)
3. Replace the print cartridge.

Tire tracks

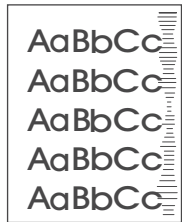

This defect typically occurs when the print cartridge has far exceeded its rated life of 10,000 (Q5942A) or 20,000 (Q5942X) pages. For example, if you are printing a very large quantity of pages with very little toner coverage.

1. Replace the print cartridge.
2. Reduce the number of pages that you print with very low toner coverage.

White spots on black

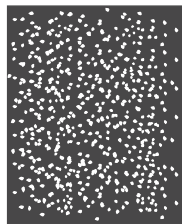

1. Print a few more pages to see if the problem corrects itself.
2. Make sure that the type and quality of the paper you are using meet HP specifications. (See [Paper specifications](#).)
3. Make sure that the environmental specifications for the printer are being met. (See [Operating environment](#).)
4. Replace the print cartridge.

Scattered lines



1. Make sure that the type and quality of the paper you are using meet HP specifications. (See [Paper specifications](#).)
2. Make sure that the environmental specifications for the printer are being met. (See [Operating environment](#).)
3. Turn over the stack of paper in the tray. Also, try rotating the paper 180°.
4. Open the Configure Device menu at the printer control panel. Open the Print Quality submenu and change the **TONER DENSITY** setting. (See [Print Quality submenu](#).)
5. Open the Configure Device menu at the printer control panel. On the Print Quality submenu, open **OPTIMIZE** and set **LINE DETAIL=ON**.

Blurred print

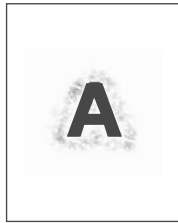

1. Make sure that the type and quality of the paper you are using meet HP specifications. (See [Paper specifications](#).)
2. Make sure that the environmental specifications for the printer are being met. (See [Operating environment](#).)
3. Turn over the stack of paper in the tray. Also, try rotating the paper 180°.
4. Do not use paper that already has been run through the printer.
5. Decrease the toner density. Open the Configure Device menu at the printer control panel. Open the Print Quality submenu and change the **TONER DENSITY** setting. (See [Print Quality submenu](#).)
6. Open the Configure Device menu at the printer control panel. On the Print Quality submenu, open **OPTIMIZE** and set **HIGH TRANSFER=ON**. (See [Print Quality submenu](#).)

Random image repetition



If an image that appears at the top of the page (in solid black) repeats further down the page (in a gray field), the toner might not have been completely erased from the last job. (The repeated image might be lighter or darker than the field it appears in.)

- Change the tone (darkness) of the field that the repeated image appears in.
- Change the order in which the images are printed. For example, have the lighter image at the top of the page, and the darker image farther down the page.
- From your software application, rotate the whole page 180° to print the lighter image first.
- If the defect occurs later in a print job, turn the printer power off for 10 minutes, and then turn the printer power on to restart the print job.

Troubleshooting network printing problems

NOTE

HP recommends that you use the printer CD-ROM to install and set up the printer on a network.

- Print a configuration page (see [Configuration page](#)). If an HP Jetdirect print server is installed, printing a configuration page also prints a second page that shows the network settings and status.
- See the **HP Jetdirect Print Server Administrator's Guide** on the printer CD-ROM for help and for more information about the Jetdirect configuration page. To reach the guide, select the appropriate print server series, select the appropriate print server product, and then click **troubleshoot a problem**.
- Try printing the job from another computer.
- To verify that a printer works with a computer, use a parallel or USB cable to connect it directly to a computer. You will have to reinstall the printing software. Print a document from a program that has printed correctly in the past. If this works, a problem with the network might exist.
- Contact your network administrator for assistance.

Troubleshooting common Windows problems

Error message:

"Error Writing to LPTx" in Windows 9x.

Cause	Solution
Media is not loaded.	Make sure that paper or other print media is loaded in the trays.
The cable is defective or loose.	Make sure that the cables are connected correctly, the printer is on, and the Ready light is on.
The printer is plugged into a power strip and is not receiving enough power.	Unplug the power cord from the power strip and plug it into another electrical outlet.
The input/output setting is incorrect.	Click Start , click Settings , and then click Printers . Right-click the HP LaserJet 4250 or 4350 series printer driver and select Properties . Click Details and then click Port Settings . Click to clear the check mark from the Check Port State before Printing box. Click OK . Click Spool Setting and then click Print Directly to Printer . Click OK .

Error message:

"General Protection FaultException OE"

"Spool32"

"Illegal Operation"

Cause	Solution
	<p>Close all software programs, restart Windows, and try again.</p> <p>Select a different printer driver. If the HP LaserJet 4250 or 4350 series PCL 6 driver is selected, switch to a PCL 5e or PS printer driver. You can usually do this from a software program.</p> <p>Delete all temp files from the Temp subdirectory. You can determine the name of the directory by editing the AUTOEXEC.BAT file and looking for the statement "Set Temp =". The name after this statement is the temp directory. It is usually C:\TEMP by default, but can be redefined.</p> <p>See the Microsoft Windows documentation that came with your computer for more information about Windows error messages.</p>

Troubleshooting common Macintosh problems

In addition to the problems that are listed in [Solving general printing problems](#), this section lists problems that can occur when using Mac OS 9.x, or Mac OS X.

NOTE

Setup for USB and IP printing is performed through the **Desktop Printer Utility**. The printer will **not** appear in the Chooser.

Problems with Mac OS 9.x

The printer name or IP address does not show or verify in the Desktop Printer Utility.

Cause	Solution
The printer might not be ready.	Make sure that the cables are connected correctly, the printer is on, and the ready light is on. If you are connecting through a USB or Ethernet hub, try connecting directly to the computer or use a different port.
The wrong connection type might be selected.	Make sure that Printer (USB) or Printer (LPR) is selected in the Desktop Printer Utility , depending on the type of connection that exists between the printer and the computer.
The wrong printer name or IP address is being used.	Check the printer name or IP address by printing a configuration page. See Configuration page . Verify that the printer name or IP address on the configuration page matches the printer name or IP address in the Desktop Printer Utility .
The interface cable might be defective or of poor quality.	Replace the interface cable. Make sure to use a high-quality cable.

The PostScript Printer Description (PPD) file for the printer does not appear as a selection in the Desktop Printer Utility.

Cause	Solution
The printer software might not have been installed or was installed incorrectly.	Make sure that the HP LaserJet 4250 or 4350 series PPD is in the following hard drive folder: <code>System Folder/Extensions/Printer Descriptions</code> . If necessary, reinstall the software. See the getting started guide for instructions.
The PostScript Printer Description (PPD) file is corrupt.	Delete the PPD file from the following hard drive folder: <code>System Folder/Extensions/Printer Descriptions</code> . Reinstall the software. See the getting started guide for instructions.

Problems with Mac OS 9.x (continued)

A print job was not sent to the printer that you wanted.

Cause	Solution
The print queue might be stopped.	Restart the print queue. Open the Printing menu in the top menu bar and click Start Print Queue .
The wrong printer name or IP address is being used. Another printer that has the same or a similar name or IP address might have received your print job.	Check the printer name or IP address by printing a configuration page. See Configuration page . Verify that the printer name or IP address on the configuration page matches the printer name or IP address in the Desktop Printer Utility .
The printer might not be ready.	Make sure that the cables are connected correctly, the printer is on, and the ready light is on. If you are connecting through a USB or Ethernet hub, try connecting directly to the computer or use a different port.
The interface cable might be defective or of poor quality.	Replace the interface cable. Make sure to use a high-quality cable.

You cannot use the computer while the printer is printing.

Cause	Solution
Background Printing has not been selected.	For LaserWriter 8.6 and later: Turn Background Printing on by selecting Print Desktop on the File menu and then clicking Background Printing .

An encapsulated PostScript (EPS) file does not print with the correct fonts.

Cause	Solution
This problem occurs with some programs.	<ul style="list-style-type: none">• Try downloading the fonts that are contained in the EPS file to the printer before printing.• Send the file in ASCII format instead of binary encoding.

Your document is not printing with New York, Geneva, or Monaco fonts.

Cause	Solution
The printer might be substituting fonts.	Click Options in the Page Setup dialog box to clear substituted fonts.

You are unable to print from a third-party USB card.

Cause	Solution
This error occurs when the software for USB printers is not installed.	When adding a third-party USB card, you might need the Apple USB Adapter Card Support software. The most current version of this software is available from the Apple Web site.

Problems with Mac OS 9.x (continued)

When connected with a USB cable, the printer does not appear in the Desktop Printer Utility or the Apple System Profiler after the driver is selected.

Cause	Solution
This problem is caused by either a software or hardware component.	<p>Software troubleshooting</p> <ul style="list-style-type: none">• Check that your Macintosh supports USB.• Verify that your Macintosh operating system is Mac OS 9.1 or later.• Ensure that your Macintosh has the appropriate USB software from Apple. <hr/> <p>NOTE</p> <p>The iMac and Blue G3 desktop Macintosh systems meet all of the requirements to connect to a USB device.</p> <hr/> <p>Hardware troubleshooting</p> <ul style="list-style-type: none">• Check that the printer is turned on.• Verify that the USB cable is connected correctly.• Check that you are using the appropriate high-speed USB cable.• Ensure that you do not have too many USB devices drawing power from the chain. Disconnect all of the devices from the chain and connect the cable directly to the USB port on the host computer.• Check to see if more than two nonpowered USB hubs are connected in a row on the chain. Disconnect all of the devices from the chain and connect the cable directly to the USB port on the host computer. <hr/> <p>NOTE</p> <p>The iMac keyboard is a nonpowered USB hub.</p>

Problems with Mac OS X

The printer driver is not listed in Print Center.

Cause	Solution
The printer software might not have been installed or was installed incorrectly.	Make sure that the HP LaserJet 4250 or 4350 series PPD is in the following hard drive folder: <code>Library/Printers/PPDs/Contents/Resources/<lang>.lproj</code> , where “<lang>” represents the two-letter language code for the language that you are using. If necessary, reinstall the software. See the getting started guide for instructions.
The Postscript Printer Description (PPD) file is corrupt.	Delete the PPD file from the following hard drive folder: <code>Library/Printers/PPDs/Contents/Resources/<lang>.lproj</code> , where “<lang>” represents the two-letter language code for the language that you are using. Reinstall the software. See the getting started guide for instructions.

Problems with Mac OS X (continued)

The printer name, IP address, or Rendezvous host name does not appear in the printer list box in the print center.

Cause	Solution
The printer might not be ready.	Make sure that the cables are connected correctly, the printer is on, and the ready light is on. If you are connecting through a USB or Ethernet hub, try connecting directly to the computer or use a different port.
The wrong connection type might be selected.	Make sure that USB, IP Printing, or Rendezvous is selected, depending on the type of connection that exists between the printer and the computer.
The wrong printer name, IP address, or Rendezvous host name is being used.	Check the printer name, IP address, or Rendezvous host name by printing a configuration page. See Configuration page . Verify that the name, IP address, or Rendezvous host name on the configuration page matches the printer name, IP address, or Rendezvous host name in the Print Center.
The interface cable might be defective or of poor quality.	Replace the interface cable. Make sure to use a high-quality cable.

The printer driver does not automatically set up your selected printer in Print Center.

Cause	Solution
The printer might not be ready.	Make sure that the cables are connected correctly, the printer is on, and the ready light is on. If you are connecting through a USB or Ethernet hub, try connecting directly to the computer or use a different port.
The printer software might not have been installed or was installed incorrectly.	Make sure that the HP LaserJet 4250 or 4350 series PPD is in the following hard drive folder: <code>Library/Printers/PPDs/Contents/Resources/<lang>.lproj</code> , where “<lang>” represents the two-letter language code for the language that you are using. If necessary, reinstall the software. See the getting started guide for instructions.
The Postscript Printer Description (PPD) file is corrupt.	Delete the PPD file from the following hard drive folder: <code>Library/Printers/PPDs/Contents/Resources/<lang>.lproj</code> , where “<lang>” represents the two-letter language code for the language that you are using. Reinstall the software. See the getting started guide for instructions.
The printer might not be ready.	Make sure that the cables are connected correctly, the printer is on, and the ready light is on. If you are connecting through a USB or Ethernet hub, try connecting directly to the computer or use a different port.
The interface cable might be defective or of poor quality.	Replace the interface cable. Make sure to use a high-quality cable.

A print job was not sent to the printer that you wanted.

Cause	Solution
The print queue might be stopped.	Restart the print queue. Open print monitor and select Start Jobs .

Problems with Mac OS X (continued)

A print job was not sent to the printer that you wanted.

Cause	Solution
The wrong printer name or IP address is being used. Another printer with the same or similar name, IP address, or Rendezvous host name might have received your print job.	Check the printer name, IP address, or Rendezvous host name by printing a configuration page. See Configuration page . Verify that the name, IP address, or Rendezvous host name on the configuration page matches the printer name, IP address, or Rendezvous host name in the Print Center.

An encapsulated PostScript (EPS) file does not print with the correct fonts.

Cause	Solution
This problem occurs with some programs.	<ul style="list-style-type: none">• Try downloading the fonts that are contained in the EPS file to the printer before printing.• Send the file in ASCII format instead of binary encoding.

You are unable to print from a third-party USB card.

Cause	Solution
This error occurs when the software for USB printers is not installed.	When adding a third-party USB card, you might need the Apple USB Adapter Card Support software. The most current version of this software is available from the Apple Web site.

Problems with Mac OS X (continued)

When connected with a USB cable, the printer does not appear in the Macintosh Print Center after the driver is selected.

Cause	Solution
This problem is caused by either a software or a hardware component.	<p>Software troubleshooting</p> <ul style="list-style-type: none">• Check that your Macintosh supports USB.• Verify that your Macintosh operating system is Mac OS X version 10.1 or later.• Ensure that your Macintosh has the appropriate USB software from Apple. <p>Hardware troubleshooting</p> <ul style="list-style-type: none">• Check that the printer is turned on.• Verify that the USB cable is connected correctly.• Check that you are using the appropriate high-speed USB cable.• Ensure that you do not have too many USB devices drawing power from the chain. Disconnect all of the devices from the chain, and connect the cable directly to the USB port on the host computer.• Check to see if more than two nonpowered USB hubs are connected in a row on the chain. Disconnect all of the devices from the chain and connect the cable directly to the USB port on the host computer. <hr/> <p>NOTE</p> <p>The iMac keyboard is a nonpowered USB hub.</p> <hr/>

Troubleshooting common PostScript problems

The following situations are specific to the PostScript (PS) language and might occur when several printer languages are being used. Check the control-panel display for messages that might help resolve problems.

NOTE

To receive a printed or screen message when PS errors occur, open the **Print Options** dialog box and click the selection next to the PS Errors section that you want.

General problems

The job prints in Courier (the printer's default typeface) instead of the typeface that you requested.

Cause	Solution
The requested typeface is not downloaded.	Download the font that you want and send the print job again. Verify the type and location of the font. Download the font to the printer if applicable. Check the software documentation for more information.

A legal page prints with clipped margins.

Cause	Solution
The print job was too complex.	You might need to print your job at 600 dots per inch, reduce the complexity of the page, or install more memory.

A PS error page prints.

Cause	Solution
The print job might not be PS.	Make sure that the print job is a PS job. Check to see whether the software application expected a setup or PS header file to be sent to the printer.

Specific errors

Limit Check Error

Cause	Solution
The print job was too complex.	You might need to print your job at 600 dots per inch (dpi), reduce the complexity of the page, or install more memory.

VM Error

Cause	Solution
A font error occurred.	Select unlimited downloadable fonts from the printer driver.

Range Check

Cause	Solution
A font error occurred.	Select unlimited downloadable fonts from the printer driver.

Troubleshooting the optional hard disk

Item	Explanation
The printer does not recognize the optional hard disk.	Turn the printer power off and verify that the hard disk is inserted correctly and is securely fastened. Print a configuration page to confirm that the optional hard disk has been recognized. See Configuration page .
You receive this message: DISK FAILURE. EIO X DISK NOT FUNCTIONAL	Turn the printer power off and make sure that the EIO disk is inserted correctly and securely fastened. If the printer control panel message continues to appear, the optional hard disk needs to be replaced.
You receive this message: Disk is Write Protected.	Fonts and forms cannot be stored on the optional hard disk when it is write protected. Use the Device Storage Manager in HP Web Jetadmin or the Macintosh-based HP LaserJet Utility to remove the write protection from the optional hard disk. Press ✓ (SELECT button) to open the printer control panel menus.
You attempted to use a disk-resident font, but the printer substituted a different font.	If you are using PCL, print the PCL Font Page, and verify that the font is on the optional hard disk. If you are using PS, print the PS Font Page and make sure that the font is on the optional hard disk. If the font is not on the optional hard disk, use Device Storage Manager in HP Web Jetadmin or the Macintosh-based HP LaserJet Utility to download the font. See PS or PCL font list .

A

Supplies and accessories

This section provides information about ordering parts, supplies, and accessories. Use only parts and accessories that are specifically designed for this printer.

- [Ordering parts, accessories, and supplies](#)
- [Part numbers](#)

Ordering parts, accessories, and supplies

Several methods are available for ordering parts, supplies, and accessories:

- [Ordering directly from HP](#)
- [Ordering through service or support providers](#)
- [Ordering directly through the embedded Web server \(for printers that are connected to a network\)](#)
- [Ordering directly through the HP Toolbox software \(for printers that are directly connected to a computer\)](#)

Ordering directly from HP

You can obtain the following directly from HP:

- **Replacement parts** To order replacement parts in the U.S. see <http://www.hp.com/go/hpparts/>. Outside the United States, order parts by contacting your local authorized HP service center.
- **Supplies and accessories** To order supplies in the U.S., see <http://www.hp.com/go/ljsupplies>. To order supplies worldwide, see <http://www.hp.com/ghp/buyonline.html>. To order accessories, see <http://www.hp.com/support/lj4250> or <http://www.hp.com/support/lj4350>.

Ordering through service or support providers

To order a part or accessory, contact an HP-authorized service or support provider. (See [HP customer care](#).)

Ordering directly through the embedded Web server (for printers that are connected to a network)

Use the following steps to order printing supplies directly through the embedded Web server. (See [Using the embedded Web server](#) for an explanation of this feature.)

To order directly through the embedded Web server

1. In the Web browser on the computer, type the IP address for the printer. The printer status window appears.
2. Select the **Setting** tab at the top of the window.
3. If asked to provide a password, type the password.
4. On the left side of the Device Configuration window, double-click **Order Supplies**. This provides a URL from which to purchase consumables. Supplies information with part numbers and printer information is provided.
5. Select the part numbers that you want to order and follow the instructions on the screen.

Ordering directly through the HP Toolbox software (for printers that are directly connected to a computer)

The HP Toolbox software gives you the ability to order supplies and accessories directly from the computer. To order supplies by using the HP Toolbox, click **Toolbox Links**, and then click **Order Supplies**. A link is provided to the HP Web site for ordering supplies.

Part numbers

The following list of accessories was current at the time of printing. Ordering information and availability of the accessories might change during the life of the printer.

Paper-handling accessories

Item	Description	Part number
Optional 500-sheet tray and feeder unit	Optional tray to increase paper capacity. Holds Letter, A4, Legal, A5, B5 (JIS), Executive, and 8.5 x 13 inch paper sizes. The printer can accommodate up to three optional 500-sheet feeders.	Q2440B
Optional 1,500-sheet tray and feeder unit	Optional tray to increase paper capacity. Holds Letter, Legal, and A4 paper sizes.	Q2444B
Envelope feeder	Holds up to 75 envelopes.	Q2438B
Duplexer (duplex printing accessory)	Allows automatic printing on both sides of the paper.	Q2439B
500-sheet stacker	Provides an additional output bin that holds 500 sheets.	Q2442B
500-sheet stapler/stacker	Allows for high-volume output with automatic job finishing. Staples up to 15 sheets of paper.	Q2443B
1,000-staple cartridge	Provides three staple cartridges.	Q3216A
Stapler unit	Holds the stapler cartridge and the stapler head. Order the stapler unit if you are experiencing stapler failure and an HP-authorized service or support provider advises you to replace the unit. NOTE The staple cartridge is not included with the stapler unit and must be ordered separately, when it needs to be replaced.	Q3216-60501
Storage cabinet	Raises the height of the printer and provides room to store paper.	Q2445B

Print cartridges

Item	Description	Part number
HP LaserJet print cartridge	10,000-page cartridge	Q5942A
	20,000-page cartridge	Q5942X

Maintenance kits

Item	Description	Part number
<p>Printer maintenance kit. Includes a replacement fuser, a transfer roller, a transfer-roller tool, a pickup roller, eight feed rollers, and one pair of disposable gloves. Includes instructions for installing each component.</p> <p>The printer maintenance kit is a consumable item, and its cost is not covered under the warranty or most extended warranty options.</p>	110-volt printer maintenance kit	Q5421A
	220-volt printer maintenance kit	Q5422A

Memory

Item	Description	Part number
100-pin DDR memory DIMM (dual inline memory module) Boosts the ability of the printer to handle large or complex print jobs.	48 MB	Q6007A
	64 MB	Q2625A
	128 MB	Q2626A
	256 MB	Q2627A
EIO hard disk	20-GB permanent storage for fonts and forms. Also used for making multiple original prints and for job-storage features.	J6073A

Cables and interfaces

Item	Description	Part number
Enhanced I/O (EIO) cards HP Jetdirect print server multi-protocol EIO network cards:	HP Jetdirect 620n Fast Ethernet (10/100Base-TX) print server	J7934A
	HP Jetdirect 680n 802.11b wireless internal print server	J6058A
	HP Jetdirect Connectivity card for USB, serial, and LocalTalk connections	J4135A
Parallel cables	2-meter IEEE 1284-B cable	C2950A
	3-meter IEEE 1284-B cable	C2951A
USB cable	2-meter A to B cable	C6518A

Print media

For more information about media supplies, go to <http://www.hp.com/go/ljsupplies>.

Item	Description	Part number
HP Soft Gloss laser paper For use with HP LaserJet printers. Coated paper, good for business documents with high impact, such as brochures, sales material, and documents with graphics and photographic images. Specifications: 32 lb (120 g/m ²).	Letter (220 x 280 mm), 50 sheets/box	C4179A/Asia-Pacific countries/regions
	A4 (210 x 297 mm), 50 sheets/box	C4179B/Asia-Pacific countries/regions and Europe
HP LaserJet tough paper For use with HP LaserJet printers. This satin-finish paper is waterproof and tear-proof, yet doesn't compromise on print quality or performance. Use it for signs, maps, menus, and other business applications.	Letter (8.5 x 11 inch), 50 sheets to a carton	Q1298A/North America
	A4 (210 x 297 mm), 50 sheets to a carton	Q1298B/Asia-Pacific countries/regions and Europe

Item	Description	Part number
<p>HP Premium Choice LaserJet paper</p> <p>HP's brightest LaserJet paper. Expect spectacular color and crisp black from this paper that is extra smooth and brilliantly white. Ideal for presentations, business plans, external correspondence and other high-value documents</p> <p>Specifications: 98 bright, 32 lb. (75 g/m²).</p>	Letter (8.5 x 11 inch), 500 sheets/ream, 10-ream carton	HPU1132/North America
	Letter (8.5 x 11 inch), 250 sheets/ream, 6-ream carton	HPU1732 North America
	A4 (210 x 297 mm), 5-ream carton	Q2397A/Asia-Pacific countries/regions
	A4 (210 x 297 mm), 250 sheet/ream, 5-ream carton	CHP412/Europe
	A4 (210 x 297 mm), 500 sheet/ream, 5-ream carton	CHP410/Europe
	A4 (210 x 297 mm), 160 g/m ² , 500 sheet/ream, 5-ream carton	CHP413/Europe
<p>HP LaserJet paper</p> <p>For use with HP LaserJet printers. Good for letterhead, high-value memos, legal documents, direct mail, and correspondence.</p> <p>Specifications: 96 bright, 24 lb (90 g/m²).</p>	Letter (8.5 x 11 inch), 500 sheets/ream, 10-ream carton	HPJ1124/North America
	Legal (8.5 x 14 inch), 500 sheets/ream, 10-ream carton	HPJ1424/North America
	A Letter (220 x 280 mm), 500 sheets/ream, 5-ream carton	Q2398A/Asia-Pacific countries/regions
	A4 (210 x 297 mm), 500 sheets/ream, 5-ream carton	Q2400A/Asia-Pacific countries/regions
	A4 (210 x 297 mm), 500 sheets/ream	CHP310/Europe
<p>HP Printing paper</p> <p>For use with HP LaserJet and inkjet printers. Created especially for small and home offices. Heavier and brighter than copier paper.</p> <p>Specifications: 92 bright, 22 lb.</p>	Letter (8.5 x 11 inch), 500 sheets/ream, 10-ream carton	HPP1122/North America and Mexico
	Letter (8.5 x 11 inch), 500 sheets/ream, 3-ream carton	HPP113R/North America
	A4 (210 x 297 mm), 500 sheets/ream, 5-ream carton	CHP210/Europe
	A4 (210 x 297 mm), 300 sheets/ream, 5-ream carton	CHP213/Europe

Item	Description	Part number
<p>HP Multipurpose paper</p> <p>For use with all office equipment-laser and inkjet printers, copiers, and fax machines. Created for businesses that want one paper for all their office needs. Brighter and smoother than other office papers.</p> <p>Specifications: 90 bright, 20 lb (75 g/m²).</p>	<p>Letter (8.5 x 11 inch), 500 sheets/ream, 10-ream carton</p> <p>Letter (8.5 x 11 inch), 500 sheets/ream, 5-ream carton</p> <p>Letter (8.5 x 11 inch), 250 sheets/ream, 12-ream carton</p> <p>Letter (8.5 x 11 inch), 3-hole, 500 sheets/ream, 10-ream carton</p> <p>Legal (8.5 x 14 inch), 500 sheets/ream, 10-ream carton</p>	<p>HPM1120/North America</p> <p>HPM115R/North America</p> <p>HP25011/North America</p> <p>HPM113H/North America</p> <p>HPM1420/North America</p>
<p>HP Office paper</p> <p>For use with all office equipment-laser and inkjet printers, copiers, and fax machines. Good for high-volume printing.</p> <p>Specifications: 84 bright, 20 lb (75 g/m²).</p>	<p>Letter (8.5 x 11 inch), 500 sheets/ream, 10-ream carton</p> <p>Letter (8.5 x 11 inch), 3-hole, 500 sheets/ream, 10-ream carton</p> <p>Legal (8.5 x 14 inch), 500 sheets/ream, 10-ream carton</p> <p>Letter (8.5 x 11 inch), Quick Pack; 2,500-sheet carton</p> <p>Letter (8.5 x 11 inch), Quick Pack 3-hole; 2,500-sheet carton</p> <p>A Letter (220 x 280 mm), 500 sheets/ream, 5-ream carton</p> <p>A4 (210 x 297 mm), 500 sheets/ream, 5-ream carton</p> <p>A4 (210 x 297 mm), 500 sheets/ream, 5-ream carton</p> <p>A4 (210 x 297 mm), Quick Pack; 2500 sheets/ream, 5-ream carton</p>	<p>HPC8511/North America and Mexico</p> <p>HPC3HP/North America</p> <p>HPC8514/North America</p> <p>HP2500S/North America and Mexico</p> <p>HP2500P/North America</p> <p>Q2408A/Asia-Pacific countries/regions</p> <p>Q2407A/Asia-Pacific countries/regions</p> <p>CHP110/Europe</p> <p>CHP113/Europe</p>

Item	Description	Part number
<p>HP Office recycled paper</p> <p>For use with all office equipment-laser and inkjet printers, copiers, and fax machines. Good for high-volume printing.</p> <p>Satisfies U.S. Executive Order 13101 for environmentally preferable products.</p> <p>Specifications: 84 bright, 20 lb, 30% post-consumer content.</p>	Letter (8.5 x 11 inch), 500 sheets/ream, 10-ream carton	HPE1120/North America
	Letter (8.5 x 11 inch), 3-hole, 500 sheets/ream, 10-ream carton	HPE113H/North America
	Legal (8.5 x 14 inch), 500 sheets/ream, 10-ream carton	HPE1420/North America
<p>HP LaserJet transparencies</p> <p>For use only with HP LaserJet monochrome printers. For crisp, sharp text and graphics, rely on the only transparencies specifically designed and tested to work with monochrome HP LaserJet printers.</p> <p>Specifications: 4.3-mil thickness.</p>	Letter (8.5 x 11 inch), 50 sheets to a carton	92296T/North America, Asia-Pacific countries/regions, and Europe
	A4 (210 x 297 mm), 50 sheets to a carton	922296U/Asia-Pacific countries/regions and Europe

B

Control panel menus

You can perform most routine printing tasks from the computer by using the program or printer driver. These two methods are the most convenient way to control the printer, and they will override the printer-control-panel settings. See the Help file for your program, or, for more information about gaining access to the printer driver, see [Using the printer driver](#).

You can also control the printer by changing settings at the printer control panel. Use the control panel to gain access to printer features that are not supported by the program or printer driver.

You can print a menu map at the printer control panel that shows the settings with the currently selected values (see [Menu map](#)). The sections that follow list the settings and possible values. In the Values column, the default value for each setting is the one with an asterisk (*) next to it.

Some menus or menu items appear only if certain options are installed in the printer.

This section explains the following menus:

- [Retrieve Job menu](#)
- [Information menu](#)
- [Paper Handling menu](#)
- [Configure Device menu](#)
- [Diagnostics menu](#)
- [Service menu](#)

Retrieve Job menu

This menu provides a list of the stored jobs in the printer and access to all the job storage features. You can print or delete these jobs at the printer control panel. See [Using job-storage features](#) for more information about using this menu.

NOTE

If you turn the printer power off, all stored jobs are deleted unless an optional hard disk is installed.

The section that follows lists the settings and possible values. In the Values column, the default value for each setting is the one with an asterisk (*) next to it.

Item	Values	Explanation
PRINT STORED JOB LIST	There is no value to select.	Prints a page showing all jobs stored on the device.

Item	Values	Explanation
[USERNAME]	[JOBNAME] ALL PRIVATE JOBS NO STORED JOBS	<p>The name of the person who sent the job.</p> <p>[JOBNAME]: The name of the job stored in the printer. Select one of your jobs or all of your private jobs (those that were assigned a PIN in the printer driver).</p> <ul style="list-style-type: none"> • Print: Prints the selected job. PIN REQUIRED TO PRINT: A prompt that appears for jobs that were assigned a personal identification number (PIN) in the printer driver. You must enter the PIN to print the job. COPIES: You can select the number of copies that you want to print (1 to 32000). • Delete: Deletes the selected job from the printer. PIN REQUIRED TO DELETE: A prompt that appears for jobs that were assigned a PIN in the printer driver. You must enter the PIN to delete the job. <p>ALL PRIVATE JOBS: Appears if two or more private jobs are stored in the printer. Selecting this item prints all of the private jobs that are stored in the printer for that user, after the correct PIN is entered.</p> <p>NO STORED JOBS: Indicates that no stored jobs are available to print or delete.</p>

Information menu

The Information menu contains printer information pages that give details about the printer and its configuration. Scroll to the information page that you want, and then press ✓ (**SELECT** button).

Item	Explanation
PRINT MENU MAP	The menu map shows the layout and current settings of the printer control panel menu items. For more information, see Menu map .
PRINT CONFIGURATION	The configuration page shows the current printer configuration. If an HP Jetdirect print server is installed, an HP Jetdirect configuration page will print out as well. For more information, see Configuration page .
PRINT SUPPLIES STATUS PAGE	The supplies status page shows the levels of the supplies for the printer, calculation of the number of pages remaining, and cartridge-usage information. This page is available only if you are using genuine HP supplies. For more information, see Supplies status page .
PRINT USAGE	<p>The usage page shows the quantity of pages printed, as well as the paper source used. It also shows the number of one-sided versus two-sided pages that have been printed.</p> <hr/> <p>NOTE</p> <p>This item appears only if a mass-storage device that contains a recognized file system is installed in the printer, such as an optional CompactFlash card. This item generates a page containing information that can be used for accounting purposes.</p> <hr/>
PRINT FILE DIRECTORY	This item appears only if a mass-storage device that contains a recognized file system is installed in the printer, such as an optional CompactFlash card. The file directory shows information for all installed mass-storage devices. For more information, see Printer memory .
PRINT PCL FONT LIST	The PCL font list shows all the PCL fonts that are currently available to the printer. For more information, see PS or PCL font list .
PRINT PS FONT LIST	The PS font list shows all the PS fonts that are currently available to the printer. For more information, see PS or PCL font list .

Paper Handling menu

If paper-handling settings are correctly configured at the printer control panel, you can print by selecting the type and size of media in the program or the printer driver. For more information about configuring for media types and sizes, see [Printing by type and size of media \(locking trays\)](#). For more information about supported media types and sizes, see [Supported sizes of print media](#) and [Paper specifications](#).

Some items on this menu (such as duplex and manual feed) are available in the program or the printer driver (if the appropriate driver is installed). Program and printer driver settings override control-panel settings. For more information, see [Using the printer driver](#).

The section that follows lists the settings and possible values. In the Values column, the default value for each setting is the one that has an asterisk (*) next to it.

Item	Values	Explanation
ENVELOPE FEEDER SIZE	*COM10 MONARCH C5 ENVELOPE DL ENVELOPE B5 ENVELOPE	This item appears only if the optional envelope feeder is installed. Set the value to correspond with the envelope size that is currently loaded in the optional envelope feeder.
ENVELOPE FEEDER TYPE	*ANY TYPE PLAIN PREPRINTED LETTERHEAD PREPUNCHED LABELS BOND RECYCLED COLOR CARDSTOCK >164 G/M2 ROUGH	This item appears only if the optional envelope feeder is installed. Set the value to correspond with the envelope type that is currently loaded in the optional envelope feeder.

Item	Values	Explanation
TRAY 1 SIZE	*ANY SIZE LETTER LEGAL EXECUTIVE A4 A5 STATEMENT 8.5 x 13 B5 (JIS) EXECUTIVE (JIS) D POSTCARD (JIS) 16K ENVELOPE 10 ENVELOPE MONARCH ENVELOPE C5 ENVELOPE DL ENVELOPE B5 CUSTOM	<p>Use this item to set the value to correspond with the media size that is currently loaded in tray 1.</p> <p>ANY: If both the type and size for tray 1 are set to ANY, the printer will pull media from tray 1 first if media is loaded in the tray.</p> <p>A size other than ANY: The printer does not pull from this tray unless the type or size of the print job matches the type or size that is loaded in this tray.</p> <p>For more information, see Customizing tray 1 operation.</p>
TRAY 1 TYPE	*ANY PLAIN PREPRINTED LETTERHEAD TRANSPARENCY PREPUNCHED LABELS BOND RECYCLED COLOR LIGHT 60-75 G/M2 CARDSTOCK 164-200 G/M2 ROUGH ENVELOPE	<p>Use this item to set the value to correspond with the type of media that is currently loaded in tray 1.</p> <p>ANY: If both the type and size for tray 1 are set to ANY, the printer will pull media from tray 1 first if media is loaded in the tray.</p> <p>A type other than ANY: The printer does not pull from this tray unless the type or size of the print job matches the type or size that is loaded in this tray.</p>

Item	Values	Explanation
TRAY 2 SIZE	*LETTER LEGAL A4 EXECUTIVE A5 B5 (ISO) CUSTOM	Set the value to correspond with the media size that is currently loaded in tray 2.
TRAY 2 TYPE	ANY *PLAIN PREPRINTED LETTERHEAD TRANSPARENCY PREPUNCHED LABELS BOND RECYCLED COLOR CARDSTOCK > 64 g/m2 ROUGH	Use this item to set the value to correspond with the type of media that is currently loaded in tray 2.
TRAY [N] TYPE	ANY *PLAIN PREPRINTED LETTERHEAD TRANSPARENCY PREPUNCHED LABELS BOND RECYCLED COLOR CARDSTOCK > 64 g/m2 ROUGH	Use this item to set the value to correspond with the type of media currently that is loaded in the specified tray, where [N] is the number of the tray. This item appears only if an optional tray is installed.

Item	Values	Explanation
TRAY [N] SIZE	*LETTER LEGAL A4	<p>Use this item to set the value to correspond with the media size that is currently loaded in the specified tray, where [N] is the number of the tray.</p> <p>This item appears only if an optional tray is installed. The available sizes might vary depending upon the optional feeder device that is installed.</p>
Tray [N] Custom	UNIT OF MEASURE X DIMENSION Y DIMENSION	<p>This item appears only if a tray is set to a custom size.</p> <p>UNIT OF MEASURE: Use this option to select the unit of measure to use when you set custom paper sizes for the specified tray.</p> <p>X DIMENSION: Use this item to set the measurement of the width of the paper (measurement from side to side in the tray). The options are 3.0 to 8.50 INCHES or 76 to 216 MM.</p> <p>Y DIMENSION: Sets the measurement of the length of the paper (measurement from front to back in the tray). The options are 5.0 to 14.00 INCHES or 127 to 356 MM.</p> <p>After the Y DIMENSION value is selected, a summary screen appears. This screen contains feedback that summarizes all the information that was specified on the previous three screens, such as TRAY 1 SIZE= 8.50 x 14 INCHES, Setting saved.</p>

Configure Device menu

This menu contains administrative functions.

[Printing submenu](#)

[Print Quality submenu](#)

[System Setup submenu](#)

[Stapler/stacker submenu](#)

[I/O submenu](#)

[Resets submenu](#)

Printing submenu

Some items on this menu are available in the program or printer driver (if the appropriate driver is installed). Program and printer driver settings override control-panel settings. In general, it is better to change these settings in the printer driver, if applicable.

The section that follows lists the settings and possible values. In the Values column, the default value for each setting is the one with an asterisk (*) next to it.

Item	Values	Explanation
COPIES	*1 to 32000	<p>Sets the default number of copies by selecting any number from 1 to 32000. Use ▲ (UP button) or ▼ (DOWN button) to select the number of copies, or use the numeric keypad, if available, to specify the number of copies.</p> <p>Use ✓ (SELECT button) after specifying the number of copies. The Setting saved message appears.</p> <p>This setting applies only to print jobs that do not have the number of copies specified in the program or printer driver, such as an MS-DOS, UNIX, or Linux application.</p> <hr/> <p>NOTE</p> <p>It is best to set the number of copies in the program or printer driver. (Program and printer driver settings override control-panel settings.)</p> <hr/>

Item	Values	Explanation
DEFAULT PAPER SIZE	* LETTER LEGAL EXECUTIVE STATEMENT 8.5 x 13 A4 A5 B5 (JIS) EXECUTIVE (JIS) DPOSTCARD (JIS) 16K ENVELOPE 10 ENVELOPE MONARCH ENVELOPE C5 ENVELOPE DL ENVELOPE B5 CUSTOM	Sets the default image size for paper and envelopes. (The item name changes from paper to envelope as you scroll through the available sizes.) This setting applies only to print jobs that do not have the paper size specified in the program or printer driver.
DEFAULT CUSTOM PAPER SIZE	UNIT OF MEASURE X DIMENSION Y DIMENSION	Sets a default custom paper size for tray 1 or any 500-sheet tray. This menu appears only if the Custom-Standard switch in the selected tray is set to Custom.
PAPER DESTINATION	* STANDARD TOP BIN REAR BIN STACKER BIN	Configures the output bin destination. Only the optional bins that are installed appear on the menu.
DUPLEX	* OFF ON	Appears only if an optional duplex-printing accessory is installed. Select ON to print on both sides (duplex) or OFF to print on one side (simplex) of a sheet of paper.
DUPLEX BINDING	* LONG EDGE SHORT EDGE	Changes the binding edge for duplex printing. The menu item appears if an optional duplex-printing accessory is installed in the printer and DUPLEX=ON .
OVERRIDE A4/LETTER	NO * YES	Allows the printer to print an A4-size job on letter-size paper if A4-size paper is not loaded in the printer (or vice versa).
MANUAL FEED	* OFF ON	Feeds the paper manually from tray 1, rather than automatically from a tray. If MANUAL FEED=ON and tray 1 is empty, the printer goes offline when it receives a print job. MANUALLY FEED [PAPER SIZE] appears on the printer control-panel display.

Item	Values	Explanation
EDGE-TO-EDGE OVERRIDE	*NO YES	Turns the edge-to-edge mode on or off for all print jobs.
COURIER FONT	*REGULAR DARK	Selects the version of Courier font to use: REGULAR: The internal Courier font available on the HP LaserJet 4 series printers. DARK: The internal Courier font that is available on the HP LaserJet III series printers.
WIDE A4	*NO YES	Changes the number of characters that can be printed on a single line of A4-size paper. NO: Up to 78 10-pitch characters can be printed on one line. YES: Up to 80 10-pitch characters can be printed on one line.
PRINT PS ERRORS	*OFF ON	Determines whether a PS error page prints or not. OFF: PS error page never prints. ON: PS error page prints when PS errors occur.
PRINT PDF ERRORS	*OFF ON	Determines whether a PDF error page prints or not. OFF: PDF error page never prints. ON: PDF error page prints when PDF errors occur.

Item	Values	Explanation
PCL	FORM LENGTH ORIENTATION FONT SOURCE FONT NUMBER FONT PITCH FONT POINT SIZE SYMBOL SET APPEND CR TO LF SUPPRESS BLANK PAGES	<p>FORM LENGTH: Sets vertical spacing from 5 to 128 lines for default paper size.</p> <p>ORIENTATION: Allows you to select default page orientation to portrait or landscape.</p> <p>FONT SOURCE: Allows you to select the font source as *Internal, CARD SLOT 1, 2, or 3, Internal disk, or EIO disk.</p> <p>FONT NUMBER: The printer assigns a number to each font and lists the numbers on the PCL Font List. The range is 0 to 999.</p> <p>FONT PITCH: Selects the font pitch. This item might not appear, depending on the font selected. The range is 0.44 to 99.99.</p> <p>FONT POINT SIZE: Selects the font point size. This appears only if a font with a scalable point size is selected as the default font. The range is 4.00 to 999.75.</p> <p>SYMBOL SET: Selects any one of several available symbol sets at the printer control panel. A symbol set is a unique grouping of all the characters in a font. PC-8 or PC-850 is recommended for line-draw characters.</p> <p>APPEND CR TO LF: Select YES to append a carriage return to each line feed encountered in backward-compatible PCL jobs (pure text, no job control). Some environments, such as UNIX, indicate a new line using only the line feed control code. This option allows you to append the required carriage return to each line feed.</p> <p>SUPPRESS BLANK PAGES: When generating your own PCL, extra form feeds are included that would cause a blank page(s) to be printed. Select YES for form feeds to be ignored if the page is blank.</p>

Print Quality submenu

Some items on this menu are available in the program or printer driver (if the appropriate driver is installed). Program and printer driver settings override control-panel settings. For more information, see [Using the printer driver](#). In general, it is best to change these settings in the printer driver, if applicable.

The section that follows lists the settings and possible values. In the Values column, the default value for each setting is the one with an asterisk (*) next to it.

Item	Values	Explanation
SET REGISTRATION	PRINT TEST PAGE SOURCE ADJUST TRAY [N]	<p>Shifts the margin alignment to center the image on the page from top to bottom, and left to right. You can also align the image that is printed on the front with the image that is printed on the back.</p> <p>PRINT TEST PAGE: Prints a test page that shows the current registration settings.</p> <p>SOURCE: allows you to select the tray for which you want to print the test page. If installed, optional trays appear as selections, where [N] is the number of the tray.</p> <p>ADJUST TRAY N: sets the registration for the specified tray, where [N] is the number of the tray. A selection appears for each tray that is installed, and registration must be set for each tray.</p> <ul style="list-style-type: none"> ● X1 SHIFT: Registration of the image on the paper from side to side, as the paper lies in the tray. For duplexing, this side is the second side (back) of the paper. ● X2 SHIFT: Registration of the image on the paper from side to side, as the paper lies in the tray, for the first side (front) of a duplexed page. This item appears only if an optional duplexer is installed and enabled. Set the X1 SHIFT first. ● Y SHIFT: Registration of the image on the paper from top to bottom as the paper lies in the tray.

Item	Values	Explanation
FUSER MODES	PLAIN PREPRINTED LETTERHEAD TRANSPARENCY PREPUNCHED LABELS BOND RECYCLED COLOR LIGHT 60-75 G/M2 CARDSTOCK ROUGH ENVELOPE	<p>Configures the fuser mode associated with each paper type.</p> <p>Change the fuser mode only if you are experiencing problems printing on certain media types. After you select a type of media, you can select a fuser mode that is available for that type. The printer supports the following modes:</p> <p>NORMAL: Used for most types of paper.</p> <p>HIGH 1: Used for rough paper.</p> <p>HIGH 2: Used for paper that has a special or rough finish.</p> <p>LOW 1: Used for lightweight media. Use this mode if you are having problems with curled paper.</p> <p>LOW 2: Used for transparencies.</p> <hr/> <p>CAUTION</p> <p>Do not change the fuser mode for transparencies. Failure to use the LOW 2 setting while printing transparencies can result in permanent damage to the printer and fuser. Always select Transparencies as the Type in the printer driver and set the tray type at the printer control panel to TRANSPARENCY.</p> <hr/> <p>When selected, RESTORE MODES resets the fuser mode for each media type back to its default setting.</p>
OPTIMIZE	HIGH TRANSFER LINE DETAIL RESTORE OPTIMIZE	<p>HIGH TRANSFER: Set to ON if you are using highly resistive, lower-quality papers. HP recommends using only HP paper and print media.</p> <p>LINE DETAIL: Set to ON to improve the appearance of lines if scattered lines are appearing.</p> <p>RESTORE OPTIMIZE: Returns to the defaults for the Optimize settings.</p>

Item	Values	Explanation
RESOLUTION	300 600 *FASTRES 1200 PRORES 1200	<p>Selects the resolution. All values print at the same speed.</p> <p>300: Produces draft print quality and can be used for compatibility with the HP LaserJet III family of printers.</p> <p>600: Produces high print quality for text and can be used for compatibility with the HP LaserJet 4 family of printers.</p> <p>FASTRES 1200: Produces 1200-dpi print quality for fast, high-quality printing of business text and graphics.</p> <p>PRORES 1200: Produces 1200-dpi printing for the best quality in line art and graphic images.</p> <hr/> <p>NOTE</p> <p>It is best to change the resolution in the program or printer driver. (Program and printer driver settings override control-panel settings.)</p>
RET	OFF LIGHT *MEDIUM DARK	<p>Use the Resolution Enhancement technology (REt) setting to produce print with smooth angles, curves, and edges.</p> <p>REt does not affect print quality if the print resolution is set to FastRes 1200. All other print resolutions benefit from REt.</p> <hr/> <p>NOTE</p> <p>It is best to change the REt setting in the program or printer driver. (Program and printer driver settings override control-panel settings.)</p>
ECONOMODE	*OFF ON	<p>Turn EconoMode ON (to save toner) or OFF (for high quality).</p> <p>EconoMode creates draft-quality printing by reducing the amount of toner on the printed page.</p> <hr/> <p>NOTE</p> <p>It is best to turn EconoMode on or off in the program or printer driver. (Program and printer driver settings override control-panel settings.)</p> <hr/> <p>CAUTION</p> <p>HP does not recommend full-time use of EconoMode. If EconoMode is used full-time, it is possible that the toner supply will outlast the mechanical parts in the print cartridge.</p>

Item	Values	Explanation
TONER DENSITY	1 to 5 (*3)	<p>Lighten or darken the print on the page by setting the toner density. Select a setting ranging from 1 (light) to 5 (dark). The default setting of 3 usually produces the best results.</p> <hr/> <p>NOTE</p> <p>It is best to change the toner density in the program or printer driver. (Program and printer driver settings override control-panel settings.)</p>
SMALL PAPER MODE	*NORMAL SLOW	Select SLOW to prevent jams when printing on narrow media, as the part of the fuser rollers that do not make contact with the media swell up, which can cause wrinkles.
AUTO CLEANING	*OFF ON	Clean the fuser automatically by using this feature. This setting is unavailable if an optional duplexer is installed. If a duplexer is installed, run the cleaning page manually. See CREATE CLEANING PAGE below and Cleaning the fuser .
CLEANING INTERVAL	1000* 2000 5000 10000 20000	If auto cleaning is on, set how often it runs. The intervals correspond to the number of pages that the printer has printed. This setting is unavailable if an optional duplexer is installed.
AUTO CLEANING SIZE	*LETTER A4	If auto cleaning is on, set the size of paper that the printer should use when it is cleaning the printer automatically. This setting is unavailable if an optional duplexer is installed.
CREATE CLEANING PAGE	There is no value to select.	Press  (SELECT button) to print a cleaning page manually (for cleaning toner from the fuser). Open the rear output bin. Follow the instructions on the cleaning page. For more information, see Cleaning the fuser .
PROCESS CLEANING PAGE	There is no value to select.	This item is available only after a cleaning page has been created. Follow the instructions that are printed on the cleaning page. The cleaning process might take up to 2.5 minutes.

System Setup submenu

Items on this menu affect printer behavior. Configure the printer according to your printing needs.

The section that follows lists the settings and possible values. In the Values column, the default value for each setting is the one with an asterisk (*) next to it.

Item	Values	Explanation
DATE/TIME	DATE DATE FORMAT TIME TIME FORMAT	Sets the date and time settings.
JOB STORAGE LIMIT	1 to 100 (*32)	Specifies the number of quick copy jobs that can be stored on the printer. This item appears only if an optional hard-disk accessory is installed.
JOB HELD TIMEOUT	*OFF 1 HOUR 4 HOURS 1 DAY 1 WEEK	Sets the amount of time that held jobs are kept before being automatically deleted from the queue.
SHOW ADDRESS	AUTO *OFF	Defines whether or not the printer address will be shown on the display with the Ready message if the device is connected to a network.

Item	Values	Explanation
TRAY BEHAVIOR	USE REQUESTED TRAY MANUAL FEED PROMPT PS DEFER MEDIA SIZE/TYPE PROMPT	<p>Determines how the printer responds to jobs that request certain trays.</p> <p>USE REQUESTED TRAY: Determines whether the printer tries to pull paper from a different tray than the one that you selected in the printer driver.</p> <ul style="list-style-type: none"> ● EXCLUSIVELY: Sets the printer to pull paper only from the tray that you selected and not pull from another tray, even if the tray that you selected is empty. ● FIRST: Sets the printer to pull from the tray that you selected first, but allows the printer to pull from another tray automatically if the tray that you selected is empty. <p>MANUAL FEED PROMPT: Determines when the printer shows a prompt regarding pulling from tray 1 if your print job does not match the type or size that is loaded in any other tray.</p> <ul style="list-style-type: none"> ● ALWAYS: Select this option if you always want to be prompted before the printer pulls from tray 1. ● UNLESS LOADED: Prompts you only if tray 1 is empty. <p>PS DEFER MEDIA: Controls whether the PostScript (PS) or HP paper handling model is used to print jobs. ENABLED causes PS to defer to the HP paper handling model. DISABLED uses the PS paper handling model.</p> <p>SIZE/TYPE PROMPT: Use this menu item to control whether the tray configuration message and its prompts are shown whenever a tray is opened and closed. These prompts instruct you to set the type or size if the tray is configured for a type or size other than the type or size that is loaded in the tray.</p>
SLEEP DELAY	15 MINUTES *30 MINUTES 60 MINUTES 90 MINUTES 2 HOURS 4 HOURS	<p>Sets how long the printer remains idle before it enters Sleep mode.</p> <p>Sleep mode offers the following advantages:</p> <ul style="list-style-type: none"> ● Minimizes the amount of power consumed by the printer when it is idle ● Reduces wear on electronic components in the printer (turns off the display backlight, but the display is still readable) <p>The printer automatically comes out of Sleep mode when you send a print job, press a printer control panel button, open a tray, or open the top cover.</p> <p>To turn sleep mode on and off, see Sleep Mode in the Resets submenu.</p>

Item	Values	Explanation
DISPLAY	1 to 10 (*5)	Controls the brightness of the control-panel display.
PERSONALITY	*AUTO PDF PS PCL	<p>Selects the default printer language (personality). The possible values are determined by which valid languages are installed in the printer.</p> <p>Normally, you should not change the printer language. If you change it to a specific printer language, the printer will not switch automatically from one language to another unless specific software commands are sent to the printer.</p>
CLEARABLE WARNINGS	*JOB ON	<p>Sets the amount of time that a clearable warning appears on the printer control-panel display.</p> <p>JOB: The clearable warning message appears until the end of the job that generated the message.</p> <p>ON: The clearable warning message appears until you press <input type="checkbox"/> (SELECT).</p>
AUTO CONTINUE	OFF *ON	<p>Determines how the printer reacts to errors. If the printer is on a network, you probably want to turn AUTO CONTINUE to ON.</p> <p>ON: If an error occurs that prevents printing, the message appears on the printer control-panel display, and the printer goes offline for 10 seconds before returning online.</p> <p>OFF: If an error occurs that prevents printing, the message remains on the printer control-panel display, and the printer remains offline until you press <input type="checkbox"/> (SELECT).</p>
CARTRIDGE LOW	STOP *CONTINUE	<p>Determines how the printer behaves if the print cartridge is low. For the HP LaserJet 4250 series, the message first appears when about 15% (10,000-page cartridge) or about 8% (20,000-page cartridge) of the life remains in the print cartridge. For the HP LaserJet 4350 series, the message first appears when about 25% (10,000-page cartridge) or about 15% (20,000-page cartridge) of the life remains in the print cartridge. Print quality is not guaranteed if you print after receiving this message.</p> <p>STOP: The printer pauses printing until you replace the print cartridge or press <input type="checkbox"/> (SELECT button) each time you turn the printer on. The message appears until you replace the print cartridge.</p> <p>CONTINUE: The printer continues to print, and the message appears until you replace the print cartridge.</p> <p>For more information, see Managing the print cartridge.</p>

Item	Values	Explanation
CARTRIDGE OUT	STOP *CONTINUE	<p>Determines how the printer reacts if the print cartridge is empty.</p> <p>STOP: The printer stops printing until you replace the print cartridge.</p> <p>CONTINUE: The printer continues to print, and the REPLACE CARTRIDGE message appears until you replace the print cartridge. HP does not guarantee print quality if you select CONTINUE after a REPLACE CARTRIDGE condition. Replace the print cartridge as soon as possible to ensure good print quality.</p> <p>If the end of drum life is reached, the printer stops, regardless of the CARTRIDGE OUT setting.</p>
JAM RECOVERY	*AUTO OFF ON	<p>Determines how the printer behaves if a jam occurs.</p> <p>AUTO: The printer automatically selects the best mode for printer jam recovery (usually ON).</p> <p>OFF: The printer does not reprint pages following a jam. Printing performance might be increased with this setting.</p> <p>ON: The printer automatically reprints pages after a jam is cleared.</p>
RAM DISK	*AUTO OFF	<p>Determines how the RAM disk is configured. This item appears only if no optional hard-disk accessory is installed.</p> <p>AUTO: Allows the printer to determine the optimal RAM-disk size based on the amount of available memory.</p> <p>OFF: The RAM disk is not available.</p> <hr/> <p>NOTE</p> <p>If you change the setting from OFF to AUTO, the printer automatically reinitializes when it becomes idle.</p> <hr/>
LANGUAGE	*ENGLISH Several	<p>Selects the language for the messages that appear on the printer control-panel display.</p>

Stapler/stacker submenu

Use this submenu to select settings for the optional stapler/stacker, if it is installed.

Some items on this menu are available in the program or printer driver (if the appropriate driver is installed).

The section that follows lists the settings and possible values. In the Values column, the default value for each setting is the one that has an asterisk (*) next to it.

Item	Values	Explanation
STAPLES	* NONE ONE	<p>Determines whether print jobs are stapled or not.</p> <p>NONE: Turns off stapling.</p> <p>ONE: Turns on stapling.</p> <hr/> <p>NOTE</p> <p>Selecting the stapler at the printer control panel changes the default setting to staple. It is possible that all print jobs will be stapled.</p> <hr/> <p>For information about selecting the stapler at the printer control panel, see Stapling documents.</p>
STAPLES OUT	* STOP CONTINUE	<p>Determines how the printer behaves if the stapler runs out of staples, as indicated by the REPLACE STAPLE CARTRIDGE message on the printer control-panel display.</p> <p>STOP: The printer stops printing until you refill the stapler.</p> <p>CONTINUE: The stapler accepts print jobs if it is out of staples, but the pages are not stapled.</p> <p>For information about ordering a new staple cartridge, see Part numbers. For information about refilling the stapler, see Loading staples.</p>

I/O submenu

Items on the I/O (input/output) menu affect the communication between the printer and the computer. The contents of the I/O submenu depend on which EIO card is installed.

The section that follows lists the settings and possible values. In the Values column, the default value for each setting is the one with an asterisk (*) next to it.

Item	Values	Explanation
I/O TIMEOUT	5 to 300 (*15) SECONDS	<p>Select the I/O timeout period in seconds.</p> <p>Use this setting to adjust timeout for the best performance. If data from other ports appear in the middle of your print job, increase the timeout value.</p>
PARALLEL INPUT	HIGH SPEED ADVANCED FUNCTIONS	<p>Configure the parallel features.</p> <p>HIGH SPEED: Select YES to enable the printer to accept the faster parallel communications that are used for connections with newer computers.</p> <p>ADVANCED FUNCTIONS: Turn the bidirectional parallel communication on or off. The default is set for a bidirectional parallel port (IEEE-1284).</p> <p>The function allows the printer to send status readback messages to the computer. (Turning the parallel advanced functions on might slow language switching.)</p>

Item	Values	Explanation
EMBEDDED JETDIRECT MENU	TCP/IP IPX/SPX APPLETALK DLC/LLC SECURE WEB DIAGNOSTICS	<p>TCP/IP: Select whether the TCP/IP protocol stack is enabled or disabled. You can set several TCP/IP parameters.</p> <p>Select the TCP/IP CONFIGURE METHOD to configure the EIO card. For the MANUAL option, set the values for IP ADDRESS , SUBNET MASK , LOCAL GATEWAY, and DEFAULT GATEWAY.</p> <p>IPX/SPX: Select whether the IPX/SPX protocol stack (in Novell NetWare networks, for example) is enabled or disabled.</p> <p>APPLETALK: Enable or disable an AppleTalk network.</p> <p>DLC/LLC: Select whether the DLC/LLC protocol stack is enabled or disabled.</p> <p>SECURE WEB: Specify whether the embedded Web server accepts communications by using only secure HTTP (HTTPS) or by using both HTTP and HTTPS.</p> <p>DIAGNOSTICS: Provides tests to help diagnose network hardware or TCP/IP network connection problems.</p>

Resets submenu

Items on the Resets submenu relate to returning settings to the defaults and changing settings such as Sleep Mode.

The section that follows lists the settings and possible values. In the Values column, the default value for each setting is the one with an asterisk (*) next to it.

Item	Values	Explanation
RESTORE FACTORY SETTINGS	There is no value to select.	<p>Performs a simple reset and restores most of the factory (default) settings. This item also clears the input buffer for the active I/O.</p> <hr/> <p>CAUTION</p> <p>Restoring memory during a print job cancels the print job.</p> <hr/>

<p>CLEAR MAINTENANCE MESSAGE</p>	<p>There is no value to select.</p>	<p>Appears after the PERFORM PRINTER MAINTENANCE message. The PERFORM PRINTER MAINTENANCE message can be temporarily cleared for approximately 10,000 pages, and then the message appears again. When the PERFORM PRINTER MAINTENANCE message first appears, a new maintenance kit should be installed to maintain optimum print quality and feed performance.</p> <p>For more information, see Performing preventive maintenance. To order the printer maintenance kit, see Part numbers.</p>
<p>SLEEP MODE</p>	<p>*ON OFF</p>	<p>Turns Sleep Mode on or off. Using Sleep mode offers the following advantages:</p> <ul style="list-style-type: none"> • Minimizes the amount of power that the printer consumes when it is idle • Reduces wear on electronic components in the printer (turns off the display backlight, but the display is still readable) <p>The printer automatically comes out of Sleep mode when you send a print job, press a printer control panel button, open a tray, or open the top cover.</p> <p>You can set how long the printer remains idle before it enters sleep mode. See the SLEEP DELAY information in the System Setup submenu.</p>

Diagnostics menu

Administrators can use this submenu to isolate parts and to troubleshoot jam and print-quality issues.

The section that follows lists the settings and possible values. In the Values column, the default value for each setting is the one that has an asterisk (*) next to it.

Item	Values	Explanation
PRINT EVENT LOG	There is no value to select.	Press ✓ (SELECT button) to generate a list of the 50 most recent entries in the event log. The printed event log shows error number, error code, page count, and description or personality.
SHOW EVENT LOG	There is no value to select.	Press ✓ (SELECT button) to scroll through the contents of the event log at the printer control panel, which lists up to the 50 most recent events. Use ▲ (UP button) or ▼ (DOWN button) to scroll through the event log contents.
PAPER PATH TEST	PRINT TEST PAGE SOURCE DESTINATION DUPLEX COPIES	<p>Generates a test page that is useful for testing the paper-handling features of the printer.</p> <p>PRINT TEST PAGE: Press ✓ (SELECT button) to start the paper-path test using the source (tray), destination (output bin), duplex, and number of copies settings that you set in the other items on the Paper Path Test menu. Set the other items before selecting PRINT TEST PAGE.</p> <p>SOURCE: Select the tray that uses the paper path that you want to test. You can select any tray that is installed. Select ALL TRAYS to test all tray paper paths. Paper must be loaded in the selected trays.</p> <p>DESTINATION: Select the output bin that uses the paper path that you want to test. You can select any output bin that is installed. Optional bins (stacker or stapler/stacker bin) must also be correctly configured in the printer driver. Select ALL BINS to test all paper paths.</p> <p>DUPLEX: Determine whether the paper goes through the duplexer during the paper-path test. This item is available only if the duplexer is installed.</p> <p>COPIES: Set how many sheets of paper are used from each tray during the paper-path test. If you are testing the optional stapler/stacker (DESTINATION item), select 10 or more sheets.</p>

Service menu

The Service menu is locked and requires a PIN for access. This menu is intended for use by authorized service personnel.



Specifications

HP LaserJet 4250 or 4350 series physical specifications

Product dimensions

Printer model	Width	Depth	Height	Weight ¹
HP LaserJet 4250, 4250n, 4350, and 4350n	418 mm (16.5 inches)	451 mm (17.8 inches)	377 mm (14.8 inches)	20.2 kg (44.5 lb)
HP LaserJet 4250tn and 4350tn	418 mm (16.5 inches)	451 mm (17.8 inches)	498 mm (19.6 inches)	27.2 kg (60.0 lb)
HP LaserJet 4250dtn and 4350dtn	418 mm (16.5 inches)	533 mm (21.0 inches)	498 mm (19.6 inches)	29.7 kg (65.5 lb)
HP LaserJet 4250dtnsl and 4350dtnsl	418 mm (16.5 inches)	533 mm (21.0 inches)	740 mm (29.1 inches)	33.7 kg (74.3 lb)

¹Without print cartridge

Product dimensions, with all doors and trays fully opened

Printer model	Width	Depth	Height
HP LaserJet 4250, 4250n, 4350, and 4350n	547 mm (21.5 inches)	936 mm (38.9 inches)	418 mm (16.5 inches)
HP LaserJet 4250tn, 4250dtn, 4350tn, and 4350dtn	668 mm (26.3 inches)	936 mm (38.9 inches)	418 mm (16.5 inches)
HP LaserJet 4250dtnsl and 4350dtnsl	734 mm (28.9 inches)	936 mm (38.9 inches)	418 mm (16.5 inches)

Printer accessories

Accessory	Width	Depth	Height	Weight
500-sheet feeder	418 mm (16.5 inches)	451 mm (17.8 inches)	121 mm (4.8 inches)	7 kg (15.4 lb)
1,500-sheet feeder	416 mm (16.4 inches)	514 mm (20.2 inches)	286 mm (11.3 inches)	13 kg (28.7 lb)

Printer accessories (continued)

Accessory	Width	Depth	Height	Weight
Stacker	211 mm (8.3 inches)	427 mm (16.8 inches)	351 mm (13.8 inches)	4.2 kg (9.3 lb)
Stapler/stacker	211 mm (8.3 inches)	427 mm (16.8 inches)	351 mm (13.8 inches)	4.2 kg (9.3 lb)
Printer cabinet/stand	330 mm (13 inches)	686 mm (27 inches)	660 mm (26 inches)	19.8 kg (43.6 lb)
Duplex-printing accessory				2.5 kg (5.5 lb)
Envelope feeder				2.5 kg (5.5 lb)

Electrical specifications

WARNING!

Power requirements are based on the country/region where the printer is sold. Do not convert operating voltages. This can damage the printer and void the product warranty.

Power requirements (HP LaserJet 4250 or 4350 series)

Specification	110-volt models	230-volt models
Power requirements	110 to 127 Vac ($\pm 10\%$) 50/60 Hz (± 3 Hz)	220 to 240 Vac ($\pm 10\%$) 50/60 Hz (± 3 Hz)
Rated short-term current	10.0 Amps	5.0 Amps

Power consumption HP LaserJet 4250 or 4350 series (average, in watts)¹

Product model	Printing ²	Ready	Sleep	Off
HP LaserJet 4250	680 W ³	20 W	13 W	0.3 W
HP LaserJet 4250n	680 W ³	20 W	13 W	0.3 W
HP LaserJet 4250tn	680 W ³	20 W	13 W	0.3 W
HP LaserJet 4250dtn	680 W ³	21 W	13 W	0.3 W
HP LaserJet 4250dtnsl	750 W ³	23 W	13 W	0.3 W
HP LaserJet 4350	790 W ³	20 W	13 W	0.3 W
HP LaserJet 4350n	790 W ³	20 W	13 W	0.3 W
HP LaserJet 4350tn	790 W ³	20 W	13 W	0.3 W
HP LaserJet 4350dtn	790 W ³	21 W	13 W	0.3 W
HP LaserJet 4350dtnsl	825 W ³	23 W	13 W	0.3 W

¹ Values subject to change. See <http://www.hp.com/support/lj4250> or <http://www.hp.com/support/lj4350> for current information.

²Power numbers are the highest values measured using all standard voltages.

³HP LaserJet 4250 speed is 45 ppm Letter size and 43 ppm A4 size. HP LaserJet 4350 speed is 55 ppm Letter size and 52 ppm A4 size.

⁴Default time from Ready mode to Sleep = 30 minutes.

⁵Recovery time from Sleep to start of printing = less than 8 seconds.

⁶Heat dissipation in Ready mode = 75 BTU/hour

Acoustic emissions

Sound power and pressure level¹ (HP LaserJet 4250 or 4350 series)

Sound power level	Declared per ISO 9296
Printing ² (HP LaserJet 4250)	$L_{wAd} = 6.9$ Bels (A) [69 dB(A)]
Printing ² (HP LaserJet 4350)	$L_{wAd} = 7.1$ Bels (A) [71 dB(A)]
Ready (HP LaserJet 4250)	$L_{wAd} = 4.0$ Bels (A) [40 dB(A)]
Ready (HP LaserJet 4350)	$L_{wAd} = 3.8$ Bels (A) [38 dB(A)]
Sound pressure level	Declared per ISO 9296
Printing ² (HP LaserJet 4250)	$L_{pAm} = 62$ dB (A)
Printing ² (HP LaserJet 4350)	$L_{pAm} = 64$ dB (A)
Ready (HP LaserJet 4250)	$L_{pAm} = 26$ dB (A)
Ready (HP LaserJet 4350)	$L_{pAm} = 26$ dB (A)

¹Values subject to change. See <http://www.hp.com/support/lj4250> or <http://www.hp.com/support/lj4350> for current information.

²HP LaserJet 4250 speed is 43 ppm A4 size. HP LaserJet 4350 speed is 52 ppm A4 size.

³Configuration tested (HP LaserJet 4250): Base printer, simplex printing with A4 paper size.

⁴Configuration tested (HP LaserJet 4350): Base printer, simplex printing with A4 paper size.

Operating environment

Environmental condition	Printing	Storage/standby
Temperature (printer and print cartridge)	10° to 32°C (50° to 90°F)	0° to 35°C (32° to 95°F)
Relative humidity	10% to 80%	10% to 90%

Paper specifications

For complete paper specifications for all HP LaserJet printers, see the *HP LaserJet printer family print media guide* (available at <http://www.hp.com/support/ljpaperguide>).

Category	Specifications
Acid content	5.5 pH to 8.0 pH
Caliper	0.094 to 0.18 mm (3.0 to 7.0 mils)
Curl in ream	Flat within 5 mm (0.02 inch)
Cut edge conditions	Cut with sharp blades with no visible fray.
Fusing compatibility	Must not scorch, melt, offset, or release hazardous emissions when heated to 200°C (392°F) for 0.1 second.
Grain	Long grain
Moisture content	4% to 6% by weight
Smoothness	100 to 250 Sheffield

Printing and paper storage environment

Ideally, the printing and paper storage environment should be at or near room temperature, and not too dry or too humid. Remember paper is hygroscopic; it absorbs and loses moisture rapidly.

Heat works with humidity to damage paper. Heat causes the moisture in paper to evaporate, while cold causes it to condense on the sheets. Heating systems and air conditioners remove most of the humidity from a room. As paper is opened and used, it loses moisture, causing streaks and smudging. Humid weather or water coolers can cause the humidity to increase in a room. As paper is opened and used it absorbs any excess moisture, causing light print and dropouts. Also, as paper loses and gains moisture it can distort. This can cause jams.

As a result, paper storage and handling are as important as the paper-making process itself. Paper storage environmental conditions directly affect the feed operation.

Care should be taken not to purchase more paper than can be easily used in a short time (about 3 months). Paper stored for long periods might experience heat and moisture extremes, which can cause damage. Planning is important to prevent damage to a large supply of paper.

Unopened paper in sealed reams can remain stable for several months before use. Opened packages of paper have more potential for environmental damage, especially if they are not wrapped with a moisture-proof barrier.

The paper storage environment should be properly maintained to ensure optimum printer performance. The required condition is 20° to 24°C (68° to 75°F), with a relative humidity of 45% to 55%. The following guidelines should be helpful when evaluating the paper's storage environment:

- Paper should be stored at or near room temperature.
- The air should not be too dry or too humid (due to the hygroscopic properties of paper).
- The best way to store an opened ream of paper is to rewrap it tightly in its moisture-proof wrapping. If the printer environment is subject to extremes, unwrap only the amount of paper to be used during the day's operation to prevent unwanted moisture changes.

Envelopes

Envelope construction is critical. Envelope fold lines can vary considerably, not only between manufacturers, but also within a box from the same manufacturer. Successful printing on envelopes depends upon the quality of the envelopes. When selecting envelopes, consider the following components:

- **Weight:** The weight of the envelope paper should not exceed 105 g/m² (28 lb) or jamming might occur.
- **Construction:** Prior to printing, envelopes should lie flat with less than 6 mm (0.25 inch) curl, and should not contain air.
- **Condition:** Envelopes should not be wrinkled, nicked, or otherwise damaged.
- **Temperature:** You should use envelopes that are compatible with the heat and pressure of the printer.
- **Size:** You should use only envelopes within the following size ranges.
 - **Minimum:** 76 x 127 mm (3 x 5 inches)
 - **Maximum:** 216 x 356 mm (8.5 x 14 inches)

NOTE

Use only tray 1 or the optional envelope feeder to print envelopes. You might experience some jams when using any media with a length less than 178 mm (7 inches). This might be caused by paper that has been affected by environmental conditions. For optimum performance, make sure you are storing and handling the paper correctly (see [Printing and paper storage environment](#)). Choose envelopes in the printer driver (see [Using the printer driver](#)).

Envelopes with double side seams

Double side-seam construction has vertical seams at both ends of the envelope rather than diagonal seams. This style might be more likely to wrinkle. Be sure the seam extends all the way to the corner of the envelope as illustrated below.

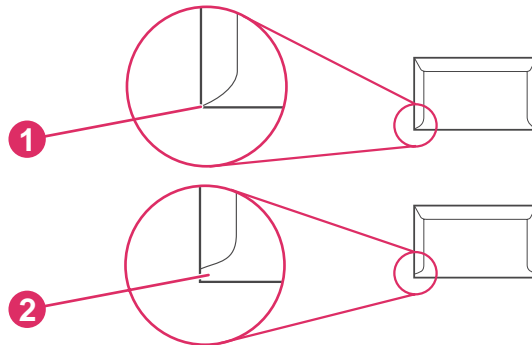

- 1 Acceptable envelope construction
- 2 Unacceptable envelope construction

Envelopes with adhesive strips or flaps

Envelopes with a peel-off adhesive strip or with more than one flap that folds over to seal must use adhesives compatible with the heat and pressure in the printer. The extra flaps and strips might cause wrinkling, creasing, or even jams and might even damage the fuser.

Envelope margins

The following gives typical address margins for a commercial #10 or DL envelope.

Type of address	Top margin	Left margin
Return address	15 mm (0.6 inch)	15 mm (0.6 inch)
Delivery address	51 mm (2 inches)	89 mm (3.5 inches)

NOTE

For the best print quality, position margins no closer than 15 mm (0.6 inch) from the edges of the envelope. Avoid printing over the area where the envelope's seams meet.

Envelope storage

Proper storage of envelopes helps contribute to print quality. Envelopes should be stored flat. If air is trapped in an envelope, creating an air bubble, then the envelope might wrinkle during printing.

For more information, see [Printing envelopes](#).

Labels

CAUTION

To avoid damaging the printer, use only labels recommended for laser printers. To prevent serious jams, always use tray 1 to print labels and always use the rear output bin. Never print on the same sheet of labels more than once or print on a partial sheet of labels.

Label construction

When selecting labels, consider the quality of each component:

- **Adhesives:** The adhesive material should be stable at 200°C (392°F), the printer's fusing temperature.
- **Arrangement:** Only use labels with no exposed backing between them. Labels can peel off sheets with spaces between the labels, causing serious jams.
- **Curl:** Prior to printing, labels must lie flat with no more than 13 mm (0.5 inch) of curl in any direction.
- **Condition:** Do not use labels with wrinkles, bubbles, or other indications of separation.

For more information, see [Printing on labels](#).

NOTE

Choose labels in the printer driver (see [Using the printer driver](#)).

Transparencies

Transparencies used in the printer must be able to withstand 200°C (392°F), the printer's fusing temperature.

CAUTION

To avoid damaging the printer, use only transparencies recommended for use in HP LaserJet printers, such as HP-brand transparencies. (For ordering information, see [Part numbers](#).)

For more information, see [Printing on transparencies](#).

NOTE

Choose transparencies in the printer driver (see [Using the printer driver](#)).

D

Printer memory and expansion

This section explains the memory features of the printer and provides steps for expansion.

- [Printer memory](#)
- [Installing CompactFlash cards](#)
- [Checking memory installation](#)
- [Saving resources \(permanent resources\)](#)
- [Installing EIO cards or mass storage devices](#)

Overview

The printer comes with one dual inline memory module (DIMM) already installed. One additional DIMM slot and two CompactFlash slots are available for upgrading the printer with the following items:

- More printer memory—DIMMs (SDRAM) are available in 48, 64, 128, and 256 MB, for a maximum of 512 MB.
- CompactFlash font cards—Unlike standard printer memory, CompactFlash cards can be used to permanently store downloaded items, such as fonts and forms, even when the printer is off. These cards can also be used to enable the printer to print non-Roman characters.
- Other DIMM-and CompactFlash-based printer languages and printer options.

NOTE

Single inline memory modules (SIMMs) used in previous HP LaserJet printers are not compatible with the printer.

The printer also has two EIO slots for expanding the printer's capabilities with a mass storage device, such as an optional hard disk for storing forms and fonts, and for certain job-storage functions. The EIO slots can also be used for adding a wireless connections, a network card, or a connectivity card for serial or AppleTalk.

NOTE

Some HP LaserJet 4250 or 4350 series printers come with a network device already installed. The EIO slot can be used to provide networking capabilities in addition to those already built into the printer.

To find out how much memory is installed in the printer, or to find out what is installed in the EIO slots, print a configuration page. (See [Configuration page](#).)

Printer memory

You might want to add more printer memory to the printer if you often print complex graphics, print PostScript (PS) documents, or use many downloaded fonts. Added memory also gives you more flexibility in supporting job-storage features, such as quick copying.

To install printer memory

CAUTION

Static electricity can damage DIMMs. When handling DIMMs, either wear an antistatic wrist strap or frequently touch the surface of the DIMM antistatic package, then touch bare metal on the printer.

The HP LaserJet 4250 or 4350 series printers come with one DIMM installed in slot 1. A second DIMM can be installed in slot 2. If desired, you can replace the DIMM installed in slot 1 with a higher-memory DIMM.

If you have not already done so, print a configuration page to find out how much memory is installed in the printer before adding more memory. (See [Configuration page](#).)

1. Turn the printer power off.

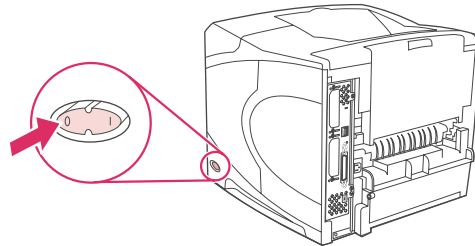

2. Unplug the power cord and disconnect any cables.

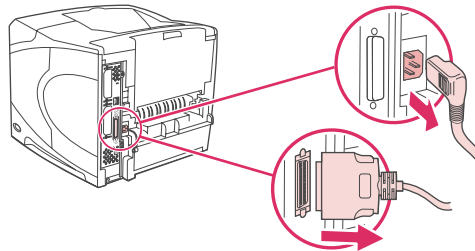

3. Grasp the cover on the right side of the printer and pull it firmly toward the rear of the printer until it stops.

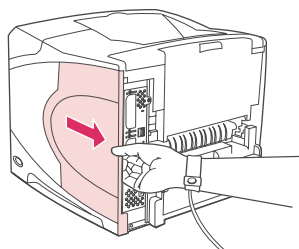

4. Remove the cover from the printer.

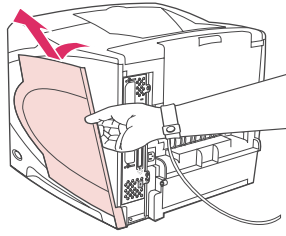

5. Open the access door by pulling on the metal tab.

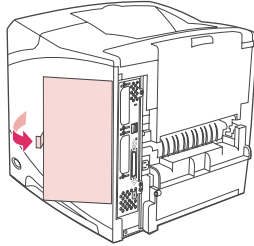

6. Remove the DIMM from the antistatic package. Hold the DIMM with your fingers against the side edges and thumbs against the back edge. Align the notches on the DIMM with the DIMM slot. (Check that the locks on each side of the DIMM slot are open, or outward.)

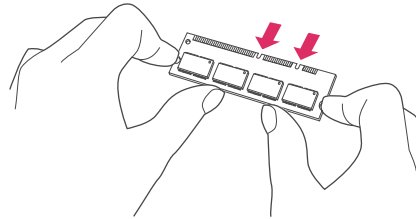

7. Press the DIMM straight into the slot, and press firmly. Make sure the locks on each side of the DIMM snap into place.

NOTE

To remove a DIMM, first release the locks.

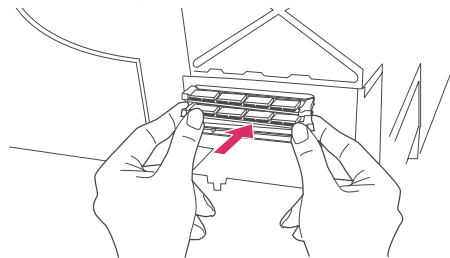

CAUTION

Do not move or remove the preinstalled DIMM in the bottom slot.

8. Close the access door and press firmly until it snaps into place.

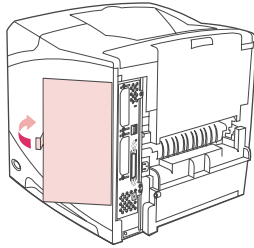

9. Set the bottom of the cover onto the printer. Make sure the bottom tab on the cover fits into the corresponding slot in the printer. Rotate the cover up, toward the printer.

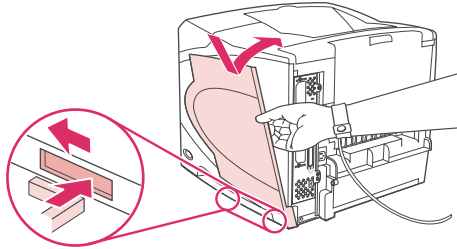

10. Slide the cover toward the front of the printer until it clicks into place.

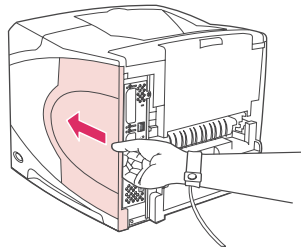

11. Reattach any cables and the power cord, then turn the printer power on, and then test the DIMM installation. See [Checking memory installation](#) below.

Installing CompactFlash cards

Up to two CompactFlash cards can be installed to add additional fonts to the printer.

To install a CompactFlash card

1. Turn the printer power off.

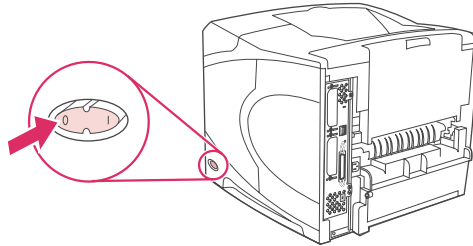

2. Unplug the power cord and disconnect any cables.

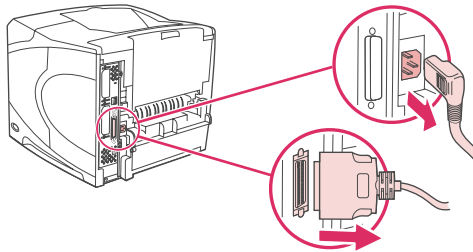

3. Grasp the cover on the right side of the printer and pull it firmly toward the rear of the printer until it stops.

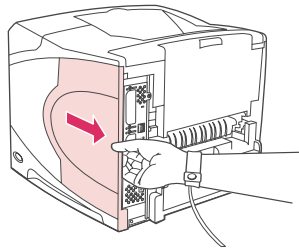

4. Remove the cover from the printer.

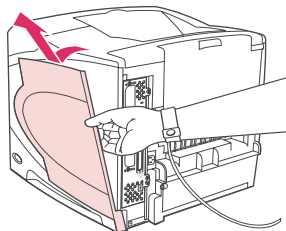

5. Open the access door by pulling on the metal tab.

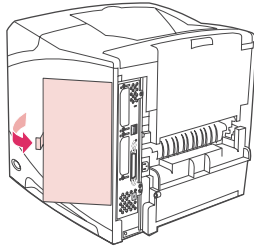

6. Remove the CompactFlash card from its package.

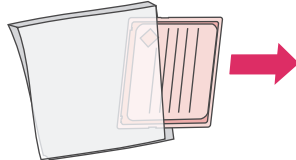

7. Hold the CompactFlash card by its edges and line up the grooves in the side of the card with the tabs in the CompactFlash card slot.

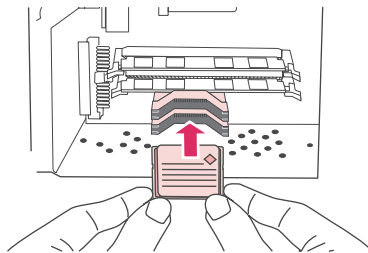

8. Slide the CompactFlash card into place.

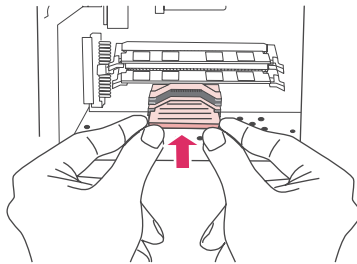

9. Close the access door, press firmly until it snaps into place.

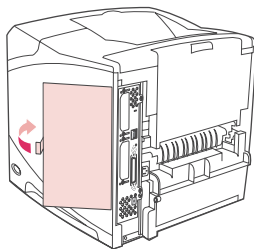

10. Set the bottom of the cover onto the printer. Make sure the bottom tab on the cover fits into the corresponding slot in the printer. Rotate the cover up, toward the printer.

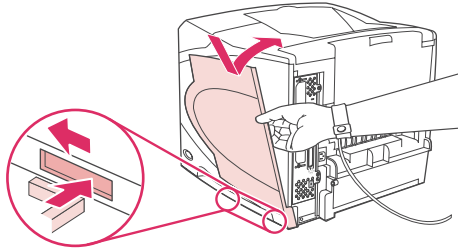

11. Slide the cover toward the front of the printer until it clicks into place.

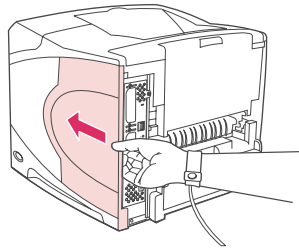

12. Reattach any cables and the power cord, then turn the printer power on and test the installation. (See [Checking memory installation.](#))

Use Device Storage Manager in HP Web Jetadmin to manage fonts. For more information, see the Help in HP Web Jetadmin.

Checking memory installation

After installing the DIMM or CompactFlash card, make sure that the installation was successful.

To verify that DIMMs or CompactFlash cards are installed correctly

1. Check that Ready appears on the printer control panel display when the printer power is turned on. If an error message appears, a DIMM or CompactFlash card might have been incorrectly installed. See [Interpreting control-panel messages](#).
2. Print a new configuration page. (See [Configuration page](#).)
3. Check the memory section on the configuration page and compare it to the configuration page that was printed before the memory installation. If the amount of memory has not increased, the DIMM or CompactFlash card might not be installed correctly, or the DIMM or CompactFlash card might be defective. Repeat the installation procedure. If necessary, install a different DIMM or CompactFlash card.

NOTE

If you installed a printer language (personality), check the "Installed Personalities and Options" section on the configuration page. This area should list the new printer language.

Saving resources (permanent resources)

Utilities or jobs that you download to the printer sometimes include resources (for example, fonts, macros, or patterns). Resources that are internally marked as permanent remain in the printer memory until you turn the printer power off.

Use the following guidelines if you use the page description language (PDL) ability to mark resources as permanent. For technical details, see an appropriate PDL reference for PCL or PS.

- Mark resources as permanent only when it is absolutely necessary that they remain in memory while the printer power is turned on.
- Send permanent resources to the printer only at the beginning of a print job and not while the printer is printing.

NOTE

Over-using permanent resources or downloading them while the printer is printing might affect printer performance or the ability to print complex pages.

Installing EIO cards or mass storage devices

Follow this procedure to install an EIO card or mass storage device (optional hard disk).

To install EIO cards or mass storage devices

1. Turn the printer power off.
2. Remove the two screws and cover plate from the EIO 1 or EIO 2 slot on the back of the printer.

NOTE

Do not discard the screws or the cover plate. Save them for future use if you remove the EIO card.

3. Install the EIO card or mass storage device in the EIO slot and tighten the screws.

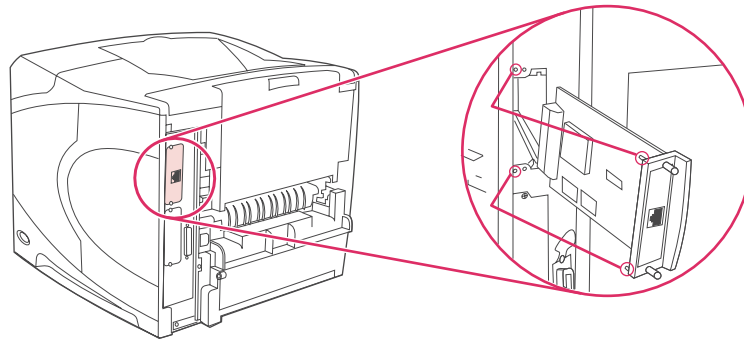

4. Turn the printer power on and print a configuration page to verify that the new EIO device is recognized. (See [Configuration page](#).)

To remove an installed EIO card or mass storage device (optional hard disk)

1. Turn the printer power off.
2. Remove the two screws from the EIO card or mass storage device, and then remove the EIO card or mass storage device from the EIO slot.
3. Place the cover plate from the EIO 1 or EIO 2 slot onto the back of the printer. Insert and tighten the two screws.
4. Turn the printer power on.

E

Printer commands

Most programs do not require you to enter printer commands. See your computer and software documentation to find the method for entering printer commands, if needed.

PCL 6 and PCL 5e	PCL 6 and PCL 5e printer commands tell the printer which tasks to perform or which fonts to use. This section provides a quick reference for users who are already familiar with PCL 6 and PCL 5e command structure.
HP-GL/2	The printer has the ability to print vector graphics using the HP-GL/2 graphics language. Printing in the HP-GL/2 language requires that the printer leave PCL 5e language and enter HP-GL/2 mode, which can be done by sending the printer PCL 5e code. Some programs switch languages through their drivers.
PJL	HP's Printer Job Language (PJL) provides control above PCL 5e and other printer languages. The four major functions provided by PJL are: printer language switching, job separation, printer configuration, and status readback from the printer. PJL commands can be used to change printer default settings.

NOTE

The table at the end of this section contains commonly used PCL 5e commands. (See [Common PCL 6 and PCL 5 printer commands](#).) For a complete listing and explanation of how to use PCL 5e, HP-GL/2, and PJL commands, see the *HP PCL/PJL Reference Set*, which is available on CD-ROM (HP part number 5961-0975).

Understanding PCL 6 and PCL 5e printer command syntax

Before using printer commands, compare these characters:

Lowercase l:	l	Uppercase O:	O
Number one:	1	Number 0:	0

Many printer commands use the lowercase letter l (l) and the number one (1), or the uppercase letter O (O) and the number zero (0). These characters might not appear on your screen as shown here. You must use the exact character and case specified for PCL 6 or PCL 5e printer commands.

The figure below explains the elements of a typical printer command (in this instance, a command for page orientation).

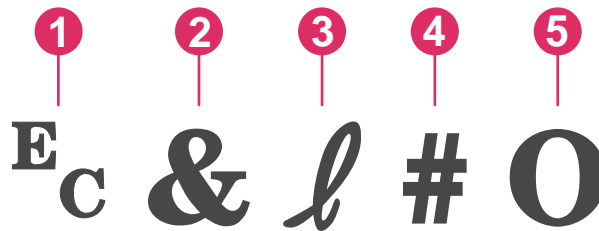

- 1 Escape character (begins the escape sequence)
- 2 Parameterized character
- 3 Group character
- 4 Value field (contains both alpha and numeric characters)
- 5 Termination character (uppercase)

Combining escape sequences

Escape sequences can be combined into one escape sequence string. Follow these three important rules when combining code:

1. The first two characters after the E_c character are the parameterized and group characters. These characters must be the same in all of the commands that are to be combined.
2. When combining escape sequences, change the uppercase termination character in each individual escape sequence to lowercase.
3. The final character of the combined escape sequence must be uppercase.

The following is an example of an escape sequence string that would be sent to the printer to select legal paper, landscape orientation, and eight lines per inch:

```
Ec&I3AEc&I1OEc&I8D
```

The following escape sequence sends the same printer commands by combining them into a shorter sequence:

```
Ec&I3a1o8D
```

Using escape characters

Printer commands always begin with the escape character (E_c).

The following table shows how the escape character can be inserted in various MS-DOS programs.

DOS program	Entry	What appears
Lotus 1-2-3 and Symphony	Type \027	027
Microsoft Word for MS-DOS	Hold down Alt and type 027 on the numeric keypad	↔
WordPerfect for MS-DOS	Type <27>	<27>
MS-DOS Edit	Hold down Ctrl+P , and press Esc	↔
MS-DOS Edlin	Hold down Ctrl+V , and press [^[
dBase	?? CHR(27)+"command"	?? CHR(27)+" "

Selecting PCL 6 and PCL 5 fonts

The printer font list provides PCL 6 and PCL 5 printer commands for selecting fonts. See [PS or PCL font list](#) for information about how to print the list. A sample section is shown in the following illustration.

One variable box is available for specifying symbol sets and one for specifying point size. These variables must be filled in, or the printer will use defaults. For example, if you want a symbol set that contains line-draw characters, select the 10U (PC-8) or 12U (PC-850) symbol set. Other common symbol set codes are listed in the section [Common PCL 6 and PCL 5 printer commands](#).

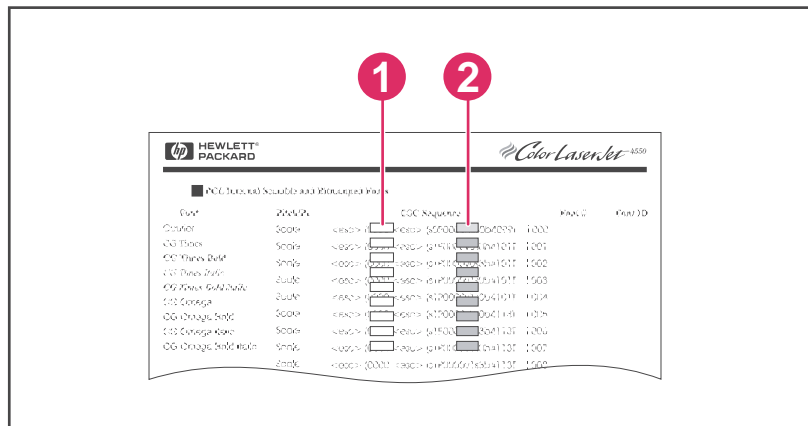

- 1 Symbol set
- 2 Point size

NOTE

Fonts are either "fixed" or "proportional" in spacing. The printer contains both fixed fonts (Courier, Letter Gothic, and Lineprinter) and proportional fonts (CG Times, Arial, Times New Roman, and others). Fixed-spaced fonts are generally used in programs such as spreadsheets and databases, where it is important for columns to line up vertically. Proportional-spaced fonts are generally used in text and word-processing programs.

Common PCL 6 and PCL 5 printer commands

Job-control commands

Function	Command	Options (#)
Reset	E _c E	not available
Number of copies	E _c &I#X	1 to 999
2-sided/1-sided printing	E _c &I#S	0 = Simplex (1-sided) printing 1 = Duplex (2-sided) with long edge binding 2 = Duplex (2-sided) with short edge binding

Page-control commands

Function	Command	Options (#)
Paper source	E _c &I#H	0 = Prints or ejects current page 1 = Tray 2 2 = Manual feed, paper 3 = Manual feed, envelope 4 = Tray 1 5 = Tray 3 6 = Optional envelop feeder 7 = Auto select 8 = Tray 4 20 to 69 = external trays
Paper size	E _c &I#A	1 = Executive 2 = Letter 3 = Legal 25 = A5 26 = A4 45 = JIS B5 80 = Monarch envelope 81 = Commercial 10 envelope 90 = DL ISO envelope 91 = C5 ISO envelope 100 = B5 ISO envelope/B5 ISO 101 = Custom

Page-control commands (continued)

Function	Command	Options (#)
Paper type	E _c &n#	5WdBond = Bond 6WdPlain = Plain 6WdColor = Color 7WdLabels = Labels 9WdRecycled = Recycled 11WdLetterhead = Letterhead 10WdCardstock = Cardstock 11WdPrepunched = Prepunched 11WdPreprinted = Preprinted 13WdTransparency = Transparency #WdCustompapertype = Custom ¹
Orientation	E _c &l#O	0 = Portrait 1 = Landscape 2 = Reverse portrait 3 = Reverse landscape
Top margin	E _c &l#E	# = Number of lines
Text length (bottom margin)	E _c &l#F	# = Number of lines from top margin
Left margin	E _c &a#L	# = Column number
Right margin	E _c &a#M	# = Column number from left margin
Horizontal motion index	E _c &k#H	1/120-inch increments (compresses print horizontally)
Vertical motion index	E _c &l#C	1/48-inch increments (compresses print vertically)
Line spacing	E _c &l#D	# = Lines per inch (1, 2, 3, 4, 5, 6, 12, 16, 24, 48)
Perforation skip	E _c &l#L	0 = Disable (turn off) 1 = Enable (turn on)

¹ For custom paper, replace "Custompapertype" with the name of the paper, and replace the "#" with the number of characters in the name, plus 1.

Cursor Positioning

Function	Command	Options (#)
Vertical position (rows)	E _c &a#R	# = Row number

Cursor Positioning (continued)

Function	Command	Options (#)
Vertical position (dots)	E _c *p#Y	# = Dot number (300 dots = 1 inch)
Vertical position (decipoints)	E _c &a#V	# = Decipoint number (720 decipoints = 1 inch)
Horizontal position (columns)	E _c &a#C	# = Column number
Horizontal position (dots)	E _c *p#X	# = Dot number (300 dots = 1 inch)
Horizontal position (decipoints)	E _c &a#H	# = Decipoint number (720 decipoints = 1 inch)

Programming hints

Function	Command	Options (#)
End of line wrap	E _c &s#C	0 = Enable (turn off) 1 = Disable (turn on)
Display functions on	E _c Y	not available
Display functions off	E _c Z	not available

Language selection

Function	Command	Options (#)
Enter PCL 6 or PCL 5 mode	E _c %#A	0 = Use previous PCL 5 cursor position 1 = Use current HP-GL/2 pen position
Enter HP-GL/2 mode	E _c %#B	0 = Use previous HP-GL/2 pen position 1 = Use current PCL 5 cursor position

Font selection

Function	Command	Options (#)
Symbol sets	E _c (#	8U = HP Roman-8 Symbol Set 10U = IBM Layout (PC-8) (code page 437) Default Symbol Set 12U = IBM Layout for Europe (PC-850) (code page 850) 8M = Math-8 19U = Windows 3.1 Latin 1 9E = Windows 3.1 Latin 2 (commonly used in Eastern Europe) 5T = Windows 3.1 Latin 5 (commonly used in Turkey) 579L = Wingdings Font
Primary spacing	E _c (s#P	0 = Fixed 1 = Proportional
Primary pitch	E _c (s#H	# = Characters/inch
Set pitch mode ¹	E _c &k#S	0 = 10 4 = 12 (elite) 2 = 16.5 - 16.7 (compressed)
Primary height	E _c (s#V	# = Points
Primary style	E _c (s#S	0 = Upright (solid) 1 = Italic 4 = Condensed 5 = Condensed italic
Primary stroke wt.	E _c (s#B	0 = Medium (book or text) 1 = Semi bold 3 = Bold 4 = Extra bold
Typeface	E _c (s#T	Print a PCL 6 or PCL 5 font list to view the command for each internal font.

¹The preferred method is to use the primary pitch command.

F

Regulatory information

Introduction

This section contains the following regulatory information:

- [FCC regulations](#)
- [Environmental Product Stewardship program](#)
- [Declaration of conformity](#)
- [Laser safety statement](#)
- [Canadian DOC statement](#)
- [Korean EMI statement](#)
- [Finnish laser statement](#)

FCC regulations

This equipment has been tested and found to comply with the limits for a Class B digital device, pursuant to Part 15 of the FCC rules. These limits are designed to provide reasonable protection against harmful interference in a residential installation. This equipment generates, uses, and can radiate radio frequency energy. If this equipment is not installed and used in accordance with the instructions, it may cause harmful interference to radio communications. However, there is no guarantee that interference will not occur in a particular installation; the presence of interference can be determined by turning the equipment off and on. If this equipment does cause harmful interference to radio or television communications, the user is encouraged to try to correct the interference by one or more of the following measures:

- Reorient or relocate the receiving antenna.
- Increase distance between equipment and receiver.
- Connect equipment to an outlet on a circuit different from that to which the receiver is located.
- Consult your dealer or an experienced radio/television technician.

NOTE

Any changes or modifications to the printer that are not expressly approved by HP could void the user's authority to operate this equipment.

Use of a shielded interface cable is required to comply with the Class B limits of Part 15 of FCC rules.

Environmental Product Stewardship program

Protecting the environment

Hewlett-Packard Company is committed to providing quality products in an environmentally sound manner. This product has been designed with several attributes to minimize impacts on our environment.

Ozone production

This product generates no appreciable ozone gas (O₃).

Energy consumption

Power usage drops significantly while in PowerSave mode, which saves natural resources and saves money without affecting the high performance of this product. This product qualifies for ENERGY STAR® (Printers, Version 3.0), which is a voluntary program to encourage the development of energy-efficient office products.



ENERGY STAR® is a U.S. registered service mark owned by the U.S. government. As an ENERGY STAR partner, Hewlett-Packard Company has determined that this product meets ENERGY STAR Guidelines for energy efficiency. For more information, see <http://www.energystar.gov>.

Toner consumption

EconoMode uses significantly less toner, which might extend the life of the print cartridge.

Paper use

This product's automatic duplex feature (two-sided printing) and n-up printing (multiple pages printed on one page) capabilities can reduce media usage and the resulting demands on natural resources. (The automatic duplex feature is available only for models that include a built-in duplexer. Manual duplexing is available for all models. See [Printing on both sides of paper \(optional duplexer\)](#).)

Plastics

Plastic parts over 25 grams are marked according to international standards that enhance the ability to identify plastics for recycling purposes at the end of the product's life.

HP LaserJet printing supplies

In many countries/regions, this product's printing supplies (for example, print cartridge and fuser) can be returned to HP through the HP Printing Supplies Environmental Program. An easy-to-use and free take back program is available in more than 30 countries/regions. Multilingual program information and instructions are included in every new HP LaserJet print cartridge and supplies package.

HP Printing Supplies Returns and Recycling Program Information

Since 1992, HP has offered HP LaserJet supplies return and recycling free of charge in 86% of the world market where HP LaserJet supplies are sold. Postage-paid and pre-addressed labels are included within the instruction guide in most HP LaserJet print cartridge boxes. Labels and bulk boxes are also available through the Web site at <http://www.hp.com/recycle>. More than 10 million HP LaserJet print cartridges were recycled globally in 2002 through the HP Planet Partners supplies recycling program. This record number represents 26 million pounds of print cartridge materials that were diverted from landfills. Worldwide, HP recycled an average of 80% of the print cartridge by weight, consisting primarily of plastic and metals. Recycled plastics and metals are used to make new products, such as HP products, plastic trays, and spools. The remaining materials are disposed of in an environmentally responsible manner.

- **U.S. returns** For a more environmentally responsible return of used cartridges and supplies, HP encourages the use of bulk returns. Simply bundle two or more cartridges together and use the single, prepaid, preaddressed UPS label that is supplied in the package. For more information in the U.S., call 1-800-340-2445 or visit the HP LaserJet Supplies Web site at <http://www.hp.com/recycle>.
- **Non-U.S. returns** Non-U.S. customers should call the local HP Sales and Service Office or visit the <http://www.hp.com/recycle> Web site for further information regarding availability of the HP Supplies Returns and Recycling Program.

Paper

This product is capable of using recycled papers when the paper meets the guidelines outlined in the *HP LaserJet Printer Family Print Media Guide*. Go to <http://www.hp.com/support/ljpaperguide> to download this guide in .PDF format. This product is suitable for the use of recycled media according to EN12281:2002.

Material restrictions

This HP product does not contain added mercury.

This HP product may initially contain lead in solder that might require special handling at end-of-life. This product will eventually switch to lead-free construction in compliance with the European Waste from Electrical and Electronic Equipment (WEEE) law.

This HP product contains a battery that might require special handling at end-of-life.

Type	Lithium Carbon Monofluoride (BR1632), 3 Volt, button-style battery, 1.5 grams
Materials	Mercury-free, Cadmium-free
Location	On printed circuit board
User removable	No

For recycling information, you can contact <http://www.hp.com/recycle> or contact your local authorities or the Electronics Industry Alliance: <http://www.eiae.org>.

Material safety data sheet

Material Safety Data Sheets (MSDS) for supplies that contain chemical substances (for example, toner) can be obtained by contacting the HP Web site at <http://www.hp.com/go/msds> or <http://www.hp.com/hpinfo/community/environment/productinfo/safety>.

For more information

To obtain information about the following environmental topics, visit <http://www.hp.com/go/environment> or <http://www.hp.com/hpinfo/community/environment/productinfo/safety>.

- Product environmental profile sheet for this and many related HP products.
- HP's commitment to the environment
- HP's environmental management system
- HP's end-of-life product return and recycling program
- Material Safety Data Sheets (MSDS)

Declaration of conformity

Declaration of Conformity

according to ISO/IEC Guide 22 and EN 45014

Manufacturer's Name: Hewlett-Packard Company
Manufacturer's Address: 11311 Chinden Boulevard
Boise, Idaho 83714-1021, USA

declares, that the product

Product Name: HP LaserJet 4250 and LaserJet 4350 printer
Regulatory Model Number³⁾: BOISB-0309-00
Including optional duplex accessory (Q2439B), optional 500-sheet input tray (Q2440B), optional 1500-Sheet Input Tray (Q2440B), and optional 500-sheet stapler/stacker accessory (Q2443B)

Product Options: ALL

conforms to the following Product Specifications:

Safety: IEC 60950:1999 / EN60950: 2000
IEC 60825-1:1993 +A1 +A2 / EN 60825-1:1994 +A11 +A2 (Class 1 Laser/LED Product)
GB4943-2001

EMC: CISPR 22:1997 / EN 55022:1998 Class B¹⁾
EN 61000-3-2:1995 + A14
EN 61000-3-3:1995 + A1
EN 55024:1998
FCC Title 47 CFR, Part 15 Class B²⁾ / ICES-003, Issue 4
GB9254-1998, GB17625.1-1998

Supplementary Information:

The product herewith complies with the requirements of the EMC Directive 89/336/EEC and the Low Voltage Directive 73/23/EEC, and carries the CE-Marking accordingly.

- 1) The product was tested in a typical configuration with Hewlett-Packard Personal Computer Systems.
- 2) This Device complies with Part 15 of the FCC Rules. Operation is subject to the following two conditions: (1) this device may not cause harmful interference, and (2) this device must accept any interference received, including interference that may cause undesired operation.
- 3) For regulatory purposes, this product is assigned a Regulatory model number. This number should not be confused with the marketing name or the product number(s).

Boise, Idaho , USA

March 12, 2004

For regulatory topics only:

Australia Contact: Product Regulations Manager, Hewlett-Packard Australia Ltd., 31-41 Joseph Street Blackburn, Victoria 3130, Australia

European Contact: Your Local Hewlett-Packard Sales and Service Office or Hewlett-Packard GmbH, Department HQ-TRE / Standards Europe, Herrenberger Strasse 140 , D-71034, Böblingen (FAX: +49-7031-14-3143)

USA Contact: Product Regulations Manager, Hewlett-Packard Company, PO Box 15, Mail Stop 160 Boise, ID 83707-0015, (Phone: 208-396-6000)

Country-/region-specific safety statements

Laser safety statement

The Center for Devices and Radiological Health (CDRH) of the U.S. Food and Drug Administration has implemented regulations for laser products manufactured since August 1, 1976. Compliance is mandatory for products marketed in the United States. The printer is certified as a "Class 1" laser product under the U.S. Department of Health and Human Services (DHHS) Radiation Performance Standard according to the Radiation Control for Health and Safety Act of 1968.

Since radiation emitted inside the printer is completely confined within protective housings and external covers, the laser beam cannot escape during any phase of normal user operation.

WARNING!

Using controls, making adjustments, or performing procedures other than those specified in this user guide may result in exposure to hazardous radiation.

Canadian DOC statement

Complies with Canadian EMC Class B requirements.

«Conforme à la classe B des normes canadiennes de compatibilité électromagnétiques (CEM).»

Japanese VCCI statement

この装置は、情報処理装置等電波障害自主規制協議会（VCCI）の基準に基づくクラスB情報技術装置です。この装置は、家庭環境で使用することを目的としていますが、この装置がラジオやテレビジョン受信機に近接して使用されると、受信障害を引き起こすことがあります。
取り扱い説明書に従って正しい取り扱いをして下さい。

Korean EMI statement

사용자 안내문 (B 급 기기)

이 기기는 비업무용으로 전자파장해검정을 받은 기기로서, 주거지역에서는 물론 모든 지역에서 사용할 수 있습니다.

Finnish laser statement

LASERTURVALLISUUS

LUOKAN 1 LASERLAITE

KLASS 1 LASER APPARAT

HP LaserJet 4250, 4250n, 4250tn, 4250dtn, 4250dtnsl, 4350, 4350n, 4350tn, 4350dtn, and 4350dtnsl -laserkirjoitin on käyttäjän kannalta turvallinen luokan 1 laserlaite. Normaalisissa käytössä kirjoittimen suojakoteloointi estää lasersäteen pääsyn laitteen ulkopuolelle.

Laitteen turvallisuusluokka on määritetty standardin EN60825-1 (1994) mukaisesti.

VAROITUS!

Laitteen käyttäminen muulla kuin käyttöohjeessa mainitulla tavalla saattaa altistaa käyttäjän turvallisuusluokan 1 ylittävälle näkymättömälle lasersäteilylle.

WARNING!

Om apparaten används på annat sätt än i bruksanvisning specificerats, kan användaren utsättas för osynlig laserstrålning, som överskrider gränsen för laserklass 1.

HUOLTO

HP LaserJet 4250, 4250n, 4250tn, 4250dtn, 4250dtnsl, 4350, 4350n, 4350tn, 4350dtn, and 4350dtnsl -kirjoittimen sisällä ei ole käyttäjän huollettavissa olevia kohteita. Laitteen saa avata ja huoltaa ainoastaan sen huoltamiseen koulutettu henkilö. Tällaiseksi huoltotoimenpiteeksi ei katsota väriainekasetin vaihtamista, paperiradan puhdistusta tai muita käyttäjän käsikirjassa lueteltuja, käyttäjän tehtäväksi tarkoitettuja ylläpitotoimia, jotka voidaan suorittaa ilman erikoistyökaluja.

VARO!

Mikäli kirjoittimen suojakotelo avataan, olet alttiina näkymättömälle lasersäteilylle laitteen ollessa toiminnassa. Älä katso säteeseen.

WARNING!

Om laserprinterns skyddshölje öppnas då apparaten är i funktion, utsättas användaren för osynlig laserstrålning. Betrakta ej strålen.

Tiedot laitteessa käytettävän laseriodin säteilyominaisuuksista:

Aallonpituus 770-800 nm

Teho 5 mW

Luokan 3B laser



Service and support

Hewlett-Packard limited warranty statement

HP PRODUCT

HP LaserJet 4250, 4250n, 4250tn, 4250dtn, 4250dtnsl, 4350, 4350n, 4350tn, 4350dtn, and 4350dtnsl

DURATION OF LIMITED WARRANTY

One-year limited warranty

HP warrants to you, the end-user customer, that HP hardware and accessories will be free from defects in materials and workmanship after the date of purchase, for the period specified above. If HP receives notice of such defects during the warranty period, HP will, at its option, either repair or replace products which prove to be defective. Replacement products may be either new or equivalent in performance to new.

HP warrants to you that HP software will not fail to execute its programming instructions after the date of purchase, for the period specified above, due to defects in material and workmanship when properly installed and used. If HP receives notice of such defects during the warranty period, HP will replace software which does not execute its programming instructions due to such defects.

HP does not warrant that the operation of HP products will be uninterrupted or error free. If HP is unable, within a reasonable time, to repair or replace any product to a condition as warranted, you will be entitled to a refund of the purchase price upon prompt return of the product.

HP products may contain remanufactured parts equivalent to new in performance or may have been subject to incidental use.

Warranty does not apply to defects resulting from (a) improper or inadequate maintenance or calibration, (b) software, interfacing, parts or supplies not supplied by HP, (c) unauthorized modification or misuse, (d) operation outside of the published environmental specifications for the product, or (e) improper site preparation or maintenance.

TO THE EXTENT ALLOWED BY LOCAL LAW, THE ABOVE WARRANTIES ARE EXCLUSIVE AND NO OTHER WARRANTY OR CONDITION, WHETHER WRITTEN OR ORAL, IS EXPRESSED OR IMPLIED AND HP SPECIFICALLY DISCLAIMS ANY IMPLIED WARRANTIES OR CONDITIONS OF MERCHANTABILITY, SATISFACTORY QUALITY, AND FITNESS FOR A PARTICULAR PURPOSE. Some countries/regions, states or provinces do not allow limitations on the duration of an implied warranty, so the above limitation or exclusion might not apply to you. This warranty gives you specific legal rights and you might also have other rights that vary from country/region to country/region, state to state, or province to province. HP's limited warranty is valid in any country/region or locality where HP has a support presence for this product and where HP has marketed this product. The level of warranty service you receive may vary according to local standards. HP will not alter form, fit or function of the product to make it operate in a country/region for which it was never intended to function for legal or regulatory reasons.

TO THE EXTENT ALLOWED BY LOCAL LAW, THE REMEDIES IN THIS WARRANTY STATEMENT ARE YOUR SOLE AND EXCLUSIVE REMEDIES. EXCEPT AS INDICATED ABOVE, IN NO EVENT WILL HP OR ITS SUPPLIERS BE LIABLE FOR LOSS OF DATA OR FOR DIRECT, SPECIAL, INCIDENTAL, CONSEQUENTIAL (INCLUDING LOST PROFIT OR DATA), OR OTHER DAMAGE, WHETHER BASED IN CONTRACT, TORT, OR OTHERWISE. Some countries/regions, states or provinces do not allow the exclusion or limitation of incidental or consequential damages, so the above limitation or exclusion may not apply to you.

THE WARRANTY TERMS CONTAINED IN THIS STATEMENT, EXCEPT TO THE EXTENT LAWFULLY PERMITTED, DO NOT EXCLUDE, RESTRICT OR MODIFY AND ARE IN ADDITION TO THE MANDATORY STATUTORY RIGHTS APPLICABLE TO THE SALE OF THIS PRODUCT TO YOU.

Print Cartridge Limited Warranty Statement

This HP Print Cartridge is warranted to be free from defects in materials and workmanship.

This warranty does not apply to print cartridges that (a) have been refilled, refurbished, remanufactured or tampered with in any way, (b) experience problems resulting from misuse, improper storage, or operation outside of the published environmental specifications for the printer product or (c) exhibit wear from ordinary use.

To obtain warranty service, please return the product to place of purchase (with a written description of the problem and print samples) or contact HP customer support. At HP's option, HP will either replace products that prove to be defective or refund your purchase price.

TO THE EXTENT ALLOWED BY LOCAL LAW, THE ABOVE WARRANTY IS EXCLUSIVE AND NO OTHER WARRANTY OR CONDITION, WHETHER WRITTEN OR ORAL, IS EXPRESSED OR IMPLIED AND HP SPECIFICALLY DISCLAIMS ANY IMPLIED WARRANTIES OR CONDITIONS OF MERCHANTABILITY, SATISFACTORY QUALITY, AND FITNESS FOR A PARTICULAR PURPOSE.

TO THE EXTENT ALLOWED BY LOCAL LAW, IN NO EVENT WILL HP OR ITS SUPPLIERS BE LIABLE FOR DIRECT, SPECIAL, INCIDENTAL, CONSEQUENTIAL (INCLUDING LOST PROFIT OR DATA), OR OTHER DAMAGE, WHETHER BASED IN CONTRACT, TORT, OR OTHERWISE.

THE WARRANTY TERMS CONTAINED IN THIS STATEMENT, EXCEPT TO THE EXTENT LAWFULLY PERMITTED, DO NOT EXCLUDE, RESTRICT OR MODIFY AND ARE IN ADDITION TO THE MANDATORY STATUTORY RIGHTS APPLICABLE TO THE SALE OF THIS PRODUCT TO YOU.

Availability of support and service

Around the world, HP provides a variety of service and support options for purchase. Availability of these programs will vary depending upon your location.

HP maintenance agreements

HP has several types of maintenance agreements that meet a wide range of support needs. Maintenance agreements are not part of the standard warranty. Support services vary by location. Contact HP Customer Care to determine the services available to you and for more information about maintenance agreements. In general, the printer will have the following maintenance agreements:

Onsite service agreements

To provide you with the level of support best suited to your needs, HP has on-site service agreements with two response times:

Priority Onsite Service

This agreement provides 4-hour service response to your site for calls made during normal HP business hours.

Next-Day Onsite Service

This agreement provides support by the next working day following a service request. Extended coverage hours and extended travel beyond HP's designated service zones are available on most on-site agreements (for additional charges).

HP Express Exchange (U.S. and Canada only)

This service, available for an additional fee, is an alternative to the standard warranty and entails returning your printer for repair. HP Express Exchange allows you to receive a refurbished replacement unit and then return your defective printer. The fast turnaround from HP Express Exchange minimizes downtime over traditional service programs that require you to ship the defective printer to the manufacturer and then wait for the printer to be repaired and returned.

If you choose to use this service, follow the steps listed below. If you have HP on-site support service, you should work directly with the local HP Customer Care center instead of following the steps outlined here.

NOTE

To identify potential support options for this printer, go to <http://www.hpexpress-services.com> and type the printer model number. In North America, additional options might be available through HP Customer Care. Call 1-800-HPINVENT [1-800-474-6836 (U.S.)] or 1-800-268-1221 (Canada).

To use HP Express Exchange

1. Call the HP Customer Care Center for the U.S. or Canada. A technician troubleshoots the situation and determines whether the printer has actually failed. If so, the technician refers the customer to the HP Service Center.
2. A representative from the service center requests product and customer information. In some cases, collateral might also be requested.
3. Before agreeing to use this service, check with the representative for information about returning your defective printer.
4. HP ships a refurbished replacement unit to arrive the next day. (Geographic distance might prevent next-day shipping.)

Exchanged units carry the remainder of the original unit's warranty or 90 days, whichever is greater.

Repacking the printer

If HP Customer Care determines that your printer needs to be returned to HP for repair, follow the steps below to repack the printer before shipping it.

CAUTION

Shipping damage as a result of inadequate packing is the customer's responsibility.

To repack the printer

1. Remove and retain any DIMMs or CompactFlash cards that you have purchased and installed in the printer. Do not remove the DIMM that came with the printer.

CAUTION

Static electricity can damage DIMMs. When handling DIMMs, either wear an antistatic wrist strap, or frequently touch the surface of the DIMM antistatic package and then touch bare metal on the printer. To remove the DIMMs, see [Printer memory](#).

2. Remove and retain the print cartridge.

CAUTION

It is **extremely important** to remove the print cartridge before shipping the printer. A print cartridge that is left in the printer during shipping will leak and entirely cover the printer engine and other parts with toner.

To prevent damage to the print cartridge, avoid touching the roller on it, and store the print cartridge in its original packing material or so that it is not exposed to light.

3. Remove and retain the power cable, interface cable, and optional accessories.
4. If possible, include print samples and 50 to 100 sheets of paper or other print media that did not print correctly.
5. Include a completed copy of the [Service information form](#).
6. In the U.S., call HP Customer Care to request new packing material. In other areas, use the original packing material, if possible. Hewlett-Packard recommends insuring the equipment for shipment.

Service information form

WHO IS RETURNING THE EQUIPMENT?		Date:
Person to contact:		Phone:
Alternate contact:		Phone:
Return shipping address:	Special shipping instructions:	
WHAT ARE YOU SENDING?		
Model name:	Model number:	Serial number:
Please attach any relevant printouts. Do NOT ship accessories (manuals, cleaning supplies, etc.) that are not required to complete the repair.		
HAVE YOU REMOVED THE PRINT CARTRIDGE?		
You must remove the print cartridge before shipping the printer, unless a mechanical problem prevents you from doing so.		
<input type="checkbox"/> Yes.	<input type="checkbox"/> No, I cannot remove it.	
WHAT NEEDS TO BE DONE? (Attach a separate sheet if necessary.)		
1. Describe the conditions of the failure. (What was the failure? What were you doing when the failure occurred? What software were you running? Is the failure repeatable?)		
2. If the failure is intermittent, how much time elapses between failures?		
3. If the unit connected to any of the following, give the manufacturer and model number.		
Personal computer:	Modem:	Network:
4. Additional comments:		
HOW WILL YOU PAY FOR THE REPAIR?		
<input type="checkbox"/> Under warranty	Purchase/received date:	
(Attach proof of purchase or receiving document with original received date.)		
<input type="checkbox"/> Maintenance contract number:		
<input type="checkbox"/> Purchase order number:		
Except for contract and warranty service, a purchase order number and/or authorized signature must accompany any request for service. If standard repair prices do not apply, a minimum purchase order is required. Standard repair prices can be obtained by contacting an HP-authorized repair center.		
Authorized signature:		Phone:
Billing address:	Special billing instructions:	

Index

Symbols/Numerics

- 1,500-sheet tray
 - loading 53
 - paper jams 139
 - printing from 222
 - registration settings 217
 - troubleshooting 126
 - 1200 dpi resolution 219
 - 300 dpi resolution 219
 - 500-sheet tray
 - custom-size settings 214
 - loading 51
 - paper jams 138
 - printing from 222
 - registration settings 217
 - settings 211
 - troubleshooting 126
 - 600 dpi resolution 219
- ## A
- A4 paper settings 214
 - accessibility 7
 - accessories
 - lights 10, 169
 - locating 8
 - locking and unlocking 11
 - moving 11
 - ordering 196
 - part numbers 198
 - troubleshooting 126, 171
 - Accessory installation guides 2
 - acoustic emissions specifications 234
 - address, displaying printer 16
 - address, printer
 - Macintosh, troubleshooting 185, 188
 - adhesive labels. *See* labels
 - agreements, maintenance 272
 - Alerts tab, HP Toolbox 96
 - alerts, e-mail 101
 - anticounterfeit website 109
 - Apple Macintosh. *See* Macintosh
 - AppleTalk setting 226
 - Attention light 14
 - Auto Cleaning Page 114, 220
 - auto continue setting 21, 223

B

- background printing, troubleshooting 186
- batch installation, driver 100
- battery specifications 264
- bidirectional communication settings 225
- binding edge settings 73
- bins
 - paper curl, troubleshooting 128
- bins, output
 - jams, clearing 141
 - locating 8
 - paper path test 228
 - selecting 56
 - settings 214
- blank pages, troubleshooting 129
- blinking lights 13
- blurred print, troubleshooting 181
- both sides, printing on
 - layout options 73
 - loading paper 72
 - loading paper for stapling 58
 - manually 74
 - paper sizes supported 71
 - troubleshooting 129
 - usage page 208
 - using duplexer 71, 73
- browser requirements
 - embedded Web server 90
 - HP Toolbox 94
- browsers supported
 - HP Web Jetadmin 93
- buttons, control panel 13

C

- cables
 - troubleshooting 122
- cables,
 - part numbers 200
- canceling print jobs 75
- capacities, trays 5, 38
- capacity
 - 1,500-sheet tray 39
 - 500-sheet tray 39
 - envelope feeder 40
 - stapler/stacker 40
 - tray 1 38

- card stock
 - fuser modes 218
 - output bin, selecting 56
 - printing on 68
- carriage returns, settings 216
- cartridges
 - Economode 81
 - features 7
 - life expectancy 110
 - low 22
 - low toner message 110
 - non-HP 109
 - ordering iii
 - out 23
 - out of toner message 111
 - part numbers 199
 - recycling 263
 - status information 109
 - status, viewing with embedded Web server 91
 - status, viewing with HP Toolbox 95
 - storing 109
 - supplies status page 107
 - supply level, checking 110
- cartridges, print
 - EconoMode 219
 - low 223
 - out 224
 - paper jams 135
- cartridges, staple
 - loading 49
 - settings 225
- characters
 - misformed 178
 - symbol sets 216
- cleaning
 - fuser 113
 - printer 112
 - toner from clothing 113
- cleaning page
 - automatic 114, 220
 - manual 113
- clearable warnings
 - setting display time 21
- clearable warnings setting 21, 223
- clearing jams
 - 1,500-sheet tray 139
 - 500-sheet tray 138
 - duplexer 140
 - envelope feeder 136
 - frequently, troubleshooting 146
 - fuser area 142
 - locations 134
 - output area 141
 - recovery settings 224
 - staple 145
 - top-cover 135
 - tray 1 137
- clock, setting 102
- clothing, cleaning toner from 113
- coated paper 67
- commands
 - escape sequences 254, 255
 - font selection 255, 259
 - PCL 256
 - syntax 254
 - types of 253
- communications settings 225
- CompactFlash card
 - locating 9
- CompactFlash cards
 - accessing 8
 - installing 246
 - types available 242
 - verifying installation 249
- configuration page
 - troubleshooting 121
- configuration page, printing 105
- configuration, driver 99
- configurations, printer 3
- Configure Device menu 213
- consumables
 - recycling 263
- contracts, maintenance 272
- control panel
 - buttons 13
 - clearable warning settings 21, 223
 - Configure Device menu 213
 - date/time settings 221
 - Diagnostics menu 228
 - error messages 148
 - help 14
 - I/O menu 225
 - Information menu 208
 - language, selecting 24, 120, 224
 - lights 13
 - locating 8, 12
 - menu map, printing 14, 105
 - online Help 148
 - Paper Handling menu 209
 - print cartridge supply level, checking 110
 - Print Quality menu 216
 - Printing menu 213
 - Resets menu 226
 - Retrieve Job menu 206
 - settings 15
 - Stapler/stacker menu 224
 - stapler/stacker, selecting 48
 - System Setup menu 220
 - troubleshooting 120
- copies
 - setting default number 213
- counterfeit supplies 109
- counts, page 106

- Courier font
 - settings 215
- covers
 - first page, different paper 83
- creased paper, troubleshooting 179
- crooked pages 178
- curled paper, troubleshooting 179
- custom-size paper
 - 500-sheet tray specifications 39, 41
 - printing on 68
 - settings 80, 212
 - tray 1 specifications 38
 - tray settings 69, 214
 - tray specifications 38
- customer support
 - embedded Web server links 92
 - HP Express Exchange 273
 - HP Instant Support Professional Edition (ISPE) iii
 - Macintosh iv
 - maintenance agreements 272
 - online iii
 - repacking printer 274
 - service dealers iv
 - service information form 275
 - telephone iii
- customization utility 100

D

- darkness, setting 220
- Data light 14
- data transmission settings 225
- date settings 221
- date, setting 102
- declaration of conformity 266
- default settings
 - drivers, changing 76
- default settings, restoring 226
- density, troubleshooting 174
- Desktop Printer Utility, troubleshooting 185
- Device Settings window, HP Toolbox 96
- Diagnostics menu 228
- dimensions, printer 231
- DIMMs
 - accessing 8
 - installing 243
 - locating 9
 - part numbers 199
 - types available 242
 - verifying installation 249
- disk
 - EIO slots 242
 - file directory, printing 208
 - font list, printing 107
 - installing 251
 - locating 9
 - removing 251
 - troubleshooting 193

- DLC/LLC setting 226
- documentation 2
- Documentation tab, HP Toolbox 96
- dots, troubleshooting 174, 180
- double-sided printing
 - layout options 73
 - loading paper 72
 - loading paper for stapling 58
 - manual 74
 - paper sizes supported 71
 - troubleshooting 129
 - usage page 208
 - using duplexer 71, 73
- downloading software iii
- draft printing 81
- draft quality printing 219
- drivers
 - configuring 99
 - default settings, changing 76
 - downloading iii
 - help 28
 - Linux 27
 - Macintosh iv
 - Macintosh, troubleshooting 187
 - operating systems supported 27
 - OS/2 27
 - selecting 28
 - settings 15, 28, 76
- dropouts, troubleshooting 175
- drum life out message 111
- duplex printing accessory
 - binding options 73
 - jams 140
 - locating 9
 - models including 3, 5
 - paper orientation 72
 - paper path test 228
 - paper sizes supported 71
 - paper specifications 40
 - part number 198
 - settings 214
 - stapling paper 58
 - usage page 208
 - using 71, 73
- duplexing
 - troubleshooting 129

E

- e-mail alerts 96, 101
- Economode 81
- EconoMode setting 219
- EIO cards
 - installing 251
 - locating 9
 - part numbers 200

- removing 251
- settings 225
- slots 242
- Elo cards
 - part numbers 200
- electrical specifications 233
- embedded Web server
 - e-mail alerts 101
 - features 90
 - Information tab 91
 - Networking tab 92
 - opening 90
 - Other Links tab 92
 - print cartridge supply level, checking 110
 - Settings tab 91
 - system requirements 90
- energy consumption 263
- energy specifications 233
- ENERGY STAR
 - compliance 263
- energy use 7
- enlarging documents 82
- envelope feeder
 - capacity 5
 - envelope specifications 40
 - installing 60
 - loading 60, 62
 - locating 9
 - paper jams 136
 - part number 198
 - removing 61
 - settings 46, 209
 - specifications 59
- envelopes
 - default size, setting 214
 - margins 59, 238
 - output bin, selecting 56
 - printing from envelope feeder 60, 62
 - printing from tray 1 59
 - specifications 38, 237
 - storing 238
 - wrinkled, troubleshooting 180
- environment, specifications 235
- environmental
 - features 263
- EPS files, troubleshooting 186, 189
- error messages
 - event log 228
 - event log, printing 106
 - settings 21, 223
 - Windows 184
- error messages, troubleshooting 148
- escape characters 254
- Ethernet cards, part numbers 200
- event log 106, 228

- Explorer, versions supported
 - embedded Web server 90
 - HP Toolbox 94
 - HP Web Jetadmin 93
- Express Exchange, HP 273
- Extended Service iv
- extended warranty 272

F

- factory defaults, restoring 226
- FastRes 5, 81
- FastRes resolution;draft quality printing 219
- FCC statements 262
- features
 - printer 3
 - specifications 5
- feed rollers, replacing 115
- feeder units
 - moving 11
- file directory, printing 208
- flashing lights 13
- Flip Pages Up binding option 73
- fonts
 - EPS files, troubleshooting 186, 189
 - included 6
 - list, printing 208
 - lists, printing 107
 - Macintosh, troubleshooting 186
 - PCL commands 255, 259
 - permanent resources 250
 - settings 216
 - troubleshooting 191
- form lines, settings;vertical line spacing settings;line spacing settings 216
- fuser
 - cleaning 113
 - modes 218
 - paper jams 142
 - replacing 115
- fuser modes 47

G

- General Protection FaultException OE 184
- Getting started guide 2
- gray background, troubleshooting 176
- guides, documentation 2

H

- heavy paper
 - fuser modes 218
 - output bin, selecting 56
 - printing on 68

- held jobs
 - memory requirements 84
 - private 86
 - proof-and-hold 85
 - Retrieve Job control panel menu 206
 - settings 15, 221
- Help 148
- help
 - control panel 14
 - drivers 28
- HP Express Exchange 273
- HP Instant Support Professional Edition (ISPE) iii
- HP Jetdirect print server
 - configuration page, printing 105
 - installing 251
 - locating 9
 - models including 3
 - part numbers 200
 - removing 251
 - settings 226
- HP Jetlink port 6
- HP LaserJet Utility, Macintosh 30
- HP media, ordering 200
- HP OpenVMS drivers 27
- HP Printing Supplies Returns and Recycling Program 263
- HP SupportPack 272
- HP Toolbox
 - Alerts tab 96
 - Device Settings window 96
 - Documentation tab 96
 - features 94
 - links 97
 - opening 95
 - print cartridge supply level, checking 110
 - Status tab 95
 - Troubleshooting tab 95
 - uninstalling 98
- HP Web Jetadmin
 - browsers supported 93
 - downloading 93
 - driver configuration 99
 - e-mail alerts 101
- HP-Authorized Dealers iv
- HP-GL/2 commands 253
- humidity requirements 235

I

- I/O menu 225
- IBM OS/2 drivers 27
- Illegal Operation errors 184
- image reptition, troubleshooting 182
- Information menu 208
- information pages, printing 105
- Information tab, embedded Web server 91

- input trays
 - configuring 17
- Install notes 96
- installing
 - CompactFlash cards 246
 - drivers using customization utility 100
 - EIO cards 251
 - envelope feeder 60
 - Macintosh software 34
 - memory (DIMMs) 243
 - network software, Macintosh 33
 - network software, Windows 32
 - Windows printing system 31
 - Windows software using New Hardware Found wizard 35
- interface cables, troubleshooting 122
- Internet Explorer, versions supported
 - embedded Web server 90
 - HP Toolbox 94
 - HP Web Jetadmin 93
- IP address
 - Macintosh, troubleshooting 185, 188
- IP address, displaying 16
- ISPE (HP Instant Support Professional Edition) iii

J

- jams
 - 1,500-sheet tray 139
 - 500-sheet tray 138
 - duplexer 140
 - envelope feeder 136
 - first sheet, troubleshooting 128
 - frequent 146
 - fuser area 142
 - locations 134
 - output bin 141
 - recovery setting 23, 224
 - staple 145
 - top-cover 135
 - tray 1 137
- Jet direct print server
 - configuration page, printing 105
- Jetadmin
 - browsers supported 93
 - downloading 93
 - driver configuration 99
 - e-mail alerts 101
- Jetdirect print server
 - installing 251
 - locating 9
 - models including 3
 - part numbers 200
 - removing 251
 - settings 226
- Jetlink port 6
- job held timeout 16
- job storage limit 15

- jobs
 - formatted incorrectly 125
 - not printing, troubleshooting 122
 - private 86
 - proof-and-hold 85
 - retention 221
 - Retrieve Job menu 206
 - stopped, troubleshooting 124
 - storing, memory requirements 84

K

- keys, control panel 13
- kit, maintenance
 - part number 199
- kit, printer maintenance
 - message, clearing 227
 - using 115

L

- labels
 - fuser modes 218
 - output bin, selecting 56
 - printing 64
 - specifications 239
- landscape orientation
 - duplexing options 73
 - PCL commands 257
- language, control panel 24, 120, 224
- languages, printer
 - included 6
 - settings 20, 223
 - switching, PCL commands 258
- laser safety statements 267
- LaserJet Utility, Macintosh 30
- last page, different paper 83
- legal paper, clipped margins 191
- letter paper, override A4 settings 214
- letterhead
 - fuser modes 218
 - printing on 65
- light print
 - setting toner density 220
 - troubleshooting 174
- lights
 - accessories 10, 169
- lights, control panel 13
- Limit Check error 191
- line feed settings 216
- lines, troubleshooting 175, 218
- links
 - embedded Web server 92
 - HP Toolbox 97
- Linux driver support 27
- loading
 - 1,500-sheet tray 53
 - 500-sheet tray 51
 - coated paper 67

- custom-size paper 68
- envelope feeder 60, 62
- envelopes in tray 1 59
- labels 64
- paper for duplexing 72
- preprinted paper 65
- stapler/stacker paper 58
- staples 49
- transparencies 65
- tray 1 50

locking

- accessories 11
- trays 45
- locking driver features 99
- loose toner, troubleshooting 177
- low toner 22, 223
- low toner message 110
- LPT error messages 184

M

- Macintosh
 - AppleTalk settings 226
 - background printing 186
 - default driver settings, changing 78
 - driver settings 76
 - drivers supported 27
 - drivers, troubleshooting 187
 - fonts, troubleshooting 186
 - HP LaserJet Utility 30
 - installing software 34
 - network installation 33
 - operating systems supported 26
 - PPDs 30
 - problems, troubleshooting 185
 - software included 30
 - support Web sites iv
 - uninstalling software 36
 - USB card, troubleshooting 186, 189
- maintenance
 - agreements 272
- maintenance agreements iv
- maintenance kit
 - message, clearing 227
 - part number 199
 - using 115
- manual feed
 - printing to tray 1 46
 - settings 18, 214, 222
- manuals 2, 96
- map, menu 14, 105
- margins
 - envelopes 59, 238
 - legal paper, troubleshooting 191
 - PCL commands 257
 - registration settings 217

- media
 - capacity 5
 - covers 83
 - curl, troubleshooting 128
 - custom-size 80
 - custom-size, printing 68, 69
 - duplexing, sizes supported 71
 - fuser modes 47
 - HP, ordering 200
 - manual feed 46
 - PCL commands 256
 - preprinted 65
 - prepunched 65
 - printing multiple pages on single sheet 80
 - PS settings 19
 - sizes supported 38
 - small 69
 - source, selecting 82
 - specifications 37, 236
 - stapling 48
 - storing 236
 - tray selection 17, 44, 45
 - tray settings 209
 - troubleshooting 132
 - troubleshooting trays 128
 - usage page 208
 - memory
 - configuration page 106
 - included 6
 - installing DIMMs 243
 - job-storage requirements 84
 - locating 9
 - part numbers 199
 - permanent resources 250
 - RAM disk settings 24
 - upgrading 242
 - verifying installation 249
 - menus, control panel
 - accessing 13
 - Configure Device 213
 - Diagnostics 228
 - I/O 225
 - Information 208
 - map, printing 14, 105
 - Paper Handling 209
 - Print Quality 216
 - Printing 213
 - Resets 226
 - Retrieve Job 206
 - Stapler/stacker 224
 - System Setup 220
 - mercury specifications 264
 - messages
 - event log 228
 - event log, printing 106
 - settings 21, 223
 - Windows 184
 - messages, troubleshooting 148
 - Microsoft Windows. See Windows
 - misformed characters, troubleshooting 178
 - model number 106
 - models 3
 - moving the printer 11
 - multiple pages, printing on single sheet 80
- N**
- n-up printing 80
 - narrow paper
 - printing on 69
 - Netscape Navigator, versions supported
 - embedded Web server 90
 - HP Toolbox 94
 - HP Web Jetadmin 93
 - Networking tab, embedded Web server 92
 - networks
 - driver configuration 99
 - installing Macintosh software 33
 - installing Windows software 32
 - settings 226
 - troubleshooting printing 183
 - wireless 6
 - noise specifications 234
 - non-HP print cartridges 109
 - not responding, troubleshooting 130
 - Novell NetWare settings;NetWare settings;IPX/SPX setting 226
 - number of copies, setting default 213
- O**
- on-site service agreements 272
 - on/off switch, locating 8
 - online customer support iii
 - online Help 148
 - online help
 - control panel 14
 - drivers 28
 - OpenVMS drivers 27
 - operating environment specifications 235
 - operating systems supported 26, 27
 - ordering
 - media, HP 200
 - part numbers for 198
 - ordering supplies iii
 - orientation, page
 - duplexing options 73
 - PCL commands 257
 - stapler/stacker 58
 - orientation, setting default;page orientation
 - default;portrait orientation, setting as default;landscape orientation, setting as default 216
 - OS/2 drivers 27
 - Other links
 - embedded Web server 92
 - HP Toolbox 97

- out of toner 23, 224
- out of toner message 111
- output bins
 - paper jams 141
 - settings 214
- output quality
 - settings 219
 - troubleshooting 172
- override A4/letter 214
- ozone specifications 263

P

- packaging printer 274
- page counts 106
- page orientation
 - duplexing options 73
 - PCL commands 257
 - stapler/stacker 58
- pages per minute 5
- pages per sheet 80
- paper
 - 1,500-sheet tray specifications 39
 - 500-sheet tray specifications 39
 - capacity 5
 - coated 67
 - covers 83
 - curl, troubleshooting 128
 - curled 179
 - custom-size 80, 214
 - custom-size, printing 68, 69
 - default size, setting 214
 - duplexer specifications 40
 - duplexing, sizes supported 71
 - fuser modes 47, 218
 - HP, ordering 200
 - loading 1,500-sheet tray 53
 - loading 500-sheet tray 51
 - loading tray 1 50
 - manual feed 46
 - override A4/letter setting 214
 - PCL commands 256
 - preprinted 65
 - prepunched 65
 - printing multiple pages on single sheet 80
 - PS settings 19
 - sizes supported 38
 - small 69
 - source, selecting 82
 - specifications 37, 236
 - stapler/stacker specifications 40
 - stapling 48
 - storing 236
 - tray selection 17, 44, 45, 210, 222
 - tray settings 209
 - troubleshooting 132
 - troubleshooting trays 128
 - usage page 208
 - wrinkled 179
- paper handling accessories
 - lights 169
 - troubleshooting 126
- Paper Handling menu 209
- paper jams
 - 1,500-sheet tray 139
 - 500-sheet tray 138
 - duplexer 140
 - envelope feeder 136
 - fuser area 142
 - locations 134
 - output bin 141
 - recovery settings 224
 - top-cover 135
 - tray 1 137
- paper path
 - cleaning 114
 - test 228
- parallel cable, part number 200
- parallel cables
 - troubleshooting 122
- parallel communications, settings 225
- parallel port
 - locating 10
 - type included 6
- parallel ports
 - not supported for Macintosh 34
- part numbers
 - cables 200
 - EIO cards 200
 - maintenance kit 199
 - media, HP 200
 - memory 199
 - print cartridges 199
 - trays 198
- parts
 - ordering 196
- PCL commands
 - common 256
 - escape sequences 254, 255
 - font selection 255, 259
 - syntax 254
- PCL drivers
 - features 28
 - operating systems supported 27
 - See *also* drivers
- PCL font list, printing 107, 208
- PCL, setting as printer language 20, 223
- PDEs, Macintosh 30
- percent of normal size 82
- perform printer maintenance message 115, 227
- permanent resources 250

- personalities
 - included 6
 - settings 20, 223
 - switching, PCL commands 258
 - viewing installed 106
- phone numbers
 - ordering supplies iii
 - service agreements iv
 - support iii
- pickup rollers, replacing 115
- PJL (Printer Job Language) commands 253
- platforms supported 26, 27
- portrait orientation
 - duplexing options 73
 - PCL commands 257
- ports
 - included 6
 - locating 10
 - LPT error messages 184
 - troubleshooting Macintosh 186, 189
- postcards
 - output bin, selecting 56
 - printing 68
 - specifications 38
- PostScript error pages
 - settings 215
 - troubleshooting 122
- PostScript Printer Description (PPD) files
 - included 30
 - troubleshooting 185
- PostScript, setting as printer language 20, 223
- power
 - consumption 263
 - specifications 233
- power consumption 7
- power switch, locating 8
- PPDs
 - included 30
 - troubleshooting 185
- preconfiguration, driver 99
- preprinted paper
 - fuser modes 218
 - printing on 65
- prepunched paper
 - fuser modes 218
 - printing on 65
- print cartridges
 - EconoMode 219
 - Economode 81
 - features 7
 - life expectancy 110
 - low 22, 223
 - low toner message 110
 - non-HP 109
 - ordering iii
 - out 23, 224
 - out of toner message 111
 - paper jams 135
 - part numbers 199
 - recycling 263
 - status information 109
 - status, viewing with embedded Web server 91
 - status, viewing with HP Toolbox 95
 - storing 109
 - supplies status page 107
 - supply level, checking 110
- print jobs
 - formatted incorrectly 125
 - not printing, troubleshooting 122
 - retention 15, 221
 - stopped, troubleshooting 124
- print quality
 - settings 81, 219
 - troubleshooting 172
- Print Quality menu 216
- print quality, troubleshooting
 - repetitive images 182
- printer commands
 - escape sequences 254, 255
 - font selection 255, 259
 - PCL 256
 - syntax 254
 - types of 253
- Printer Dialog Extensions (PDEs), Macintosh 30
- printer drivers. *See* drivers
- printer language
 - switching, PCL commands 258
- printer languages
 - included 6
- printer maintenance kit
 - message, clearing 227
 - part number 199
 - using 115
- printerlanguages
 - viewing installed 106
- Printing menu 213
- private jobs 86
- processor speed 6
- proof-and-hold jobs 85
- ProRes 5, 81
- ProRes resolution 219
- PS Defer Media setting 19
- PS driver
 - features 28
 - operating system supported 27
 - See also* drivers
- PS error pages
 - settings 215
 - troubleshooting 122
- PS font list, printing 107, 208
- PS, setting as printer language 20, 223
- punched paper
 - fuser modes 218
 - printing on 65

Q

- quality
 - settings 219
 - troubleshooting 172
- quick copy jobs
 - settings 15, 221

R

- RAM disk
 - settings 224
- RAM disk settings 24
- Range Check, troubleshooting 192
- Ready light 13
- rear output bin
 - locating 8
 - paper jams 141
 - printing to 56
 - settings 214
 - using with duplexer 71
- recovery, jam 23, 224
- recycling
 - plastics 263
 - print cartridges 263
- reduce/enlarge options 82
- reference materials 2
- registration settings 217
- regulatory statements
 - Canadian DOC statement 267
 - declaration of conformity 266
 - FCC 262
 - Finnish laser statement 268
 - Japanese VCCI statement 267
 - Korean EMI statement 267
 - laser safety 267
- removing software
 - HP Toolbox 98
 - Macintosh 36
 - Windows 36
- repacking printer 274
- repeating defects, troubleshooting; defects, repeating 177
- repetitive defects
 - images 182
- Resets menu 226
- resizing documents 82
- resolution
 - features 5
 - settings 81, 219
 - troubleshooting quality 172
- resource saving 250
- restoring default settings 226
- REt setting; Resolution Enhancement technology (REt) setting 219

- retention, job
 - memory requirements 84
 - private 86
 - proof-and-hold 85
 - Retrieve Job menu 206
 - settings 15, 221
- Retrieve Job menu 206
- right-side panel, locating 8
- rollers, replacing 115
- rough paper
 - fuser modes 218
 - output bin, selecting 56

S

- saving resources, memory 250
- scaling documents 82
- security
 - settings 106
- serial cables, troubleshooting 122
- serial number 106
- service
 - agreements iv, 272
 - HP Express Exchange 273
 - HP-authorized dealers iv
 - information form 275
 - repacking printer 274
- settings
 - configuration page, printing 105
 - control panel 15
 - defaults, changing 76
 - driver 76
 - driver configuration 99
 - drivers 28
 - locking 99
 - restoring defaults 226
- Settings tab, embedded Web server 91
- shipping printer 274
- silent installation, driver 100
- SIMMs, incompatibility 242
- size, paper
 - 1,500-sheet tray specifications 39
 - 500-sheet tray specifications 39
 - duplexer specifications 40
 - envelope feeder specifications 40
 - printing small or custom 68
 - stapler/stacker specifications 40
 - tray 1 specifications 38
 - tray selection 44, 45
- size, printer 231
- Size/type prompt setting 19
- skewed pages 178
- Sleep mode
 - delay, setting 19
 - power specifications 233
 - turning on or off 20
- sleep mode 227
- slow printing, troubleshooting 124, 129

- small paper
 - printing on 69
- small paper, printing on 56
- smearred toner, troubleshooting 176
- software
 - downloading iii
 - HP Toolbox 94
 - installing Macintosh 34
 - installing on Windows 31
 - installing using New Hardware Found wizard 35
 - Linux 27
 - Macintosh iv
 - macintosh 30
 - Macintosh, included 30
 - network installation, Macintosh 33
 - network installation, Windows 32
 - operating systems supported 26
 - settings 15
 - uninstalling from Macintosh 36
 - uninstalling from Windows 36
- source, paper 82
- specifications
 - accessibility 7
 - acoustic emissions 234
 - electrical 233
 - energy use 7
 - envelopes 237
 - labels 239
 - media 37
 - memory 6
 - operating environment 235
 - paper 236
 - printer features 5
 - printer size 231
 - speed 5
 - transparencies 239
 - trays 5
- specifications, paper
 - 1,500-sheet tray 39
 - envelope feeder 40
- specks, troubleshooting 174, 180
- speed
 - data transmission settings 225
 - processor 6
 - resolution settings 219
 - specifications 5
 - troubleshooting 124, 129
- Spool32 errors 184
- spots, troubleshooting 174, 180
- stacker
 - capacity 5
 - light status 10, 169
 - locating 9
 - moving 11
 - paper specifications 40
 - part number 198
 - printing to 48, 57
- staple cartridges
 - loading 49
 - part numbers 198
- staple jams 145
- stapler unit
 - replacing 116
- stapler/stacker
 - capacity 5
 - default, setting as 48
 - jams, staple 145
 - light status 10, 169
 - loading paper 58
 - loading staples 49
 - locating 9
 - models including 3
 - moving 11
 - paper specifications 40
 - paper-path test 228
 - part number 198
 - printing to 48, 57
 - settings 224
- Stapler/stacker menu 224
- stapling documents 48
- status
 - alerts, e-mail 101
 - e-mail alerts 96
 - Information tab, embedded Web server 91
 - lights 169
 - lights, control panel 13
 - supplies 107
 - supplies page, printing 208
 - viewing with HP Toolbox 95
- Status tab, HP Toolbox 95
- stopped printing, troubleshooting 124
- stopping print jobs 75
- storage cabinet
 - locating 9
 - moving 11
 - part number 198
- storage, job
 - memory requirements 84
 - private 86
 - proof-and-hold 85
 - quick copy 84
 - Retrieve Job menu 206
 - settings 15, 221
- storing
 - envelopes 238
 - paper 236
- storing print cartridges 109
- straight-through paper path 56
- supplies
 - non-HP 109
 - ordering iii, 196
 - part numbers 198, 199
 - recycling 263
 - status page 107

- status page, printing 208
- status, viewing with embedded Web server 91
- status, viewing with HP Toolbox 95
- supply level, print cartridges 110
- support
 - embedded Web server links 92
 - HP Express Exchange 273
 - HP Instant Support Professional Edition (ISPE) iii
 - Macintosh iv
 - maintenance agreements 272
 - online iii
 - repacking printer 274
 - service dealers iv
 - service information form 275
 - telephone iii
- SupportPack, HP 272
- symbol sets, selecting 216
- syntax, PCL commands 254
- system requirements
 - drivers 27
 - embedded Web server 90
 - HP Toolbox 94
 - HP Web Jetadmin 93
 - printing software 26
- System Setup menu 220

T

- technical support
 - embedded Web server links 92
 - HP Express Exchange 273
 - HP Instant Support Professional Edition (ISPE) iii
 - Macintosh iv
 - maintenance agreements 272
 - online iii
 - repacking printer 274
 - service dealers iv
 - service information form 275
 - telephone iii
- telephone numbers
 - ordering supplies iii
 - service agreements iv
 - support iii
- temperature requirements 235
- tests 228
- text quality, troubleshooting 178, 181
- text, troubleshooting
 - garbled 130
- three-hole punched paper
 - fuser modes 218
 - printing on 65
- time settings 221
- time, setting 102
- timeout settings
 - held jobs 16
 - Sleep mode 19
- timeouts, I/O settings 225
- tire tracks, troubleshooting 180

- toner
 - cleaning from clothing 113
 - density setting 220
 - EconoMode 219
 - low 22, 223
 - out 223
 - out of 23
 - output quality, troubleshooting 176
- toner cartridges. See print cartridges
- toner, saving 81
- Toolbox
 - Alerts tab 96
 - Device Settings window 96
 - Documentation tab 96
 - features 94
 - links 97
 - opening 95
 - Status tab 95
 - Troubleshooting tab 95
 - uninstalling 98
- top cover
 - paper jams, clearing 135
- top output bin
 - locating 8
 - paper jams 141
 - printing to 56
 - settings 214
- transfer rollers, replacing 115
- transparencies
 - fuser modes 218
 - HP, ordering 203
 - output bin 56
 - printing 65
 - specifications 239
- tray 1
 - custom-size paper settings 69
 - custom-size settings 214
 - duplexing 72
 - duplexing manually 74
 - envelopes, printing 59
 - loading 50, 58
 - locating 8
 - locking 45
 - manual feed 46
 - manual feed settings 18
 - paper jams 137
 - paper supported 38
 - printing from 17, 44, 222
 - registration settings 217
 - setting size 210
 - settings 209
 - troubleshooting 126
- trays
 - capacities 5
 - custom-size paper settings 69
 - custom-size settings 214
 - duplexing 72

- duplexing manually 74
- included 3
- loading 1,500-sheet tray 53
- loading 500-sheet tray 51
- loading tray 1 50
- locating 8, 9
- locking 45
- manual feed 46
- moving 11
- paper jams 134, 137, 138, 139
- paper path test 228
- paper specifications 39
- part numbers 198
- PCL commands 256
- registration settings 217
- selecting 17, 44, 82, 222
- settings 209
- settings, viewing 106
- troubleshooting 126, 128
- troubleshooting
 - 1,500-sheet tray paper jams 139
 - 500-sheet tray paper jams 138
 - accessories 169, 171
 - blank pages 129
 - blurred print 181
 - cables 122
 - configuration page printing 121
 - control panel display 120
 - curled paper 128, 179
 - dropouts 175
 - duplexer jams 140
 - duplexing 129
 - envelope feeder jams 136
 - EPS files 186, 189
 - error messages 148
 - event log 228
 - fonts 191
 - fuser-area paper jams 142
 - gray background 176
 - hard disk accessory 193
 - information pages 105
 - jams, first sheet 128
 - legal paper 191
 - light print 174
 - Limit Check error 191
 - lines 175, 180, 218
 - Macintosh problems 185
 - network printing 183
 - online Help 148
 - output bin jams 141
 - output quality 172
 - paper 132
 - paper jams 134, 146
 - PostScript problems 191
 - printing 122, 124, 130
 - PS errors 122
 - Range Check 192
 - repeating defects 177
 - repetitive images 182
 - skewed pages 178
 - slow printing 124, 129
 - smeared toner 176
 - specks 174
 - staple jams 145
 - text 130
 - text quality 178, 181
 - tire tracks 180
 - top-cover paper jams 134
 - tray 1 paper jams 137
 - tray selection 126
 - trays 128
 - VM error 192
 - white spots 180
 - Windows error messages 184
 - wrinkled paper 179
- Troubleshooting tab, HP Toolbox 95
- two-sided printing
 - layout options 73
 - loading paper 72
 - loading paper for stapling 58
 - manual 74
 - paper sizes supported 71
 - troubleshooting 129
 - usage page 208
 - using duplexer 71, 73

U

- uninstalling
 - HP Toolbox 98
- UNIX
 - carriage return settings 216
 - Model Scripts 27
- unlocking accessories 11
- upgrading memory 242
- usage page 208
- USB cable, part number 200
- USB port
 - locating 10
 - troubleshooting Macintosh 186, 189
 - type included 6
- user guide 96

V

- VM error 192
- voltage specifications 233

W

- warnings setting 21, 223
- warranty
 - extended iv, 272
 - print cartridge 271
 - product 269
- watermarks, printing 79
- wave, troubleshooting 128

- wavy paper, troubleshooting 179
- Web browser requirements
 - embedded Web server 90
 - HP Toolbox 94
- Web Jetadmin
 - browsers supported 93
 - downloading 93
 - driver configuration 99
 - e-mail alerts 101
- Web sites
 - customer support iii
 - downloading software iii
 - HP Web Jetadmin, downloading 93
 - Macintosh support iv
 - ordering supplies iii
 - paper specifications 236
 - service agreements iv
 - UNIX and Linux drivers 27
- websites
 - anticounterfeit 109
- weight, paper
 - printing on heavy media 68
 - stapling documents 48
- weight, paper specifications
 - 1,500-sheet tray 39
 - 500-sheet tray 39
 - duplexer 40
 - envelope feeder 40
 - stapler/stacker 40
 - tray 1 38
- weight, printer 231
- white lines or spots, troubleshooting;lines, troubleshooting 180
- Wide A4 settings 215
- Windows
 - default driver settings, changing 76
 - driver settings 76
 - drivers supported 27
 - error messages, troubleshooting 184
 - installing software 31
 - installing using New Hardware Found wizard 35
 - network installation 32
 - uninstalling software 36
 - versions supported 26
- wireless network cards 6
- wrinkled paper, troubleshooting 179
- wrong printer, sending to 186



© 2004 Hewlett-Packard Development Company, L.P.

www.hp.com/support/lj4250

www.hp.com/support/lj4350



Q5400-90933