

HP LaserJet 9040/9050

User Guide

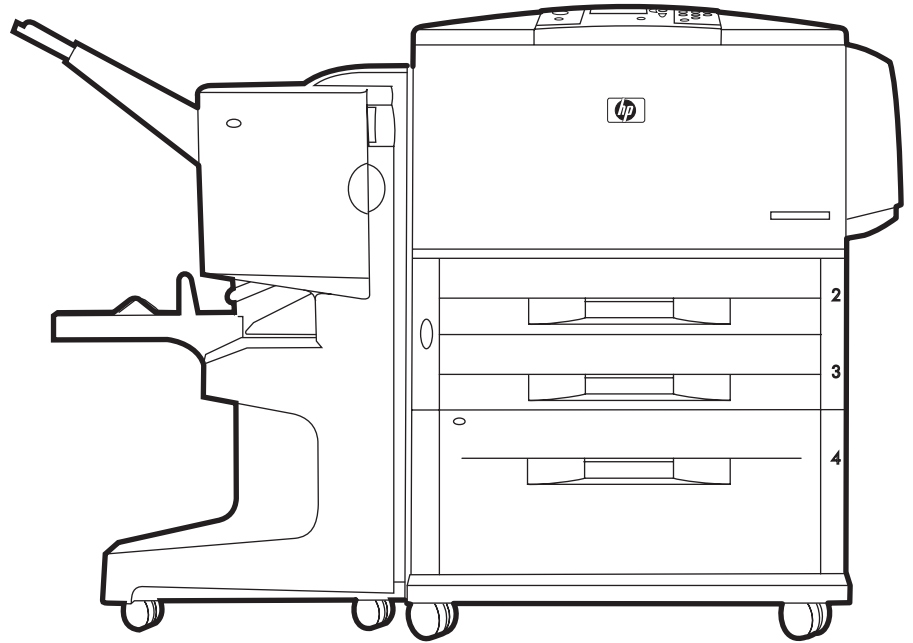

hp LaserJet 9040/9050 series printers

User Guide

Copyright and License

© 2005 Copyright Hewlett-Packard Development Company, L.P.

Reproduction, adaptation or translation without prior written permission is prohibited, except as allowed under the copyright laws.

The information contained herein is subject to change without notice.

The only warranties for HP products and services are set forth in the express warranty statements accompanying such products and services. Nothing herein should be construed as constituting an additional warranty. HP shall not be liable for technical or editorial errors or omissions contained herein.

Publication number: Q3721-90940

Edition 1, 02/2005

Trademark Credits

Adobe, Acrobat, and PostScript are trademarks of Adobe Systems Incorporated.

ENERGY STAR[®] is a U.S. registered mark.

HP-UX Release 10.20 and HP-UX Release 11.00 and later on all HP 9000 computers are Open Group UNIX products,

Linux is a U.S. registered trademark of Linus Torvalds.

Microsoft, Windows and Windows NT are U.S. registered trademarks of Microsoft Corporation.

UNIX is a registered trademark of The Open Group.

Contents

1 Printer basics

Features and benefits of the printer	7
Parts or accessories	10
External view of printer and accessories	14
Layout and basic operation of the control panel	15
Interpreting control-panel lights	16
Using control-panel menus	16
Paper-handling status LED interpretation	17
Printer software	18
Software features	18
Printer drivers	19
Software for Macintosh computers	22
Installing the printing system software	23
Uninstalling the software	26
Software for networks	27
HP Web Jetadmin	27
Communicating by using an optional HP Jetdirect print server	29
Communicating by using the HP Jetdirect embedded print server	29
Embedded Web server	30
Using the embedded Web server	30
HP Toolbox	31
Supported operating systems	31
To view the HP Toolbox	31
HP Toolbox sections	31
Help system	33

2 Printing tasks

Loading input trays	36
Loading optional Tray 1	36
To load optional Tray 1 when the same paper is used for multiple print jobs	37
Loading Trays 2, 3, and 4	39
Loading custom-size paper in Trays 2, 3, and 4	45
Configuring the trays by using the Paper Handling menu	47
Orienting media	49
Basic printing instructions	54
Selecting the output bin	55
Selecting an output location	56
Printing envelopes	57
Using the optional 3,000-sheet stacker	60
Output features	60
Using the optional stacker/stapler	60
Selecting the stapler	60
Loading staples	61
Using the optional multifunction finisher	63
Output features	63
Using the stapler	63
Loading staples	64
Making booklets	66
Using the optional 8-bin mailbox	68
Output features	68

Printing both sides of paper (duplexing)	68
Printing on special paper	70
Printing on letterhead, prepunched paper, or preprinted paper (single-sided)	70
Printing on letterhead, prepunched paper, or preprinted paper (double-sided)	70
Printing labels	70
Printing on transparencies	71
Guidelines for custom-size paper, card stock, and heavy paper	71
Printing full-bleed images	71

3 Advanced printing tasks

Overview	73
Using features in the printer driver	74
Setting the registration	75
Using a different first page	76
Including a blank back page	77
Printing multiple pages on one sheet of paper	77
Customizing optional Tray 1 operation	78
Printing from optional Tray 1 when the loaded paper is requested	78
Manually feeding paper from optional Tray 1	78
Specifying paper to print on	79
Benefits of printing by type and size of paper	79
Using the job-storage features	80
Printing a private job	80
Releasing private jobs	81
Deleting a private job	81
Storing a print job	81
Printing a stored job	82
Deleting a stored job	82
QuickCopying a job	82
Printing additional copies of QuickCopy jobs	83
Deleting a QuickCopy job	83
Proofing and holding a job	83
Printing the remaining copies of a held job	84
Deleting a held job	84

4 Security features

Overview	85
Secure Disk Erase	86
Affected data	86
Gaining access to Secure Disk Erase	86
Additional information	86
Security lock	87
Job storage features	87

5 Printer maintenance

Overview	89
Cleaning the printer	90
General cleaning	90
Printer maintenance kit	92
To reset the printer maintenance count	92
To print a configuration page	92
Managing the print cartridge	93
Print cartridge authentication	93
Non-HP print cartridges	93
Print cartridge storage	93
Checking the toner level	93
Print cartridge conditions	94

Order the print cartridge	94
Replace the print cartridge	95
Recycling	95
Using the printer cleaning page	95

6 Problem solving

Overview	97
Clearing jams	98
Clearing jams from the input tray areas	99
Clearing jams from the duplex printing accessory (duplexer)	103
Clearing jams from the output areas	105
To clear jams in the 8-bin mailbox	116
Solving repeated paper jams	117
Understanding printer messages	118
Resolving control-panel messages	119
Correcting output quality problems	128
Preventing wrinkles on envelopes	132
Solving common printer issues	133
Using the embedded Web server	142
Home pages	142
Device pages	143
Networking pages	143
Printing information pages	144
Checking the printer configuration	145
Menu map	145
Configuration page	146
Supplies status page	147
Usage page	148
PCL or PS font list	149
Jetdirect page	150
Event log page	151
Printing a paper path test	152

Appendix A Specifications

Overview	153
Paper specifications	156
Supported sizes of paper for input and output	157
Supported types of paper	160
Labels	161
Transparencies	161
Envelopes	161
Card stock and heavy paper	162
Environmental specifications	163
Electrical specifications	163
Acoustical specifications	164
Operating environment	164

Appendix B Control-panel menus

Overview	165
Retrieve job menu	166
Information menu	166
Paper handling menu	167
Configure device menu	168
Printing submenu	168
Print quality submenu	171
System setup submenu	173

I/O submenu	175
Resets submenu	179
Diagnostics menu.	180
Service menu	180

Appendix C Printer memory and expansion

Overview	181
Determining memory requirements	182
Installing memory and fonts	182
To install DDR memory DIMMs	182
To install a flash memory card	185
Checking memory installation	188
Saving resources (permanent resources)	189
Installing EIO cards/mass storage	189

Appendix D Regulatory information

Environmental product stewardship program.	191
Protecting the environment	191
Ozone production	191
Power consumption	191
Toner consumption	191
Paper use	191
Plastics	192
HP LaserJet printing supplies	192
HP printing supplies returns and recycling program information	192
Material restrictions	192
Material safety data sheet	193

Appendix E Using accessibility shortcut keys in the Help Viewer

Using F6 to switch between the Navigation and Topic Panes	195
Shortcut keys for the Help Viewer	195
Shortcut keys for the Contents tab	196
Shortcut keys for the Index tab	196
Shortcut keys for the Search tab	196
Shortcut keys for the Favorites tab	197

Appendix F Using the HTML Help Viewer

Getting more out of help.	199
To find a help topic	199
To create a list of favorite help topics	200
To copy a help topic	200
To print the current help topic	200
To find topics using the toolbar buttons	200
Using the shortcut menu commands	201

1 Printer basics

Congratulations on your purchase of an HP LaserJet 9040/9050 series printer. If you have not done so, see the *Getting Started Guide* that was provided with the printer for setup instructions.

Now that the printer is set up and ready to use, take a few moments to get to know the printer. This chapter introduces the following information about the printer:

- Features and benefits of the printer
- Layout and basic operation of the control panel
- Printer software
- Embedded Web server
- Help system

Features and benefits of the printer

This section lists the major printer features.

Speed and throughput

- Transmit Once, Raster Image Processing (RIP) ONCE technology
- Eight-second standby to first page
- 40 pages per minute (ppm) (HP LaserJet 9040 series printer) or 50 ppm (HP LaserJet 9050 series printer) on letter or ISO A4 paper
- Duty cycle up to 300,000 pages per month
- 533 megahertz (MHz) microprocessor

Resolution

- 600 dots per inch (dpi) with Resolution Enhancement technology (REt)
- FastRes 1200 provides 1200 dpi quality at full speed
- Up to 220 levels of gray

Memory

- 64 megabytes (MB) of random access memory (RAM), expandable to 512 MB using industry standard 100-pin double data rate (DDR) dual in-line memory modules (DIMMs) for the base model HP LaserJet 9040/9050 printer
- 128 MB of RAM, expandable to 512 MB by using industry-standard 100-pin DDR DIMMs for the HP LaserJet 9040n/9050n and the HP LaserJet 9040dn/9050dn printers
- Memory Enhancement technology (MEt), which automatically compresses data to use RAM more efficiently

User interface

- Graphic display on control panel
- Embedded Web server to gain access to support and order supplies (for network-connected printers)
- HP Toolbox software to provide printer status and alerts, configure printer settings, and print internal printer information pages

Language and fonts

- HP Printer Command Language (PCL) 6 driver
- HP PCL 5e driver for compatibility
- Printer Job Language (PJM)
- Printer Management Language
- 80 scalable TrueType typefaces
- HP PostScript 3 emulation (PS)

Print cartridge

- No-shake cartridge design
- Authentication of HP print cartridges
- No-pull tab with automatic seal-tab removal
- Internet-enabled supplies ordering

Paper handling

- **Input**
 - **Optional Tray 1 (multipurpose tray):** A multipurpose tray for paper, transparencies, labels, and envelopes. Holds up to 100 sheets of paper or 10 envelopes.
 - **Trays 2 and 3:** Two 500-sheet trays. These trays automatically sense commonly used standard paper sizes up to A3- or 11 x 17-size media, and can print on custom-size paper.
 - **Optional Tray 4 (2,000-sheet input tray):** This tray automatically senses commonly used standard paper sizes up to A3 or 11 x 17, and can print on custom-size paper.
 - **Optional duplex printing accessory:** Provides two-sided printing (both sides of paper).
- **Output**
 - **Standard output bins**
 - **Standard top bin:** The standard top bin is located at the top of the printer and is the factory default bin. This bin can receive up to 500 sheets of paper.
 - **Standard left bin:** The left output bin is located on the left side of the printer. This bin can hold up to 100 sheets of paper.
 - **Optional 3,000-sheet stacker:** A stacking device.
 - **Upper bin (face-up):** Holds up to 100 sheets of paper.
 - **Lower bin (face-down):** Holds up to 3,000 sheets of paper.
 - **Optional 3,000-sheet stacker/stapler:** Provides multiposition stapling for up to 50 sheets of paper per job, or equivalent job height of 5 mm (depending on paper thickness).
 - **Upper bin (face-up):** Holds up to 100 sheets of paper.
 - **Lower bin (face-down):** Holds up to 3,000 sheets of paper.
 - **Optional Multifunction finisher:** Provides 1,000 sheets of stacking capacity, stapling for as many as 50 sheets of paper per document, plus folding and saddle stitching of booklets that contain up to 10 sheets of paper.
 - **Upper bin (straight paper path):** Holds up to 1,000 sheets of paper.
 - **Lower booklet bin:** Holds up to 50 booklets.

- **Optional 8-bin mailbox:** A stacker, collator, or job separator that also provides eight mailboxes that can be assigned to individual users or workgroups for easy identification and retrieval. The mailbox can stack 2,000 sheets of A4- or Letter-size paper in all the bins.
 - **Upper bin (face-up):** Holds up to 125 sheets of paper.
 - **Bins 1 through 8 (face-down):** Each holds up to 250 sheets of paper.

Connectivity

- HP Jetdirect EIO print server cards
 - Universal serial bus (USB), serial, and LocalTalk
 - Fast Ethernet 10/100TX
 - Wireless 802.11b
- Parallel B connection
- Local area network (LAN)-connector (RJ-45) for the embedded print server (standard on the HP LaserJet 9040n/9050n and the HP LaserJet 9040dn/9050dn)

Environmental features

- The Sleep setting saves energy (meets ENERGY STAR[®] guidelines, Version 3.0)

Note

See [Protecting the environment](#) for more information.

Firmware updates

Use information from the HP Web site to upgrade the printer and system firmware. To download the latest firmware, go to www.hp.com/go/lj9040_firmware or to www.hp.com/go/lj9050_firmware and follow the onscreen instructions. To easily send firmware updates to multiple printers, use the HP Web Jetadmin software (go to www.hp.com/go/webjetadmin).

Note

The firmware for the HP LaserJet 9040n/9050n and the HP LaserJet 9040dn/9050dn includes the networking modules.

Optional HP EIO hard disk

The EIO hard disk accessory can be used to store selected print jobs, support RIP ONCE technology, and permanently store downloaded fonts and forms in the printer. Unlike standard printer memory, many items on the EIO hard disk remain in the printer even when the printer is turned off. Fonts downloaded to the EIO hard disk are available to all users of the printer.

The EIO hard disk can be write-protected through software for additional security.

Use the device storage manager applet in HP Web Jetadmin to delete files and manage fonts on a mass-storage device. See [Embedded Web server](#). For more information, see the printer software Help.

Hewlett-Packard Company occasionally introduces new software tools for use with your printer and accessories. These tools are available from the Internet. For more information, go to www.hp.com/support/lj9050_lj9040.

Macintosh users

Use the HP LaserJet Utility to download fonts and files. For more information, see [HP LaserJet Utility](#) or the HP LaserJet Utility Guide online Help that is included with your HP LaserJet Utility software.

Security features

- Secure Disk Erase
- Security lock
- Job retention

For more information about these features, see [Security features](#).

Parts or accessories

The following table describes the parts and accessories that come with or are available to purchase for use with your printer.

Type of item	Item	Description or use	Order number
Paper handling, input	Optional Tray 1 (multipurpose tray) (standard on the HP LaserJet 9040n/9050n and 9040dn/9050dn models)	Automatically feeds up to 100 sheets of paper, or smaller amounts of special media such as envelopes and labels.	C8568A
	Optional Tray 4 (2,000-sheet feeder)	An optional tray that fits under the printer for increased input capacity.	C8531A
	Optional Duplex printing accessory (duplexer) (standard on the HP LaserJet 9040dn/9050dn model)	Produces automatic printing on both sides of paper.	C8532A

Type of item	Item	Description or use	Order number
Optional output devices (one device can be installed in any printer)	3,000-sheet stacker	One 3,000-sheet stacking device. The device also offers job offset capabilities.	C8084A
	3,000-sheet stacker/stapler	One 3,000-sheet stacking device that provides stapling for as many as 50 sheets of paper per document. The device also offers job offset capabilities.	C8085A
	Multifunction finisher	A finishing device that provides up to 1,000 sheets of stacking capacity, stapling for as many as 50 sheets of paper, plus folding and saddle-stitching of booklets that contain up to 10 sheets of paper.	C8088B
	8-bin mailbox	A device that provides a face-up bin (upper bin) and 8 face-down bins that can be assigned to individual users or workgroups. The device also functions as a job separator, stacker, and sorter/collator.	Q5693A
Printing supplies	Print cartridge (average of 30,000 pages at approximately 5% coverage)	Replacement HP maximum capacity, smart print cartridge.	C8543X
	Staple cartridge (for stacker/stapler)	Replacement HP 5,000-staple cartridge.	C8091A
	Staple cartridge (for multifunction finisher)	Replacement HP 5,000-staple cartridge.	C8092A

Type of item	Item	Description or use	Order number	
Memory, fonts, and mass storage	SDRAM double data rate (DDR) memory DIMMs (100-pin)	The printer has two memory DIMM slots. One is used by factory-installed memory.		
		Improves the ability of the printer to handle large and stored jobs (maximum 512 MB with HP-brand DDR DIMMs).		
		32 MB	Q3982A	
		64 MB	Q2625A	
		128 MB	Q2626A	
		256 MB	C2627A	
		512 MB	C2628A	
		Flash memory cards (100-pin)	Permanent storage for fonts and forms.	
			16 MB	Q2634A
			32 MB	Q2635A
64 MB	Q2636A			
EIO hard disk	Permanent storage for fonts and forms. Enables RIP ONCE technology of print jobs that are too large to RIP ONCE in RAM.	J6073A (> 5 GB)		

Type of item	Item	Description or use	Order number
Cable and interface accessories	EIO cards	<ul style="list-style-type: none"> ● HP Jetdirect Connectivity Card for USB, serial, and LocalTalk connectivity 	J4135A
		<ul style="list-style-type: none"> ● HP Jetdirect 620N Print Server for Fast Ethernet (10/100Base-TX) networks (RJ-45 only) (embedded 10/100Base-TX on the HP LaserJet 9040n/9050n and 9040dn/9050dn models is standard) 	J7934A
		<ul style="list-style-type: none"> ● HP 680n Wireless 802.11b connectivity 	J6058A
		<ul style="list-style-type: none"> ● HP Jetdirect 625N Print Server for Fast Ethernet (10/100Base-TX networks) 	J7960A
Maintenance kit	Printer maintenance kit	<ul style="list-style-type: none"> ● The kit contains two Type 1 rollers, seven Type 2 rollers, one transfer roller assembly, and one fuser assembly. 	C9152A (for 110-V models) C9153A (for 220-V models)

External view of printer and accessories

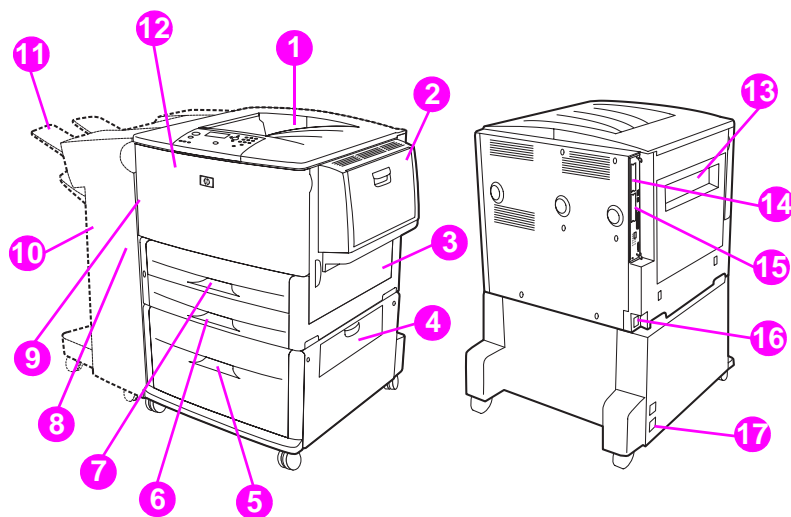

1. Standard top bin (face-down output bin)
2. Optional Tray 1
3. Right door
4. Vertical transfer door
5. Optional Tray 4
6. Tray 3
7. Tray 2
8. Left door (behind output device)
9. Optional duplex printing accessory (duplexer) (inside of the printer)
10. Optional output device (3,000-sheet stacker, 3,000-sheet stacker/stapler, multifunction finisher, or 8-bin mailbox)
11. Upper bin (face-up output bin shown on optional output device)
12. Front door
13. Left door
14. EIO slot 1
15. EIO slot 2
16. Power cord
17. Tray 4 output power





Note

For specific information about the output bins for each optional output device, see [Selecting the output bin](#).

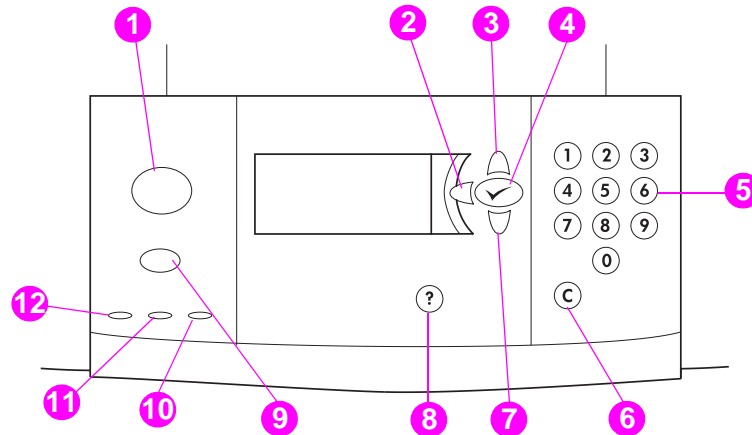
Layout and basic operation of the control panel

The control panel includes three light-emitting diode (LED) indicator lights, four navigation buttons, dedicated Help, two job-specific buttons, a numeric keypad, and a graphical display (capable of showing up to four lines of text).



Callout number	Button	Function
1	MENU	Enters or exits the menus.
2	 (Back Arrow)	Backs up one step from a selection or from a keypad entry.
3	 (Up Arrow)	Navigates to the previous item in the list.
4	 (SELECT)	<ul style="list-style-type: none"> Saves the selected value for that item. An asterisk (*) appears next to the selection, indicating that it is the new default. Default settings remain when the printer is turned off or is reset (unless you reset all factory defaults from the <code>Resets</code> menu). Prints one of the printer information pages from the control panel.
5	NUMERIC KEYPAD	Can be used to specify numeric values.
6	C (Clear)	Returns a numeric entry to its default value.
7	 (Down Arrow)	Navigates to the next item in the list.
8	? (Help)	Gets help about the message that currently appears.

Callout number	Button	Function
9	STOP	Brings up the Stop menu with the following options: <ul style="list-style-type: none"> Cancel the current print job. Pause the printer. Resume printing if the printer was paused.

Interpreting control-panel lights

Callout number	Light		Indication
10	Attention	Off	The printer has no error.
		On	The printer has a critical error. Turn the printer off and then on.
		Blinking	Action is required. See the control-panel display.
11	Data	Off	The printer has no data to print.
		On	The printer has data to print, but is not ready or is offline.
		Blinking	The printer is processing or is printing the data.
12	Ready	Off	The printer is offline or has an error.
		On	The printer is ready to print.
		Blinking	The printer is going offline; wait for the blinking to stop.

Using control-panel menus

For a complete list of control-panel items and possible values, see [Control-panel menu](#). When additional trays or other accessories are installed in the printer, new menu items automatically appear.

To print a control-panel menu map

See [Menu map](#) for information about how to print a control-panel menu map.

To change a control-panel setting

- 1 Press **✓** or **MENU** to open the menus.
- 2 Use **▲** or **▼** to scroll to the menu you want, and press **✓** to select it. Depending on the menu, you might have to repeat this step to select a submenu.
- 3 Use **▲** or **▼** to scroll to the item you want, and press **✓** to select it.
- 4 Use **▲** or **▼** to scroll to the value you want, and press **✓** to select it. An asterisk (*****) appears next to the selection on the control-panel display, indicating that it is now the default.
- 5 Press **MENU** to exit the menu.

Note

Settings in the printer driver and software override control-panel settings. (Software settings override printer driver settings.) If you cannot open a menu or use an item, it is either not an option for the printer, or your network administrator has locked the function. (The control panel reads `ACCESS DENIED MENU LOCKED`.) See your network administrator.

Paper-handling status LED interpretation

Use the following table to interpret the status LED on the optional 2,000-sheet input tray (optional Tray 4), optional 3,000-sheet stacker, optional 3,000-sheet stacker/stapler, optional multifunction finisher, and optional 8-bin mailbox.

Light	Optional 2,000-sheet input tray (Tray 4)	Optional output device (3,000-sheet stacker, 3,000-sheet stacker/stapler, multifunction finisher, or 8-bin mailbox)
Solid green	The accessory is on and ready.	The accessory is on and ready.
Blinking green	The accessory is in service mode.	The accessory is in service mode.
Solid amber	The accessory is experiencing a hardware malfunction.	The accessory is experiencing a hardware malfunction.
Blinking amber	The accessory has a jam, or a page needs to be removed from the tray, even if the page is not jammed. The vertical transfer door might be open.	The accessory has a jam, or a page needs to be removed from the unit, even if the page is not jammed. The accessory is not correctly attached to the printer.
Off	The printer might be in Sleep mode. Press any button of your choice. The accessory is not receiving power.	The printer might be in Sleep mode. Press any button of your choice. The accessory is not receiving power.

Printer software

Included with the printer is a CD-ROM that contains the printing-system software. The software components and printer drivers on this CD-ROM help you to use the printer to its fullest potential. See the installation notes on the CD-ROM for installation instructions.

Note

For the latest information about the printing system software components, see the readme file on the Web at www.hp.com/support/lj9050_lj9040. For information about installing the printer software, see the install notes on the CD-ROM that was included with the printer.

This section summarizes the software that is included on the CD-ROM. The printing system includes software for the following operating environments:

- Microsoft® Windows 9X and Windows Millennium Edition (Me)
- Microsoft Windows NT® 4.0, Windows 2000, and Windows XP
- IBM OS/2 version 3.0 or later (also available on the Web)
- Apple Mac OS 7.5 or later
- Linux (also available on the Web)

The printing system also includes software for network administrators that use the following network operating systems:

- Microsoft Windows 9X and Windows Me
- Microsoft Windows NT 4.0, Windows 2000, and Windows XP
- Microsoft Windows Server 2003
- Mac OS (EtherTalk)
- Linux (Web)
- UNIX® (Web)

Network printer installation for UNIX and other network operating systems is available from the Web or through a local HP-authorized distributor.

Note

For a list of printer drivers, updated HP printer software, and product support information, go to www.hp.com/support/lj9050_lj9040.

Software features

Automatic configuration, Update Now, and Preconfiguration features are available with the HP LaserJet 9040/9050 series printers.

Driver Autoconfiguration

The HP LaserJet PCL 6 and PCL 5e drivers for Windows and the PS drivers for Windows 2000 and Windows XP feature automatic discovery and driver configuration for printer accessories at the time of installation. Some accessories that Driver Autoconfiguration supports are the duplexing unit, optional paper trays, and dual inline memory modules (DIMMs).

Update Now

If you have modified the configuration of the HP LaserJet 9040/9050 printer since installation, the driver can be automatically updated with the new configuration in environments that support bidirectional communication. Click the **Update Now** button to automatically reflect the new configuration in the driver.

Note

The Update Now feature is not supported from the client machine in a Point-and-Print environment. Update Now can be used for locally-installed printers, and by the Point-and-Print server.

HP Driver Preconfiguration

HP Driver Preconfiguration is a set of tools that you can use to customize and distribute HP software in managed corporate printing environments. By using HP Driver Preconfiguration, information technology, (IT) administrators can preconfigure the printing and device defaults for HP printer drivers before installing the drivers in the network environment. For more information, see the *HP Driver Preconfiguration Support Guide*, which is available at www.hp.com/support/lj9050_lj9040.

Printer drivers

Use the printer drivers to gain access to the printer features and allow the computer to communicate with the printer (by using a printer language). Check the installation notes, the readme file, and the late-breaking readme file on the printer CD-ROM for additional software and languages.

The following table lists the printer drivers that are included with the printer. The most recent drivers are available at www.hp.com/support/lj9050_lj9040. (If you do not have access to the Internet, see the HP support flyer.) Depending on the configuration of Windows-based computers, the installation program for the printer software automatically checks the computer for Internet access in order to obtain the latest drivers.

Note

The PCL 5e print driver for all operating systems, plus the PCL 6 and PS drivers for Windows NT 4.0, are available on the CD-ROM. However, these print drivers are not installed during typical installation. To install one of these drivers, use the Add Printer Wizard.

Operating system ¹	PCL 5e	PCL 6	PS ²	PPD ³
Windows 9X and Windows Me	➤	➤	➤	
Windows NT 4.0,	➤	➤	➤	
Windows 2000	➤	➤	➤	
Windows XP	➤	➤	➤	
Windows Server 2003	➤	➤	➤	
Macintosh OS	➤	➤	➤	➤

1. Not all of the printer features are available from all drivers or operating systems. See the context-sensitive Help in your driver for available features.

2. PostScript (PS) 3 emulation is referred to as PS throughout this guide.

3. Only PostScript Printer Description (PPDs) files are included (see [PostScript Printer Description Files \(PPDs\) and Printer Dialog Extension \(PDEs\)](#)). If you need the Apple printer driver, it comes with the Macintosh operating system (OS), or it can be obtained directly from Apple.

Note If your system did not automatically check the Internet for the latest drivers during software installation, you can download the latest drivers from www.hp.com/support/lj9050_lj9040. After you are connected, click **Downloads and Drivers** to find the driver that you want to download.

You can obtain Model Scripts for UNIX and Linux by downloading them from the Internet or by requesting them from an HP-authorized service or support provider. You can download the UNIX installers at www.hp.com/support/net_printing.

Note If the printer driver that you want is not on the printer CD-ROM or it is not listed here, check the installation notes, the readme file, and the late-breaking readme file to see if the printer driver is supported. If it is not supported, contact the manufacturer or distributor of the program that you are using and request a driver for the printer.

Additional drivers

The following drivers are not included on the CD-ROM, but are available from the Internet or from HP Customer Care.

- OS/2 PCL 5e/6 printer driver
- OS/2 PS printer driver
- UNIX model scripts
- Linux drivers
- HP OpenVMS drivers

Note The OS/2 drivers are available from IBM and are packaged with OS/2. They are not available in Traditional Chinese, Simplified Chinese, Korean, or Japanese.

Note The HP OpenVMS drivers are available from h71000.www7.hp.com.

Choose the correct printer driver for your needs

Select a printer driver based on the way that you use the printer. Certain printer features are available only in the PCL 6 drivers. See the printer driver Help for available features.

- Use the PCL 6 driver to take full advantage of the printer features. For general office printing, the PCL 6 driver is recommended to provide optimum performance and print quality.
- Use the PCL 5e driver if you need backward compatibility with previous PCL printer drivers or older printers.
- Use the PS driver if you are printing primarily from PostScript-specific programs such as Adobe and Corel, for compatibility with PostScript Level 3 needs, or for PS font DIMM support.

Note The printer automatically switches between PS and PCL printer languages.

Printer driver Help

Each printer driver has help screens that can be activated by clicking the **Help** button, pressing the **F1** key, or clicking the question mark symbol in the upper-right corner in the printer driver (depending on the Windows operating system in use). These help screens give detailed information about the specific driver. Printer driver Help is separate from the software program Help.

Gaining access to the printer drivers

Use one of the following methods to gain access to the printer drivers from your computer:

Operating system	Temporarily change settings (from a software program)	Change print job default settings (across all software programs)	Change configuration settings (for example, add a new input tray)
Windows 9X, Windows NT, and Windows Me	On the File menu, click Print . Select the printer, and then click Properties . (The actual steps can vary; this is the most common method.)	Click the Start button, point to Settings , and then click Printers . Right-click the appropriate printer icon, and then select Properties (Windows 98 and Windows Me) or Document Defaults (Windows NT 4.0).	Click the Start button, point to Settings , and then click Printers . Right-click the appropriate printer icon, and then select Properties . Click the Configure tab.
Windows 2000 and Windows XP	On the File menu, click Print . Select the printer, and then click Properties or Preferences . (The actual steps can vary; this is the most common method.)	Click the Start button, point to Settings , and then click Printers or Printers and Faxes . Right-click the printer icon, and then select Printing Preferences .	Click the Start button, point to Settings , and then click Printers . Right-click the appropriate printer icon, and then select Properties . Click the Device Settings tab.
Macintosh OS 9.1	On the File menu, click Print . Change the settings that you want on the various pop-up menus.	On the File menu, click Print . As you change settings on the pop-up menu, click Save Settings .	Click the desktop printer icon. From the Printing menu, click Change Setup .
Macintosh OS X 10.1	On the File menu, click Print . Change the settings that you want on the various pop-up menus.	On the File menu, click Print . As you change settings on the various pop-up menu, click Save Custom Settings . These settings are saved as the Custom option. To use the new settings, you must select the Custom option each time that you open a program and print.	Delete the printer and reinstall it. The driver will be automatically configured with the new options when the driver is reinstalled (AppleTalk connections only.) Configuration settings might not be available in Classic mode.

Operating system	Temporarily change settings (from a software program)	Change print job default settings (across all software programs)	Change configuration settings (for example, add a new input tray)
Macintosh OS X.2	On the File menu, click Print . Change the settings that you want on the various pop-up menus.	On the File menu, click Print . Change settings on the various pop-up menus. On the Presets pop-up menu, click Save as , and type a name for the preset. These settings are saved in the Presets menu. To use the new settings, you must select the saved preset option each time that you open a program and print.	Open the Print Center . (Select the hard drive, click Applications , click Utilities , and then double-click Print Center .) Click the print queue. On the Printers menu, click Show Info . Select the Installable Options menu. Configuration settings might not be available in Classic mode.
Macintosh OS X.3	On the File menu, click Print . Change the settings that you want on the various pop-up menus.	On the File menu, click Print . Change settings on the various pop-up menus. On the Presets pop-up menu, click Save as , and type a name for the preset. These settings are saved in the Presets menu. To use the new settings, you must select the saved preset option each time that you open a program and print.	Open the Printer Setup Utility . (Select the hard drive, click Applications , click Utilities , and then double-click Printer Setup Utility .) Click the print queue. On the Printers menu, click Show Info . Select the Installable Options menu.

Software for Macintosh computers

The HP installer provides PostScript Printer Description (PPD) files, Printer Dialog Extensions (PDEs), and the HP LaserJet Utility for use with Macintosh computers.

The embedded Web server can be used by Macintosh computers if the printer is connected to a network.

PostScript Printer Description Files (PPDs) and Printer Dialog Extension (PDEs)

Use PPDs, in combination with the PostScript drivers, to gain access to the printer features and allow the computer to communicate with the printer. An installation program for the PPDs, PDEs, and other software is provided on the CD-ROM. Use the appropriate PS driver that is provided with the operating system.

HP LaserJet Utility

Use the HP LaserJet Utility to control features that are not available in the driver. Use the illustrated screens to select the printer features that you want. Use the HP LaserJet Utility to perform the following tasks:

- name the printer, assign it to a zone on the network, and download files and fonts
- configure and set the printer for Internet protocol (IP) printing

Note

The HP LaserJet Utility is not currently supported for OS X, but the utility is supported for the Classic environment.

Installing the printing system software

The following sections contain instructions for installing the printing system software.

The printer comes with printing system software and printer drivers on a CD-ROM. The printing system software on the CD-ROM must be installed to take full advantage of the printer features.

If you do not have access to a CD-ROM drive, you can download the printing system software from the Internet at www.hp.com/support/lj9050_lj9040.

Note

Sample model scripts for UNIX (HP-UX®, Sun Solaris) and Linux networks are available for download at www.hp.com/support/net_printing.

Installing Windows printing system software for direct connections

This section explains how to install the printing system software for Microsoft Windows 98, Windows Me, Windows NT 4.0, Windows 2000, Windows Server 2003, and Windows XP.

If you are installing the software on Windows NT 4.0, Windows 2000, Windows Server 2003, or Windows XP, make sure that you have administrator privileges.

When installing the printing software in a direct-connect environment, always install the software before connecting the parallel cable. If the parallel cable was connected before the software installation, see [Installing the software after the parallel cable has been connected](#).

To install the printing system software

- 1 Close all of the software programs that are open or running.
- 2 Insert the printer CD-ROM into the CD-ROM drive. If the welcome screen does not open, start it by using the following procedure:
 - a On the **Start** menu, click **Run**.
 - b Type the following information: X:/setup (where X is the letter of the CD-ROM drive).
 - c Click **OK**.
- 3 When prompted, click **Install Printer** and follow the instructions on the computer screen.
- 4 Click **Finish** when the installation is complete. You might need to restart the computer.
- 5 Print a Test Page or a page from any software program to make sure that the software is correctly installed.

If installation fails, reinstall the software. If this fails, check the installation notes and readme files on the printer CD-ROM or the flyer that came in the printer box, or go to www.hp.com/support/lj9050_lj9040 for help or more information.

Installing Windows printing system software for networks

The software on the printer CD-ROM supports network installation with a Microsoft network. For network installation on other operating systems, go to www.hp.com/support/lj9050_lj9040, or see the *Network Installation Guide* that is included with the printer.

The HP Jetdirect print server that is included with the HP LaserJet 9040n/9050n and the HP LaserJet 9040dn/9050dn printer has a 10/100Base-TX network port. If you need an HP Jetdirect print server with another type of network port, see [Parts or accessories](#) or go to www.hp.com/support/lj9050_lj9040.

The installer does not support printer installation or printer object creation on Novell servers. It supports only direct-mode network installations between Windows computers and a printer. To install your printer and create objects on a Novell server, use an HP utility (such as HP Web Jetadmin or HP Install Network Printer Wizard) or a Novell utility (such as NWAdmin).

To install the printing system software

- 1 Make sure that the HP Jetdirect print server is configured correctly for the network by printing a configuration page (see [Printing information pages](#)). On the second page, locate the printer IP address. You might need this address to complete network installation. If the printer is using DHCP IP configuration, use the name on the second page. Otherwise, if the printer is shut down for an extended period of time, DHCP does not guarantee that the same IP address will be issued.
- 2 Close all software programs that are open or running.
- 3 Insert the printer CD-ROM into the CD-ROM drive. If the welcome screen does not open, start it by using the following procedure:
 - a On the **Start** menu, click **Run**.
 - b Type the following: X:/setup (where X is the letter of the CD-ROM drive).
 - c Click **OK**.
- 4 When prompted, click **Install Printer** and follow the instructions on the computer screen.
- 5 Click **Finish** when installation has completed. You might need to restart the computer.
- 6 Print a Test Page or a page from any software program to make sure that the software is correctly installed.

Note

If installation fails, reinstall the software. If this fails, check the installation notes and readme files on the printer CD-ROM or the flyer that came in the printer box, or go to www.hp.com/support/lj9050_lj9040 for help or more information.

Setting up a Windows computer to use the network printer by using Windows-sharing

If the printer is directly connected to a computer with a parallel cable, you can share the printer on the network so that other network users can print to it.

See your Windows documentation for information about how to make Windows-sharing available. After the printer is shared, install the printer software on all computers that share the printer.

Installing Macintosh printing system software for networks

This section describes how to install Macintosh printing system software. The printing system software supports Mac OS versions 8.6 through 9.2.x, Mac OS version 10.1, and later.

The printing system software includes the following components:

- **PostScriptR Printer Description (PPD) files**

The PPDs, in combination with the PostScript printer drivers, provide access to printer features. An installation program for the PPDs and other software is provided on the CD-ROM that came with the printer. Use the Apple LaserWriter 8 printer driver that comes with the computer.

- **HP LaserJet Utility**

The HP LaserJet Utility provides access to features that are not available in the printer driver. Use the illustrated screens to select printer features and complete the following tasks with the printer:

- Name the printer.
- Assign the printer to a zone on the network.
- Assign an IP to the printer.
- Download files and fonts.
- Configure and set the printer for IP or AppleTalk printing.

Note

The HP LaserJet Utility is not currently supported for OS X, but the utility is supported for the Classic environment.

To install printer drivers from Mac OS 8.6 to 9.2

- 1 Connect the network cable between the HP Jetdirect print server and a network port.
- 2 Insert the CD-ROM into the CD-ROM drive. The CD-ROM menu runs automatically. If the CD-ROM menu does not run automatically, double-click the CD-ROM icon on the desktop, and then double-click the Installer icon. This icon is located in the Installer/ <language> folder of the Starter CD-ROM (where <language> is your language preference). (For example, the Installer/English folder contains the Installer icon for the English printer software.)
- 3 Follow the instructions on the computer screen.
- 4 Open the Apple Desktop Printer Utility that is located in the {Startup Disk}: Applications: Utilities folder.
- 5 Double-click **Printer (AppleTalk)**.
- 6 Next to AppleTalk Printer Selection, click **Change**.
- 7 Select the printer, click **Auto Setup**, and then click **Create**.
- 8 On the **Printing** menu, click **Set Default Printer**.

Note

The icon on the desktop is generic. All of the specific print panels appear in the print dialog box in a program.

To install printer drivers from Mac OS 10.1 and later

- 1 Connect the network cable between the HP Jetdirect print server and a network port.
- 2 Insert the CD-ROM into the CD-ROM drive. The CD-ROM menu runs automatically. If the CD-ROM menu does not run automatically, double-click the CD-ROM icon on the desktop, and then double-click the Installer icon. This icon is located in the Installer/<language> folder of the Starter CD-ROM (where <language> is your language preference). (For example, the Installer/English folder contains the Installer icon for the English printer software.)

- 3 Double-click the **HP LaserJet Installers** folder.
- 4 Follow the instructions on the computer screen.
- 5 Double-click the Installer icon for the appropriate language.
- 6 On your computer hard drive, double-click **Applications**, double-click **Utilities**, and then double-click **Print Center**.
- 7 Click **Add Printer**.
- 8 Select the AppleTalk connection type on OS X 10.1 and the Rendezvous connection type on OS X 10.2.
- 9 Select the printer name.
- 10 Click **Add Printer**.
- 11 Close the Print Center by clicking the close button in the upper-left corner.

Note

Macintosh computers cannot be connected directly to the printer by using a parallel port.

Installing the software after the parallel cable has been connected

If you have already connected a parallel cable to a Windows computer, the **New Hardware Found Wizard** appears when you turn on the computer.

To allow the Wizard to search the CD and automatically install the printer software

- 1 In the **New Hardware Found** dialog box, click **Search CD-ROM drive**.
- 2 Click **Next**.
- 3 Follow the instructions on the computer screen.
- 4 Print a Test Page or a page from any software program to make sure that the software is correctly installed.

If installation fails, reinstall the software. If this fails, check the installation notes and readme files on the printer CD-ROM or the flyer that came in the printer box, or go to www.hp.com/support/lj9050_lj9040 for help or more information.

Uninstalling the software

This section explains how to uninstall the printing system software.

To remove software from Windows operating systems

Use the Uninstaller in the HP LaserJet 9040/9050/Tools program group to select and remove any or all of the Windows HP printing system components.

- 1 Click **Start** and then click **Programs**.
- 2 Click **HP LaserJet 9040** or **HP LaserJet 9050**, and then click **Tools**.
- 3 Click **Uninstaller**.
- 4 Click **Next**.
- 5 Select the HP printing system components that you want to uninstall.
- 6 Click **OK**.
- 7 Follow the instructions on the computer screen to complete the uninstallation.

To remove software from Macintosh operating systems

Drag the HP LaserJet folder and PPDs to the trash can.

Software for networks

For a summary of available HP network installation and configuration software solutions, see the *HP Jetdirect Print Server Administrator's Guide*. You can find this guide on the CD-ROM that is included with the printer.

HP Web Jetadmin

Use HP Web Jetadmin to manage HP Jetdirect connected printers within your intranet by using a browser. HP Web Jetadmin is a browser-based management tool, and should be installed only on a single network administration server. It can be installed and run on Red Hat Linux; Suse Linux; Windows NT 4.0 Server and Workstation; Windows 2000 Professional, Server, and Advanced Server; and Windows XP with Service Pack 1.

To download a current version of HP Web Jetadmin and for the latest list of supported host systems, visit HP Customer Care Online at www.hp.com/go/webjetadmin.

When HP Web Jetadmin is installed on a host server, any client can gain access to it through a supported Web browser (such as Microsoft Internet Explorer 5.5 and 6.0 or Netscape Navigator 7.0).

HP Web Jetadmin has the following features:

- The task-oriented user interface provides configurable views, saving network managers significant time.
- The customizable user profiles let network administrators include only the function that the user will view or use.
- Instant e-mail notification of hardware failure, low supplies, and other printer problems can be routed to different people.
- Remote installation and management can be completed from any location by using only a standard Web browser.
- The advanced autodiscovery locates peripherals on the network, without manually entering each printer into a database.
- It offers simple integration into enterprise management packages.
- Users can quickly find peripherals based on parameters such as IP address, color capability, and model name.
- Peripherals can be easily organized into logical groups, with virtual office maps for easy navigation.
- Multiple printers can be configured and managed at the same time.

For the latest information about HP Web Jetadmin, go to www.hp.com/go/webjetadmin.

UNIX

The HP Jetdirect Printer Installer for UNIX is a simple printer installation utility for HP-UX and Solaris networks. It is available for download from HP Customer Care Online at www.hp.com/support/net_printing.

Utilities

The printer is equipped with several utilities to make it easy to monitor and manage the printer on a network.

Embedded Web server

This printer is equipped with an embedded Web server, which provides access to information about printer and network activities. A Web server provides an environment in which Web programs can run, similar to the way an operating system, such as Windows, provides an environment for programs to run on your computer. The output from these programs can then be viewed in a Web browser, such as Microsoft Internet Explorer or Netscape Navigator.

When a Web server is “embedded,” that means that it resides on a hardware device (such as a printer) or in firmware, rather than as software that is loaded on a network server.

The advantage of an embedded Web server is that it provides an interface to the printer that anyone who has a network-connected computer or a standard Web browser can use. You do not need to install or configure any special software. For more information about the HP embedded Web server, see the *Embedded Web Server User Guide*. You can find this guide on the CD-ROM that was included with the printer.

Features

Use the HP embedded Web server to view the printer and network card status and to manage printing functions from your computer. With the HP embedded Web server, you can complete the following tasks:

- view printer status information
- determine the remaining life on all supplies and order new ones
- view and change tray configurations
- view and change the printer control-panel menu configuration
- view and print internal pages
- receive notification of printer and supplies events
- add or customize links to other Web sites
- select the language in which to show the embedded Web server pages
- view and change network configuration

For information about the features and functionality of the embedded Web server, see [Embedded Web server](#).

HP Toolbox

For information about the HP Toolbox, see [HP Toolbox](#).

Other components and utilities

Several software programs are available for Windows and Macintosh OS users, as well as for network administrators. These programs are summarized in the following table.

Windows	Macintosh OS	Network administrator
<ul style="list-style-type: none">● Software installer — automates the printing system installation● Online Web registration● HP Toolbox	<ul style="list-style-type: none">● PostScript Printer Description files (PPDs) — for use with the PostScript drivers that come with the Mac OS● LaserJet Utility (available from the Internet) — a printer management utility for Mac OS users● HP Toolbox (for Mac OS X v10.2 and later)	<ul style="list-style-type: none">● HP Web Jetadmin — a browser-based system management tool (see www.hp.com/go/webjetadmin for the latest HP Web Jetadmin software)● HP Jetdirect Printer Installer for UNIX—available for download from www.hp.com/support/net_printing

Communicating by using an optional HP Jetdirect print server

If you purchase an optional HP Jetdirect internal print server, and you cannot communicate with the printer over the network, check the operation of the print server. Check the Jetdirect configuration page for the message `I/O CARD READY`.

To print a configuration page

- 1 Press `✓`.
- 2 Use `▲` or `▼` to scroll to `Information` and then press `✓`.
- 3 Use `▲` or `▼` to scroll to `Print Configuration` and then press `✓`.

For troubleshooting information, see the documentation that came with the print server.

Communicating by using the HP Jetdirect embedded print server

The HP LaserJet 9040n/9050n and the LaserJet 9040dn/9050dn have an embedded print server. If you cannot communicate with the printer over the network, check the operation of the embedded print server. Check the embedded Jetdirect configuration page for the message `I/O CARD READY`, and for the correct network configuration settings. See [To print a configuration page](#) for instructions.

Verify that the print server was able to link to the network automatically:

- Check that a link LED on the printer's LAN (RJ-45) connector is lit, which indicates a successful link. A link failure is indicated when both LEDs are off.
- Check the embedded Jetdirect configuration page for error messages. The message `LOSS OF CARRIER ERROR` indicates a link failure.

For link failures, check all of the network cable connections. In addition, you can try to manually configure the link settings on the embedded print server by using the printer control-panel menus (`MENU`, `CONFIGURE DEVICE`, `I/O`, `EMBEDDED JETDIRECT MENU`, `LINK SPEED`).

Note

HP Jetdirect print servers are available for many different network connections, including 802.11 wireless networks.

Embedded Web server

Using the embedded Web server

The HP LaserJet 9040/9050 series printers come equipped with an embedded Web server. Open the embedded Web server from a Web browser to obtain the following information about the printer:

- Control-panel messages
- Supplies levels and supplies ordering
- Tray configuration
- Printer control-panel menu configurations
- Printer configuration page
- Printer Event Log
- Printer usage (types of print jobs)
- Network configuration and management
- E-mail alerts

You can also use the embedded Web server to perform the print-job management functions that would usually be done at the printer control panel, including these functions:

- Changing printer settings
- Changing printer configuration
- Canceling print jobs

To gain access to the embedded Web server

Note

To use the embedded Web server, you must have an IP-based network and a Web browser.

In your Web browser, type the Internet Protocol (IP) address that is assigned to the printer. For example, if the printer IP address is 192.0.0.192, you would type this address:

`http://192.0.0.192`

For more information, see the *HP Embedded Web Server User Guide* at www.hp.com/support/lj9050_lj9040.

HP Toolbox

The HP Toolbox is a Web-based software program that you can use for the following tasks:

- Check the printer status.
- Print internal printer information pages.

You can view the HP Toolbox when the printer is connected to a network. The HP Toolbox software is automatically installed as part of the typical software installation.

Note

You do not need Internet access to open and use the HP Toolbox. However, if you click a link in the Other Links area, you must have Internet access to go to the site that is associated with the link. See [Other links](#) for more information.

Supported operating systems

The HP Toolbox is supported for the following operating systems:

- Windows 98, Windows 2000, Windows Me, Windows Server 2003, and Windows XP
- Macintosh OS 10.2 or later

Supported browsers

To use the HP Toolbox, you must have one of the following browsers:

- Microsoft Internet Explorer 5.5 or later (Internet Explorer 5.2 or later for Macintosh)
- Netscape Navigator 7.0 or later (Netscape Navigator 7.0 or later for Macintosh)
- Opera Software ASA Opera 7.0 for Windows
- Safari 1.0 software for Macintosh

All HP Toolbox pages can be printed from the browser.

To view the HP Toolbox

On the **Start** menu, select **Programs**, select **HP LaserJet 9040** or **HP LaserJet 9050**, and then select **HP LaserJet Toolbox**.

Note

You can also view the HP Toolbox by clicking the system tray icon or the desktop icon.

The HP Toolbox opens in a Web browser.

Note

After you open the HP Toolbox, you can bookmark it in your browser so that you can return to it quickly in the future.

HP Toolbox sections

The HP Toolbox software contains the following sections and options:

- [Status tab](#)
- [Alerts tab](#)
- [Device Settings button](#)
- [HP Toolbox links](#)
- [Other links](#)

Status tab

The **Status** tab has links to the following main pages:

- **Device Status.** View printer status information. This page indicates various printer conditions such as a paper jam or an empty tray. Use the virtual control panel buttons on this page to change printer settings. After you correct a problem with the printer, click the **Refresh** button to update the device status.
- **Supplies Status.** View detailed supplies status such as the percentage of toner remaining in the print cartridges and the number of pages that have been printed with the current print cartridges. This page also has links to order supplies and to find recycling information.
- **Print Info Pages.** Print the configuration page and other information pages that are available for the printer, such as the **Supplies Status** page, the **Demo** page, and the **Menu Map**.

Alerts tab

Use the **Alerts** tab to configure the printer to automatically notify you of printer alerts. The **Alerts** tab has links to the following main pages:

- Set up status alerts
- Administrative settings

On the **Set up status alerts** page, you can turn alerts on or off, specify when the printer should send an alert, and select from the following types of alerts:

- a pop-up message
- a task-bar icon

Click **Apply** to activate the settings.

On the **Administrative settings** page, you can set the frequency with which the HP Toolbox checks for printer alerts. The following settings are available:

- **Less often:** every 15000 milliseconds
- **Normal:** every 8000 milliseconds
- **More often:** every 4000 milliseconds

If you want to reduce network I/O traffic, reduce the frequency with which the printer checks for alerts.

Device Settings button

Clicking the **Device Settings** button connects you to the printer's embedded Web server.

See [Using the embedded Web server](#) for more information.

HP Toolbox links

The HP Toolbox links on the left side of the screen provide links to the following options:

- **Select a device.** Select from all of the HP Toolbox-enabled devices.
- **View current alerts.** View the current alerts for all of the installed printers. (You must be printing to view current alerts.)
- **Text only page.** View HP Toolbox as a site map that links to text-only pages.

Other links

Each page in the HP Toolbox contains links to the HP Web site for the following information:

- Product registration
- Product support
- Ordering supplies
- HP Instant Support™
- You must have Internet access to use any of these links. If you use a dial-up connection and did not connect to the Internet when you first opened the HP Toolbox, you must connect to the Internet before you can visit these Web sites.

Help system

At any time, you can gain access to the Help system on the printer control panel. Press **?** on the control panel.

2 Printing tasks

This section presents information about the following basic printing tasks:

- Loading input trays
- Orienting media
- Basic printing instructions
- Selecting the output bin
- Printing envelopes
- Using the optional 3,000-sheet stacker
- Using the optional stacker/stapler
- Using the optional multifunction finisher
- Using the optional 8-bin mailbox
- Printing both sides of paper (duplexing)
- Printing on special paper

Loading input trays

This section contains information about loading detectable and undetectable standard-size and custom-size media into optional Tray 1, Tray 2, Tray 3, and optional Tray 4.

CAUTION

To avoid a jam, never add or remove paper from optional Tray 1 or open Tray 2, Tray 3, or optional Tray 4 while printing from that tray.

To avoid damaging the printer, print labels and envelopes from optional Tray 1 only. Send labels and envelopes to the left output bin or upper bin. Print on only one side of labels and envelopes.

Loading optional Tray 1

Optional Tray 1, which holds up to 100 sheets, is available for the printer. For paper specifications, see [Paper specifications](#).

To load optional Tray 1 for occasional one-time use

Use this procedure if Tray 1 usually remains empty and is used for printing on a variety of sizes or types of paper.

- 1 Open optional Tray 1.

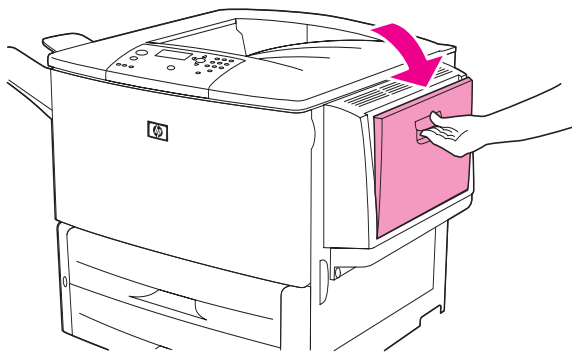

- 2 Load (orient) paper according to the size and the finishing options.

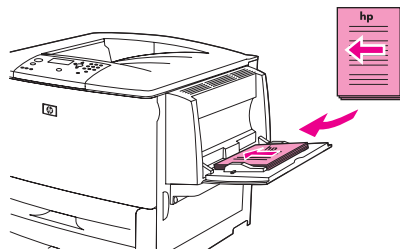

CAUTION

To avoid jams, print sheets of labels one sheet at a time.

- Adjust the paper guides so that they lightly touch the paper stack, but do not bend the paper.

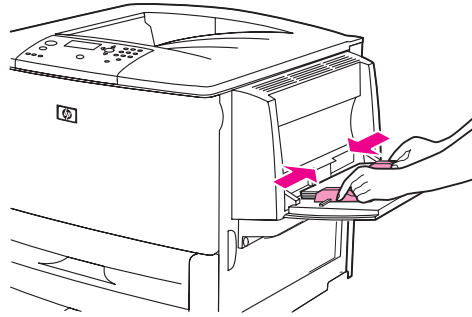

- Make sure that the paper fits under the tabs on the guides and that the stack does not extend above the load-level indicators.

Note

If printing on A3, 11 x 17, or other long media, also pull out the tray extension until it stops.

- Look at the control-panel display within a few seconds of loading the paper. (Reload the paper if the time has already elapsed.)
 - If TRAY X <TYPE> <SIZE> does *not* appear on the control-panel display, then the tray is ready for use.
 - If TRAY X <TYPE> <SIZE> appears on the control-panel, press ✓ to change the size and type configuration. The **Size** menu appears.
- Press ▲ to highlight ANY SIZE.
- Press ✓ to select ANY SIZE. The message SETTING SAVED appears on the control-panel display.
- When the **Type** menu appears, press ▲ to highlight ANY TYPE.
- Press ✓ to select ANY TYPE. The message SETTING SAVED appears on the control-panel display.
- If TRAY 1 ANY SIZE ANY TYPE appears on the control-panel display, then the printer is ready for intermittent use of a variety of paper sizes and types. Press ➡ to accept the size and type setting.

To load optional Tray 1 when the same paper is used for multiple print jobs

Use the following procedure if Tray 1 is usually loaded with the same type of paper, and the paper is not usually removed from Tray 1 between print jobs. The following procedure can usually increase the printer performance when printing from Tray 1.

CAUTION

To avoid a jam, never add or remove paper from a tray while printing from that tray.

- On the control panel, press ✓ to open the menus.
- Use ▲ or ▼ to scroll to PAPER HANDLING and then press ✓.
- Use ▲ or ▼ to scroll to TRAY 1 SIZE and then press ✓.
- Use ▲ or ▼ to scroll to the correct size and then press ✓. The message SETTING SAVED appears on the control-panel display.

Note

If you select CUSTOM as the paper size, also select the unit of measure (the X and Y dimensions).

- 5 Use ▲ or ▼ to scroll to TRAY 1 TYPE and then press ✓.
- 6 Use ▲ or ▼ to scroll to the correct type and then press ✓. The message SETTING SAVED appears on the control-panel display.
- 7 Press MENU to exit the menus.
- 8 Open optional Tray 1.

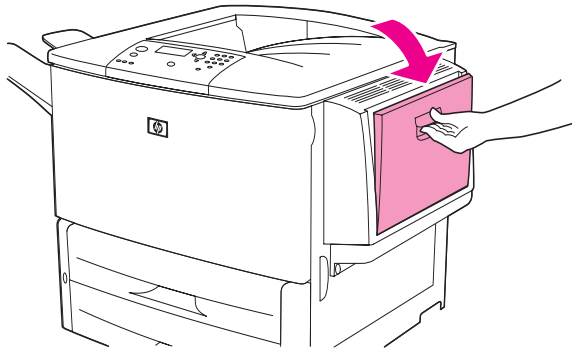

- 9 Load (orient) paper according to size and finishing options.

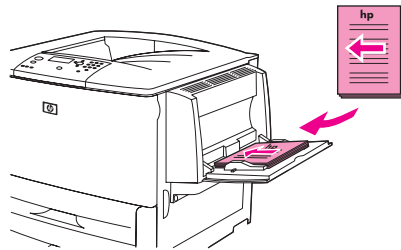

CAUTION

To avoid jams, print sheets of labels one at a time.

- 10 Adjust the paper guides so that they lightly touch the paper stack, but do not bend the paper.

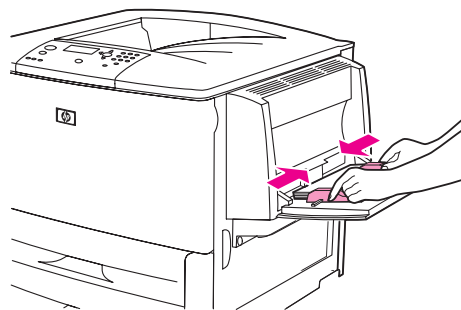

- 11 Make sure that the paper fits under the tabs on the guides and does not extend above the load level indicators.

Note

If printing on A3, 11 x 17, or other long media, also pull out the tray extension until it stops.

- 12 Look at the control panel within a few seconds of loading the paper. The tray configuration appears. (Open and close the tray again if the time has already elapsed.)

13 Press **MENU** to exit the menus. The tray is ready to use.

Loading Trays 2, 3, and 4

The 500-sheet input trays (Trays 2 and 3) come with the printer. Tray 4 is an optional tray that holds up to 2,000 sheets of standard-size paper. For paper specifications, see [Paper specifications](#).

To load detectable, standard-size paper in Trays 2, 3, and 4

Follow this procedure to load detectable standard-size paper in the tray. The following are the detectable sizes, which are marked inside the tray:

- A4
- Letter
- A3
- Legal
- 11 x 17
- Executive
- B4 (JIS)
- B5 (JIS)
- A4-Rotated
- Letter-Rotated

CAUTION

To avoid a jam, never add or remove paper from a tray while printing from that tray.

- 1 Open the tray until it stops.

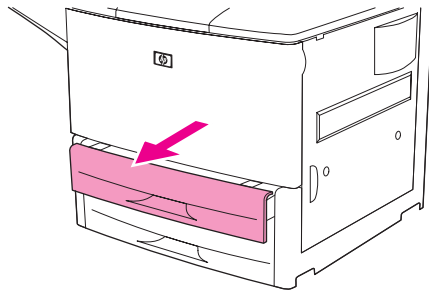

- 2 Adjust the left (Y) paper guide by pressing the tab on the guide and set the guide to the correct paper size.

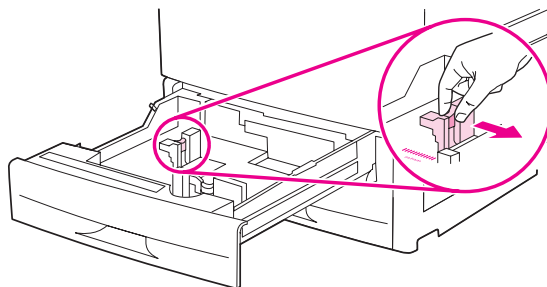

- Adjust the front (X) paper guide by pressing the tab on the guide and set the guide to the correct paper size.

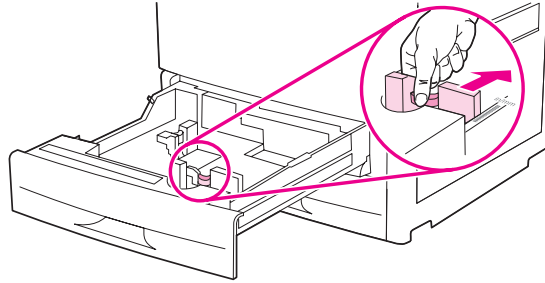

Note

For Tray 4, when loading Letter-size or 11 x 17 paper, move the paper guide lock to the down position. For all other paper sizes, the paper guide lock should be in the up position.

CAUTION

For Tray 4, never store paper or other items in the area to the left of the paper guides. Doing so can permanently damage the tray.

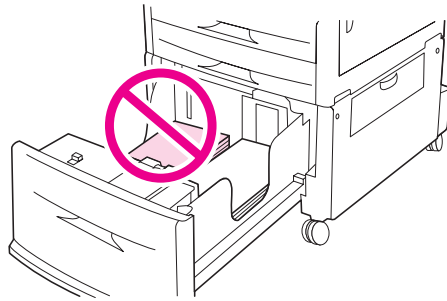

- Load (orient) the paper according to size.

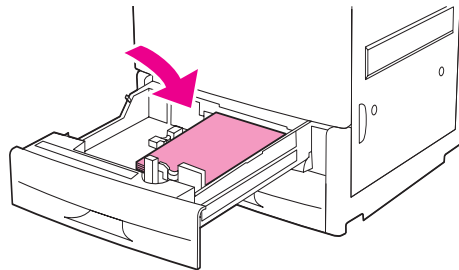

Note

See [Orienting media](#) for instructions on loading preprinted, letterhead, and prepunched paper.

- 5 Set the Custom/Standard switch to Standard.

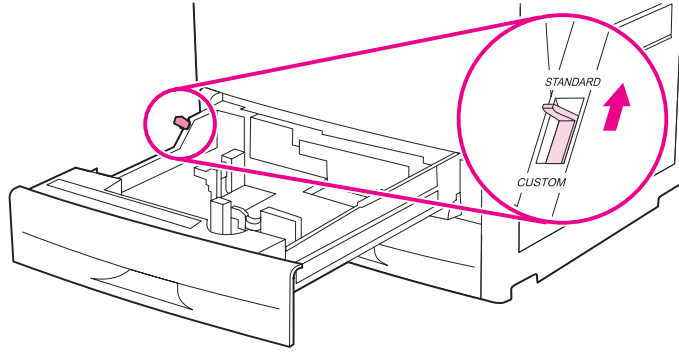

- 6 Close the tray.

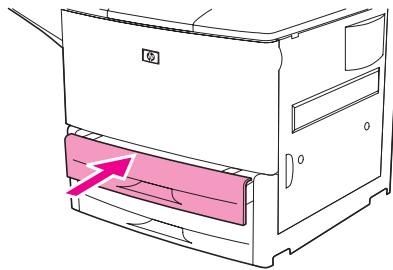

- 7 Look at the control panel within a few seconds of closing the tray. (Open and close the tray if the time has already elapsed.) The control panel indicates the tray size and type configuration. Complete one of the following actions:
 - If the size and type settings are correct, press \rightarrow to accept the settings.
 - If the size and type settings are not correct, press \checkmark . The TRAY X SIZE=*<SIZE> menu appears.
- 8 To change the size setting, use \blacktriangle or \blacktriangledown to scroll to the correct size and then press \checkmark . The message SETTING SAVED appears for a moment, and then the tray type menu appears.

Note

Depending on the size that you selected, the printer might prompt you to move the Custom/Standard switch in the tray to another position. The printer might also prompt you to move the paper guides. Follow the instructions on the control panel, close the tray, and then repeat this procedure starting with step 7.

- 9 To change the type setting, use \blacktriangle or \blacktriangledown to scroll to the correct type and then press \checkmark . The message SETTING SAVED appears for a moment, and then the current size and type settings appear.
- 10 If the size and type settings are correct, press \rightarrow to accept the settings. The tray is ready to use.

To load undetectable standard-size paper in Trays 2, 3, and 4

Follow this procedure to load undetectable standard-size paper in the tray. The following are the undetectable standard sizes:

- A5
- 8K
- 16K
- JIS Executive
- Statement
- 8.5 x 13 (216 x 330 mm)

CAUTION

To avoid a jam, never add or remove paper from a tray while printing from that tray.

- 1 Open the tray until it stops.

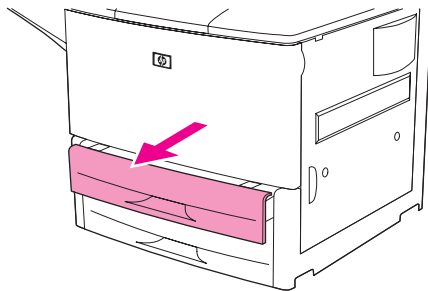

- 2 Press the tab on the front paper guide and slide the guide all the way out.
- 3 Press the tab on the left paper guide and slide the guide all the way out.

CAUTION

For Tray 4, never store paper or other items in the area to the left of the paper guides. Doing so can permanently damage the tray.

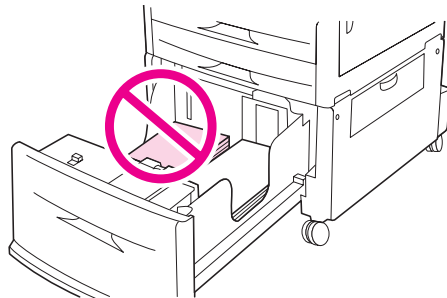

- 4 Load (orient) the paper according to size.

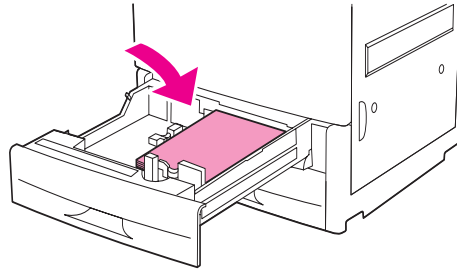

Note

See **Orienting media** for instructions on loading preprinted, letterhead, and prepunched paper.

- 5 Adjust the left paper guide by pressing the tab on the guide and sliding the guide until it gently touches the paper.

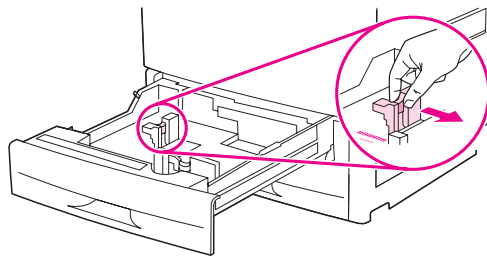

- 6 Adjust the front paper guide by pressing the tab on the guide and sliding the guide until it gently touches the paper.

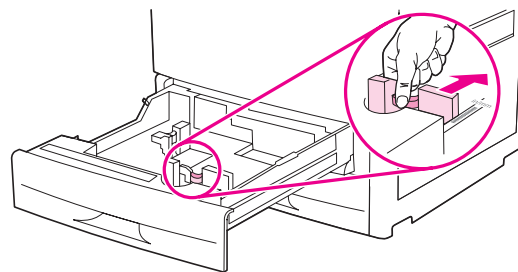

Note

When loading Tray 4, make sure that the paper guide lock is in the up position.

- 7 Set the Custom/Standard switch to Custom.

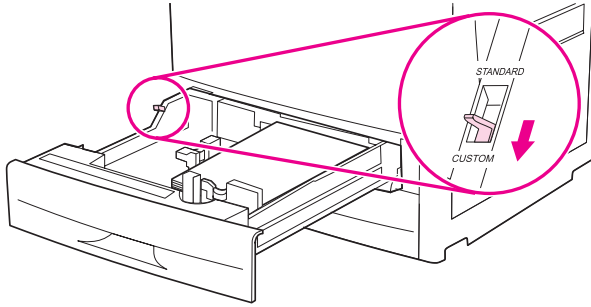

- 8 Close the tray.

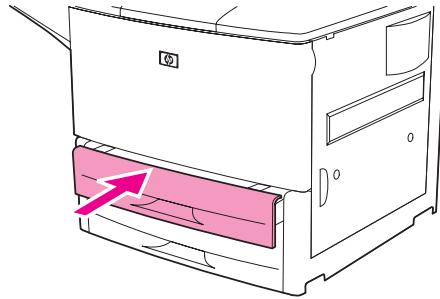

- 9 Look at the control panel within a few seconds of closing the tray. (Open and close the tray if the time has already elapsed.) The control panel indicates the tray size and type settings. Complete one of the following actions:
 - If the size and type settings are correct, press \rightarrow to accept the settings.
 - If the size and type settings are not correct, press \checkmark . The TRAY X SIZE=* \langle SIZE \rangle menu appears.
- 10 To change the size setting, use \blacktriangle or \blacktriangledown to scroll to the correct size and then press \checkmark . The message SETTING SAVED appears for a moment, and then the tray type menu appears.

Note

Depending on the size that you selected, the printer might prompt you to move the Custom/Standard switch in the tray to another position. The printer might also prompt you to move the paper guides. Follow the instructions on the control panel, close the tray, and then repeat this procedure starting with step 9.

- 11 To change the type setting, use \blacktriangle or \blacktriangledown to scroll to the correct type and then press \checkmark . The message SETTING SAVED appears for a moment, and then the current size and type settings appear.
- 12 If the size and type settings are correct, press \rightarrow to accept the settings. The tray is ready to use.

Loading custom-size paper in Trays 2, 3, and 4

Use the following procedure to load custom-size paper in the tray.

CAUTION

To avoid a jam, never add or remove paper from a tray while printing from that tray.

- 1 Open the tray until it stops.

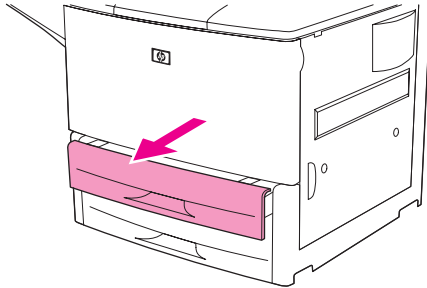

- 2 Press the tab on the front (X) paper guide and slide the guide all the way out.
- 3 Press the tab on the left (Y) paper guide and slide the guide all the way out.
- 4 Load (orient) the paper according to size.

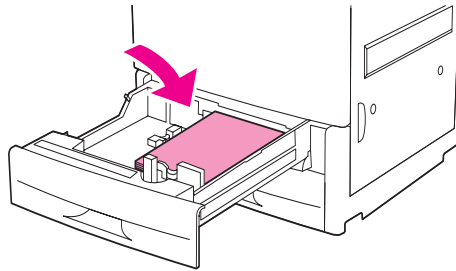

Note

See [Orienting media](#) for instructions on loading preprinted, letterhead, and prepunched paper.

- 5 Set the Custom/Standard switch to Custom.

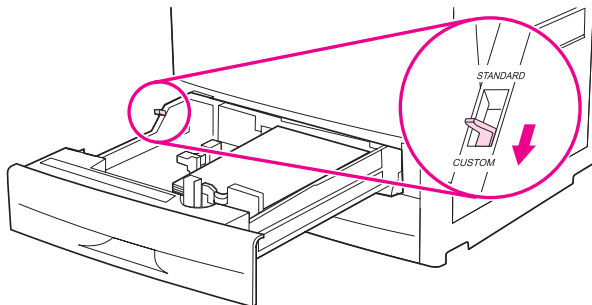

- Adjust the left (Y) paper guide by pressing the tab on the guide and sliding the guide until it gently touches the paper.

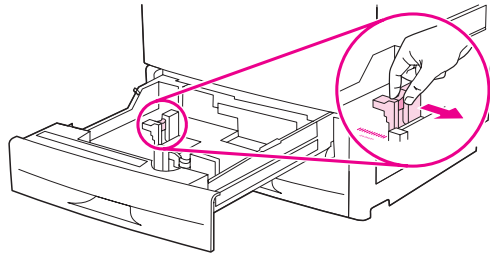

- Adjust the front (X) paper guide by pressing the tab on the guide and sliding the guide until it gently touches the paper.

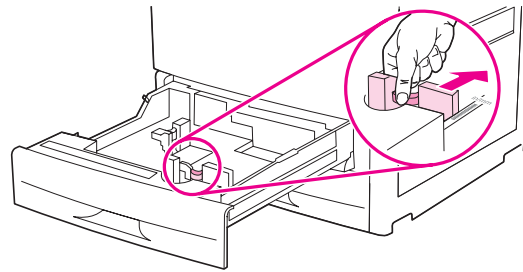

- Note the orientation of the paper, as well as the value of the X dimension and the Y dimension. The X and Y dimensions are marked in the tray. You will need this information for a later step.

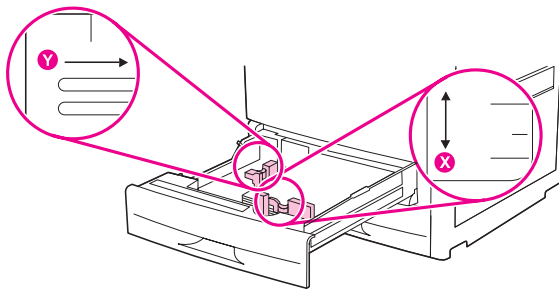

Note

When loading Tray 4, make sure that the paper guide lock is in the up position.

- Close the tray.

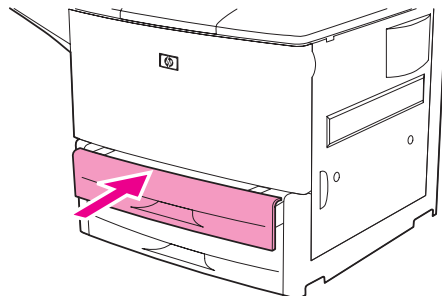

- 10 Look at the control panel within a few seconds of closing the tray. (Open and close the tray if the time has already elapsed.) The tray size and type settings appear.
 - If the size and type settings are correct, press \rightarrow to accept the settings. The tray is ready for use. (You do not need to complete the rest of this procedure unless you want to configure the exact custom dimension. See the following note for more information.)
 - To change the size setting, press \checkmark . The TRAY X SIZE=*<SIZE> menu appears.

Note

If the size that appears on the control panel is CUSTOM, then the tray size is set to ANY CUSTOM. The tray will match any custom-size print job, even if the print-job dimensions are different from the dimensions of the paper that is loaded in the tray. If you prefer, you can specify the exact dimensions of the custom-size paper that is loaded in the tray. When you specify exact dimensions, the dimensions appear as the size, rather than CUSTOM.

- 11 Press \checkmark to select CUSTOM. The UNIT OF MEASURE menu appears.

Note

The printer might prompt you to move the Custom/Standard switch in the tray to another position. The printer might also prompt you to move the paper guides. Follow the instructions on the control panel, close the tray, and then repeat this procedure starting with step 10.

- 12 Use \blacktriangle or \blacktriangledown to select the unit of measure (MILLIMETERS or INCHES) and then press \checkmark .
- 13 Use the numeric keypad or the \blacktriangle or \blacktriangledown keys to specify the X (front to back) dimension and then press \checkmark .
- 14 Use the numeric keypad or the \blacktriangle or \blacktriangledown keys to specify the Y (left to right) dimension and then press \checkmark . The message SETTING SAVED appears for a moment, and then the TRAY X TYPE menu appears.
- 15 To change the type setting, use \blacktriangle or \blacktriangledown to scroll to the correct type and then press \checkmark . The message SETTING SAVED appears for a moment, and then the current size in the dimension that you selected appears.
- 16 Press \rightarrow to accept the settings. The tray is ready to use.

Configuring the trays by using the Paper Handling menu

You can configure the paper type and size for the input trays without a prompt on the printer control-panel display. Use the following procedure to gain access to the Paper Handling menu and configure the trays.

To configure the paper size for the tray

- 1 On the control panel, press \checkmark to open the menus.
- 2 Use \blacktriangle or \blacktriangledown to scroll to PAPER HANDLING and then press \checkmark .
- 3 Use \blacktriangle or \blacktriangledown to scroll to TRAY X SIZE and then press \checkmark . (X is the number of the tray that you want to configure.)
- 4 Use \blacktriangle or \blacktriangledown to scroll to the correct size and then press \checkmark .
- 5 Touch MENU to exit the menus.

Note

Depending on the size that you selected, the printer might prompt you to move the Custom/Standard switch in the tray to another position. The printer might also prompt you to move the paper guides. Follow the instructions on the control panel, and then close the tray,

To configure the paper type for the tray

- 1 On the control panel, press ✓ to open the menus.
- 2 Use ▲ or ▼ to scroll to PAPER HANDLING and then press ✓.
- 3 Use ▲ or ▼ to scroll to TRAY X TYPE and then press ✓. (X is the number of the tray that you want to configure.)
- 4 Use ▲ or ▼ to scroll to the correct type and then press ✓. The message SETTING SAVED appears for a moment.
- 5 Touch MENU to exit the menus.

Orienting media

Orient media types and sizes according to the tray from which they will print and according to whether the media will be duplexed (printed on both sides).

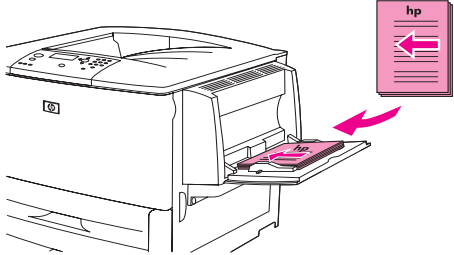
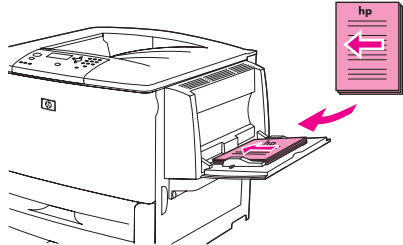
Type of media	Tray	Duplexed	Media Orientation
Letter or A4, including letterhead (weights up to 216 g/m ²) (58 lb bond)	1	No*	Long edge toward feed direction; side to be printed on facing up. 
Letter or A4, including letterhead (weights up to 216 g/m ²) (58 lb bond) NOTE For better duplexing performance, set the size and type for Tray 1.	1	Yes	Long edge toward feed direction; first side to be printed on facing down.  Note: When printing on paper that is both prepunched <i>and</i> preprinted/letterhead, orient the paper in the same way that you would orient preprinted/letterhead paper.

* When Alternate Letterhead mode is enabled and media type Letterhead or Preprinted is selected, you must orient the media for two-sided (duplex) printing. For more information, see [Alternate Letterhead mode](#).

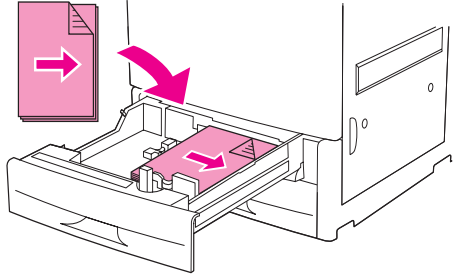
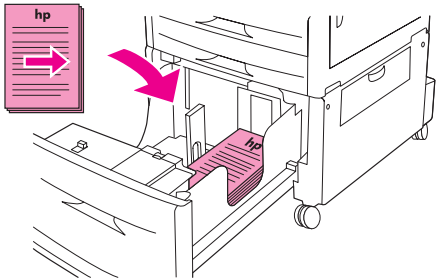
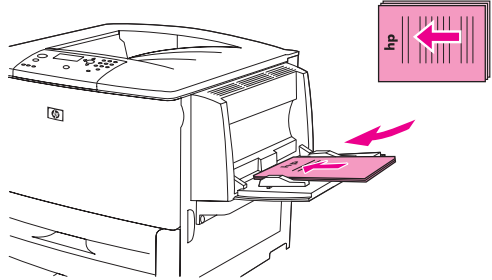
Type of media	Tray	Duplexed	Media Orientation
Letter or A4, including letterhead (weights up to 199 g/m ²) (53 lb bond)	2, 3, or 4	No*	<p>Long edge toward feed direction; side to be printed on facing down.</p>  <p>Note: When printing on paper that is both prepunched <i>and</i> preprinted/letterhead, orient the paper in the same way that you would orient preprinted/letterhead paper.</p>
Letter or A4, including letterhead (weights up to 199 g/m ²) (53 lb bond)	2, 3, or 4	Yes	<p>Long edge toward feed direction; first side to be printed on facing up.</p> 
Other standard sizes and custom sizes (weights up to 216 g/m ²) (58 lb bond)	1	No*	<p>Short edge toward feed direction; side to be printed on facing up.</p> 

* When Alternate Letterhead mode is enabled and media type Letterhead or Preprinted is selected, you must orient the media for two-sided (duplex) printing. For more information, see [Alternate Letterhead mode](#).

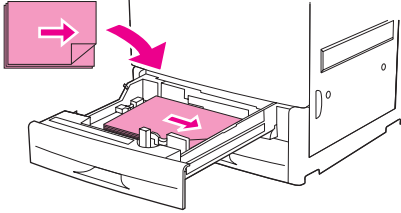
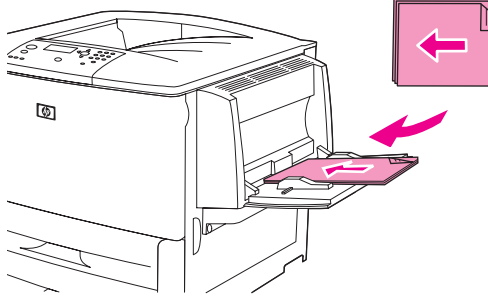
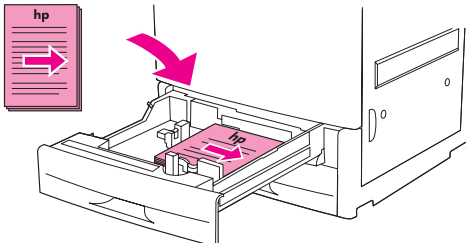
Type of media	Tray	Duplexed	Media Orientation
Other standard sizes and custom sizes (weights up to 199 g/m ²) (53 lb bond)	2, 3, or 4	No*	Short edge toward feed direction; side to be printed on facing down. 
Other standard sizes and custom sizes (weights up to 216 g/m ²) (58 lb bond) NOTE For better duplexing performance, set the size and type for Tray 1.	1	Yes	Short edge toward feed direction; first side to be printed on facing down. 
Other standard sizes and custom sizes (weights up to 199 g/m ²) (53 lb bond)	2, 3, or 4	Yes	Short edge toward feed direction; first side to be printed on facing up. 

* When Alternate Letterhead mode is enabled and media type Letterhead or Preprinted is selected, you must orient the media for two-sided (duplex) printing. For more information, see [Alternate Letterhead mode](#).

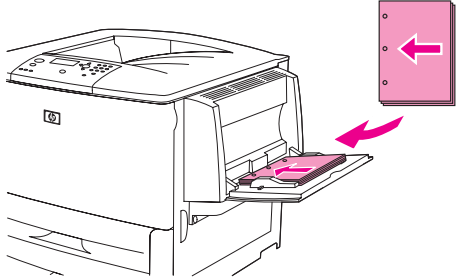
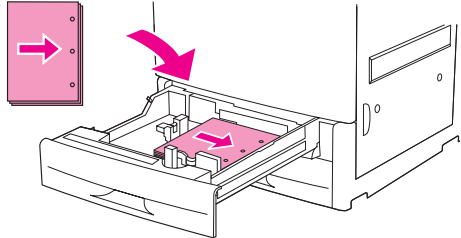
Type of media	Tray	Duplexed	Media Orientation
Prepunched Letter or A4 (weights up to 216 g/m ²) (58 lb bond)	1	Either	<p>Long edge with holes toward feed direction; side to be printed on facing up.</p>  <p>Note: When printing on paper that is both prepunched <i>and</i> preprinted/letterhead, orient the paper in the same way that you would orient preprinted/letterhead paper.</p>
Prepunched Letter or A4 (weights up to 199 g/m ²) (53 lb bond)	2, 3, or 4	Either	<p>Long edge with holes toward feed direction; side to be printed on facing down.</p>  <p>Note: When printing on paper that is both prepunched <i>and</i> preprinted/letterhead, orient the paper in the same way that you would orient preprinted/letterhead paper.</p>

* When Alternate Letterhead mode is enabled and media type Letterhead or Preprinted is selected, you must orient the media for two-sided (duplex) printing. For more information, see [Alternate Letterhead mode](#).

Type of media	Tray	Duplexed	Media Orientation
Labels, Letter, A4 size sheets, or transparencies	Tray 1 only	No (Never duplex)	Long edge toward feed direction; side to be printed on facing up.

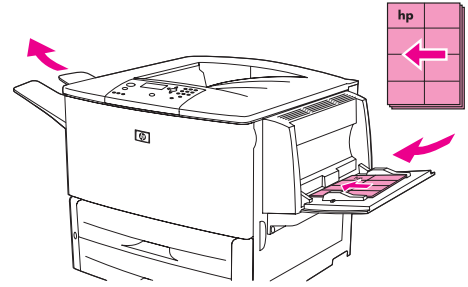

Envelopes	Tray 1 only	No (Never duplex)	Short edge toward feed direction; side to be printed on facing up and the postage end toward the printer. If height of envelope is greater than 190 mm (7.5 inches), feed flap first. Otherwise, feed the flap toward the rear of printer.
-----------	-------------	----------------------	--

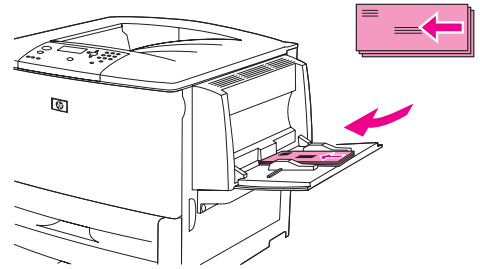

* When Alternate Letterhead mode is enabled and media type Letterhead or Preprinted is selected, you must orient the media for two-sided (duplex) printing. For more information, see [Alternate Letterhead mode](#).

Alternate Letterhead mode

Windows drivers include an Alternate Letterhead mode, which is configured in the Device Settings portion of the printer properties (in the Windows control panel). This mode causes all print jobs with media types of Letterhead and Preprinted to be treated as two-sided (duplexed), so that you can load paper in the same way for one-sided and two-sided printing. Because the print speed is the same as it is for two-sided (duplex) printing, one-sided jobs print at approximately half-speed.

Basic printing instructions

This section provides the basic instructions for printing when setting options from the printer driver for this printer (Windows) or the Apple LaserWriter (Macintosh). If possible, you should try to set printer options from the program in which you are working or from the **Print** dialog box. Most Windows and Macintosh programs allow you to set the printer options this way. If a setting is not available in the program or printer driver, you must set it at the printer control panel.

To print

- 1 Make sure that paper is loaded in the printer. See [Loading input trays](#) or www.hp.com/support/lj9050_lj9040 for instructions.
- 2 If you loaded a custom-size media in Tray 2, Tray 3, or optional Tray 4, or if you loaded any size media in optional Tray 1, set the tray to the size of paper that you loaded. See [Loading input trays](#) or www.hp.com/support/lj9050_lj9040 for instructions.
- 3 Set the paper size.
 - For Windows: On the **File** menu, click **Page Setup** or **Print**. If you select **Print**, make sure that this printer is selected and then click **Properties**.
- 4 For Macintosh: On the **File** menu, select **Page Setup**. Make sure that this printer is selected. In the paper size box, select:
 - The size of paper you are using.
 - **Custom**.
- 5 Select the orientation, such as **Portrait** or **Landscape**.
- 6 If the printer driver is not already open, on the **File** menu click **Print**. In Windows programs, also click **Properties**.
- 7 In the paper source box, select the paper type and size or select the tray from which you want paper pulled. See [Specifying paper to print on](#).
- 8 Select any other settings that you want, such as duplexing (if an optional duplexer is installed in the printer), watermarks, or different first page. For more information about these settings, see the tasks in this section and in the next section ([Advanced printing tasks](#)).
- 9 The standard output top bin is the default output location. Use this location for output of standard types of media. For labels, transparencies, and heavy paper, use the left output bin. Or, you can select an optional output accessory, such as the stacker or stacker/stapler.
- 10 Select the **Print** command to print the job.

Selecting the output bin

The printer has several output locations: the standard top bin, the left output bin, and the optional output devices.

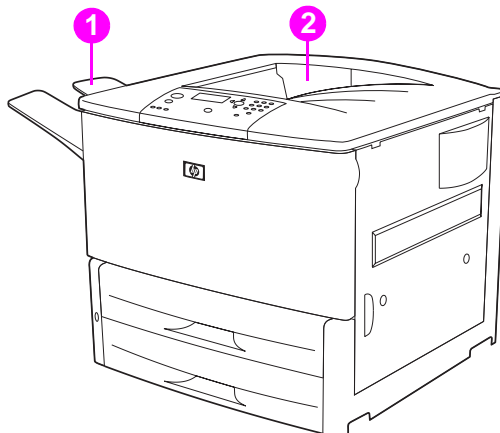

The **left output bin (1)**, located on the left side of the printer, holds up to 100 sheets of paper.

The **standard top bin (2)** is located at the top of the printer and is the factory default bin. This bin can receive up to 500 sheets of paper in the correct (face-down) order as they exit the printer. A sensor causes the printer to stop when the paper bin is full. Printing continues when you empty or reduce the amount of paper in the bin.

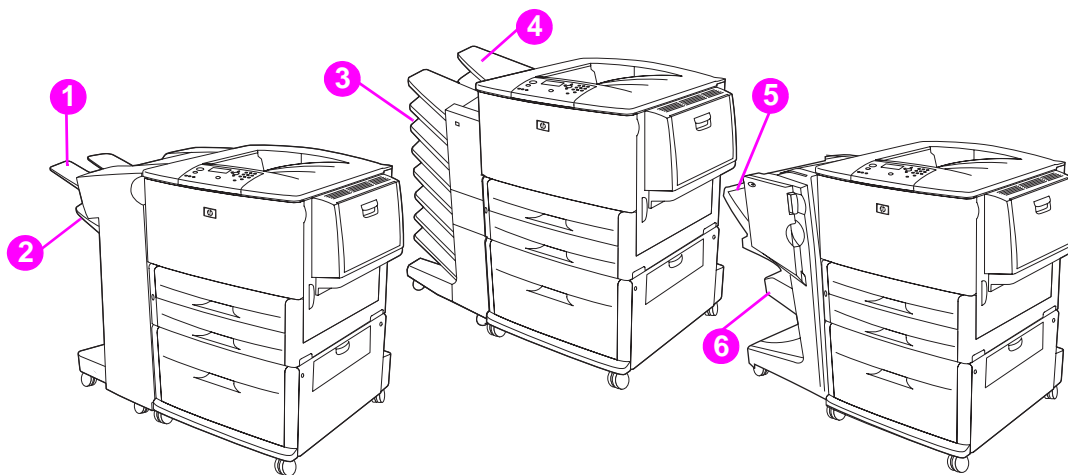

Stacker or stacker/stapler output bins

For the 3,000-sheet stacker or 3,000-sheet stacker/stapler, the output bins are the upper bin (1) (face-up) and the lower bin (2) (face-down).

The upper bin (face-up) (1) is the top bin on the stacker or stacker/stapler. This bin holds up to 100 sheets of paper in face-up order as they exit the printer. A sensor causes the product to stop when the bin is full. Product operation continues when you empty or reduce the amount of paper in the bin.

Lower bin (face-down) (2) is the lower bin on the stacker or stacker/stapler. This bin holds up to 500 sheets of paper and can stack or staple jobs. This bin is the default output bin.

8-bin mailbox output bins

If you choose the 8-bin mailbox, the output bins are the upper bin (4) and the eight face-down bins (3).

The upper bin (4) holds up to 125 sheets of paper.

The network administrator can assign the eight bins (3) to individual users or workgroups. Each bin can stack up to 250 sheets of paper.

Note

When an 8-bin mailbox device is connected to the printer, the default bin is the printer's standard top bin.

Multifunction finisher output bins

If you choose the multifunction finisher, the output bins are the upper bin (5) and the lower booklet bin (6).

The **upper bin** (5) is the top bin on the multifunction finisher. This bin provides 1,000 sheets of stacking capacity, and can offset each job as it is stacked, delivering unstapled jobs face up or face down. This bin also provides stapling for up to 50 sheets of paper per document. The upper bin is the default output bin when the multifunction finisher is attached.

The **lower bin** (4) is the lower bin on the multifunction finisher. This bin provides folding and saddle stitching of booklets that contain up to 10 sheets of paper.

Selecting an output location

It is recommended that you select an output location (bin) through your program or printer driver. (Where and how you make selections depends on your program or printer driver.) If you cannot select an output location from the program or printer driver, set the default printer output location from the printer control panel.

To select an output location from the control panel

- 1 Use ▲ or ▼ to scroll to `Configure Device` and then press ✓.
- 2 Use ▲ or ▼ to scroll to `Printing` and then press ✓.
- 3 Use ▲ or ▼ to scroll to `Paper Destination` and then press ✓.
- 4 Use ▲ or ▼ to scroll to the output bin or device you want and then press ✓. Your network administrator might have changed the name of the device. An asterisk (*) appears next to your selection.

Printing envelopes

You can print on envelopes by using optional Tray 1, which holds up to 10 envelopes. Many types of envelopes can be printed on from optional Tray 1.

Printing performance depends on the construction of the envelope. Always test a few sample envelopes before purchasing a large quantity. For envelope specifications, see [Paper specifications](#) or go to www.hp.com/support/lj905_lj9040.

CAUTION

Envelopes with clasps, snaps, windows, coated linings, exposed self-stick adhesives, or other synthetic materials can severely damage the printer. Do not use envelopes with pressure-sensitive adhesive.

The basic steps for printing envelopes are:

- 1 Move the fuser levers. See [To change the fuser levers](#).
- 2 Load the envelopes. See [To load envelopes in optional Tray 1](#).
- 3 Send the print job. See [To print envelopes from a program](#).

Note

If envelopes are wrinkled when printed, see [Preventing wrinkles on envelopes](#) for instructions.

To load envelopes in optional Tray 1

- 1 Open optional Tray 1, but do not pull out the extension. (Most envelopes feed best without the extension. However, oversize envelopes might need the extension.)

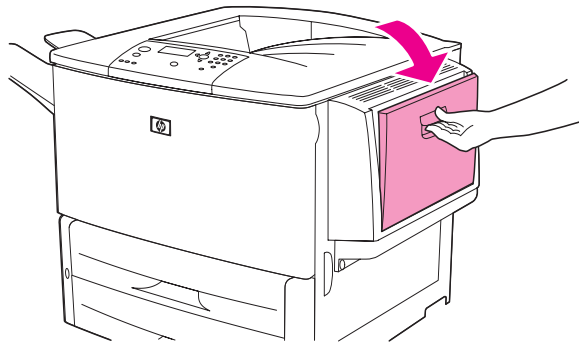

- 2 Load up to 10 envelopes in the center of optional Tray 1 with the side to be printed on facing up, and the postage end toward the printer. Slide the envelopes into the printer as far as they will go without forcing them.

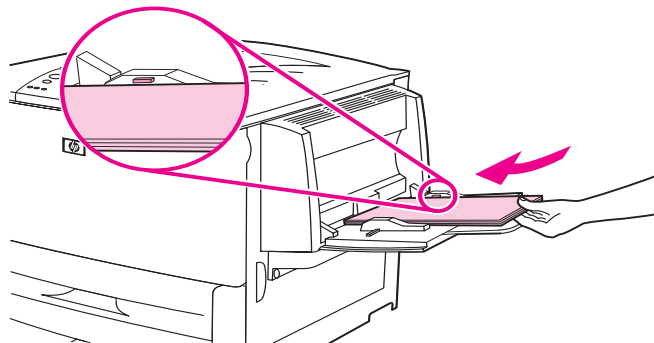

- 3 Adjust the guides to touch the envelope stack without bending the envelopes. Make sure the envelopes fit under the tabs on the guides.

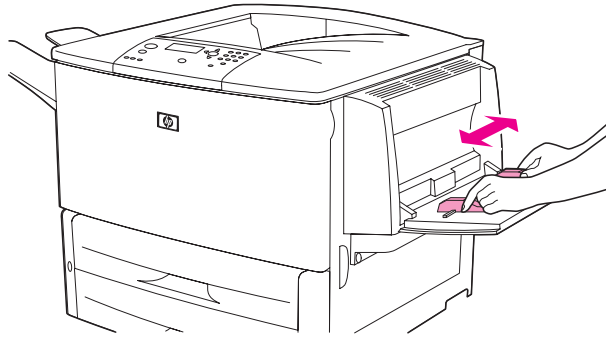

- 4 Change the fuser levers (see [To change the fuser levers](#)).

To change the fuser levers

- 1 If an optional output device is installed, slide it away from the printer to access the left door.

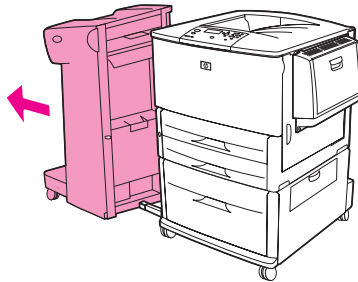

- 2 Open the left door.

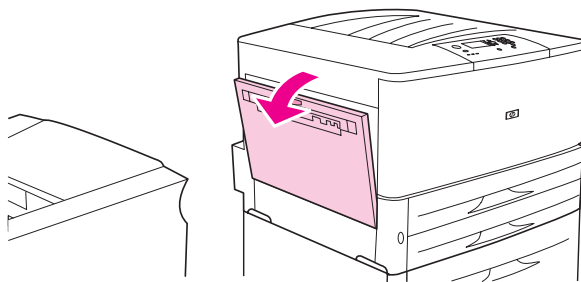

WARNING!

Avoid touching the adjacent fusing area. It can be *hot*.

- 3 Locate and lift up the two blue levers.

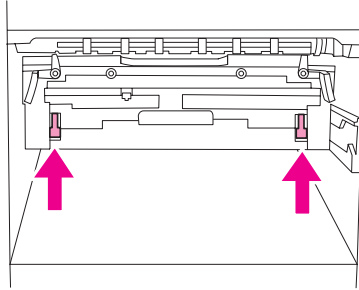

Note

Return the fuser levers to the down position after printing an envelope.

- 4 Close the left door.

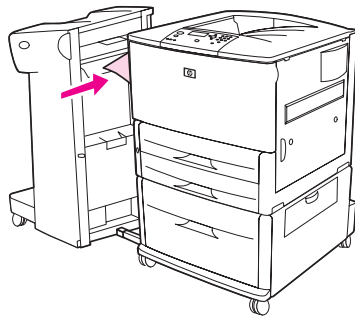

To print envelopes from a program

- 1 Load envelopes into optional Tray 1.
- 2 In your program or in the printer driver, select optional Tray 1 as the source.
- 3 Set the appropriate envelope size and type. For envelope specifications, see [Paper specifications](#), or go to www.hp.com/support/lj9050_lj9040.
- 4 If your program does not automatically format an envelope, specify "Portrait" for page orientation.

CAUTION

To avoid a printer jam, do not remove or insert an envelope after you begin printing.

- 5 Set margins to within 15 mm (0.6 inch) from the edge of the envelope. For best print quality, set margins for a return and mailing address (typical address margins for a Commercial #10 or DL envelope are offered). Avoid printing over the area where the three back flaps meet on the back of an envelope.
- 6 To print by type and size of paper, see [Specifying paper to print on](#), or go to www.hp.com/support/lj9050_lj9040.
- 7 Select the standard output bin (the default) as the output location. If you print envelopes to the stacker, stacker/stapler, or multifunction finisher, they exit to the face-up bin of that accessory.
- 8 When finished, return the fuser levers to the down position.

CAUTION

Failure to return levers to the down position for standard paper types can result in poor print quality.

Using the optional 3,000-sheet stacker

Output features

The optional 3,000-sheet stacker provides the following output features:

- Stacks up to 3,000 sheets of A4- or Letter-size paper
- Stacks up to 1,500 sheets of A3- or Ledger-size paper
- Can offset, print jobs or the first page can be offset

Bin 2 (face-down on the 3,000-sheet stacker and 3,000-sheet stacker/stapler) on the output devices is the default bin for all output.

Using the optional stacker/stapler

The optional 3,000-sheet stacker/stapler can staple documents consisting of a minimum of two pages, and a maximum of 50 pages (75 g/m², 20 lb bond paper) or equivalent to 6 mm (0.2 inches). The pages must be 64 to 199 g/m² (17 to 53 lb) for all sizes that the engine supports

Keep in mind these additional points:

- The stacker can hold up to 3,000 sheets.
- Heavier media might have a stapling limit of less than 50 pages.
- If the job you want stapled consists of only one sheet, or if it consists of more than 50 sheets, the printer will print the job. However it will not be stapled.

Selecting the stapler

You can usually select the stapler through your program or printer driver, although some options might only be available through the printer driver. Where and how you make selections depends on your program or printer driver.

If you cannot select the stapler from the program or printer driver, select the stapler from the printer control panel.

To select stapling as the default from the control panel

- 1 From the Ready state, use ▲ or ▼ to scroll to `Configure Device` menu and then press ✓.
- 2 Use ▲ or ▼ to scroll to the stacker/stapler, and then press ✓.
- 3 Use ▲ or ▼ to scroll to `Staple` and then press ✓.
- 4 Select the number of staples that you want as a default.
- 5 Use ▲ or ▼ to scroll to `Printing` and then press ✓.
- 6 Use ▲ or ▼ to scroll to the output bin or device you want and then press ✓. An asterisk (*) appears next to your selection.

Loading staples

Load staples using this procedure.

To load staples

- 1 Move the stacker/stapler away from the printer.

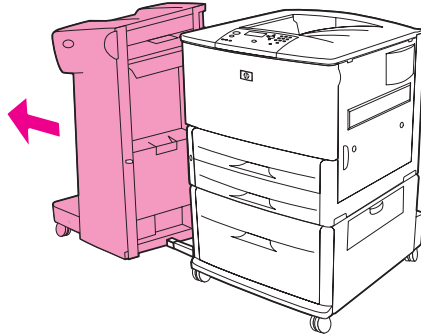

- 2 Open the stacker/stapler-unit door.

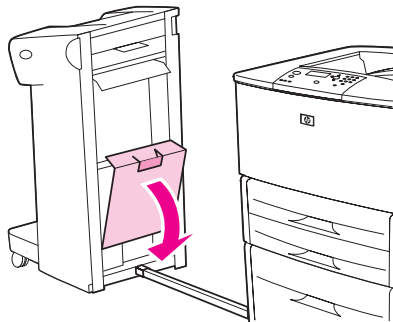

- 3 Lift up on the green tab on the empty staple cartridge and pull it out.

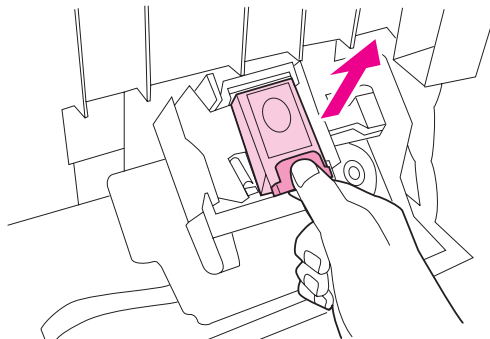

- 4 Insert the new staple cartridge so that it snaps into place.

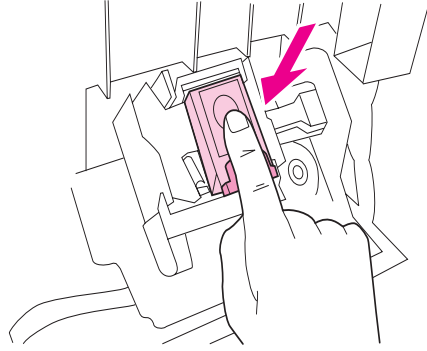

- 5 Close the stapler-unit door and attach the stacker/stapler to the printer.

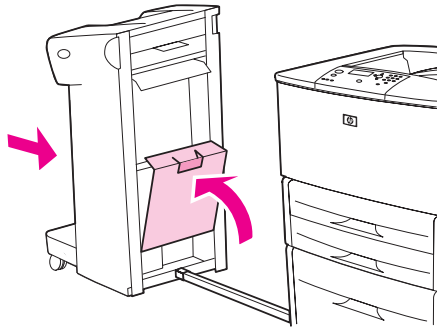

Using the optional multifunction finisher

See the *HP LaserJet 9040/9050 Getting Started Guide* at www.hp.com/support/lj9050_lj9040 for more information about the following topics:

- Stapling documents
- Saddle stitching
- Printing booklets
- Adding a cover to a booklet

Output features

The optional multifunction finisher provides the following output features:

- Stacks up to 1,000 sheets of A4- and Letter-size paper or up to 500 sheets of A3- and Ledger-size paper
- Stacks up to 50 booklets of 5 sheets of A3- and Ledger-size paper
- Offsets jobs
- Staples up to 50 sheets of paper per document of A4- and Letter-size paper
- Staples up to 25 sheets of paper per document A3- and Ledger-size paper
- Folds single pages
- Saddle-stitches and folds booklets up to 10 sheets of paper (40 pages)

Using the stapler

The finisher can staple documents consisting of a minimum of two pages, and a maximum of 50 pages of 75 g/m² (20 lb) A4- or Letter-size media or up to 25 pages of A3- or 11x 17-size media or equivalent 6 mm (0.2 inch). The pages must be between 64 and 199 g/m² (17 and 53 lb) for any size supported by the product.

Consider these additional points:











- The stacker can hold up to 1,000 sheets stacked (not stapled).
- Heavier media might have a stapling limit of fewer than 50 pages.

If the job you want stapled consists of only one sheet, or if it consists of more than 50 sheets, the finisher delivers the job to the output bin without staples.

Selecting stapling

You can usually select the stapler through your program or driver, although some options might be available only through the driver. Where and how you make selections depends on your program or driver.

If you cannot select the stapler from the program or driver, select the stapler from the product control panel.

- 1 Press  to open the menus.
- 2 Use  and  to scroll to CONFIGURE DEVICE and then press .
- 3 Use  and  to scroll to STAPLES and then press .
- 4 Use  and  to scroll to the desired stapling option and then press .

Your stapling options are None, One, or Two staples.

Loading staples

- 1 Open the stapler-unit door.

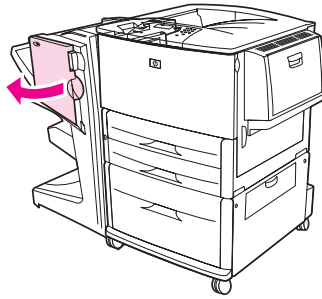

- 2 Slide the stapler-unit toward you.

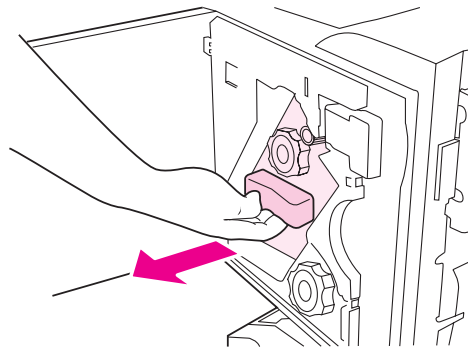

- 3 Turn the large green knob until the blue dot appears in the window of the stapler-unit.

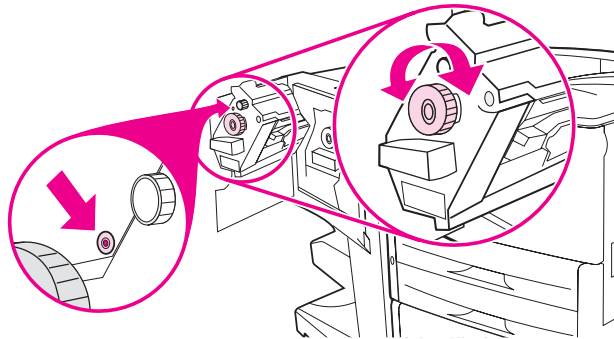

- 4 Turn the small green knob at the top of the stapler unit clockwise until the staple cartridge moves to the left of the stapler unit.

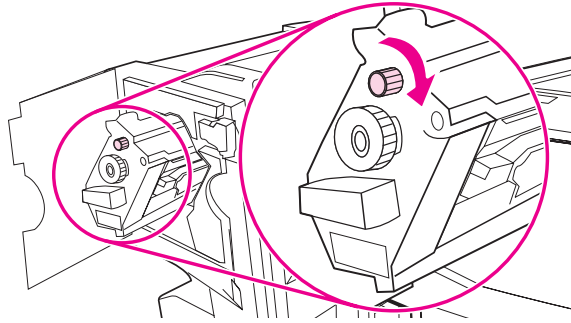

CAUTION

The blue dot must appear in the window of the stapler-unit before you remove the staple cartridge. If you try to remove the staple cartridge before the blue dot appears in the window, you could damage the finisher.

- 5 On the empty staple cartridge, squeeze the tabs together and pull the empty cartridge out.

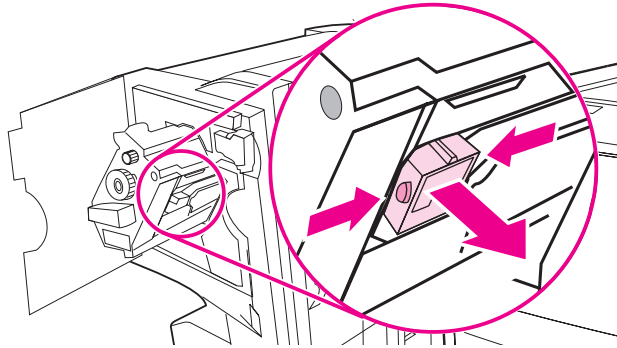

- 6 Insert the new staple cartridge so that it locks into place.

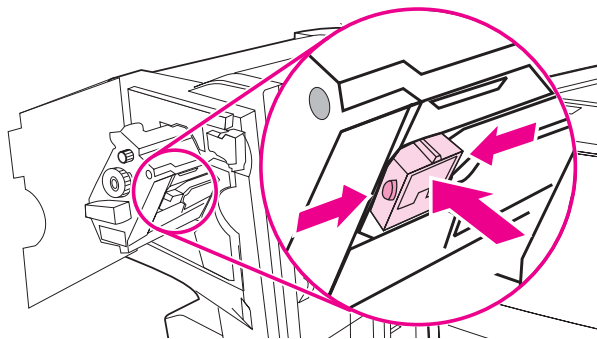

- 7 Slide the stapler-unit into the finisher.

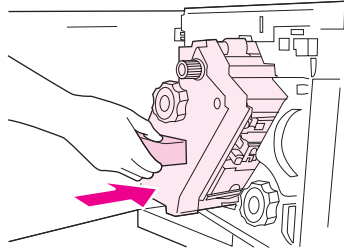

- 8 Close the stapler-unit door.

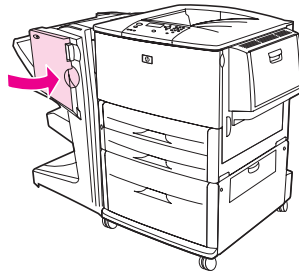

Making booklets

You can gain access to the booklet-printing feature through some programs, such as desktop publishing programs. Refer to the user guide that came with your program for information on making booklets.

If you are using a program that does not support booklet making, you can create booklets by using your HP drivers.

Note

HP recommends that you use your program to prepare and preview your document for printing, and then use your HP driver to print and saddle stitch your booklet.

Use these three main steps to create a booklet from your driver:

- Preparing your booklet: Arrange the pages on a sheet (booklet imposition) to create a booklet. You can impose your document from your program or use the booklet-printing feature in your HP driver.
- Adding a cover: Add a cover to your booklet by selecting a different first page of a different paper type. You can also add a cover of the same paper type as your booklet. Booklet covers must be the same size as the rest of the sheets. However, the covers can be a different weight from the rest of the booklet. (See [Using a different first page](#) for more information)
- Saddle stitching: Paper must be fed into the printer short-edge first. The printer will ask for rotated paper. The finisher staples the center of your booklet (saddle stitching). If your booklet is only one sheet of paper, the finisher will fold the sheet, but not staple it. If the booklet consists of more than one sheet of paper, the finisher will staple and then fold up to 10 sheets per booklet.

The booklet-printing feature of the multifunction finisher allows you to saddle stitch and fold booklets using the following paper sizes:

- A3
- A4-Rotated (A4-R)*
- Letter-Rotated (Letter R)*
- Legal
- 11 x 17

See the *Multifunction Finisher User's Guide* at www.hp.com/support/lj9050_lj9040 for detailed information about making booklets.

*A4-R and Letter-R are A4-size and Letter-size media that are rotated 90° in the tray.

Using the optional 8-bin mailbox

Output features

- Handles high-capacity output that increases the printer's output capacity to 2,000 sheets of standard media
- Uses the upper bin to provide 125 sheets of face-up stacking capacity
- Delivers printed jobs face-down to the eight face-down bins, and each bin provides 250 sheets of stacking capacity
- Offers stacking options in different operational modes: mailbox, stacker, job separator, and sorter/collator

For more information about the 8-bin mailbox, see the use guide that came with the 8-bin mailbox.

Printing both sides of paper (duplexing)

The printer can automatically print on both sides of paper when an optional duplex printing accessory (duplexer) is installed and configured. See the documentation that is included with the duplexer for installation instructions.

CAUTION

Never try to print on both sides of labels, envelopes, transparencies, or paper that is heavier than 199 g/m² (53 lb). Damage to the printer or a jam can result.

To print on both sides of paper

- 1 If necessary, configure the printer driver to recognize the duplexer. See the printer software help for instructions.
- 2 Load (orient) paper for duplexing.

Note

For better duplexing performance, set the size and type for Tray 1.

- 3 Select the **Print on both sides** option from the program or printer driver. If you cannot select this option from one of those locations, set it at the printer control panel. (In the `Configure Device` menu, select the `Printing` menu, select `Duplex`, and then select `ON`.)
- 4 Set the **Binding** and **Orientation** options from the **Print** dialog box, if possible. If not, set them from the printer control panel. See [Layout options for printing on both sides of paper](#) for more information.

Layout options for printing on both sides of paper

The four print layout options are shown below. Select the binding and orientation options for this printer from the **Print** dialog box, if possible. The terminology in the **Print** dialog box for the binding edge might be different than the terms that are listed here.

If you cannot set these options from the **Print** dialog box, set them from the control panel. Select the **Configure Device** menu, select the **Printing** menu, select **DUPLEX BINDING** or **ORIENTATION**, and then select the layout option that you want.

Printing left-to-right

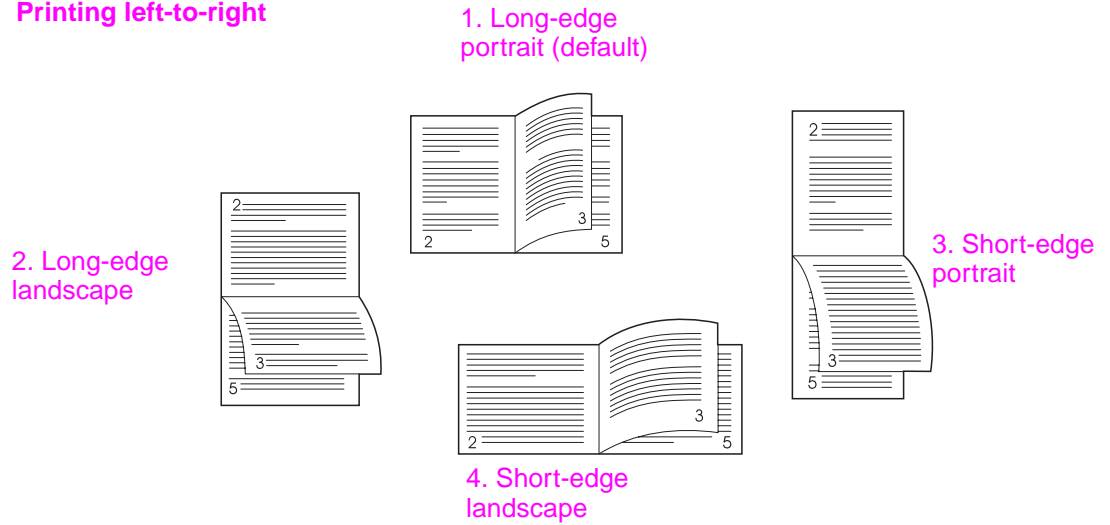

Printing right-to-left

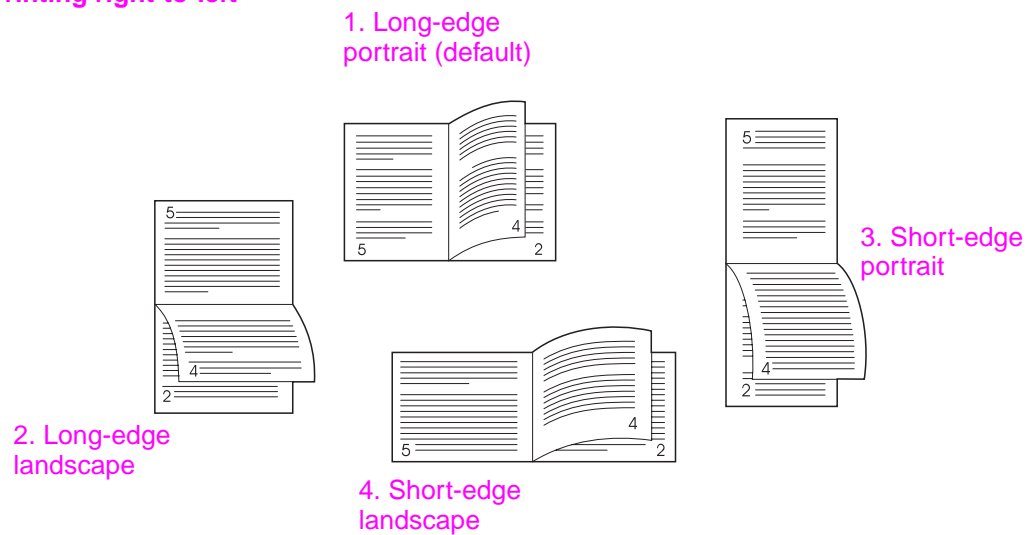

Printing on special paper

This section contains guidelines for printing on special media, which includes letterhead, transparencies, postcards, and custom-size and heavy paper, and printing full-bleed images.

Printing on letterhead, prepunched paper, or preprinted paper (single-sided)

- When printing on letterhead, prepunched, or preprinted paper, be sure to correctly orient the paper. See [Orienting media](#) for instructions.
- If the paper is heavier than 199 g/m² (53 lb bond) and less than 216 g/m² (58 lb bond) load it only in optional Tray 1. See [Paper specifications](#), or go to www.hp.com/support/lj9050_lj9040 for complete paper specifications.

Printing on letterhead, prepunched paper, or preprinted paper (double-sided)

- When printing on letterhead, prepunched, or preprinted paper, be sure to correctly orient the paper. See [Orienting media](#) for instructions.
- When printing on both sides of prepunched paper, you must select prepunched paper as the paper type in the **Paper Handling** menu from the control panel or select prepunched paper from your printer driver.

Printing labels

- Orient labels according to the guidelines in [Orienting media](#).
- Print a stack of up to 50 sheets of labels from optional Tray 1.
- Use only labels recommended for laser printers. Make sure the labels meet the correct specifications. (See [Paper specifications](#), or go to www.hp.com/support/lj9050_lj9040.)

CAUTION

Failure to follow these instructions can damage the printer.

Special cautions:

- Do not load optional Tray 1 to capacity, because labels are heavier than paper.
- Do not use labels that are separating from the backing sheet, wrinkled, or damaged in any way.
- Do not use labels that have the backing sheet exposed. (Labels must cover the entire backing sheet with no exposed spaces.)
- Do not feed a sheet of labels through the printer more than once. The adhesive backing is designed for only one pass through the printer.
- Do not print on both sides of labels.

Printing on transparencies

- Transparencies used in this printer must be able to withstand the 200°C (392°F), the maximum temperature for the printer.
- Use only transparencies recommended for use in laser printers.
- Use the left output bin for transparencies. If you select the optional stacker, stacker/stapler, multifunction finisher, or 8-bin mailbox, use the upper bin for transparencies.

CAUTION

Do not attempt to print on both sides of transparencies. Do not attempt to print on envelopes, custom paper, or paper that is heavier than 199 g/m² (58 lb). Printing on other transparencies can damage the printer.

Guidelines for custom-size paper, card stock, and heavy paper

- You can print on custom-size paper from optional Tray 1, Tray 2, Tray 3, or optional Tray 4.
- Any paper heavier than 199 g/m² (53 lb) must be fed only from optional Tray 1. For paper specifications, see [Paper specifications](#) or go to www.hp.com/support/lj9050_lj9040.
- If you are printing from optional Tray 1, the edge of the paper feeding into the printer must be at least 98 mm (3.9 inches) wide to allow rollers inside the printer to grab the paper, and a maximum of 312 mm (12.3 inches). Measuring from the leading edge to the trailing edge of the paper, the length must be at least 191 mm (7.5 inches) and a maximum of 470 mm (18.5 inches).
- If you are printing from Tray 2 or 3, the edge of the paper feeding into the printer must be at least 148 mm (5.8 inches) wide to allow rollers inside the printer to grab the paper, and a maximum of 297 mm (11.7 inches). Measuring from the leading edge to the trailing edge of the paper, the length must be at least 210 mm (8.3 inches) and a maximum of 432 mm (17.0 inches).
- If you are printing from optional Tray 4, the edge of the paper feeding into the printer must be at least 182 mm (7.2 inches) wide to allow rollers inside the printer to grab the paper, and a maximum of 297 mm (11.7 inches). Measuring from the leading edge to the trailing edge of the paper, the length must be at least 210 mm (8.3 inches) and a maximum of 432 mm (17.0 inches).

Printing full-bleed images

Because the product can print on specially cut paper up to 312 x 470 mm (12.3 x 18.5 inches), you can print bleed images of up to 297 x 450 mm (11.7 x 17.7 inches) in size by using crop marks. Full-bleed images can be printed from Tray 1 only. The default for edge-to-edge or full-bleed printing is “off”. See your program help for more information.

3 Advanced printing tasks

Overview

This section presents these advanced printing tasks:

- Using features in the printer driver
- Setting the registration
- Using a different first page
- Including a blank back page
- Printing multiple pages on one sheet of paper
- Customizing optional Tray 1 operation
- Specifying paper to print on
- Using the job-storage features
 - Printing a private job
 - Storing a print job
 - QuickCopying a job
 - Proofing and holding a job

Using features in the printer driver

When you print from a software program, many of the printer features are available from the printer driver. To gain access to Windows printer drivers, see [Gaining access to the printer drivers](#).

Note

Settings in the printer driver and software program generally override control-panel settings. (Software program settings generally override printer driver settings.)

Printer collation

The printer collation feature allows multiple original prints (mopying) that provide you the following advantages:

- reduced network traffic
- faster return to the software program
- all original documents

Saving printer setup information

Printer drivers allow you to save the printer settings you use most often as the default settings. For example, the driver might be set to print on 2 sides (duplex).

All printer drivers for Windows 2000 and Windows XP, and PCL 6 and PCL 5e printer drivers for Windows 9X, ME, and NT 4.0 allow you to save printer settings for multiple kinds of print jobs. For example, you might want to create a quick set for envelopes, or for printing the first page of a document on letterhead.

New printer driver features

Look for **Quick Sets**, **Scale to Fit** (any page size to any page size), and **Booklet Printing** options in the Windows printer driver, or see the printer driver help for more information.

Printing watermarks











A watermark is a notice, such as “Top Secret,” printed in the background of each page in a document. Check the driver for available options, or see the printer driver online help for more information.

For Macintosh, you can select “Custom” and specify the text you choose, depending on your driver version.









Setting the registration

Use the Set Registration feature to center the front and back images on a page that has been duplexed (printed on both sides). This feature also helps you set edge-to-edge printing to within approximately 2 millimeters (0.1 inch) of all edges of the paper. Image placement will vary slightly for each input tray. The alignment procedure must be performed for each tray. The administrator can use an internal-tray registration page to calibrate each tray.

To set the registration

- 1 Press  to open the menus.
- 2 Use  and  to scroll to `CONFIGURE DEVICE` and then press .
- 3 Use  and  to scroll to `PRINT QUALITY` and then press .
- 4 Use  and  to scroll to `SET REGISTRATION` and then press .

You can select a tray by specifying a `SOURCE`. The default `SOURCE` is tray 2. If you want to set the registration for tray 2, go to step 7. Otherwise, proceed to the next step.

- 5 Use  and  to scroll to `SOURCE` and then press .
- 6 Use  and  to select a tray and then press . After selecting a tray, the control-panel display returns to the `SET REGISTRATION` menu.
- 7 Use  and  to scroll to `PRINT TEST PAGE` and then press .
- 8 Follow the instructions on the printed page.

Using a different first page

To print a different first page

Follow these instructions for printing a first page that is different from other pages in the print job. The instructions are provided for Tray 1, however, you can print a different first page from other trays.

- 1 For Windows, select “Use different paper for first page” in your printer driver. Select one tray for the first page and one of the other trays for the remaining pages. Place the paper for the first page in the first tray that you selected. (For manual feed, place paper in optional Tray 1 after the job is sent to the printer and the printer requests paper.) For loading optional Tray 1, place the paper with the side to be printed on facing up, the top of the page toward the rear of the printer.
For Macintosh computers, select “First from” and “Remaining from” in the **Print** dialog box.

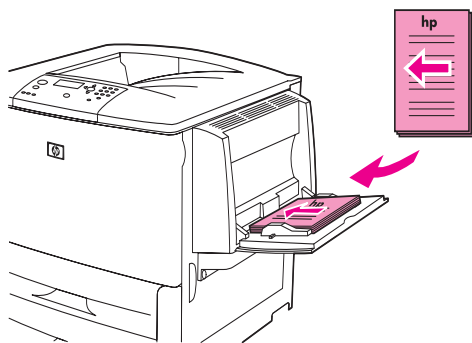

Note

Where and how you make selections depends on your software program or associated printer driver. (Some options are only available through the printer driver.)

- 2 Load the paper for the remaining pages of the document into another tray. You can select the first and remaining pages by type of paper. For more information, see [Specifying paper to print on](#).

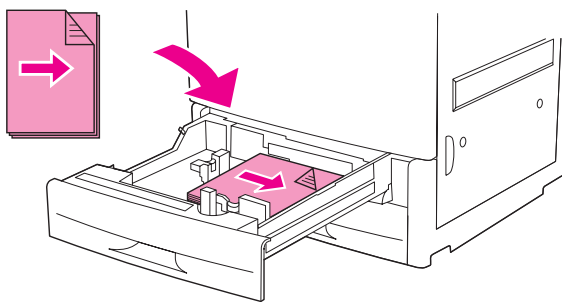

Including a blank back page

This option allows you to add blank pages to the end of a print job.

For Windows, select **Use different paper for first page** on the **Paper** tab of your printer driver, and then select **Back Page**. You can then select the paper source you want to use for your back page. To turn the feature off, select **No back page**.

Printing multiple pages on one sheet of paper

You can print more than one page on a single sheet of paper. This feature is available in some printer drivers and provides a cost-effective way to print draft pages.

To print more than one page on a sheet of paper, look for a layout or pages per sheet option in the printer driver. (This is sometimes called 2-up, 4-up, or n-up printing.)

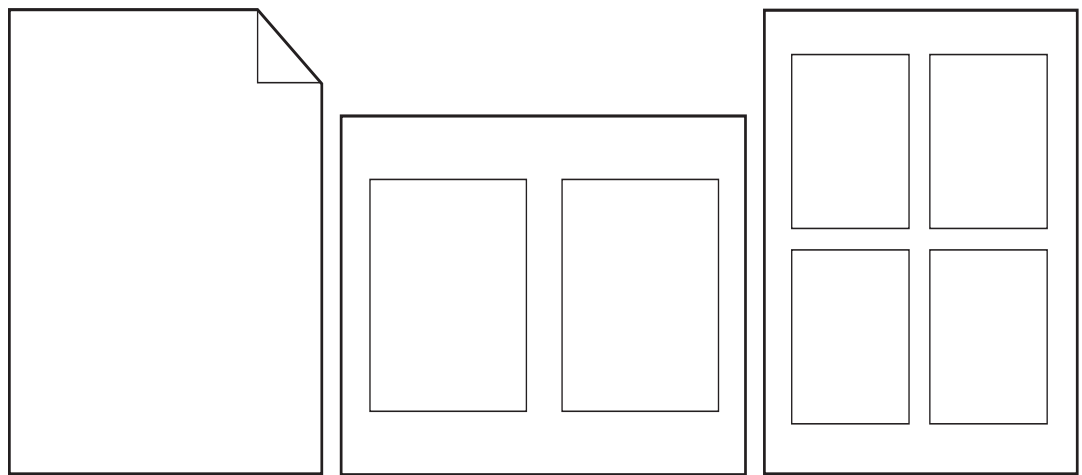

Customizing optional Tray 1 operation

Customize optional Tray 1 to fit your printing needs.

The printer can be set to print from optional Tray 1:

- When the tray is loaded and `TRAY 1 SIZE=ANY SIZE` and `TRAY 1 TYPE=ANY TYPE`; (formerly **First** mode). Print speed might be slower than normal.
- Only when the type of paper loaded is specifically requested and `TRAY 1 SIZE=a specific size` and `TRAY 1 TYPE=a specific type` (formerly **Cassette** mode).

Printing from optional Tray 1 when the loaded paper is requested

When `TRAY 1 SIZE=a specific size` and `TRAY 1 TYPE=a specific type` (formerly **Cassette** mode), the printer treats optional Tray 1 like the internal trays. Instead of looking for paper in optional Tray 1 first, the printer pulls paper starting either from the bottom tray upward or starting with the tray that matches type or size settings selected in the program from which you are printing.

From the program or the **Print** dialog box, select the type and size for a tray, if possible. If not, set the type and size from the printer control panel. (See [Specifying paper to print on.](#))

When `TRAY 1 SIZE=a specific size` and `TRAY 1 TYPE=a specific type` is set at the printer control panel, an option appears in the `PAPER HANDLING` menu to configure **size** as well as **type** settings for optional Tray 1.

Manually feeding paper from optional Tray 1

The manual feed feature is another way of printing special paper from optional Tray 1, such as envelopes or letterhead.

Specifying paper to print on

You can configure the printer to select paper by *type* (such as plain or letterhead) and *size* (such as letter or A4), as opposed to *source* (a paper tray).

Printing by Type and Size means that the printer pulls paper from the first tray that is loaded with the type or size that you select. Selecting paper by type rather than source is similar to locking out trays, which helps to protect special paper from accidental use. (However, selecting the ANY SIZE, ANY TYPE, or PLAIN setting does not turn on the tray lock-out function.)

For example, if Tray 2 is configured for letterhead, and you specify in the driver that you want to print on plain paper, the printer will not pull the letterhead from Tray 2. Instead, the printer pulls paper from a tray that has plain paper loaded and is configured for plain paper on the printer control panel.

Selecting paper by type and size results in significantly better print quality for heavy paper, glossy paper, and transparencies. Using the wrong setting can result in unsatisfactory print quality. Always print by *type* for special print media such as labels or grayscale transparencies. *Always* print by *size* for envelopes.

Benefits of printing by type and size of paper

If you frequently use several kinds of paper, once trays are set correctly, you do not have to check which paper is loaded in each tray before you print. This is especially helpful when the printer is shared and more than one person loads or removes paper. Printing by type and size of paper is a way to be sure that print jobs always print on the appropriate paper.

To set the type for the paper or media you loaded when you are unsure which type (such as bond or recycled) to choose, check the label on the package of paper. For supported types of paper, see [Paper specifications](#) or go to www.hp.com/support/lj9050_lj9040.

Note

The type and size settings can also be configured from the embedded Web server or HP Web Jetadmin software for networked printers. See the printer driver online help.

To print by type and size of paper

Note

Settings in the printer driver and software program override control-panel settings. (Software program settings generally override printer driver settings.)

- 1 Load and adjust the trays. (See [Loading input trays](#), or go to www.hp.com/support/lj9050_lj9040.)
- 2 At the printer control panel, press ✓, use ▲ or ▼ to scroll to PAPER HANDLING, and then press ✓.
- 3 Do one of the following:
 - To allow the printer to automatically pull the type and size of paper loaded in optional Tray 1: Set TRAY 1 SIZE=ANY SIZE and TRAY 1 TYPE=ANY TYPE.
 - To print by type and size from optional Tray 1: Set TRAY 1 SIZE to the size loaded, and set TRAY 1 TYPE to the type loaded.
 - To print by type and size from Tray 2, Tray 3, or optional Tray 4 when the tray is loaded with standard size paper: Just set the type. If the size is a detectable standard size, it will be automatically detected. If the size is an undetectable size, set the size.
 - To print by type and size from Tray 2, Tray 3, or optional Tray 4 when the tray is loaded with a custom size paper: set the size and type. For the size, select **Custom**, and then set the values using the measurements on the guides in the trays.
- 4 From the program or printer driver, select the type and size of paper.

Using the job-storage features

Four special job-storage features are available for this printer. All four are available when a hard disk is installed. Private jobs and proof and hold jobs are available in RAM (with no hard disk installed).

- **Private jobs.** When you send a private job to the printer, the job does not print until you enter a PIN at the printer.
- **Stored jobs.** You can download a job such as a personnel form, time sheet, or calendar, to the printer and allow other users to print the job at any time. Stored jobs are copied to the optional hard disk and are not deleted if retention space on the printer becomes limited.
- **QuickCopy jobs.** You can print the requested number of copies of a job and then store a copy of the job on the optional hard disk in the printer. Storing the job allows you to print additional copies of the job later.
- **Proof and hold jobs.** This feature provides a quick and easy way to print and proof one copy of a job and then print the additional copies.

Follow the instructions below to gain access to the job retention features at the computer. Then, see the specific section for the type of job you want to create.

CAUTION

If you turn the printer off, all QuickCopy, Proof and hold, and Private jobs are deleted.

To gain access to the job storage features

For Windows

- 1 On the **File** menu, click **Print**.
- 2 Click **Properties** and click the **Job Storage** tab.
- 3 Select the desired **Job Storage Mode**.

For Macintosh

In newer drivers: Select **Job Retention** from the pull-down menu in the print dialog box. In older drivers, select **Printer Specific Options**.

Printing a private job

The private printing feature lets a user specify that a job is not printed until that user releases it using a 4-digit personal identification number (PIN) through the printer control panel. The user specifies the PIN in the driver, and the PIN is sent to the printer as part of the print job.

Note

The private jobs feature uses available printer RAM memory if the printer does not have a hard disk installed. For moderate to heavy use of this feature, HP recommends installing an optional hard disk.













To create private jobs

To specify that a job is private from the driver, select the Private Job option, enter a User Name and Job Name, and type a 4-digit PIN. The job will not print until you enter the PIN at the control panel.

Releasing private jobs

The user can print a private job from the control panel.













To release private jobs

- 1 Press .
- 2 Use  or  to scroll to `Retrieve Job` and then press .
- 3 Scroll to `USER NAME` and press .
- 4 Use  or  to scroll to your job and then press .
- 5 Use  or  to scroll to `Print` and then press . (The `Print` icon should have  next to it.)
- 6 Use the numeric keypad to type the PIN, and then press .

Deleting a private job

A private job is automatically deleted from the printer hard disk accessory after the user releases it for printing. If you want to delete the job without printing it, use this procedure.

To delete private jobs

- 1 Press .
- 2 Use  or  to scroll to `Retrieve Job` and then press .
- 3 Scroll to `USER NAME` and press .
- 4 Use  or  to scroll to your job and then press .
- 5 Use  or  to scroll to `Delete` and then press . (`Delete` should have  next to it.)
- 6 Use the numeric keypad to type the PIN, and then press .

Storing a print job

The user can download a print job to the printer hard disk accessory without printing it. The user can then print the job at any time through the printer control panel. For example, a user might want to download a personnel form, calendar, time sheet, or accounting form that other users can access and print.

To store a print job on the hard disk accessory, select the **Stored Job** option in the driver when printing from the printer.

Note

The stored job feature uses available RAM memory on the printer if the printer does not have a hard disk installed. For moderate to heavy use of this feature, HP recommends installing an optional hard disk.













To create stored jobs

In the printer driver, select the **Stored Job** option and type a user name and job name. The job does not print until someone requests it at the printer. See [Printing a stored job](#).

Printing a stored job

The user can print a job stored on the printer hard disk accessory from the control panel.

To print a stored job











- 1 Press .
- 2 Use  or  to scroll to `Retrieve Job` and then press .
- 3 Scroll to `USER NAME` and press .
- 4 Use  or  to scroll to your job and then press .
- 5 To print the default number of copies, press . When  is selected, the screen changes to `Copies=n`. To change the number, use the numeric keypad or  and  to select a new number, and then press .

If `Print` has  next to it, the job is a private job and requires a PIN. See [Printing a private job](#).

Deleting a stored job

Jobs stored on the printer hard disk accessory can be deleted from the control panel.

To delete a stored job

- 1 Press .
- 2 Use  or  to scroll to `Retrieve Job` and then press .
- 3 Scroll to `USER NAME` and press .
- 4 Use  or  to scroll to your job and then press .
- 5 Use  or  to scroll to `Delete` and then press .

If `Delete` has  next to it, the job requires a PIN to delete. See [Printing a private job](#).

QuickCopying a job

The QuickCopy feature prints the requested number of copies of a job and stores a copy on the printer hard disk accessory. Additional copies of the job can be printed later. This feature can be turned off from the driver.

The default number of different QuickCopy jobs that can be stored on the printer is 32. From the control panel, you can set a different default number. See [JOB STORAGE LIMIT=32](#).

To create QuickCopy jobs

CAUTION

If the printer needs additional space to store newer QuickCopy jobs, the printer will delete other stored QuickCopy jobs, starting with the oldest job. To permanently store the job and prevent the printer from deleting it when space is needed, select the **Stored Job** option instead of the **QuickCopy** option.

















In the printer driver, select the **QuickCopy** option and type a user name and a job name.

When you send the job to print, the printer prints the number of copies you set in the printer driver. To print more quick copies at the printer, see [Printing additional copies of QuickCopy jobs](#).

Printing additional copies of QuickCopy jobs

This section describes how to print additional copies of a job stored on the printer hard disk accessory from the control panel.

To print more copies of a QuickCopy job

- 1 Press .
- 2 Use  or  to scroll to `Retrieve Job` and then press .
- 3 Scroll to `USER NAME` and press .
- 4 Use  or  to scroll to your job and then press .
- 5 To print the default number of copies, go to the next step. Otherwise, to check or change the number of copies to print:
 - a Use  or  to scroll to `Copies` and then press . The number of copies to be printed appears at the top of the window.
 - b To change the number, use the numeric keypad or  and  to select a new number and then press .
- 6 Use  or  to scroll to `Print` and then press . The job prints.

If `Print` has  next to it, the job requires a PIN to print. See [Printing a private job](#).













Deleting a QuickCopy job

Delete a QuickCopy job at the printer when you no longer need it. If the printer needs additional space to store new QuickCopy jobs, the printer will automatically delete other stored QuickCopy jobs, starting with the oldest job.

Note

Stored QuickCopy jobs can be deleted from the control panel or from HP Web Jetadmin.

To delete a QuickCopy job

- 1 Press .
 - 2 Use  or  to scroll to `Retrieve Job` and then press .
 - 3 Scroll to `USER NAME` and press .
 - 4 Use  or  to scroll to your job and then press .
 - 5 Use  or  to scroll to `Delete` and then press .
- If `Delete` has  next to it, the job requires a PIN to delete. See [Printing a private job](#).

Proofing and holding a job

The proof and hold feature provides a quick and easy way to print and proof one copy of a job and then to print the additional copies.

To permanently store the job and prevent the printer from deleting it when space is needed for something else, select the **Stored Job** option in the driver.

The proof and hold feature uses available RAM memory on the printer if the printer does not have a hard disk installed. For moderate to heavy use of this feature, HP recommends installing an optional hard disk.

To create a proof and hold job

CAUTION

If the printer needs additional space to store newer proof and hold jobs, the printer will delete other stored proof and hold jobs, starting with the oldest job. To permanently store the job and prevent the printer from deleting it when space is needed, select the **Stored Job** option in the printer driver instead of the **Proof and Hold** option.











In the printer driver, select the **Proof and Hold** option and enter a user name and job name.

The printer prints one copy of the job for you to proof. Then, see [Printing the remaining copies of a held job](#).

Printing the remaining copies of a held job

The user can print the remaining copies of a job held on the printer hard disk accessory from the control panel.

To print a proof and hold job











- 1 Press .
- 2 Use  or  to scroll to `Retrieve Job` and then press .
- 3 Scroll to `USER NAME` and press .
- 4 Use  or  to scroll to your job and then press .
- 5 Use  or  to scroll to `Print` and then press . The job prints the remaining copies requested from the computer.

If `Print` has  next to it, the job requires a PIN to print. See [Printing a private job](#).

Deleting a held job

When a user sends a proof and hold job, the printer automatically deletes that user's previous proof and hold job. If no proof and hold job already exists for that job name and the printer needs additional space, the printer might delete other proof and hold jobs, starting with the oldest one.

To delete a proof and hold job

- 1 Press .
- 2 Use  or  to scroll to `Retrieve Job` and then press .
- 3 Scroll to `USER NAME` and press .
- 4 Use  or  to scroll to your job and then press .
- 5 Use  or  to scroll to `Delete` and then press .

If `Delete` has  next to it, the job requires a PIN to delete. See [Printing a private job](#).

4 Security features

Overview

This section explains important security features available on your printer:

- Secure Disk Erase
- Security lock
- Job storage features

Secure Disk Erase

You might need to protect deleted data from unauthorized access on the printer hard drive. Secure Disk Erase is a security feature that you can use to securely erase print jobs from the hard drive.

Security levels are set by using HP Web Jetadmin. Three levels of Secure Disk Erase are available:

- Non-Secure Fast Erase

This is a simple file-table erase function. Access to the file is removed, but actual data is retained on the disk until it is overwritten by subsequent data-storage operations. This is the fastest mode. Non-Secure Fast Erase is the default erase mode.

- Secure Fast Erase

Access to the file is removed, and the data is overwritten with a fixed, identical character pattern. This is slower than Non-Secure Fast Erase, but all data is overwritten. Secure Fast Erase meets the U.S. Department of Defense 5220-22.M requirements for the clearing of disk media.

- Secure Sanitizing Erase

This level is similar to the Secure Fast Erase mode. In addition, data is repetitively overwritten by using an algorithm that prevents any residual data persistence. This mode will impact performance. Secure Sanitizing Erase meets the U.S. Department of Defense 5220-22.M requirements for the sanitization of disk media.

Affected data

Data affected (covered) by the Secure Disk Erase feature includes temporary files that are created during the print and copying process, stored jobs, proof and hold jobs, disk-based fonts, and disk-based macros (forms). Note that stored jobs will only be securely overwritten when they have been deleted through the Retrieve Job menu on the device after the appropriate erase mode has been set. (See [Deleting a stored job](#).) This feature will not impact data that is stored on flash-based printer non-volatile RAM (NVRAM) that retains default printer settings, page counts, and similar data. This feature does not affect data that is stored on a system RAM disk (if one is used). This feature does not impact data that is stored on the flash-based system boot RAM.

Changing the Secure Disk Erase mode does not overwrite previous data on the disk, nor does it immediately perform a full-disk sanitization. Changing the Secure Disk Erase mode changes how the printer cleans up temporary data for jobs after the erase mode has been changed.

Gaining access to Secure Disk Erase

Use HP Web Jetadmin to set the Secure Disk Erase feature.

Additional information

For additional information about the HP Secure Disk Erase feature, see the HP support flyer or go to www.hp.com/go/webjetadmin).

Security lock

The security lock is a mechanical lock that can be used to prevent the removal of internal computer components. Optional EIO accessories are not protected, however. Purchase the lock assembly separately, and then install it on the product.

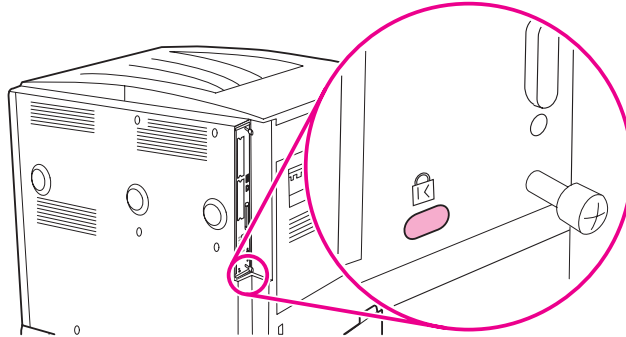

Job storage features

Several job-storage features are available for the printer. These features include printing private jobs, storing print jobs, quick-copying jobs, and proofing and holding jobs.

For more information about job storage features, see [Using the job-storage features](#).

5 Printer maintenance

Overview

This section explains basic printer maintenance.

- [Cleaning the printer](#)
- [Printer maintenance kit](#)
- [Managing the print cartridge](#)
- [Print cartridge conditions](#)

Cleaning the printer

General cleaning

To maintain print quality, clean the printer thoroughly:

- every time you change the print cartridge.
- whenever print-quality problems occur.

Clean the outside of the printer with a lightly water-dampened cloth. Clean the inside with only a dry, lint-free cloth. Observe all warnings and cautions that appear with the cleaning tasks on the following pages.

WARNING!

Avoid touching the fusing area when cleaning the printer. It can be *hot*.

CAUTION

To avoid permanent damage to the print cartridge, do not use ammonia-based cleaners on or around your printer.

To clean the printer

- 1 Before you begin these steps, turn the printer off and disconnect all cables, including the power cable.

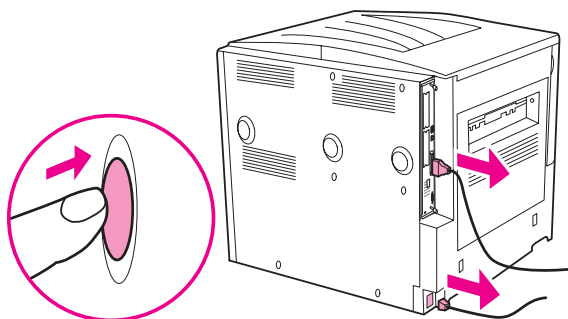

- 2 Open the front cover of the printer and remove the print cartridge.

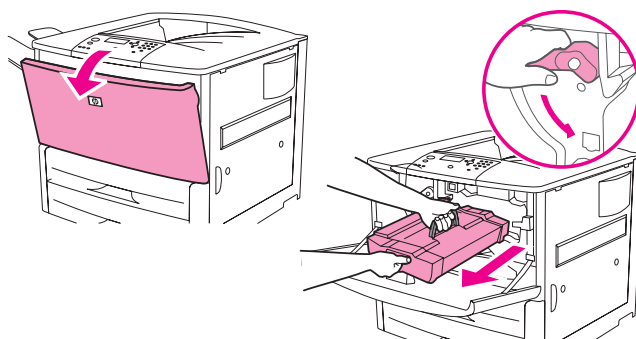

CAUTION

To prevent damage to the print cartridge, use two hands when removing it from the printer.

Do not expose the print cartridge to light for more than a few minutes. Cover the print cartridge when it is outside of the printer.

Note

If toner gets on your clothes, wipe it off with a dry cloth, and wash your clothes in cold water. *Hot water sets toner into fabric.*

- 3 With a dry, lint-free cloth, wipe any residue from the paper path area, the registration roller, and the print cartridge cavity.

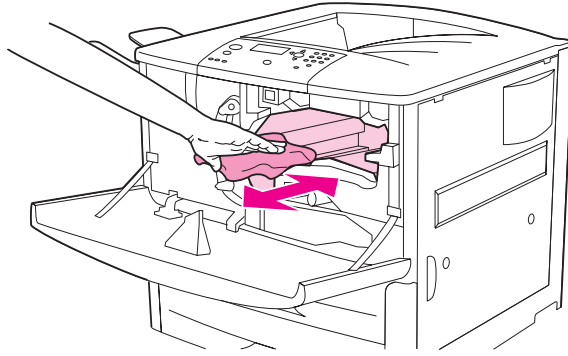

- 4 Replace the print cartridge.

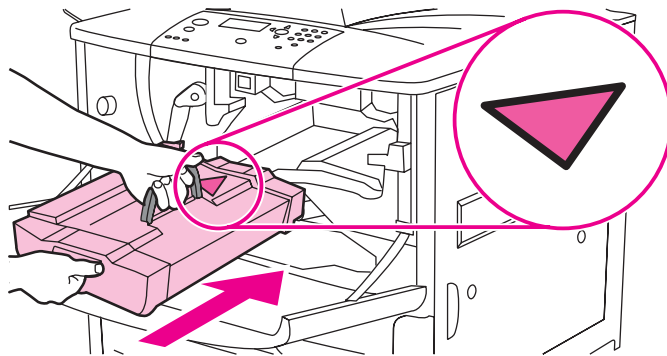

- 5 Turn the green lever back to the locked position.

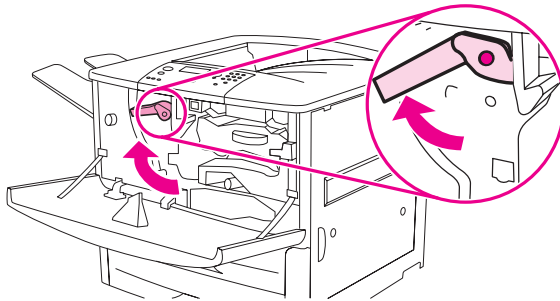

- 6 Close the front cover, reconnect all cables, and turn the printer on.

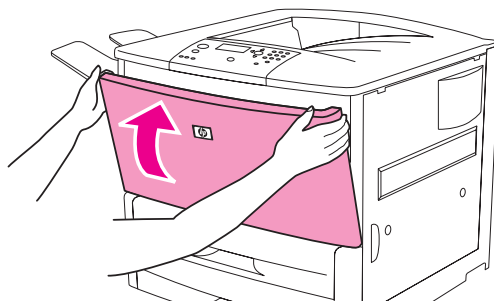

Printer maintenance kit

Note

The printer maintenance kit is a consumable and is not covered under warranty.

To ensure optimum print quality, HP recommends that the printer maintenance kit be used approximately every 350,000 pages. You might need to replace the kit more often, depending on the type of printing you do. If you have questions about how frequently you should use a maintenance kit, contact the support center at www.hp.com/support/lj9050_lj9040.

When the `PERFORM PRINTER MAINTENANCE` message appears on the control panel, you need to purchase a printer maintenance kit and install the new parts. The part number for the 110-V kit is C9152A. The part number for the 220-V kit is C9153A. The printer maintenance kit contains two Type 1 rollers, seven Type 2 rollers, one transfer roller assembly, and one fuser assembly. Complete instructions for installing the kit components are included in the printer maintenance kit box.

After a new maintenance kit is installed, reset the printer maintenance count.

To reset the printer maintenance count

- 1 Turn the printer off.
- 2 Turn the printer on.
- 3 When the memory count starts, press and hold ✓.
- 4 When the three LEDs are on, press ▲ until `NEW MAINTENANCE KIT` appears on the screen.
- 5 Press ✓.

If the message persists,

- 1 Use ▲ or ▼ to scroll to `CONFIGURE DEVICE`.
- 2 Use ▲ or ▼ to scroll to `RESETS`.
- 3 Press ✓.
- 4 Use ▲ or ▼ to scroll to `CLEAR MAINTENANCE MESSAGE`.
- 5 Press ✓.

To verify that the maintenance kit is reset to zero, print a configuration page by using the following procedure.

To print a configuration page

- 1 Press ✓.
- 2 Use ▲ or ▼ to scroll to `INFORMATION`, and press ✓.
- 3 Use ▲ or ▼ to scroll to `PRINT CONFIGURATION`, and press ✓.

For more information about installing the printer maintenance kit, see the instructions that accompany it.

Managing the print cartridge

When you use a new, authentic HP print cartridge (C8543X), you can obtain the following types of supplies information:

- amount of cartridge life remaining
- estimated number of pages remaining
- number of pages printed
- other supplies information

Print cartridge authentication

The printer will let you know that a cartridge is not a genuine HP print cartridge when you insert it in the printer. If you insert a used HP cartridge from another HP printer, the printer can take as many as 20 printed pages to receive the message authenticating that the cartridge is a genuine HP part.

If the printer control-panel message states that this is not a genuine HP print cartridge and you believe you purchased an HP cartridge, go to www.hp.com/go/anticounterfeit.

Non-HP print cartridges

Hewlett-Packard Company cannot recommend use of non-HP print cartridges, either new or remanufactured. Because they are not HP products, HP cannot influence their design or control their quality. Service or repairs required as a result of using a non-HP print cartridge will *not* be covered under the printer warranty.

Print cartridge storage

Do not remove the print cartridge from its package until you are ready to use it.









CAUTION

To prevent damage to the print cartridge, do not expose it to light for more than a few minutes.

Checking the toner level

You can check the toner level by using the printer control panel, the embedded Web server, the printer software, or HP Web Jetadmin.

Using the printer control panel

- 1 Press  to open Menu.
- 2 Use  or  to select INFORMATION and then press .
- 3 Use  or  to select PRINT SUPPLIES STATUS PAGE and then press .
- 4 Press  to print the supplies status page. See [Supplies status page](#) for information about the supplies status page.

Using the embedded Web server

- 1 In your Web browser, type the IP address for the printer home page. This takes you to the printer status page.
- 2 On the left side of the screen, click **Supplies Status**. This takes you to the supplies status page, which provides toner level information. See [Supplies status page](#) for information about the supplies status page.

Using printer software

The following conditions must be met in order to use this feature:

- The HP Toolbox software must be installed on your computer. (HP Toolbox is automatically installed as part of the typical printer software installation.)
- The printer must be connected to a network.
- You must have access to the World Wide Web to order supplies.

To use the printer software

- 1 On the **Start** menu, select **Programs**, and then click **HP toolbox**.

The HP Toolbox opens in a Web browser.

- 2 On the left side of the window, click the **Status** tab, and then click **Supplies Status**.

Note

If you want to order supplies, click **Order Supplies**. This opens a browser that produces a URL where you can purchase supplies. Select the supplies that you want to order and then finish the ordering process.

Using HP Web Jetadmin

In HP Web Jetadmin, select the printer device. The device status page shows toner level information.

Print cartridge conditions

Use these procedures when you see a message that relates to the print cartridge, or when you want to change or replace a print cartridge.

Order the print cartridge

When the print cartridge is low, the message `ORDER CARTRIDGE` appears on the printer control panel.

If the `ORDER CARTRIDGE` message appears but the printer continues printing, the `CARTRIDGE LOW` setting is set to `CONTINUE` (the default setting).

If the printer stops printing when low toner is detected, `CARTRIDGE LOW` is set to `STOP`. To resume printing, press `✓`.

The message `ORDER CARTRIDGE` will continue to appear until you replace the print cartridge.

Select `CARTRIDGE LOW=CONTINUE` or `CARTRIDGE LOW=STOP` from the Configuration menu on the printer control panel (see [System setup submenu](#)).

HP recommends that you place an order for a replacement print cartridge when you first receive an `ORDER CARTRIDGE` alert. You can order a cartridge by using the Internet Enabled Supplies Ordering feature. To do so, click the printer icon on the bottom right of your screen, click the icon for the printer that you use, and then click the Order Supplies link on the status page. In a network environment, use the embedded Web server to order supplies online.

Replace the print cartridge

When the print cartridge is empty, a `REPLACE CARTRIDGE` message appears on the printer control panel. The printer continues printing (without customer interaction) until it reaches a drum-out condition, but HP does not guarantee print quality after this message appears. However, if the `REPLACE CARTRIDGE` message results from the drum life being exceeded, the user has to replace the cartridge immediately, and no override is possible. This is done to protect the printer and the print cartridge.

Recycling

For information about recycling the print cartridge, see [Protecting the environment](#) or go to www.hp.com/recycle.

Using the printer cleaning page

Note

To ensure good print quality with certain types of paper, use the cleaning page every time the print cartridge is replaced. If the cleaning page is frequently needed, try a different type of paper.

If toner specks appear on the front or back side of your print jobs, use the following procedure.

From the printer control panel:

- 1 Use ▲ or ▼ to select `Configure Device` and then press ✓.
- 2 Use ▲ or ▼ to select `Print Quality` and then press ✓.
- 3 Use ▲ or ▼ to select `Create Cleaning Page` and then press ✓.
- 4 Follow the instructions on the cleaning page.
- 5 When toner has been cleaned from inside the printer, shiny black spots will appear on the page black strip. If white spots appear on the black strip, print another cleaning page.

Note

In order for the cleaning page to work correctly, print the cleaning page on copier-grade paper (not bond or rough paper).

Rocking the print cartridge

When you install a print cartridge for the first time, gently rock the cartridge from front to back to distribute the toner evenly inside the cartridge. Because of the new cartridge design, this is the only time that you need to rock the cartridge.

Configuring alerts

You can use HP Web Jetadmin or the embedded Web server in the printer to configure the system to alert you to problems with the printer. The alerts take the form of e-mail messages that are sent to the e-mail account or accounts that you specify.

You can configure the following items:

- the printer(s) that you want to monitor.
- which alerts are to be received (for example, alerts for paper jams, paper out, order cartridge, replace cartridge, and cover open)
- the e-mail account to which the alerts should be forwarded

Software	Location for information
HP Web Jetadmin	See the HP Web Jetadmin Help system for details on alerts and how to set them up.

Software	Location for information
Embedded Web server	See Using the embedded Web server for general information about the embedded Web server. See the embedded Web server Help system for details on alerts and how to set them up.

You can also receive alerts through the HP Toolbox software. These alerts display as either a pop-up window or an animated taskbar icon. The HP Toolbox software does not send alerts in the form of an e-mail message. You can configure the HP Toolbox software to deliver only the alerts that you want to receive, and you can also specify how often the software checks the printer status. See [HP Toolbox](#) for more information.

6 Problem solving

Overview

This section will help you to troubleshoot and solve printer problems.

Clearing jams	Occasionally, paper can jam during printing. This section will help you to locate paper jams, properly clear them from the printer, and solve repeated jams.
Understanding printer messages	Many different messages can appear on the printer control-panel display. Some messages tell the current printer status, such as <code>INITIALIZING</code> . Other messages require action, such as <code>CLOSE RIGHT DOOR</code> . Most of these messages are self-explanatory. However, some messages indicate a problem with the printer, or require further action or description. This section lists these types of messages and tells you what to do if a message persists.
Resolving control-panel messages	This section lists messages that might appear on the control panel and explains what causes the message and what action can be taken to resolve the message
Correcting output quality problems	The printer should produce print jobs of the highest quality. If print jobs do not appear sharp and clear, if defects such as lines, specks, or smears appear on the page, or if paper is wrinkled or curled, use this section to troubleshoot and solve the print quality problem.
Solving common printer issues	Before you can eliminate a printer problem, you must understand the location of the problem. Use the tables in this section to determine the printer problem, and then follow the corresponding troubleshooting suggestions.
Using the embedded Web server	The pages that give information about the printer are on the embedded Web server.
Printing information pages	These pages can be printed from the printer control panel.
Checking the printer configuration	From the printer, you can print information pages, which give details about the printer and its configuration.
Printing a paper path test	The paper path test can be used to verify that various paper paths are working properly.

Clearing jams

If a paper-jam message appears on the printer control panel, look for paper in the locations that are indicated in the following graphic. You might need to look for paper in locations other than those that are indicated in the paper-jam message. If the location of the paper jam is not obvious, look first in the front-door area.

After looking at the graphic, you can go to the procedure for clearing the jam. When clearing jams, be very careful not to tear the paper. If a small piece of paper is left in the printer, it could cause additional jams. If jams are a recurring problem, see [Solving repeated paper jams](#).

Note

Loose toner might remain in the printer after a paper jam and cause output quality problems. These should clear up within a few pages.

Jam locations

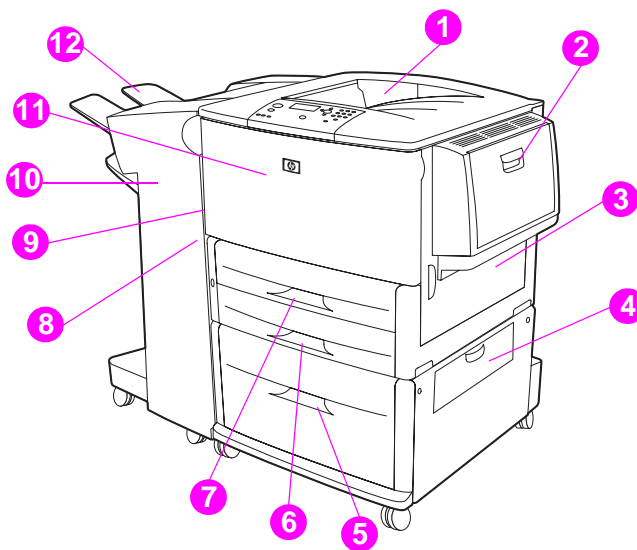

1. Standard top bin (face-down output bin)
2. Optional Tray 1
3. Right door
4. Vertical transfer door
5. Optional Tray 4
6. Tray 3
7. Tray 2
8. Left door (behind output accessory)
9. Duplexer (inside the printer)
10. Optional output device
11. Front door and print cartridge area
12. Upper bin (face-up output bin)

Clearing jams from the input tray areas

To clear jams in optional Tray 1

- 1 Check for paper in the optional Tray 1 area, and remove any paper from this area. Carefully check to be sure you have removed all pieces of torn paper.

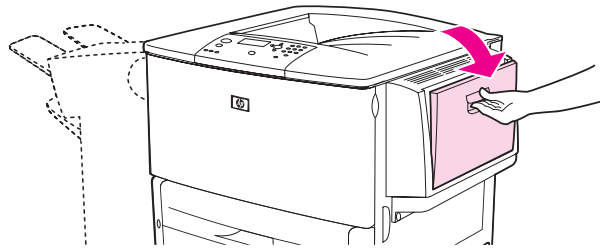

- 2 Open and close the right door to reset the printer.

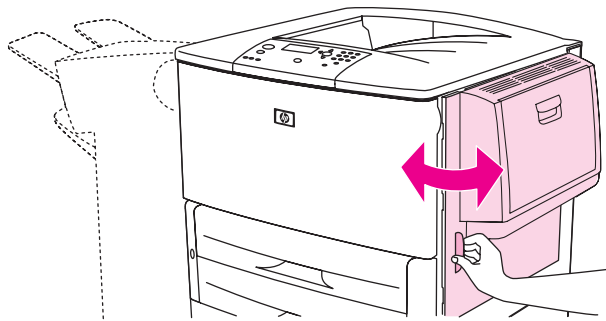

To clear jams inside the right door

- 1 Open the right door.

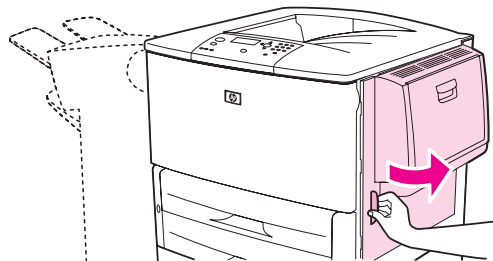

- 2 Check for paper in the right door area, and remove any paper from this area. Carefully check to be sure you have removed all pieces of torn paper.

- 3 Open the jam access cover. Pull out and lift the green tab.

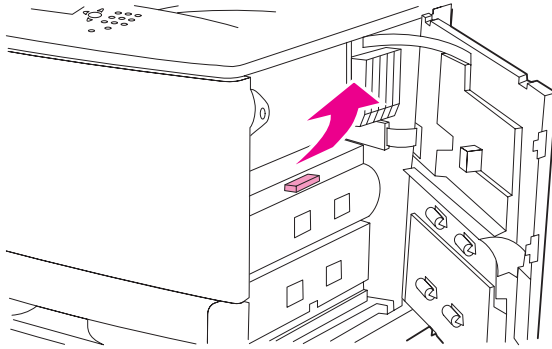

- 4 Remove any paper from this area by pulling it out of the printer.
- 5 Push the green lever down to original position.

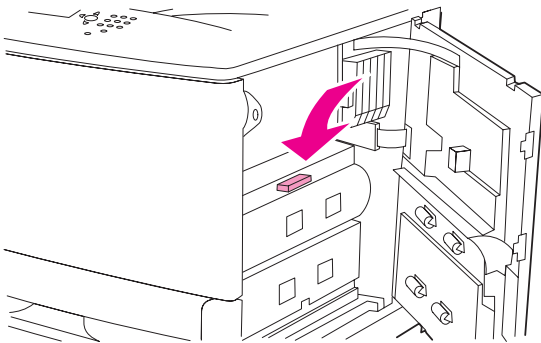

- 6 Close the right door.

To clear jams in Trays 2 and 3

- 1 Open the tray until it stops.

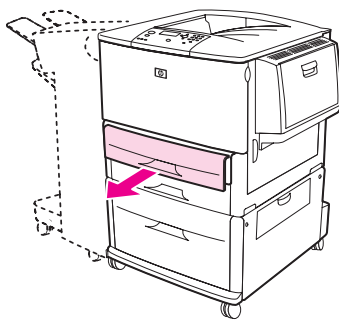

- 2 Check for paper in the tray area, and remove any paper from this area. Carefully check to be sure you have removed all pieces of torn paper.

- 3 Close the tray.

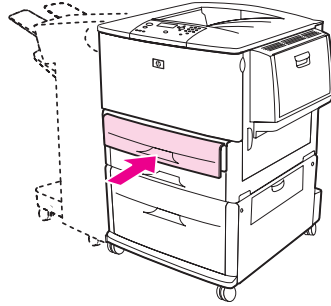

- 4 Open and close the right door to reset the printer.

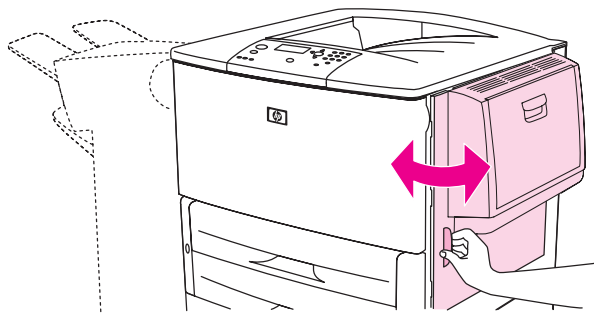

To clear jams in optional Tray 4

- 1 Open the vertical transfer door on optional Tray 4.

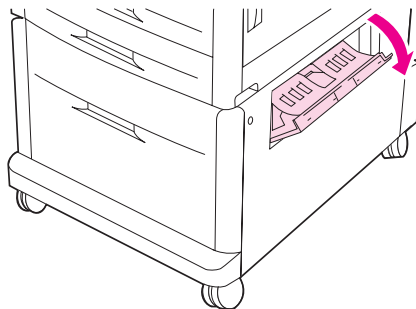

- 2 Check for paper in this area, and remove any paper from this area. Carefully check to be sure that you have removed all pieces of torn paper.

- 3 If you did not see any paper in the right access door, open optional Tray 4.

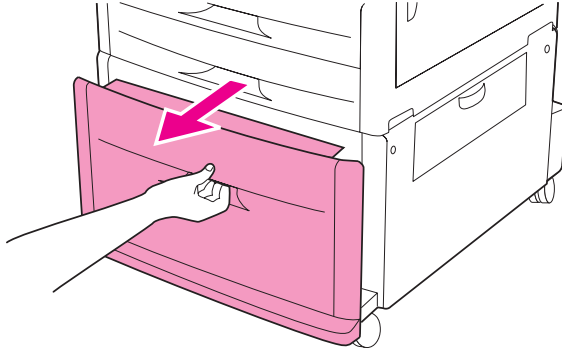

- 4 Check for paper in the tray area, and remove any paper from this area. Carefully check to be sure you have removed all pieces of torn paper.
- 5 Close optional Tray 4.

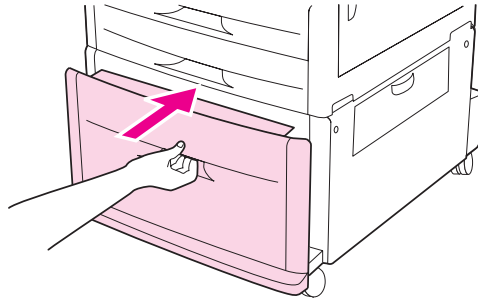

- 6 Close the vertical transfer door.

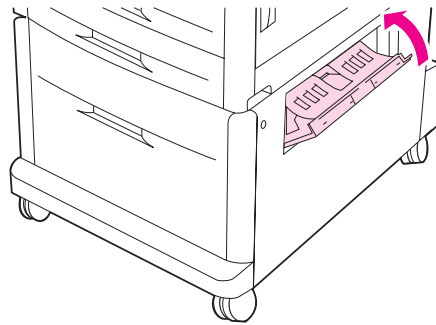

Clearing jams from the duplex printing accessory (duplexer)

To clear jams in the duplex printing accessory

- 1 If an optional output device is installed, slide it away from the printer to access the left door.

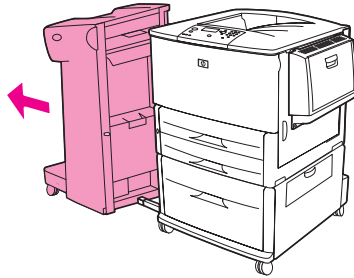

- 2 Open the left door and carefully pull out any paper from area.

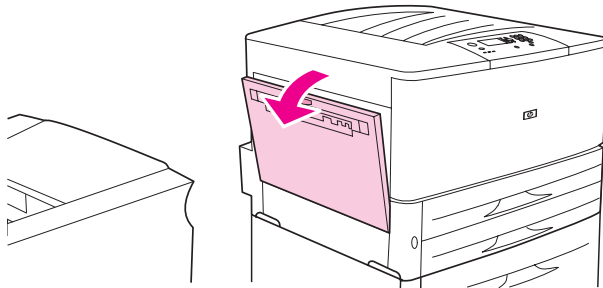

WARNING!

Avoid touching the adjacent fusing area. It can be *hot*.

- 3 Remove the duplex printing accessory by pressing the green lever and pulling the unit out until it stops.

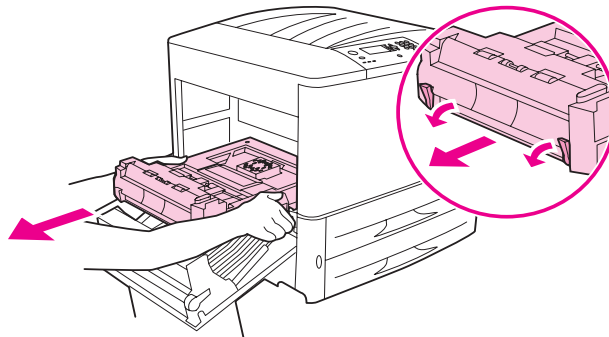

- 4 Remove any paper by lifting the two green levers in the duplex printing accessory.

- 5 Open the front door.

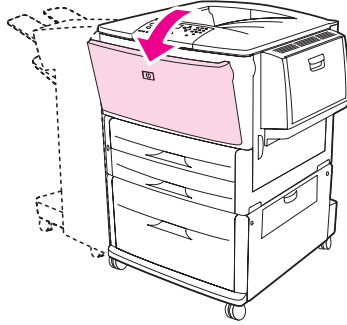

- 6 Check for paper in the duplex printing accessory area, and remove any paper by pulling it out of the printer. Be careful not to tear the paper.

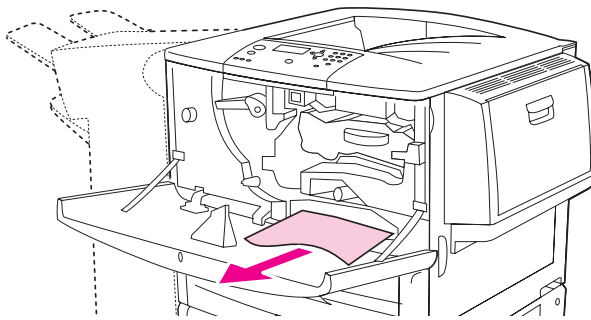

- 7 Reinstall the duplex printing accessory by sliding it back into the slot until it locks into place.

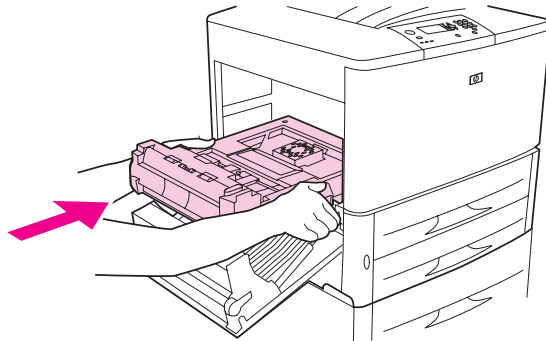

- 8 Close all open doors. If an optional output device is installed, push it back into place.

Clearing jams from the output areas

To clear jams in the standard output bin

- 1 If the jam extends into the output area, slowly and carefully pull the paper straight out of the printer so that it does not tear.

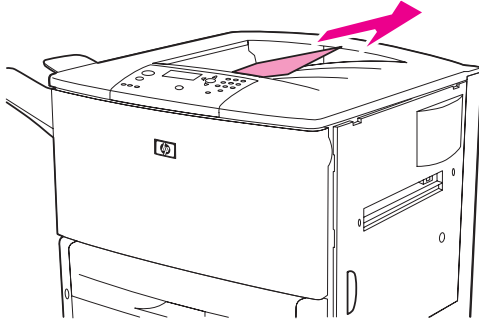

- 2 Open the left door and carefully pull out any paper from area. (If an optional output device is installed, first move it away from the printer to access the left door.)

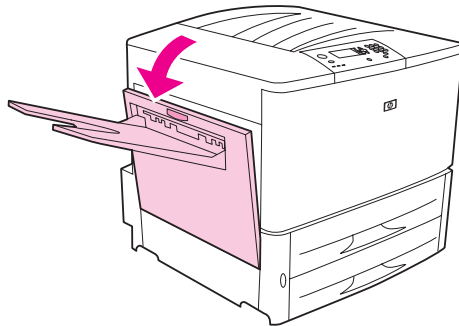

- 3 Close all open doors. If an optional output device is installed, push it back into place.

To clear jams in the left door (fuser area)

- 1 If an optional output device is installed, slide it away from the printer to access the left door.

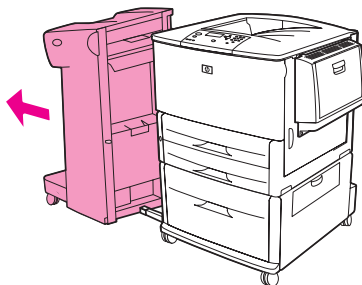

- 2 Open the left door.

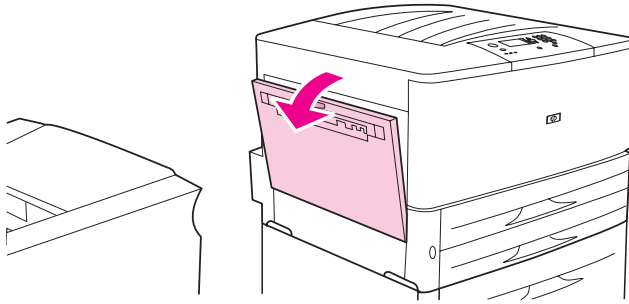

WARNING!

Avoid touching the adjacent fusing area. It can be *hot*.

- 3 Remove any jammed or damaged paper from this area by pulling it out of the printer.
- 4 Press down on the green tab and carefully check for paper. Be sure to remove all pieces of torn paper.

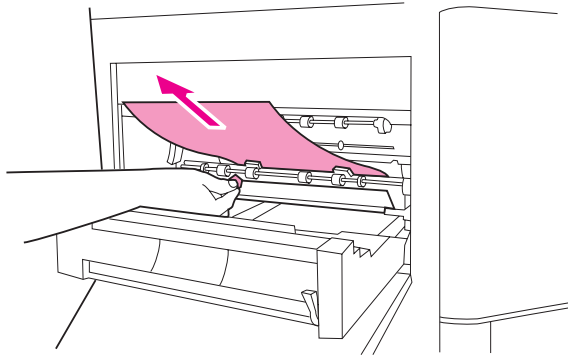

- 5 Close the left door. If an optional output device is installed, push it back into place.

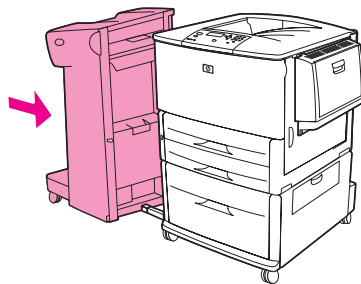

To clear jams in the multifunction finisher

- 1 Open the finisher cover.

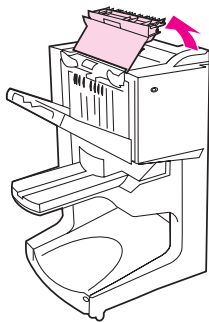

- 2 Slowly and carefully pull the paper straight out of the finisher so that it does not tear.

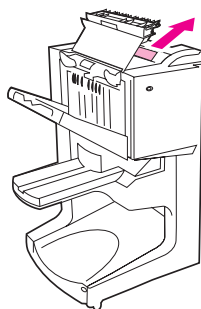

- 3 Close the finisher cover.

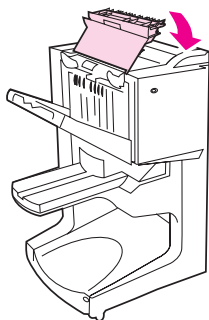

- 4 Move the finisher away from the printer.

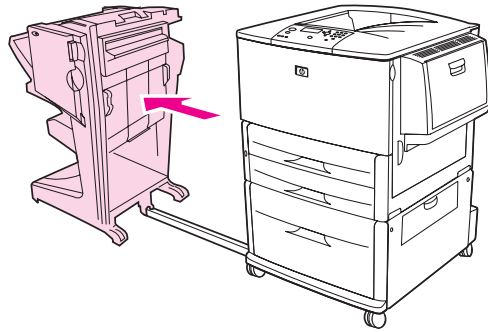

- 5 Carefully remove any paper from the printer output area.

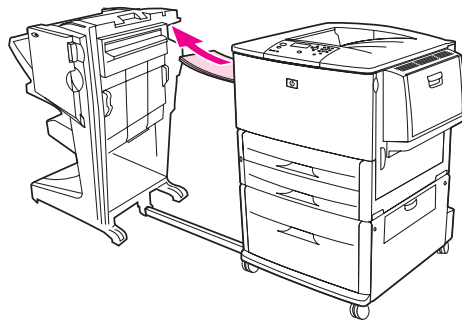

- 6 Carefully remove any paper from the finisher input area.

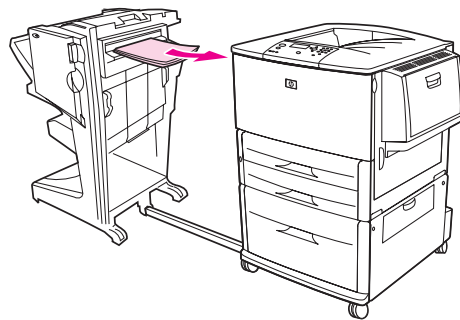

- 7 Open the stapler-unit door.

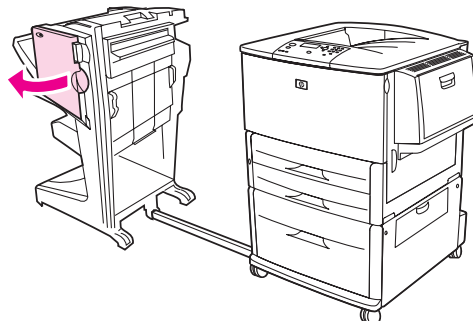

- 8 To clear a booklet jam, turn the bottom green knob clockwise to remove the booklet.

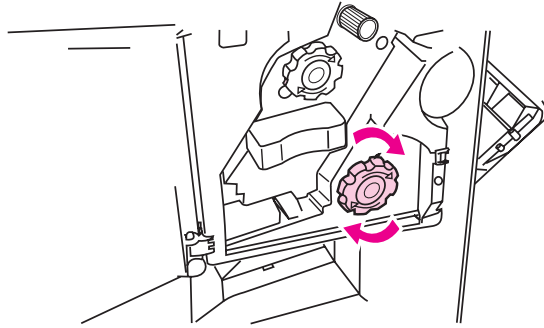

- 9 Close the stapler-unit door.

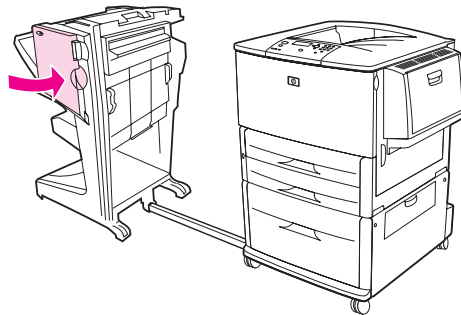

- 10 Reattach the finisher.

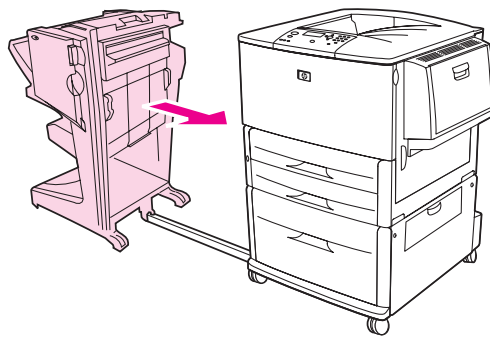

To clear a staple jam from the optional stacker/stapler

- 1 Slide the stacker/stapler away from the printer.

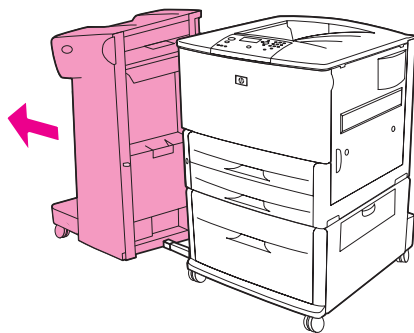

- 2 Open the stapler-unit door.

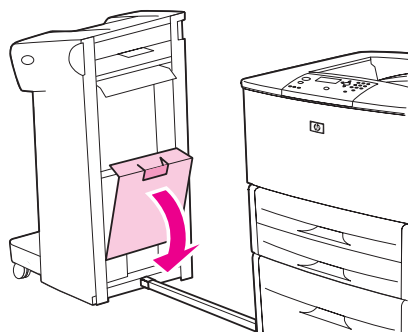

- 3 On the staple cartridge, lift up on the green tab and pull the cartridge out.

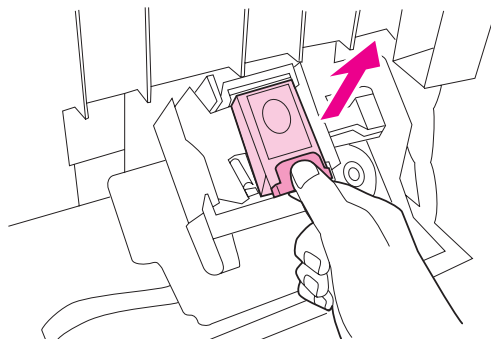

- 4 Pull the cartridge lever up.

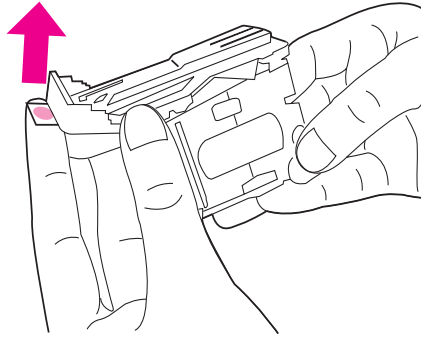

- 5 Remove the jammed staple.
- 6 Push the cartridge lever down.

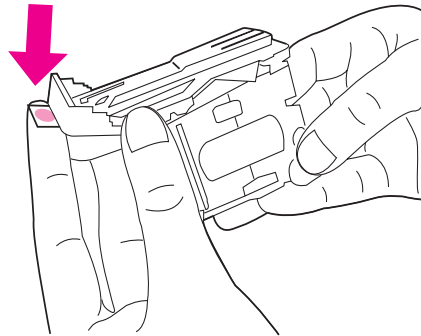

- 7 Insert the staple cartridge so that it snaps into place.

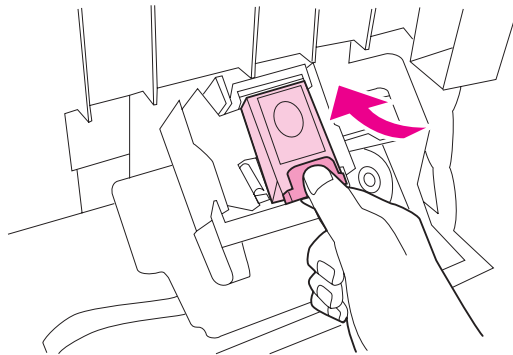

- 8 Close the stapler-unit door.

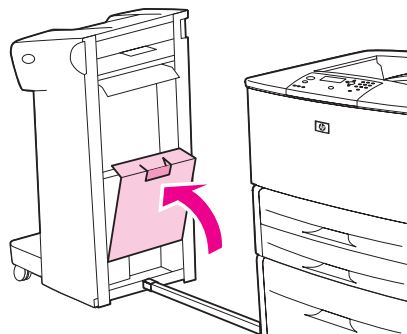

- 9 Reattach the stacker/stapler to the printer.

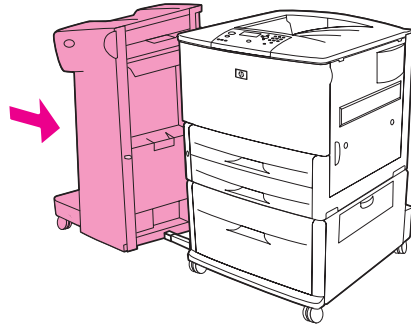

Note

The stapler needs to reload after clearing a staple jam, so the first few documents (no more than five) might not be stapled. If a print job is sent and the stapler is jammed or is out of staples, the job will still print as long as the path to the output bin is not blocked.

To clear a staple jam from the multifunction finisher

- 1 Open the stapler-unit door.

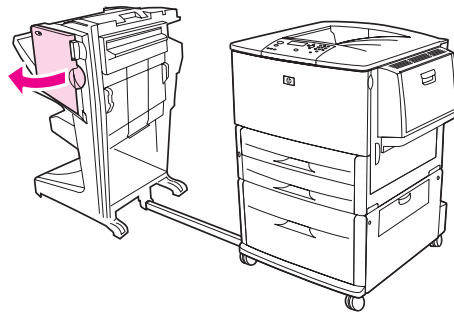

- 2 Slide the stapler unit toward you.

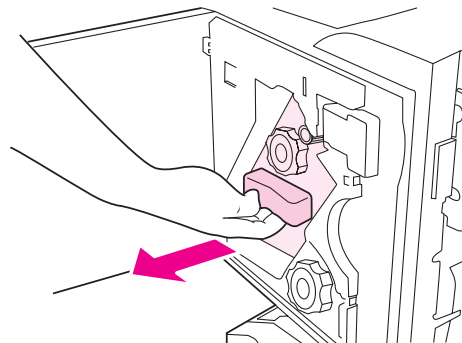

- 3 Turn the large green knob until the blue dot appears in the window of the stapler unit.

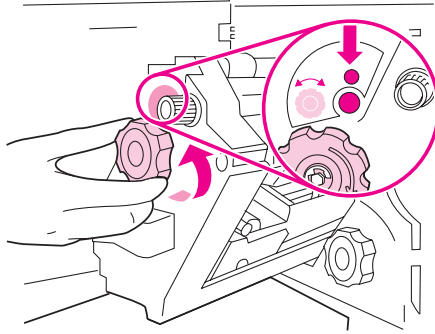

- 4 Turn the small green knob at the top of the stapler unit clockwise until the staple cartridge moves to the left of the stapler unit.

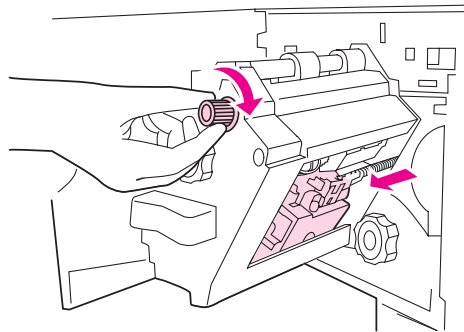

CAUTION

The blue dot must appear in the window of the stapler unit before you remove the staple cartridge. If you try to remove the staple cartridge before the blue dot appears in the window, you could damage the finisher.

- 5 Remove the staple cartridge.

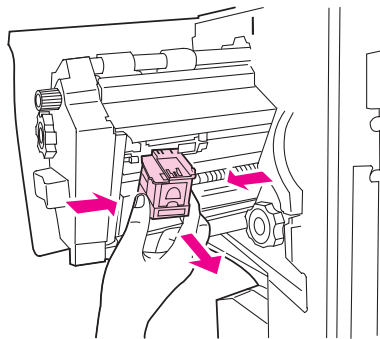

- 6 Pull up on the lever labeled with a green dot.

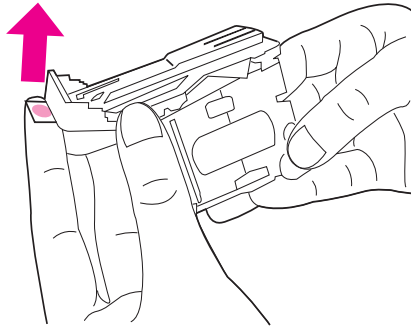

- 7 Remove the damaged staple.

- 8 Press down on the lever that is labeled with a green dot.

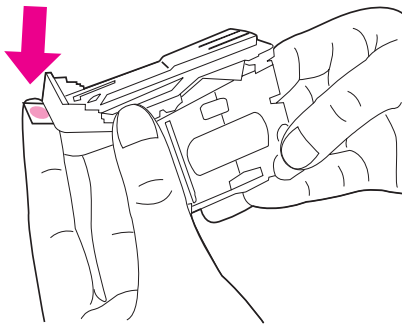

- 9 Reinstall the staple cartridge.

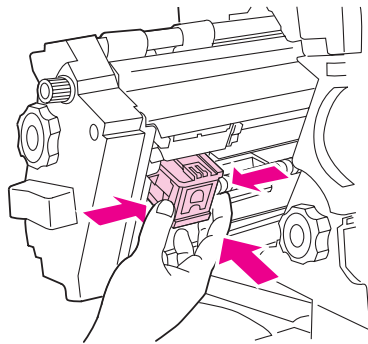

- 10 Slide the stapler unit into the finisher.

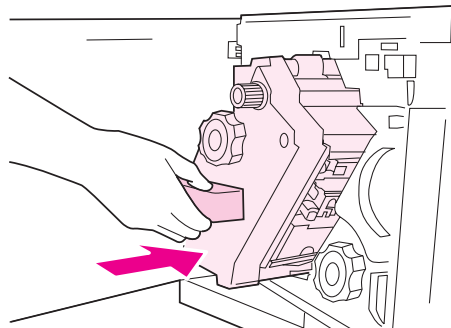

11 Close the stapler-unit door.

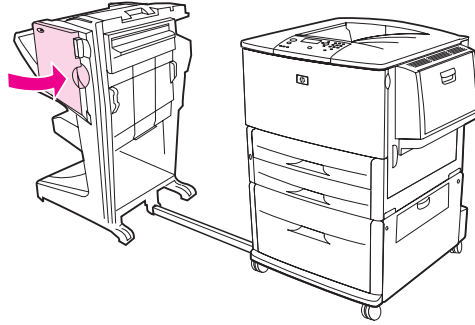

In rare instances, a staple jam might occur in the upper half of the stapler head.

- 1** Follow steps 1 through 4 for clearing a staple jam from the multifunction finisher (see [To clear a staple jam from the multifunction finisher](#)).
- 2** Locate the damaged staple at the back of the stapler unit, and then remove the staple.

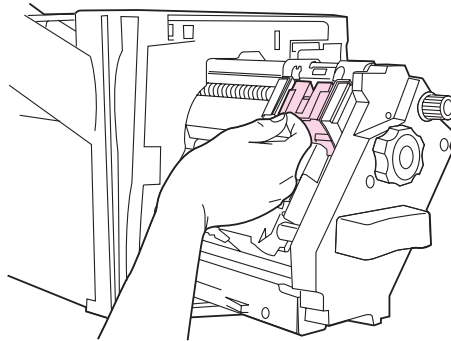

- 3** Follow steps 10 through 11 for clearing a staple jam from the multifunction finisher (see [To clear a staple jam from the multifunction finisher](#)).

To clear jams in the 8-bin mailbox

Note

Check that the paper in use is not thicker or heavier than what the 8-bin mailbox supports. See [Paper specifications](#).

- 1 Move the 8-bin mailbox away from the printer. To do this, stand on the left side of the printer and pull the 8-bin mailbox straight toward you.

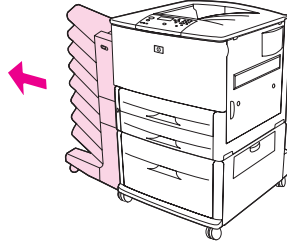

- 2 Carefully remove the upper (face-up) bin.
- 3 Pull down the handle on the output paper module and remove any jammed media from this area.

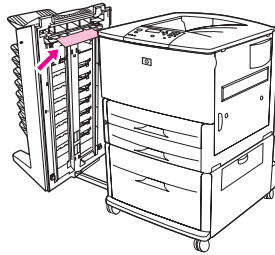

- 4 Push the 8-bin mailbox back into place, and then reattach the upper bin.

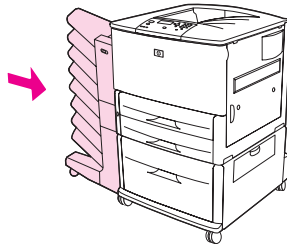

Solving repeated paper jams

Situation	Solution
General repeated paper jam problems	<ol style="list-style-type: none"><li data-bbox="603 268 1465 327">1. Check to make sure that paper is correctly loaded in the trays and that all width guides are correctly set (see Printing tasks).<li data-bbox="603 373 1465 432">2. Make sure that the paper tray is set for the size of paper installed and that the tray is not overloaded with paper.<li data-bbox="603 478 1465 537">3. Try turning over the stack of paper in the tray. If you are using prepunched or letterhead paper, try printing from optional Tray 1.<li data-bbox="603 583 1465 676">4. Do not use previously printed paper or torn, worn, or irregular paper. For recommended paper and other print media for your printer, see Paper specifications or go to www.hp.com/support/lj9050_lj9040.<li data-bbox="603 722 1465 814">5. Check the paper specifications. (See Paper specifications or go to www.hp.com/support/lj9050_lj9040.) If paper is outside of the recommended specifications, problems can occur.<li data-bbox="603 861 1465 919">6. The printer might be dirty. Clean the printer as described in Cleaning the printer, or go to www.hp.com/support/lj9050_lj9040.<li data-bbox="603 966 1465 989">7. Check that all damaged or jammed paper is removed from printer.

Note

If the jams continue, contact your HP-authorized service provider. (See the HP support flyer or go to www.hp.com/support/lj9050_lj9040.)

Understanding printer messages

Printer messages appear on the printer control-panel display to relay the normal status of the printer (such as `Processing Job`), or an error condition (such as `Close Right Door`) that needs attention. [Resolving control-panel messages](#) lists messages that require attention, or that might raise questions. Messages are listed in alphabetical order, with numeric messages at the end of the list. Not all messages are listed, because some (such as `Ready`) are self-explanatory.

Note

Some printer messages are affected by the `AUTO CONTINUE` and `CLEARABLE WARNINGS` settings in the `CONFIGURE DEVICE` menu, in the `System Setup` submenu, on the printer control panel (see [System setup submenu](#)).

Using the printer online Help system

This printer features an online Help system on the control panel that provides instructions for resolving most printer errors. Certain control-panel messages alternate with instructions about using the online Help system.

Whenever a `?` appears in an error message or a message alternates with `FOR HELP TOUCH ?`, press the `?` button to view the Help and use `▲` and `▼` to scroll through the message.

To exit the online Help system, press `?`.

If a message persists

- Some messages (for example, requests to load a tray, or a message that a previous print job is still in the printer memory) allow you to press `✓` to print, or to press `STOP`, and then select `Cancel Job` to clear the job and eliminate the message.
- If a message persists after performing all of the recommended actions, contact an HP-authorized service or support provider. (See the HP support flyer, or go to www.hp.com/support/lj9050_lj9040.)

Resolving control-panel messages

Message	Explanation or recommended action
Access Denied MENUS LOCKED	The printer control-panel function you are trying to access has been locked to prevent unauthorized access. See your network administrator.
ACTION NOT CURRENTLY AVAILABLE FOR TRAY X Tray size cannot be ANY SIZE/ANY CUSTOM	A duplexed document was requested from a tray that is set to Any Size or Any Custom. Duplexing is not allowed from a tray configured to Any Size or Any Custom. Select another tray or reconfigure the tray.
BAD DUPLEXER CONNECTION For help press ?	The duplex printing accessory is not connected properly to the printer. Turn the printer off and reinstall the duplex printing accessory.
Bad Optional tray connection	The optional tray is not connected properly to the printer. Turn the printer off and reinstall the optional tray.
BAD TRAY 1 CONNECTION For help press ?	Optional Tray 1 is not connected properly to the printer. Turn the printer off and reinstall optional Tray 1.
<BINNAME> FULL Remove all paper from bin	The specified output bin is full. Empty the bin to continue printing.
CANCELING...	The printer is cancelling a job. The message continues while the job is stopped, the paper path is flushed, and any remaining incoming data on the active data channel is received and discarded.
CARD SLOT X NOT FUNCTIONAL For help press ?	The compact flash card in the specified slot is not working correctly.
CARTRIDGE FAILURE For help press ? alternates with Return for Replacement	Cartridge is loaded and the shipping protection strip cannot be fully removed. Return the cartridge for a new one. (See the HP support flyer or go to www.hp.com/support/lj9050_lj9040 .)
Checking paper path	The engine is rotating its rollers to check for possible paper jams. Some pages might be ejected.
CHOSEN PERSONALITY NOT AVAILABLE To continue press ✓ alternates with For help press ?	A print job requested a printer language (personality) that does is not available with this printer. The job will not print and will be cleared from memory. Print the job using a driver for a different printer language, or add the requested language to the printer (if available).

Message	Explanation or recommended action
Cleaning...	The printer is processing the cleaning page.
CLEANING DISK <x>% COMPLETE... Do not power off alternates with For help press ?	The hard disk or compact flash disk is being cleaned. Contact your network administrator.
CLOSE RIGHT DOOR To continue turn off then on alternates with CLOSE RIGHT DOOR For help press ?	The right door is open and must be closed for printing to continue.
Creating... CLEANING PAGE	The printer is generating the cleaning page.
DATA RECEIVED To print last page Press ✓	The printer has received data but is waiting for a form feed or is in the Pause state.
Deleting...	The printer is deleting a stored job.
DIFFERENT PAPER SIZES IN JOB	Different paper sizes are used for a single job in the multifunction finisher. Verify that all pages in the job are configured for the same size paper.
DUPLEXER ERROR REMOVE DUPLEXER Install duplexer with power off	The duplexer has been removed. Reinsert the duplexer.
EIO X DISK NOT FUNCTIONAL For help press ?	The EIO hard disk is not working correctly. Remove the EIO hard disk from the slot (a slot number will replace the X) indicated. Reseat the EIO hard disk. If the message continues, replace the disk with a new EIO hard disk.
Event log empty	The user is attempting to view an empty event log by selecting SHOW EVENT LOG from the control panel.
FINISHING PROCESS NOT FUNCTIONAL For help press ✓	The external device might not be able to perform the finishing process, but it could still pass paper. The pages will be completed unfinished.
INCORRECT	The wrong PIN was typed. Return to the previous screen and retype the PIN.

Message	Explanation or recommended action
INSERT OR CLOSE TRAY xx For help press ?	The specified tray must be inserted or closed for printing to continue.
INSTALL CARTRIDGE For help press ?	The print cartridge has been removed or has been installed incorrectly. It must be replaced or reinstalled correctly for printing to continue.
Insufficient memory to load Fonts/Data For help press ? alternates with [DEVICE] To continue press ✓	The printer does not have enough memory to load the data (for example, fonts or macros) from the location specified. Touch OK to continue without this information. If the message persists, add more memory.
LOAD TRAY XX [TYPE] [SIZE] To use another tray press ✓ . alternates with LOAD TRAY XX [TYPE] [SIZE] For help press ?	A job is sent that requires a specific type and size that is not available. Load the requested paper into optional Tray 1. Press ✓ to use a type and size that is available in another tray.
LOAD TRAY XX [TYPE] [SIZE] For help press ?	The tray is empty or is configured for a different size of paper than the size that was requested.
MANUALLY FEED [TYPE] [SIZE] For help press ? alternates with To use another tray press ✓ .	Load the requested paper into optional Tray 1. To override the message, press ✓ if the desired paper is available in another tray. Press ✓ to use a type and size that is available in another tray.
No job to cancel	The STOP button was pressed, but there is no active job or buffered data to cancel. The message appears for approximately two seconds before the printer returns to the READY state.
NON-HP SUPPLY INSTALLED alternates with Economode disabled	The printer has detected that the supply is not a genuine HP cartridge, and the message appears for approximately 30 seconds before the printer is returned to the READY state. If you think you purchased an HP print cartridge, go to www.hp.com/go/anticounterfeit . Any printer repair that is required as a result of using a non-HP print cartridge is not covered under the printer warranty.
ORDER CARTRIDGE LESS THAN XXXX PAGES For help press ?	The print cartridge is low and the CARTRIDGE LOW setting in the SYSTEM SETUP submenu is set to CONTINUE . Approximately 2 weeks of typical printing capacity remains in the cartridge. This offers sufficient time to order a new cartridge.

Message	Explanation or recommended action
Paused To return to ready press STOP	The product is paused but no errors. exist The product will continue to receive data until the memory is full.
PERFORM PRINTER MAINTENANCE For help press ?	The printer has passed its prescribed printed page threshold between maintenance procedures. To ensure optimum print quality, the printer prompts you to perform routine maintenance every 350,000 pages. To order a printer maintenance kit, see the HP support flyer or go to www.hp.com/support/lj9050_lj9040 .
Performing upgrade	The printer is performing a firmware upgrade.
Receiving upgrade	The printer is receiving a firmware upgrade.
Reinsert Duplexer	The duplexer has been removed. Reinsert it.
Request accepted please wait	A user requested an internal page. When the current job has finished, the internal page will be printed.
REPLACE CARTRIDGE For help press ?	The print cartridge has reached the "out" level. The CARTRIDGE=LOW menu has been set to CONTINUE. Printing will continue until no more toner is available.
REPLACE STAPLER CARTRIDGE To continue press ✓	The external stapling device is out of staples. Replace the staple cartridge.
REPLACE STAPLES To continue press ✓	The external stapling device is out of staples. Replace the staple cartridge.
SANITIZING DISK <x>% COMPLETE Do not power off	The hard disk or compact flash disk is being cleaned. Contact your network administrator.
SIZE MISMATCH IN TRAY xx For help press ?	Tray xx is loaded with paper that is longer or shorter in the feed direction than the size configured for the tray.
STAPLER ALIGN ERROR	The paper in the external paper handling device is not aligned.
STAPLER LOW ON STAPLES For help press ?	The stapler device is running out of staples and needs to be refilled.
STAPLER OUT OF STAPLES For help press ?	The stapler device is out of staples and needs to be refilled.
STAPLING INTERRUPTION	Remove the jammed staple.

Message	Explanation or recommended action
<p>TOO MANY PAGES IN JOB TO STAPLE</p> <p>For help press ?</p>	<p>The job is too large to staple. The job will be printed unstapled. Reduce the number of pages in the job to staple.</p>
<p>TOO MANY PAGES IN JOB TO FINISH</p> <p>For help press ?</p>	<p>The job height is greater than the finisher capacity.</p>
<p>TOO MANY PAGES TO MAKE BOOKLET</p>	<p>The page content is too large to be saddle stitched.</p>
<p>UNABLE TO STORE JOB <JOB NAME></p>	<p>A job cannot be stored on the printer because of a memory, disk, or configuration problem.</p> <p>If job name is unknown, insert UNTITLED.</p>
<p>Waiting for TRAY XX to lift</p>	<p>The tray is in the process of lifting the paper to the top of the tray for feeding.</p>
<p>10.xx.yy SUPPLY MEMORY ERROR</p> <p>For help press ?</p>	<p>The product cannot read or write to at least one supply e-label, or a supply e-label is missing. Reinstall the supply or install a new supply.</p>
<p>11.XX INTERNAL CLOCK ERROR</p> <p>To continue press ✓</p>	<p>The internal clock on this product is not working. The printer still prints, but a prompt appears to set the date and time whenever the printer is turned off and then turned on.</p> <p>Time stamping for documents and events might also be affected. To resolve this issue, contact an HP-authorized service or support provider. (See the HP support flyer, or go to www.hp.com/support/lj9050_lj9040.)</p>
<p>13.xy.zz JAM IN [LOCATION]</p>	<p>Remove jammed paper from the specified location (see Clearing jams).</p> <p>Open and close the front door to clear the message.</p> <p>If the message persists after all jams have been cleared, a sensor might be stuck or broken. Contact an HP-authorized service or support provider. (See the HP support flyer, or go to www.hp.com/support/lj9050_lj9040.)</p>
<p>20 INSUFFICIENT MEMORY</p> <p>For help press alternates with To continue press ✓</p>	<p>The printer received more data than can fit in its available memory. You might have tried to transfer too many macros, soft fonts, or complex graphics.</p> <p>Press ✓ to print the transferred data (some data might be lost), and then simplify the print job or install additional memory (see Printer memory and expansion).</p>
<p>21 PAGE TOO COMPLEX</p> <p>For help press ? alternates with To continue press ✓</p>	<p>The page formatting process was not fast enough for the printer.</p> <p>Press ✓ to print the transferred data. (Some data might be lost.)</p> <p>If this message appears often, simplify the print job or add printer memory.</p>

Message	Explanation or recommended action
<p>22 EIO x BUFFER OVERFLOW</p> <p>To continue press ✓</p>	<p>Too much data was sent to the EIO card in the specified slot (x). An improper communications protocol might be in use.</p> <p>Press ✓ to print the transferred data. (Some data might be lost.)</p> <p>Check the host configuration. If this message persists, contact an HP-authorized service or support provider. (See the HP support flyer or go to www.hp.com/support/lj9050_lj9040.)</p>
<p>22 EMBEDDED I/O BUFFER OVERFLOW</p> <p>To continue press ✓</p>	<p>Too much data was sent to the embedded HP Jetdirect print server.</p>
<p>22 PARALLEL I/O BUFFER OVERFLOW</p> <p>For help press ? alternates with</p> <p>To continue press ✓</p>	<p>Too much data was sent to the parallel port.</p> <p>Check for a loose cable connection, and be sure to use a high-quality cable. (See the HP support flyer or go to www.hp.com/support/lj9050_lj9040.) Some non-HP parallel cables might be missing pin connections or might otherwise not conform to the IEEE-1284 specification.</p> <p>This error can occur if the driver you are using is not IEEE-1284 compliant. For best results, use the HP driver that came with the printer (see Printer drivers).</p> <p>Press ✓ to clear the error message. (Data will be lost.)</p> <p>If this message persists, contact an HP-authorized service or support provider. (See the HP support flyer or go to www.hp.com/support/lj9050_lj9040.)</p>
<p>40 EIO x BAD TRANSMISSION</p> <p>To continue press ✓</p>	<p>The connection between the printer and the EIO card in the specified slot has been broken.</p> <p>Press ✓ to clear the error message and continue printing.</p>
<p>40 EMBEDDED I/O BAD TRANSMISSION</p> <p>To continue press ✓</p>	<p>The connection with the embedded HP Jetdirect print server has been broken.</p> <p>Turn the printer off, and then turn the printer on.</p>
<p>41.x ERROR</p> <p>For help press ? alternates with</p> <p>To continue press ✓</p>	<p>A temporary printing error occurred.</p> <p>Turn the printer off, and then turn the printer on.</p> <p>If this message persists, contact an HP-authorized service or support provider. (See the HP support flyer or go to www.hp.com/support/lj9050_lj9040.)</p>
<p>41.3 UNEXPECTED SIZE IN TRAY xx</p> <p>For help press ? alternates with</p> <p>To use another tray press ✓</p>	<p>A tray (xx) is loaded with paper that is longer or shorter in the feed direction than the size configured for the tray.</p> <p>Press ✓ to get to TRAY xx SIZE=. Reconfigure the size in a tray so the printer will use a tray that contains the size that is required for the print job.</p> <p>If the error does not clear, turn the printer off, and then turn the printer on.</p> <p>If this message persists, contact an HP-authorized service or support provider. (See the HP support flyer or go to www.hp.com/support/lj9050_lj9040.)</p>
<p>49.xxxxx ERROR</p> <p>To continue turn off then on</p>	<p>A critical firmware error has occurred.</p> <p>Turn the printer off, and then turn the printer on.</p> <p>If this message persists, contact an HP-authorized service or support provider. (See the HP support flyer or go to www.hp.com/support/lj9050_lj9040.)</p>

Message	Explanation or recommended action
<p>50.x FUSER ERROR For help press ?</p>	<p>A fuser error has occurred. Turn the printer off, and then turn the printer on. If this message persists, contact an HP-authorized service or support provider. (See the HP support flyer or go to www.hp.com/support/lj9050_lj9040.)</p>
<p>51.xy ERROR For help press ? alternates with To continue turn off then on</p>	<p>A temporary printing error occurred. Turn the printer off, and then turn the printer on. If this message persists, contact an HP-authorized service or support provider. (See the HP support flyer or go to www.hp.com/support/lj9050_lj9040.)</p>
<p>52.xy ERROR For help press ? alternates with To continue turn off then on</p>	<p>A temporary printing error occurred. Turn the printer off, and then turn the printer on. If this message persists, contact an HP-authorized service or support provider. (See the HP support flyer or go to www.hp.com/support/lj9050_lj9040.)</p>
<p>53.xy.zz CHECK RAM DIMM SLOT [X] To continue Press ✓</p>	<p>There is a problem with the printer memory. The DIMM that caused the error will not be used. The following are the values of x: x = Device location 0 = On-board memory 1 = Slot 1 2 = Slot 2 You might need to reseal or replace the specified DIMM. Turn the printer off, and then replace the DIMM that caused the error. If this message persists, contact an HP-authorized service or support provider. (See the HP support flyer or go to www.hp.com/support/lj9050_lj9040.)</p>
<p>55.xx.yy DC CONTROLLER ERROR For help press ? alternates with To continue turn off then on</p>	<p>A temporary printing error occurred. Press ✓. If the error does not clear, turn the printer off, and then turn the printer on. If this message persists, contact an HP-authorized service or support provider. (See the HP support flyer or go to www.hp.com/support/lj9050_lj9040.)</p>
<p>56.xx ERROR For help press ? alternates with To continue turn off then on</p>	<p>A temporary printing error occurred. Turn the printer off, and then turn the printer on. If this message persists, contact an HP-authorized service or support provider. (See the HP support flyer or go to www.hp.com/support/lj9050_lj9040.)</p>
<p>57.xx ERROR For help press ? alternates with To continue turn off then on</p>	<p>A temporary printing error occurred. Turn the printer off, and then turn the printer on. If this message persists, contact an HP-authorized service or support provider. (See the HP support flyer or go to www.hp.com/support/lj9050_lj9040.)</p>

Message	Explanation or recommended action
<p>58.xx ERROR</p> <p>For help press</p> <p>alternates with</p> <p>To continue turn off then on</p>	<p>A temporary printing error occurred.</p> <p>Turn the printer off, and then turn the printer on.</p> <p>If this message persists, contact an HP-authorized service or support provider. (See the HP support flyer or go to www.hp.com/support/lj9050_lj9040.)</p>
<p>59.xw ERROR</p> <p>For help press ?</p> <p>alternates with</p> <p>To continue turn off then on</p>	<p>A temporary printing error occurred.</p> <p>Turn the printer off, and then turn the printer on.</p> <p>If this message persists, contact an HP-authorized service or support provider. (See the HP support flyer or go to www.hp.com/support/lj9050_lj9040.)</p>
<p>60.x ERROR</p> <p>For help press ?</p>	<p>An obstruction prevents the tray specified by xx from lifting paper properly for feeding.</p> <p>If this message persists, contact an HP-authorized service or support provider. (See the HP support flyer or go to www.hp.com/support/lj9050_lj9040.)</p>
<p>62 NO SYSTEM</p> <p>To continue turn off then on.</p>	<p>A problem exists with the printer firmware.</p> <p>To continue, turn the printer off, and then turn the printer on.</p> <p>If this message persists, contact an HP-authorized service or support provider. (See the HP support flyer or go to www.hp.com/support/lj9050_lj9040.)</p>
<p>64 ERROR</p> <p>For help press ?</p> <p>alternates with</p> <p>To continue turn off then on</p>	<p>A scan buffer error occurred.</p> <p>Turn the printer off, and then turn the printer on.</p> <p>If this message persists, contact an HP-authorized service or support provider. (See the HP support flyer or go to www.hp.com/support/lj9050_lj9040.)</p>
<p>68.x STORAGE ERROR SETTINGS CHANGED</p> <p>For help press ?</p> <p>alternates with</p> <p>To continue press ✓</p>	<p>An error occurred in the printer nonvolatile memory (NVRAM), and one or more printer settings has been reset to its factory default.</p> <p>Printing can continue, but there might be some unexpected functions because an error occurred in permanent storage.</p> <p>Pressing ✓ should clear the message.</p> <p>If this message persists, contact an HP-authorized service or support provider. (See the HP support flyer or go to www.hp.com/support/lj9050_lj9040.)</p>
<p>68.x PERMANENT STORAGE FULL</p> <p>For help press ?</p> <p>alternates with</p> <p>To continue press ✓</p>	<p>The printer NVRAM is full. Some settings saved in the NVRAM might have been reset to the factory defaults.</p> <p>Printing can continue, but there might be some unexpected functions because an error occurred in permanent storage.</p> <p>Pressing ✓ should clear the message.</p> <p>If this message persists, contact an HP-authorized service or support provider. (See the HP support flyer or go to www.hp.com/support/lj9050_lj9040.)</p>
<p>68.x PERMANENT STORAGE WRITE FAIL</p> <p>To continue press ✓</p>	<p>The printer NVRAM is failing to write.</p> <p>Printing can continue, but there might be some unexpected functions because an error occurred in permanent storage.</p> <p>Pressing ✓ should clear the message.</p> <p>If this message persists, contact an HP-authorized service or support provider. (See the HP support flyer or go to www.hp.com/support/lj9050_lj9040.)</p>

Message	Explanation or recommended action
<p>69.x ERROR For help press ? alternates with To continue turn off then on</p>	<p>A temporary printing error occurred. Turn the printer off, reseal the duplex printing accessory, and then turn the printer on. If this message persists, remove the duplexer and resume single-sided printing. If this message continues to persist, contact an HP-authorized service or support provider. (See the HP support flyer or go to www.hp.com/support/lj9050_lj9040.)</p>
<p>79.xxxx ERROR To continue turn off then on</p>	<p>A critical hardware error occurred. Turn the printer off, and then turn the printer on. If the message persists, remove the duplexer and resume single-sided printing. Contact an HP-authorized service or support provider. (See the HP support flyer or go to www.hp.com/support/lj9050_lj9040.)</p>
<p>8x.yyyy EIO ERROR</p>	<p>The EIO accessory card in slot x has encountered a critical error as specified by yyyy.</p>
<p>8X.YYYY EMBEDDED JETDIRECT ERROR</p>	<p>The embedded HP Jetdirect print server has encountered a critical error as specified by YYYY.</p>

Correcting output quality problems

Use the examples in the image defect table to determine which print quality problem you are experiencing, and then see the corresponding reference pages to troubleshoot.

Note

The examples below depict letter-size paper that has passed through the printer long-edge first. (If the paper has passed through the printer short-edge first, lines and repeating defects will run vertically rather than horizontally.)

 <p>See Light print or fade</p>	 <p>See Specks</p>	 <p>See Dropouts</p>	 <p>See Lines</p>
 <p>See Gray background</p>	 <p>See Toner smear</p>	 <p>See Loose toner</p>	 <p>See Repeating defects</p>
 <p>See Misformed characters</p>	 <p>See Page skew</p>	 <p>See Curl or wave</p>	 <p>See Wrinkles or creases</p>

Light print or fade

- The print cartridge might be low. Replace the print cartridge.
- Maintenance might be due. Check this by printing a copy of the supplies status page (see [Supplies status page](#)). If maintenance is due, order and install the printer maintenance kit. (See the HP support flyer or go to www.hp.com/support/lj9050_lj9040.)
- The print cartridge might be almost empty. Replace the print cartridge.

Specks

Specks might appear on a page after a jam has been cleared.

- Print a few more pages to see if the problem corrects itself.
- If specks occur frequently, set your printer up to automatically run a cleaning page (see [Using the printer cleaning page](#)).
- Clean the inside of the printer (see [General cleaning](#), or go to www.hp.com/support/lj9050_lj9040) and run a manual cleaning page to clean the fuser (see [Using the printer cleaning page](#)).
- Try using a different type of paper.
- Check for print cartridge leaks. If the print cartridge is leaking, replace it.

Dropouts

- Make sure that the environmental specifications for the printer are being met (see [Environmental specifications](#)).
- If the paper is rough and the toner easily rubs off, either try changing the fuser mode to High 1 or High 2, or try using a smoother paper.
- Try using a different paper type.

Lines

- Print a few more pages to see if the problem corrects itself.
- Clean the inside of the printer (see [Cleaning the printer](#), or go to www.hp.com/support/lj9050_lj9040) and run a manual cleaning page to clean the fuser (see [Using the printer cleaning page](#)).
- Replace the print cartridge.
- Maintenance might be due. Check this by printing a copy of the supplies status page (see [Supplies status page](#)). If maintenance is due, order and install the printer maintenance kit. (See the HP support flyer or go to www.hp.com/support/lj9050_lj9040.)

Gray background

- Do not use paper that has already been run through the printer.
- Print a few more pages to see if the problem corrects itself.
- Turn over the stack of paper in the tray. Also, try rotating the paper 180°.
- At the printer control panel, use the **Print quality** menu to decrease the toner density setting (see [System setup submenu](#)).
- Make sure that the environmental specifications for the printer are being met (see [Environmental specifications](#)).
- Replace the print cartridge.

Toner smear

Also see [Loose toner](#).

- Print a few more pages to see if the problem corrects itself.
- Try using a different type of paper.
- Make sure that the environmental specifications for the printer are being met (see [Environmental specifications](#)).
- Clean the inside of the printer (see [Cleaning the printer](#), or go to www.hp.com/support/lj9050_lj9040) and run a manual cleaning page to clean the fuser (see [Using the printer cleaning page](#)).
- Maintenance might be due. Check this by printing a copy of the supplies status page (see [Supplies status page](#)). If maintenance is due, order and install the printer maintenance kit. (See the HP support flyer or go to www.hp.com/support/lj9050_lj9040.)
- Replace the print cartridge.

Loose toner

Loose toner, in this context, is defined as toner that can be rubbed off the page.

- If paper is heavy or rough, try using a high fuser mode so that toner fuses more completely onto the paper. At the printer control panel, use `Fuser Modes` in the `Print Quality` menu (see [Print quality submenu](#)).
- If you have observed a rougher texture on one side of your paper, try printing on the non-rough side.
- Make sure that the environmental specifications for the printer are being met (see [Environmental specifications](#)).
- Make sure that paper type and quality meet HP specifications (see [Paper specifications](#)).
- Maintenance might be due. Check this by printing a copy of the supplies status page (see [Supplies status page](#)). If maintenance is due, order and install the printer maintenance kit. (See the HP support flyer or go to www.hp.com/support/lj9050_lj9040.)

Repeating defects

- Print a few more pages to see if the problem corrects itself.
- If the distance between defects is 38 mm (1.5 in) or 94 mm (3.8 in), the print cartridge might need to be replaced.
- Clean the inside of the printer (see [Cleaning the printer](#), or go to www.hp.com/support/lj9050_lj9040) and run a manual cleaning page to clean the fuser (see [Using the printer cleaning page](#)).
- Maintenance might be due. Check this by printing a copy of the supplies status page (see [Supplies status page](#)). If maintenance is due, order and install the printer maintenance kit. (See the HP support flyer or go to www.hp.com/support/lj9050_lj9040.)

Misformed characters

- Print a few more pages to see if the problem corrects itself.
- Make sure that the environmental specifications for the printer are being met (see [Environmental specifications](#)).
- Maintenance might be due. Check this by printing a copy of the supplies status page (see [Supplies status page](#)). If maintenance is due, order and install the printer maintenance kit. (See the HP support flyer or go to www.hp.com/support/lj9050_lj9040.)

Page skew

- Print a few more pages to see if the problem corrects itself.
- Verify that there are no torn pieces of paper inside the printer.
- Make sure that paper is loaded correctly, all adjustments have been made, and the paper is under the corner tabs (see [Orienting media](#)).
- Turn over the stack of paper in the tray. Also, try rotating the paper 180°.
- Make sure that paper type and quality meet HP specifications (see [Paper specifications](#)).
- Make sure that the environmental specifications for the printer are being met (see [Environmental specifications](#)).

Curl or wave

- Turn over the stack of paper in the tray. Also, try rotating the paper 180°.
- Make sure that paper type and quality meet HP specifications (see [Paper specifications](#)).
- Make sure that the environmental specifications for the printer are being met (see [Environmental specifications](#)).
- Try printing to a different output bin.
- If media is lightweight and smooth, try using a low fuser mode to reduce the heat in the fusing process. At the printer control panel, use `Fuser Modes` in the `Print Quality` menu (see [Print quality submenu](#)).

Wrinkles or creases

- Print a few more pages to see if the problem corrects itself.
- Make sure that the environmental specifications for the printer are being met (see [Environmental specifications](#)).
- Turn over the stack of paper in the tray. Also, try rotating the paper 180°.
- Make sure that paper is loaded correctly, all adjustments have been made, and the paper is under the corner tabs (see [Orienting media](#)).
- Make sure that paper type and quality meet HP specifications (see [Paper specifications](#)).
- If envelopes are creasing, try storing envelopes so that they lie flat.

Preventing wrinkles on envelopes

If envelopes are wrinkled when printed, first ensure that you are using supported types of envelopes. Then, use the following procedure to move the fuser levers to the higher position while printing the envelopes.

To prevent wrinkles on envelopes

- 1 Open the left door (If an optional output device is installed, first slide it away from the printer).

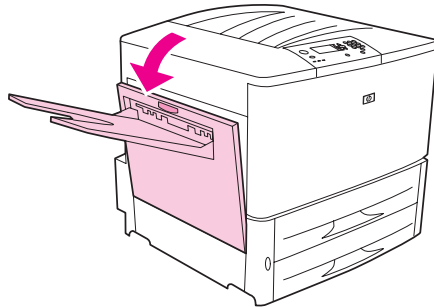

WARNING!

Avoid touching the adjacent fusing area. It can be HOT.

- 2 Locate and lift up the two blue levers.

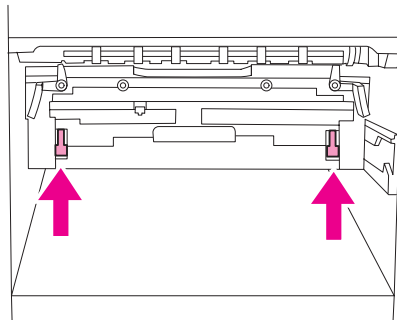

- 3 Close the left door.

When finished printing the envelopes, return the fuser levers to the down position for standard paper types.

CAUTION

Failure to return levers in the down position for standard paper types might result in poor print quality.







Solving common printer issues

Troubleshooting checklist

- Ensure that media that is loaded into the trays is from a freshly opened ream, contains no defects, and is installed correctly with the paper guides adjusted.
- Verify that the product is using a dedicated circuit and is plugged directly into the wall.

Note

For more information about an optional HP output device, see the user guide that came with the device.

Situation	Solution
Correct size of paper is not loaded.	Check paper trays to be sure the correct sizes are loaded as configured. Also, check that guides are set correctly.
Display is blank, and internal fans are not running.	Make sure that the printer power is on. Press all of the buttons on the printer control panel to see if one is stuck; contact your HP-authorized service representative if this does not resolve the problem.
Messages appear in the display.	See Understanding printer messages .
Paper is jammed in the printer.	Check for paper jams (see Clearing jams).
Printer display is in the wrong language or shows unfamiliar characters.	Reconfigure the control-panel display language. See the <i>Getting Started Guide</i> , or press  while simultaneously pushing the power switch ON. Hold  until SELECT LANGUAGE appears, and then release  . Use  and  to select the appropriate language. Press  to save your selection. The control-panel display will indicate that the printer is ready to use. If the new language does not appear in the display, you might not have pressed  to save your new selection.
Printer is not working at all.	Plug the AC power cord firmly into the grounded power receptacle and into the printer. (Be sure the power source is energized.)
Printer is turned on, but internal fans are not running.	Make sure the line voltage is correct for the printer power configuration. (See the plate next to the power receptacle on the back of your printer for voltage requirements.) If you are using a power strip and its voltage is not within specification, plug the printer directly into the power receptacle.
Printer voltage is not correct.	Make sure line voltage is in the correct range. (See the product label next to the power receptacle on the back of the printer for voltage requirements.)

Situation	Solution
A page fails to print.	Set <code>PRINT PS ERRORS=ON</code> , and then send the job again to print a PS error page. If this does not identify the problem, try turning off Resource Saving and I/O Buffering or try installing more memory (see PCL or PS font list).
A page prints with clipped margins.	If the page margins are clipped, you might have to print the page at 300-dpi resolution or install more memory. Also try turning off Resource Saving and I/O Buffering .
A PS error page prints.	<ul style="list-style-type: none"> ● Make sure the print job is a PS job. ● Check to see whether your program expected you to send a setup or PS header file to the printer. ● Check the printer setup in your software application to make sure that the printer is selected. ● Check cable connections to ensure that they are secure. ● Reduce the complexity of the graphic. ● Add available memory by turning on Resource Saving.
A text listing of PS commands prints instead of your PS print job.	The control-panel <code>PERSONALITY=AUTO</code> setting might have been confused by a nonstandard PS code. Check the <code>PERSONALITY</code> setting to see if it is set to <code>PS</code> or <code>PCL</code> . If it is set to <code>PCL</code> , set it to <code>PERSONALITY=AUTO</code> . If it is set to <code>AUTO</code> , set it to <code>PS</code> for this print job only. When the job has printed, return the setting to <code>AUTO</code> .
Attempted to use a disk-resident font, but the printer substituted a different font.	If you are using PCL, print the PCL Font Page, and verify that the font is on the disk. If you are using PS, print the PS Font Page and make sure that the font is on the disk. If the font is not on the disk, use the Device Storage Manager or the Macintosh-based HP LaserJet utility to download the font.
Auto setup did not automatically set up the printer.	<ul style="list-style-type: none"> ● Set up the printer manually by selecting Configure (Windows 9.X and NT) or Device Settings (Windows 2000 and XP). ● Select an alternate PPD (Macintosh). See Using the embedded Web server. ● The PPD might have been renamed. If so, select the renamed PPD (Macintosh). See Using the embedded Web server. ● A network queue might be present.
Blank pages print.	<ul style="list-style-type: none"> ● Turn the printer off and then on. ● Make sure the printer cartridge is installed properly.
Cannot access Tray 2 or 3, or optional Tray 4.	Make sure that the paper tray guides are adjusted correctly for the paper size you are using. (See Loading input trays , or go to www.hp.com/support/lj9050_lj9040 .)
Cannot clear <code>MANUALLY FEED [TYPE] [SIZE]</code> message.	<ul style="list-style-type: none"> ● A previous print job might still be in the printer buffer. ● Make sure that optional Tray 1 has the correct paper size loaded. (See Loading input trays, or go to www.hp.com/support/lj9050_lj9040.)

Situation	Solution
Computer software problem.	Check that your computer is working correctly by printing from a program you know works, or by printing a plain text file to see if the problem is with your program or with your printer driver. (For example, C:\dir>LPTn where n is the number of the computer port the printer is connected to, for example LPT1.) To print the page, you might have to send a form feed command from your computer.
Control-panel settings, such as RESOLUTION or ORIENTATION, do not work or are ignored.	Software commands override control-panel settings (see Using control-panel menus for information about how your program works with control-panel settings).
Data from a previous print job is still in the printer buffer.	<ul style="list-style-type: none"> ● Make sure that you are using the correct printer driver. ● A complex print job might still be processing. ● Make sure the printer is not paused. Make sure that PROCESSING appears on the control panel ● Pull out the print cartridge and check for paper. Reseat the print cartridge. ● Open Trays 2 and 3. Make sure that the appropriate paper is inserted. (See Loading input trays, or go to www.hp.com/support/lj9050_lj9040.) Close the trays.
Data is missing, but there are no printer messages.	<ul style="list-style-type: none"> ● Check your software program to be sure the print file contains no errors. ● Check your cable to make sure it is securely connected to both the printer and the computer. ● Your parallel printer cable might be defective. Use a high-quality cable. (See the HP support flyer, or go to www.hp.com/support/lj9050_lj9040 for an HP cable part number.) ● Check your network connection.
Data light is flashing, but nothing prints.	<ul style="list-style-type: none"> ● Make sure that you are using the correct printer driver. ● A complex print job might still be processing. ● Make sure the printer is not paused. Make sure that PROCESSING appears on the control-panel display. ● Pull out the print cartridge and check for paper. Reseat the print cartridge. ● Open Trays 2 and 3. Make sure that the appropriate paper is loaded. (See Loading input trays, or go to www.hp.com/support/lj9050_lj9040.) Close the trays.
Driver might not be set up to print on both sides of the paper.	Make sure that the option to print on both sides of the paper is properly configured in the driver.
Duplex printing accessory jams.	Make sure that you are using the supported paper weights and sizes. (See Paper specifications , or go to www.hp.com/support/lj9050_lj9040 .)

Situation	Solution
First page takes much longer to print than following pages.	<ul style="list-style-type: none"> ● Make sure that the printer control panel shows <code>READY</code>. ● Set the Sleep feature for a longer time period (see Configuration page). If a page takes longer to print due to complex formatting commands, changing the Sleep setting might not improve print speed. You might want to simplify the page.
Garbled pages print, there are overprints, or only a portion of a page prints.	<ul style="list-style-type: none"> ● Make sure that your program is configured for the correct printer. ● Replace the printer interface (I/O) cable with a cable that you know works to see if the cable is defective. ● Your parallel printer cable might be defective. Use a high-quality cable. (See the HP support flyer, or go to www.hp.com/support/lj9050_lj9040 for an HP cable part number.) ● Set the <code>PERSONALITY</code> item in the <code>System Setup</code> submenu of the <code>Configure Device</code> menu to <code>AUTO</code> (see <code>PERSONALITY=AUTO</code>). The printer might have been set to PCL, and a PS job was sent to the printer, or vice versa. ● Data sent to the printer might be corrupt. Try sending another file to see if it prints.
General repeated stapler jam problems.	<ul style="list-style-type: none"> ● Check to see that the job to be stapled is less than 5 mm (0.1 inch) thick. ● Stapler might have some trapped staple wires that are obstructing the magazine. Remove loose staples and paper dust from the inside of the stapler (see To clear a staple jam from the optional stacker/stapler).
Job has incorrect fonts.	<ul style="list-style-type: none"> ● If you are printing an .EPS file, try downloading the fonts contained in the .EPS file to the printer before printing. Use the HP LaserJet Utility (see Software for Macintosh computers). ● If the document is not printing with New York, Geneva, or Monaco fonts, go into the Page Setup dialog box, and select Options to deselect substituted fonts.
Job is not sent to the correct printer.	<p>Another printer with the same or similar name might have received the print job. Make sure that the printer name matches the name selected in the Chooser (see Using the embedded Web server).</p>
Job prints in Courier (the printer default font) instead of the font you requested.	<ul style="list-style-type: none"> ● The requested typeface is not available in the printer or is not present on the disk. Use a font download utility to download the desired font. ● Fonts downloaded to memory are lost when the printer is turned off. They are also lost if Resource Saving is not used, and a personality switch is performed to print a PCL job. Disk fonts are not affected by PCL jobs or by turning the printer off. ● Print a PS Font Page to verify that the font is available. If a disk font appears to be missing, it might be because a software utility was used to delete the font, because the disk was re-initialized, or because the disk drive is not installed correctly. Print a configuration page to verify that the disk drive is installed and is functioning correctly. ● Print a Disk Directory to help identify available fonts.

Situation	Solution
Job prints on the wrong side of the paper.	<ul style="list-style-type: none"> ● Make sure you have loaded the paper correctly. (See Loading input trays, or go to www.hp.com/support/lj9050_lj9040.) ● If you are printing one-sided copies, load paper into optional Tray 1 with the side to be printed facing up. Load paper in Trays 2, 3, and optional Tray 4 with the side to be printed facing down. ● If you are printing two-sided copies, load paper into optional Tray 1 with the first side to be printed facing down. Load paper in Trays 2, 3, and optional Tray 4 with the first side to be printed facing up.
Job was not duplexed.	<ul style="list-style-type: none"> ● Print a configuration page to ensure that the duplex printing accessory is installed properly (see Configuration page). ● Make sure the duplex printing accessory has been configured in the printer driver. ● Make sure that the software is not overriding the printer driver setting.
Job was not stapled.	<p>Jobs sent to the stapler might not be stapled for one or more of the following reasons:</p> <ul style="list-style-type: none"> ● One-page jobs will not be stapled. ● The stapler is out of staples and <code>AUTO CONTINUE</code> is set to <code>ON</code>. ● The wrong size or type of paper was used for the job. ● More than 50 pages were sent to the stapler, exceeding its capacity. ● The stapler has bent or broken staples in the stapler head. ● A staple jam was recently cleared (up to two sequential jobs might not be stapled). ● The job was sent to a bin other than the stapler bin because the wrong size or type of paper was used for the job. ● The interface cable to the stapler unit might be defective or not connected properly.
Job went to a different location than was expected.	<p>The wrong size or type of paper was used for the job. (See Configuring the trays by using the Paper Handling menu, or go to www.hp.com/support/lj9050_lj9040.)</p>
Last page did not print and the Data light is on.	<ul style="list-style-type: none"> ● Make sure that you are using the correct printer driver. ● Complex print job might still be processing. ● Printer might be waiting for the end of a file that did not come with the job. Press  to send it. ● Make sure the printer is not paused. Make sure that <code>PROCESSING</code> appears on the control-panel display. ● Pull out the print cartridge and check for paper. Reseat the print cartridge. ● Open Trays 2 and 3. Make sure that the appropriate paper is loaded. (See Loading input trays, or go to www.hp.com/support/lj9050_lj9040.) Close the trays.
Network or shared printer problems.	<p>Check for network or shared printer problems by connecting your computer directly to the printer and printing from a program that you know works. If you suspect network problems, check with your network administrator or consult the network documentation that came with your printer network cards.</p>

Situation	Solution
Optional Tray 4 will not work.	The power cord is not firmly plugged in to both the printer and the power receptacle. Remove and reconnect the power cord.
Paper is loaded into optional Tray 1, and a load or manual feed message appears on the control-panel display.	Load the correct paper in the tray. (See Loading input trays , or go to www.hp.com/support/lj9050_lj9040 .) If the correct paper is already loaded, press ✓.
Paper is not going to the correct output location.	<ul style="list-style-type: none"> ● Verify that the correct output bin is selected in the printer driver. For more information about changing printer driver settings, see the online help. ● The paper does not meet the specifications for the output bin. (See Selecting an output location, or go to www.hp.com/support/lj9050_lj9040.)
Paper jams and paper-feeding problems.	<ul style="list-style-type: none"> ● See To clear jams in Trays 2 and 3 or To clear jams in optional Tray 4. ● Ensure that paper specifications are within recommended range. (See Paper specifications, or go to www.hp.com/support/lj9050_lj9040.) ● Make sure the paper guides are adjusted properly and are not skewed. (See Loading input trays, or go to www.hp.com/support/lj9050_lj9040.) ● Perform preventive maintenance if requested by the printer.
Printer does not recognize the duplex printing accessory.	<ul style="list-style-type: none"> ● Print a configuration page to ensure that the duplex printing accessory is installed properly (see Configuration page). ● Turn the printer off. Remove and reinstall the unit. Turn the printer on. ● Make sure that the duplex printing accessory has been configured in the printer driver.
Printer does not recognize the hard disk.	Turn the printer off and verify that the hard disk is inserted correctly and is securely fastened.
Printer does not recognize optional Tray 4.	<ul style="list-style-type: none"> ● Make sure you selected optional Tray 4 in the printer driver (see Printer software). ● Turn the printer off and then on. ● Make sure the power cord is plugged into optional Tray 4. ● If the printer still does not recognize optional Tray 4, contact your dealer or authorized HP service provider.
Printer does not recognize stapler.	Check the cable to the stapler. Make sure it is properly connected at both ends.

Situation	Solution
Printer draws paper from the wrong tray.	<ul style="list-style-type: none"> ● Be sure your program is selecting the correct paper size or type. ● Make sure that the driver for your program is correctly installed, configured, and capable of requesting the appropriate paper size and type. ● The size of paper requested is not loaded in the tray selected. The printer draws paper from the next default tray that contains the correct size. Load the correct paper in the tray and make sure the tray is adjusted correctly. Load the tray with enough paper to complete the print job. To always print from the requested tray, set <code>USE REQUESTED TRAY</code> to <code>EXCLUSIVELY</code>. ● If you selected Tray 2, 3, or optional Tray 4 and did not turn the printer off when installing it, the printer does not recognize it and draws paper from the next default tray source. Turn the printer off, and then back on, and the printer will recognize the tray.
Printer interface problems.	Print a configuration page from the printer control panel to verify that the interface configurations shown on the printout match those on the host computer (see Configuration page).
Printer is paused.	Press STOP . Press ▲ and ▼ to select <code>Resume</code> , and then press ✓ .
Printer is off or not connected to an active power source.	Make sure that all power cables are firmly plugged in to both the printer components and an active power source. Make sure the printer is on.
Printer is ready, but not receiving data (the Data light does not blink).	<ul style="list-style-type: none"> ● Check for loose I/O cable connections at the printer and computer or network port. ● Try your I/O cable on a system that you know works. ● Check that the correct interface cable was selected and is securely connected to both the printer and the computer. If the cable is not correctly configured, see the <i>HP LaserJet 9050/9040 Series Printer Getting Started Guide</i> for configuration information. ● If connected to a network, print a Jetdirect configuration page to check for interface or network problems (see Configuration page).
Printer is usually slow to respond.	<ul style="list-style-type: none"> ● Printer speed is highly dependent on how your software application is set up, which printer driver you are using, and how much traffic is on the network. See the getting started guide for configuration information. ● You might need to add more memory (see Installing memory and fonts).
Printer port problem.	Check that your computer port is configured and working properly. One way to check this is to connect another printer to that port on your computer and print from a program you know works.
Printer prints only part of a page or document.	The connection has been broken during transmission. If you move the portable device during transmission, the connection can be broken. IRDA-compliant devices are designed to recover from temporary connection interruptions. You have up to 40 seconds to re-establish the connection (depending on the portable device being used).

Situation	Solution
Printer prints wrong fonts or formats.	<ul style="list-style-type: none"> ● The font is not present in the printer and must be downloaded from your program, or the proper font DIMM must be installed. Check your program to make sure the correct printer driver has been installed and configured. To verify that the font you want is available, print a PS or PCL font list (see Information menu). ● Your software selected a substitute font for one that is not available in the printer. (See your software program manual for more information about font selection.)
Printing stops in the middle of the job.	<ul style="list-style-type: none"> ● Check the control-panel display for an error message. ● If you are on a network, make sure the computer is correctly configured and that there is not a network problem (see your network administrator). ● Check the line voltage to make sure that it is steady and within printer specifications. (See the HP support flyer or go to www.hp.com/support/lj9050_lj9040.) Turn the printer off and then back on. ● Check the time-out setting in your network program. You might need to increase it. ● If you are trying to copy a file to the printer from the DOS prompt, use the copy command <code>COPY [filename] LPTn /B printer port</code>, such as LPT1 (where n is the port number). <p>Note To output the page, you might have to send a form feed command from the computer.</p>
PS print job will not print.	Check the configuration in the PostScript tab of Windows. Check that Protocol is set to AppleTalk and that Binary Data is not selected.
Software is selecting the wrong port.	Check your operating system port settings to be sure the print job is being sent to the correct port (for example, LPT1).
The control panel and driver are not set to the same paper size.	Make sure that the custom paper size defined from the control panel and the custom paper size defined in the driver are the same.
The file you are trying to print might not have the option to print on both sides of the paper turned on.	Make sure that the option to print on both sides of the paper is configured in the driver.

Situation	Solution
The Macintosh computer is not communicating with the printer.	<ul style="list-style-type: none"> ● Make sure that READY appears on the printer control panel. ● Make sure that the correct printer driver is selected in the left half of the Chooser. Then make sure that the correct printer name is selected (highlighted) on the right half of the Chooser. An icon will appear next to the printer name after the driver has been set up and configured with the PPD. ● If the printer resides on a network with multiple zones, make sure the correct zone is selected in the AppleTalk Zones box in the Chooser. ● Make sure the correct printer has been selected in the Chooser by printing a configuration page (see Configuration page). Make sure the name of the printer that appears on the configuration page matches the printer in the Chooser. ● Make sure AppleTalk is active. (Select this in the Chooser or in the AppleTalk control panel, whichever is applicable for your OS version.) ● Make sure the computer and printer are on the same network. From Control Panels in the Apple menu, select the Network (or the AppleTalk) control panel and then select the correct network (for example, LocalTalk or EtherTalk).
The printer driver icon does not appear in the Chooser .	Make sure the Apple LaserWriter 8 Chooser extension resides in the Extensions folder. If it does not exist anywhere on your system, you can obtain the driver from your Macintosh OS system software CD, from Apple Computer, Inc. For more information, see the HP support flyer or go to www.hp.com/support/lj9050_lj9040 .
Type has been specified as labels, transparencies, or envelopes.	<ul style="list-style-type: none"> ● Make sure that the media type can be printed on both sides. (See the HP support flyer or go to www.hp.com/support/lj9050_lj9040.) ● Change the media type to the proper media type for printing on both sides.

Using the embedded Web server

Home pages

The home pages of the embedded Web server are the informational pages for the printer. These include:

- **Printer status page**
This page shows the printer control panel and any current message. The control-panel status lights and buttons also appear, so you can change the printer control-panel menu settings from this page. Consumable life levels and the input tray media configuration also appear.
- **Configuration page**
The printer configuration page appears on this site in the embedded Web server. For more information, see [Configuration page](#).
- **Event log page**
This page shows the printer event log. For more information, see [Event log page](#).
- **Supplies page**
This page shows the levels of the consumables for the printer.
- **Usage page**
This page shows how much of each media type has been used by the printer.
- **Device identification page**
This page lets you name the device for network management needs, and shows the IP address and server for the printer.

Device pages

Use the device pages of the embedded Web server to configure the printer from your computer. These pages can be password protected. Always consult with your network administrator before changing the printer configuration.

- **Configure printer page**
This page is where you configure all printer settings.
- **Alerts page**
This page is where you configure notification recipients for various printer events.
- **E-mail page**
The e-mail addresses of notification recipients of printer events are typed into this page.
- **Order supplies page**
The remaining life of various consumables appears on this page, and links to the HP Web site for ordering supplies also appear.
- **Contact information page**
The name and e-mail address of the primary point of contact for information about the printer is typed into this page. The primary point of contact is usually the network administrator.
- **Security page**
This page configures the password information for the embedded Web server. Password information should be configured only by the network administrator.
- **Other links page**
This page is used to add other Web sites to the embedded Web server. These sites appear on the navigational bar throughout the embedded Web server pages.
- **Refresh rate page**
This page configures how often the embedded Web server obtains information from the printer regarding printer status.
- **Language page**
The language that the embedded Web server appears in is configured from this page.
- **Device identification page**
This page lets you name the device for network management needs, and shows the IP address and server for the printer.

Networking pages

The network pages of the embedded Web server provide access to HP Jetdirect network configuration parameters and status. These include:







- **Network settings page**
This page provides access to network protocol configuration parameters and other settings.
- **Security settings page**
Use these pages to control access to the device and set client authentication settings for connection to 802.11x networks.
- **Diagnostic pages**
These pages provide access to network statistics and configuration page settings that are useful in troubleshooting.

Printing information pages







From the printer control panel, you can print these pages, which contain information about the printer configuration:

- Menu map
- Configuration page
- Supplies Status page
- Usage page
- File Directory page
- PCL Driver or PS Driver font list

To print an information page

- 1 Press .
- 2 Use  or  to scroll to `Information` and then press .
- 3 Use  or  to scroll to the information page you want and then press .

To print a configuration page

- 1 Press .
- 2 Use  or  to scroll to `Information` and then press .
- 3 Use  or  to scroll to `Print Configuration` and then press .

Checking the printer configuration

Information about printer configuration can be found in the *Getting Started Guide* that came with the printer.

From the printer control panel, you can print pages that give details about the printer and its current configuration. The following information pages are described here:

- Menu map
- Configuration page
- Supplies status page
- Usage page
- PCL or PS font list
- File directory page
- Jetdirect
- Event log
- Paper path test

Use this procedure to print these information pages. Then, see the specific sections below for more information about each page.

Menu map

To see the current settings for the menus and items available on the control panel, print a control-panel menu map. Many of these values can be overridden from the printer driver or program. You might want to store the menu map near the printer for reference.

The content of the menu map varies, depending on the options currently installed in the printer. For a complete list of control-panel items and possible values, see [Control-panel menus](#). To change a control-panel setting, see [Control-panel menus](#).

Configuration page

Use the configuration page to view current printer settings, to help troubleshoot printer problems, or to verify installation of optional accessories, such as memory (DIMMs), paper trays, and printer languages.

Note

If an HP Jetdirect print server is installed, an HP Jetdirect configuration page will print out as well.

The configuration page contains the following information:

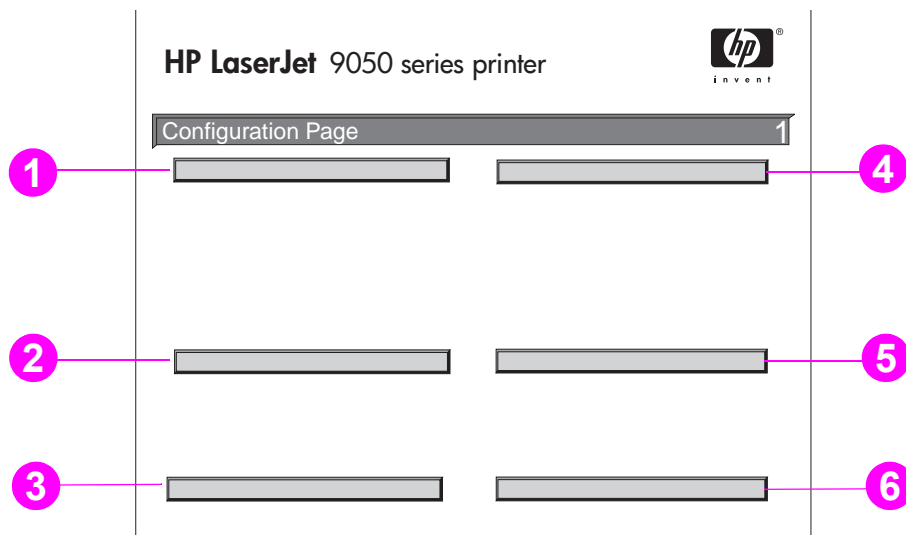

- 1 Printer Information** lists the serial number, page counts, and other information for the printer.
- 2 Event Log** lists the number of entries in the log, the maximum number of entries viewable, and the last three entries. The second page of the event log is the manufacturer's page. This page contains information that might assist HP Customer Care representatives in solving possible printer problems.
- 3 Installed Personalities and Options** lists all printer languages that are installed (such as PCL and PS), and lists options that are installed in each DIMM and compact flash slot and EIO slot.
- 4 Memory** lists the printer memory information, PCL Driver Work Space (DWS), and I/O buffering and Resource Saving information.
- 5 Security** lists the status of the printer control-panel lock, control-panel password, and disk drive.
- 6 Paper Trays and Options** lists the size settings for all trays and lists optional paper-handling accessories and output devices that are installed.

Supplies status page

Use the supplies status page to obtain information about the print cartridge that is installed in the printer, the amount of toner left in the cartridge, and the number of pages and jobs that have been processed. The page also lets you know when you should schedule the next preventative maintenance.

The supplies status page contains the following information:

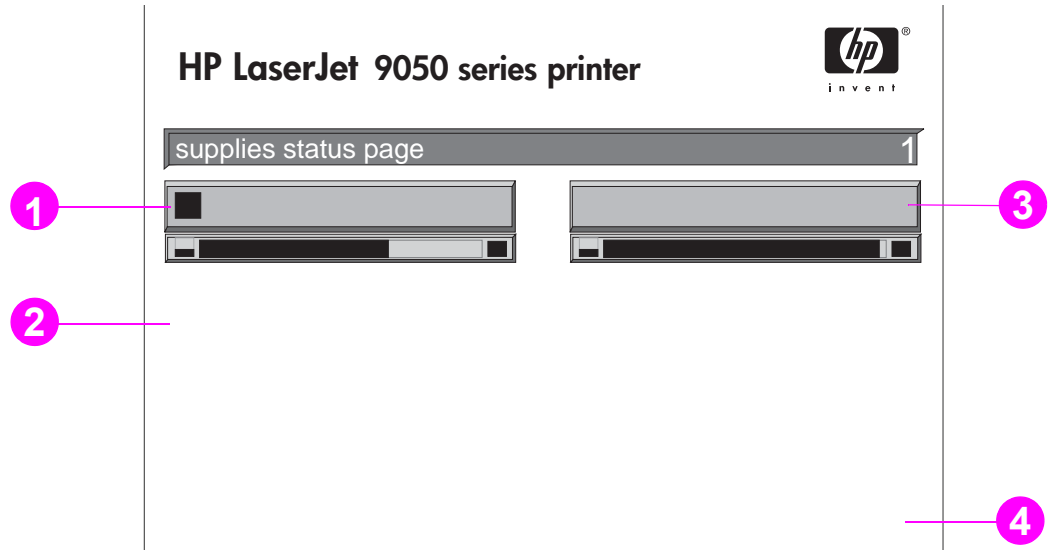

- 1 Cartridge Information** indicates the amount of toner available in the print cartridge, estimated pages remaining for the amount of toner left in the cartridge, total number of pages and jobs processed, print cartridge manufacture date and serial number, and how to recycle HP print cartridges.
- 2 Printer Information** lists total printer page count, preventative maintenance interval, pages until next maintenance should be performed, and serial number of the printer.
- 3 Other Supplies Information** indicates the percentage of the maintenance kit that has been used and the HP part numbers.
- 4 Ordering Information** provides information about how to order supplies.

Usage page

Use the usage page to obtain information about the page sizes and number of pages printed.

The usage page contains the following information:

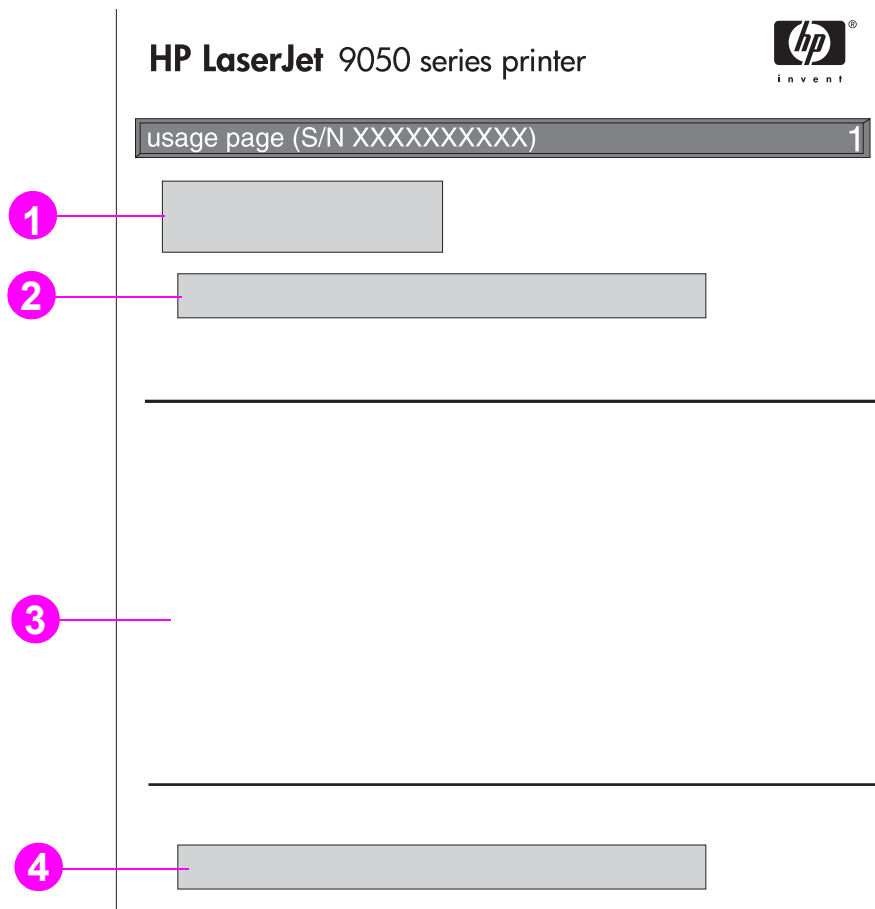

- 1 **Product Name** and **Printer Name** indicate the series of HP LaserJet printer in use.
- 2 **Usage Totals** indicates types of pages that have been printed, the number of single-sided pages printed, the number of duplexed pages printed, and the total number of pages printed.
- 3 **Print Mode & Paper Path Usage** indicates the number of times that each print mode has been used, the number of times that each input device has been used, and the number of times that each output bin has been used.
- 4 **Coverage** indicates the amount of toner used on a page.

PCL or PS font list

Use the font lists to see which fonts are currently installed in the printer. (The font lists also show which fonts are resident on a hard disk or flash DIMM.)

The PS font list shows the PS fonts installed, and gives a sample of those fonts. The following describes the information that can be found on the PCL font list:

- **Font** gives the font names and samples.
- **Pitch/Point** indicates the pitch and point size of the font.
- **Escape Sequence** (a PCL 5e programming command) is used to select the designated font. (See the legend at the bottom of the font list page.)
- **Font #** is the number used to select fonts from the printer control panel (not the software application). Do not confuse the font # with the font ID, described below. The number indicates the DIMM slot where the font is stored.
 - **SOFT**: Downloaded fonts that stay resident in the printer until other fonts are downloaded to replace them or until the printer is turned off.
 - **INTERNAL**: Fonts that permanently reside in the printer.
- **Font ID** is the number you assign to soft fonts when you download them through software.
- 1 **Disk Information** indicates the disk model number, serial number, capacity, available free space, and whether you can write to the disk.
- 2 **File Size** column indicates the size of each file under the Directory/File Name column. If a directory is listed on the line, then Directory appears in this column, and its path is listed in the Directory/File Name column.
- 3 **Directory/File Name** indicates the name of the file. Files in a subdirectory are listed right after the directory line. The files are not necessarily listed in alphabetic order.

Jetdirect page

The Jetdirect page contains the following information:

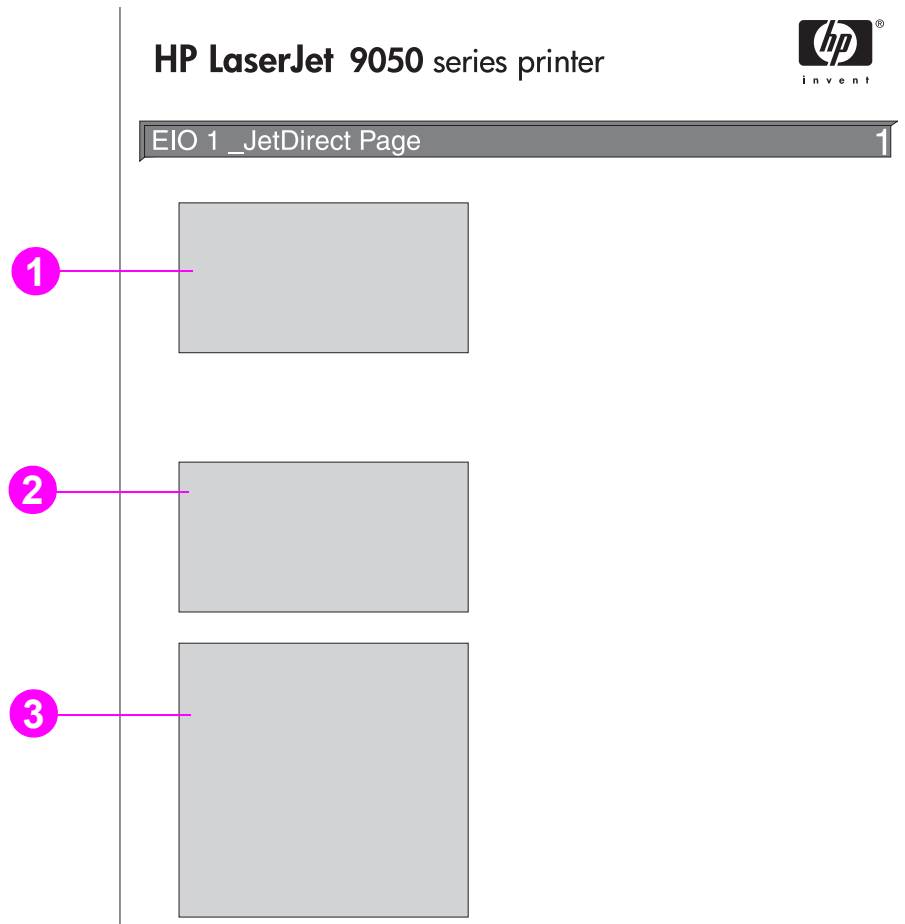

- 1 HP Jetdirect Configuration** indicates the printer status, model number, hardware address, firmware version, port select, port configuration, auto negotiation, manufacturing identification, and manufactured date.
- 2 Network Statistics** indicates the total packets received, unicast packets received, bad packets received, framing errors received, total packets transmitted, unsendable packets, transmit collisions, and transmit late collisions.
- 3 Protocol Information** indicates the status for TCP/IP, IPX/SPX, Novell/NetWare, AppleTalk, and DLC/LLC.

Event log page

The first page of the event log contains the following information:

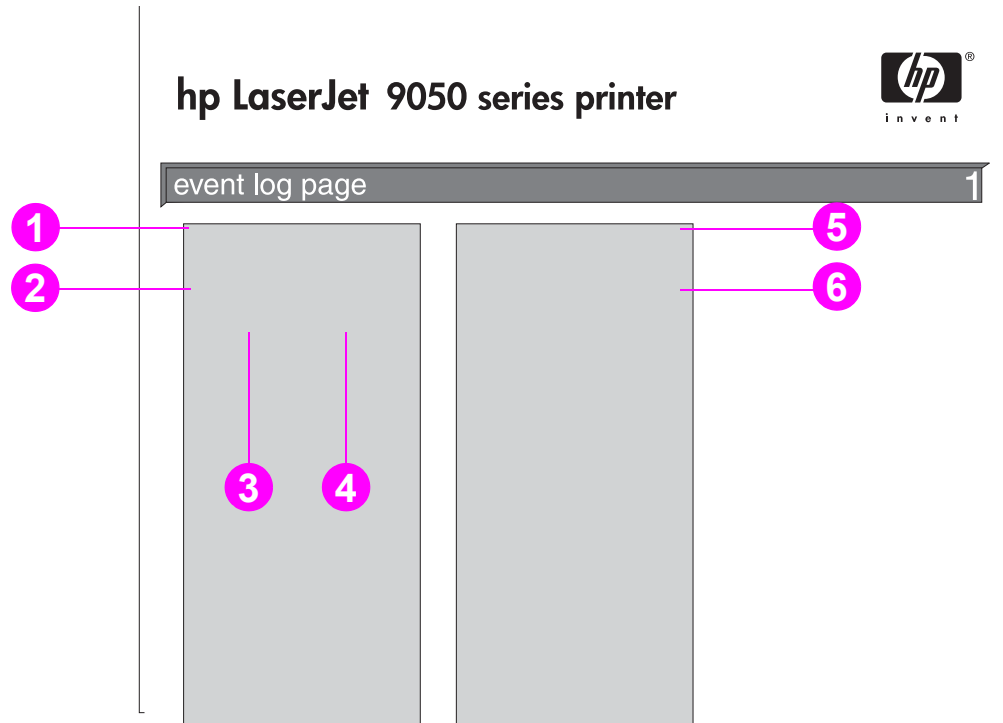

- 1 **Current Page Count** indicates the number of pages printed from the printer.
- 2 **Number** indicates the order in which the events occurred. The last event to occur has the highest number.
- 3 **Page Count** indicates the number of pages printed from the printer when the event occurred.
- 4 **Event** indicates the internal event code for each event.
- 5 **Serial Number** indicates the serial number of the printer.
- 6 **Description or Personality** indicates whether the event occurred due to a problem within a printer personality or due to a printer jam.

The second page of the event log is the manufacturing page. This page contains information that might assist HP Customer Care representatives in solving possible printer problems.











To print an event log

- 1 Press **✓**.
- 2 Use **▲** or **▼** to scroll to **Diagnostics** and press **✓**.
- 3 Use **▲** or **▼** to scroll to **Print Event Log** and press **✓**.

Printing a paper path test

The paper path test can be used to verify that various paper paths are working properly or to troubleshoot problems with tray configuration.

To print a paper path test

- 1 Press .
- 2 Use  or  to scroll to `Diagnostics` and then press .
- 3 Use  or  to scroll to `Paper Path Test` and then press .
- 4 Use  or  to select the input tray you want to test, the output bin, the duplex printing accessory (if available), and number of copies, pressing  after you set the value for each. After selecting the last option, the paper path test automatically starts.

See the user guide for each accessory device that is attached to the printer.

A Specifications

Overview

This section presents some of the printer specifications.

- Paper specifications
- Environmental specifications

Paper weight equivalence table

Use this table to determine approximate equivalent basis weight in weight specifications other than U.S. bond weight. For example, to determine the equivalent of 20 lb U.S. bond weight paper in U.S. cover weight, locate the bond weight (in row two, first column) and scan across the row to the cover weight (in the third column). The equivalent is 75 g/m² (28 lb).

Note

Shaded areas indicate a standard weight for that grade.

U.S. Bond Weight (lb)	U.S. Text/ Book Weight (lb)	U.S. Cover Weight (lb)	U.S. Bristol Weight (lb)	U.S. Index Weight (lb)	U.S. Tag Weight (lb)	Metric Weight (g/m ²)
17	43	24	29	35	39	64
20	50	28	34	42	46	75
21	54	30	36	44	49	80
22	56	31	38	46	51	81
24	60	33	41	50	55	90
27	68	37	45	55	61	100
28	70	39	49	58	65	105
32	80	44	55	67	74	120
34	86	47	58	71	79	128
36	91	50	62	75	83	135

U.S. Bond Weight (lb)	U.S. Text/ Book Weight (lb)	U.S. Cover Weight (lb)	U.S. Bristol Weight (lb)	U.S. Index Weight (lb)	U.S. Tag Weight (lb)	Metric Weight (g/m ²)
39	100	55	67	82	91	148
42	107	58	72	87	97	157
43	110	60	74	90	100	163
47	119	65	80	97	108	176
53	134	74	90	110	122	199
58	146	80	98	120	133	216

Printing supplies

Item	Part number	Description or use
Print cartridge average of 30,000 pages at 5% coverage	C8543X	Replacement HP maximum capacity, smart print cartridge.
HP LaserJet Monochrome Transparencies Letter (8.5 x 11 in), 50 sheets/box A4 (210 x 297 mm), 50 sheets/box	92296T 92296U	Specifically engineered for use with HP LaserJet monochrome printers. Specifications: 4.3 mil thickness. Two-sided coating.
HP LaserJet Soft Gloss Paper Letter (8.5 x 11 in), 50 sheets/box A4 (210 x 297 mm), 50 sheets/box	C4179A C4179B	For use with HP Color LaserJet and HP LaserJet monochrome printers. Coated paper, good for business documents with high impact, such as brochures, sales material, and documents with graphics and photographic images. Specifications: 32 lb. Two-sided satin gloss coating.
HP Premium Choice LaserJet Paper Letter (8.5 x 11 in), 500 sheets/ream, 10-ream carton A4 (210 x 297 mm), 500 sheets/ream, 4-ream carton Tabloid (11 x 17 in), 250 sheets/ream, 6-ream carton A3 (420 x 297 mm), 500 sheets/ream, 4-ream carton	HPU1132 CHP410 HPU1732 CHP420	For use with HP Color LaserJet and HP LaserJet monochrome printers. A heavy, super-bright paper for high-impact documents such as resumes, brochures, reports, and presentations. Specifications: 98 bright, 32 lb.

Item	Part number	Description or use
HP LaserJet Paper		Enhances performance for all HP LaserJet printers. Heavier for letterhead, high-value memos, legal documents, direct mail, and correspondence.
Letter (8.5 x 11 in), 500 sheets/ream, 10-ream carton	HPJ1124	
Letter (8.5 x 11 in), 3-hole, 500 sheets/ream, 10-ream carton	HPJ113H	Specifications: 96 bright, 24 lb.
Legal (8.5 x 14 in), 500 sheets/ream, 10-ream carton	HPJ1424	
A4 (210 x 297 mm), 500 sheets/ream, 5-ream carton	CHP310	
Tabloid (11 x 17 in), 500 sheets/ream, 5-ream carton	HPJ1724	
HP Printing Paper		For use with laser and inkjet printers. Created especially for small offices and home offices. Heavier and brighter than copier paper.
Letter (8.5 x 11 in), 500 sheets/ream, 10-ream carton	HPP1122	
A4 (210 x 297 mm), 500 sheets/ream, 5-ream carton	CHP210	Specifications: 92 bright, 22 lb.
A3 (420 x 297 mm), 500 sheets/ream, 5-ream carton	CHP220	
HP MultiPurpose Paper		For use with all office equipment (laser and inkjet printers, copiers, and fax machines). Created for businesses that want one paper for all their office needs. Brighter and smoother than other office papers.
Letter (8.5 x 11 in), 500 sheets/ream, 10-ream carton	HPM1120	
Letter (8.5 x 11 in), 500 sheets/ream, 5-ream carton	HPM115R	Specifications: 90 bright, 20 lb.
Letter (8.5 x 11 in), 3-hole, 500 sheets/ream, 10-ream carton	HPM113H	
Legal (8.5 x 14 in), 500 sheets/ream, 10-ream carton	HPM1420	
Tabloid (11 x 17 in), 500 sheets/ream, 5-ream carton	HPM1720	
HP Office Paper		For use with all office equipment (laser and inkjet printers, copiers, and fax machines). Good for standard, high-volume printing. Brighter than standard papers.
Letter (8.5 x 11 in), 500 sheets/ream, 10-ream carton	HPC8511	
Letter (8.5 x 11 in), 3-hole, 500 sheets/ream, 10-ream carton	HPC3HP	Specifications: 87 bright, 20 lb.
Legal (8.5 x 14 in), 500 sheets/ream, 10-ream carton	HPC8514	
A4 (210 x 297 mm), 500 sheets/ream, 5-ream carton	CHP110	
Tabloid (11 x 17 in), 500 sheets/ream, 5-ream carton	HPC1117	
HP Office Recycled Paper		For use with all office equipment (laser and inkjet printers, copiers, and fax machines). Good for high-volume printing.
Letter (8.5 x 11 in), 500 sheets/ream, 10-ream carton	HPE1120	
Letter (8.5 x 11 in), 3-hole, 500 sheets/ream, 10-ream carton	HPE113H	Satisfies U.S. Executive Order 13101 for environmentally preferable products.
Legal (8.5 x 14 in), 500 sheets/ream, 10-ream carton	HPE1420	Specifications: 84 bright, 20 lb, 30% post-consumer content.

Envelope margins

The following table gives typical address margins for a Commercial #10 or DL envelope.

Type of address	Top margin	Left margin
Return address	15 mm (0.6 inch)	15 mm (0.6 inch)
Delivery address	51 mm (2 inches)	85 mm (3.5 inches)

Note

For the best print quality, position margins no closer than 15 mm (0.6 inch) from the edges of the envelope.

Paper specifications

HP LaserJet printers produce excellent print quality. This printer accepts a variety of media, such as cut-sheet paper (including recycled paper), envelopes, labels, transparencies, and custom-size paper. Properties such as weight, grain, and moisture content are important factors affecting printer performance and output quality.

The printer can use a variety of paper and other print media in accordance with the guidelines in this manual. Paper that does not meet these guidelines can cause the following problems:

- Poor print quality
- Increased jams and multiple-sheet feeds
- Premature wear on the printer, requiring repair

For best results, use only HP brand paper and print media. Hewlett-Packard cannot recommend the use of other brands. Because they are not HP products, HP cannot influence or control their quality.

It is possible for paper to meet all of the guidelines in this manual and still not produce satisfactory results. This might be the result of improper handling, unacceptable temperature and humidity levels, or other variables over which HP has no control.

Before purchasing a large quantity of paper, make sure it meets the requirements specified in this user guide and in the *Guidelines for Paper and Other Print Media* guide. Always test paper before purchasing a large quantity. For more information, see www.hp.com/go/ljpaper.

CAUTION

Using paper outside HP specifications can cause problems for the printer, requiring repair. This repair is not covered by the HP warranty or service agreements.

Supported sizes of paper for input and output

Note

For more information on an optional HP output device, see the user guide that came with the product.

Tray or Bin	Capacity	Paper	Weight
Optional Tray 1	Up to 100 sheets Up to 10 envelopes Maximum stack height for transparencies: 10 mm (0.4 inch)	<ul style="list-style-type: none"> Standard detectable sizes: Letter, Legal, Executive, ISO A3, ISO A4, ISO A5, 11 x 17, JIS B5, JIS B4, JPostD, Custom sizes: Minimum: 98 x 191 mm (3.9 x 7.5 inches) Maximum: 312 x 470 mm (12.3 x 18.4 inches) Envelope sizes: Commercial #10, C5, DL, Monarch, B5 Transparencies: 0.12 to 0.13 mm thick (4.7 to 5.5 mils thick) <p>Note Print envelopes, transparencies, and labels from optional Tray 1 only.</p>	64 to 216 g/m ² (17 to 58 lb bond) Two-sided printing: 64 to 199 g/m ² (17 to 53 lb bond)
Trays 2 and 3	Up to 500 sheets	<ul style="list-style-type: none"> Standard detectable sizes: Letter, Letter-R, Legal, Executive, ISO A3, ISO A4-R, ISO A5, JIS B4, JIS B5, 11 x 17 Custom sizes: Minimum: 148 x 210 mm (5.8 x 8.3 inches) Maximum: 297 x 431 mm (11.7 x 17 inches) 	64 to 199 g/m ² (17 to 53 lb bond)
Optional Tray 4	Up to 2,000 sheets	<ul style="list-style-type: none"> Standard detectable sizes: Letter, Legal, Executive, ISO A3, ISO A4, 11 x 17, JIS B4, JIS B5 Standard undetectable sizes: 8K, 16K, JIS Executive, 8.5 x 13 (215 x 330 mm) Custom sizes: Minimum: 182 x 210 mm (7.2 x 8.3 inches) Maximum: 297 x 431 mm (11.7 x 17 inches) 	64 to 199 g/m ² (17 to 53 lb bond)
Standard top bin	Up to 500 sheets Up to 50 transparencies	<ul style="list-style-type: none"> Standard sizes: Letter, Legal, Executive, ISO A3, ISO A4, ISO A5, 11 x 17, JIS B5, JIS B4, JPostD, Monarch, 8K, 16K Custom sizes Custom types: Transparencies 	64 to 199 g/m ² (17 to 53 lb bond)

Tray or Bin	Capacity	Paper	Weight
Left output bin	Up to 100 sheets Up to 10 transparencies	<ul style="list-style-type: none"> Standard sizes: Letter, Legal, Executive, ISO A3, ISO A4, ISO A5, 11 x 17, JIS B5, JIS B4, JPostD, Monarch, 8K, 16K Custom sizes Custom types: Envelopes, labels 	64 to 216 g/m ² (17 to 58 lb bond)
Duplex printing accessory		<ul style="list-style-type: none"> Standard detectable sizes: Letter, Letter-R, Legal, Executive, ISO A3, ISO A4, ISO A4-R, 11 x 17, JIS B4, JIS B5 Standard undetectable sizes: 8K, 16K Custom sizes Custom types: Duplexing is <i>not</i> supported for envelopes, labels, or transparencies 	64 to 199 g/m ² (17 to 53 lb bond)
Optional 3,000-sheet stacker	Up to 3,000 sheets of Letter or A4 Up to 1,500 sheets of A3 or 11 x 17	<ul style="list-style-type: none"> Standard sizes for lower bin: Letter, Legal, Executive, ISO A3, ISO A4, ISO A5, 11 x 17, JIS B5, JIS B4, 8K, 16K Standard sizes for upper bin: Letter, Legal, Executive, ISO A3, ISO A4, ISO A5, 11 x 17, JIS B5, JIS B4, JPostD, Monarch, 8K, 16K Custom sizes Custom types: Envelopes, labels, transparencies, heavy paper 	<ul style="list-style-type: none"> 64 to 199 g/m² (17 to 53 lb bond) in lower bin 64 to 216 g/m² (17 to 58 lb bond) in upper bin
Optional 3,000-sheet stacker/stapler	Up to 3,000 sheets of Letter or A4 Up to 1,500 sheets of A3 or 11 x 17 Up to 50 sheets stapled	<ul style="list-style-type: none"> Standard sizes for lower bin: Letter, Legal, Executive, ISO A3, ISO A4, ISO A5, 11 x 17, JIS B5, JIS B4, 8K, 16K Standard sizes for upper bin: Letter, Legal, Executive, ISO A3, ISO A4, ISO A5, 11 x 17, JIS B5, JIS B4, JPostD, Monarch, 8K, 16K Custom sizes Custom types: Envelopes, labels, transparencies, heavy paper 	<ul style="list-style-type: none"> 64 to 199 g/m² (17 to 53 lb bond) in lower bin 64 to 216 g/m² (17 to 58 lb bond) in upper bin

Tray or Bin	Capacity	Paper	Weight
Optional multifunction finisher	Up to 1,000 sheets of stacked 20 lb bond for Letter and A4 (up to 50 sheets stapled), and 500 sheets stacked 20 lb bond for A3 and 11 x 17 (up to 25 sheets stapled) Up to 40 booklets of 5 sheets stacked or 20 booklets of 10 sheets stacked	<ul style="list-style-type: none"> Standard sizes: Letter, Legal, Executive, ISO A3, ISO A4, ISO A5, JIS B4, JIS B5, 11 x 17 Custom sizes: Minimum: 98 x 191 mm (3.9 x 7.5 inches) Maximum: 312 x 470 mm (12.3 x 18.5 inches) Custom types: Envelopes, labels, transparencies, heavy paper 	<ul style="list-style-type: none"> 64 to 199 g/m² (17 to 53 lb bond) in lower booklet bin 64 to 216 g/m² (17 to 58 lb bond) in upper bin
Optional 8-bin mailbox	Up to 250 sheets of A4 and Letter per output bin	<ul style="list-style-type: none"> Standard sizes for upper bin: Letter, Legal, Executive, ISO A3, ISO A4, ISO A5, JIS B4, JIS B5, 11 x 17 Custom sizes: Minimum: 148 x 210 mm (5.8 x 8.3 inches) Maximum: 297 x 432 mm (11.7 x 17 inches) Standard sizes for 8 mailbox bins: Letter, Legal, Executive, ISO A3, ISO A4, ISO A5, JIS B4, JIS B5, 11 x 17 Custom sizes: Minimum: 148 x 210 mm (5.8 x 8.3 inches) Maximum: 297 x 432 mm (11.7 x 17 inches) 	<ul style="list-style-type: none"> 60 to 135 g/m² (16 to 36 lb bond) in 8 mailbox bins 60 to 216 g/m² (16 to 58 lb bond) in upper bin

Supported types of paper

Use settings on the printer control panel to select the following types of paper and other print media.

- Plain
- Pre-printed
- Letterhead
- Transparency (see [Transparencies](#))
- Prepunched
- Labels (see [Labels](#))
- Bond
- Recycled
- Color
- Card stock (see [Card stock and heavy paper](#))
- Rough
- Envelope (for Tray 1 only)

Guidelines for using paper

For best results, use conventional 75 g/m² (20 lb) paper. Make sure the paper is of good quality, and free of cuts, nicks, tears, spots, loose particles, dust, wrinkles, voids, and curled or bent edges.

If you are unsure what type of paper you are loading (such as bond or recycled), check the label on the package of paper.

Some paper causes print quality problems, jamming, or damage to the printer. Do not use letterhead paper that is printed with low-temperature inks, such as those used in some types of thermography, and do not use raised letterhead. Coated papers and some transparencies can wrap around the fuser roller and possibly cause jams.

The printer uses heat and pressure to fuse toner to the paper. Make sure that any colored paper or preprinted forms use inks that are compatible with the printer fusing temperature (392°F or 200°C for 0.1 second).

Resolving issues with paper and other print media

Use this section to resolve common problems with paper and other print media.

Symptom	Problem	Solution
Poor print quality or toner adhesion, problems with feeding	Too moist, too rough, too smooth, or embossed; faulty paper lot	Try another kind of paper, between 100 to 250 Sheffield, 4% to 6% moisture content.
Dropouts, jamming, curl	Stored improperly	Store paper flat in its moisture-proof wrapping.
Increased gray background shading	Too heavy	<ul style="list-style-type: none">● Use lighter paper.● Use the left output bin or the upper bin.

Symptom	Problem	Solution
Excessive curl Problems with feeding	Too moist, wrong grain direction or short-grain construction	<ul style="list-style-type: none"> ● Use the left output bin or the upper bin. ● Use long-grain paper.
Jamming, damage to printer	Cutouts or perforations	Use paper free of cutouts or perforations.
Problems with feeding	Ragged edges	Use supported types of paper.
Multi-sheet feeding	Paper sticking together	Remove paper, fan it, and reload paper.

Labels

To avoid damaging the printer, use only labels recommended for use in monochrome laser printers. Never print on the same sheet of labels more than once.

CAUTION

Do not print on both sides of labels, transparencies, envelopes, custom paper, or paper heavier than 216 g/m² (58 lb bond). Damage to the printer and jams might result.

Label construction

When selecting labels, consider the quality of each component:

- **Adhesives:** The adhesive material should be stable at 200°C (392°F), the maximum fusing temperature of the printer.
- **Arrangement:** Only use full-sheet labels. Labels can peel off sheets with spaces between the labels, causing serious jams.
- **Curl:** Prior to printing, labels must lay flat with no more than 13 mm (0.5 inch) of curl in any direction.
- **Condition:** Do not use labels with wrinkles, bubbles, or other indications of separation.

Transparencies

CAUTION

Transparencies used in the printer must be able to withstand 200°C (392°F), the maximum fusing temperature of the printer. To avoid damaging the printer, use only transparencies recommended for use in monochrome laser printers.

Do not print on both sides of labels, transparencies, envelopes, custom paper, or paper heavier than 216 g/m² (58 lb bond). Damage to the printer and jamming might result.

If you have problems printing transparencies, use optional Tray 1 and send them to the left output bin or the upper bin.

Envelopes

Note

To print envelopes, use optional Tray 1 and print them either to the left output bin or to the upper bin.

Envelope construction

Envelope construction is critical. Envelope fold lines can vary considerably, not only between manufacturers, but also within a box from the same manufacturer. Successful printing on envelopes depends upon the quality of the envelopes. When selecting envelopes, consider the following components:

- **Weight:** See [Paper specifications](#) for supported envelope weight.
- **Construction:** Prior to printing, envelopes should lay flat with less than 6 mm (0.3 inch) curl and should not contain air. (Envelopes that trap air can cause problems.)
- **Condition:** Make sure envelopes are not wrinkled, nicked, or otherwise damaged.
- **Sizes in optional Tray 1:** See [Supported sizes of paper for input and output](#) for supported paper sizes.

Envelopes with adhesive strips or flaps

Envelopes with a peel-off adhesive strip, or with more than one flap that folds over to seal, must use adhesives compatible with the heat and pressure of the printer. The extra flaps and strips might cause wrinkling, creasing, or jams.

Envelopes with double-side-seams

Double-side-seam construction has vertical seams at both ends of the envelope rather than diagonal seams. This style might be more likely to wrinkle. Be sure the seam extends all the way to the corner of the envelope.

Envelope storage

Proper storage of envelopes helps contribute to good print quality. Envelopes should be stored flat. If air is trapped in an envelope creating an air bubble, then the envelope might wrinkle during printing.

Card stock and heavy paper

For optimum printer performance, do not use paper heavier than 216 g/m² (58 lb bond) in optional Tray 1 or 199 g/m² (53 lb) in other trays. Paper that is too heavy might cause misfeeds, stacking problems, jams, poor toner fusing, poor print quality, or excessive mechanical wear.

Card stock construction

- **Smoothness:** 135 to 216 g/m² (36 to 58 lb bond) card stock should have a smoothness rating of 100 to 180 Sheffield.
- **Construction:** Card stock should lay flat with less than 5 mm (0.2 inches) of curl.
- **Condition:** Make sure card stock is not wrinkled, nicked, or otherwise damaged.
- **Sizes:** See the sizes listed for [Optional Tray 1](#).

Note

Before loading card stock in optional Tray 1, make sure it is regular in shape and not damaged. Also, make sure the cards are not stuck together.

Environmental specifications

Electrical specifications

WARNING!

Power requirements are based on the country/region where the printer is sold. Do not convert operating voltages. This may damage the printer and void the product warranty.

Power requirements

	110-Volt models	230-Volt models
	100-127V (+/- 10%) 50/60 Hz (+/- 2 Hz)	220-240V (+/- 10%) 50/60 Hz (+/- 2 Hz)
Rated short-term current	12 Amps	5.3 Amps

Power consumption

Product model ²	Power consumption (average, in watts) ¹			
	Printing ³ (110-127V) (220-240V)	Ready ⁴ (110-127V) (220-240V)	Sleep 2 ⁵ (Fan off) (110-127V) (220-240V)	Off (110-127V) (220-240V)
HP LaserJet 9050	1,000 Watts	200 Watts	21 Watts	0.5 Watts
HP LaserJet 9050n	1,000 Watts	200 Watts	21 Watts	0.5 Watts
HP LaserJet 9050dn	1,000 Watts	200 Watts	21 Watts	0.5 Watts
HP LaserJet 9040	900 Watts	200 Watts	21 Watts	0.5 Watts
HP LaserJet 9040n	900 Watts	200 Watts	21 Watts	0.5 Watts
HP LaserJet 9040dn	900 Watts	200 Watts	21 Watts	0.5 Watts

1. Values current as of October 24, 2004. Values subject to change, see www.hp.com/support/lj9050_lj9040 for current information.

2. The HP LaserJet 9050 print speed is 50 pages per minute (ppm). The HP LaserJet 9040 print speed is 40 ppm.

3. Power reported is highest values measured using all standard voltages.

4. Heat dissipation in Ready mode = 700 BTU/hour.

5. Default time from Ready mode to Sleep 2 = 60 minutes.

Acoustical specifications

Declared per ISO 9296

Sound power level ¹ HP LaserJet 9050	Printing (50 ppm)	$L_{WA_d} = 7.2$ Bels (A) [72 dB(A)]
	Ready	$L_{WA_d} = 5.6$ Bels (A) [56 dB(A)]
Sound power level ² HP LaserJet 9040	Printing (40 ppm)	$L_{WA_d} = 7.0$ Bels (A) [dB(A)]
	Ready	$L_{WA_d} = 5.6$ Bels (A) [dB(A)]
Sound pressure level ³ (Bystander position) HP LaserJet 9050	Printing (50 ppm)	$L_{pAm} = 56$ dB(A)
	Ready	$L_{pAm} = 40$ dB(A)
Sound pressure level ⁴ (Bystander position) HP LaserJet 9040	Printing (40 ppm)	$L_{pAm} = 54$ dB(A)
	Ready	$L_{pAm} = 39$ dB(A)

1. Values current as of October 16, 2003. Values subject to change, see www.hp.com/support/lj9050_lj9040 for current information.
2. Values current as of October 24, 2004. Values subject to change, see www.hp.com/support/lj9050_lj9040 for current information.
3. Values current as of October 16, 2003. Values subject to change, see www.hp.com/support/lj9050_lj9040 for current information.
4. Values current as of October 24, 2004. Values subject to change, see www.hp.com/support/lj9050_lj9040 for current information.

Note

Configuration tested: The HP LaserJet 9050 printing simplex from Tray 3 at 50 ppm using A4 paper, and the HP LaserJet 9040 printing simplex from Tray 3 at 40 ppm using A4 paper.

Operating environment

Operating temperature	50°F to 91°F (10°C to 32.5°C)
Relative humidity	10% to 80%
Storage temperature	-40°F to +60°F
Storage humidity	15% to 90%
Speed, in pages per minute (ppm)	50 ppm (HP LaserJet 9050 series printer) or 40 ppm (HP LaserJet 9040 series printer)
Expandable memory	Up to 512 MB total, using optional accessory memory DDR DIMMs

B Control-panel menus

Overview

The control-panel menu layout shows the menus that everyone uses while protecting the menus that administrators use. Everyone typically uses the first three menus in the list. Administrators and service technicians use the other items, which can be protected with a personal identification number (PIN).

Perform most routine printing tasks from the computer by using the printer driver or the software program. These settings override the printer control-panel settings. See the Help files that are associated with the software, or, for more information about the printer driver, see [Gaining access to the printer drivers](#). If you cannot open a menu or use an item, it either is not an option for the printer or your network administrator has locked the function (ACCESS DENIED MENU LOCKED appears on the control panel). See your system administrator for more information.

Note

Printer driver and software commands override the printer control-panel settings.

At the control panel, you can print a menu map that indicates the layout and current settings of the control-panel menu items (see [Menu map](#)).

Additional menu items can appear in the control panel, depending on the options that are installed in the printer.

This appendix contains information about all the items and possible values that are available on the printer. (Default values are listed in the “Item” column.)

For more information about an optional HP output device, see the user guide that came with the device.

This appendix contains information about the following topics:

- The [Retrieve job menu](#) shows jobs that are stored on the device. Jobs are listed by user and job name. See [Using the job-storage features](#) for information about how to store jobs.
- The [Information menu](#) provides a menu map that can be printed and other information pages.
- The [Paper handling menu](#) is used to set the media type (and the size, if it is not detected) for each tray.
- The [Configure device menu](#) allows administrators to set defaults, I/O ports, run diagnostics, and reset the printer.



The following submenus are available on the Configure device menu:

- [Printing submenu](#)
- [System setup submenu](#)
- [I/O submenu](#)
- [Resets submenu](#)
- [Diagnostics menu](#) provides information about the printer that administrators and service technicians can use to define settings, see usage information, and troubleshoot problems.
- The [Service menu](#) allows service technicians to monitor printer status and to provide appropriate assistance during a service call.

Retrieve job menu

Note

If no private, stored, quick copy, or proof and hold jobs are stored on the printer hard disk or in RAM, the message `NO STORED JOB` appears when the menu is selected.

- 1 A list of user names appears.
- 2 Select a user name, and a list of jobs that are stored for that user appears.
- 3 Select a job name, and print or delete that job. If a job requires a PIN before it can be printed or deleted,  appears next to the `PRINT` or `DELETE` command and a PIN must be typed. If a job requires a PIN to delete,  appears next to the `DELETE` command and a PIN must be provided.
- 4 If you select `PRINT`, the printer prompts you to specify the number of copies to print (1 to 32,000).

Information menu

To print an information page, scroll to the information page that you want and press .

Item	Explanation
<code>PRINT MENU MAP</code>	Generates a menu map that shows layout and current settings of the control menu items. The printer will back up one screen to <code>SET FRONT TO BACK</code> when the page is completed.
<code>PRINT CONFIGURATION</code>	Generates a page detailing the current configuration of the printer. The printer will return to the online <code>READY</code> state when the page is completed.
<code>PRINT SUPPLIES STATUS PAGE</code>	Generates a page that shows the number of pages remaining for each supply in the printer. The printer will return to the online <code>READY</code> state when the page is completed.
<code>PRINT USAGE PAGE</code>	Generates a page that contains information that could be used for cost accounting. This item is only available if a hard disk is installed. The printer will return to the online <code>READY</code> state when the page is completed.
<code>PRINT FILE DIRECTORY</code>	Generates a directory page containing information for all installed mass storage devices. The printer will return to the online <code>READY</code> state when the page is completed.
<code>PRINT PCL FONT LIST</code>	Generates a typeface list of all PCL fonts available on the printer. The printer will return to the online <code>READY</code> state when the page is completed.
<code>PRINT PS FONT LIST</code>	Generates a typeface list of all PS fonts available on the printer. The printer will return to the online <code>READY</code> state when the page is completed.

Paper handling menu

When paper handling settings are correctly configured through the control panel, you can print by selecting the type and size of paper from the printer driver or software application. For more information, see [Specifying paper to print on](#).

Some items in this menu (such as duplex and manual feed) are available from specific software programs, or from the printer driver (if the appropriate driver is installed). Printer driver and software program settings override control-panel settings. For more information, see [Using features in the printer driver](#).

Item	Values	Explanation
TRAY <N> SIZE=LETTER	ANY SIZE LETTER LETTER-ROTATED LEGAL A4 A4-ROTATED EXECUTIVE EXECUTIVE(JIS) A3 A5 B4(JIS) B5(JIS) 8K 16K 8.5 X 13 11 X 17 CUSTOM ANY CUSTOM	Allows the user to set the paper size for Tray 2, 3, and optional Tray 4 (if installed) when the custom switch is in the CUSTOM position. Size is detected if the switch is in the STANDARD position. Substitute the tray number for <N>.
TRAY <N> TYPE=PLAIN	ANY TYPE PLAIN PREPRINTED LETTERHEAD TRANSPARENCY PREPUNCHED LABELS BOND RECYCLED COLOR CARDSTOCK>163 ROUGH 90-105 G/M2 ENVELOPE *	Allows the user to specify the type of media in each tray. Substitute the tray number for <N>. *ENVELOPE appears for Tray 1 only.

Configure device menu

This menu contains all administrative functions.

Printing submenu

Some items in this menu are available from a software application, or from the printer driver (if the appropriate driver is installed). Printer driver and program settings override control-panel settings. For more information, see [Using features in the printer driver](#).

Item	Values	Explanation
COPIES=1	1 to 32,000	Set the default number of copies by selecting any number from 1 to 32,000. Use the numeric keypad to select the number of copies. Note It is best to set the number of copies from the printer driver or software application. (Driver and software settings override control-panel settings.)
DEFAULT PAPER SIZE= LETTER	LETTER LEGAL A4 EXECUTIVE 11X17 A3 B4(JIS) B5(JIS) CUSTOM A5 LETTER ROTATED STATEMENT 8.5X13 12X18 A4 ROTATED RA3 EXECUTIVE(JIS) DPOSTCARDS(JIS) 8K 16k ENVELOPE #10 ENVELOPE MONARCH ENVELOPE C5 ENVELOPE DL ENVELOPE B5	Set the default image size for paper and envelopes. (The item name will change from paper to envelope as you scroll through the available sizes.)

Item	Values	Explanation
DEFAULT PAPER TYPE	PLAIN PREPRINTED LETTERHEAD TRANSPARENCY PREPUNCHED LABELS BOND RECYCLED COLOR CARDSTOCK>163 ROUGH 90-105 G/M2 ENVELOPE *	Allows the user to specify the type of media in each tray. Substitute the tray number for <N>. *ENVELOPE appears for Tray 1 only.
DEFAULT CUSTOM PAPER SIZE	UNIT OF MEASURE X DIMENSION Y DIMENSION	Allows the user to set a custom paper size for any of the installed trays. Substitute the tray number for <N>. This menu only appears when the selected tray custom switch is in the custom size position. The user selects the X and Y dimensions of the custom paper size using the ruler labels in the trays.
PAPER DESTINATION=STANDARD OUTPUT	STANDARD OUTPUT LEFT OUTPUT BIN STANDARD TOP BIN	Allows the user to configure the output paper bin destination. Only installed optional bins will appear on the menu.
DUPLEX=OFF	OFF ON	This item appears only when an optional duplex printing accessory is installed. Set the value to ON to print on both sides (duplex) or OFF to print on one side (simplex) of a sheet of paper. For more information, see the HP support flyer or go to www.hp.com/support/lj9050_lj9040 .
DUPLEX BINDING=LONG EDGE	LONG EDGE SHORT EDGE	Allows the user to change the binding edge for duplex printing. The menu item is displayed when a duplex printing accessory is installed in the printer and DUPLEX=ON.
OVERRIDE A4/LETTER=NO	YES NO	This command is used to print on letter-size paper when an A4 job is sent, but no A4-size paper is loaded in the printer (or to print on A4-size paper when a letter job is sent, but no letter paper is loaded in the printer).
MANUAL FEED=OFF	OFF ON	Feed the paper manually from optional Tray 1, rather than automatically from a tray. When MANUAL FEED=ON and optional Tray 1 is empty, the printer goes offline when it receives a print job. It then displays MANUALLY FEED [PAPER SIZE]. For more information, see Manually feeding paper from optional Tray 1 .
EDGE TO EDGE OVERRIDE=NO	NO YES	Turns the edge-to-edge mode on or off for all print jobs. This mode can be overridden inside a print job by an edge-to-edge PJJ variable.

Item	Values	Explanation
COURIER FONT=REGULAR	REGULAR DARK	Select the version of Courier font to use: REGULAR: The internal Courier font available on the HP LaserJet 4 Series printers. DARK: The internal Courier font available on the HP LaserJet III Series printers. Both fonts are not available at the same time.
WIDE A4=NO	YES NO	The Wide A4 setting changes the number of characters that can be printed on a single line of A4 paper. YES: Up to 80 10-pitch characters can be printed on one line. NO: Up to 78 10-pitch characters can be printed on one line.
PRINT PS ERRORS=OFF	ON OFF	Select ON to print the PS error page when PS errors occur.
PRINT PDF ERRORS= OFF	OFF ON	Select ON to print the PDF error page when PDF errors occur.

PCL submenu

Item	Values	Explanation
FORM LENGTH=60	5 to 128	Sets vertical spacing from 5 to 128 lines for default paper size. Enter the value using the numeric keypad.
ORIENTATION= PORTRAIT	PORTRAIT LANDSCAPE	Allows the user to select default page orientation. Note It is best to set the page orientation from the printer driver or software application. (Driver and software settings override control-panel settings.)
FONT SOURCE=INTERNAL	INTERNAL CARD SLOT X	INTERNAL: Internal fonts. SLOT 1, 2, or 3: Fonts stored in one of the three DIMM slots.
FONT NUMBER=0	0-999	The printer assigns a number to each font and lists them on the PCL Font List (See PCL or PS font list). The font number appears in the Font # column of the printout.
FONT PITCH=10.00	0.44 to 99.99	Using the numeric keypad or ▲ and ▼, enter a value. This item might not appear, depending on the font selected.
SYMBOL SET=PC-8	Variety of available symbol sets	Select any one of several available symbol sets from the printer control panel. A symbol set is a unique grouping of all the characters in a font. PC-8 or PC-850 is recommended for line draw characters.

Item	Values	Explanation
APPEND CR TO LF=NO	YES NO	Select YES to append a carriage return to each line feed encountered in backward-compatible PCL jobs (pure text, no job control). Some environments, such as UNIX, indicate a new line using only the line feed control code. This option allows the user to append the required carriage return to each line feed.
SUPRESS BLANK PAGES=NO	NO YES	When set to YES, form feeds are ignored if the page is blank.

Print quality submenu

Some items in this menu are accessible from a software application, or from the driver (if the appropriate driver is installed). Driver and software settings override control-panel settings. For more information, see [Using features in the printer driver](#).

Item	Values	Explanation
SET REGISTRATION	PRINT TEST PAGE SOURCE=TRAY 2 ADJUST TRAY <X>	Shift the margin alignment to center the image on the page from top to bottom, and left to right. You can also align the image on the front, with the image printed on the back.
FUSER MODES	List of paper types	<p>Configure the fuser mode associated with each paper type. The fuser mode can only be changed from this menu option in the control panel.</p> <p>AUTO: Utilizes the optimum mode for that media type. NORMAL: Normal temperature, prints at 50 pages per minute (ppm) (40 ppm for the HP LaserJet 9040). LOW: Low temperature, prints at 50 ppm (40 ppm for the HP LaserJet 9040). HIGH1: Raises the temperature, prints at 50 ppm (40 ppm for the HP LaserJet 9040). HIGH2: Raises the temperature, prints at 32 ppm. SPECIAL: Mode to print at normal speeds with a 40-second delay added to the beginning of the next job. After each 400 pages are printed, the first page of that job is printed at a slower speed in order to clean the fuser. No defects should be noticeable on the printed page. This is not a preferred setting.</p> <p>The default value for each paper type is AUTO. For a complete list of supported paper types, see Paper specifications.</p> <p>CAUTION If you change the fuser mode to HIGH1 or HIGH2, be sure to change it back to the default when you are done printing. Setting a paper type to HIGH1 or HIGH2 might shorten the life of some consumables, such as the fuser, and might cause other failures or jams.</p>

Item	Values	Explanation
RESOLUTION= FASTRES 1200	300 600 FASTRES 1200	<p>Select the resolution from the following values:</p> <p>300: Produces draft print quality at maximum printer speed. 300 dpi (dots per inch) is recommended for some bitmapped fonts and graphics, and for compatibility with the HP LaserJet III family of printers.</p> <p>600: Produces high print quality at maximum product speed.</p> <p>FASTRES 1200: Produces optimum print quality (comparable to 1200 dpi) at maximum product speed.</p> <p>Note It is best to change the resolution from the driver or software application. (Driver and software settings override control-panel settings.)</p>
RET=MEDIUM	OFF LIGHT MEDIUM DARK	<p>Use printer Resolution Enhancement technology (REt) setting to produce print with smooth angles, curves, and edges.</p> <p>All print resolutions, including FastRes 1200, benefit from REt.</p> <p>Note It is best to change the REt setting from the driver or software application. (Driver and software settings override control-panel settings.)</p>
ECONOMODE	ON OFF	<p>When set to ON, the printer prints with a reduced amount of toner per page; however, the print quality of the page is drastically reduced.</p>
TONER DENSITY=3	1 to 5	<p>Lighten or darken the print on the page by changing the toner density setting. The settings range from 1 (light) to 5 (dark), but the default setting of 3 usually produces the best results.</p> <p>Note It is best to change the toner density from the driver or software application. (Driver and software settings override control-panel settings.)</p>
SMALL PAPER MODE=NORMAL	NORMAL SLOW	<p>When printing narrow media the part of the fuser rollers that do not make contact with the media swell up and can cause wrinkles.</p>

System setup submenu

Items in this menu affect the printer function. Configure the printer according to your printing needs.

Item	Values	Explanation
DATE/TIME	DATE DATE FORMAT TIME TIME FORMAT	Sets the date and time for the printer. The Real Time Clock is set to Greenwich Mean Time (GMT).
JOB STORAGE LIMIT=32	1 to 100	Specifies the number of jobs that can be stored on the printer hard disk accessory.
JOB HELD TIMEOUT= OFF	OFF 1 HOUR 4 HOURS 1 DAY 1 WEEK	Sets the amount of time that quick copy, proof and hold, private, and stored jobs are kept before being automatically deleted from the queue.
SHOW ADDRESS=OFF	AUTO OFF	Sets whether or not the printer IP address will be shown with the Ready message. If this value is "on," the address of the EIO card in slot 1 is shown.
TRAY BEHAVIOR	USE REQUESTED TRAY MANUAL FEED PROMPT PS DEFER MEDIA	Specifies the behavior of the tray by indicating which tray the printer should print from. USE REQUESTED TRAY sets the tray that the printer should print from for specified jobs. The values for this menu item are EXCLUSIVELY (default) and FIRST. MANUAL FEED PROMPT determines whether or not the product prompts the use when a job does not match a requested configured tray. The values for this menu item are ALWAYS (default) or UNLESS LOADED. PS DEFER MEDIA sets whether the paper-handling model is based on PostScript rules or HP rules. The values for this menu item are ENABLED (default) and DISABLED.
SLEEP DELAY=60 MINUTES	1 MINUTE 15 MINUTES 30 MINUTES 60 MINUTES 90 MINUTES 2 HOURS 4 HOURS	Set how long the printer remains idle before it enters Sleep mode: <ul style="list-style-type: none"> Minimizes the amount of power consumed by the printer when it is idle. Reduces wear on the printer electronic components (Turns off the display backlight). When you send a print job, press a control-panel button, open a paper tray, or open the top cover, the printer automatically exits Sleep mode. <p>Note Sleep turns off the backlight on the display, but the display is still readable.</p>
WAKE TIME SUBMENU	SETTING WAKE TIME	Sets the time that the printer automatically comes out of sleep mode. This feature can be set for a different time for each day of the week.

Item	Values	Explanation
PERSONALITY=AUTO	AUTO PCL PS PDF XHTML MIME	Select the default printer language (personality). Possible values are determined by which valid languages are installed in the printer. Normally you should not change the printer language (the default is AUTO). If you change it to a specific printer language, the printer does not automatically switch from one language to another unless specific software commands are sent to the printer.
CLEARABLE WARNINGS=JOB	ON JOB	Set the amount of time that a clearable warning appears on the printer control panel. ON: Warning messages appear on the control panel until ✓ is pressed. JOB: Warning messages appear on the control panel until the end of the job from which they were generated.
AUTO_CONTINUE=ON	ON OFF	Determine how the printer reacts to errors. ON: If an error prevents printing, the message is displayed, and the printer goes offline for 10 seconds before returning online. OFF: If an error prevents printing, the message remains on the display, and the printer does not print until ✓ is pressed. Note To stop printing when out of staples (when a stapler accessory is installed), set AUTO_CONTINUE=OFF on the control-panel System setup menu.
CARTRIDGE_LOW=CONTINUE	CONTINUE STOP	Determine how the printer functions when toner is low. The CARTRIDGE_LOW message first appears when the print cartridge is almost out of toner. (About 2400 pages can still be printed at 5% coverage.) CONTINUE: The printer continues to print while the CARTRIDGE_LOW message is displayed. STOP: The printer goes offline and wait for further action. For more information, see Managing the print cartridge .
CARTRIDGE_OUT=CONTINUE	STOP CONTINUE	Determine how the printer functions when toner is out.
JAM_RECOVERY=AUTO	AUTO ON OFF	Determine how the printer functions when a jam occurs. AUTO: The printer automatically selects the best mode for printer jam recovery (usually ON). This is the default setting. ON: The printer automatically reprints pages after a paper jam is cleared. OFF: The printer does not reprint pages following a paper jam. Printing performance might be increased with this setting.
LANGUAGE=ENGLISH	List of available languages	Sets the language that is used on the control panel.

I/O submenu

Items in the **I/O** (input/output) menu affect the communication between the printer and the computer.

I/O timeout submenu

Item	Values	Explanation
I/O TIMEOUT=15	5 to 300	Select the I/O timeout period in seconds. (I/O timeout refers to the time, measured in seconds, that the printer waits before ending a print job.) This setting allows you to adjust timeout for best performance. If data from other ports appear in the middle of your print job, increase the timeout value.

Parallel input submenu

Item	Values	Explanation
HIGH SPEED=YES	YES NO	The printer accepts faster parallel communications used for connections with newer computers.
ADVANCED FUNCTIONS=ON	ON OFF	Turn the bidirectional parallel communication on or off. The default is set for a bidirectional parallel port (IEEE-1284). This setting allows the printer to send status readback messages to the computer. (Turning the parallel advanced functions on might slow language switching.)

EIO X Jetdirect submenu

The EIO (enhanced input/output) submenu appears only when an EIO device is installed in an EIO slot on the printer (such as an HP Jetdirect print server). The items in the menu depend on the particular accessory product installed. If the printer contains an HP Jetdirect print server EIO card, you can configure basic networking parameters using the EIO menu. These and other parameters can also be configured through HP Web Jetadmin or other network configuration tools (such as by using Telnet or browsing the embedded Web server).

For more information about the EIO submenu, see the documentation that came with the EIO Jetdirect card.

Embedded Jetdirect submenu

Item	Options	Values	Explanation	
TCP/IP	ENABLE	ON OFF	Enable the TCP/IP protocol. Disable the TCP/IP protocol.	
	HOST NAME		An alphanumeric string, up to 32 characters, used to identify the device. This name is listed on the Jetdirect configuration page. The default host name is NPIxxxxxx, where xxxxxx is the last six digits of the LAN hardware (MAC) address.	
	CONFIG METHOD	BOOTP		Use BootP (Bootstrap Protocol) for automatic configuration from a BootP server.
		DHCP		Use DHCP (Dynamic Host Configuration Protocol) for automatic configuration from a DHCP server. If selected and a DHCP lease exists, DHCP RELEASE and DHCP RENEW menus will be available to set DHCP lease options.
		AUTO IP		Use automatic link-local IP addressing. An address in the form 169.254.x.x will be automatically assigned.
		MANUAL		Use the MANUAL SETTINGS menu to configure TCP/IP parameters.
	DHCP RELEASE		The current DHCP lease along with the leased IP address are released.	
	DHCP RENEW	NO (default)		The print server does not request to renew the DHCP lease.
		YES		The print server requests to renew the current DHCP lease.
	MANUAL SETTINGS	IP ADDRESS		The unique IP address of the printer.
		SUBNET MASK		The subnet mask for the printer.
		SYSLOG SERVER		The IP address of the syslog server used to receive and log syslog messages.
		DEFAULT GATEWAY		The IP address of the gateway or router used for communications with other networks.
IDLE TIMEOUT			The time period, in seconds, after which an idle TCP print data connection is closed (default is 270 seconds).	

Item	Options	Values	Explanation
TCP/IP	DEFAULT IP PRIMARY DNS SECONDARY DNS PROXY SERVER PROXY PORT	AUTO IP LEGACY	<p>A link-local IP address 169.254.x.x will be set.</p> <p>The address 192.0.0.192 will be set, consistent with older Jetdirect products.</p> <p>Specify the IP address (n.n.n.n) of the Primary Domain Name System (DNS) Server.</p> <p>Specify the IP address (n.n.n.n) of the Secondary Domain Name System (DNS) Server.</p> <p>Specifies the proxy server to be used by embedded applications in your printer. A proxy server is typically used by network clients for Internet access. It caches Web pages, and provides a degree of Internet security, for those clients.</p> <p>To specify a proxy server, enter its IP address or fully-qualified domain name. The name can be up to 64 characters.</p> <p>For some networks, you may need to contact your Independent Service Provider (ISP) for the proxy server address.</p> <p>Enter the port number used by the proxy server for client support. The port number identifies the port reserved for proxy activity on your network, and can be a value from 0 to 65535.</p>
IPX/SPX	ENABLE FRAME TYPE	ON OFF AUTO EN_8023 EN_LII EN_8022 EN_SNAP	<p>Enable the IPX/SPX protocol. Disable the IPX/SPX protocol.</p> <p>Selects the frame type setting for your network. AUTO (default) Automatically sets and limits the frame type to the first one detected.</p> <p>Frame type selections for Ethernet networks.</p>
APPLETALK	ENABLE	ON OFF	Enable or disable the AppleTalk protocol.
DLC/LLC	ENABLE		Enable or disable the DLC/LLC protocol.
SECURE WEB	HTTPS REQUIRED HTTPS OPTIONAL		<p>For secure, encrypted communications, only HTTPS access is accepted. The print server will appear as a secure site.</p> <p>Access using either HTTP or HTTPS permitted.</p>

Item	Options	Values	Explanation	
DIAGNOSTICS	LOOPBACK TEST	YES	CAUTION This test will erase your TCP/IP configuration. YES the loopback test will be initiated. NO the loopback test will not be initiated.	
		NO		
	PING TEST	DEST IP	Specify the IP address of the remote host. A valid IP address must be entered.	
		PACKET SIZE	Specify the size of each packet, in bytes, to be sent to the remote host. The minimum is 64 (default) and the maximum is 2048.	
		TIMEOUT	Specify the length of time, in seconds, to wait for a response from the remote host. The default is 1 and the maximum is 100.	
		COUNT	Specify the number of ping test packets to send for this test. Select a value from 1 to 100. To configure the test to run continuously, select 0.	
		PRINT RESULTS	If the ping test was not set for continuous operation, you can choose to print the test results. YES to print results, NO to skip.	
		EXECUTE	Specify whether to initiate the ping test. Select YES to initiate, NO to skip.	
		PING RESULTS	PACKETS SENT	Determines the number of packets (0-65535) sent to the remote host since the most recent test was initiated or completed.
			PACKETS RECEIVED	Displays the number of packets (0-65535) received from the remote host since the most recent test was initiated or completed.
			PERCENT LOST	Displays the percent of ping test packets that were sent with no response from the remote host since the most recent test was initiated or completed.
			RTT MIN	Displays the minimum detected round-trip-time (RTT), from 0 to 4096 milliseconds, for packet transmission and response.
	RTT MAX		Displays the maximum detected RTT, from 0 to 4096 milliseconds, for packet transmission and response.	
		RTT AVE	Displays the average detected RTT, from 0 to 4096 milliseconds, for packet transmission and response.	
		PING IN PROGRESS	Displays whether or not a ping test is in progress. YES indicates a test in progress, NO indicates that a test completed or was not run.	
	REFRESH	Updates the ping test data with current results.		

Item	Options	Values	Explanation
RESET SECURITY	NO YES	NO YES	Specifies whether the current security settings on the print server will be saved or reset to factory defaults. NO (default) The current security settings are maintained. YES Security settings are reset to factory defaults.
LINK SPEED	AUTO 10T HALF 10T FULL 100TX HALF 100TX FULL		The print server will automatically configure itself to match the network's link speed and communication mode. If it fails, 100TX HALF is set. 10Mbps, half-duplex operation. 10Mbps, full-duplex operation. 100Mbps, half-duplex operation. 100Mbps, full-duplex operation.

Resets submenu

Note

Use this menu with caution. You can lose buffered page data or printer configuration settings when you select these items. Reset the product only under the following circumstances:

- You want to restore the printer default settings.
- Communication between the product and computer has been interrupted.
- You are having problems with a port.

The items in the `Resets` submenu will clear all memory in the printer, while `RESET` clears only the current job.

Diagnostics menu

Administrators can use this menu to troubleshoot jam and print quality issues.

Item	Values	Explanation
PRINT EVENT LOG		Generates a localized LIFO (last in, first out) list of the 50 most recent entries in the error log. The printed event log shows error number, page count, error code, and description or personality.
SHOW EVENT LOG		Allows the user to scroll through the contents of the event log from the printer control panel, and shows the 50 most recent events. Use ▲ and ▼ to scroll through the event log contents.
PAPER PATH TEST	PRINT TEST PAGE	Generates a test page that is useful for testing the paper handling features of the printer.
	SOURCE=TRAY 2	Specifies if paper from all of the trays or from a specific tray is used when the test is performed.
	DESTINATION=STANDARD OUTPUT	Specifies which paper paths are tested.
	DUPLEX=OFF	Specifies if the duplexer is included when the test is performed.
	COPIES=1	Specifies how many sheets of paper from the specified source are sent when the test is performed.
	SENSORS=OFF	Specifies if sensor information is displayed as the paper moves through the path or if only the status of the device is displayed during the paper path test.

Service menu

The Service menu is locked. A service technician must type a PIN to open the menu.

C Printer memory and expansion

Overview

This appendix includes:

- Determining memory requirements
- Installing memory and fonts
- Checking memory installation
- Saving resources (permanent resources)
- Installing EIO cards/mass storage

The printer has two double data rate (DDR) memory DIMM slots for upgrading various features.

- To add more printer memory, DDR memory DIMMs are available in 16, 32, 64, 128, and 256 MB, for a maximum of 512 MB.
- To increase flash memory cards, available in 16, 32, and 64 MB. Unlike standard printer memory, flash memory cards can be used to permanently store downloaded items in the printer, even when the printer is off. The printer supports Type 1 and Type 2 flash memory.
- To add flash memory-based accessory fonts, macros, and patterns, use the appropriate DDR DIMM.
- To add other flash memory-based printer languages and printer options, use the appropriate DDR DIMM.

Note

Single in-line memory modules (SIMMs) used on previous HP LaserJet printers are not compatible with this printer.

You might want to add more memory to the printer if you often print complex graphics or PS documents, print with the optional duplex printing accessory, use many downloaded fonts, or print large paper sizes (such as A3, B4, or 11 x 17).

The printer has two EIO slots for expanding printer capabilities:

- One or more network cards.
- A mass storage device, such as a hard disk.

For ordering information, see the HP support flyer, or go to www.hp.com/support/lj9050_lj9040.

Determining memory requirements

The amount of memory you need depends on the types of documents you print. Your print engine can print most text and graphics at 1,200 dpi FastRes without additional memory.

Add memory to your printer if you:

- commonly print complex graphics.
- use many temporarily downloaded fonts.
- print complex documents.
- print two-sided documents.
- use advanced functions.
- print PostScript documents.

Installing memory and fonts

To install DDR memory DIMMs

Use this procedure to install additional memory. Before you begin, print a configuration page (see [To print a configuration page](#)) to find out how much memory is installed in the printer before adding more memory. The table lists the maximum amount of memory allowed for each DIMM slot.

Note

On the HP LaserJet 9040/9050 base model, to obtain 512 MB of memory, you need to remove the 64 MB that came with the printer and replace it with 256 MB.







On the HP LaserJet 9040n/9050n and the HP LaserJet 9040dn/9050dn, to obtain 512 MB of memory, you need to remove the 128 MB that came with the printer and replace it with 256 MB.

Slot label on the Configuration page	Slot label on the Formatter board	Description
Slot 1	J1	64 MB or 128 MB depending on model
Slot 2	J2	Empty
Total		64 MB or 128 MB depending on model

CAUTION

Static electricity can damage DIMMs. When handling DIMMs, either wear an antistatic wrist strap or frequently touch the surface of the DIMM antistatic package, then touch bare metal on the printer.

To print a configuration page

- 1 Press .
- 2 Use  or  to scroll to `Information` and press .
- 3 Use  or  to scroll to `Print Configuration` and press .

To install memory

- 1 If you have not already done so, print a configuration page to find out how much memory is installed in the printer before adding more memory. (Press **22** on the numeric keypad when the printer is idle.)
- 2 Turn the printer off. Disconnect the power cord and any cables.

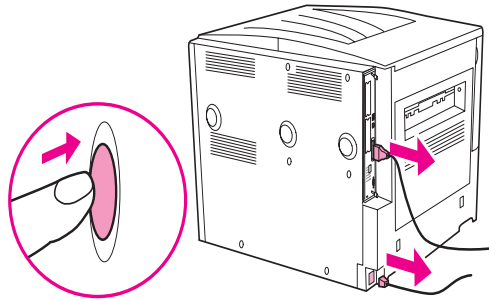

- 3 Loosen the two captive thumb screws on the back of the printer.

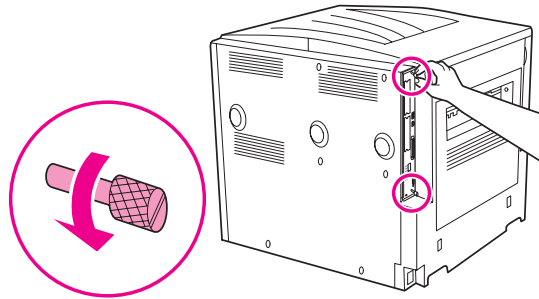

WARNING!

The formatter has sharp edges.

- 4 Grasp the screws and pull the formatter board out of the printer. Place it on a flat, non-conductive surface.

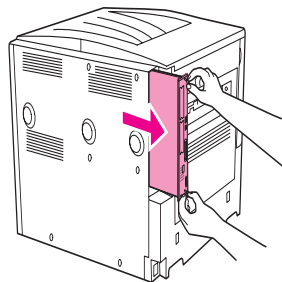

- 5 Remove the DIMM from the antistatic package. Hold the DIMM with fingers against the side edges and thumbs against the back edge. Align the notches on the DIMM with the DIMM slot. (Check that the locks on each side of the DIMM slot are open, or outward.) See [Installing memory and fonts](#) for the maximum amount of memory for each DIMM slot.

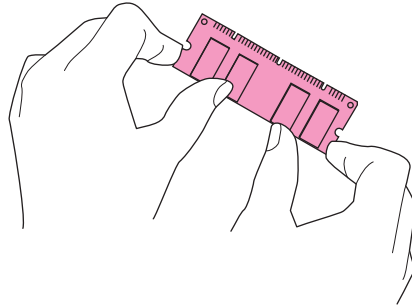

- 6 Press the DIMM straight into the slot (press firmly). Make sure the locks on each side of the DIMM snap inward into place. (To remove a DIMM, the locks must be released.)

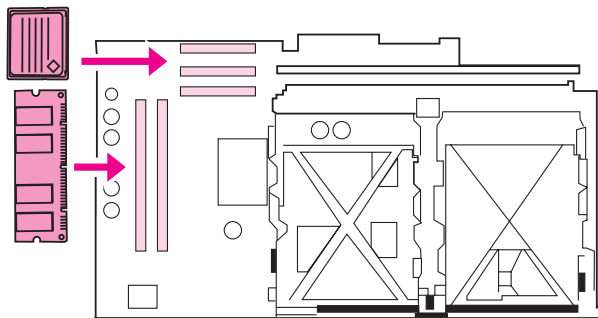

- 7 Slide the formatter board back into the printer and tighten the two screws.

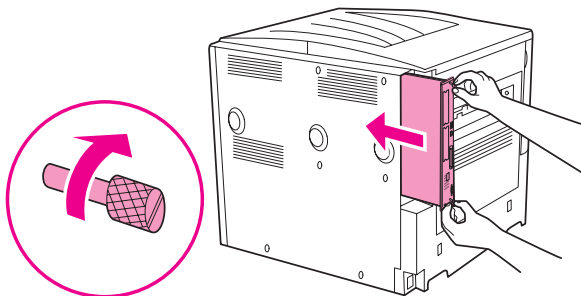

- 8 Plug in the power cord and connect all cables. Turn the printer on.

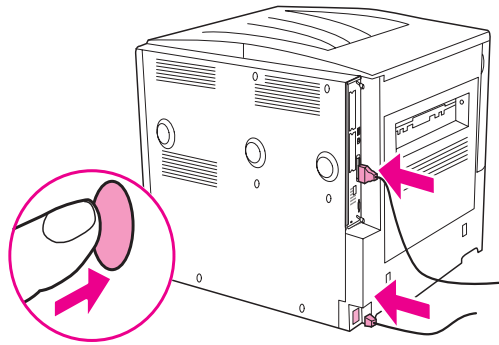

To install a flash memory card

CAUTION

Do not insert a flash memory card that is designed for use with a digital camera into the printer. The printer does not support photo printing directly from a flash memory card. If you install a camera-type flash memory card, a message asking if you want to reformat the flash memory card appears on the control-panel display. If you choose to reformat the card, all data on the card will be lost.

- 1 Turn the printer off and disconnect all power and interface cables.

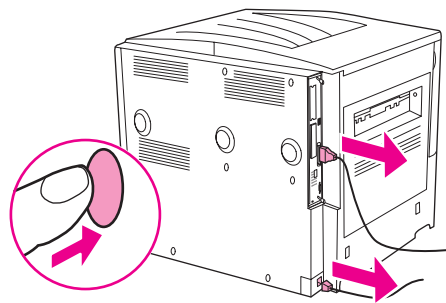

- 2 Loosen the two captive thumb screws on the back of the printer.

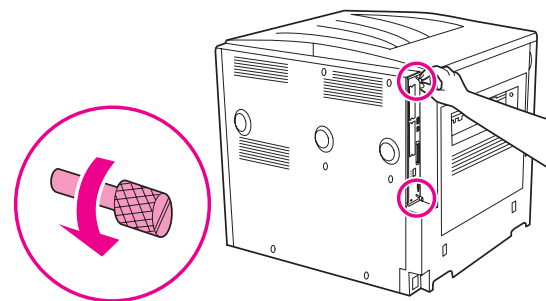

WARNING!

The formatter has sharp edges.

- 3 Grasp the screws and pull the formatter board out of the printer. Place it on a flat, non-conductive surface.

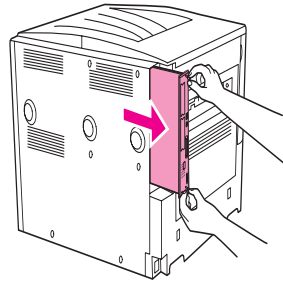

- 4 Remove the compact flash from the antistatic package. Hold the compact flash with fingers against the side edges and thumbs against the back edge. Align the notches on the compact flash with the compact flash slot.

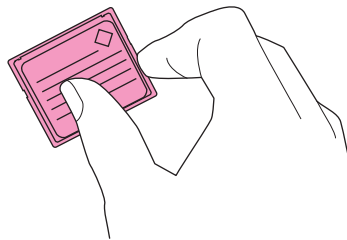

- 5 Press the compact flash straight into the slot.

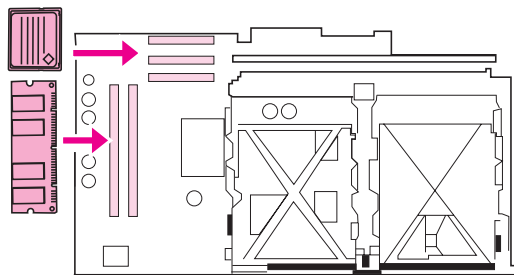

CAUTION

Do not insert the flash memory card at an angle.

Note

The first flash memory slot marked "Firmware Slot" is reserved for firmware only. Slots 2 and 3 should be used for all other solutions.

- 6 Slide the formatter board back into the printer and tighten the two screws.

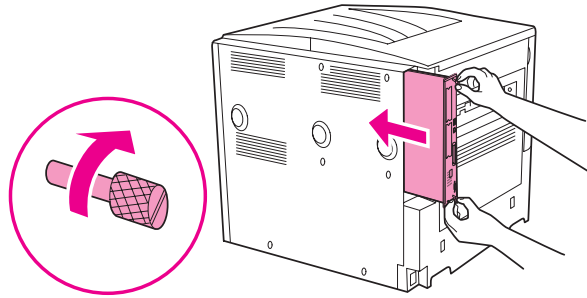

- 7 Plug in the power cord and connect all cables. Turn the printer on.

Checking memory installation

Follow this procedure to verify that memory is installed correctly:

- 1 Check that **READY** appears on the printer control-panel display when the printer is turned on. If an error message appears, a DIMM might have been incorrectly installed.
- 2 Press **22** on the numeric keypad. The configuration page prints.
- 3 Check the memory section on the configuration page and compare it to the configuration page printed before the DIMM installation. If the amount of memory has not increased, one of the following situations might have occurred:
 - The memory might not be installed correctly. Repeat the installation procedure.
 - The memory might be defective. Try a new DIMM, or try installing the DIMM in a different slot.

Note

If you installed a printer language (personality), check the Installed Personalities and Options section on the configuration page. This area should list the new printer language.

Saving resources (permanent resources)

Utilities or jobs that you downloaded to the printer sometimes include resources (for example, fonts, macros, or patterns). Resources that are internally marked as permanent remain in the printer memory until you turn the printer off.

If you do not have an embedded or optional hard disk or flash memory card for storing downloaded resources, you might want to change the amount of memory allocated to each language when downloading an unusually large number of fonts, or if the printer is in a shared environment.

The minimum amount of memory that can be allocated to resource saving is 400 KB each for PCL and PS.

Installing EIO cards/mass storage

Hewlett-Packard constantly introduces new software tools for use with your printer and accessories. These tools are available from the Internet free of charge. (See the HP support flyer or go to www.hp.com/support/lj9050_lj9040.)

Follow this procedure to install an EIO card or mass storage device:

- 1 Turn off the printer and remove the power cord before installing the EIO cards or mass storage device.
- 2 Use the graphic for the location of the EIO cards or optional mass storage device, such as a hard disk.

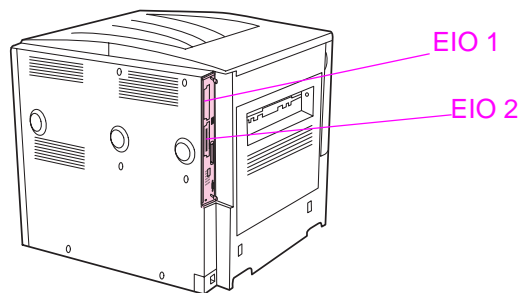

- 3 Use the Device Storage Manager for Web Jetadmin to manage fonts on a mass storage device, or use the LaserJet Utility on a Macintosh.
- 4 After you have installed a new device, print a configuration page by using the following procedure.

To print a configuration page

- 1 Press **✓**.
- 2 Use **▲** or **▼** to scroll to **Information** and press **✓**.
- 3 Use **▲** or **▼** to scroll to **Print Configuration** and press **✓**.

D Regulatory information

Environmental product stewardship program

Protecting the environment

Hewlett-Packard Company is committed to providing quality products in an environmentally sound manner. This product has been designed with several attributes to minimize impacts on our environment.

Ozone production

This product generates no appreciable ozone gas (O₃).

Power consumption

Power usage drops significantly while in Sleep mode, which saves natural resources and saves money without affecting the high performance of this product. This product qualifies for ENERGY STAR® (Version 3.0), which is a voluntary program to encourage the development of energy-efficient office products.



ENERGY STAR® is a U.S. registered mark. As an ENERGY STAR Partner, Hewlett-Packard Company has determined this product meets ENERGY STAR Guidelines for energy efficiency. For more information, see www.energystar.gov.

Toner consumption

Draft mode uses significantly less toner, which might extend the life of the print cartridge.

Paper use

This product's optional automatic duplex feature and N-up printing (multiple pages printed on one page) capability can reduce paper usage and the resulting demands on natural resources.

Plastics

Plastic parts over 25 grams are marked according to international standards that enhance the ability to identify plastics for recycling purposes at the end of the product's life.

HP LaserJet printing supplies

In many countries/regions, this product's print cartridge can be returned to HP through the HP Printing Supplies Returns and Recycling Program. An easy-to-use and free take back program is available in more than 30 countries/regions. Multi-lingual program information and instructions are included in every new HP LaserJet print cartridge and supplies package.

HP printing supplies returns and recycling program information

Since 1992, HP has offered HP LaserJet supplies return and recycling free of charge in 86% of the world market where HP LaserJet supplies are sold. Postage-paid and pre-addressed labels are included within the instruction guide in most HP LaserJet print cartridge boxes. Labels and bulk boxes are also available through the Web site: www.hp.com/recycle.

More than 10 million HP LaserJet print cartridges were recycled globally in 2002 through the HP Planet Partners supplies recycling program. This record number represents 26 million pounds of print cartridge materials diverted from landfills. Worldwide HP recycled an average of 80% of the print cartridge by weight consisting primarily of plastic and metals. Plastics and metals are used to make new products such as HP products, plastic trays and spools. The remaining materials are disposed of in an environmentally responsible manner.

US returns

For a more environmentally responsible return of used cartridges and supplies, HP encourages the use of bulk returns. Simply bundle two or more cartridges together and use the single, pre-paid, pre-addressed UPS label that is supplied in the package. For more information in the U.S., call 800-340-2445 or visit the HP Web site at www.hp.com/recycle.

Non-US returns

Non-US customers should call the local HP Sales and Service Office or visit the www.hp.com/recycle Web site for further information regarding availability of the HP Returns and Recycling program.

Paper

The printer is suited for use of recycled papers when the paper meets the guidelines outlined in the HP LaserJet Printer Family Media Specifications Guide. See www.hp.com/support/lj9050_lj9040 for ordering information. The printer is suited for use of recycled paper according to EN12281:2002.

Material restrictions

This HP product does not contain added mercury.

This HP product contains a lithium battery located on the formatter board that may require special handling at end-of-life.

For recycling information, you can contact www.hp.com/recycle or contact your local authorities or the Electronics Industries Alliance: www.eiae.org.



廢電池請回收

Material safety data sheet

Material Safety Data Sheets (MSDS) can be obtained by contacting the HP Web site at www.hp.com/go/msds or www.hp.com/hpinfo/community/environment/productinfo/safety.

For more information

To obtain information about these environmental topics:

- Product environmental profile sheet for this and many related HP products
- HP's commitment to the environment
- HP's environmental management system
- HP's end-of-life product return and recycling program
- MSDS

Visit: www.hp.com/go/environment or www.hp.com/hpinfo/community/environment/.

E Using accessibility shortcut keys in the Help Viewer

The following topics describe how you can navigate in this user guide.

- [Using F6 to switch between the Navigation and Topic Panes](#)
- [Shortcut keys for the Help Viewer](#)
- [Shortcut keys for the Contents tab](#)
- [Shortcut keys for the Index tab](#)
- [Shortcut keys for the Search tab](#)
- [Shortcut keys for the Favorites tab](#)

Notes

- There are also shortcut menu commands that can be accessed through the keyboard.
- Shortcut keys also work in secondary and pop-up windows.
- Every time you use a shortcut key in the Navigation pane, you lose focus in the Topic pane. To return to the Topic pane, press **F6**.
- The **Match similar words** check box on the **Search** tab will be selected if you used it for your last search.

Using F6 to switch between the Navigation and Topic Panes

You can quickly switch between the Navigation pane and the Topic pane by pressing **F6** on the keyboard.

Shortcut keys for the Help Viewer

To close the Help Viewer.	ALT+F4
To switch between the Help Viewer and other open windows.	ALT+TAB
To display the Options menu.	ALT+O
To change Microsoft Internet Explorer settings. The Internet Options dialog box contains accessibility settings. To change these settings click the General tab, and then click Accessibility .	ALT+O , and then press I
To hide or show the Navigation pane.	ALT+O , and then press T
To print a topic.	ALT+O , and then press P . Or, right-click in the topic and click Print .
To move back to the previous topic.	ALT+LEFT ARROW , or ALT+O , and then press B

To move forward to the next topic (provided you have viewed it just previously).	ALT+RIGHT ARROW , or ALT+O , and then press F
To turn on or off search highlighting.	ALT+O , and then press O
To refresh the topic that appears in the Topic pane (this is useful if you have linked to a Web page).	F5 , or ALT+O , and then press R
To return to the home page (help authors can specify a home page for a help system).	ALT+O , and then press H
To stop the viewer from opening a page (this is also useful if you are linking to the Web and want to stop a page from downloading).	ALT+O , and then press S
To jump to a predetermined topic or Web page. The help author who builds a compiled help (.chm) file can add two links, on the Options menu, to important topics or Web pages. When you select a Jump command you go to one of those topics or Web pages.	ALT+O , and then press 1 or 2
To switch between the Navigation pane and the Topic pane.	F6
To scroll through a topic.	UP ARROW and DOWN ARROW , or PAGE UP and PAGE DOWN
To scroll through all the links in a topic or through all the options on a Navigation pane tab.	TAB

Shortcut keys for the Contents tab

To display the Contents tab.	ALT+C
To open and close a book or folder.	PLUS SIGN (+) and MINUS SIGN (-) , or LEFT ARROW and RIGHT ARROW
To select a topic.	UP ARROW and DOWN ARROW
To display the selected topic.	ENTER

Shortcut keys for the Index tab

To display the Index tab.	ALT+N
To type a keyword to search for.	ALT+W , and then type the word
To select a keyword in the list.	UP ARROW and DOWN ARROW
To display the associated topic.	ALT+D

Shortcut keys for the Search tab

To display the Search tab.	ALT+S
To type a keyword to search for.	ALT+W , and then type the word
To start a search.	ALT+L
To select a topic in the results list.	ALT+T , and then UP ARROW and DOWN ARROW
To display the selected topic.	ALT+D
The following options are only available if full-text search is enabled.	
To search for a keyword in the result list of a prior search.	ALT+U
To search for words similar to the keyword. For example, to find words like "running" and "runs" for the keyword "run."	ALT+M
To only search through topic titles.	ALT+R

Shortcut keys for the Favorites tab

To display the **Favorites** tab.

To add the currently displayed topic to the Favorites list.

To select a topic in the Favorites list.

To display the selected topic.

To remove the selected topic from the list.

ALT+I

ALT+A

ALT+P, and then UP ARROW and DOWN
ARROW

ALT+D

ALT+R

F Using the HTML Help Viewer

The following topics provide information about navigating and using this guide. For more information, click one of the following topics:

- [Getting more out of help](#)
- [To find a help topic](#)
- [To create a list of favorite help topics](#)
- [To copy a help topic](#)
- [To print the current help topic](#)
- [To find topics using the toolbar buttons](#)
- [Using the shortcut menu commands](#)

Getting more out of help

Here are some tips on how to find more information when using the HTML Help Viewer:

- To link to another topic, a Web page, a list of other topics, or a program, click the colored, underlined words.
- To view topics that contain related information, click the words, “Related Topics,” which may appear at the end of a topic, and then click the title of the topic you want.
- To see if a word or phrase contained in a topic is in the index, select the word, and then press **F1**.
- If you are viewing content from the Web in the Topic pane, you can click **Stop** or **Refresh** on the toolbar to interrupt a download or refresh a Web page.
- If you use a particular Help topic often, you can add it to your favorites list.
- Right-click the **Contents** tab or Topic pane for shortcut menu commands.

To find a help topic

In the Navigation pane, click one of the following tabs:

- To browse through a table of contents, click the **Contents** tab. The table of contents is an expandable list of important topics.
- To see a list of index entries, click the **Index** tab, and then type a word or scroll through the list. Topics are often indexed under more than one entry.
- To locate every occurrence of a word or phrase that may be contained in a Help file, click the **Search** tab, and then type the word.

Note

Click the contents entry, index entry, or search results entry to display the corresponding topic.

To create a list of favorite help topics

- 1 Locate the Help topic you want to make a favorite topic.
- 2 Click the **Favorites** tab, and then click **Add**.

Notes

- To return to a favorite topic, click the **Favorites** tab, select the topic, and then click **Display**.
- If you want to rename a topic, select the topic, and then type a new name in the **Current topic** box.
- To remove a favorite topic, select the topic and then click **Remove**.

To copy a help topic

- 1 In the Topic pane, right-click the topic you want to copy, and then click **Select All**.
- 2 Right-click again, and then click **Copy**. This copies the topic to the Clipboard.
- 3 Open the document you want to copy the topic to.
- 4 Position your cursor where you want the information to appear.
- 5 On the **Edit** menu, click **Paste**.

Note

If you want to copy only part of a topic, select the text you want to copy, right-click, and then click **Copy**.

To print the current help topic

Right-click a topic, and then click **Print**.

Note

If you print from the **Contents** tab (by right-clicking an entry, and then clicking **Print**) you will see options to print only the current topic, or the current topic and all subtopics.

To find topics using the toolbar buttons

There are five navigational buttons that can be located on the toolbar in the Help Viewer. You can click these buttons to find help topics:

- **Back** displays the last topic you viewed.
- **Forward** displays the next topic in a previously displayed sequence of topics.
- **Next** displays the next topic listed in the table of contents.
- **Previous** displays the previous topic listed in the table of contents.
- **Home** displays the Home page topic for the help file you are viewing.
- **Refresh** updates Web content that is currently displayed in the Topic pane.
- **Stop** stops downloading file information. Click this button to stop a Web page from downloading.

Note

The toolbar in your Help Viewer may not contain all of these navigational buttons.

Using the shortcut menu commands

There are several commands on the shortcut menu that you can use to display and customize information.

Command	Description
Right-click in the table of contents, and then click Open All .	Opens all books or folders in the table of contents. This command only works if the Contents tab is displayed.
Right-click in the table of contents, and then click Close All .	Closes all books or folders. This command only works if the Contents tab is displayed.
Right-click, and then click Print .	Prints the topic.
Right-click in the table of contents, and then click Customize .	Opens the Customize Information Wizard, which allows you to customize the documentation. If the help file was built with information types, you can use this wizard to select a subset of topics to view. For example, you could choose to see only overview topics.

Note

These commands can be accessed through the keyboard. You can click **SHIFT+F10** to display the shortcut menu, and then click the appropriate shortcut keys. Or, you can enable Mousekeys. Use a Mousekey combination to display the shortcut menu, and then click the appropriate shortcut keys.

Index

Numerics

2,000-sheet tray. *See* Tray 4

3,000-sheet stacker

bins 55

capacity 8

features 60

lights, status 17

locating 14

paper sizes supported 158

part number 11

3,000-sheet stacker/stapler

bins 55

capacity 8

error messages 122

lights, status 17

loading staples 61

locating 14

not recognized 138

paper sizes supported 158

part number 11

printing to 60

staple jams, clearing 110

staple jams, frequent 136

stapling, troubleshooting 137

8-bin mailbox

bins, types of 56

capacity 9

features 68

jams, clearing 116

lights, status 17

locating 14

paper sizes supported 159

part number 11

A

A4 paper

override settings 169

Wide A4 settings 170

accessories, part numbers 10

acoustical specifications 164

action not currently available error message 119

adding paper 36

address, IP 142, 173

adhesive labels

fuser mode 171

loading 53

printing 36, 70

specifications 161

alerts page, embedded Web server 143

alerts, setting up 32, 95

alignment

tray registration 75, 171

troubleshooting 131

allocating memory 189

Alternate Letterhead mode 53

anticounterfeit Web site 93

Appletalk settings 177

Attention light 16

authentication, print cartridges 93

auto continue, settings 174

auto setup, troubleshooting 134

autoconfiguration, driver 18

B

back page, settings 77

background, gray 129, 160

bad connection error messages 119

base memory 7

battery information 192

bidirectional communication settings 175

binding edge, settings 169

bins, output

8-bin mailbox 56

capacities 8

full, error messages 119

jam locations 98

jams, clearing 105

locating 14, 55

multifunction finisher 56

paper path test, printing 152

paper sizes supported 157

selecting 56, 169

stacker 55

stacker/stapler 55

troubleshooting 138

black dots, troubleshooting 95, 129

blank pages

adding 77

suppressing 171

troubleshooting 134

bleeds, printing 71

blinking lights

control panel 16

paper-handling devices 17

booklets, creating 66

both sides, printing on

loading paper 49

printing 68

settings 169

troubleshooting 135, 137

browsers, HP Toolbox requirements 31

buffers

data remaining in, troubleshooting 135

overflow, error messages 124, 126

bulk returns, recycling 192

buttons, control-panel 15

C

capacities, trays and bins 8, 157

cardstock

fuser mode 171

printing 71

specifications 162

carriage returns, settings 171

- cartridges, print
 - authentication 93
 - error messages 119, 121, 122
 - features 8
 - low 174
 - non-HP 93, 121
 - ordering 94
 - out, settings 174
 - part numbers 11, 154
 - recycling 192
 - removing 90
 - replacing 95
 - status, viewing in HP Toolbox 32
 - storing 93
 - supplies status page 147
 - toner level, checking 93
 - usage information 148
 - cartridges, staple
 - error messages 122
 - part numbers 11
 - characters
 - dropouts, troubleshooting 129
 - misformed, troubleshooting 130
 - Chooser, Macintosh 141
 - cleaning page, printing 95
 - cleaning the printer 90
 - clearable warnings, settings 174
 - clipped margins, troubleshooting 134
 - clock, setting 173
 - clothing, toner on 90
 - collation features 74
 - complex pages, troubleshooting 123
 - configuration page
 - information on 146
 - Jetdirect 29
 - printing 144, 166
 - viewing from embedded Web server 142
 - Configure device menu 168
 - configure printer page, embedded Web server 143
 - connectivity options 9
 - consumables. *See* supplies
 - contact information page, embedded Web server 143
 - Contents tab shortcut keys 196
 - control panel
 - blank, troubleshooting 133
 - buttons 15
 - Configure device menu 168
 - Diagnostics menu 180
 - EIO menu 175
 - help system 118
 - I/O menu 175
 - Information menu 166
 - language, selecting 133, 174
 - lights 16
 - locked menus 16
 - menu map, printing 145, 166
 - menus 165
 - messages 118
 - Paper handling menu 167
 - Parallel input submenu 175
 - PCL menu 170
 - Print quality menu 171
 - Printing submenu 168
 - Resets 179
 - Retrieve job menu 166
 - Service menu 180
 - settings, changing 16
 - settings, overriding 74
 - System setup submenu 173
 - copies, number of 168
 - count, printer maintenance 92
 - counts, page 146, 151
 - Courier font settings 170
 - covers, booklet 66
 - creases, troubleshooting 131
 - crop marks, printing 71
 - curl, troubleshooting 131, 161
 - Current Page Count 151
 - custom-size paper
 - loading 45, 50, 51
 - printing 71
 - sizes supported 157
 - tray settings 169
 - cut-off pages, troubleshooting 136
- D**
- dark setting, toner density 172
 - Data light 16, 139
 - data transmission settings 175
 - data, missing 135
 - date, setting 173
 - DC controller error messages 125
 - default settings
 - driver, changing 21
 - number of copies 168
 - paper type 169
 - restoring 179
 - saving 74
 - defect tables, image quality 128
 - deleting jobs
 - private 81
 - proof and hold 84
 - QuickCopy 83
 - stored 82
 - density settings 172
 - device identification page, embedded Web server 142, 143
 - device pages, embedded Web server 143
 - Device Status, viewing in HP Toolbox 32
 - diagnostic pages, embedded Web server 143
 - Diagnostics menu 180
 - different first page 76
 - different paper size error message 120
 - DIMMs
 - error messages 125
 - installing 183
 - part numbers 12
 - slots 181, 182
 - verifying installation 188
 - directory, file 144, 166
 - disk
 - erase, security feature 86
 - error messages 120
 - features 9
 - file directory, printing 144, 166
 - information page 149
 - installing 189
 - job retention 80, 173
 - not recognized 138
 - part number 12
 - DLC/LLC settings 177
 - doors
 - jam locations 98
 - left, clearing jams 105
 - locating 14
 - right, clearing jams 99
 - dots per inch (dpi) settings 172
 - dots, troubleshooting 95, 129

- double-sided printing
 - loading paper 49
 - printing 68
 - settings 169
 - troubleshooting 135, 137
 - downloading firmware 9
 - dpi (dots per inch) settings 172
 - draft printing 172
 - Driver Work Space (DWS) 146
 - drivers
 - autoconfiguration 18
 - features 20
 - help 20
 - included 19
 - preconfiguration 19
 - saving settings 74
 - settings 21
 - settings, overriding 74
 - troubleshooting 135
 - troubleshooting Macintosh 141
 - Update Now button 19
 - dropouts, troubleshooting 129
 - duplex printing accessory
 - bad connection error message 119
 - features 8
 - jam locations 98
 - jams, clearing 103
 - locating 14
 - not recognized 138
 - paper sizes supported 158
 - part number 10
 - reinsert error message 122
 - remove error message 120
 - troubleshooting 135
 - duplexing
 - layout options 69
 - loading paper 49
 - printing 68
 - settings 169
 - troubleshooting 135, 137
 - duty cycle 7
 - DWS (Driver Work Space) 146
- E**
- Economode 172
 - edges not printing, troubleshooting 134
 - edge-to-edge printing 71, 75, 169
 - EIO cards
 - buffer overflow, error messages 124
 - error messages 127
 - installing 189
 - part numbers 13
 - slots 14
 - supported 9
 - EIO disk
 - erase, security feature 86
 - error messages 120
 - features 9
 - file directory, printing 144, 166
 - information page 149
 - job retention 80, 173
 - not recognized 138
 - part number 12
 - EIO menu 175
 - electrical specifications 163
 - Electronic Industries Alliance 192
 - e-mail page, embedded Web server 143
 - e-mail, receiving alerts 95
 - embedded print server 29
 - embedded Web server
 - accessing 30
 - features 28
 - pages 142
 - energy specifications 163
 - Energy Star compliance 191
 - envelopes
 - default image size, setting 168
 - loading 53, 57
 - margins 59, 156
 - printing 36, 57
 - sizes supported 157
 - specifications 161
 - storing 162
 - wrinkles, troubleshooting 132
 - environmental protection information 191
 - environmental specifications 164
 - EPS files, troubleshooting 136
 - equivalence table, paper 153
 - erasing disk 86
 - error messages
 - alphabetical list 119
 - control panel lights 16
 - numerical list 123
 - settings 174
 - troubleshooting 118
 - Ethernet cards supported 9
 - event log
 - embedded Web server page 142
 - information on 146, 151
 - printing 151
 - viewing 180
 - expansion slots
 - DIMMs 181, 182
 - EIO 9
 - Installed Personalities and Options 146
- F**
- face-down bin. *See* standard top bin
 - face-up bin. *See* bins, output
 - factory default settings, restoring 179
 - faded print, troubleshooting 129
 - FastRes 7, 172
 - Favorites tab
 - adding help topics 200
 - shortcut keys 197
 - features
 - drivers 20
 - job retention 80
 - printer 7
 - software 18
 - feeding modes, trays 78, 79
 - file directory, printing 144, 166
 - finding help topics 199, 200
 - finisher, multifunction. *See* multifunction finisher
 - firmware
 - error messages 124
 - upgrading 9
 - first page
 - different paper for 76
 - speed, specifications 7
 - speed, troubleshooting 136
 - flash memory
 - DIMMs, part numbers 12
 - DIMMs, upgrading 181
 - installing 185
 - slots 182
 - flashing lights
 - control panel 16
 - paper-handling devices 17

- folding booklets 66
- font DIMMs, part numbers 12
- fonts
 - Courier settings 170
 - EPS files, troubleshooting 136
 - included 8
 - lists, printing 144, 149, 166
 - PCL settings 170
 - storing on hard disk 9
 - troubleshooting 134, 140
- form lines, settings 170
- fraud Web site 93
- front door
 - jam locations 98
 - locating 14
- front-to-back registration 75
- full-bleed images, printing 71
- fuser area, clearing jams 105
- fuser error messages 125
- fuser levers, setting 58, 59
- fuser modes 171

G

- garbled pages, troubleshooting 136
- glossy paper, HP 154
- gray background, troubleshooting 129, 160
- guidelines, paper 156, 160

H

- hard disk
 - erase, security feature 86
 - error messages 120
 - features 9
 - file directory, printing 144, 166
 - information page 149
 - installing 189
 - job retention 80, 173
 - not recognized 138
 - part number 12
- heavy paper
 - fuser mode 171
 - printing 71
 - specifications 162
- help
 - control panel 118
 - copying topics 200
 - drivers 20
 - favorite topics 200
 - finding topics 199, 200
 - key, control-panel 15
 - printing topics 200
 - shortcuts 195, 201
 - using Help Viewer 199
- Help Viewer
 - shortcut keys 195
 - using 199
- home pages, embedded Web server 142
- HP Driver Preconfiguration 19
- HP FastRes 7
- HP fraud Web site 93
- HP Jetdirect print servers
 - EIO menu 175
 - error messages 127
 - information page 150
 - part numbers 13
 - troubleshooting 29
- HP LaserJet Monochrome Transparencies 154
- HP LaserJet Paper 155
- HP LaserJet Soft Gloss Paper 154
- HP LaserJet Utility 23
- HP MultiPurpose Paper 155
- HP Office Paper 155
- HP Office Recycled Paper 155
- HP OpenVMS drivers 20
- HP Premium Choice LaserJet Paper 154
- HP Printing Paper 155
- HP Printing Supplies Returns and Recycling Program 192
- HP Toolbox
 - alerts, setting up 96
 - features 28, 31
 - toner level, checking from 94
- HP Web Jetadmin
 - alerts, configuring 95
 - features 27
 - firmware upgrades 9
 - toner level, checking from 94
- HTTPS settings 177
- humidity, operating environment 164

I

- I/O buffer overflow, error messages 124
- I/O menu 175
- IBM OS/2 support 20
- image quality
 - cleaning page, printing 95
 - defect tables 128
 - settings 171
- image size, setting default 168
- Index tab shortcut keys 196
- Information menu 166
- information pages
 - configuration 146
 - event log 151
 - font lists 149
 - JetDirect 150
 - menu map 145
 - printing 144, 166
 - supplies status 147
 - usage 148
 - viewing from embedded Web server 142
- ink cartridges. *See* print cartridges
- input trays
 - action not currently available error message 119
 - behavior settings 173
 - capacities 8, 157
 - error messages 121
 - included 8
 - jam locations 98
 - jams, clearing 99
 - loading 36
 - locating 14
 - orientation, paper 49
 - paper path test 152
 - paper sizes, supported 157
 - part numbers 10
 - registration 75, 171
 - selecting 79
 - settings, viewing 146
 - size error messages 124
 - troubleshooting 134, 139
- Installed Personalities and Options 146
- installing
 - EIO cards 189
 - flash memory cards 185
 - Macintosh software 25
 - memory 182
 - network software 24
 - Windows software 23
- insufficient memory 123
- interface problems, troubleshooting 139

IP address 142, 173
IPX/SPX settings 177

J

jams

- 8-bin mailbox 116
- clearing 98
- duplex printing accessory 103
- error messages 123
- frequent, troubleshooting 117
- left door 105
- locations 98
- multifunction finisher 107
- preventing 36
- recovery settings 174
- right door 99
- standard output bin 105
- staple, frequent 136
- staple, multifunction finisher 112
- staple, stacker/stapler 110
- Tray 1 99
- Tray 2 or 3 100
- Tray 4 101

Jetadmin, HP Web

- alerts, configuring 95
- features 27
- firmware upgrades 9
- toner level, checking from 94

Jetdirect print servers

- EIO menu 175
- error messages 127
- information page 150
- part numbers 13
- troubleshooting 29

job retention

- error messages 123
- features, accessing 80
- job storage limit, setting 173
- private jobs 80
- proof and hold 83
- QuickCopy 82
- Retrieve job menu 166
- Security Disk Erase 86
- stored jobs 81
- timeout settings 173

jobs, canceling 16

K

keys, control-panel 15

L

labels

- fuser mode 171
- loading 53
- printing 36, 70
- specifications 161

landscape orientation

- setting as default 170
- two-sided printing 69

language page, embedded Web server 143

language, control panel 133, 174

languages, printer

- automatic switching 20
- default, setting 174
- error messages 119
- included 8
- list of installed, printing 146

LaserJet Monochrome Transparencies 154

LaserJet Paper, HP 155

LaserJet Paper, HP Premium Choice 154

LaserJet Soft Gloss Paper 154

LaserJet Utility 23

last page, not printing 137

LEDs

- control-panel 16
- paper-handling devices 17

left door

- clearing jams 105
- jam locations 98
- locating 14

left output bin

- locating 55
- paper sizes supported 158

letterhead

- Alternate Letterhead mode 53
- fuser mode 171
- printing on 70

light print

- setting, toner density 172
- troubleshooting 129

lights

- control-panel 16
- paper-handling devices 17

line feed settings 171

line spacing settings 170

lines, troubleshooting 129

links, embedded Web server 143

Linux support 18

loading

- envelopes 53, 57
- labels 53
- letterhead 53
- orienting paper 49
- standard-size paper 39, 42
- staples in multifunction finisher 64
- staples in stacker/stapler 61
- transparencies 53
- Tray 1 36

LocalTalk support 9

lock, security 87

locked menus, control panel 16

long edge binding, settings 169

loose toner, troubleshooting 130

low print cartridges, settings 174

M

Macintosh

- Appletalk settings 177

- Chooser, troubleshooting 141

- communications, troubleshooting 141

- driver settings 21

- drivers included 19

- HP LaserJet Utility 23

- installing software 25

- operating systems supported 18

- PPDs and PDEs 22

- uninstalling software 26

mailbox

- bins, types of 56

- capacity 9

- features 68

- jams, clearing 116

- lights, status 17

- locating 14

- paper sizes supported 159

- part number 11

- maintenance kit
 - ordering 122
 - part numbers 13
 - replacing 92
 - status 147
- manual feed
 - control panel settings 169
 - first page 76
 - messages, troubleshooting 138
 - selecting 78
 - troubleshooting 134
- manufacturing page 151
- map, menu 144, 145, 166
- margins
 - clipped, troubleshooting 134
 - envelopes 59, 156
 - settings 171
- mass storage devices
 - installing 189
 - management tools 9
- mass storage devices. *See also* hard disk
- Material Safety Data Sheet (MSDS) 193
- media
 - cardstock specifications 162
 - curl, troubleshooting 131
 - custom-size, loading 45
 - default image size, setting 168
 - first page, different 76
 - fuser modes 171
 - HP 154
 - labels 70
 - letterhead 53
 - loading 36
 - orientation 49
 - prepunched, loading 52
 - recycled 155
 - sizes, supported 157
 - small, mode for 172
 - special 70
 - specifications 156, 160
 - standard-size, loading 39, 42
 - tray selection 79
 - troubleshooting 160
 - type, setting default 169
 - types supported 160
 - weight equivalence table 153
- media jams. *See* paper jams
- memory
 - allocation 189
 - base 7
 - configuration page, printing 146
 - DIMM error messages 125
 - flash cards, installing 185
 - installing 182
 - insufficient 123
 - job retention features 80
 - NVRAM errors 126
 - part numbers 12
 - requirements, determining 181, 182
 - verifying installation 188
- Menu button 15
- menu map, printing 144, 145, 166
- menus, control panel
 - Configure device 168
 - Diagnostics 180
 - EIO 175
 - I/O 175
 - Information 166
 - locked 16
 - map, printing 145, 166
 - navigating 16
 - Paper handling 167
 - Parallel input 175
 - PCL 170
 - Print quality 171
 - Printing 168
 - Resets 179
 - Retrieve job 166
 - Service 180
 - System setup 173
 - using 165
- mercury statement 192
- messages
 - alphabetical list 119
 - control panel lights 16
 - numerical list 123
 - settings 174
 - troubleshooting 118
- microprocessor speed 7
- misalignment, troubleshooting 131
- misformed characters, troubleshooting 130
- missing data, troubleshooting 135
- modes
 - Alternate Letterhead 53
 - fuser 171
 - Sleep 173
 - Tray 1 78
 - trays 79
- mopying (multiple original prints) 74
- Mousekeys feature 201
- MSDS (Material Safety Data Sheet) 193
- multifunction finisher
 - bins, output 56
 - booklets, creating 66
 - capacity 8
 - different paper size error message 120
 - error messages 122
 - features 63
 - lights, status 17
 - locating 14
 - paper jams, clearing 107
 - paper sizes supported 159
 - part number 11
 - staple jams, clearing 112
 - staple jams, frequent 136
 - stapler, using 63
 - staples, loading 64
 - stapling, troubleshooting 137
- multiple original prints (mopying) 74
- multiple pages per sheet 77
- MultiPurpose Paper, HP 155
- multipurpose tray. *See* Tray 1

N

- naming printer 142
- narrow media settings 172
- networking pages, embedded Web server 143

- networks
 - HP Jetdirect print servers 29
 - installing software 24
 - operating systems supported 18
 - settings page, embedded Web server 143
 - software for 27
 - speed settings 179
 - troubleshooting 137
- No back page 77
- noise specifications 164
- non-HP media 156
- non-HP print cartridges 93, 121
- nonvolatile memory errors 126
- notification settings, embedded Web server 143
- number of copies 168
- n-up printing 77
- NVRAM errors 126

O

- Office Paper, HP 155
- Office Recycled Paper, HP 155
- online help. *See* help
- OpenVMS drivers 20
- operating environment specifications 164
- operating systems supported 18
- order supplies page, embedded Web server 143
- ordering
 - parts and accessories 10
 - print cartridges 94
 - through embedded Web server 143
- orientation
 - default 170
 - loading media 49
 - two-sided printing 69
- OS/2 support 20
- other links page, embedded Web server 143
- output bins
 - 8-bin mailbox 56
 - capacities 8
 - full, error messages 119
 - jam locations 98
 - jams, clearing 105
 - locating 14, 55
 - multifunction finisher 56
 - paper path test, printing 152
 - paper sizes supported 157
 - selecting 56, 169
 - stacker 55
 - stacker/stapler 55
 - troubleshooting 138
- output quality
 - cleaning page, printing 95
 - settings 171
 - troubleshooting 128
- overhead transparencies
 - HP LaserJet 154
 - loading 53
 - printing 71
 - specifications 161
- overprints, troubleshooting 136
- override A4/letter 169
- overriding settings 74
- ozone statement 191

P

- page counts 151
- page counts, viewing 146
- page orientation
 - default 170
 - loading media 49
 - two-sided printing 69
- page skew, troubleshooting 131
- pages not printing
 - all 134
 - last 137
 - partial 136, 139
 - stops mid-job 140
- pages per minute 7, 164
- Pages Per Sheet 77
- paper
 - curl, troubleshooting 131
 - custom-size, loading 45
 - default image size, setting 168
 - first page, different 76
 - fuser modes 171
 - letterhead 53
 - loading 36
 - orientation 49
 - prepunched, loading 52
 - recycled 155
 - sizes, supported 157
 - small, mode for 172
 - specifications 156, 160
 - standard-size, loading 39, 42
 - tray selection 79
 - troubleshooting 160
 - type, setting default 169
 - types supported 160
 - weight equivalence table 153
- Paper handling menu 167
- paper input trays. *See* trays
- paper jams
 - 8-bin mailbox 116
 - clearing 98
 - duplex printing accessory 103
 - error messages 123
 - frequent, troubleshooting 117
 - left door 105
 - locations 98
 - multifunction finisher 107
 - preventing 36
 - recovery settings 174
 - right door 99
 - standard output bin 105
 - Tray 1 99
 - Tray 2 or 3 100
 - Tray 4 101
- paper path test, printing 152
- paper-handling status LEDs 17
- parallel connections, error messages 124
- Parallel input submenu 175
- part numbers 10
- part numbers, supplies 154
- partial pages, troubleshooting 136
- path test, printing 152
- paused printing 139
- pausing the printer 16
- PCL drivers 19, 20
- PCL font list, printing 144, 149, 166
- PCL menu 170
- PDEs, Macintosh 22
- PDF error page 170
- permanent resources 189

- personalities
 - automatic switching 20
 - default, setting 174
 - error messages 119
 - included 8
 - list of installed, printing 146
- PINs
 - control panel menus 165
 - error messages 120
 - releasing private jobs 80
 - Service menu 180
- plastics, recycling 192
- platforms supported 18
- portrait orientation
 - setting as default 170
 - two-sided printing 69
- ports
 - parallel, error messages 124
 - troubleshooting 139, 140
- postcards
 - printing 71
 - specifications 162
- PostScript emulation drivers 19, 20
- PostScript error pages 134, 170
- PostScript font list, printing 149, 166
- PostScript jobs, troubleshooting 140
- PostScript Printer Description Files (PPDs), Macintosh 22
- power cord, locating 14
- power specifications 163
- PPDs, Macintosh 22
- preconfiguration, driver 19
- Premium Choice LaserJet Paper 154
- preprinted paper
 - fuser mode 171
 - printing on 70
- prepunched paper
 - fuser mode 171
 - loading 52
 - printing 70
- print cartridges
 - authentication 93
 - error messages 119, 121, 122
 - features 8
 - low 174
 - non-HP 93, 121
 - ordering 94
 - out, settings 174
 - part numbers 11, 154
 - recycling 192
 - removing 90
 - replacing 95
 - status, viewing in HP Toolbox 32
 - storing 93
 - supplies status page 147
 - toner level, checking 93
 - usage information 148
- print jobs, canceling 16
- print jobs, resuming 16
- print quality
 - cleaning page, printing 95
 - settings 171
 - troubleshooting 128
- Print quality menu 171
- print servers
 - EIO menu 175
 - error messages 127
 - Jetdirect page 150
 - part numbers 13
 - troubleshooting 29
- Printer Dialog Extension (PDEs), Macintosh 22
- printer drivers
 - autoconfiguration 18
 - features 20
 - help 20
 - included 19
 - preconfiguration 19
 - saving settings 74
 - settings 21
 - settings, overriding 74
 - troubleshooting 135
 - troubleshooting Macintosh 141
 - Update Now button 19
- printer languages
 - automatic switching 20
 - default, setting 174
 - error messages 119
 - included 8
 - list of installed, printing 146
- printer maintenance kit
 - ordering 122
 - part numbers 13
 - replacing 92
 - status 147
- printer status page, embedded Web server 142
- printing
 - basic instructions 54
 - private jobs 81
 - proof and hold jobs 84
 - QuickCopy jobs 83
 - stored jobs 82
 - troubleshooting 134
- Printing Paper, HP 155
- Printing submenu 168
- private jobs
 - control panel settings 166
 - deleting 81
 - options 80
 - printing 80
 - Security Disk Erase 86
 - timeout settings 173
- processor speed 7
- proof and hold jobs
 - control panel settings 166
 - creating 83
 - deleting 84
 - options 80
 - printing 84
 - Security Disk Erase 86
 - timeout settings 173
- protocol settings 176
- PS drivers 19, 20
- PS error pages 134, 170
- PS font list, printing 144, 149, 166
- PS jobs, troubleshooting 140

Q

- quality
 - cleaning page, printing 95
 - settings 171
 - troubleshooting 128
- quick sets 74
- QuickCopy jobs
 - control panel settings 166
 - creating 82
 - deleting 83
 - options 80
 - printing 83
 - Security Disk Erase 86
 - timeout settings 173

R

- RAM. *See* memory
- Ready light 16
- recovery, jam 174
- recycled paper 155
- recycling supplies 192
- refilling paper 36
- refilling staples
 - 3,000-sheet stacker/stapler 61
 - multifunction finisher 64
- refresh rate page, embedded Web server 143
- registration, tray 75, 171
- releasing jobs
 - private 81
 - proof and hold 84
 - stored 82
- removing software 26
- repeating defects, troubleshooting 130
- replacing
 - print cartridges 95
 - printer maintenance kit 92
- reports
 - configuration page 146
 - event log 151
 - font lists 149
 - JetDirect page 150
 - menu map 145
 - printing 144, 166
 - supplies status page 147
 - usage page 148
 - viewing from embedded Web server 142
- Resets menu 179
- resetting printer maintenance count 92
- resolution 7
- Resolution Enhancement technology (REt) 7, 172
- resolution settings 172
- resource saving 189
- restoring default settings 179
- resuming printing 16
- REt (Resolution Enhancement technology) 7, 172
- Retrieve job menu 166
- review copies, printing 83
- right door
 - clearing jams 99
 - jam locations 98
 - locating 14
- RIP ONCE technology 9
- RIP Once technology 7
- rollers, included in maintenance kit 13

S

- saddle stitching 66
- saving settings 74
- scan buffer errors 126
- Search tab shortcut keys 196
- security
 - embedded Web server settings 143
 - lock 87
 - settings 179
 - status, configuration page 146
 - Web sites, settings 177
- Security Disk Erase 86
- serial number
 - cartridges 147
 - disk accessory 149
 - printer 146
- Service menu 180
- Set Registration 75, 171

- settings
 - configuration page 146
 - control panel, changing 16
 - driver 21
 - image quality 171
 - overriding 74
 - restoring defaults 179
 - saving 74
- shared printers, troubleshooting 137
- sharing, Windows 24
- short edge binding, settings 169
- shortcuts, help 195, 201
- sizes, paper
 - error messages 124
 - selecting trays by 79
 - supported 157
- skewed pages, troubleshooting 131
- Sleep mode
 - Energy Star compliance 191
 - power consumption 163
 - settings 173
- slots
 - DIMM 181, 182
 - EIO 9
 - Installed Personalities and Options 146
 - locating 14
- slow printing, troubleshooting 136, 139
- small paper mode 172
- smear toner, troubleshooting 130
- Soft Gloss Paper 154
- software
 - CD-ROM, contents 18
 - features 18
 - installing on Macintosh 25
 - installing on Windows 23
 - Macintosh 22
 - network 27
 - settings, overriding 74
 - troubleshooting 135
 - uninstalling 26
- special media, printing on 36, 70
- specifications
 - acoustical 164
 - card stock 162
 - envelopes 161
 - environmental 164
 - labels 161
 - paper 156, 160
 - power 163
 - transparencies 161
- specks, troubleshooting 95, 129
- speed
 - data transmission settings 175
 - network settings 179
 - pages per minute 7
 - print 164
 - processor 7
 - resolution settings 172
 - troubleshooting 136, 139
- stacker
 - bins 55
 - capacity 8
 - features 60
 - lights, status 17
 - locating 14
 - paper sizes supported 158
 - part number 11
 - selecting output location 56

- stacker/stapler
 - bins 55
 - capacity 8
 - error messages 122
 - lights, status 17
 - loading staples 61
 - locating 14
 - not recognized 138
 - paper sizes supported 158
 - part number 11
 - printing to 60
 - selecting output location 56
 - staple jams, clearing 110
 - staple jams, frequent 136
 - stapling, troubleshooting 137
 - standard top bin
 - features 55
 - jam locations 98
 - jams, clearing 105
 - locating 14
 - paper sizes supported 157
 - staple cartridges
 - error messages 122
 - loading in multifunction finisher 64
 - loading in stacker/stapler 61
 - part numbers 11
 - staple jams
 - frequent, troubleshooting 136
 - multifunction finisher, clearing 112
 - stacker/stapler, clearing 110
 - stapling documents
 - troubleshooting 137
 - using the 3,000-sheet stacker/stapler 60
 - using the multifunction finisher 63
 - status messages
 - alphabetical list 119
 - control panel lights 16
 - numerical list 123
 - settings 174
 - troubleshooting 118
 - status page, embedded Web server 142
 - Status tab, HP Toolbox 32
 - status, supplies
 - information page 147
 - page, printing 144, 166
 - viewing in embedded Web server 142
 - viewing in HP Toolbox 32
 - Stop button 16
 - stopped printing, troubleshooting 140
 - storage devices
 - installing 189
 - management tools 9
 - storage devices. *See* hard disk
 - stored jobs
 - control panel settings 166
 - creating 81
 - deleting 82
 - error messages 123
 - options 80
 - printing 82
 - Security Disk Erase 86
 - timeout settings 173
 - storing
 - envelopes 162
 - print cartridges 93
 - printer 164
 - supplies
 - error messages 123
 - ordering 143
 - part numbers 154
 - recycling 192
 - status, viewing in embedded Web server 142
 - status, viewing in HP Toolbox 32
 - supplies status page
 - information on 147
 - printing 144, 166
 - symbol sets 170
 - System setup submenu 173
- T**
- TCP/IP settings 176, 178
 - temperature, operating environment 164
 - temporary printing errors 125
 - test, paper path 152
 - text, troubleshooting
 - dropouts 129
 - misformed 130
 - time, setting 173
 - timeout settings
 - held jobs 173
 - I/O 175
 - Sleep mode 173
 - toner
 - adhesion problems 160
 - density settings 172
 - level, checking 93
 - loose, troubleshooting 130
 - smear, troubleshooting 130
 - specks, troubleshooting 95, 129
 - usage information 148
 - washing off clothing 90
 - toner cartridges. *See* print cartridges
 - Toolbox, HP
 - alerts, setting up 96
 - features 28, 31
 - toner level, checking from 94
 - transparencies
 - fuser mode 171
 - HP LaserJet 154
 - loading 53
 - printing 71
 - specifications 161
 - Tray 1
 - bad connection, error message 119
 - capacity 8
 - custom-size paper specifications 71
 - envelopes, loading 53, 57
 - error messages 121
 - feeding modes, setting 78
 - first page, different paper for 76
 - fuser levers, setting 58, 59
 - jam locations 98
 - jams, clearing 99
 - labels, loading 53
 - loading 36
 - loading paper 49
 - locating 14
 - manual feed messages, troubleshooting 138
 - manual feed mode 78
 - paper sizes supported 157
 - part number 10
 - registration 75

- Tray 2
 - capacity 8
 - custom-size paper specifications 71
 - jam locations 98
 - jams, clearing 100
 - loading custom-size paper 45
 - loading paper, orientation 50
 - loading standard-size paper 39, 42
 - locating 14
 - paper sizes supported 157
 - registration 75
 - settings 167
 - troubleshooting 134
- Tray 3
 - capacity 8
 - custom-size paper specifications 71
 - jam locations 98
 - jams, clearing 100
 - loading custom-size paper 45
 - loading paper, orientation 50
 - loading standard-size paper 39, 42
 - locating 14
 - paper sizes supported 157
 - registration 75
 - settings 167
 - troubleshooting 134
- Tray 4
 - capacity 8
 - custom-size paper specifications 71
 - jam locations 98
 - jams, clearing 101
 - lights, status 17
 - loading custom-size paper 45
 - loading paper, orientation 50
 - loading standard-size paper 39, 42
 - locating 14
 - not recognized 138
 - paper sizes supported 157
 - part number 10
 - power, troubleshooting 138
 - registration 75
 - settings 167
 - troubleshooting 134
- trays
 - action not currently available error message 119
 - behavior settings 173
 - capacities 8, 157
 - error messages 121
 - features 8
 - included 8
 - jam locations 98
 - jams, clearing 99
 - loading 36
 - locating 14
 - orientation, paper 49
 - paper path test 152
 - paper sizes, supported 157
 - part numbers 10
 - registration 75, 171
 - registration/calibration 75
 - selecting 79
 - settings, viewing 146
 - size error messages 124
 - troubleshooting 134, 139

- troubleshooting
 - checklist 133
 - control panel 133
 - control-panel messages 118
 - curled pages 131
 - faded print 129
 - fonts 134, 140
 - gray background 129
 - HP Jetdirect printer servers 29
 - jams, clearing 98
 - jams, frequent 117
 - lights, control-panel 16
 - lights, paper-handling devices 17
 - lines 129
 - Macintosh 141
 - manual feed 134, 138
 - missing data 135
 - networks 137
 - pages not printing 134
 - paper 160
 - paper path test 152
 - partial pages 136
 - paused printing 139
 - ports 139, 140
 - printer, sending to 136
 - PS print jobs 140
 - quality 128
 - repeating defects 130
 - skew 131
 - software 135
 - specks 129
 - speed 139
 - staple jams, clearing 110
 - staple jams, frequent 136
 - stapling 137
 - stopped printing 140
 - toner smear 130
 - trays 134
- TrueType fonts, included 8
- two-sided printing
 - layout options 69
 - loading paper 49
 - printing 68
 - settings 169
 - troubleshooting 135, 137
- typefaces. *See* fonts
- types, paper 160
 - default, setting 169
 - fuser modes 171
 - selecting trays by 79
 - tray settings 167

U

- uninstalling software 26
- UNIX
 - carriage return settings 171
 - HP Jetdirect Printer Installer utility 27
 - support 18
- Update Now button 19
- upgrading
 - EIO cards supported 9
 - firmware 9
 - memory 181, 182
- upper output bin, locating 14
- usage page
 - embedded Web server 142
 - information on 148
 - printing 144, 166
- USB support 9

V

- vertical line spacing settings 170
- vertical transfer door
 - jam locations 98
 - locating 14
- voltage, troubleshooting 133

W

- washing off toner 90
- watermarks, printing 74
- wave, troubleshooting 131
- Web Jetadmin
 - alerts, configuring 95
 - features 27
 - firmware upgrades 9
 - toner level, checking from 94
- Web sites
 - anticounterfeit 93
 - Electronic Industries Alliance 192
 - environmental information 193
 - firmware upgrades 9
 - Material Safety Data Sheet (MSDS) 193
 - paper specifications 156
 - recycling information 192
 - security settings 177
 - Windows software 9
- weight, paper
 - equivalence table 153
 - heavy 162
 - supported 157
- Wide A4 setting 170
- Windows
 - driver settings 21
 - drivers included 19
 - installing software 23
 - networks, installing software 24
 - operating systems supported 18
 - uninstalling software 26
- wrinkles, troubleshooting
 - envelopes 132
 - pages 131, 161
- wrong side, pages printing on 137

© 2005 Hewlett-Packard Development Company, L.P.

www.hp.com



Q3721-90940