

III·PRO

Basic Information

Network Camera

Model No. **WV-S8574L, WV-S8573L**
WV-S8564L, WV-S8563L
WV-S8544L, WV-S8543L
WV-S8544, WV-S8543

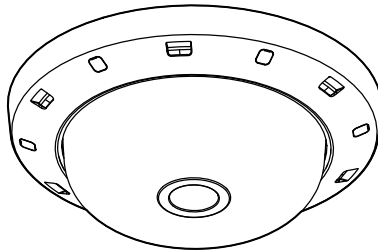

WV-S8574L

About the user manuals

Product documentation is composed of the following documents.

- **Installation Guide (accessory):** Provides information about “Precautions”, “Precautions for installation” and the installation method.
- **Basic Information (this document):** Provides information about “Precautions for use”, “Parts and functions” and “Detail specifications”.
- **Operating Instructions (Refer to the link on the following support website):** Explains how to perform the settings and how to operate this camera.
<https://i-pro.com/global/en/surveillance/training-support/documentation-database-list>

“<Control No.: C****>” used in these documents should be used to search for information on our technical information website

(<https://i-pro.com/global/en/surveillance/training-support/support/technical-information>) and will guide you to the right information.

- microSDXC/ microSDHC/ microSD memory card is described as microSD memory card.
- The external appearance and other parts shown in this manual may differ from the actual product within the scope that will not interfere with normal use due to improvement of the product.



Contents

Limitation of liability.....	3
Disclaimer of warranty.....	3
About notations.....	4
System requirements for a PC.....	4
Network security.....	5
Precautions for use.....	6
Parts and functions.....	9
Insert / remove a microSD memory card.....	14
Troubleshooting.....	16
Detail specifications.....	18

Limitation of liability

THIS PUBLICATION IS PROVIDED "AS IS" WITHOUT WARRANTY OF ANY KIND, EITHER EXPRESS OR IMPLIED, INCLUDING BUT NOT LIMITED TO, THE IMPLIED WARRANTIES OF MERCHANTABILITY, FITNESS FOR ANY PARTICULAR PURPOSE, OR NON-INFRINGEMENT OF THE THIRD PARTY'S RIGHT.

THIS PUBLICATION COULD INCLUDE TECHNICAL INACCURACIES OR TYPOGRAPHICAL ERRORS. CHANGES ARE ADDED TO THE INFORMATION HEREIN, AT ANY TIME, FOR THE IMPROVEMENTS OF THIS PUBLICATION AND/OR THE CORRESPONDING PRODUCT (S).

Disclaimer of warranty

IN NO EVENT SHALL i-PRO Co., Ltd. BE LIABLE TO ANY PARTY OR ANY PERSON, EXCEPT FOR REPLACEMENT OR REASONABLE MAINTENANCE OF THE PRODUCT, FOR THE CASES, INCLUDING BUT NOT LIMITED TO BELOW:

- (1) ANY LOSS OR DAMAGE, INCLUDING WITHOUT LIMITATION, DIRECT OR INDIRECT, SPECIAL, CONSEQUENTIAL OR EXEMPLARY, ARISING OUT OF OR RELATING TO THE PRODUCT;
- (2) ANY INCONVENIENCE, LOSS, OR DAMAGE CAUSED BY INAPPROPRIATE USE OR NEGLIGENT OPERATION OF THE USER;
- (3) ALL MALFUNCTIONS OR TROUBLES FROM UNAUTHORIZED DISASSEMBLE, REPAIR OR MODIFICATION OF THE PRODUCT BY THE USER, REGARDLESS OF THE CAUSE OF THE MALFUNCTION OR TROUBLE;
- (4) INCONVENIENCE OR ANY LOSS ARISING WHEN IMAGES ARE NOT DISPLAYED, DUE TO ANY REASON OR CAUSE INCLUDING ANY FAILURE OR PROBLEM OF THE PRODUCT;
- (5) ANY PROBLEM, CONSEQUENTIAL INCONVENIENCE, OR LOSS OR DAMAGE, ARISING OUT OF THE SYSTEM COMBINED BY THE DEVICES OF THIRD PARTY;
- (6) ANY CLAIM OR ACTION FOR DAMAGES BROUGHT BY ANY PERSON OR ORGANIZATION AS A PHOTOGRAPHED SUBJECT DUE TO VIOLATION OF PRIVACY CONCERNING A SURVEILLANCE CAMERA'S PICTURE OR SAVED DATA, FOR SOME REASON (INCLUDING USE WHEN USER AUTHENTICATION ON THE AUTHENTICATION SETTING SCREEN IS SET TO OFF), BECOMING PUBLIC OR BEING USED FOR ANY PURPOSE;
- (7) LOSS OF REGISTERED DATA CAUSED BY ANY FAILURE (INCLUDING INITIALIZATION OF THE PRODUCT DUE TO FORGOTTEN AUTHENTICATION INFORMATION SUCH AS A USER NAME AND PASSWORD).

About notations

The following notations are used when describing the functions limited for specified models. The functions without the notations are supported by all models.

S857xL	WV-S8574L, WV-S8573L	S856xL	WV-S8564L, WV-S8563L
S854xL	WV-S8544L, WV-S8543L	S854x	WV-S8544, WV-S8543
S85x4x	WV-S8574L, WV-S8564L, WV-S8544L, WV-S8544	S85x3x	WV-S8573L, WV-S8563L, WV-S8543L, WV-S8543



The functions with this notation are available when using the model with the clear dome cover.



The functions with this notation are available when using the model with the smoke dome cover.

System requirements for a PC

CPU:	Intel® Core™ Processor family - Intel® Core™ i5-6500 or faster - Intel® Core™ i7-6700 or faster recommended
Memory:	4 GB (2 GB x 2, Dual Channel) or more recommended.
Network interface:	10BASE-T/100BASE-TX/1000BASE-T 1 port
Audio interface:	Sound card (when using the audio function)
Monitor:	Image capture size: 1024 x 768 pixels or more High-resolution monitoring: 3840 x 2160 pixels or more Color: 24-bit True color or better
OS:	Microsoft Windows 11 Microsoft Windows 10
Web browser:	Google Chrome™ Firefox Microsoft Edge (Chromium or later)
Others:	Adobe® Reader® or Acrobat Reader® (It is necessary to view the PDF file.)

IMPORTANT:

- For information on the operation verification of web browsers, refer to our technical information website <Control No.: C0132>.
 - When using a PC that does not meet the above requirements, displaying of images may become slower or the web browser may become inoperable.
 - Audio may not be heard if a sound card is not installed on a PC. Audio may be interrupted depending on the network environment.
-

Network security

As you will use this unit connected to a network, your attention is called to the following security risks.

- ① Leakage or theft of information through this unit
- ② Use of this unit for illegal operations by persons with malicious intent
- ③ Interference with or stoppage of this unit by persons with malicious intent

It is your responsibility to take precautions such as those described below to protect yourself against the above network security risks.

- Use this unit in a network secured by a firewall, etc.
- If this unit is connected to a network that includes PCs, make sure that the system is not infected by computer viruses or other malicious entities (using a regularly updated anti-virus program, anti-spyware program, etc.).
- To prevent unauthorized access, use user-authentication, set user names and passwords, and limit which users can log in.
- Apply measures such as user authentication to protect your network against leakage or theft of information, including image data, authentication information (user names and passwords), alarm mail information and DDNS server information.
- After the unit is accessed by the administrator, make sure to close the browser.
- Change the administrator password periodically. Additionally, save user authentication information (user names and passwords) in such a way that it is kept out of the hands of third parties.
- Do not install the camera in locations where the camera or the cables can be destroyed or damaged by persons with malicious intent.

Precautions for use

When the product is accessible from the Internet

To prevent unauthorized access, note the following.

- Leave user authentication turned on.
- Periodically change passwords that are used to access the product.
Refer to the Operating Instructions for information about how to change passwords.

To keep on using with stable performance

Do not use this product in hot and humid conditions for a long time. Failure to observe this causes component degradation resulting in life shortening of this product. Do not expose this product to direct heat sources such as a heater.

Usage such as switching the power ON/OFF frequently could lead to failure of the camera.

Handle this product with care.

Do not drop this product, nor apply shock or vibration to the product. Failure to observe this may cause trouble.

Do not subject dome cover to strong impact.

Doing so may cause damage or immersion.

Do not directly touch the lens and dome cover with your bare hands.

A dirty dome cover or lens causes deterioration of picture quality.

When an error is detected, this product will restart automatically.

This product will be inoperable for around 2 minutes after the restart just as when the power is turned on.

About the automatic status detection function

When this product malfunctions due to exogenous noise, etc. for 30 seconds or more, the product will automatically restart and will return to normal state. When the product is restart, initialization will be carried out as when the power of the product is turned on. When the product repeatedly resets, exogenous noise level around the product may be high and that may cause malfunction. Contact your dealer for instructions.

Periodically images on the screen appear to be distorted

When the camera is installed in a location where it is subject to small vibrations (for example, when it is installed near devices that vibrate), images may appear distorted and stretched lengthways. This phenomenon is a characteristic of image pickup devices that use CMOS sensors and is caused by the relationship between the periodic movements of the camera and the timing that the image sensor reads images. This is not a problem with the camera. To reduce the possibility of this phenomenon occurring, install the camera in a secure location.

About the ventilation opening

- Because humidity is retained internally in the camera, the camera has a ventilation opening and contains moisture absorption gel.
- Depending on conditions such as temperature, humidity or the climate, condensation may form and it may take time to dehumidify.
- Do not block the surface of the ventilation opening.

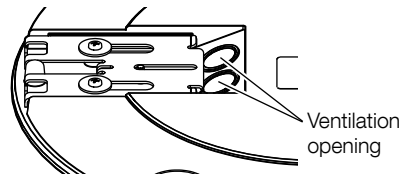

What to do if “WARMING UP-PLEASE WAIT” appears on the display. (S854xL) (S854x)

This message indicates that the temperature inside the camera has become extremely low. The camera will be automatically restarted when the inside the camera is warmed up by the built-in heater. Please wait for a while.

We shall not be liable for content compensation, losses of recorded or edited content and any direct or indirect consequent damages caused by failure to record or edit due to faults with this unit or the microSD memory card. In addition, the same provisions apply after unit is repaired.

About the CMOS image sensor

- When continuously shooting a bright light source such as a spotlight, the color filter of the CMOS image sensor may become deteriorated and this may cause discoloration. Even when changing the fixed shooting direction after continuously shooting a spotlight for a certain period, the discoloration may remain.
- When shooting fast-moving subjects or objects crossing the shooting area may look to be bending askew.

Cleaning this product body

Be sure to turn off the power before cleaning. Failure to observe this may cause injury. Do not use benzine, thinner, alcohol, or any other types of solvents or detergents. Otherwise, it may cause discoloration. When using a chemical cloth for cleaning, read the caution provided with the chemical cloth product.

- Do not loosen or remove screws unless instructed to do so in the product documentation.

Cleaning the lens

Use a lens cleaning paper (used to clean camera lenses or lenses of spectacles). When using solvent, use an alcohol solvent and do not use a glass cleaner or a thinner.

Cleaning of the front panel

Use lens cleaning paper (used to clean camera or spectacles lenses) to remove any dirt on the front panel. If dust or the like is adhered at this time, the front panel may get scratched. We recommend rinsing for stubborn stains.

AVC Patent Portfolio License

THIS PRODUCT IS LICENSED UNDER THE AVC PATENT PORTFOLIO LICENSE FOR THE PERSONAL USE OF A CONSUMER OR OTHER USES IN WHICH IT DOES NOT RECEIVE REMUNERATION TO (i) ENCODE VIDEO IN COMPLIANCE WITH THE AVC STANDARD (“AVC VIDEO”) AND/OR (ii) DECODE AVC VIDEO THAT WAS ENCODED BY A CONSUMER ENGAGED IN A PERSONAL ACTIVITY AND/OR WAS OBTAINED FROM A VIDEO PROVIDER LICENSED TO PROVIDE AVC VIDEO. NO LICENSE IS GRANTED OR SHALL BE IMPLIED FOR ANY OTHER USE. ADDITIONAL INFORMATION MAY BE OBTAINED FROM MPEG LA, L.L.C.
SEE [HTTP://WWW.MPEGLA.COM](http://www.mpegla.com)

Product disposal/transfer

Data saved on this product or a storage device used with this product may lead to personal information leakage. When it is necessary to dispose or give this product to someone, even when for repair, make sure that there is no data on this product.

When abandoning the memory media, it is recommended to destroy it physically after deleting data by PC.

Effects on images and image quality

Under the following conditions, image quality may deteriorate or images may become difficult to see.

- When there are raindrops on the front panel due to wind during rainfall.
- When there is snow on the front panel due to wind during snowfall. (varies depending on the amount and quality of snowfall).
- When the front panel is dirty due to dust in the air or vehicle exhaust.

About HEVC High Efficiency Video Coding patents

Covered by one or more claims of the HEVC patents listed at patentlist.accessadvance.com.

Router

When connecting this product to the Internet, use a broadband router with the port forwarding function (NAT, IP masquerade).

Refer to the Operating Instructions for further information about the port forwarding function.

Time & date setting

It is necessary to set the time & date before putting this product into operation. Refer to the Operating Instructions for descriptions of how to perform the settings.

Parts and functions

The following are descriptions when using the model WV-S8574L.

Cables

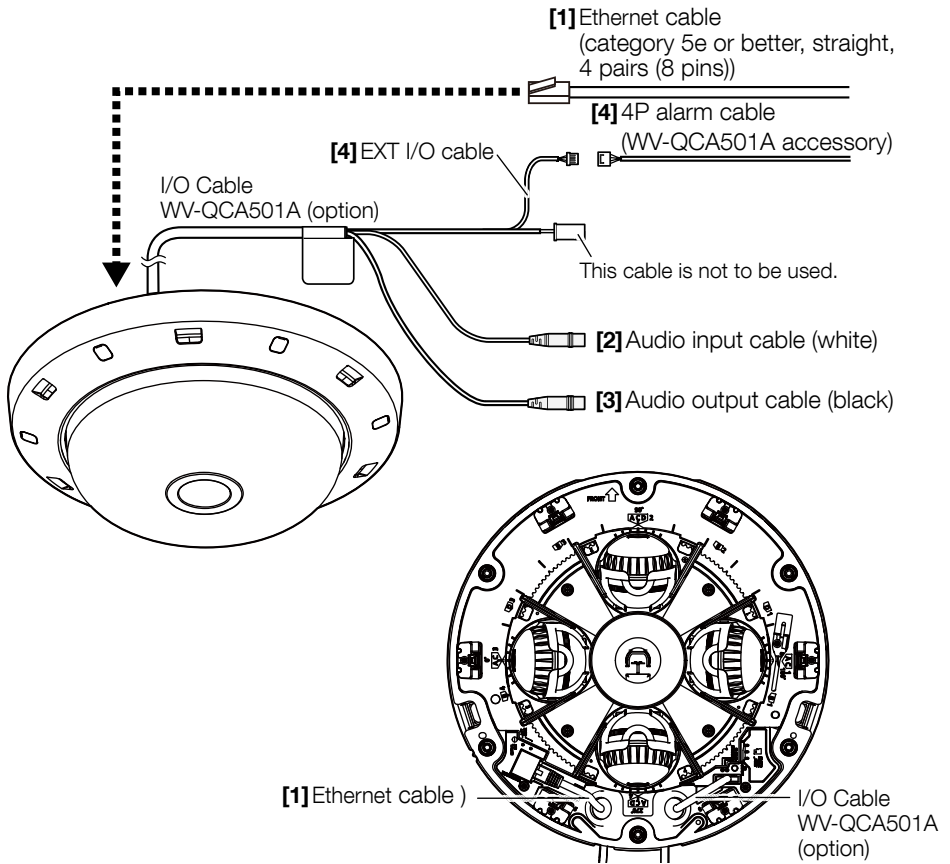

[1] RJ45 Network cable

Connect an Ethernet cable (category 5e or better, straight, 4 pairs (8 pins)) to the network connector.

IMPORTANT:

- Use all 4 pairs (8 pins) of the Ethernet cable.
- The maximum cable length is 100 m {328 feet}.
- Make sure that the PoE+ device in use is compliant with IEEE802.3at standard.
- When the Ethernet cable is disconnected once, reconnect the cable after around 2 seconds.
When the cable is quickly reconnected, the power may not be supplied from the PoE+ device.

[2] Audio input cable (white)

Connect a microphone or the line out of an external device using a stereo mini plug (ø3.5 mm).

<For microphone input>

- Recommended microphone (locally procured): Plug-in power type
(Sensitivity of microphone: $-48 \text{ dB} \pm 3 \text{ dB}$ (0 dB=1 V/Pa, 1 kHz))
- Input impedance: Approx. $2 \text{ k}\Omega$ (unbalanced)
- Supply voltage: $2.4 \text{ V} \pm 0.5 \text{ V}$
- Recommended cable length: Less than 1 m {3.28 feet}

<For line input>

- Input level for the line input: Approx. -10 dBV
- Recommended cable length: Less than 10 m {32.8 feet}

[3] Audio output cable (black)

Connect an external speaker* using a stereo mini plug (ø3.5 mm). (Audio output is monaural.)

- Output impedance: Approx. 600Ω (unbalanced)
- Recommended cable length: Less than 10 m {32.8 feet}
- Output level: -20 dBV *Use a powered speaker.

IMPORTANT:

- Connect/disconnect the audio cables and turn on the power of the camera after turning off the power of the audio output devices. Otherwise, loud noise may be heard from the speaker.
 - Make sure that the stereo mini plug is connected to this cable. When a monaural mini plug is connected, audio may not be heard.
When connecting a monaural speaker with amplifier, use a locally procured conversion cable (mono-stereo).
-

[4] EXT I/O cable / 4P alarm cable (WV-QCA501A accessory)

Note:

- Off, input, and output of the ALARM IN2 and 3 can be switched by configuring the setting. Refer to the Operating Instructions for further information about the ALARM IN2 and 3 settings (“Off”, “Alarm input”, “Alarm output” or “AUX output”).
-

<Ratings>

- Alarm input1 / Black & white input / Auto time adjustment input, Alarm input2, Alarm input3
Input specification: No-voltage make contact input (4 V - 5 V DC, internally pulled up)
OFF: Open or 4 V - 5 V DC
ON: Make contact with GND (required drive current: 1 mA or more)
- Alarm output, AUX output
Output specification: Open collector output (maximum applied voltage: 20 V DC)
OPEN: 4 V - 5 V DC by internal pull-up
CLOSE: Output voltage 1 V DC or less (maximum drive current: 50 mA)

4P alarm cable

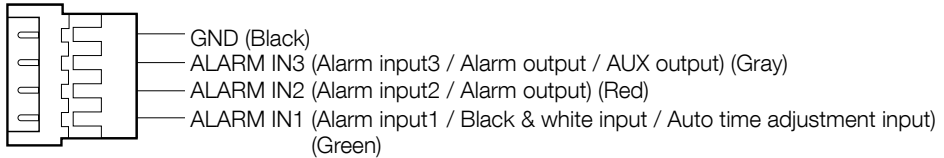

IMPORTANT:

- Install external devices so that they do not exceed the rating of the network camera.
 - When using the ALARM IN2 and/or 3 as the output terminals, ensure they do not cause signal collision with external signals.
-

■ Indicators and buttons

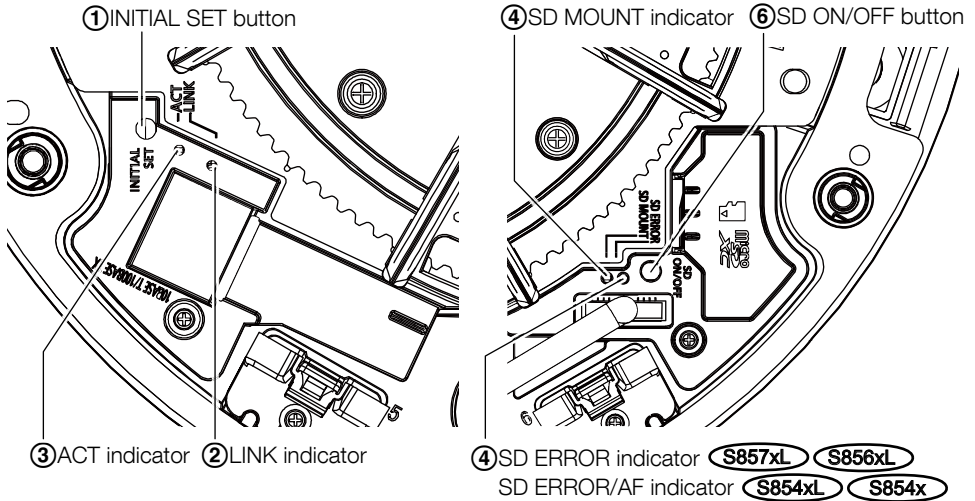

① INITIAL SET button (Initializing switch button)

Follow the steps below to initialize the network camera.

- (1) Turn off the power of the camera. When using a PoE+ hub, disconnect the Ethernet cable from the camera.
- (2) Turn on the power of the camera while pressing the INITIAL SET button, and make sure to release the button after approximately 15 seconds. In about 2 minutes later, the camera will start up and the settings including the network settings will be initialized. Retry if the camera does not start up normally.

IMPORTANT:

- When the camera is initialized, the settings including the network settings will be initialized. Before initializing the settings, it is recommended to write down the settings in advance.
 - Do not turn off the power of the camera during the process of initialization. Otherwise, it may fail to initialize and may cause malfunction.
-

② LINK indicator

- When the camera is able to communicate with the connected device Lights orange

③ ACT indicator

- When data is being sent via the network camera Blinks green (accessing)

④ SD MOUNT indicator

- When a microSD memory card is inserted and could be recognized
Lights off → Blinks green → Lights off
- When data can be saved after the microSD memory card is inserted and the SD ON/OFF button is pressed (less than 1 second)
Lights off → Lights green
- When data can be saved to the microSD memory card
Lights green
- When the microSD memory card is removed after holding down the SD ON/OFF button (about 2 seconds)
Lights green → Blinks green → Lights off (recording)
Lights green → Lights off (waiting for recording)
- When data cannot be saved to the microSD memory card because an abnormality was detected or the microSD memory card is configured not to be used
Lights off

⑤ SD ERROR indicator **S857xL** **S856xL** SD ERROR/AF indicator **S854xL** **S854x**

- When AF (Auto Focus) operation is being executed
S854xL **S854x**
Blinks red (Interval of 2 time/ second)
- When the set is being started
Lights red
- When an SD memory card is recognized normally
Lights red → Lights off
- When the SD slot is not used or an abnormality is detected in SD card after the camera has started
Lights red → Stays red

Note:

- Lighting/blinking LED can be turned off with the software settings at any time. (The initial state is lighting or blinking.) Set the LED to be solid off if necessary, depending on the installation conditions. (☞ Operating instructions on our support website)
-

⑥ SD ON/OFF button

- (1)When the SD ON/OFF button is pressed (less than 1 second), the SD MOUNT indicator lights up in green and data can be saved to the microSD memory card.
- (2)When the SD ON/OFF button is held down (about 2 seconds), the SD MOUNT indicator lights off and the microSD memory card can be removed.

Insert / remove a microSD memory card

Note:

- Use a microSD memory card dedicated to i-PRO cameras.
- Refer to the Operating Instructions on our support website for further information about the microSD memory card settings.

■ Insert a microSD memory card

- ① Remove the enclosure from the camera. (Refer to installation procedure leaflet)
- ② Insert the microSD memory card until it makes a clicking sound.
- ③ When a click is heard, release your finger from the microSD memory card and check if the microSD memory card is correctly inserted.
- ④ After the microSD memory card has been inserted, press the SD ON/OFF button, and make sure the SD MOUNT indicator is continually lit.
If you do not press the SD ON/OFF button after inserting the microSD memory card, the SD MOUNT indicator is automatically lit approximately 5 minutes later.

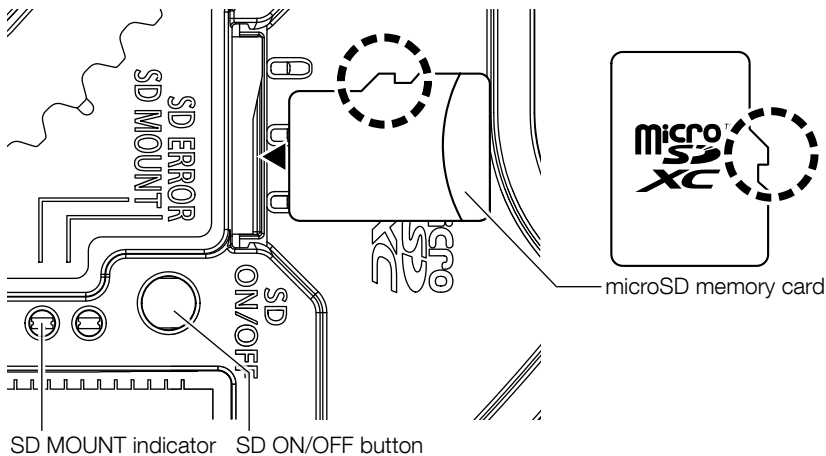

- ⑤ Attach the enclosure to the camera.

■ Remove a microSD memory card

When removing a microSD memory card, reverse the procedure.

- To remove the microSD memory card, hold down the SD ON/OFF button for about 2 seconds. When the flashing SD MOUNT indicator goes out, you can remove the microSD memory card.
-

IMPORTANT:

- Before turning off the camera power switch, make sure that the SD MOUNT indicator is turned off. If you turn off the camera power switch while the SD MOUNT indicator is lit or flashing, the recorded data may be corrupted or damaged.
-

Note:

- When using a microSD memory card, format it using this product. Recorded data on the microSD memory card will be deleted when formatted. If an unformatted microSD memory card or a microSD memory card formatted with other devices is used, this product may not work properly or performance deterioration may be caused. Refer to the Operating instructions on our support website for how to format a microSD memory card.
 - When some microSD memory cards are used with this product, the product may not work properly or performance deterioration may be caused. Use a microSD memory card dedicated to i-PRO cameras.
-

Troubleshooting

Before asking for repairs, check the symptoms with the following table.

Contact your dealer if a problem cannot be solved even after checking and trying the solution in the table or a problem is not described below.

Symptom	Cause/solution	Reference pages
Power is not turned on.	<p>When using a PoE+ device for power supply</p> <ul style="list-style-type: none"> • Are the PoE+ device (IEEE802.3at compliant) and the RJ45 Network connector connected using an Ethernet cable? Check whether the connection is appropriately established. • Depending on the PoE+ device, the power supply will stop when the demanded power exceeds its total power limit for all PoE+ ports. Refer to the operating instructions of the PoE+ device in use. 	Installation Guide
The LINK indicator does not light in orange even when the Ethernet cable is connected to the camera.	<ul style="list-style-type: none"> • Is the Ethernet cable connected appropriately? Connect the Ethernet cable appropriately. • Is the hub or router connected to the camera operating appropriately? Check if the hub or router in use is operating appropriately. • Is the Ethernet cable connected to the camera broken? Replace the cable with another one. 	12
Frame by frame or skipping may occur in the distributed images.	<ul style="list-style-type: none"> • Is a PoE+ power supply device or hub that is compliant with 10BASE-T/100BASE-TX used? Use a PoE+ power supply device or hub that is compliant with 1000BASE-T. 	–
“Power supply is operating on PoE” is still being displayed in the screen.	<ul style="list-style-type: none"> • Operating on PoE. Use a PoE+ hub / device that is compliant with IEEE802.3at standard. It is impossible to supply the power to this product from a PoE hub that is compliant with IEEE802.3af standard. 	–
The SD MOUNT indicator does not light even when a microSD memory card is installed.	<p>This indicator lights up green when the microSD memory card is recognized correctly and ready for use.</p> <ul style="list-style-type: none"> • Has the inserted microSD memory card been formatted on a PC? Use a microSD memory card formatted on the camera. Or install the software to format the microSD memory card on the PC. Refer to our technical information website <Control No.: C0105> for further information about the supported software. 	12, 13

Symptom	Cause/solution	Reference pages
<p>SD ERROR indicator S857xL S856xL SD ERROR/AF indicator S854xL S854x lights red</p>	<p>This indicator lights up red when data cannot be saved on the SD memory card.</p> <ul style="list-style-type: none"> • Hasn't the inserted SD memory card been formatted on a PC? Use an SD memory card formatted on the camera. Or install the software to format the SD memory card on the PC. Refer to our website <Control No.: C0105> for further information about the supported software. • Isn't the inserted SD memory card faulty? Replace the card with a normal one. 	
<p>Audio input contains noise.</p>	<ul style="list-style-type: none"> • Check the following. <ul style="list-style-type: none"> • Grounding of the camera, a switching hub or peripheral devices are not done. • The camera is used near an electrical power line. • The camera is used near a device which produces strong magnetic field or radio waves (such as near a TV/radio antenna, a motor of an air conditioning system, a transformer, etc.) <p>When audio input still contains noise even after checking the above possibilities, use a powered microphone or connect audio output with low output impedance.</p>	<p>Installation Guide</p>
<p>Auto focus (AF) can not be automatically adjusted. S854xL S854x</p>	<ul style="list-style-type: none"> • In the following locations or with the following subjects, the focus may not be able to be automatically adjusted. In this case, manually adjust the focus from the software screen. <ul style="list-style-type: none"> • When the subject moves a lot • When there are large changes to the lighting intensity • When the light level is low • When the subject or location is extremely bright or reflective • When viewing through windows • When the front panel is in a locations where it can easily become dirty • Locations where there is not much contrast such as a white wall • When there is harsh flickering 	<p>Operating Instructions</p>

Detail specifications

• Basic

Power source *1:	PoE+ (IEEE802.3at compliant)
Power consumption *1:	<p>S857xL S856xL S854xL</p> <p>PoE+ DC 54 V: 470 mA/ Approx. 25.4 W (Class 4 device)</p> <p>S854x</p> <p>PoE+ DC 54 V: 320 mA/ Approx. 17.3 W (Class 4 device)</p>
Operating environment	
Ambient operating temperature:	<p>-40 °C to +60 °C *2 {-40 °F to +140 °F}</p> <p>(Power On range: -30 °C to +60 °C {-22 °F to +140 °F})</p> <p>Maximum temperature according to NEMA TS 2 (2.2.7): 74 °C {165 °F}</p>
Ambient operating humidity:	10 % to 100 % (no condensation)
Storage environment	
Storage temperature:	-30 °C to +60 °C {-22 °F to +140 °F}
Storage humidity:	10 % to 95 % (no condensation)
EXT I/O terminals *3, *4:	<p>ALARM IN1 (Alarm input 1/ Black & white input/ Auto time adjustment input) (x1)</p> <p>ALARM IN2 (Alarm input 2/ ALARM OUT) (x1)</p> <p>ALARM IN3 (Alarm input 3/ ALARM OUT/ AUX OUT) (x1)</p>
Audio input *3:	ø3.5 mm stereo mini jack
For microphone input:	<p>Recommended applicable microphone: Plug-in power type (Sensitivity of microphone: -48 dB±3 dB (0 dB=1 V/Pa, 1 kHz))</p> <p>Input impedance: Approx. 2 kΩ (unbalanced)</p> <p>Supply voltage: 2.4 V ±0.5 V</p>
For line input:	Input level: Approx. -10 dBV
Audio output *3:	<p>ø3.5 mm stereo mini jack (Audio output is monaural.)</p> <p>Output impedance: Approx. 600 Ω (unbalanced)</p> <p>Output level: -20 dBV</p>
Waterproof *4:	<p>IP66/ IP67 (IEC 60529), Type 4X (UL50E)</p> <p>NEMA 4X compliant</p>
Shock resistance:	IK10 (IEC 62262)
Other standard support:	NEMA TS 2 (2.2.7-2.2.9)
Wind resistance:	Up to 40 m/s {approx. 89 mph}
Dimensions:	<p>ø300 mm x 90 mm (H) {ø11-13/16 inches x 3-17/32 inches (H)}</p> <p>{5-1/4 inches(W) x 5-1/4 inches(H) x 15-3/32 inches (D)}</p>
Mass:	<p>Approx. 3.3 kg {7.28 lbs} S857xL S856xL</p> <p>Approx. 3.1 kg {6.83 lbs} S854xL S854x</p>
Finish:	<p>Main body: Aluminum die cast, i-PRO white</p> <p>Outer fixing screws: Stainless steel (Corrosion-resistant treatment)</p> <p>Front panel: PC resin, </p>
Others:	Tamper-resistant enclosure *5

*1 Refer to our technical information website <Control No.: C0106> for further information about Power source and Power consumption information.

*2 When using with the IR LED Light constantly lit, the upper limit of the operating temperature range is +50 °C {+122 °F}.

*3 When using EXT I/O terminal, audio input, and audio output, multi-cable (option: WV-QCA501A) is required.

- *4 Refer to the Operating Instructions for further information about the EXT I/O terminal settings.
 Input specification : No-voltage make contact input (4 V - 5 V DC, internally pulled up)
 OFF : Open or 4 V - 5 V DC
 ON : Make contact with GND (required drive current: 1 mA or more)
 Output specification : Open collector output (maximum applied voltage: 20 V DC)
 OPEN : 4 V - 5 V DC by internal pull-up
 CLOSE : Output voltage 1 V DC or less (maximum drive current: 50 mA)
- *5 Only when installation work is properly performed according to the Installation Guide and appropriate waterproof treatment is performed.
- *6 Component that has a structure on which the screws that are accessible after installation cannot be screwed or unscrewed using an ordinary screwdriver.

• Camera

Image sensor:	Approx. 1/2.8 type CMOS image sensor S857xL S856xL Approx. 1/2.7 type CMOS image sensor S854xL S854x
Effective pixels:	Approx. 8.4 megapixels S857xL S856xL Approx. 5.2 megapixels S854xL S854x
Scanning area:	S857xL S856xL 5.56 mm (H) × 3.13 mm (V) {7/32 inches (H) × 1/8 inches (V)} S854xL S854x 5.38 mm (H) × 3.02 mm (V) {7/32 inches (H) × 1/8 inches (V)}
Scanning system:	Progressive
Minimum illumination:	S857xL S856xL Color: C 0.084 lx {0.0078 footcandle} (30IRE, F1.44, Maximum shutter: Off (1/30 s), AGC: 11)* 0.12 lx {0.011 footcandle} (50IRE, F1.44, Maximum shutter: Off (1/30 s), AGC: 11) 0.008 lx {0.00074 footcandle} (50IRE, F1.44, Maximum shutter: max. 16/30 s, AGC: 11)* E 0.24 lx {0.022 footcandle} (30IRE, F1.44, Maximum shutter: Off (1/30 s), AGC: 11)* 0.34 lx {0.032 footcandle} (50IRE, F1.44, Maximum shutter: Off (1/30 s), AGC: 11) 0.021 lx {0.002 footcandle} (50IRE, F1.44, Maximum shutter: max. 16/30 s, AGC: 11)* BW: 0 lx {0 footcandle} (50IRE, F1.44, Maximum shutter: OFF (1/30 s), AGC: 11, when the IR LED is lit) C 0.05 lx {0.0046 footcandle} (50IRE, F1.44, Maximum shutter: Off (1/30 s), AGC: 11) 0.003 lx {0.00028 footcandle} (50IRE, F1.44, Maximum shutter: max. 16/30 s, AGC: 11)* E 0.14 lx {0.013 footcandle} (50IRE, F1.44, Maximum shutter: Off (1/30 s), AGC: 11) 0.009 lx {0.00084 footcandle} (50IRE, F1.44, Maximum shutter: max. 16/30 s, AGC: 11)*

	<p>S854xL S854x</p> <p>Color:</p> <p>C 0.21 lx {0.020 footcandle} (30IRE, F2.0, Maximum shutter: Off (1/30 s), AGC: 11)* 0.3 lx {0.028 footcandle} (50IRE, F2.0, Maximum shutter: Off (1/30 s), AGC: 11) 0.019 lx {0.0018 footcandle} (50IRE, F2.0, Maximum shutter: max. 16/30 s, AGC: 11)*</p> <p>G 0.59 lx {0.055 footcandle} (30IRE, F2.0, Maximum shutter: Off (1/30 s), AGC: 11)* 0.85 lx {0.079 footcandle} (50IRE, F2.0, Maximum shutter: Off (1/30 s), AGC: 11) 0.053 lx {0.0049 footcandle} (50IRE, F2.0, Maximum shutter: max. 16/30 s, AGC: 11)*</p> <p>BW: 0 lx {0 footcandle} (50IRE, F2.0, Maximum shutter: OFF (1/30 s), AGC: 11, when the IR LED is lit) S854xL</p> <p>C 0.12 lx {0.011 footcandle} (50IRE, F2.0, Maximum shutter: Off (1/30 s), AGC: 11) 0.0075 lx {0.0007 footcandle} (50IRE, F2.0, Maximum shutter: max. 16/30 s, AGC: 11)*</p> <p>G 0.34 lx {0.032 footcandle} (50IRE, F2.0, Maximum shutter: Off (1/30 s), AGC: 11) 0.021 lx {0.002 footcandle} (50IRE, F2.0, Maximum shutter: max. 16/30 s, AGC: 11)*</p> <p>* Converted value</p>
Intelligent Auto:	On/ Off
Super Dynamic:	On/ Off The level can be set in the range of 0 to 31.
Dynamic range:	Max. 120 dB S857xL S856xL Max. 108 dB S854xL S854x (Super Dynamic: On, Level: 31)
Maximum gain:	The level can be set in the range of 0 to 11.
Adaptive black stretch:	The level can be set in the range of 0 to 255.
Back light compensation (BLC) / High light compensation (HLC):	BLC/ HLC/ Off The level can be set in the range of 0 to 31. (only when Super Dynamic/ Intelligent Auto: Off)
Fog compensation:	On/ Off The level can be set in the range of 0 to 8. (only when Intelligent Auto / Auto contrast adjust: Off)
Light control mode setting:	Indoor scene (50 Hz)/ Indoor scene (60 Hz)/ ELC
Maximum shutter:	[30 fps/ 15 fps mode] Max. 1/10000 s, Max. 1/4000 s, Max. 1/2000 s, Max. 1/1000 s, Max. 1/500 s, Max. 1/250 s, Max. 1/120 s, Max. 1/100 s, Max. 2/120 s, Max. 2/100 s, Max. 3/120 s, Max. 1/30 s, Max. 2/30 s, Max. 4/30 s, Max. 6/30 s, Max. 10/30 s, Max. 16/30 s [25 fps/ 12.5 fps mode] Max. 1/10000 s, Max. 1/4000 s, Max. 1/2000 s, Max. 1/1000 s, Max. 1/500 s, Max. 1/250 s, Max. 1/100 s, Max. 2/100 s, Max. 3/100 s, Max. 1/25 s, Max. 2/25 s, Max. 4/25 s, Max. 6/25 s, Max. 10/25 s, Max. 16/25 s

Color/BW:	<p>S857xL S856xL S854xL Off/ On(IR Light Off)/ On(IR Light On)/ Auto1(IR Light Off)/ Auto2(IR Light On)/ Auto3(SCC) S854x Off/ On/ Auto1(Normal)/ Auto2(IR Light)/ Auto3(SCC)</p>
IR LED Light S857xL S856xL S854xL :	<p>High/ Middle/ Low/ Off C Maximum irradiation distance: 40 m {Approx. 131 ft} (30IRE)* S857xL S856xL 30 m {Approx. 99 ft} (50IRE) S857xL S856xL 20 m {Approx. 66 ft} (30IRE)* S854xL 15 m {Approx. 49 ft} (50IRE) S854xL C Maximum irradiation distance: 30 m {Approx. 99 ft} (30IRE)* S857xL S856xL 21 m {Approx. 69 ft} (50IRE) S857xL S856xL 15 m {Approx. 49 ft} (30IRE)* S854xL 11 m {Approx. 36 ft} (50IRE) S854xL</p> <p>* Converted value</p>
White balance:	ATW1/ ATW2/ AWC
Digital noise reduction:	The level can be set in the range of 0 to 255.
Privacy zone:	On/ Off Up to 8 zones available
VIQS:	On/ Off Up to 8 zones available
Camera title on screen:	On/ Off Up to 40 characters, Up to 2 lines (alphanumeric characters, marks)
Video Motion Detection (VMD):	On/ Off 4 areas available
Scene Change Detection (SCD):	On/ Off 1 area available
Audio Detection:	On/ Off
AI Sound classification:	Selectable from Gunshot, Yell, Vehicle horn, Glass break, Other
Image rotation:	0° (Off)/ 90°/ 180° (Upside-down)/ 270°

• Lens

Zoom ratio:	<p>S857xL Optical zoom 1x Extra optical zoom max 6x (1x – 6x when resolution is 640x360)</p> <p>S856xL 1x max 5x (1x – 5x when resolution is 640x360)</p> <p>S854xL S854x Optical zoom 2.5x (Motorized zoom / Motorized focus) Extra optical zoom max 10.5x (2.5x – 10.5x when resolution is 640x360)</p>
Focal length:	<p>S857xL S856xL 3.1 mm {1/8 inches}</p> <p>S854xL S854x 2.9 mm – 7.3 mm {1/8 inches – 1/4 inches}</p>

Maximum aperture ratio:	S857xL S856xL 1:1.4 S854xL S854x 1:2.0 (WIDE) – 1:3.0 (TELE)
Focus range:	S857xL S856xL 3 m {9.84 ft} – ∞ S854xL S854x 1 m {3.28 ft} – ∞
Angular field of view:	S857xL S856xL [16:9 mode*] *[4:3 mode] is not supported Horizontal: 108° Vertical: 56° S854xL S854x [16:9 mode] *[4:3 mode] is not supported Horizontal: 43° (TELE) – 100° (WIDE) Vertical: 24° (TELE) – 56° (WIDE)
DORI *1:	S857xL S856xL Detect (25 ppm / 8 ppf) 56.8 m {186.4 ft} Observe (62.5 ppm / 19 ppf) 22.7 m {74.6 ft} Recognize (125 ppm / 38 ppf) 11.4 m {37.3 ft} Identify (250 ppm / 76 ppf) 5.7 m {18.6 ft} S854xL S854x Detect (25 ppm / 8 ppf) 147.7 m {484.6 ft} (TELE) – 45.1 m {148.0 ft} (WIDE) Observe (62.5 ppm / 19 ppf) 59.1 m {193.8 ft} (TELE) – 18 m {59.2 ft} (WIDE) Recognize (125 ppm / 38 ppf) 29.5 m {96.9 ft} (TELE) – 9.0 m {29.6 ft} (WIDE) Identify (250 ppm / 76 ppf) 14.8 m {48.5 ft} (TELE) – 4.5 m {14.8 ft} (WIDE)
Adjusting angle:	Camera 1, 2, 3, 4 S85x4x Camera 1, 2, 3 S85x3x : Horizontal (PAN) angle*: ±125° (Adjust by horizontal (PAN) angle) Vertical (TILT) angle: 10° to 105° (Adjust by vertical (TILT) angle) Azimuth (YAW) angle: ±90° (Adjust by azimuth (YAW) angle) Swing (TWIST) angle: ±30° * The above is the adjustable range of each camera unit. The adjustable range varies according to the positional relationship with other camera units.

*1 Maximum distance at which a camera's tele and wide lens can meet DORI specifications. This value does not indicate the performance of the camera. Calculations made with the camera installed horizontally at resolution of maximum resolution.

• Network

Network:	10BASE-T/ 100BASE-TX/ 1000BASE-T*1 , RJ45 connector
Resolution: H.265/ H.264 *2 JPEG (MJPEG)	[16:9 mode*] *[4:3 mode] is not supported S857xL 3840×2160/ 2560×1440/ 1920×1080/ 1280×720/ 640×360/ 320×180 S856xL 3328×1872/ 2560×1440/ 1920×1080/ 1280×720/ 640×360/ 320×180 S854xL S854x 2688×1520/ 2560×1440/ 1920×1080/ 1280×720/ 640×360/ 320×180

Image compression method:

H.265/ H.264 *2

Transmission priority:

Constant bit rate/ VBR/ Frame rate/ Best effort

Frame rate:

S857xL **S856xL**

[15 fps mode]

1 fps/ 3 fps/ 5 fps*/ 7.5 fps*/ 10 fps*/ 12 fps*/ 15 fps*

[12.5 fps mode]

1 fps/ 3.1 fps/ 4.2 fps*/ 6.25 fps*/ 8.3 fps*/ 12.5 fps*

S854xL **S854x**

[30 fps mode]

1 fps/ 3 fps/ 5 fps*/ 7.5 fps*/ 10 fps*/ 12 fps*/ 15 fps*/ 20 fps*/ 30 fps*

[25 fps mode]

1 fps/ 3.1 fps/ 4.2 fps*/ 6.25 fps*/ 8.3 fps*/ 12.5 fps*/ 20 fps*/
25 fps*(The frame rate is limited to "bit rate". When a value with an asterisk (*) is selected, the actual frame rate may be lower than the value selected.)

Bit rate per client:

64 kbps/ 128 kbps*/ 256 kbps*/ 384 kbps*/ 512 kbps*/
768 kbps*/ 1024 kbps*/ 1536 kbps*/ 2048 kbps*/ 3072 kbps*/
4096 kbps*/ 6144 kbps*/ 8192 kbps*/ 10240 kbps*/
12288 kbps*/ 14336 kbps*/ 16384 kbps*/ 20480 kbps*/ 24576 kbps*/
--FREE ENTRY--

* The available range of the bit rate varies depending on the setting selected for "image capture size".

Image quality:

- For "Constant bit rate", "Frame rate", and "Best effort":
Low(Motion priority)/ Normal/ Fine(Image quality priority)
- "VBR":
0 Super fine/ 1 Fine/ 2/ 3/ 4/ 5 Normal/ 6/ 7/ 8/ 9 Low

Transmission type:

Unicast port (AUTO)/ Unicast port (MANUAL)/ Multicast

JPEG (MJPEG)

Image quality:

0 SUPER FINE/ 1 FINE/ 2/ 3/ 4/ 5 NORMAL/ 6/ 7/ 8/ 9 LOW
(10 steps: 0-9)

Transmission type: Pull (Refresh interval)/ Push (MJPEG)

Refresh interval:

S857xL **S856xL**

[15 fps mode]

0.1 fps/ 0.2 fps/ 0.33 fps/ 0.5 fps/ 1 fps/ 2 fps/ 3 fps/ 5 fps/ 6 fps/
10 fps/ 12 fps/ 15 fps

[12.5 fps mode]

0.08 fps/ 0.17 fps/ 0.28 fps/ 0.42 fps/ 1 fps/ 2.1 fps/ 3.1 fps/ 4.2 fps/
5 fps/ 8.3 fps/ 12.5 fps

S854xL **S854x**

[30 fps mode]

0.1 fps/ 0.2 fps/ 0.33 fps/ 0.5 fps/ 1 fps/ 2 fps/ 3 fps/ 5 fps/ 6 fps/
10 fps/ 12 fps/ 15 fps/ 30 fps

[25 fps mode]

0.08 fps/ 0.17 fps/ 0.28 fps/ 0.42 fps/ 1 fps/ 2.1 fps/ 3.1 fps/ 4.2 fps/
5 fps/ 8.3 fps/ 12.5 fps/ 25 fps

(JPEG frame rates are limited when using JPEG and H.265/H.264 simultaneously.)

Smart coding:	<p>GOP(Group of pictures) control Off/ Low (Variable GOP 1s-8s)/ Mid (Variable GOP 4s-16s)/ Advanced (Fixed GOP 60 seconds with 1 second Key frame)/ Frame rate control (Variable GOP 4s-16s with frame rate control) Advanced and Frame rate control are only available with H.265.</p> <p>Smart VIQS On(High)/ On(Low)/ Off</p> <p>Smart P-picture control On/ Off</p>
Audio compression method:	<p>G.726 (ADPCM): 16 kbps/ 32 kbps G.711: 64 kbps AAC-LC*3: 64 kbps/ 96 kbps/ 128 kbps</p>
Bandwidth control:	<p>Unlimited/ 4096 kbps/ 6144 kbps/ 8192 kbps/ 10240 kbps/ 12288 kbps/ 15360 kbps/ 20480 kbps/ 25600 kbps/ 30720 kbps/ 35840 kbps/ 40960 kbps/ 51200 kbps/ 61440 kbps/ 81920 kbps/ 102400 kbps/ 153600kbps</p>
Protocol:	<p>IPv6: TCP/IP, UDP/IP, HTTP, HTTPS, SSL/TLS, SMTP, DNS, NTP, SNMPv1/v2/v3, DHCPv6, RTP, MLD, ICMP, ARP, IEEE 802.1X, DiffServ, LLDP, MQTT</p> <p>IPv4: TCP/IP, UDP/IP, HTTP, HTTPS, SSL/TLS, RTSP, RTP, RTP/RTCP, SMTP, DHCP, DNS, DDNS, NTP, SNMPv1/v2/v3, UPnP, IGMP, ICMP, ARP, IEEE 802.1X, DiffServ, SRTP, LLDP, MQTT</p>
Security:	<p>User authentication, Host authentication, HTTPS*, Alteration detection of video file* FIPS 140-2 level 3 certified * The certification is pre-installed.</p>
OS *4:	<p>Microsoft Windows 10 Microsoft Windows 11</p>
Browser *4:	<p>Google Chrome Firefox Microsoft Edge (Chromium or later)</p>
Maximum concurrent access number:	<p>24* (Number of sessions that can connect to cameras at the same time) * Depends on network conditions</p>
microSD memory card *5, *6, *7, *8, *9:	<p>microSDXC memory card: 64 GB, 128 GB, 256 GB, 512 GB microSDHC memory card: 4 GB, 8 GB, 16 GB, 32 GB microSD memory card: 2 GB</p>
Mobile terminal/ Tablet terminal compatibility:	<p>iPad / iPhone (iOS 8.0 or later), Android™ terminals</p>

*1 Use the devices that are compliant with 1000BASE-T.

*2 H.265/H.264 can be selected for each stream.

*3 When recording audio on a microSD memory card, only use AAC-LC (Advanced Audio Coding - Low Complexity).

- *4 For information on the operation verification of the supported web browsers, refer to our technical information website <Control No.: C0132>.
- *5 Use a microSD memory card dedicated to i-PRO cameras.
- *6 For possible number of images and duration (an indication) that can be saved on the microSD memory card, refer to our technical information website below.
Possible number of JPEG images that can be saved: <Control No.: C0306>
Possible duration of stream images (H.265 or H.264) that can be saved: <Control No.: C0307>
- *7 Use the microSD memory card with SD Speed Class 6 or higher. Use the microSD memory card that complies with UHS-1(Ultra High Speed-1) in the case of SD Speed Class 10.
- *8 Refer to our technical information website <Control No.:C0117> for the replacement cycle (target) of a microSD memory card.
- *9 When repeatedly recording images on a microSD memory card using the auto overwrite function, make sure to use a microSD memory card with high reliability and durability.

For U.S. and Canada:

i-PRO Americas Inc.

<https://www.i-pro.com/>

For Europe and other countries:

i-PRO Co., Ltd. Fukuoka, Japan

<https://www.i-pro.com/>

i-PRO EMEA B.V. UK Branch
1010 Cambourne Business Park,
Cambridgeshire CB23 6DP

Authorised Representative in EU:
i-PRO EMEA B.V.
Laarderhoogtweg 25, 1101 EB
Amsterdam, Netherlands

